

Optimizing Video Object Detection via a Scale-Time Lattice

Kai Chen¹ Jiaqi Wang¹ Shuo Yang^{1,2} Xingcheng Zhang¹ Yuanjun Xiong^{1,2} Chen Change Loy¹ Dahua Lin¹
¹CUHK - SenseTime Joint Lab, The Chinese University of Hong Kong ²Amazon Rekognition
 {ck015, wj017, zx016, ccloy, dhlin}@ie.cuhk.edu.hk {shuoy, yuanjx}@amazon.com

Abstract

High-performance object detection relies on expensive convolutional networks to compute features, often leading to significant challenges in applications, e.g. those that require detecting objects from video streams in real time. The key to this problem is to trade accuracy for efficiency in an effective way, i.e. reducing the computing cost while maintaining competitive performance. To seek a good balance, previous efforts usually focus on optimizing the model architectures. This paper explores an alternative approach, that is, to reallocate the computation over a scale-time space. The basic idea is to perform expensive detection sparsely and propagate the results across both scales and time with substantially cheaper networks, by exploiting the strong correlations among them. Specifically, we present a unified framework that integrates detection, temporal propagation, and across-scale refinement on a Scale-Time Lattice. On this framework, one can explore various strategies to balance performance and cost. Taking advantage of this flexibility, we further develop an adaptive scheme with the detector invoked on demand and thus obtain improved tradeoff. On ImageNet VID dataset, the proposed method can achieve a competitive mAP 79.6% at 20 fps, or 79.0% at 62 fps as a performance/speed tradeoff.¹

1. Introduction

Object detection in videos has received increasing attention as it sees immense potential in real-world applications such as video-based surveillance. Despite the remarkable progress in image-based object detectors [3, 5, 26], extending them to the video domain remains challenging. Conventional CNN-based methods [15, 16] typically detect objects on a per-frame basis and integrate the results via temporal association and box-level post-processing. Such methods are slow, resource-demanding, and often unable to meet the requirements in real-time systems. For example, a competitive detector based on Faster R-CNN [26] can only operate

¹Code is available at <http://mmlab.ie.cuhk.edu.hk/projects/ST-Lattice/>

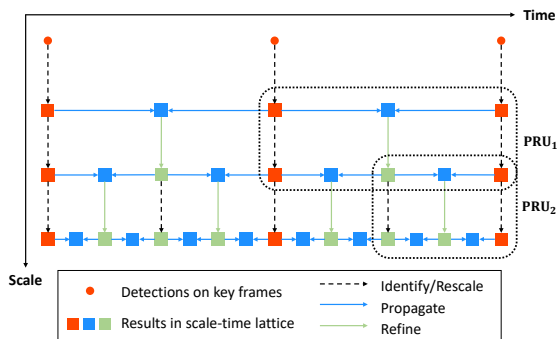

Figure 1: The proposed Scale-Time Lattice permits a flexible design space for performance-cost tradeoff.

at 7 fps on a high-end GPU like Titan X.

A typical approach to this problem is to optimize the underlying networks, e.g. via model compression [9, 13, 30]. This way requires tremendous engineering efforts. On the other hand, videos, by their special nature, provide a different dimension for optimizing the detection framework. Specifically, there exists strong continuity among consecutive frames in a natural video, which suggests an alternative way to reduce computational cost, that is, to propagate the computation temporally. Recently, several attempts along this direction were made, e.g. tracking bounding boxes [15] or warping features [33]. However, the improvement on the overall performance/cost tradeoff remains limited – the pursuit of one side often causes significant expense to the other.

Moving beyond such limitations requires a *joint* perspective. Generally, detecting objects in a video is a multi-step process. The tasks studied in previous work, e.g. image-based detection, temporal propagation, and coarse-to-fine refinement, are just individual steps in this process. While improvements on individual steps have been studied a lot, a key question is still left open: “*what is the most cost-effective strategy to combine them?*”

Driven by this joint perspective, we propose to explore a new strategy, namely pursuing a *balanced* design over a *Scale-Time Lattice*, as shown in Figure 1. The Scale-Time Lattice is a unified formulation, where the steps men-

tioned above are directed links between the nodes at different scale-time positions. From this unified view, one can readily see how different steps contribute and how the computational cost is distributed.

More importantly, this formulation comes with a *rich design space*, where one can flexibly reallocate computation on demand. In this work, we develop a balanced design by leveraging this flexibility. Given a video, the proposed framework first applies expensive object detectors to the key frames selected *sparsely* and *adaptively* based on the object motion and scale, to obtain effective bounding boxes for propagation. These boxes are then propagated to intermediate frames and refined across scales (from coarse to fine), via substantially cheaper networks. For this purpose, we devise a new component based on motion history that can propagate bounding boxes effectively and efficiently. This framework remarkably reduces the amortized cost by only invoking the detector sparsely, while maintaining competitive performance with a cheap but very effective propagation component. This also makes it convenient to seek a good performance/cost tradeoff, *e.g.* by tuning the key frame selection strategy or the network complexity at individual steps.

The main contributions of this work lie in several aspects: (1) the *Scale-Time Lattice* that provides a joint perspective and a rich design space, (2) a detection framework devised thereon that achieves better speed/accuracy tradeoff, and (3) several new technical components, *e.g.* a network for more effective temporal propagation and an adaptive scheme for keyframe selection. Without bells-and-whistles, *e.g.* model ensembling and multi-scale testing, we obtain competitive performance on par with the method [32, 33] that won ImageNet VID challenges 2017, but with a significantly faster running speed of 20 fps.

2. Related Work

Object detection in images. Contemporary object detection methods have been dominated by deep CNNs, most of which follow two paradigms, *two-stage* and *single-stage*. A two-stage pipeline firstly generates region proposals, which are then classified and refined. In the seminal work [6], Girshick *et al.* proposed R-CNN, an initial instantiation of the two-stage paradigm. More efficient frameworks have been developed since then. Fast R-CNN [5] accelerates feature extraction by sharing computation. Faster R-CNN [26] takes a step further by introducing a Region Proposal Network (RPN) to generate region proposals, and sharing features across stages. Recently, new variants, *e.g.* R-FCN [3], FPN [19], and Mask R-CNN [8], further improve the performance. Compared to two-stage pipelines, a single-stage method is often more efficient but less accurate. Liu *et al.* [21] proposed Single Shot Detector (SSD), an early attempt of this paradigm. It generates outputs from default

boxes on a pyramid of feature maps. Shen *et al.* [27] proposed DSOD, which is similar but based on DenseNet [11]. YOLO [24] and YOLOv2 [25] present an alternative that frames detection as a regression problem. Lin *et al.* [20] proposed the use of focal loss along with RetinaNet, which tackles the imbalance between foreground and background classes.

Object detection in videos. Compared with object detection in images, video object detection was less studied until the new VID challenge was introduced to ImageNet. Han *et al.* [7] proposed Seq-NMS that builds high-confidence bounding box sequences and rescores boxes to the average or maximum confidence. The method serves as a post-processing step, thus requiring extra runtime over per-frame detection. Kang *et al.* [15, 16] proposed a framework that integrates per-frame proposal generation, bounding box tracking and tubelet re-scoring. It is very expensive, as it requires per-frame feature computation by deep networks. Zhu *et al.* [33] proposed an efficient framework that runs expensive CNNs on sparse and regularly selected key frames. Features are propagated to other frames with optical flow. The method achieves $10\times$ speedup than per-frame detection at the cost of 4.4% mAP drop (from 73.9% to 69.5%). Our work differs to [33] in that we select key frames adaptively rather than at a fixed interval basis. In addition, we perform temporal propagation in a scale-time lattice space rather than once as in [33]. Based on the aforementioned work, Zhu *et al.* [32] proposed to aggregate nearby features along the motion path, improving the feature quality. However, this method runs slowly at around 1 fps due to dense detection and flow computation. Feichtenhofer *et al.* [4] proposed to learn object detection and cross-frame tracking with a multi-task objective, and link frame-level detections to tubes. They do not explore temporal propagation, only perform interpolation between frames. There are also weakly supervised methods [2, 22, 23] that learn object detectors from videos.

Coarse-to-fine approaches. The coarse-to-fine design has been adopted for various problems such as face alignment [29, 31], optical flow estimation [10, 14], semantic segmentation [18], and super-resolution [12, 17]. These approaches mainly adopt cascaded structures to refine results from low resolution to high resolution. Our approach, however, adopts the coarse-to-fine behavior in two dimensions, both spatially and temporally. The refinement process forms a 2-D Scale-Time Lattice space that allows gradual discovery of denser and more precise bounding boxes.

3. Scale-Time Lattice

In developing a framework for video object detection, our primary goal is to *precisely* localize objects in each frame, while meeting runtime requirements, *e.g.* high de-

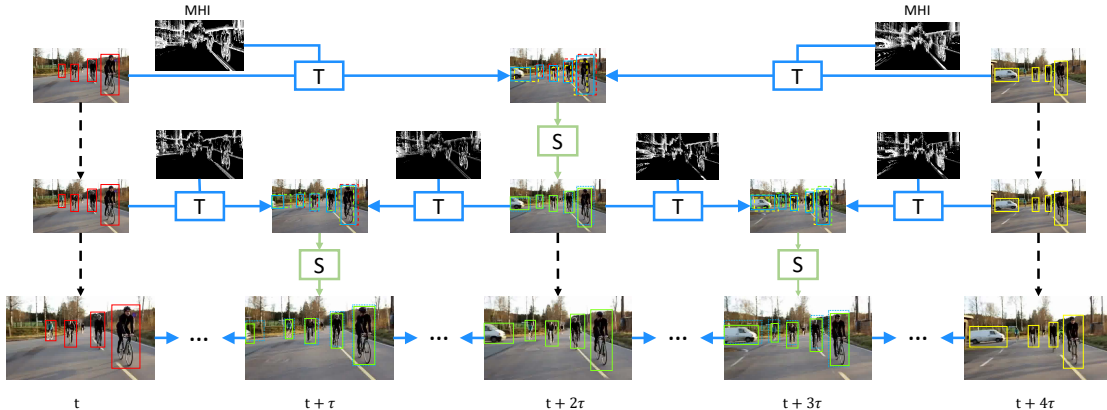

Figure 2: The Scale-Time Lattice, where each node represents the detection results at a certain scale and time point, and each edge represents an operation from one node to another. In particular, the horizontal edges (in blue color) represent the temporal propagation from one time step to the next; while the vertical edges (in green color) represent the spatial refinement from low to high resolutions. Given a video, the image-based detection is only done at sparsely chosen key frames, and the results are propagated along a pre-defined path to the bottom row. The final results at the bottom cover all time points.

tection speed. One way to achieve this is to apply the expensive object detectors on as few key frames as possible, and rely on the spatial and temporal connections to generate detection results for the intermediate frames. While this is a natural idea, finding an optimal design is non-trivial. In this work, we propose the *Scale-Time Lattice*, which unifies the sparse image-based detection and the construction of dense video detection results into a single framework. A good balance of computational cost and detection performance can then be achieved by carefully allocating resources to different components within this framework.

The *Scale-Time Lattice*, as shown in Fig. 2, is formulated as a directed acyclic graph. Each node in this graph stands for the intermediate detection results at a certain spatial resolution and time point, in the form of bounding boxes. The nodes are arranged in a way similar to a lattice: from left to right, they follow the temporal order, while from top to bottom, their scales increase gradually. An edge in the graph represents a certain operation that takes the detection results from the head node and produces the detection results at the tail node. In this work, we define two key operations, *temporal propagation* and *spatial refinement*, which respectively correspond to the horizontal and vertical edges in the graph. Particularly, the *temporal propagation* edges connect nodes at the same spatial scale but adjacent time steps. The *spatial refinement* edges connect nodes at the same time step but neighboring scales. Along this graph, detection results will be propagated from one node to another via the operations introduced above following certain paths. Eventually, the video detection results can be derived from the nodes at the bottom row, which are at the finest scale and cover every time step.

On top of the Scale-Time Lattice, a video detection

pipeline involves three steps: 1) generating object detection results on sparse key frames; 2) planning the paths from image-based detection results (input nodes) to the dense video detection results (output nodes); 3) propagating key frame detection results to the intermediate frames and refine them across scales. The detection accuracy of the approach is measured at the output nodes.

The Scale-Time Lattice framework provides a rich design space for optimizing the detection pipeline. Since the total computational cost equals to the summation of the cost on all paths, including the cost for invoking image-based detectors, it is now convenient to seek a cost/performance tradeoff by well allocating the budget of computation to different elements in the lattice. For example, by sampling more key frames, we can improve detection performance, but also introduce heavy computational cost. On the other hand, we find that with much cheaper networks, the propagation/refinement edges can carry the detection results over a long path while still maintaining competitive accuracy. Hence, we may obtain a much better accuracy/cost tradeoff if the cost budget is used instead for the right component.

Unlike previous pursuits of accuracy/cost balance like spatial pyramid or feature flow, the Scale-Time Lattice operates from coarse to fine, both temporally and spatially. The operation flow across the scale-time lattice narrows the temporal interval while increasing the spatial resolution. In the following section, we will describe the technical details of individual operations along the lattice.

4. Technical Design

In this section, we introduce the design of key components in the Scale-Time Lattice framework and show how they work together to achieve an improved balance between

performance and cost. As shown in Figure 1, the lattice is comprised of compound structures that connect with each other repeatedly to perform temporal propagation and spatial refinement. We call them *Propagation and Refinement Units (PRUs)*. After selecting a small number of key frames and obtaining the detection results thereon, we propagate the results across time and scales via PRUs until they reach the output nodes. Finally, the detection results at the output nodes are integrated into spatio-temporal tubes, and we use a tube-level classifier to reinforce the results.

4.1. Propagation and Refinement Unit (PRU)

The PRU takes the detection results on two consecutive key frames as input, propagates them to an intermediate frame, and then refines the outputs to the next scale, as shown in Figure 3. Formally, we denote the detection results at time t and scale level s as $B_{t,s} = \{b_{t,s}^0, b_{t,s}^1, \dots, b_{t,s}^{m_t}\}$, which is a set of bounding boxes $b_{t,s}^i = (x_{t,s}^i, y_{t,s}^i, w_{t,s}^i, h_{t,s}^i)$. Similarly, we denote the ground truth bounding boxes as $G_t = \{g_t^0, g_t^1, \dots, g_t^{m_t}\}$. In addition, we use I_t to denote the frame image at time t and $M_{t \rightarrow t+\tau}$ to denote the motion representation from frame t to $t + \tau$.

A PRU at the s -level consists of a temporal propagation operator \mathcal{F}_T , a spatial refinement operator \mathcal{F}_S , and a simple rescaling operator \mathcal{F}_R . Its workflow is to output $(B_{t,s+1}, B_{t+\tau,s+1}, B_{t+2\tau,s+1})$ given $B_{t,s}$ and $B_{t+2\tau,s}$. The process can be formalized as

$$B_{t+\tau,s}^L = \mathcal{F}_T(B_{t,s}, M_{t \rightarrow t+\tau}), \quad (1)$$

$$B_{t+\tau,s}^R = \mathcal{F}_T(B_{t+2\tau,s}, M_{t+2\tau \rightarrow t+\tau}), \quad (2)$$

$$B_{t+\tau,s} = B_{t+\tau,s}^L \cup B_{t+\tau,s}^R, \quad (3)$$

$$B_{t+\tau,s+1} = \mathcal{F}_S(B_{t+\tau,s}, I_{t+\tau}), \quad (4)$$

$$B_{t,s+1} = \mathcal{F}_R(B_{t,s}), \quad B_{t+2\tau,s+1} = \mathcal{F}_R(B_{t+2\tau,s}). \quad (5)$$

The procedure can be briefly explained as follows: (1) $B_{t,s}$ is propagated temporally to the time step $t + \tau$ via \mathcal{F}_T , resulting in $B_{t+\tau,s}^L$. (2) Similarly, $B_{t+2\tau,s}$ is propagated to the time step $t + \tau$ in an opposite direction, resulting in $B_{t+\tau,s}^R$. (3) $B_{t+\tau,s}$, the results at time $t + \tau$, are then formed by their union. (4) $B_{t+\tau,s}$ is refined to $B_{t+\tau,s+1}$ at the next scale via \mathcal{F}_S . (5) $B_{t,s+1}$ and $B_{t+2\tau,s+1}$ are simply obtained by rescaling $B_{t,s}$ and $B_{t+2\tau,s}$.

Designing an effective pipeline of PRU is non-trivial. Since the key frames are sampled sparsely to achieve high efficiency, there can be large motion displacement and scale variance in between. Our solution, as outlined above, is to factorize the workflow into two key operations \mathcal{F}_T and \mathcal{F}_S . In particular, \mathcal{F}_T is to deal with the large motion displacement between frames, taking into account the motion information. This operation would roughly localize the objects at time $t + \tau$. However, \mathcal{F}_T focuses on the object movement and it does not consider the offset between the detection results $B_{t,s}$ and ground truth G_t . Such deviation will

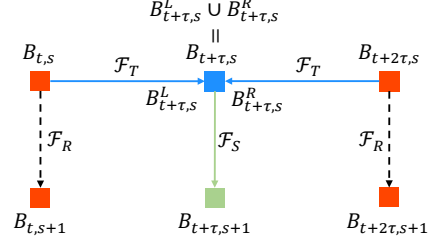

Figure 3: A Propagation and Refinement Unit.

be accumulated into the gap between $B_{t+\tau,s}$ and $G_{t+\tau}$. \mathcal{F}_S is designed to remedy this effect by regressing the bounding box offsets in a coarse-to-fine manner, thus leading to more precise localization. These two operations work together and are conducted iteratively following the scale-time lattice to achieve the final detection results.

Temporal propagation The idea of temporal propagation is previously explored in the video object detection literatures [16, 32, 33]. Many of these methods [32, 33] rely on optical flow to propagate detection results. In spite of its performance, the approach is expensive for a real-time system and not tailored to encoding the motion information over a long time span. In our work, we adopt *Motion History Image (MHI)* [1] as the motion representation which can be computed very efficiently and preserve sufficient motion information for the propagation.

We represent the motion from time t to $t + \tau$ as $M_{t \rightarrow t+\tau} = (H_{t \rightarrow t+\tau}, I_t^{(g)}, I_{t+\tau}^{(g)})$. Here $H_{t \rightarrow t+\tau}$ denotes the MHI from t to $t + \tau$, and $I_t^{(g)}$ and $I_{t+\tau}^{(g)}$ denote the gray-scale images of the two frames respectively, which serve as additional channels to enhance the motion expression with more details. We use a small network (ResNet-18 in our experiments) with RoIAlign layer [8] to extract the features of each box region. On top of the RoI-wise features, a regressor is learned to predict the object movement from t to $t + \tau$.

To train the regressor, we adopt a similar supervision to [15], which learns the relative movement from G_t to $G_{t+\tau}$. The regression target of the j -th bounding box $\Delta_{\mathcal{F}_T}^{*j}$ is defined as the relative movement between best overlapped ground truth box g_t^j and the corresponding one on frame $g_{t+\tau}^j$, adopting the same transformation and normalization used in most detection methods [5, 6].

Coarse-to-fine refinement After propagation, $B_{t+\tau,s}$ is supposed to be around the target objects but may not be precisely localized. The refinement operator \mathcal{F}_S adopts a similar structure as the propagation operator and aims to refine the propagated results. It takes $I_{t+\tau}$ and the propagated boxes $B_{t+\tau,s}$ as the inputs and yields refined boxes $B_{t+\tau,s+1}$. The regression target $\Delta_{\mathcal{F}_S}^*$ is calculated as the offset of $B_{t+\tau,s}$ w.r.t. $G_{t+\tau}$. In the scale-time lattice, smaller scales are used in early stages and larger scales are

used in later stages. Thereby, the detection results are refined in a coarse to fine manner.

Joint optimization The temporal propagation network \mathcal{F}_T and spatial refinement network \mathcal{F}_S are jointly optimized with a multi-task loss in an end-to-end fashion.

$$L(\Delta_{\mathcal{F}_T}, \Delta_{\mathcal{F}_S}, \Delta_{\mathcal{F}_T}^*, \Delta_{\mathcal{F}_S}^*) = \frac{1}{N} \sum_{j=1}^N L_{\mathcal{F}_T}(\Delta_{\mathcal{F}_T}^j, \Delta_{\mathcal{F}_T}^{*j}) + \lambda \frac{1}{N} \sum_{j=1}^N L_{\mathcal{F}_S}(\Delta_{\mathcal{F}_S}^j, \Delta_{\mathcal{F}_S}^{*j}), \quad (6)$$

where N is the number of bounding boxes in a mini batch, $\Delta_{\mathcal{F}_T}$ and $\Delta_{\mathcal{F}_S}$ are the network output of \mathcal{F}_T and \mathcal{F}_S , and $L_{\mathcal{F}_T}$ and $L_{\mathcal{F}_S}$ are smooth L1 loss of temporal propagation and spatial refinement network, respectively.

4.2. Key Frame Selection and Path Planning

Under the Scale-Time Lattice framework, selected key frames form the input nodes, whose number and quality are critical to both detection accuracy and efficiency. The most straightforward approach to key frame selection is uniform sampling which is widely adopted in the previous methods [4, 33]. While uniform sampling strategy is simple and effective, it ignores a key fact that not all frames are equally important and effective for detection and propagation. Thus a non-uniform frame selection strategy could be more desirable.

To this end, we propose an adaptive selection scheme based on our observation that temporal propagation results tend to be inferior to single frame image-based detection when the objects are small and moving quickly. Thus the density of key frames should depend on propagation difficulty, namely, we should select key frames more frequently in the presence of small or fast moving objects.

The adaptive frame selection process works as follows. We first run the detector on very sparse frames $\{t_0, t_1, t_2, \dots\}$ which are uniformly distributed. Given the detection results, we evaluate how *easy* the results can be propagated, based on both the object size and motion. The *easiness measure* is computed as

$$e_{i,i+1} = \frac{1}{|I|} \sum_{(j,k) \in I} s_{t_i, t_{i+1}}^{j,k} m_{t_i, t_{i+1}}^{j,k} \quad (7)$$

where I is the set of matched indices of B'_{t_i} and $B'_{t_{i+1}}$ through bipartite matching based on confidence score and bounding box IoUs, $s_{t_i, t_{i+1}}^{j,k} = \frac{1}{2}(\sqrt{\text{area}(b_{t_i}^j)} + \sqrt{\text{area}(b_{t_{i+1}}^k)})$ is the object size measure and $m_{t_i, t_{i+1}}^{j,k} = \text{IoU}(b_{t_i}^j, b_{t_{i+1}}^k)$ is the motion measure. Note since the results can be noisy, we only consider boxes with high confidence

scores. If $e_{i,i+1}$ falls below a certain threshold, an extra key frame $\bar{t}_{i,i+1} = \frac{t_i + t_{i+1}}{2}$ is added. This process is conducted for only one pass in our experiments.

With the selected key frames, we propose a simple scheme to plan the paths in the scale-time lattice from input nodes to output nodes. In each stage, we use propagation edges to link the nodes at the different time steps, and then use a refinement edge to connect the nodes across scales. Specifically, for nodes (t_i, s) and (t_{i+1}, s) at time point t_i and t_{i+1} of the scale level s , results are propagated to $((t_i + t_{i+1})/2, s)$, then refined to $((t_i + t_{i+1})/2, s+1)$. We set the max number of stages to 2. After two stages, we use linear interpolation as a very cheap propagation approach to generate results for the remaining nodes. More complex path planning may further improve the performance at the same cost, which is left for future work.

4.3. Tube Rescoring

By associating the bounding boxes across frames at the last stage with the propagation relations, we can construct *object tubes*. Given a linked tube $\mathcal{T} = (b_{t_0}, \dots, b_{t_n})$ consisting of $t_n - t_0$ bounding boxes that starts from frame t_0 and terminates at t_n with label l given by the original detector, we train a R-CNN like classifier to re-classify it following the scheme of Temporal Segment Network (TSN) [28]. During inference, we uniformly sample K cropped bounding boxes from each tube as the input of the classifier, and the class scores are fused to yield a *tube-level* prediction. After the classification, scores of bounding boxes in \mathcal{T} are adjusted by the following equation.

$$s_i = \begin{cases} s_i + s', & \text{if } l = l' \\ \frac{1}{n} \sum_{i=0}^n s_i, & \text{otherwise} \end{cases}$$

where s_i is the class score of b_{t_i} given by the detector, and s' and l' are the score and label prediction of \mathcal{T} given by the classifier. After the rescoring, scores of hard positive samples can be boosted and false positives are suppressed.

5. Experiments

5.1. Experimental Setting

Datasets. We experiment on the ImageNet VID dataset², a large-scale benchmark for video object detection, which contains 3862 training videos and 555 validation videos with annotated bounding boxes of 30 classes. Following the standard practice, we train our models on the training set and measure the performance on the validation set using the mean average precision (mAP) metric. We use a subset of ImageNet DET dataset and VID dataset to train our base detector, following [4, 16, 32].

²<http://www.image-net.org/challenges/LSVRC/>

Implementation details. We train a Faster R-CNN as our base detector. We use ResNet-101 as the backbone network and select 15 anchors corresponding to 5 scales and 3 aspect ratios for the RPN. A total of 200k iterations of SGD training is performed on 8 GPUs. We keep boxes with an objectness score higher than 0.001, which results in a mAP of 74.5 and a recall rate of 91.6 with an average of 37 boxes per image. During the joint training of PRU, two random frames are sampled from a video with a temporal interval between 6 and 18. We use the results of the base detector as input ROIs for propagation. To obtain the MHI between frame t and $t + \tau$, we uniformly sample five images apart from frame t and $t + \tau$ when τ is larger than 6 for acceleration. The batch size is set to 64 and each GPU holds 8 images in each iteration. Training lasts 90 epochs with a learning rate of 0.002 followed by 30 epochs with a learning rate of 0.0002. At each stage of the inference, we apply non-maximum suppression (NMS) with a threshold 0.5 to bidirectionally propagated boxes with the same class label before they are further refined. The propagation source of suppressed boxes are considered as linked with that of reserved ones to form an object tube. For the tube rescaling, we train a classifier with the backbone of ResNet-101 and the $K = 6$ frames are sampled from each tube during inference.

5.2. Results

We summarize the cost/performance curve of our approach designed based on Scale-Time Lattice (ST-Lattice) and existing methods in Figure 4. The tradeoff is made under different temporal intervals. The proposed ST-Lattice is clearly better than baselines such as naïve interpolation and DFF [33] which achieves a real-time detection rate by using optical flow to propagate features. ST-Lattice also achieves better tradeoff than state-of-the-art methods, including D&T [4], TPN+LSTM [15], and FGFA [32]. In particular, our method achieves a mAP of 79.6 at 20 fps, which is competitive with D&T [4] that achieves 79.8 at about 5 fps. After a tradeoff on key frame selection, our approach still maintains a mAP of 79.0 at an impressive 62 fps. We show the detailed class-wise performance in the supplementary material.

To further demonstrate how the performance and computational cost are balanced using the ST-Lattice space, we pick a configuration (with a fixed key frame interval of 24) and show the time cost of each edge and the mAP of each node in Figure 5. Thanks to the ST-Lattice, we can flexibly seek a suitable configuration to meet a variety of demands. We provide some examples in Fig. 6, showing the results of per frame baseline and different nodes in the proposed ST-Lattice.

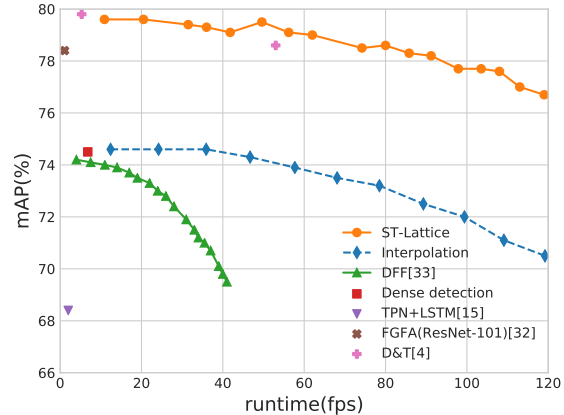

Figure 4: Performance and runtime on ImageNet VID dataset compared with existing methods.³

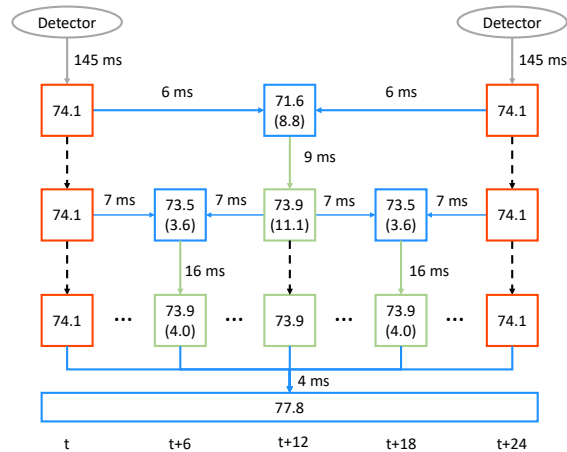

Figure 5: Cost allocation and mAP in the Scale-Time Lattice space. The value in the parenthesis refers to the improvement relative to interpolation.

5.3. Ablation Study

In the following ablation study, we use a fixed key frame interval of 24 unless otherwise indicated and run only the first stage of our approach.

Temporal propagation. In the design space of ST-Lattice, there are many propagation methods that can be explored. We compare the proposed propagation module with other alternatives, such as linear interpolation and RGB difference based regression, under different temporal intervals. For a selected key frame interval, we evaluate the mAP of propagated results on the intermediate frame from two consecutive key frames, without any refinement or rescaling. We use different intervals (from 2 to 24) to see the balance between runtime and mAP. Results are shown in Figure 7. The fps is computed w.r.t. the detection time plus propagation/interpolation time. The MHI based method outper-

will be lower in the full all-frame evaluation if the detections on other frames are interpolated.

³The mAP is evaluated on all frames, except for the fast version of D&T, which is evaluated on sparse key frames. We expect its performance

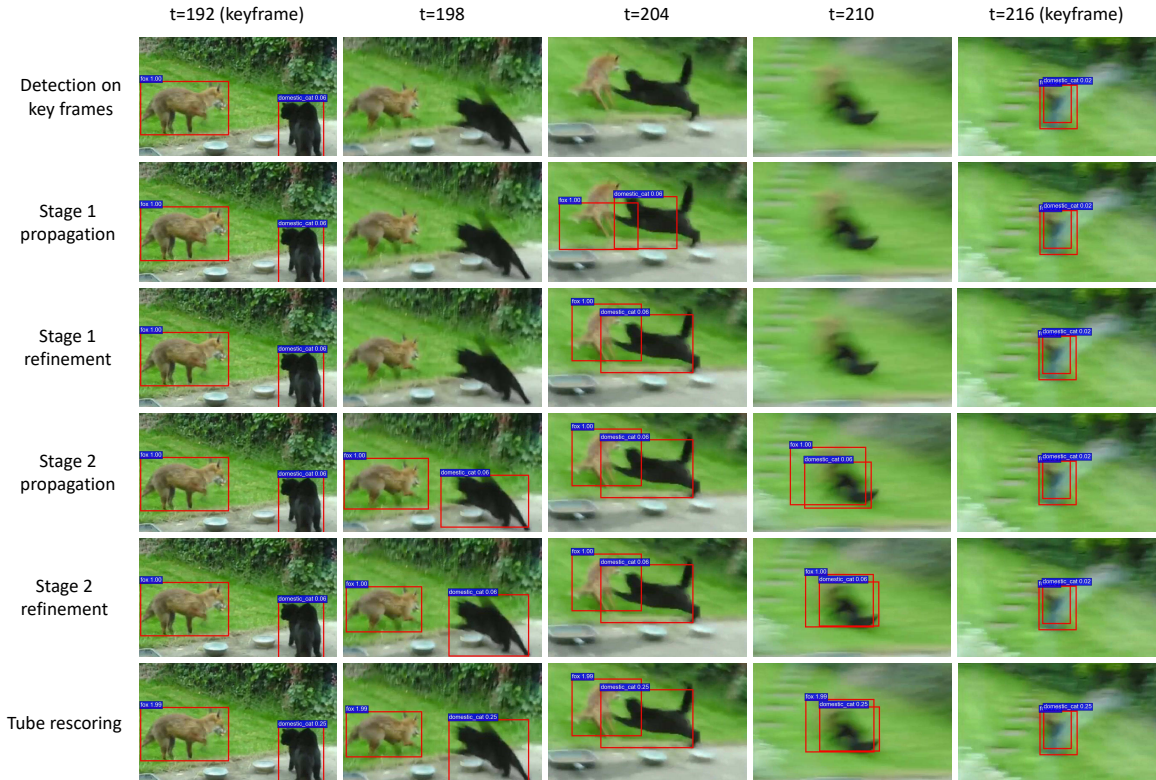

Figure 6: Examples video clips of the proposed Scale-Time Lattice. The per-frame baseline and detection results in different nodes are shown in different rows.

forms other baselines by a large margin. It even surpasses per-frame detection results when the temporal interval is small (10 frames apart). To take a deeper look into the differences of those propagation methods, we divide the ground truths into three parts according to object motion following [32]. We find that the gain mainly originates from objects with fast motion, which are considered more difficult than those with slow motion.

Designs of PRU. Our design of the basic unit is a two-step regression component PRU that takes the $B_{t,s}$ and $B_{t+2\tau,s}$ as input and outputs $B_{t+\tau,s+1}$. Here, we test some variants of PRU as well as a single-step regression module, as shown in Figure 8. M represents motion displacement and O denotes the offset w.r.t. the ground truth. The results are shown in Table 1. We find that design (a) that decouples the estimation of temporal motion displacement and spatial offset simplifies the learning target of regressors, thus yielding a better results than designs (b) and (d). In addition, comparing (a) and (c), joint training of two-stage regression also improves the results by back propagating the gradient of the refinement component to the propagation component, which in turn increases the mAP of the first step results.

Cost allocation. We investigate different cost allocation strategies by trying networks of different depths for the

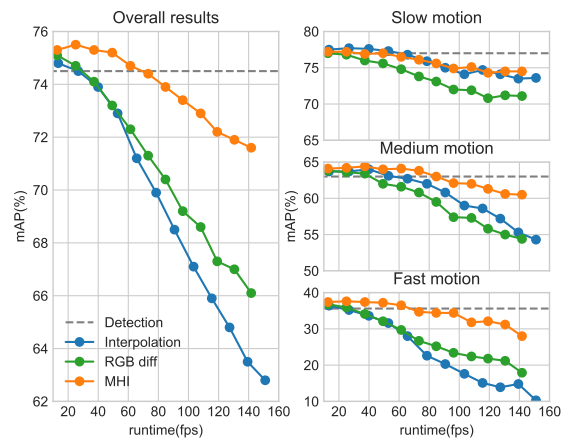

Figure 7: Results of different propagation methods under different key frame intervals. (Left) the overall results. (Right) Detailed results based on different object motion.

propagation and refinement components. Allocating computational costs at different edges on the ST-Lattice would not have the same effects, so we test different strategies by replacing the network of propagation and refinement components with cheaper or more expensive ones. The results in Table 2 indicate that the performance increases as the network gets deeper for both the propagation and refinement.

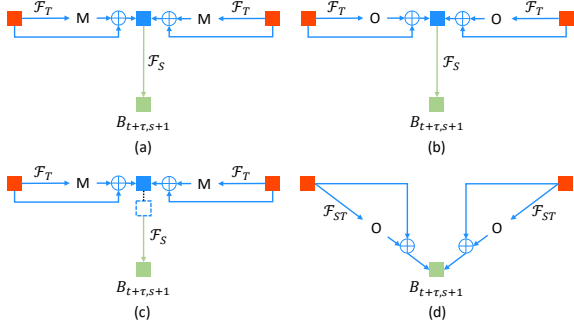

Figure 8: Variants of the basic unit. (a) is our design in Section 4 that regresses motion and offset respectively at two stages; (b) is a variant of our design that regresses the overall offset instead of motion at the first stage; (c) is the same of (a) in structure but not trained jointly; (d) is a single-step regression unit.

Table 1: Performance of different designs of basic unit. v_T and v_S refers to $B_{t+\tau,s}$ (the blue node) and $B_{t+\tau,s+1}$ (the green node) in Figure 8, respectively.

	v_T mAP (%)	v_S mAP (%)	Runtime (ms)
unit (a)	71.6	73.9	21
unit (b)	70.6	72.1	21
unit (c)	71.4	73.7	21
unit (d)	N/A	71.0	12

Table 2: Performance of different combinations of propagation (T) and refinement (S) components. The two numbers (x/y) represent the mAP after propagation and after spatial refinement, respectively. *Small*, *medium* and *large* refers to channel-reduced ResNet-18, ResNet-18 and ResNet-34.

		Net S		
		small	medium	large
Net T	small	67.7/71.1	67.7/72.7	67.8/72.6
	Medium	71.5/72.5	71.6/73.9	71.5/73.7
	Large	72.8/73.1	72.0/73.5	71.8/74.2

Notably, it is more fruitful to use a deeper network for the spatial refinement network than the temporal propagation network. Specifically, keeping the other one as medium, increasing the network size of spatial refinement from small to large results in a gain of 1.2 mAP ($72.5 \rightarrow 73.7$), while adding the same computational cost on \mathcal{F}_T only leads to an improvement of 0.8 mAP ($72.7 \rightarrow 73.5$).

Key frame selection. The selection of input nodes is another design option available on the ST-Lattice. In order to compare the effects of different key frame selection strategies, we evaluate the naïve interpolation approach and the proposed ST-Lattice based on uniformly sampled and adap-

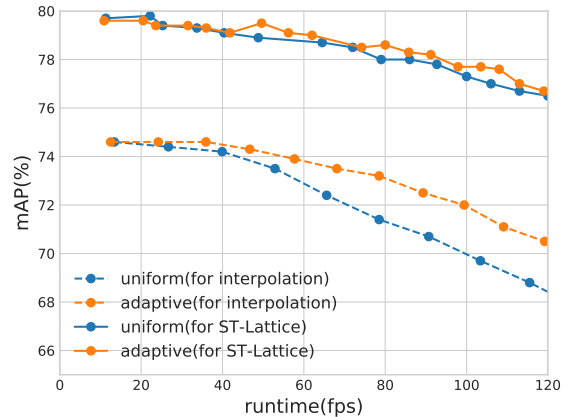

Figure 9: Uniformly sampled and adaptively selected key frames.

tively selected key frames. The results are shown in Figure 9. For the naïve interpolation, the adaptive scheme leads to a large performance gain. Though the adaptive key frame selection does not bring as much improvement to ST-Lattice as interpolation, it is still superior to uniform sampling. Especially, its advantage stands out when the interval gets larger. Adaptive selection works better because through our formulation, more hard samples are selected for running per-frame detector (rather than propagation) and leave easier samples for propagation. This phenomenon can be observed when we quantify the mAP of detections on adaptively selected key frames than uniformly sampled ones (73.3 vs 74.1), suggesting that more harder samples are selected by the adaptive scheme.

6. Conclusion

We have presented the Scale-Time Lattice, a flexible framework that offers a rich design space to balance the performance and cost in video object detection. It provides a joint perspective that integrates detection, temporal propagation, and across-scale refinement. We have shown various configurations designed under this space and demonstrated their competitive performance against state-of-the-art video object detectors with much faster speed. The proposed Scale-Time Lattice is not only useful for designing algorithms for video object detection, but also can be applied to other video-related domains such as video object segmentation and tracking.

Acknowledgment This work is partially supported by the Big Data Collaboration Research grant from SenseTime Group (CUHK Agreement No. TS1610626), the Early Career Scheme (ECS) of Hong Kong (No. 24204215), and the General Research Fund (GRF) of Hong Kong (No. 14236516).

References

- [1] A. F. Bobick and J. W. Davis. The recognition of human movement using temporal templates. *IEEE Transactions on Pattern Analysis and Machine Intelligence*, 23(3):257–267, 2001. 4
- [2] K. Chen, H. Song, C. C. Loy, and D. Lin. Discover and learn new objects from documentaries. In *IEEE Conference on Computer Vision and Pattern Recognition*, 2017. 2
- [3] J. Dai, Y. Li, K. He, and J. Sun. R-fcn: Object detection via region-based fully convolutional networks. In *Advances in Neural Information Processing Systems*, 2016. 1, 2
- [4] C. Feichtenhofer, A. Pinz, and A. Zisserman. Detect to track and track to detect. In *IEEE International Conference on Computer Vision*, 2017. 2, 5, 6
- [5] R. Girshick. Fast r-cnn. In *IEEE International Conference on Computer Vision*, 2015. 1, 2, 4
- [6] R. Girshick, J. Donahue, T. Darrell, and J. Malik. Rich feature hierarchies for accurate object detection and semantic segmentation. In *IEEE Conference on Computer Vision and Pattern Recognition*, 2014. 2, 4
- [7] W. Han, P. Khorrani, T. L. Paine, P. Ramachandran, M. Babaeizadeh, H. Shi, J. Li, S. Yan, and T. S. Huang. Seq-nms for video object detection. *arXiv preprint arXiv:1602.08465*, 2016. 2
- [8] K. He, G. Gkioxari, P. Dollár, and R. Girshick. Mask r-cnn. In *IEEE International Conference on Computer Vision*, 2017. 2, 4
- [9] A. G. Howard, M. Zhu, B. Chen, D. Kalenichenko, W. Wang, T. Weyand, M. Andreetto, and H. Adam. Mobilenets: Efficient convolutional neural networks for mobile vision applications. *arXiv preprint arXiv:1704.04861*, 2017. 1
- [10] Y. Hu, R. Song, and Y. Li. Efficient coarse-to-fine patch-match for large displacement optical flow. In *IEEE Conference on Computer Vision and Pattern Recognition*, 2016. 2
- [11] G. Huang, Z. Liu, L. van der Maaten, and K. Q. Weinberger. Densely connected convolutional networks. In *IEEE Conference on Computer Vision and Pattern Recognition*, 2017. 2
- [12] J.-B. Huang, A. Singh, and N. Ahuja. Single image super-resolution from transformed self-exemplars. In *IEEE Conference on Computer Vision and Pattern Recognition*, 2015. 2
- [13] F. N. Iandola, S. Han, M. W. Moskewicz, K. Ashraf, W. J. Dally, and K. Keutzer. Squeezenet: Alexnet-level accuracy with 50x fewer parameters and 0.5 mb model size. *arXiv preprint arXiv:1602.07360*, 2016. 1
- [14] E. Ilg, N. Mayer, T. Saikia, M. Keuper, A. Dosovitskiy, and T. Brox. FlowNet 2.0: Evolution of optical flow estimation with deep networks. In *IEEE Conference on Computer Vision and Pattern Recognition*, 2017. 2
- [15] K. Kang, H. Li, T. Xiao, W. Ouyang, J. Yan, X. Liu, and X. Wang. Object detection in videos with tubelet proposal networks. In *IEEE Conference on Computer Vision and Pattern Recognition*, 2017. 1, 2, 4, 6
- [16] K. Kang, W. Ouyang, H. Li, and X. Wang. Object detection from video tubelets with convolutional neural networks. In *IEEE Conference on Computer Vision and Pattern Recognition*, 2016. 1, 2, 4, 5
- [17] W.-S. Lai, J.-B. Huang, N. Ahuja, and M.-H. Yang. Deep laplacian pyramid networks for fast and accurate super-resolution. *arXiv preprint arXiv:1704.03915*, 2017. 2
- [18] X. Li, Z. Liu, P. Luo, C. C. Loy, and X. Tang. Not all pixels are equal: Difficulty-aware semantic segmentation via deep layer cascade. In *IEEE Conference on Computer Vision and Pattern Recognition*, 2017. 2
- [19] T.-Y. Lin, P. Dollar, R. Girshick, K. He, B. Hariharan, and S. Belongie. Feature pyramid networks for object detection. In *IEEE Conference on Computer Vision and Pattern Recognition*, July 2017. 2
- [20] T.-Y. Lin, P. Goyal, R. Girshick, K. He, and P. Dollár. Focal loss for dense object detection. In *IEEE International Conference on Computer Vision*, 2017. 2
- [21] W. Liu, D. Anguelov, D. Erhan, C. Szegedy, S. Reed, C.-Y. Fu, and A. C. Berg. Ssd: Single shot multibox detector. In *European Conference on Computer Vision*, 2016. 2
- [22] I. Misra, A. Shrivastava, and M. Hebert. Watch and learn: Semi-supervised learning of object detectors from videos. In *IEEE Conference on Computer Vision and Pattern Recognition*, 2015. 2
- [23] A. Prest, C. Leistner, J. Civera, C. Schmid, and V. Ferrari. Learning object class detectors from weakly annotated video. In *IEEE Conference on Computer Vision and Pattern Recognition*, 2012. 2
- [24] J. Redmon, S. Divvala, R. Girshick, and A. Farhadi. You only look once: Unified, real-time object detection. In *IEEE Conference on Computer Vision and Pattern Recognition*, 2016. 2
- [25] J. Redmon and A. Farhadi. Yolo9000: Better, faster, stronger. In *IEEE Conference on Computer Vision and Pattern Recognition*, 2017. 2
- [26] S. Ren, K. He, R. Girshick, and J. Sun. Faster r-cnn: Towards real-time object detection with region proposal networks. In *Advances in Neural Information Processing Systems*, 2015. 1, 2
- [27] Z. Shen, Z. Liu, J. Li, Y.-G. Jiang, Y. Chen, and X. Xue. Dsod: Learning deeply supervised object detectors from scratch. In *IEEE International Conference on Computer Vision*, 2017. 2
- [28] L. Wang, Y. Xiong, Z. Wang, Y. Qiao, D. Lin, X. Tang, and L. Van Gool. Temporal segment networks: Towards good practices for deep action recognition. In *European Conference on Computer Vision*, 2016. 5
- [29] J. Zhang, S. Shan, M. Kan, and X. Chen. Coarse-to-fine auto-encoder networks (cfan) for real-time face alignment. In *European Conference on Computer Vision*, 2014. 2
- [30] X. Zhang, X. Zhou, M. Lin, and J. Sun. Shufflenet: An extremely efficient convolutional neural network for mobile devices. *arXiv preprint arXiv:1707.01083*, 2017. 1
- [31] S. Zhu, C. Li, C. C. Loy, and X. Tang. Face alignment by coarse-to-fine shape searching. In *IEEE Conference on Computer Vision and Pattern Recognition*, 2015. 2
- [32] X. Zhu, Y. Wang, J. Dai, L. Yuan, and Y. Wei. Flow-guided feature aggregation for video object detection. In *IEEE In-*

ternational Conference on Computer Vision, 2017. 2, 4, 5, 6, 7

- [33] X. Zhu, Y. Xiong, J. Dai, L. Yuan, and Y. Wei. Deep feature flow for video recognition. In *IEEE Conference on Computer Vision and Pattern Recognition*, 2017. 1, 2, 4, 5, 6