

Interference Steering to Manage Interference

Zhao Li*, Fengjuan Guo*, Kang G. Shin[†], Yinghou Liu*, Jia Liu[‡]

*State Key Laboratory of Integrated Service Networks, Xidian University

[†]The University of Michigan, USA

[‡]National Institute of Informatics, Japan

zli@xidian.edu.cn, fjguo@stu.xidian.edu.cn, kgshin@umich.edu, yhliu_2017@stu.xidian.edu.cn, jliu@nii.ac.jp

Abstract—To enable densely deployed base stations (BSs) or access points (APs) to serve an increasing number of users and provide diverse mobile services, we need to improve spectrum utilization in wireless communication networks. Although spectral efficiency (SE) can be enhanced via smart and dynamic resource allocation, interference has become a major impediment in improving SE. There have been numerous interference management (IM) proposals at the interfering transmitter or the victim transmitter/receiver separately or cooperatively. Moreover, the existing IM schemes rely mainly on the use of channel state information (CSI). However, in some communication scenarios, the option to adjust the interferer is not available, and, in the case of downlink transmission, it is always difficult or even impossible for the victim receiver to acquire necessary information for IM.

Based on the above observations, we first propose a novel IM technique, called *interference steering* (IS). By making use of both CSI w.r.t. and data carried in the interfering signal, IS generates a signal to modify the spatial feature of the original interference, so that the steered interference at the victim receiver is orthogonal to its intended signal. We then apply IS to an infrastructure-based enterprise wireless local area network (WLAN) in which the same frequency band is reused by adjacent basic service sets (BSSs) with overlapping areas. With IS, multiple nearby APs could simultaneously transmit data on the same channel to their mobile stations (STAs), thus enhancing spectrum reuse. Our in-depth simulation results show that IS significantly improves network SE over existing IM schemes.

I. INTRODUCTION

Next-generation (a.k.a. IMT-2020 or 5G) mobile wireless networks are characterized by high data rate, high system capacity, and massive device connectivity [1]. Wireless networks circa 2020 are expected to be 1000x larger in capacity and capable of connecting 100 billion devices [2]. In order to meet these requirements, more than 1000MHz of new frequency bands should be identified to fill the spectrum resource gap by 2020. Moreover, efficient spectrum utilization policies and techniques should be developed to enable densely-populated BSSs or APs to serve an increasing number of users and provide diverse mobile services. However, interference will rise with the increase of spectrum utilization, and must be well addressed so as to achieve high spectrum efficiency.

There have been numerous promising proposals to manage interference, which can be classified into two types. The first is isolating mutually interfering transmissions via resource partition, such as fractional frequency reuse (FFR), soft frequency reuse (SFR) [3], enhanced inter-cell interference coordination (eICIC) [4], etc. However, these mechanisms may cause degradation of spectrum efficiency. The second

type is employing various signal processing techniques, such as zero-forcing beamforming (ZFBF) [5], zero-forcing (ZF) reception [6], coordinate multi-point (CoMP) [7], interference cancellation (IC) [8], interference alignment (IA) [9], interference neutralization (IN) [10-14], etc., to support concurrent transmission of multiple interfering signals.

Of these signal processing methods, IN has been under development in recent years [10-14]. It is a new IM mechanism found from, and inherent in interference networks with relays [11-12]. IN strives to combine signals arriving via various paths in such a way that the interfering signals are canceled while preserving the desired signals [13]. It can be regarded as a distributed zero-forcing of interference before the interfering signal reaches the undesired destination [14]. The authors of [13] constructed a linear distributed IN that encodes signals in both space and time for separate multiuser uplink-downlink two-way communications. In [14], an aligned IN was proposed in a multi-hop interference network formed by concatenation of two two-user interference channels. It provides a way to align interference terms over each hop in a manner that allows them to be canceled over the air at the last hop.

Note, however, that none of these existing IM methods are free of cost. For example, the CSI is required for implementing IA, ZF and ZFBF, whereas both CSI w.r.t. and data carried in the interfering signal are exploited for IC, CoMP and IN. By shaping a transmit beam using ZFBF, IA or CoMP, the adjusted signal will be attenuated; a ZF-based filter can be adopted to nullify interference at the expense of degrading the desired signal power somewhat; and for IN, an interfering signal is duplicated to neutralize the interference at the cost of additional transmit power consumption. Moreover, ZFBF and ZF reception require multiple antennas or degrees of freedom (DoFs) at the transmitter (Tx) and the receiver (Rx), respectively, and for IA, both ends of the communication link should be equipped with multiple antennas. The DoF requirements of these methods are determined by the signal dimensions, i.e., for ZFBF and ZF reception, each interfering signal component consumes one DoF, whereas for IA, at least one additional DoF should be provided to place the aligned interference. Moreover, IA is not applicable if multiple interferences are from an identical transmitter. This is because if the interfering signals originated from the same source are aligned in one direction, they will also overlap with each other at their intended receivers, thus becoming indistinguishable. With IN, since interference(s) can be neutralized over the

TABLE I
COMPARISON OF IM METHODS.

Method \ Feature	ZFBF	ZF	CoMP	IC	IA	IN	IS
Tx beam adjustment	o	x	o	x	o	x	x
Rx beam adjustment	x	o	x	x	x	x	x
Signal attenuation	o	o	o	x	o	x	x
Tx power cost	x	x	x	x	x	o	o
Tx side CSI exchange	o	x	o	x	o	o	o
Tx side data exchange	x	x	o	x	x	o	o
Rx side CSI exchange	x	o	x	o	x	x	x
Rx side data exchange	x	x	x	o	x	x	x
Tx side multi-antenna	o	x	o	x	o	o	o
Rx side multi-antenna	x	o	x	x	o	x	o
Symbol-level synchrony	x	x	o	o	x	o	o

air, no additional receiver-side DoF is required to cancel interference, thus becoming free from the aforementioned limitations of ZF reception and IA.

Table I compares some signal-processing-based IM, where the symbols o and x indicate having and not having the corresponding feature, respectively. Tx beam indicates data transmission from various sources to their corresponding receivers. Rx beam means the direction of the receive filter's main lobe. Either Tx or Rx beam adjustment will cause effective signal power loss. Tx/Rx-side CSI exchange indicates that the transmitter/receiver needs to acquire CSI from all RxS/Txs, including intended and unintended RxS/Txs, to itself. In practice, ZFBF and IA are implemented at the interfering transmitter, ZF is at the victim receiver, CoMP and IC are realized cooperatively at the Tx and Rx, respectively. When the interfering Tx is unwilling to perform IM, or collaboration between the interferer and the victim cannot be established, all methods based on such collaboration won't be applicable.

The above discussion implies the need for a new solution to the interference problem despite the numerous IM schemes proposed thus far. Unlike those methods requiring implementation at either the interfering Tx (for IA, ZFBF) or the victim Rx (for ZF), we need the victim Tx-side interference management for the following reasons. First, due to the equal or higher priority of interfering transmission over the victim, the interferer may not be amenable to implementing IM, especially when it incurs some performance loss. For example, in a heterogeneous cellular network (HCN) where small cells are deployed on top of a macrocell to improve the capacity and coverage of existing cellular systems, the macro base station may interfere with small cell users. Due to the small cells' subordinate nature, it is not practical to modify macrocell's transmissions for the small victim cell users. Second, in some communication scenarios such as a downlink transmission, acquiring information for IM (e.g., interferer identification) is always difficult or even impossible for the victim Rx, especially when there are multiple interferers. So, in the above situations, the approaches listed in Table I (except for IN) are not applicable, and hence a new IM method is called for. We therefore focus on two aspects — the available information we can utilize and the cost of IM — in the development of novel

IM. As shown in Table I, most existing methods exploit CSI while ignoring the data information that interference signal carries. Although IN is a victim Tx-based IM implementation which makes use of the interferer's data information, to the best of our knowledge, no existing IN schemes account for the power cost. That is, under a transmit power constraint, the more power consumed for IN, the less available for the intended signal's transmission. Especially when interference at the victim Rx is relatively strong, there might not be sufficient power to generate a required neutralization signal, thus making IN infeasible. The features of the proposed IS is similar to that of IN except for the multi-antenna requirement at the Rx side. The details can be seen in the following sections.

By recognizing that interference can be not only neutralized but also steered in a particular direction, we first propose a novel IM method, called *interference steering* (IS). With IS, a duplicated interfering signal is generated to modify the spatial feature of the original interference observed by the victim Rx, thus enabling interference-free data transmission. Then, we discuss the application of IS to an enterprise WLAN, which has become a pervasive and essential part of our professional life, and will be an increasingly important in future.

The main contributions of this paper are two-fold:

- Proposal of a novel IM scheme called *interference steering* (IS). By generating a steering signal, the original interference imposed on the victim Rx is steered to the orthogonal direction w.r.t. the desired signal, hence achieving interference-free transmission. IS consumes less power than IN but requires an additional DoF at the victim Rx. Moreover, IS can also subsume IN as a special case, thus becoming more general.
- Discussion of the application of IS in an enterprise WLAN where the same frequency band is reused by adjacent BSSs with overlapping areas. A random network topology and arbitrary number of interferences are considered. With the proposed mechanism, interference to cell-edge users can be mitigated, allowing nearby APs to transmit to their associated STAs on the same channel simultaneously and hence improving the system's SE.

The rest of this paper is organized as follows. Section II describes the system model, while Section III presents the

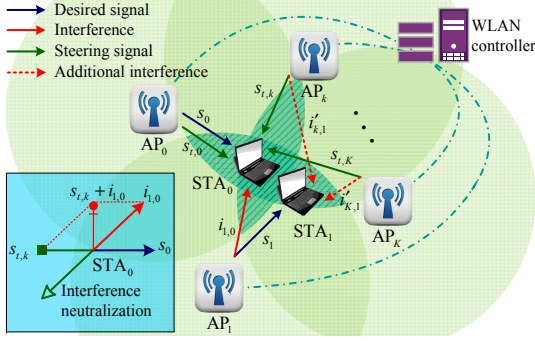

Fig. 1. System model.

design of interference steering. In Section IV, the application of IS in enterprise WLANs is detailed. Section V evaluates the proposed mechanism. Finally, Section VI concludes the paper.

Throughout this paper, we use the following notations. The set of complex numbers is denoted as \mathbb{C} , while vectors and matrices are represented by bold lower-case and upper-case letters, respectively. Let \mathbf{X}^H , \mathbf{X}^T and \mathbf{X}^{-1} denote the Hermitian, transpose and inverse of matrix \mathbf{X} . $\|\cdot\|$ indicates the Euclidean norm. $E(\cdot)$ denotes statistical expectation. $\langle \mathbf{a}, \mathbf{b} \rangle$ represents the inner product of two vectors.

II. SYSTEM MODEL

Consider downlink communication in an infrastructure-based enterprise WLAN in which coverage areas of APs often overlap. For example, approximately 15% more APs (resulting in overlapping coverage) are required for wireless voice communications so as to achieve an acceptable reception power level [15]. Although data-only communications may not require such a large amount of overlap, in order to achieve seamless coverage, coverage overlap is inevitable. For example, Fig. 1 shows K adjacent BSSs with overlapping areas. All APs are assumed to have the same transmit power, P_T , and connected to a central WLAN controller so that downlink transmissions from APs to their clients/STAs are synchronized. Although multiple STAs may be in the coverage area of an AP, only one STA is served at a time by its associated AP via one frequency channel and each STA is associated with one AP at a time. For clarity of presentation, we show only 2 edge STAs: STA_0 is associated with AP_0 and STA_1 with AP_1 . We assume APs and STAs each are equipped with N_t and N_r antennas, respectively. Since mobile stations/devices are subject to severer restrictions such as cost and hardware than an AP, we assume $N_t \geq N_r > 1$. $\mathbf{H}_{mn} \in \mathbb{C}^{N_r \times N_t}$ denotes the spatial channel from AP_m to STA_n . We employ a spatially uncorrelated Rayleigh flat fading channel model so that the elements of \mathbf{H}_{mn} are modeled as independent and identically distributed zero-mean unit-variance complex Gaussian random variables. All users experience block fading, i.e., channel parameters in a block consisting of several successive transmission cycles remain constant in the block and vary randomly between blocks. Let s_m , $m \in \{1, \dots, K\}$, be the desired signal from AP_m to its currently serving client STA_m , and $i_{m,n}$ ($n \in \{1, \dots, K\}$) be the interference from AP_m to STA_n . $s_{t,m}$ is the steering signal generated by AP_m ,

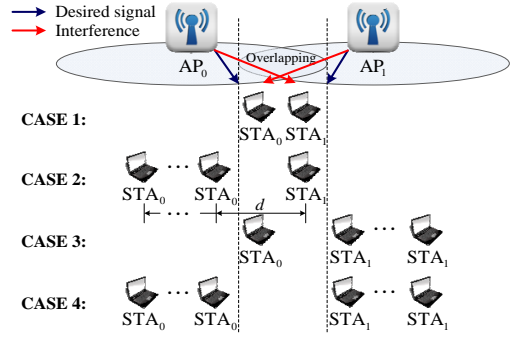

Fig. 2. Interference scenarios.

while $i'_{m,n}$ is the additional interference caused by the steering signal $s_{t,m}$ to STA_n .

According to the existing IEEE 802.11 protocols, a STA scan RF channels to search for beacons advertising the presence of nearby APs. When a radio receives a beacon frame, it acquires information about the capability and configuration of the corresponding network, and then lists available, eligible APs. Based on the number of available APs in the list, the STA determines whether it is an edge-user¹ or not. The STA also estimates CSI based on the received null data packet (NDP) announcements from nearby APs [16]. In this system model, APs with overlapping areas should be scheduled by the central controller so that their NDP transmissions are serialized (to avoid collision). By analyzing the transmitter address field [17] in the NDP announcement, the STA can differentiate CSI from different APs. In general, a non-edge STA estimates and then reports CSI to its associated AP, while an edge-STA form CSI from its associated AP as well as adjacent APs as a vector and sends the vector to its associated AP. The AP then delivers the CSI or CSI vector to the central controller.

Based on WLAN protocols, two adjacent BSSs contend for the same channel and cannot operate on the same channel simultaneously. However, for the purpose of SE enhancement, we may reuse spectrum more aggressively with effective interference management. In such a case, co-channel interference (CCI) may occur, and a STA should thus be able to detect collision caused by CCI, i.e., distinguishing collision from fading individually [18] or cooperatively [19] with its associated AP. Fig. 2 illustrates common interference scenarios in WLANs. The figure shows downlink transmissions from AP_0 to STA_0 and from AP_1 to STA_1 , initiate at time t_0 and t_1 , respectively. This simplified discussion can be readily extended to the case of more APs and STAs as in real WLANs (see Sections III and IV). Without loss of generality, we let $t_1 \geq t_0$. Both AP and STA follow the listen-before-talk (LBT) rule, and channel reciprocity holds, i.e., if an AP can detect signal from an unassociated STA, its transmission signal will interfere with the STA's reception. Let d be the distance between STA_0 and STA_1 . For simplicity, we assume inter-AP distance is large enough for APs unable to hear each other.

Let's consider the downlink transmissions from AP_0 to

¹We use the term *edge* to indicate the status of a STA that can hear from more than one AP, rather than the geographical location of the STA.

STA₀ and from AP₁ to STA₁ as an example that initiate transmission at time t_0 and t_1 respectively, and without loss of generality, we investigate the channel occupancy status observed by BSS₁ and use a general expression [STA₀ → AP₁, AP₀ → STA₁] to represent the reachability between unassociated AP – STA pairs. For example, if AP₁ overhears STA₀, then the first bit in the above expression is 1 else 0. Since the reachability between STAs doesn't affect the downlink interference, the link STA₀ → STA₁ is omitted. This simplified discussion can be readily extended to the case of more APs and STAs as in real WLANs (see Sections III and IV). Without loss of generality, we let $t_1 \geq t_0$. Both AP and STA follow the listen-before-talk (LBT) rule, and channel reciprocity holds, i.e., if an AP can detect signal from an unassociated STA, its transmission signal will interfere with the STA's reception. For simplicity, we assume inter-AP distance is large enough for APs can ignore signals from each other. So, the reachability in case 1 of Fig. 2 is [1, 1], i.e., mutual interference occurs between two adjacent BSSs. We can simply block one of the transmissions or employ a coordinated multi-point (CoMP) [20] to serve two STAs with both APs simultaneously, but CoMP requires modification of the interferer's transmission. As for the second situation, the reachability status is [0, 1], and hence AP₁ is allowed to initiate its transmission to STA₁ by employing an effective IM method to protect STA₁'s reception. In case 3, the reachability status is [1, 0]. Since STA₀ is not associated with AP₁ and all BSSs are equal, AP₁ can transmit data to STA₁ regardless of the ongoing transmission from AP₀ to STA₀. Then, IM should be employed to guarantee STA₀'s reception. CoMP is not applicable for cases 2 and 3, since not all STAs can hear from both APs. If we don't allow AP₁ to transmit to STA₁, an activated edge-STA will block transmissions on the same frequency channel in all its adjacent BSSs whose AP/STA is exposed to the interferer's signal radiation. This is undesirable for the network's requirement of high SE and system capacity. In the last situation, the reachability status is [0, 0], so two interference-free transmissions can be established concurrently. Based on the above discussion, we focus on IM for cases 2 and 3, i.e., edge-STA in case of asymmetric interference.

Since a STA is capable of detecting collision, upon sensing a conflict, the victim STA reports to its associated AP, the latter (victim Tx) asks the WLAN controller for assistance. The controller checks its database and finds a solution for the requestor. The above procedure is in accordance with the centralized management framework proposed in 5G [2], where a high-level node manages all the information. Specifically, the controller maintains the association status between the corresponding APs and STAs, the transmitting status of each AP, and the data information to be transmitted. By utilizing such information, an IS solution can be obtained (see Section IV for details). To limit the system overhead, only edge-STAs can ask their associated APs for IM.

One should note that although we take WLAN as an example to design our mechanism, other types of network as

long as they are featured as 1) direct/indirect² collaboration between the interfering Tx and victim Tx is available, and 2) the interference topology is asymmetric, our scheme is still applicable.

III. DESIGN OF INTERFERENCE STEERING

We present the signal processing procedure of *interference steering* (IS) by exploiting both CSI w.r.t. and data carried in the interference(s). IS generates a steering signal to modify the interference's spatial feature, so that the original interference is steered to the orthogonal direction of the desired signal observed by the victim Rx. In what follows, we first describe the basic design in terms of a single interference and then discuss multi-interferences scenario and cooperative IS.

A. Signal Processing of IS

We assume beamforming (BF) is employed for each downlink communication. As shown in Fig. 1, consider the transmission from AP₀ to STA₀ as an example which is corrupted by the signal sent from AP₁, the received signal at STA₀ with IS can be expressed as

$$\begin{aligned} \mathbf{y}_0 = & \sqrt{P_T - P_{OH}^{st}} \mathbf{H}_{00} \mathbf{p}_0 x_0 + \sqrt{P_T} \mathbf{H}_{10} \mathbf{p}_1 x_1 \\ & + \sqrt{P_k^{st}} \mathbf{H}_{k0} \mathbf{p}_k^{st} x_k^{st} + \mathbf{z}_0 \end{aligned} \quad (1)$$

The first three items on the right hand side (RHS) of Eq. (1) denote the desired signal from AP₀, interference from AP₁, and steering signal from AP_k where $k \in \{1, \dots, K\}$, respectively. \mathbf{z}_0 is an additive white Gaussian noise (AWGN) vector whose elements have zero mean and variance σ_n^2 . Recall that \mathbf{H}_{mn} represents the channel matrix from AP_m to STA_n. When $m = n$, we simply use one-letter subscript for conciseness. x_0 and x_1 are data symbols sent from AP₀ and AP₁, respectively. $E(\|x_0\|^2) = E(\|x_1\|^2) = 1$ holds. Since there is only one interference, data information carried by the steering signal is $x_k^{st} = x_1$. P_{OH}^{st} denotes the power cost for IS at AP₀. The variables P_k^{st} and \mathbf{p}_k^{st} are the transmit power and precoder of the steering signal at AP_k. \mathbf{p}_m represents the precoding vector at AP_m for data x_m . In order to present our design under a fixed power constraint w.r.t. the victim user-pair, we let AP₀ afford P_k^{st} , i.e., $P_{OH}^{st} = P_k^{st}$. We adopt the singular value decomposition (SVD) based BF transmission, i.e., applying SVD to \mathbf{H}_m to obtain $\mathbf{H}_m = \mathbf{U}_m \mathbf{D}_m \mathbf{V}_m^H$ and employing $\mathbf{p}_m = \mathbf{v}_m^{(1)}$ where $\mathbf{v}_m^{(1)}$ represents the principal column vector of \mathbf{V}_m . We can simply use $\mathbf{u}_m^{(1)}$ as the filter vector, where $\mathbf{u}_m^{(1)}$ is the first column vector of \mathbf{U}_m . Then, the estimated signal $\bar{\mathbf{y}}_m = [\mathbf{u}_m^{(1)}]^H \mathbf{y}_m$.

IS is designed as follows. We first define the directions of desired signal and original interference combined with steering signal as $\mathbf{d}_s = \frac{\mathbf{H}_{00} \mathbf{p}_0}{\|\mathbf{H}_{00} \mathbf{p}_0\|}$ and $\mathbf{d}_{i+s_{t,k}} = \frac{\sqrt{P_T} \mathbf{H}_{10} \mathbf{p}_1 + \sqrt{P_k^{st}} \mathbf{H}_{k0} \mathbf{p}_k^{st}}{\|\sqrt{P_T} \mathbf{H}_{10} \mathbf{p}_1 + \sqrt{P_k^{st}} \mathbf{H}_{k0} \mathbf{p}_k^{st}\|}$, respectively. Then, by letting $\langle \mathbf{d}_s, \mathbf{d}_{i+s_{t,k}} \rangle = 0$, the original interference can be steered to

²Direct collaboration refers to direct information exchange between TxS, whereas indirect indicates that the cooperation is achieved via a central control node, e.g., WLAN controller in Fig. 1.

the orthogonal direction w.r.t. the desired signal by the steering signal, s_t .

Since both the interference and the steering signal, denoted by i and $s_{t,k}$, respectively, can be decomposed into an in-phase component and a quadrature component, denoted by superscripts In and Q , respectively, w.r.t. \mathbf{d}_s , i.e., $i = i^{In} + i^Q$ and $s_{t,k} = s_{t,k}^{In} + s_{t,k}^Q$, when $s_{t,k}^{In} = -i^{In}$, IS is realized. Fig. 3 illustrates the basic principle of IS. A 2-dimensional representation is employed for readability. The vectors in the figure indicate the spatial signals.

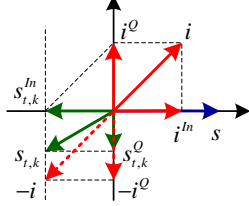

Fig. 3. An illustration of interference steering.

It can be easily seen that given $s_{t,k}^{In} = -i^{In}$, interference energy imposed on the desired transmission is countered. As $s_{t,k}^Q$ approaches $-i^Q$, $s_{t,k}$ tends to $-i$, i.e., IN is achieved. Since the length of vector indicates the strength of signal, when $s_{t,k}^Q = 0$, we have $s_{t,k} = s_{t,k}^{In}$, and obtain an IS solution with minimum power overhead.

Based on the above discussion, we take the communication scenario depicted in Fig. 1 as an example. A general expression of IS implementation is then given as:

$$\begin{cases} \mathbf{p}_k^{st} = \mathbf{H}_{k0}^{-1} [s_{t,k}^{In} + s_{t,k}^Q] / \|\mathbf{H}_{k0}^{-1} [s_{t,k}^{In} + s_{t,k}^Q]\| \\ P_k^{st} = P_T \|\mathbf{H}_{k0}^{-1} [s_{t,k}^{In} + s_{t,k}^Q]\|^2 \end{cases} \quad (2)$$

where $s_{t,k}^{In} = -i^{In} = -\sqrt{P_T} \mathbf{P} \mathbf{H}_{10} \mathbf{p}_1$ and $\mathbf{P} = \mathbf{d}_s (\mathbf{d}_s^T \mathbf{d}_s)^{-1} \mathbf{d}_s^T$ denotes projection matrix. When $s_{t,k}^Q = -\sqrt{P_T} \mathbf{H}_{10} \mathbf{p}_1 + \sqrt{P_T} \mathbf{P} \mathbf{H}_{10} \mathbf{p}_1$, we have $s_{t,k} = -i$ and IS becomes IN. Then, Eq. (2) can be rewritten as

$$\begin{cases} \mathbf{p}_k^{ne} = -\mathbf{H}_{k0}^{-1} \mathbf{H}_{10} \mathbf{p}_1 / \|\mathbf{H}_{k0}^{-1} \mathbf{H}_{10} \mathbf{p}_1\| \\ P_k^{ne} = P_T \|\mathbf{H}_{k0}^{-1} \mathbf{H}_{10} \mathbf{p}_1\|^2 \end{cases} \quad (3)$$

Note that the above results are obtained under $N_t = N_r$; when $N_t > N_r$, the inverse of \mathbf{H}_{k0} should be replaced by its Moore-Penrose pseudo inverse. One can now easily see that IS subsumes IN as a special case, making IS more general. Considering the power overhead, we limit the sum of P_k^{st} and power for the desired signal's transmission to a fixed value P_T . Moreover, only $s_{t,k}^Q = 0$ is considered in our current design.

Fig. 4 plots spatial spectrums of various signals to show the feasibility of IS where $N_t = N_r = 2$ and the desired and interference signals are randomly generated. The center frequency of input signal is $f_0 = 2.4\text{GHz}$, the antenna-element spacing is half of the signal wavelength, and the SNR of each signal is 20dB. We first employ the MUSIC (Multiple Signal Classification) algorithm to estimate DoA (Direction of Arrival) of each signal. Then, we reconstruct the spatial spectrum of signal components observed at the receiver. For ease of comparison, we also plot signal transmission via the second eigenmode which is orthogonal to the desired

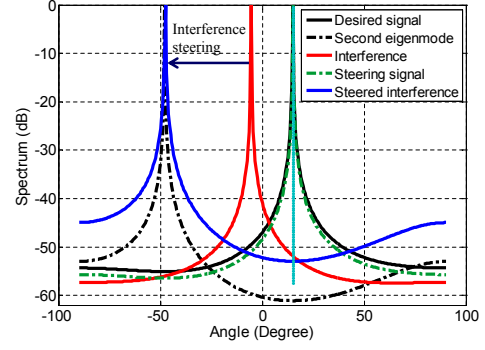

Fig. 4. Spatial spectrums of different signals.

signal utilizing the principal eigenmode. Fig. 4 shows that the steering signal moves the interference's DoA to be the same as the DoA of signal using the second eigenmode. Moreover, the lowest point of the steered interference overlaps with the peak of the desired signal. That is, the desired transmission has become interference-free.

B. Comparison of IS and Other Transmitter-Based Methods

So far, we have presented the basic signal processing of IS. One may think IS similar to some existing IM methods, such as IA, ZFBF, CoMP, IN, etc., but it is not. Basically, all of IA, ZFBF and CoMP require modifications at the interferer, so that the transmission from an interfering Tx to its intended Rx is attenuated. In case of CoMP, the user is served by multiple APs cooperatively. IN and IS are victim Tx-side implementations which are suitable only when the interferer is willing to sacrifice as is usually the case. Compared to IN, IS focuses on canceling only the effective part of the interference, thus becoming more power-efficient. However, it costs one DoF at Rx, just as IA.

Without specifications, the following simulation results in this paper are under $N_t = N_r = 2$. However, the same conclusion can be drawn with various antenna settings. For space limitation, we omit the results for other N_t and N_r values. Fig. 5 comparatively evaluates the achievable system SE of IA, ZFBF, IN and IS by using MATLAB simulation and with the consideration of two communication pairs ($K = 2$) — from AP₀ to STA₀ and from AP₁ to STA₁. AP₁ interferes with STA₀. Note that IA and ZFBF are implemented at AP₁, incurring performance loss to the transmission from AP₁ to STA₁. As for ZFBF, since N_t should be no less than the total number of receiving antennas across all receivers, we let $N_r = 1$. With the other three methods, $N_t = N_r = 2$. IN and IS are carried out by AP₀, when their power overheads, P_0^{ne} and P_0^{st} , exceed the power budget of an AP, e.g., P_T , we simply regard the victim transmission's SE as 0. In the figure, SE of an interference-free point-to-point MIMO (p2pMIMO) transmission employing BF is also plotted as a reference. IS is shown to yield the best system SE (SE of $K = 2$ transmissions). Since $N_r = 1$, the SE performance of ZFBF is inferior to that of IS and IA. System SE of IN is close to that of p2pMIMO, so SE of the transmission pair using

IN is inferred to be very low. It should be noted that due to the randomness of wireless channels, IS may incur more cost compared to IA, thus outputting lower SE under some channel conditions. However, as shown in the figure, the system SE of IS is statistically higher than that of IA.

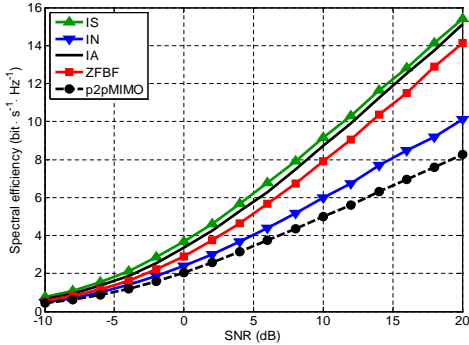

Fig. 5. Average system SE with different IM methods.

C. Multi-Interference Processing

In the above discussion, only one interferer is considered. When a victim Rx suffers from multiple interferers, its associated AP asks the WLAN controller for assistance. The latter is able to check these interference components, combine them together, and then calculate an IS solution in terms of this combined interference [21]. In other words, multiple independent interferences are not treated individually but as a whole (after combining them), and hence the dimension of interference is reduced to 1. In the case of multi-interferences, Eq. (1) can be rewritten as

$$\begin{aligned} \mathbf{y}_0 = & \sqrt{P_T - P_k^{st}} \mathbf{H}_0 \mathbf{p}_0 x_0 + \sum_{m \in \{1, \dots, M\}} \sqrt{P_T} \mathbf{H}_m \mathbf{p}_m x_m \\ & + \sqrt{P_k^{st}} \mathbf{H}_k \mathbf{p}_k^{st} x_k^{st} + \mathbf{z}_0 \end{aligned} \quad (4)$$

where m and M are the index and the total number of interferences, respectively. Transmission from AP_0 to STA_0 is interfered with by the other $M = K - 1$ transmissions. x_k^{st} is dependent on the combination of all interferences.

As in Fig. 6, MATLAB simulation is employed to evaluate the overall SE of $K = M + 1$ transmissions of which M are interferers and 1 is the victim, for different IM methods. For simplicity, we assume no interference between any two interferers. As shown in Fig. 6, the system SE improves as M increases. With IA and ZFBF, the interfering Tx conducts IM, thus degrading all transmissions from the interfering Tx to their intended Rx. In case of IS and IN, AP_0 performs the IM, only the transmission to the victim is affected. However, IS incurs much less power cost than IN, and hence yields higher SE than IN under a transmit power constraint. Thus, IS is shown to provide the best performance, while IN's SE gradually approaches IA's and exceeds ZFBF's as M increases.

We use $r_{s_0}^{\mathcal{M}}$, $r_{s_m}^{\mathcal{M}}$ and $R_{sys}^{\mathcal{M}}$ to denote the average SE of the victim AP_0 's transmission to STA_0 , the interferer's own transmission from AP_m to STA_m where $m \in \{1, \dots, K - 1\}$ and

the system employing \mathcal{M} as the IM method, respectively. r_{BF} is the SE of p2pMIMO with BF. Without loss of generality, we let the victim AP_0 carry out IN or IS. Then, the average system SE of IS, IN, IA and ZFBF with M interferers can be calculated as $R_{sys}^{IS} = r_{s_0}^{IS} + Mr_{BF}$, $R_{sys}^{IN} = r_{s_0}^{IN} + Mr_{BF}$, $R_{sys}^{IA} = r_{BF} + \sum_m^M r_{s_m}^{IA}$, $R_{sys}^{ZFBF} = r_{BF} + \sum_m^M r_{s_m}^{ZFBF}$. For example, when IS or IN is employed, the SE of the victim's transmission is $r_{s_0}^{IS}$ or $r_{s_0}^{IN}$, whereas for the other transmissions, SE is calculated in terms of p2pMIMO. That is, although $r_{s_0}^{IS}$ and $r_{s_0}^{IN}$ decreases as M grows, R_{sys}^{IS} and R_{sys}^{IN} are dominated by Mr_{BF} which grows linearly with M , thus enhancing the system SE. When IN or IS is implemented at AP_k where $k \in \{1, \dots, M\}$, the AP_0 's transmission to STA_0 is free of interference, and hence its SE is equal to r_{BF} . We then have $R_{sys}^{IS} = r_{s_0}^{IS} + Mr_{BF}$ and $R_{sys}^{IN} = r_{s_0}^{IN} + Mr_{BF}$. In case of IA and ZFBF, the victim's transmission becomes free of interference, and hence its SE is equal to r_{BF} . Since $r_{s_m}^{IA} < r_{BF}$ and $r_{s_m}^{ZFBF} < r_{BF}$, protection of STA_0 from the interference of AP_m ($m \in \{1, \dots, M\}$) requires the sacrifice of SE of all the interfering transmissions.

Fig. 7 shows the SE of a single transmission pair for different IM methods. AP_0 's transmission to STA_0 is interfered with by the other $M = K - 1$ transmissions. Under IS and IN, we let AP_0 perform IM, and plot $r_{s_0}^{IS}$ and $r_{s_0}^{IN}$, while studying the SE of an arbitrary interfering transmission — i.e., $r_{s_m}^{IA}$ and $r_{s_m}^{ZFBF}$, $m \in \{1, \dots, M\}$ — under IA and ZFBF. Both $r_{s_0}^{IS}$ and $r_{s_0}^{IN}$ are shown to decrease as M increases. In case of the transmission pair with IA or ZFBF, there is no interference to it, thus making its SE independent of M . From Fig. 7 we can obtain the SE loss of one communication pair which implements an IM method by subtracting the SE of the corresponding method from that of p2pMIMO. With IS and IN, the victim's transmission suffers from some SE loss, whereas for ZFBF and IA, each interferer sacrifices its SE performance so as to avoid interference to the victim Rx. As a result, for IS and IN, in order to guarantee the victim's transmission performance, the number of interferences to a Rx, denoted by η (see in Section V), should be limited.

D. No Need for Cooperative IS

Two types of IS are conceivable: cooperative and non-cooperative. In case of the former, IS is performed by the interfering AP or the other adjacent AP that the victim STA is not associated with, whereas the victim AP generates the IS signal in case of the latter. Note, however, both schemes require the collaboration, i.e., CSI and data sharing, between the AP performing IS and the interfering AP. We elaborate below why cooperative IS is not necessary from two aspects.

First, there may not exist strong motivation for the interfering AP to implement IS, since such an implementation will deteriorate its own transmission and there is not enough incentive to help the other AP's client. Take the communication scenario depicted in Fig. 1 as an example. If AP_1 carries out IS for STA_0 , the received signal at STA_1 becomes

$$\mathbf{y}_1 = \sqrt{P_T - P_1^{st}} \mathbf{H}_1 \mathbf{p}_1 x_1 + \sqrt{P_1^{st}} \mathbf{H}_1 \mathbf{p}_1^{st} x_1^{st} + \mathbf{z}_1 \quad (5)$$

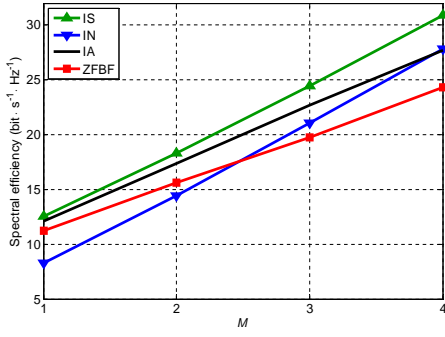

Fig. 6. Average system SE under $M \in \{1, 2, 3, 4\}$ and SNR=15dB.

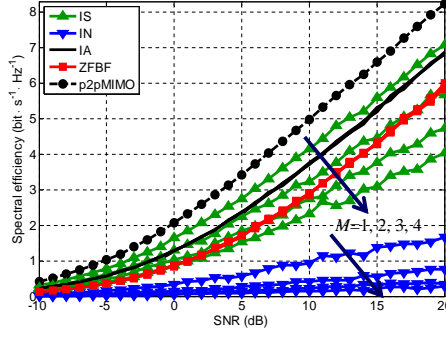

Fig. 7. SE of a single transmission pair under $M \in \{1, 2, 3, 4\}$.

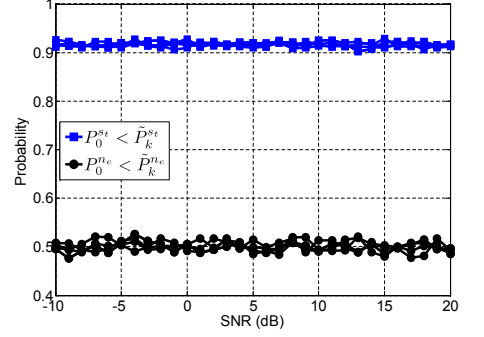

Fig. 8. Comparison of power overheads under $M \in \{1, 2, 3, 4\}$.

where $x_1^{st} = x_1$. By employing $\mathbf{u}_1^{(1)}$ as the receive filter, and noting that the first two signal components on the RHS of Eq. (5) are neither in the same direction nor orthogonal, the received SNR of STA₁ satisfies the following inequality:

$$\gamma_1 < \left\{ (P_T - P_1^{st})[\lambda_1^{(1)}]^2 + P_1^{st} \| [\mathbf{u}_1^{(1)}]^H \mathbf{H}_1 \mathbf{p}_1^{st} \|^2 \right\} / \sigma_n^2. \quad (6)$$

$\lambda_1^{(1)}$ represents the principal eigenvalue of \mathbf{H}_1 . Since $\| [\mathbf{u}_1^{(1)}]^H \mathbf{H}_1 \mathbf{p}_1^{st} \| < \lambda_1^{(1)}$, we can have $\gamma_1 < P_T [\lambda_1^{(1)}]^2 / \sigma_n^2$ where $P_T [\lambda_1^{(1)}]^2 / \sigma_n^2$ is the received SNR of STA₁ without implementing IS. That is, there will be some SE loss w.r.t. the transmission in BSS₁.

Then, let's consider the performance of IS implemented by the victim STA's nearby AP other than its associated AP and the interfering AP. In this case, for ease of comparison we let AP₀ be responsible for the power overhead of IS, and the sum of P_k^{st} and power for the desired signal's transmission is limited to P_T . According to Fig. 1 and the design in Section III.A, the received SNR of STA₀ after post-processing is

$$\gamma_0 = (P_T - P_k^{st})[\lambda_0^{(1)}]^2 / \sigma_n^2. \quad (7)$$

It can be easily seen from Eq. (7) that γ_0 is determined by the power cost of IS. If IS is carried out by AP₀, P_k^{st} is given by $P_0^{st} = P_T \| \mathbf{H}_0^{-1} \mathbf{P} \mathbf{H}_{10} \mathbf{p}_1 \|^2$. Substituting $\mathbf{P} = \mathbf{d}_s (\mathbf{d}_s^T \mathbf{d}_s)^{-1} \mathbf{d}_s^T$ into P_0^{st} , we can obtain the power overhead of non-cooperative IS as:

$$P_0^{st} = P_T \| \mathbf{H}_0 \mathbf{p}_0 \|^2 \| \mathbf{H}_0^{-1} \mathbf{H}_0 \mathbf{p}_0 \|^2 \psi = P_T \| \mathbf{H}_0 \mathbf{p}_0 \|^2 \psi \quad (8)$$

where $\psi = \| (\mathbf{d}_s^T \mathbf{d}_s)^{-1} \mathbf{d}_s^T \mathbf{H}_{10} \mathbf{p}_1 \|^2$. Similarly, when AP_k implements IS for STA₀ where $k \notin \{0, 1\}$, the power consumption of cooperative IS is

$$\tilde{P}_k^{st} = P_T \| \mathbf{H}_0 \mathbf{p}_0 \|^2 \| \mathbf{H}_{k0}^{-1} \mathbf{H}_0 \mathbf{p}_0 \|^2 \psi. \quad (9)$$

We use MATLAB simulation to obtain the probability that P_0^{st} is less than \tilde{P}_k^{st} , or equivalently $\| \mathbf{H}_{k0}^{-1} \mathbf{H}_0 \mathbf{p}_0 \| < 1$, as shown in Fig. 8. Although the above derivation is based on the single-interference assumption, the results for multiple interferences can also be derived, as shown in the figure. Since IN is a special case of IS, the power overheads of non-cooperative and cooperative IN, denoted by P_0^{ne} and \tilde{P}_k^{ne} respectively, are also studied. The probability of $P_0^{st} < \tilde{P}_k^{st}$ is notably higher than that of $P_0^{ne} < \tilde{P}_k^{ne}$, and both are independent of M . This is because cooperative IS consumes more power than the non-cooperative one, whereas for IN, the power cost is statistically

the same with or without collaboration. So, we conclude that IS should better be implemented at the victim transmitter, whereas for IN, selective diversity gain can be obtained by adaptively choosing candidate Tx's which are willing to assist the victim Rx in IN.

IV. APPLICATION OF IS IN ENTERPRISE WLANS

In this section, we elaborate the application of IS in an enterprise WLAN. Fig. 9 shows an example network with $K = 6$ BSSs. However, our discussion can be extended to a general network with a random topology and arbitrary number of interferences. Since an AP can only serve one STA on a frequency channel at a time, other users with transmission demand will be moved to different channels. Without loss of generality, we use STA_m ($m \in \{0, \dots, K-1\}$) to represent the current client served by AP_m. Since there are overlapping areas among adjacent BSSs and all BSSs reuse the same frequency channel, CCI should be well managed so that multiple interfering transmissions can be supported simultaneously. In the next two subsections, we will first discuss the maintenance of information required for IS and use graph theory to analyze the interference relationship among multiple BSSs. We will then elaborate the realization of IS at different network entities.

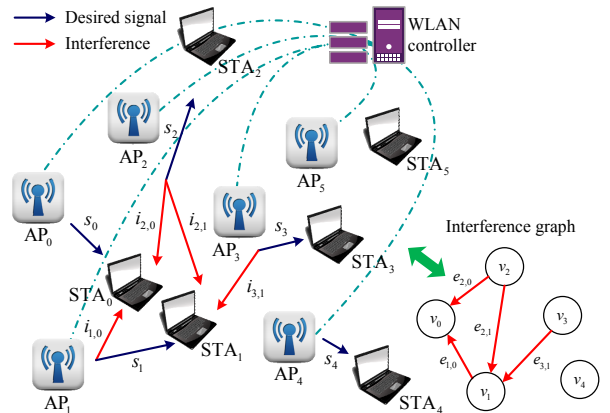

Fig. 9. An example WLAN with multiple interferences and its interference graph.

A. Data Structure and Graph Analysis

In order to achieve IS, a proper data structure should be used for managing necessary network information. We adopt a *connection matrix* \mathbf{C} and a *transmitting status vector* \mathbf{T} for this purpose. \mathbf{C} and \mathbf{T} of the WLAN depicted in Fig. 9 are then expressed as

$$\mathbf{C} = \begin{bmatrix} 1 & 1 & 1 & 0 & 0 & 0 \\ 0 & 1 & 1 & 1 & 0 & 0 \\ 0 & 0 & 1 & 0 & 0 & 0 \\ 0 & 0 & 0 & 1 & 0 & 1 \\ 0 & 0 & 0 & 0 & 1 & 0 \\ 0 & 0 & 0 & 0 & 0 & 1 \end{bmatrix} \quad (10)$$

and

$$\mathbf{T} = [1 \ 1 \ 1 \ 1 \ 1 \ 0]. \quad (11)$$

As shown in Eq. (10), if STA_{*n*} can (not) hear AP_{*m*}, then its connection status $\mathbf{C}(n+1, m+1) = 1(0)$. The principal diagonal elements of \mathbf{C} are 1 due to the association between the corresponding APs and STAs. For example, STA₀ is associated with AP₀, and hence $\mathbf{C}(1, 1) = 1$. STA₀ can also hear adjacent non-associated APs, say AP₁ and AP₂, then $\mathbf{C}(1, 2) = \mathbf{C}(1, 3) = 1$. In case of STA₃, although AP₅ is not transmitting to STA₅, STA₃ is in the coverage of AP₅, and thus $\mathbf{C}(4, 5) = 1$. From Eq. (11) we can see that when AP_{*m*} transmits to its associated client STA_{*m*}, the $(m+1)^{th}$ element of \mathbf{T} , $\mathbf{T}(m)$, is 1.

Both \mathbf{C} and \mathbf{T} are constructed based on the feedbacks from all APs and maintained by the WLAN controller. When a collision is detected and reported to an AP, the AP will inquire the central controller. Upon receiving the interference management requirement, the controller performs the operation in Eq. (12) to obtain the *adjacency matrix*, or the *interference matrix*, represented by \mathbf{A} as:

$$\mathbf{A} = \text{diag}(\mathbf{T})(\mathbf{C} - \mathbf{I}) \quad (12)$$

where $\text{diag}(\mathbf{a})$ indicates the diagonalization of vector \mathbf{a} and \mathbf{I} is a $K \times K$ unit matrix. \mathbf{A} specifies the interferences among all BSSs. For example, substituting Eqs. (10) and (11) into (12), we can get

$$\mathbf{A} = \begin{bmatrix} 0 & 1 & 1 & 0 & 0 & 0 \\ 0 & 0 & 1 & 1 & 0 & 0 \\ 0 & 0 & 0 & 0 & 0 & 0 \\ 0 & 0 & 0 & 0 & 0 & 1 \\ 0 & 0 & 0 & 0 & 0 & 0 \\ 0 & 0 & 0 & 0 & 0 & 0 \end{bmatrix}, \quad (13)$$

based on which an IS solution for the network can be calculated as discussed in the next subsection.

So far, the network's interference status is represented by \mathbf{A} . According to graph theory, an interference graph can also be employed to describe the interference relationship among BSSs. As shown in the bottom-right of Fig. 9, each vertex denoted by v_m indicates a data transmission in a BSS. The directed edge $e_{m,n}$ represents the interference from vertex m to n . The weight of an edge could be the strength of interference to its destination. Since AP₅ is not in service, v_5 is not included in the graph.

Before delving into interference further, we first discuss some useful properties of the interference graph.

First, since we assume use of BF by all transmissions, the number of edges between two adjacent vertices is at most one. However, our design can be easily extended to the case where spatial multiplexing (SM) is used by the interferer and/or the victim BSS. Such an extension does not affect the applicability of IS. On one hand, when the interferer adopts SM, there exist multiple interference components, but since IS is designed based on the aggregated effect of interference, IS is achievable in the same way as in the single-interference case. On the other hand, when the victim BSS employs SM, there will be multiple mutually orthogonal intended transmissions from the victim AP to its recipient. Since each steering signal is in the opposite direction to the corresponding desired signal component, the steering signal for one spatial data stream will not interfere with the others and an IS solution for the STA receiving multiple desired streams is available.

Second, an AP cannot implement IS for more than one victim STA simultaneously due to the non-orthogonality of transmissions to these STAs. For example, if an AP serves two clients both of which are interfered with by nearby AP(s), when the victim AP generates a steering signal for one victim user, additional interference (regarded as the side-effect of IS) will be incurred to the other victim transmission, and vice versa, thus making IS unavailable.

Third, we don't advocate cooperative IS due to its higher power overhead than the non-cooperative counterpart. In addition, an AP's assistance of another AP's client in achieving IS will incur additional interference to ongoing transmissions of its associated STA as well as non-associated STAs in its coverage area. An IS solution that counts for assistant AP selection will be very difficult, or even impossible to obtain due to the increased computational complexity or because the problem may become non-convergent. For example, when AP_{*k*} is employed for sending a steering signal $s_{t,k}$ to assist AP₀ in IS, as shown in Fig. 1, an additional interference $i'_{k,1}$ will be imposed on STA₁. If AP₁ adjusts its transmission to adapt to this interference, the interference from AP₁ to STA₀, i.e., $i_{1,0}$ varies, needing an updated steering signal from AP_{*k*}. Since the above process is non-convergent, cooperative IS is unavailable in such a situation.

Fourth, recall that for the first case in Fig. 2, an interference cycle, i.e., mutual-interference between two BSSs, occurs, and then one transmission is blocked. When this situation is generalized to the multi-BSS ($K \geq 3$) scenario, similarly to the two-BSS case, we disallow cycles, i.e., if there is (are) cycle(s), then at least one vertex should be deleted so as to break cycle(s). This can be explained in terms of the side effects of IS, i.e., additional interference. Take a three-node cycle as an example in Fig. 9 where $e_{2,0}$ is replaced with $e_{0,2}$, forming a cycle with $v_0, e_{0,2}, v_2, e_{2,1}, v_1$ and $e_{1,0}$. Without loss of generality, we calculate an IS solution for v_0 first and then obtain $s_{t,0}$. Since $s_{t,0}$ introduces additional interference $i'_{0,2}$ to v_2 , a steering signal for v_2 should be generated based on $i_{0,2} + i'_{0,2}$. Similarly, $s_{t,1}$ is calculated

in terms of $i_{2,1} + i_{0,2} + i'_{0,2}$. In the end, $i'_{1,0}$ yielded by $s_{t,1}$ will lead to the recalculation of $s_{t,0}$ at v_0 . This phenomenon is similar to a positive feedback that makes a stable IS solution unavailable in a network with interference cycles.

Based on the above discussion, the feasibility characterization of IS can be stated as in the following theorem.

Theorem 1: A set of directed links are feasible for IS if and only if their interference graph is acyclic.

To be specific, in order to achieve IS, the original interference graph should be converted to a directed acyclic graph (DAG) [22]. Moreover, due to the randomness of networks, the interference graph may not be connected. Thus, given an interference graph, we should first check its connectivity. For each connected part, we employ a depth-first search (DFS) algorithm to detect cycles [22]. Considering the fact that each vertex represents a data transmission, we break a cycle by deleting a set of nodes according to the following two rules. First, remove as few vertices as possible. Second, if the first rule is met, the sum weight of the outgoing edges of the deleted node set should be maximized, i.e., remove the set of nodes generating the most interference. A brute-force search can be used to obtain such a set of nodes.

So far, we can obtain one or multiple DAGs, depending on the connectivity of the original interference graph. Then, an IS solution is calculated for each sub-graph. Topological sorting [22] is used to determine the order of vertices that IS is computed for. Before detailing the application of this algorithm in the next subsection, we introduce one definition and two properties of the DAG of our interest as follows.

Definition 1: For a vertex, the number of tail ends adjacent to a vertex is called the *indegree* of the vertex and the number of head ends adjacent to a vertex is its *outdegree*.

Property 1: Every acyclic graph contains at least one vertex with zero indegree; otherwise, there is a cycle.

Proof: The proof can be found in [23]. ■

Property 2: The interference graph remains unchanged with non-cooperative IS.

Proof: Note that each vertex represents a data transmission and the transmission range of a steering signal is the same as its data signal. Given an interference graph, if there is an edge, say $e_{m,n}$, between two vertices, and AP_m generates steering signal $s_{t,m}$ for its client, then the interference $i'_{m,n}$ caused by $s_{t,m}$ in addition to the original interference $i_{m,n}$ will be incurred to STA_n being served by AP_n ; if there is no edge between v_m and v_n , after AP_m implements IS, STA_n receives nothing from AP_m . For the above two cases, no new edge between the two nodes will be established with non-cooperative IS, and thus Property 2 follows. ■

B. Application of IS in WLANs

We now detail the implementation of IS at STA, AP, and the central controller, respectively. Note that the interferer is not required to do anything for IS except for CSI and data sharing with the victim transmitter.

A STA needs to perform 6 tasks for IS as follows. First, it must construct a list of available networks in terms of the

received beacon signals. Second, it must determine whether it is an edge STA or a central STA according to the number of available networks on the list. Third, it should estimate CSI based on the NDP frames sent from nearby APs and feed back this information to the associated AP. Fourth, it should contend for a channel according to the LBT rule. Fifth, it should detect collision/interference from adjacent APs during data transmission. Sixth, it should ask the associated AP for assistance when collision/interference occurs.

It should be noted that only edge STA requests for IM assistance, i.e., the proposed mechanism focuses on the management of interference in the overlapping areas. Compared to the existing IEEE 802.11 protocols, one can see that IS requires only minor modifications of STA, i.e., an increased CSI estimation workload and feedback overhead w.r.t. the edge STA.

APs are connected to a central controller, and only need to inquire of the controller upon reception of an IM request from their clients. The controller calculates IS. In future WLANs, more processing is expected to move from APs to the controller, i.e., an AP may only be responsible for generating RF signals by following the instructions sent from the controller.

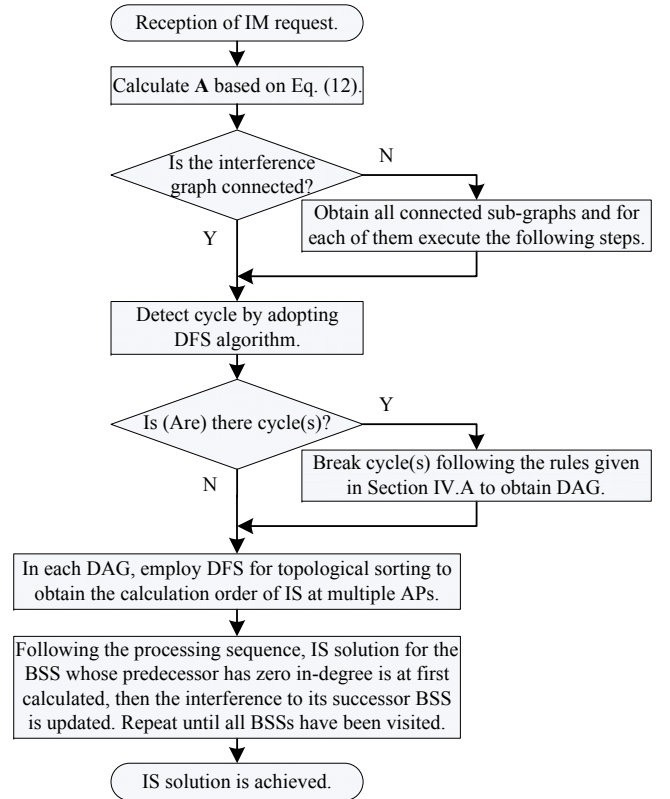

Fig. 10. Flowchart of IS implementation at the WLAN controller.

As for the WLAN controller, it maintains \mathbf{C} and \mathbf{T} based on the information received from APs. Upon receiving an IM request from APs, the controller calculates an IS solution following the procedure in Fig. 10. Then, it sends instructions

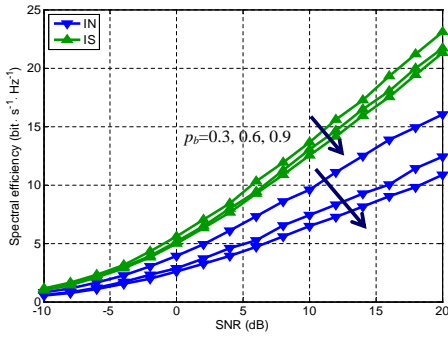

Fig. 13. System SE under $K = 3$, $p_b \in \{0.3, 0.6, 0.9\}$ and $\eta = 2$.

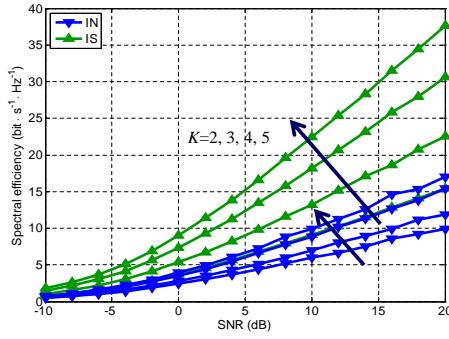

Fig. 14. System SE under $p_b = 0.9$, $K \in \{2, 3, 4, 5\}$ and $\eta = 1$.

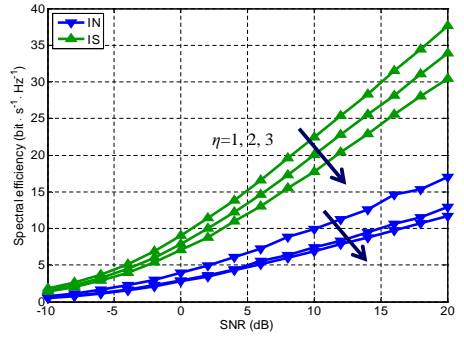

Fig. 15. System SE under $K = 5$, $p_b = 0.9$ and $\eta \in \{1, 2, 3\}$.

to each victim AP, based on which proper steering signals are generated.

According to the above discussion, IS can be implemented in WLANs with random network topologies and arbitrary number of interferences. Compared to existing WLAN protocols, the interferer is not required to do anything for IS and only minor modifications are required at the victim AP and STA. To reduce the scale of interference map and the corresponding processing complexity, we can divide the entire WLAN into multiple sub-networks each of which consists of a limited number of APs. IS is then realized in each part. However, in such a case, interference between sub-networks cannot be managed.

V. EVALUATION

We evaluate the performance of IS using MATLAB simulation. We set $N_t = N_r = 2$. The system includes K APs with random overlapping areas. All APs have the same transmit power P_T . We define the probability that the element in \mathbf{A} is 1 as p_b . By choosing different p_b s, an interference graph with various interference densities can be generated. Since we focus on IS based on victim Tx and the advantages of IS over other non-victim-Tx based implementations have been shown in Section III, here we only study the spectral efficiency of IS and IN in a generalized WLAN with random number and distribution of interferences. It should be noted that with IS or IN, a power overhead will be incurred at the executing AP; when this power cost exceeds P_T , neither IS nor IN is applicable, thus yielding $SE=0$.

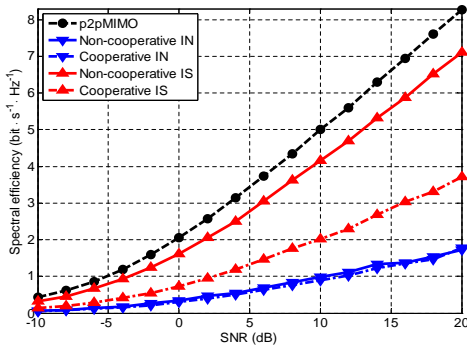

Fig. 11. Single transmission's SE with non-cooperative and cooperative IS/IN and single interference.

Fig. 11 plots the SE of a victim transmission in a BSS, denoted by a vertex in an interference graph, with non-cooperative and cooperative IS/IN and single interference. IS is shown to outperform IN due to the reduced power overhead. Cooperative IS is obviously inferior to non-cooperative IS, whereas cooperative and non-cooperative IN yield statistically the same SE. This is consistent with the results given in Fig. 8.

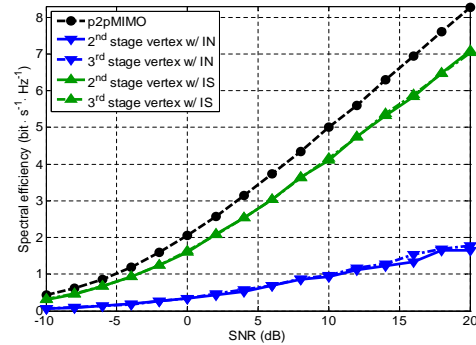

Fig. 12. Single transmission's SE at different processing stages.

Fig. 12 shows the influence of processing stage on a victim user's average SE. We adopt $K = 3$ and the interference graph with a linear topology. For example, AP_1 disturbs STA_2 associated with AP_2 , AP_0 interferes with STA_1 being served by AP_1 , and STA_0 associated with AP_0 is free of interference. According to the IS implementation in Fig. 10, since the indegree of v_0 is 0, i.e., interference-free, the IS solution for its successor vertex v_1 should be calculated first, and then v_2 . We call v_1 and v_2 the 2nd and 3rd stage vertex, respectively. It can be seen from Fig. 12 that the processing stage doesn't affect the victim's SE under either IS or IN. This is because the victim's SE is dependent on the strength of interference which can be referred to the result given in Fig. 7 where MP_T is the total transmit power of M interferers, but in the given linear topology, the strength of interference incurred to v_1 and v_2 is statically identical.

Fig. 13 plots the average system SE with IS and IN under $K = 3$ and various p_b s. Each victim suffers from at most two interferences, i.e., $\eta = 2$. SE performance is shown to decrease as p_b increases. Given the same p_b , IS outperforms IN. Moreover, since IS focuses on the mitigation of effective

part of interference imposed on the victim transmission, its SE is not as sensitive to p_b as IN's.

Fig. 14 shows the average system SE with IS and IN under fixed p_b , various K and $\eta = 1$. Although given a fixed p_b , a larger K yields higher CCI among BSSs, since IS can effectively mitigate the influence of interference on each transmission, system SE grows as K increases. Moreover, recall that IS requires much less power than IN, more transmit power will be available for data transmission, and hence IS outperforms IN in SE.

Fig. 15 plots the average system SE with IS and IN under $K = 5$, $p_b = 0.9$, and various η . SE is shown to decrease with increasing η , because as η grows, the aggregated interference is strengthened and more power will be consumed for generating a steering signal. Thus, each victim's SE decreases, degrading system SE.

VI. CONCLUSION

In this paper, we have proposed and evaluated a novel interference management technique, called *interference steering* (IS). By exploiting both CSI w.r.t. and data carried in the interference(s), a steering signal is generated so that the spatial feature of interference is made orthogonal to the intended transmission at the victim receiver. IS does not require any adjustment at the interferer and only minor modifications are required at the victim transmission pair, thus facilitating its practical implementation and deployment. The proposed mechanism can be applied to general enterprise WLANs with random network topologies and arbitrary number and distribution of interferences. Our simulation results show that IS can significantly improve system SE over the other existing IM methods.

ACKNOWLEDGMENTS

This work was supported in part by NSFC (61173135, U1405255); the 111 Project (B08038); the Fundamental Research Funds for the Central Universities (JB171503). It was also supported in part by the US National Science Foundation under Grant 1317411.

REFERENCES

- [1] NTT DOCOMO, INC, "DOCOMO 5G White Paper, 5G Radio Access: Requirements, Concept and Technologies," 2014.
- [2] "5G White Paper," <http://euchina-ict.eu/wp-content/uploads/2015/01/5G-SIG-white-paper-first-version.pdf>.
- [3] M. Qian, W. Hardjawana, Y. Li, et al., "Inter-cell interference coordination through adaptive soft frequency reuse in LTE networks," in Proc. of the IEEE Wireless Commun. and Networking Conf. (WCNC), pp. 1618-1623, 2012.
- [4] M. I. Kamel, K. M. F. Elsayed, "Performance evaluation of a coordinated time-domain eICIC framework based on ABSF in heterogeneous LTE-Advanced networks," in Proc. of the Global Commun. Conf. (GLOBECOM), pp. 5326-5331, 2012.
- [5] T. Yoo, A. Goldsmith, "On the optimality of multiantenna broadcast scheduling using zero-forcing beamforming," IEEE J. Select. Areas Commun., vol. 24, no. 3, pp. 528-541, 2006.
- [6] D. Tse, P. Viswanath, "Fundamentals of Wireless Communication," Cambridge University Press, 2004.
- [7] 3GPP TR36.814, "Further advancements for E-UTRA physical layer aspects; Coordinated multiple point transmission and reception," 2010.

- [8] M. Mollanoori, M. Ghaderi, "Uplink scheduling in wireless networks with successive interference cancellation," IEEE Trans. Mobile Computing, vol. 13, no. 5, pp. 1132-1144, 2014.
- [9] C. M. Yetis, T. Gou, S. A. Jafar, et al., "On feasibility of interference alignment in MIMO interference networks," IEEE Trans. Sig. Process., vol. 58, no. 9, pp. 4771-4782, 2010.
- [10] S. Mohajer, S. N. Diggavi, C. Fragouli, and D. N. C. Tse, "Transmission techniques for relay-interference networks," in Proc. of the 46th Annual Allerton Conf. Commun., Control, and Computing, pp. 467-474, 2008.
- [11] J. Zhang, Z. K. M. Ho, E. Jorswieck, et al., "SINR balancing for non-regenerative two-way relay networks with interference neutralization," in Proc. of Int'l Conf. Acoustics, Speech and Sig. Process. (ICASSP), pp. 7604-7608, 2014.
- [12] D. Wu, C. Yang, T. Liu, et al., "Feasibility conditions for interference neutralization in relay-aided interference channel," IEEE Trans. Sig. Process., vol. 62, no. 6, pp. 1408-1423, 2014.
- [13] J. Chen, A. Singh, P. Elia, et al., "Interference neutralization for separated multiuser uplink-downlink with distributed relays," in Proc. of the Inf. Theory and Applications Workshop (ITA), pp. 1-9, 2011.
- [14] T. Gou, S. A. Jafar, C. Wang, et al., "Aligned interference neutralization and the degrees of freedom of the $2 \times 2 \times 2$ interference channel," IEEE Trans. Inf. Theory, vol. 58, no. 7, pp. 4381-4395, 2012.
- [15] "Enterprise Mobility 4.1 Design Guide," http://www.cisco.com/c/en/us/td/docs/solutions/enterprise/Mobility/emob73dg/emob73/ch3_WLAN.html
- [16] E. Perahia, R. Stacey, "Next Generation Wireless LANs: 802.11n and 802.11ac, 2nd Edition," Cambridge University Press, New York, 2013.
- [17] S. He, H. Wang, Y. Huang, et al., "CSI Feedback for MIMO-OFDM Transmission in IEEE 802.11aj (45 GHz)," IEEE 802.11-14/1400r1, 2014.
- [18] S. Sen, R. R. Choudhury, S. Nelakuditi, "CSMA/CN: Carrier Sense Multiple Access With Collision Notification," IEEE/ACM Trans. Net., vol. 20, no. 2, pp. 544-556, 2011.
- [19] S. Rayanchu, A. Mishra, D. Agrawal, et al, "Diagnosing Wireless Packet Losses in 802.11: Separating Collision from Weak Signal," in Proc. of the IEEE Conf. Computer Commun. (INFOCOM), pp. 1409-1417, 2008.
- [20] 3GPP TR36.814, "Further advancements for E-UTRA physical layer aspects; Coordinated multiple point transmission and reception," 2010.
- [21] Z. Li, X. Dai, Shin G. Kang, "Decoding Interfering Signals With Fewer Receiving Antennas," in Proc. of the IEEE Conf. Computer Commun. (INFOCOM), pp. 370-378, 2016.
- [22] J. L. Gross, J. Yellen, P. Zhang, "Handbook of Graph Theory, Second Edition," Chapman & Hall/CRC Press, Boca Raton, 2013.
- [23] P. V. Dooren, "Graph Theory and Applications," www.hamilton.ie/ollie/Downloads/Graph.pdf.