

A Characterization of $(4, 2)$ -Choosable Graphs

Daniel W. Cranston*

March 7, 2024

Abstract

A graph G is (a, b) -choosable if given any list assignment L with $|L(v)| = a$ for each $v \in V(G)$ there exists a function φ such that $\varphi(v) \in L(v)$ and $|\varphi(v)| = b$ for all $v \in V(G)$, and whenever vertices x and y are adjacent $\varphi(x) \cap \varphi(y) = \emptyset$. Meng, Puleo, and Zhu conjectured a characterization of $(4, 2)$ -choosable graphs. We prove their conjecture.

1 Introduction

1.1 History

All graphs we consider are finite and simple (we forbid loops and multiple edges). A graph G is (a, b) -choosable if given any list assignment L with $|L(v)| = a$ for each $v \in V(G)$, there exists a function φ such that $\varphi(v) \in L(v)$ and $|\varphi(v)| = b$ for all $v \in V(G)$ and $\varphi(v) \cap \varphi(w) = \emptyset$ for all $vw \in E(G)$. In other words, φ assigns to each vertex a subset of size b of its a allowable colors, and any adjacent vertices are assigned disjoint subsets. Such an L is an a -list assignment (or a -assignment, for short) and such a φ is a b -fold L -coloring of G . As a special case, a graph is (a, b) -colorable if it has a b -fold L coloring, when $L(v) = \{1, \dots, a\}$ for all v .

The concept of (a, b) -choosability was introduced in the late 1970s by Erdős, Rubin, and Taylor [4]. In the same paper, Rubin characterized $(2, 1)$ -choosable graphs. To state his result, we need two definitions. A θ -graph, $\theta_{a, b, c}$, is formed from vertex disjoint paths with lengths a , b , c by identifying one endpoint of each path to form a vertex of degree 3 and also identifying the other endpoint of each path to form a second vertex of degree 3. We occasionally write $\theta_{a, b, c, d}$ for the analogous graph with a fourth path, of length d . The core of a connected graph G , denoted $\text{core}(G)$, is its maximum subgraph with minimum degree at least 2. Alternately, the core is the result when we repeatedly delete vertices of degree 1, for as long as possible. A graph is $(2, 1)$ -choosable if and only if its core is (this is a special case of Proposition 3). Rubin showed that a connected graph is $(2, 1)$ -choosable if and only if its core is K_1 , C_{2s} , or $\theta_{2, 2, 2s}$.

Erdős, Rubin, and Taylor concluded their paper with a number of conjectures and open questions. One asks whether a graph being (a, b) -choosable implies that it is (am, bm) -choosable. This question remains largely open¹, though some cases have been resolved, affirmatively. Tuza and Voigt [9] used Rubin's characterization of $(2, 1)$ -choosable graphs to answer this question positively when $(a, b) = (2, 1)$. In related work, Voigt [10] showed that when m is an odd integer, a graph is $(2m, m)$ -choosable precisely when it is $(2, 1)$ -choosable. (See Lemma 24 for a short proof published in [5].) Combining these two results shows that whenever a and m are integers, with a odd, if a graph is $(2a, a)$ -choosable, then it is $(2am, am)$ -choosable. As far as we know, (a, b) -choosable graphs have been characterized only when $(a, b) = (2m, m)$ and m is odd.

*Department of Mathematics and Applied Mathematics, Virginia Commonwealth University, Richmond, VA; dcranston@vcu.edu; This research is partially supported by NSA Grant H98230-16-0351.

¹After this paper was submitted, Dvořák, Hu, and Sereni [3] constructed a $(4, 1)$ -choosable graph that is not $(8, 2)$ -choosable.

Here we focus mainly on $(4, 2)$ -choosable graphs. However, in Section 6, we return to the more general case of $(2m, m)$ -choosable graphs, when m is even. Clearly such a graph must be bipartite, since no odd cycle is $(2m, m)$ -colorable. Alon, Tuza, and Voigt [1] showed that if G is (a, b) -colorable, then there exists an integer m such that G is (am, bm) -choosable. Thus, for every bipartite graph G , there exists an m such that G is $(2m, m)$ -choosable. It is easy to construct examples showing that m must depend on G (see Proposition 23). That is, there does not exist a universal constant m such that every bipartite graph is $(2m, m)$ -choosable.

Before moving on, we remark briefly about $(2m, m)$ -paintability. (Paintability is an online version of list-coloring; for a definition, see [6].) A connected graph is $(2m, m)$ -paintable if and only if its core is K_1 , $\theta_{2,2,2}$, or C_{2s} . Zhu [12] proved this when $m = 1$ and it was extended to the general case by Mahoney, Meng, and Zhu [6]. As with choosability, a graph is $(2m, m)$ -paintable if and only if its core is. That even cycles are $(2m, m)$ -paintable follows directly from the Kernel Lemma (slightly generalized), but handling $\theta_{2,2,2}$ is harder. Most of the work in [6] goes to proving the other direction: for every m all other graphs are not $(2m, m)$ -paintable.

Now we consider $(4, 2)$ -choosability. Meng, Puleo, and Zhu [8] conjectured a characterization of $(4, 2)$ -choosable graphs, and our main result is to confirm their conjecture. We write $H_1 * H_2$ to denote all graphs formed from vertex-disjoint copies of H_1 and H_2 by adding a path (possibly of length 0) from any vertex in H_1 to any vertex in H_2 .

Conjecture 1. *A connected graph is $(4, 2)$ -choosable if and only if its core is one of the following (where s and t are positive integers): (i) K_1 , (ii) C_{2s} , (iii) $\theta_{2,2s,2t}$, (iv) $\theta_{1,2s+1,2t+1}$, (v) $K_{2,4}$, (vi) a graph formed from $K_{3,3} - e$ by subdividing a single edge incident to a vertex of degree 2 an even number of times, (vii) $C_{2s} * C_{2t}$, (viii) $\theta_{2,2,2} * C_{2s}$, or (ix) $(C_4 * C_{2s}) * C_{2t}$ where the C_4 contains two cut-vertices in the final graph and they are non-adjacent.*

Main Theorem. *Conjecture 1 is true.*

1.2 Proof Outline

The proof of the Main Theorem has a number of cases, but the general outline is easy to follow, so we present it here. First we need a few more definitions and a key lemma.

For graphs G and H , we say that G contains a strong minor of H if H can be formed from some subgraph of G by repeatedly applying the following operation: delete a vertex and identify all of its neighbors. Further, we say that G contains a strong subdivision of H if H can be formed from some subgraph of G by repeatedly applying the following operation: delete a vertex of degree 2 with a neighbor of degree 2 and identify the two neighbors of the deleted vertex. Clearly, if G contains a strong subdivision of H then G contains a strong minor of H , but not vice versa. The following lemma is from [8], although a slightly weaker form appeared in [10], and both versions have their roots in [4], which contains similar ideas for $(2, 1)$ -choosability.

Strong Minor Lemma. *If H is not $(2m, m)$ -choosable, and G contains a strong minor of H , then G is not $(2m, m)$ -choosable.*

Proof. Suppose that G' is formed from a subgraph of G by deleting a single vertex, v , and identifying its neighbors. We show that if G' is not $(2m, m)$ -choosable, then neither is G . Let v' be the newly formed vertex in G' . Let L' be a $2m$ -assignment showing that G' is not $(2m, m)$ -choosable. Form a $2m$ -assignment for G as follows. If $w \in V(G')$, then $L(w) = L'(w)$. If $w \in (v \cup \{N(v)\})$, then $L(w) = L'(v')$. If $w \notin (V(G') \cup \{v\} \cup N(v))$, then let $L(w)$ be an arbitrary set of $2m$ colors. Now suppose that G has an m -fold L -coloring, φ . Note that $\varphi(w) = L(v) \setminus \varphi(v)$ for every $w \in N(v)$. Thus, by deleting v and identifying its neighbors, we get an m -fold L' -coloring of G' , a contradiction. Hence, G has no m -fold L -coloring. So G is not $(2m, m)$ -choosable. The lemma follows by induction on the number of deletion/contraction operations used to form H from a subgraph of G . \square

In the rest of the paper all graphs we consider are connected and bipartite. It suffices to consider the core of G , so we assume $\delta \geq 2$ (as usual, δ denotes the minimum degree). Most of

strong minor

strong subdivision

δ

our work is spent showing that if G does not have one of the forms (i)–(ix) in Conjecture 1, then G is not (4,2)-choosable. Specifically, we will find some subgraph of G that is not (4,2)-choosable. If G has arbitrarily large girth, then clearly we must consider some subgraph of arbitrary size to prove that G is not (4,2)-choosable (since all trees are (4,2)-choosable). However, this is not really a problem. Our idea is to give the same list $L(v)$ to each vertex v in some connected subgraph H_1 . In any valid L -coloring of G , every vertex of H_1 in one part of the bipartition must get the same colors; likewise for every vertex of H_1 in the other part (and the sets of colors used on the two parts must partition $L(v)$). Thus, all of these vertices in one part essentially function as a single vertex. We also repeat this list assignment method for other vertex-disjoint connected subgraphs H_i . (This idea is formalized in the Strong Minor Lemma, above.) As a result, all of the list assignments we construct explicitly are for graphs with at most 10 vertices.

We write $\mathcal{B}(G)$ to denote the multiset of blocks of G that contain a cycle, those that are not K_2 . It is straightforward to show that if $|\mathcal{B}(G)| \geq 4$, then G is not (4,2)-choosable. So most of our work is for when $|\mathcal{B}(G)| \in \{1, 2, 3\}$. When $|\mathcal{B}(G)| = 1$ (thus, G is 2-connected, since $\delta \geq 2$), we prove a structural lemma that says that either G is a graph of the form (i)–(vi) in the conjecture, or else G contains a “bad” subgraph. Next we show that all bad subgraphs are, in fact, not (4,2)-choosable. Given a graph G and a 4-assignment L , to prove that G has no 2-fold L -coloring φ , we typically assume that φ exists and reach a contradiction. This finishes the case $|\mathcal{B}(G)| = 1$. It also helps significantly with the cases $|\mathcal{B}(G)| \in \{2, 3\}$, since each block in $\mathcal{B}(G)$ must be of the form (i)–(vi).

Now suppose $|\mathcal{B}(G)| = 2$, and pick an arbitrary block containing a cycle $B_1 \in \mathcal{B}(G)$. We focus on some cut-vertex $v \in V(B_1)$. For most G , we construct some list assignment L and show that G has no 2-fold L -coloring. Our idea is to consider each of the $\binom{4}{2}$ possible ways to color v from $L(v)$. For some of these ways we show that the coloring cannot be extended to all of B_1 , and for the others we show that it cannot be extended to $G \setminus B_1$. The only exceptions are when G is of the form (vii) or (viii). The case $|\mathcal{B}(G)| = 3$ is similar, except that now the exceptions are of the form (ix).

1.3 Preliminaries

Most of our other definitions are standard, but, for reference, we collect some of them here. By G contains H we mean that H is a subgraph of G . A k -vertex is a vertex of degree k . An ear decomposition of a graph G is a partition of its edges into paths P_0, \dots, P_k such that P_0 is a single edge, each other P_i is a path with its endpoints in $\cup_{j=0}^{i-1} P_j$ and its internal vertices (if any) disjoint from this subgraph. For a connected graph G , a vertex $v \in V(G)$ is a cut-vertex of G if $G - v$ is disconnected. If a connected graph has no cut-vertex, then it is 2-connected. A block of a graph G is a maximal 2-connected subgraph. We will use two lemmas of Whitney [11] about 2-connected graphs. We need the second in a slightly more general form than is usually stated, so we include a short proof.

$\mathcal{B}(G)$

k -vertex
ear decomposition
cut-vertex
2-connected
block

Lemma 1. *A connected graph G with at least three vertices is 2-connected if and only if every pair of edges lie on a cycle.*

Lemma 2. *A graph G is 2-connected if and only if G has an ear decomposition. Further, if G is 2-connected and H is a 2-connected subgraph of G , then G has an ear decomposition that begins with an ear decomposition of H .*

Proof. Let C be an arbitrary cycle in G . Clearly C has an ear decomposition. Now suppose H is a proper subgraph of G , and P_0, \dots, P_k is an ear decomposition of H . Pick $e_1 \in E(H)$ and $e_2 \in E(G) \setminus E(H)$. By Lemma 1, some cycle D contains e_1 and e_2 . Let P_{k+1} be a shortest path along D that contains e_2 and has both endpoints in H . Now P_0, \dots, P_k, P_{k+1} is an ear decomposition for a larger subgraph of G . By induction on $|E(G) \setminus E(H)|$, we can extend the ear decomposition to all of G . This proves the first statement. To prove the second, begin with an ear decomposition of H , and extend it to an ear decomposition of G , as in the proof above. \square

Our next proposition is essentially from [4] (and appeared explicitly in [9]). For completeness, we include the proof.

Proposition 3. *For every graph G and every positive integer m , graph G is $(2m, m)$ -choosable if and only if $\text{core}(G)$ is $(2m, m)$ -choosable.*

Proof. We assume G is connected. One direction is trivial, since $\text{core}(G) \subseteq G$. For the other, suppose that $\text{core}(G)$ is $(2m, m)$ -choosable. Let $t = |V(G) \setminus V(\text{core}(G))|$. Let L be a $2m$ -assignment for G . We show that G has an m -fold L -coloring, by induction on t . The case $t = 0$ holds since $\text{core}(G)$ is $(2m, m)$ -choosable, by hypothesis. When $t \geq 1$, G has a 1-vertex, v ; let w be the neighbor of v . By induction, $G - v$ has an m -fold L -coloring, φ . Now $|L(v) \setminus \varphi(w)| \geq 2m - m = m$, so we can extend φ to v . \square

2 $|\mathcal{B}(G)| = 1$

Let $\mathcal{G}_{good} = \{C_{2s}, \theta_{2,2s,2t}, \theta_{1,2s+1,2t+1}, \theta_{2,2,2,2}\}$, where s and t range over all positive integers. Let $\mathcal{G}_{bad} = \{\theta_{3,3,3}, \theta_{2,2,2,4}, K_{3,3}, K_{2,5}, Q_3 - v\}$, where Q_3 denotes the 3-dimensional cube (and v is an arbitrary vertex, since Q_3 is vertex transitive). Every graph in \mathcal{G}_{good} is known to be $(4,2)$ -choosable (we give specific references at the end of Section 4). Later in this section we show that every graph G is not $(4,2)$ -choosable if either $G \in \mathcal{G}_{bad}$ or G contains two cycles that intersect in at most one vertex. (The graphs $\theta_{3,3,3}$ and $\theta_{2,2,2,4}$ were shown to not be $(4,2)$ -choosable by Meng, Puleo, and Zhu, in Section 6 of [8]; all other graphs in \mathcal{G}_{bad} and \mathcal{G}_{cycles} are shown in Figures 3–10.) To conclude this section, we will determine which strong subdivisions of $K_{3,3} - e$ are $(4,2)$ -choosable. Thus, our next lemma plays a central role in our proof of Conjecture 1.

Lemma 4. *Let G be 2-connected and bipartite. Either (i) $G \in \mathcal{G}_{good}$, (ii) G contains two cycles that intersect in at most one vertex, (iii) G contains a strong subdivision of a graph in \mathcal{G}_{bad} , or (iv) G is a strong subdivision of $K_{3,3} - e$.*

Proof. Suppose the lemma is false, and let G be a counterexample. Since G is 2-connected, Lemma 1 implies that G contains some θ -graph H ; if possible, pick H to have its three paths of odd lengths. For a path P , we write $\text{Int}(P)$ to denote the set of interior vertices of P , excluding the endpoints.

Case 1: Each path of H has odd length. Say $H = \theta_{a,b,c}$, with $a \leq b \leq c$. Since G contains no strong subdivision of $\theta_{3,3,3}$, we have $a = 1$. Let v and w denote the 3-vertices in H , and let P_1 and P_2 denote the other two v, w -paths in H . Since G is 2-connected, Lemma 2 implies that G has an ear decomposition that begins with vw, P_1, P_2 . Since $G \notin \mathcal{G}_{good}$, the ear decomposition continues with some path P_3 . Let x_3 and y_3 denote the endpoints of P_3 . If $\{x_3, y_3\} = \{v, w\}$, then G contains a strong subdivision of $\theta_{3,3,3}$, a contradiction. If $|\{x_3, y_3\} \cap \{v, w\}| = 1$, then G contains two cycles intersecting in exactly one vertex, a contradiction. If $x_3, y_3 \in V(P_1)$, then G contains two vertex disjoint cycles (one in $P_1 \cup P_3$ and one in $P_2 + vw$), a contradiction. So, by symmetry between P_1 and P_2 , we assume $x_3 \in \text{Int}(P_1)$ and $y_3 \in \text{Int}(P_2)$.

If x_3 and y_3 are in the same part of the bipartition, then G contains a strong subdivision of $Q_3 - v$, a contradiction. So assume that x_3 and y_3 are in opposite parts. If P_3 is the last ear in the decomposition, then G is a strong subdivision of $K_{3,3} - e$, a contradiction. So assume there exists another ear in the decomposition, P_4 ; call its endpoints x_4 and y_4 . If $x_4, y_4 \in V(P_3)$, then G contains two cycles intersecting in at most one vertex (one in $P_3 \cup P_4$ and one in, say, $P_1 + vw$), a contradiction. Suppose $|\{x_4, y_4\} \cap V(P_3)| = 1$; say $x_4 \in V(P_3)$ and, by symmetry, $y_4 \in V(P_1)$. Again, G contains two cycles intersecting in at most one vertex (one in $P_1 \cup P_3 \cup P_4$ and one in $P_2 + vw$), a contradiction. So $x_4, y_4 \notin V(P_3)$. By the same argument as for P_3 , we can assume that $x_4 \in \text{Int}(P_2)$ and $y_4 \in \text{Int}(P_1)$. Further, when we walk along $P_1 \cup P_2$, vertices x_3 and y_3 must alternate with vertices x_4 and y_4 (since otherwise G contains vertex disjoint cycles, a contradiction). So we may assume the vertices appear in the order x_3, v, x_4, y_3, w, y_4 .

Suppose that x_3 and x_4 are both in the opposite part of the bipartition from v . This implies that also y_3 and y_4 are in the opposite part from w . Thus, G contains a strong subdivision of

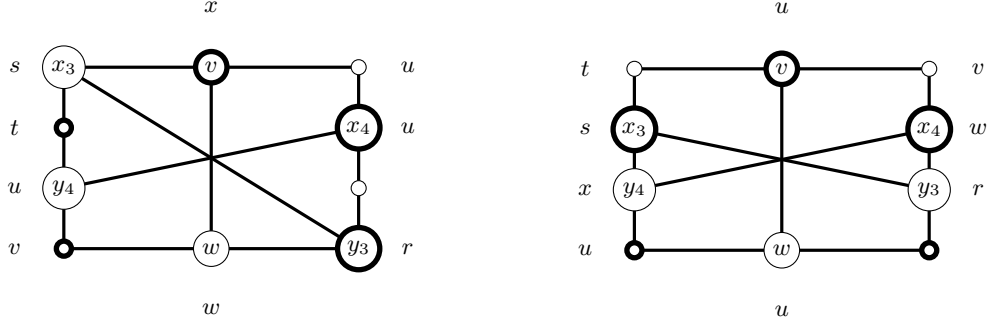

Figure 1: Two strong subdivisions of $Q_3 - v$ that arise in Case 1 of the proof of Lemma 4. The boldness of the vertex indicates its part in the bipartition. The label outside of each vertex indicates its preimage in $Q_3 - v$, as shown in Figure 4.

$K_{3,3}$, a contradiction (the branch vertices are v, w, x_3, x_4, y_3, y_4). So at least one of x_3 and y_3 is in the same part of the bipartition as v . Now G must contain a strong subdivision of $Q_3 - v$; there are two possibilities, both shown in Figure 1. This completes Case 1.

Case 2: G has a θ -subgraph with paths of even lengths (but none with paths of odd lengths). Let P_1, P_2, P_3 be the paths of the θ -subgraph, and let v and w denote their common endpoints. Suppose that G contains a fourth vertex disjoint v, w -path, P_4 . Consider an ear decomposition of G beginning with P_1, \dots, P_4 . Suppose it continues with some ear P_5 , and let x_5, y_5 denote its endpoints. By symmetry, we assume that either (i) $\{x_5, y_5\} = \{v, w\}$, (ii) $x_5 \in \{v, w\}$ and $y_5 \in \text{Int}(P_1)$, (iii) $x_5, y_5 \in \text{Int}(P_1)$, or (iv) $x_5 \in \text{Int}(P_1)$ and $y_5 \in \text{Int}(P_2)$. In (i), G has a strong subdivision of $K_{2,5}$, so we are done. In each of (ii), (iii), and (iv), G has two cycles that intersect in at most one vertex, so again we are done. So we assume no such P_5 exists. Thus, either $G = \theta_{2,2,2,2}$ or G is a strong subdivision of $\theta_{2,2,2,4}$; in each case we are done.

So assume instead that G has no further v, w -path. Since $G \notin \mathcal{G}_{good}$, the ear decomposition must have a fourth ear, P_4 ; again, denote its endpoints by x_4 and y_4 . If $\{x_4, y_4\} \cap \{v, w\} \neq \emptyset$, then G contains two cycles intersecting in at most one vertex, so we are done. Similarly, if $\{x_4, y_4\} \in \text{Int}(P_1)$, then G contains two disjoint cycles; again we are done. So, by symmetry, we assume that $x_4 \in \text{Int}(P_1)$ and $y_4 \in \text{Int}(P_2)$. Since, we are not in Case 1, vertices x_4 and y_4 must

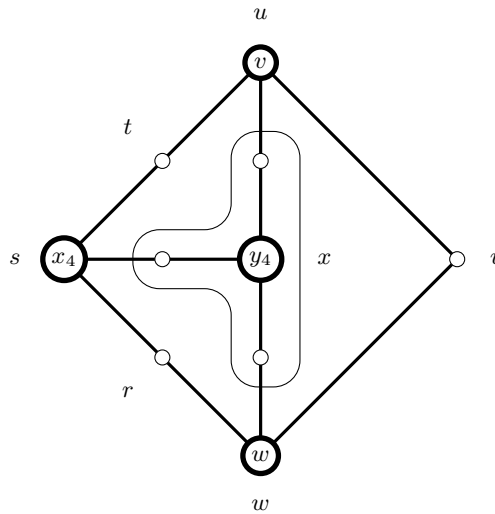

Figure 2: A strong subdivision of $Q_3 - v$ arising in Case 2 of the proof of Lemma 4. The boldness of the vertex indicates its part in the bipartition. The label outside of each vertex (or set of vertices) indicates its preimage in $Q_3 - v$, as shown in Figure 4.

be in the same part of the bipartition. Similarly, vertices x_4 and y_4 are in the same part of the bipartition as vertices v and w . Now G contains a strong subdivision of $Q_3 - v$, a contradiction (see Figure 4). \square

Let \mathcal{G}_{cycles} denote the set of five graphs shown in Figures 3, 5, 7, 9, and 10. \mathcal{G}_{cycles}

Lemma 5. *If a graph G is 2-connected, bipartite, and contains two cycles that intersect in at most one vertex, then G contains a strong minor of some graph in \mathcal{G}_{cycles} .*

Proof. Let G be 2-connected. Suppose G has two cycles, C_1 and C_2 , that intersect in a single vertex, v . By Menger's Theorem there exists a path P from C_1 to C_2 that has its internal vertices disjoint from C_1 and C_2 . Let w_1 and w_2 denote the endpoints of P on C_1 and C_2 . Now G has as a strong minor the graph in Figure 3, 9, or 10, depending on whether 0, 1, or 2 of w_1 and w_2 lie in the same part of the bipartition as v .

Suppose instead that G has vertex disjoint cycles, C_1 and C_2 . By Menger's Theorem, G has disjoint paths P_1 and P_2 from C_1 to C_2 (with their internal vertices disjoint from C_1 and C_2). Let v_1 and w_1 denote the endpoints on C_1 of P_1 and P_2 , and let v_2 and w_2 denote the endpoints on C_2 of P_1 and P_2 . If either of P_1 and P_2 has even length, then we can contract it to reach the case handled above, since G has as a strong minor two cycles intersecting in a single vertex. So we instead assume that both P_1 and P_2 have odd length. Now G has as a strong minor either Figure 5 or Figure 7, depending on whether or not v_1 and v_2 lie in the same part of the bipartition. \square

We typically denote the colors in our 4-assignments by elements of $\{1, \dots, 7\}$. For brevity, we usually suppress set notation. So we write 1235 as shorthand for $\{1, 2, 3, 5\}$.

Lemma 6. *Every graph in \mathcal{G}_{bad} and \mathcal{G}_{cycles} is not $(4, 2)$ -choosable.*

Proof. Given a 4-assignment L for a graph G , to show that G has no 2-fold L -coloring, we pick some vertex z and show that each of the $\binom{4}{2}$ ways to color z cannot be extended to all of G . This is generally straightforward, though a few cases involve wrinkles. For brevity we omit the details, but they are available in an earlier version of this paper [2]. To illustrate the idea, consider the bold vertex, v , in Figure 3. If v is colored with 12, then its neighbor to the left, w , is colored 45, and the vertex below w is colored 16. But now the vertex below v cannot be colored. Similarly, we can show that none of the $\binom{4}{2}$ possible colorings of v extends to the whole graph. So G has no L -coloring. For each of Figures 3–8, we use a similar argument, starting from the bold vertex. For Figures 9 and 10, the analysis is a bit more subtle, though it follows the same approach. \square

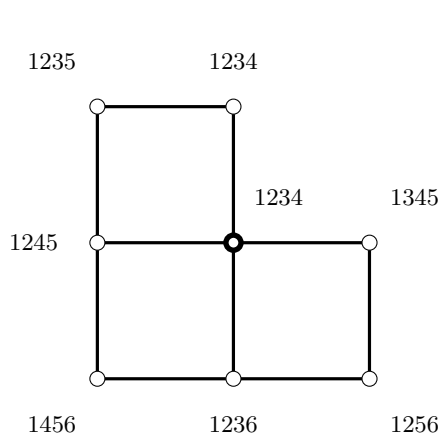

Figure 3

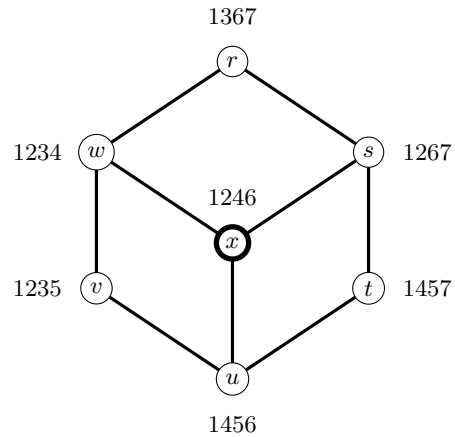

Figure 4

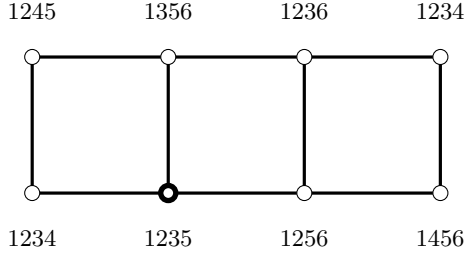

Figure 5

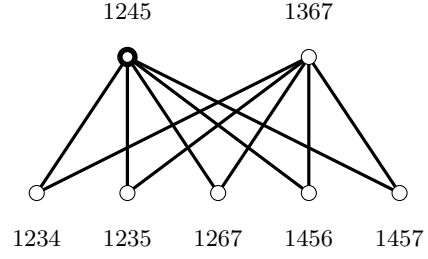

Figure 6

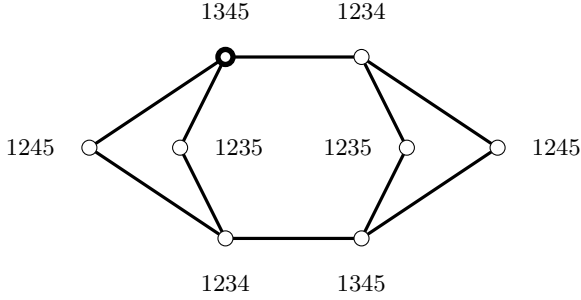

Figure 7

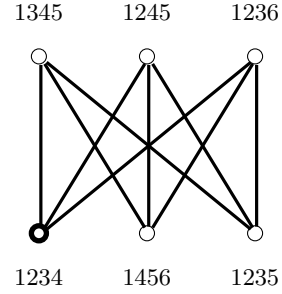

Figure 8

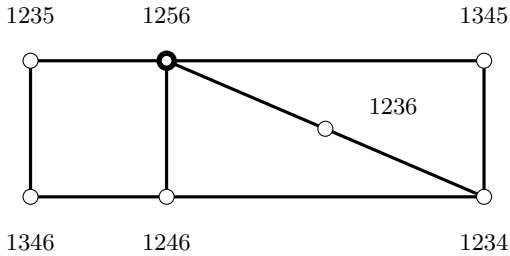

Figure 9

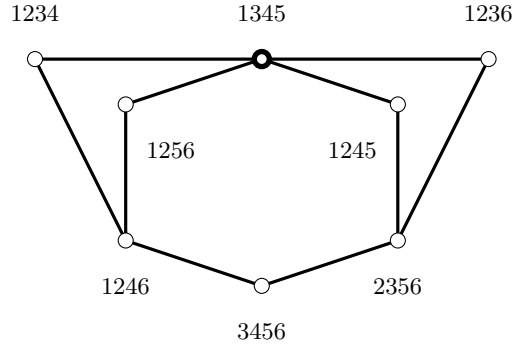

Figure 10

Lemma 7. *A strong subdivision of $K_{3,3} - e$ is $(4,2)$ -choosable only if it can be formed from $K_{3,3} - e$ by repeatedly subdividing a single edge incident to a vertex of degree 2.*

Proof. Note that $K_{3,3} - e$ contains eight edges; four are each incident to one 2-vertex, and the other four are each incident to two 3-vertices. It is easy to check that if a strong subdivision of $K_{3,3} - e$ cannot be formed from $K_{3,3} - e$ by repeatedly subdividing a single edge incident to a vertex of degree 2, then it is a strong subdivision of the graph shown in either Figure 11 or Figure 12. So, by the Strong Minor Lemma, it suffices to show that neither of these graph is $(4,2)$ -choosable.

Let G denote the graph in Figure 11, and L denote its 4-assignment. If $\varphi(x) = 12$: $\varphi(w) = 34$, $\varphi(v) = 15$, $\varphi(u) = 26$, $\varphi(t) = 13$, $\varphi(y) = \infty$. Here, and throughout, we write $\varphi(v) = \infty$ to denote that v has at most one color remaining in its list, so cannot be colored. If $\varphi(x) = 14$: $\varphi(s) = 56$, $\varphi(r) = 13$, $\varphi(w) = \infty$. If $\varphi(x) = 15$: $\varphi(y) = 23$, $\varphi(t) = 16$, $\varphi(s) = \infty$. If $\varphi(x) = 24$: $\varphi(w) = 13$, $\varphi(r) = 56$, $\varphi(s) = \infty$. If $\varphi(x) = 25$: $\varphi(y) = 13$, $\varphi(t) = 26$, $\varphi(u) = 15$, $\varphi(v) = 34$, $\varphi(w) = \infty$. If $\varphi(x) = 45$: $\varphi(s) = 16$, $\varphi(t) = 23$, $\varphi(y) = \infty$.

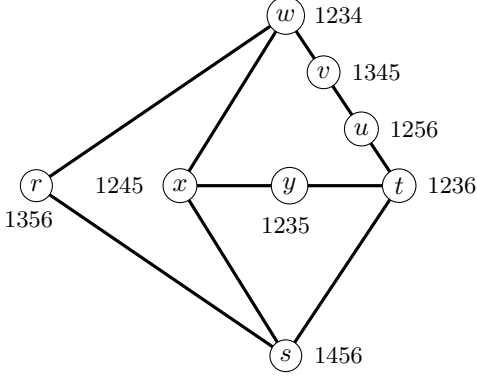

Figure 11

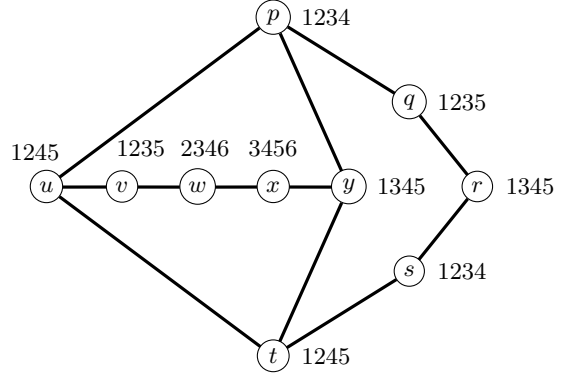

Figure 12

Now let G denote the graph in Figure 12, and L denote its 4-assignment. If $\varphi(t) = 12$: $\varphi(s) = 34$, $\varphi(r) = 15$, $\varphi(q) = 23$, $\varphi(p) = 14$, $\varphi(u) = \infty$. If $\varphi(t) = 14$: $\varphi(y) = 35$, $\varphi(x) = 46$, $\varphi(w) = 23$, $\varphi(v) = 15$, $\varphi(u) = \infty$. If $\varphi(t) = 15$: $\varphi(u) = 24$, $\varphi(p) = 13$, $\varphi(y) = \infty$. If $\varphi(t) = 24$: $\varphi(u) = 15$, $\varphi(v) = 23$, $\varphi(w) = 46$, $\varphi(x) = 35$, $\varphi(y) = \infty$. If $\varphi(t) = 25$: $\varphi(u) = 14$, $\varphi(p) = 23$, $\varphi(q) = 15$, $\varphi(r) = 34$, $\varphi(s) = \infty$. If $\varphi(t) = 45$: $\varphi(y) = 13$, $\varphi(p) = 24$, $\varphi(u) = \infty$. \square

The proof of our next result is simple (given our work to this point), but the statement summarizes everything that we have already proved and will need in the rest of the paper. So we call it a theorem. Recall that $\mathcal{G}_{good} = \{C_{2s}, \theta_{2,2s,2t}, \theta_{1,2s+1,2t+1}, \theta_{2,2,2,2}\}$.

Theorem 8. *Every 2-connected graph G is not $(4,2)$ -choosable unless either (i) $G \in \mathcal{G}_{good}$ or (ii) G is formed from $K_{3,3} - e$ by repeatedly subdividing a single edge incident to a 2-vertex.*

Proof. Suppose G is 2-connected. If G is $(4,2)$ -choosable, then G is bipartite. By Lemma 4, either (i) $G \in \mathcal{G}_{good}$, (ii) G contains two cycles that intersect in at most one vertex, (iii) G contains a strong subdivision of a graph in \mathcal{G}_{bad} , or (iv) G is a strong subdivision of $K_{3,3} - e$. By Lemma 5, in (ii) G contains a strong minor of a graph in \mathcal{G}_{cycles} . So, by the Strong Minor Lemma and Lemma 6, in (ii) and (iii) G is not $(4,2)$ -choosable. By Lemma 7, in (iv) G is not $(4,2)$ -choosable unless it is formed from $K_{3,3} - e$ by repeatedly subdividing a single edge incident to a vertex of degree 2. \square

3 $|\mathcal{B}(G)| = 2$

In this section we consider the case where G has exactly two blocks that contain cycles, say B_1 and B_2 . For a cut-vertex v , let V_1, \dots, V_t denote the vertex sets of the components of $G - v$, and let $G_i = G[V_i \cup \{v\}]$ for each $i \in [t]$. (When $|\mathcal{B}(G)| = 2$, we will have $t = 2$.) A *lollipop* is formed from a cycle by identifying the end of a path (possibly of length 0) with one vertex of the cycle.

V_1, \dots, V_t
 G_i
 lollipop

For the sake of illustration, consider standard list-coloring (where each vertex must be colored with a single color). Suppose J is formed from two vertex-disjoint lollipops, say G_1 and G_2 , by identifying their 1-vertices, call them v_1 and v_2 . To show G is not 2-choosable, it suffices to construct list assignments L_1 and L_2 for the two lollipops, where each G_i is not L_i -colorable, $|L_i(v_i)| = 1$, and $|L_i(w)| = 2$ for each $w \in V(G_i) \setminus \{v_i\}$. To form L for G , we simply take the union of the two list assignments, except that if $L_1(v_1) = L_2(v_2)$, then we permute or rename colors in L_2 to avoid this. Clearly G has no L -coloring, since if we color v with color $\alpha \in L_1(v_1)$, then the coloring does not extend to G_1 and if we color with $\beta \in L_2(v_2)$, then the coloring does not extend to G_2 .

We now apply the same idea to show that graphs are not $(4,2)$ -choosable. The extra complication is that the possible colorings for a cut-vertex v are no longer independent of each

other. If two possible colorings of v share a color, then they will also do so after every possible permutation or renaming of colors. So if a list assignment forbids some of the $\binom{4}{2}$ ways to color a vertex, then we only care about the relations to each other of the colorings forbidden for v . For example, two distinct colorings either intersect in a common color or are disjoint. A set of three distinct colorings either (a) intersect in a common color, (b) pairwise intersect, but have no common intersection, or (c) include two colorings that are complements of each other, with respect to $L(v)$ (and a third coloring that intersects each). We capture this idea with the following definition.

Definition 1. A 4-assignment L for a graph H is k -forcing for a vertex v if every 2-fold L -coloring φ of H assigns v one of at most k subsets of $L(v)$. Trivially, every 4-assignment L is 6-forcing for each $v \in V(H)$, since $\binom{4}{2} = 6$. We will be interested in the case when $k \in \{2, 3, 4\}$. For clarity, we write (i) 2_{in} -forcing, (ii) 2_{comp} -forcing, (iii) 3_{in} -forcing, (iv) 3_{out} -forcing, and (v) 4_{out} -forcing (again, for a vertex v). This denotes that (i) the two options for $\varphi(v)$ have a common color, (ii) the two options for $\varphi(v)$ are complements of each other (with respect to $L(v)$), (iii) the three options for $\varphi(v)$ have a common color, (iv) the three options for $\varphi(v)$ exclude a common color, and (v) the two excluded options for $\varphi(v)$ have a common color.

k -forcing

We illustrate the point of this definition with an example. Suppose we have a graph G with $|\mathcal{B}(G)| = 2$, a cut-vertex v , and the resulting subgraphs G_1 and G_2 . To show that G is not (4,2)-choosable, it suffices to show that G_1 has a 3_{in} -forcing 4-assignment L_1 and G_2 has a 3_{out} -forcing 4-assignment L_2 . To see why, note that by renaming and permuting color classes, we can assume that $L_1(v) = L_2(v) = 1234$ and L_1 forces a coloring of v in $\{12, 13, 14\}$, but L_2 forces one in $\{23, 24, 34\}$. Thus, no coloring of v extends to both G_1 and G_2 . So G has no L -coloring. A similar idea works if L_1 is 4_{out} -forcing and L_2 is 2_{in} -forcing. (It is easy to construct a 4_{out} -forcing 4-assignment for every lollipop; see Lemma 10. If there exists v such that G_1 , G_2 , and G_3 each contain a lollipop, then G is not (4,2)-choosable: we use one lollipop to forbid 12 and 13 on v , another to forbid 23 and 24, and the third to forbid 14 and 34. Thus, the more challenging case when $|\mathcal{B}(G)| \geq 3$ is when the block tree is a path.)

The following proposition allows us to extend a k -forcing assignment along a path. We will use it to show that if e is a cut-edge of G , then G/e is (4,2)-choosable if and only if G is (4,2)-choosable.

Proposition 9. *Suppose that there exists $x \in V(H)$ with $d(x) = 1$ and w is the neighbor of x . If $H - x$ has a 4-assignment L' that is 4_{out} -forcing (resp. 2_{in} -forcing, 2_{comp} -forcing, 3_{in} -forcing, and 3_{out} -forcing) for w , then H has a 4-assignment L that is 4_{out} -forcing (resp. 2_{in} -forcing, 2_{comp} -forcing, 3_{out} -forcing, and 3_{in} -forcing) for x .*

Proof. Let L be given by $L(v) = L'(v)$ for all $v \in V(H) - x$ and $L(x) = L'(w)$. □

Note that in the first three cases L is the same type of forcing assignment for x as L' is for w . However, the types swap for 3_{out} -forcing and 3_{in} -forcing.

Lemma 10. *The 4-assignment 1234, 1234, 1235, 2345 for a 4-cycle is 4_{out} -forcing for the first two vertices. Further, if G consists of a 4-cycle with a path pendant at one vertex, then there exists a 4-assignment that is 4_{out} -forcing for each vertex of the path and also for the degree 3 vertex and one of its neighbors on the cycle.*

Proof. Denote the vertices of the cycle by v_1, v_2, v_3, v_4 , in order. Let L denote the given list assignment. It is easy to check that if $\varphi(v_1) \in \{24, 34\}$, then we cannot complete the coloring. Since $L(v_1) = L(v_2)$, this implies that if $\varphi(v_2) \in \{13, 12\}$, then we cannot complete the coloring. This proves the first statement. For the second statement, add a path pendant at v_1 . Now extend the 4-assignment L by letting $L(v) = 1234$ for each vertex on the path. Now the second statement follows by induction on the path length, using Proposition 9. □

It is enlightening to know that if G consists of an even cycle with a path pendant at one cycle vertex and $v \in V(G)$, then there is no 4-assignment that is 3-forcing for v . (This is an

easy consequence of the fact that if $\mathcal{B}(G) = \{C_{2s}, C_{2t}\}$, then G is $(4,2)$ -choosable, which was proved by Meng, Puleo, and Zhu.) However, we will not need this result until later, so we prove it as Corollary 15.

The following lemma is the main result of this section.

Lemma 11. *Let G be a graph with $\delta \geq 2$ and $|\mathcal{B}(G)| = 2$. If $\mathcal{B}(G) \neq \{C_{2s}, C_{2t}\}$ and $\mathcal{B}(G) \neq \{C_{2s}, \theta_{2,2,2}\}$, then G is not $(4,2)$ -choosable.*

Proof. We begin by proving a series of claims. The point of each is to construct a k -forcing assignment for a 2-connected graph (that is either in \mathcal{G}_{good} or is formed from $K_{3,3}$ by repeatedly subdividing a single edge incident to a 2-vertex). For a cut-vertex v and subgraphs G_1 and G_2 , our goal is to find list assignments L_1 for G_1 and L_2 for G_2 such that L_1 is a -forcing and L_2 is b -forcing and $a + b \leq 6$. Using the approach outlined after Definition 1, this allows us to show G is not $(4,2)$ -choosable. This approach succeeds unless $\mathcal{B}(G)$ is one of the two exceptions in the statement of theorem.

Claim 1. *If $H = \theta_{2,2,2}$ and $v, w \in V(H)$ with v and w non-adjacent, then H has a 4-assignment that is 3_{in} -forcing for v and also has a 4-assignment that is 3_{out} -forcing for v . In one of these assignments, at least one of the three allowable colorings of v forces a unique coloring of w .*

We will not need the second statement in the proof of the current lemma, but will use it later on, and it is convenient to prove now. The desired assignments are shown in Figures 13 and 14. By symmetry, we can assume that $v \in \{v_1, v_2\}$ (as shown in the figures), and thus $w \in \{w_1, w_2\}$ (as in Figure 14). First consider the labeling L in Figure 13. If $\varphi(v_1) \in \{12, 13, 23\}$, then colors 4, 5, 6 are used on its neighbors, so the final vertex has no coloring. Thus L is 3_{in} -forcing for v_1 . Since $L(v_1) = L(v_2)$, also L is 3_{out} -forcing for v_2 .

Now consider the assignment L in Figure 14. It is easy to check that this L forces $\varphi(v_1) \in \{13, 14, 34\}$. This, in turn, forces $\varphi(v_2) \in \{24, 23, 12\}$, since $L(v_1) = L(v_2)$. So L is 3_{out} -forcing for v_1 and 3_{in} -forcing for v_2 . Further, $\varphi(v_1) = 13$ if and only if $\varphi(v_2) = 24$, and if $\varphi(v_1) = 13$, then $\varphi(w_2) = 25$, and $\varphi(w_1) = 13$. This finishes the proof of the first statement, and also proves the second statement. \diamond

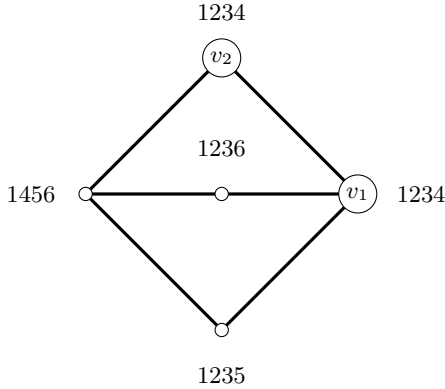

Figure 13: A 4-assignment that is 3_{in} -forcing for v_1 .

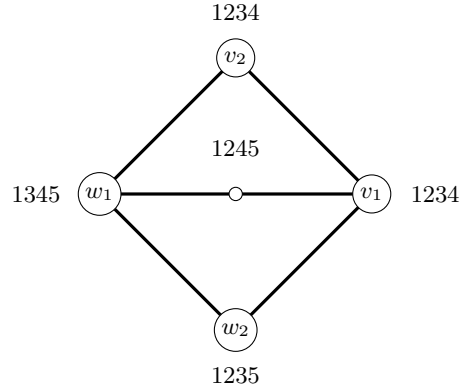

Figure 14: A 4-assignment that is 3_{out} -forcing for v_1 .

Claim 2. *If $H = K_{2,4}$ and $v \in V(H)$, then H has a 4-assignment L that is 2_{in} -forcing for v .*

Consider the 4-assignment L shown in Figure 15. By symmetry (between r and s and also between t, u, v , and w), it suffices to show that L is 2_{in} -forcing for r , since $L(w) = L(r)$. We show that L forces $\varphi(r) \in \{14, 24\}$. If $\varphi(r) \subseteq 123$, then u, v , and w use 6, 5, and 4, so we cannot extend the coloring to s . If $\varphi(r) = 34$, then w and t use 1, 5, and 6, so we again cannot color s . Thus, $\varphi(r) \in \{14, 24\}$, so L is 2_{in} -forcing for r , and also w , which proves Claim 2. \diamond

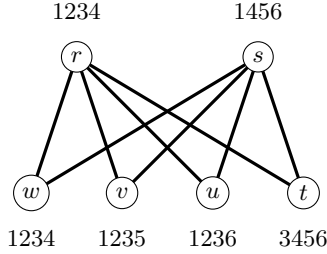

Figure 15: A 4-assignment that is 2_{in} -forcing for r .

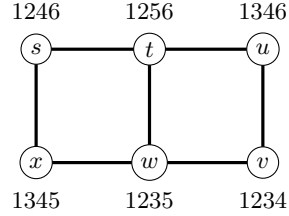

Figure 16: A 4-assignment that is 2_{in} -forcing for v .

Claim 3. *If $H = \theta_{1,3,3}$ and $v \in V(H)$, then H has a 4-assignment L that is 2_{in} -forcing for v .*

By symmetry, there are only two possibilities for v . First suppose $d(v) = 3$. Let w denote the other vertex such that $d(w) = 3$. By Lemma 10, give a 4-assignment L_1 to one 4-cycle in H such that $L_1(v) = L_1(w) = 1234$ and L_1 forces $\varphi(v) \notin \{12, 13\}$. Similarly, give a 4-assignment L_2 to the other 4-cycle such that $L_2(v) = L_2(w) = 1234$ and L_2 forces $\varphi(v) \notin \{14, 24\}$. Now $L_1 \cup L_2$ forces $\varphi(v) \in \{23, 34\}$, so is 2_{in} -forcing for v .

Assume instead that $d(v) = 2$. Let L be the 4-assignment in Figure 16. It is straightforward to check that L forces $\varphi(v) \in \{14, 24\}$, as follows. If $\varphi(v) = 12$: $\varphi(w) = 35$, $\varphi(x) = 14$, $\varphi(s) = 26$, $\varphi(t) = \infty$. If $\varphi(v) = 13$: $\varphi(w) = 25$, $\varphi(t) = 16$, $\varphi(u) = \infty$. If $\varphi(v) = 23$: $\varphi(w) = 15$, $\varphi(t) = 26$, $\varphi(s) = 14$, $\varphi(x) = \infty$. If $\varphi(v) = 34$: $\varphi(u) = 16$, $\varphi(t) = 25$, $\varphi(w) = \infty$. This proves Claim 3. \diamond

Claim 4. *If $H = \theta_{2,2,4}$ and $v \in V(H)$, then H has a 4-assignment L that is 2_{in} -forcing for v .*

Consider $\theta_{2,2,4}$, shown in Figures 17 and 18. For any given vertex in $V(\theta_{2,2,4})$, we must construct a 4-assignment L such that L is 2_{in} -forcing for that vertex. By symmetry, we assume this vertex is r , u , v , or w . Consider the list assignment L in Figure 17.

If $\varphi(w) = 12$: $\varphi(v) = 34$, $\varphi(u) = 15$, $\varphi(t) = 23$, $\varphi(s) = 14$, $\varphi(r) = \infty$. If $\varphi(w) = 15$: $\varphi(r) = 24$, $\varphi(s) = 13$, $\varphi(x) = \infty$. If $\varphi(w) = 25$: $\varphi(r) = 14$, $\varphi(s) = 23$, $\varphi(t) = 15$, $\varphi(u) = 34$, $\varphi(v) = \infty$. If $\varphi(w) = 45$: $\varphi(x) = 13$, $\varphi(s) = 24$, $\varphi(r) = \infty$. Thus, $\varphi(w) \in \{14, 24\}$. Since $\varphi(r) = \varphi(w)$, we get $\varphi(r) \in \{25, 15\}$. Also, $\varphi(v) \in \{23, 13\}$. So L is 2_{in} -forcing for r , v , and w .

Now consider the list assignment L in Figure 18. We show that it is 2_{in} -forcing for u (in fact we show that it is 1-forcing for u , but we will not need this). We begin by showing $\varphi(u) \notin \{35, 45, 46\}$, which is straightforward. If $\varphi(u) = 35$: $\varphi(t) = 14$, $\varphi(s) = 23$, $\varphi(x) = 15$, $\varphi(w) = 26$, $\varphi(v) = \infty$. If $\varphi(u) = 45$: $\varphi(v) = 26$, $\varphi(w) = 15$, $\varphi(x) = 23$, $\varphi(s) = 14$, $\varphi(t) = \infty$. If $\varphi(u) = 46$: $\varphi(v) = 25$, $\varphi(w) = 16$, $\varphi(r) = 24$, $\varphi(s) = 13$, $\varphi(t) = \infty$. Now we consider $\varphi(u) \in \{34, 56\}$. If $\varphi(u) = 34$, then $\varphi(t) = 15$, so $1 \notin \varphi(s)$. Also, $4 \notin \varphi(v)$, so $1 \in \varphi(w)$, since otherwise $\varphi(v) \cup \varphi(w) \subseteq 256$, a contradiction. Thus, $1 \notin \varphi(r)$ and $1 \notin \varphi(x)$. If $2 \in \varphi(s)$, then $\varphi(r) = 46$ and $\varphi(x) = 35$, so we cannot color s . Thus, $2 \notin \varphi(s)$, so $\varphi(s) = 34$. Now $\varphi(r) = 26$ and $\varphi(x) = 25$, so we cannot color w , a contradiction. If $\varphi(u) = 56$, then $\varphi(v) = 24$, so $2 \notin \varphi(w)$. Also, $5 \notin \varphi(t)$, so $2 \in \varphi(s)$, so $2 \notin \varphi(r)$ and $2 \notin \varphi(x)$. If $1 \in \varphi(w)$, then $\varphi(r) = 46$ and $\varphi(x) = 35$, so we cannot color w . Thus, $1 \notin \varphi(w)$, so $\varphi(w) = 56$. Now $\varphi(x) = 13$ and $\varphi(r) = 14$, so we cannot color s . This finishes the proof of Claim 4. \diamond

Suppose G is $(4, 2)$ -choosable. By Theorem 8, we assume each block in $\mathcal{B}(G)$ is either (i) C_{2s} , (ii) $\theta_{2,2s,2t}$, (iii) $\theta_{1,2s+1,2t+1}$, (iv) $\theta_{2,2,2,2}$ (that is, $K_{2,4}$) or (v) a strong subdivision of $K_{3,3} - e$. Since every instance of (v) contains as a subgraph an instance of (iii), we need not consider (v).

Suppose that one block, say B_1 , of G is $K_{2,4}$. By the Strong Minor Lemma, it suffices to consider the case that the other block, B_2 is an even cycle. Let B'_2 denote the subgraph of G consisting of B_2 and the path (possibly of length 0) from B_2 to B_1 . Let $\{v\} = V(B_1) \cap V(B'_2)$. By Lemma 10, subgraph B'_2 has a 4-assignment L_1 that is 4_{out} -forcing on v . By symmetry, assume

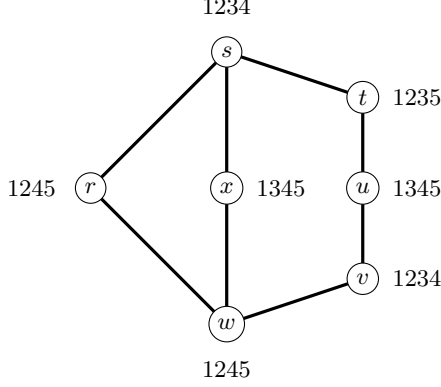

Figure 17: A 4-assignment that is 2_{in} -forcing for r , v , and w .

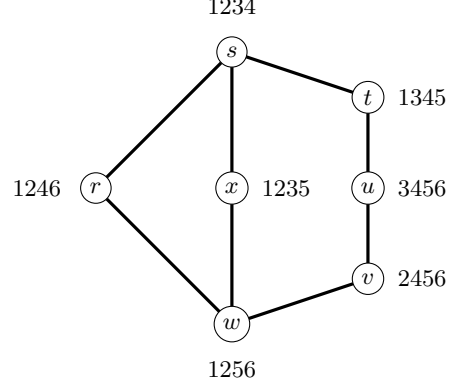

Figure 18: A 4-assignment that is 2_{in} -forcing for u .

that $L_1(v) = 1234$ and L_1 forces $\varphi(v) \notin \{12, 13\}$. By Claim 2, block B_1 has a 4-assignment L_2 that is 2_{in} -forcing on v . By permuting colors in L_2 , we can assume that $L_2(v) = 1234$ and L_2 forces $\varphi(v) \in \{12, 13\}$. Hence, $L_1 \cup L_2$ is a 4-assignment L for G such that G has no 2-fold L -coloring. Thus, G is not $(4,2)$ -choosable, a contradiction. So no block of G is $K_{2,4}$.

Suppose that one block, say B_1 , of G is $\theta_{1,2s+1,2t+1}$. It suffices to consider the case when $B_1 = \theta_{1,3,3}$. Let v be the cut-vertex of G in B_1 . By Claim 3, B_1 has a 4-assignment L_1 that is 2_{in} -forcing for v . By symmetry, assume that $L_1(v) = 1234$ and L_1 forces $\varphi(v) \in \{12, 13\}$. Let B_2 be the other block in $\mathcal{B}(G)$ and let B'_2 consist of B_2 and the path from B_2 to v . By Lemma 10, B'_2 has a 4-assignment L_2 that is 4_{out} -forcing for v . By permuting colors in L_2 , we can ensure that $L_2(v) = 1234$ and that L_2 forces $\varphi(v) \notin \{12, 13\}$. Let $L = L_1 \cup L_2$. Since G has no 2-fold L -coloring, we conclude that G is not $(4,2)$ -choosable, a contradiction. So no block of G is $\theta_{1,2s+1,2t+1}$.

Suppose that both blocks in $\mathcal{B}(G)$ are strong subdivisions of $\theta_{2,2,2}$, and let v be a cut-vertex in one block, say B_1 . By Claim 1, block B_1 has a 4-assignment L_1 that is 3_{in} -forcing for v , and such that $L_1(v) = 1234$. Further, by symmetry, we assume that L_1 forces $\varphi(v) \in \{12, 13, 14\}$. Let B_2 denote the other block in $\mathcal{B}(G)$, and let B'_2 consist of B_2 and the path from B_2 to v . By Claim 1 and Proposition 9, subgraph B'_2 has a 4-assignment L_2 such that $L_2(v) = 1234$ and L_2 is 3_{out} -forcing for v , requiring that $\varphi(v) \notin \{12, 13, 14\}$. Now $L_1 \cup L_2$ is a 4-assignment such that G has no 2-fold L -coloring. Thus, G is not $(4,2)$ -choosable, a contradiction.

Finally, suppose that $B_1 = C_{2s}$ and B_2 is a strong subdivision of $\theta_{2,2,4}$. By the Strong Minor Lemma, we assume that $B_2 = \theta_{2,2,4}$. Let v be the cut-vertex in B_2 , and let B'_1 consist of B_1 and the path from B_1 to v . By Lemma 10, subgraph B'_1 has a 4-assignment L_1 that is 4_{out} -forcing for v ; by symmetry we assume that $L_1(v) = 1234$ and L_1 forces $\varphi(v) \notin \{12, 13\}$. By Claim 4, block B_2 has a 4-assignment L_2 that is 2_{in} -forcing for v ; by symmetry we assume that $L_2(v) = 1234$ and that L_2 forces $\varphi(v) \in \{12, 13\}$. Let $L = L_1 \cup L_2$. Since G has no 2-fold L -coloring, we conclude that G is not $(4,2)$ -choosable, a contradiction.

Thus either $\mathcal{B}(G) = \{C_{2s}, C_{2t}\}$ or $\mathcal{B}(G) = \{C_{2s}, \theta_{2,2,2}\}$. \square

4 $|\mathcal{B}(G)| \geq 3$

Lemma 12. *Let G be $(4,2)$ -choosable with $\delta \geq 2$. Now $|\mathcal{B}(G)| \leq 3$. Further, if $|\mathcal{B}(G)| = 3$, then each block of G is a cycle, G has a path P that contains at least one edge in each block of $\mathcal{B}(G)$, the block of $\mathcal{B}(G)$ that appears second along P is C_4 , and the cut-vertices in this C_4 are non-adjacent (see Figure 19).*

Proof. By Lemma 11, we can assume that every block in $\mathcal{B}(G)$ is either an even cycle or $\theta_{2,2,2}$

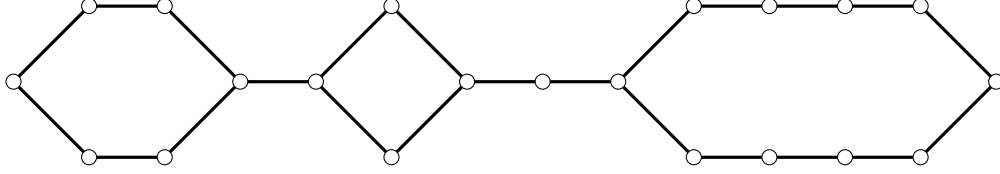

Figure 19: An example of the case allowable in Lemma 12.

(since otherwise G contains a subgraph that is not $(4,2)$ -choosable). Suppose some $v \in V(G)$ is in at least three distinct blocks of G . Let H'_1, H'_2, H'_3 be three components of $G - v$ and let H_i be the subgraph induced by $\{v\} \cup V(H'_i)$, for each i . Since $\delta \geq 2$, each H_i contains a cycle with an incident path (possibly length 0) ending at v . By Lemma 10 and Proposition 9, we give each H_i a 4-assignment L_i that is 4_{out} -forcing for v . By permuting colors in these assignments, we get that $L_i(v) = 1234$ for each i and that assignment L_1 forces $\varphi(v) \notin \{12, 13\}$, assignment L_2 forces $\varphi(v) \notin \{23, 24\}$, and assignment L_3 forces $\varphi(v) \notin \{14, 24\}$. Thus, G is not $(4,2)$ -choosable, a contradiction.

Now suppose that G contains a block B_0 with vertices v_1, v_2, v_3 and each v_i is in a block B_i distinct from B_0 . Let T be a tree in B_0 that contains v_1, v_2, v_3 and such that the only leaves of T are in the set $\{v_1, v_2, v_3\}$. Delete from B_0 all edges except those of T ; call the resulting graph G' . (Note that $\delta(G') \geq 2$.) If v_1, v_2, v_3 appear on a path in G' , then (by symmetry) v_2 appears second along the path, so v_2 is in at least three distinct blocks in G' . Now G' (and hence G) is not $(4,2)$ -choosable, as above. So assume instead that v_1, v_2, v_3 do not appear on a path in G' ; hence, there exists a vertex w such that v_1, v_2, v_3 are in distinct components of $G' - w$. Thus, w is in at least three distinct blocks in G' . So again, G' (and, thus, G) is not $(4,2)$ -choosable.

The previous two paragraphs show that each vertex of G is in at most two blocks and that for each block at most two of its vertices appear in two blocks. Thus, there exists a path P that contains an edge of every block in $\mathcal{B}(G)$.

Suppose that $|\mathcal{B}(G)| \geq 4$. By the Strong Minor Lemma, it suffices to consider the case when each block $B_i \in \mathcal{B}(G)$ is a 4-cycle; assume they appear in the order B_1, B_2, B_3, B_4 along P . First, suppose that B_2 (or B_3 , by symmetry) has cut-vertices that are adjacent; call these vertices v and w . Let B'_1 consist of B_1 and the path from B_1 to B_2 ; say v is the leaf in B'_1 . Similarly, let B'_3 denote B_3 and the path from B_3 to B_2 ; note that w is the leaf in B'_3 . By Lemma 10, we give B'_1 a 4-assignment that is 4_{out} -forcing for v ; by symmetry, assume that $L_1(v) = 1234$ and L_1 forces $\varphi(v) \notin \{12, 13\}$. Similarly, we give B_2 a 4-assignment L_2 with $L(v) = L(w) = 1234$; by permuting colors in L_2 , we can require that L_2 forces $\varphi(v) \notin \{14, 24\}$. Together L_1 and L_2 force $\varphi(v) \in \{23, 34\}$. Since $L_2(w) = L_2(v)$, also L_1 and L_2 force $\varphi(w) \in \{14, 12\}$. Now we give B'_3 a 4_{out} -forcing assignment L_3 with $L_3(w) = 1234$ and such that L_3 forces $\varphi(w) \notin \{12, 14\}$. Let $L = L_1 \cup L_2 \cup L_3$. Since G has no 2-fold L -coloring, we conclude that G is not $(4,2)$ -choosable, a contradiction.

Now assume that the cut-vertices in B_2 (resp. B_3) are non-adjacent; call them v_2 and w_2 (resp. v_3 and w_3). Define B'_1 and B'_3 as above, and define B'_4 analogously. By Lemma 10, we give a 4-assignment to $B'_1 \cup B_2$ that is 2_{comp} -forcing for v_2 . This uses an assignment L_1 for B'_1 that forces $\varphi(v_2) \notin \{24, 34\}$ and an assignment L_2 for B_2 that forces $\varphi(v_2) \notin \{12, 13\}$ (we also require $L_1(v_2) = L_2(v_2) = 1234$). So, $L_1 \cup L_2$ forces $\varphi(v_2) \in \{14, 23\}$. It is easy to check that this forces $\varphi(w_2) \in \{23, 45\}$. Thus, $L_1 \cup L_2$ is 2_{comp} -forcing for w_2 . Similarly, we construct an assignment for $B_3 \cup B'_4$ that is 2_{comp} -forcing for v_3 . By Proposition 9, we extend this to an assignment for $B'_3 \cup B'_4$ that is 2_{comp} -forcing for w_2 . By permuting colors in the lists $B'_3 \cup B'_4$, we can ensure that $B'_3(w_2) = 2345$ and that $B'_3 \cup B_4$ forces $\varphi(w_2) \notin \{23, 45\}$. Thus, G is not $(4,2)$ -choosable, a contradiction.

Now assume that $|\mathcal{B}(G)| = 3$ and that the second block along P , call it B_2 , is not C_4 . First suppose that B_2 is an even cycle of length at least 6. If the two cut-vertices in B_2 are an even distance apart, then G contains a strong minor of a graph in which a single vertex lies in three edge-disjoint cycles. As shown above, G is not $(4,2)$ -choosable. If the two cut-vertices in B_2 are

an odd distance apart, then G contains a strong minor of a graph G' with $\mathcal{B}(G') = \{C_4, C_4, C_4\}$, such that the middle C_4 has cut-vertices that are adjacent. Again, G is not $(4,2)$ -choosable, as shown above.

Now assume that $B_2 = \theta_{2,2,2}$. Let v and w denote the cut-vertices in B_2 . As shown above, we can assume v and w are non-adjacent (since every pair of vertices in $\theta_{2,2,2}$ lie on a 4-cycle). Define B'_1 and B'_3 as above. We give B_2 the 4-assignment L_2 shown in Figure 14. By Claim 1 of Lemma 11, assignment L_2 is 3_{out} -forcing for v_1 and 3_{in} -forcing for v_2 . First suppose that the cut-vertex v is v_1 in the figure, so w is w_1 . By Lemma 10, we give B'_1 a 4-assignment L_1 that forces $\varphi(v_1) \notin \{14, 34\}$. Similarly, we give B'_3 a 4-assignment L_3 that forces $\varphi(w_1) \neq 13$. Let $L = L_1 \cup L_2 \cup L_3$. Note that G has no 2-fold L -coloring, as follows. Assignment L_2 forces $\varphi(v_1) \in \{13, 14, 34\}$. However, L_1 forces $\varphi(v_1) \notin \{14, 34\}$. Thus, $\varphi(v_1) = 13$. By Claim 1, this implies that $\varphi(w_1) = 13$. But L_3 forces $\varphi(w_1) \neq 13$, a contradiction.

Now instead assume that the cut-vertex v is v_2 in Figure 14, so w is w_2 . Now, similar to the previous case, we give B'_1 a 4-assignment that forces $\varphi(v_2) \notin \{12, 23\}$. Since L_2 forces $\varphi(v_2) \in \{12, 23, 24\}$, note that $L_1 \cup L_2$ forces $\varphi(v_2) = 24$. By Claim 1, this forces $\varphi(w_2) = 25$. So we give B'_3 a 4-assignment that forces $\varphi(w_2) \neq 25$. Thus, G has no 2-fold $(L_1 \cup L_2 \cup L_3)$ -coloring, a contradiction. This concludes the case that $B_2 \neq C_4$.

Now suppose that B_1 (or B_3 , by symmetry) is not an even cycle. It suffices to consider the case when B_1 and B_2 are 4-cycles and $B_3 = \theta_{2,2,2}$. Define B'_1 and B'_3 as above. Again, let v and w be the cut-vertices in B_2 , and v be the leaf in B'_1 . Give B_2 a 4-assignment L_2 that forces $\varphi(v) \notin \{12, 13\}$. Similarly, give B'_1 a 4-assignment L_1 that forces $\varphi(v) \notin \{23, 24\}$. So $L_1 \cup L_2$ forces $\varphi(v) \in \{14, 34\}$. Let x denote the neighbor of v in B_2 with $L_2(x) = L_2(v)$. Now $\varphi(v) \in \{14, 34\}$ forces $\varphi(x) \in \{23, 12\}$. Thus $2 \notin \varphi(w)$. Hence, $L_1 \cup L_2$ is 3_{out} -forcing for w . Now the first statement in Claim 1 (together with Proposition 9), allow us to give B'_3 a 4-assignment L_3 that is 3_{in} -forcing for w . By permuting colors in L_3 , we can require that $L_3(w) = 2345$ and L_3 forces $2 \in \varphi(w)$. Thus, G has no 2-fold $(L_1 \cup L_2 \cup L_3)$ -coloring, which is a contradiction. This concludes the proof. \square

Theorem 13. *If a connected graph is $(4,2)$ -choosable, then either its core is one of the following six types (where s and t are positive integers): (i) K_1 , (ii) C_{2s} , (iii) $\theta_{2,2s,2t}$, (iv) $\theta_{1,2s+1,2t+1}$, (v) $K_{2,4}$, (vi) a graph formed from $K_{3,3} - e$ by subdividing a single edge incident to a vertex of degree 2 an even number of times, or else (vii) $\mathcal{B}(G) = \{C_{2s}, C_{2t}\}$, (viii) $\mathcal{B}(G) = \{\theta_{2,2,2}, C_{2s}\}$, or (ix) $\mathcal{B}(G) = \{C_4, C_{2s}, C_{2t}\}$, where the C_4 appears second on a path passing through all three blocks, and the two cut-vertices in C_4 are non-adjacent.*

Proof. The proof is simply collecting our results thus far. If we are not in (i), then the core of G has minimum degree at least 2. When G is $(4,2)$ -choosable and 2-connected, we are in (i-vi) by Theorem 8. When $|\mathcal{B}(G)| = 2$, we are in (vii) or (viii) by Lemma 11. When $|\mathcal{B}(G)| \geq 3$, we are in (ix) by Lemma 12. \square

Theorem 13 confirms one direction of the characterization conjectured by Meng, Puleo, and Zhu. If a graph is $(4,2)$ -choosable, then it is a graph they conjectured was $(4,2)$ -choosable. To complete the proof of their conjecture, we must show that each graph in (i)–(ix) of Theorem 13 is indeed $(4,2)$ -choosable. Case (i) is trivial, and Tuza and Voigt [9] handled (ii) and (v). Meng, Puleo, and Zhu [8] handled (iii), (iv), and (vii). So in the next section we must handle cases (vi), (viii), and (ix).

5 Graphs that are $(4,2)$ -choosable

In this section we complete the proof of Conjecture 1, by showing that every graph in cases (vi), (viii), and (ix) of Conjecture 1 (and Theorem 13) is indeed $(4,2)$ -choosable. We should mention now that in one case the proof is computer-aided. The main point of this section is to show that verifying $(4,2)$ -choosability for each graph in the four infinite families (case (viii) contains two of these families) can actually be reduced to verifying $(4,2)$ -choosability of four specific graphs,

three with 8 vertices and one with 10 vertices; these graphs are shown in Figure 20. For all of these graphs, Meng, Puleo, and Zhu already verified (4,2)-choosability by computer.

For the three of these graphs with cut-vertices we sketch how to check (4,2)-choosability by hand. For the fourth, it seem we really need computer case-checking. To sketch these proofs we need two ideas. The first was foreshadowed by our notion of k -forcing. We show that each 4-assignment for C_4 forbids at most two colorings of each vertex; likewise, each 4-assignment for $\Theta_{2,2,2}$ forbids at most three colorings of each vertex. Thus, for the two graphs on the left in Figure 20, each 4-assignment admits some coloring of the cut-vertex that extends to both blocks. A similar, but more subtle, argument works for the 10-vertex graph.

To prove the claims in the previous paragraph about 4-assignments for C_4 and $\Theta_{2,2,2}$, we introduce the notion of *flat* list assignments (see Definition 2). Intuitively, these are list assignments that are the most difficult to color from. More formally, we show that each 4-assignment L can be mapped to a flat 4-assignment L' such that the 2-fold L' -colorings map injectively into 2-fold L -colorings. The numbers of flat 4-assignments for every graph is finite (4 for C_4 , and 35 for $\Theta_{2,2,2}$), so we can prove the claims by simply examining each such 4-assignment.

For the 2-connected graph, as a double-check, Landon Rabern independently wrote a computer program to verify that it is (4,2)-choosable. The biggest theoretical insight in this process was showing that we only need to consider list assignments with at most 8 colors in total; we prove this in Lemma 19. Another important step was generating the list assignments to avoid isomorphic copies (one list assignment is formed from another by permuting the names of colors). Otherwise, his program was essentially brute force.

As we mentioned earlier, Meng, Puleo, and Zhu proved that a graph is (4,2)-choosable whenever it is formed from two vertex disjoint cycles by adding a path from a vertex on one cycle to a vertex on the other. We use a corollary of this fact, so we include their lemma next.

Lemma 14. *If G is a connected graph with $\mathcal{B}(G) = \{C_{2s}, C_{2t}\}$, then G is (4,2)-choosable.*

Corollary 15. *If G is a connected graph with $\mathcal{B}(G) = \{C_{2s}\}$, then for each vertex $v \in V(G)$, there does not exist a 4-assignment L that is 3-forcing for v .*

Proof. Suppose the corollary is false; let G , v , and L be a counterexample. Let C denote the cycle in G , and let G' be the subgraph of G consisting of C , v , and the path from v to C . By symmetry, we assume that $L(v) = 1234$ and that L forces either (i) $\varphi(v) \in \{12, 13, 23\}$, (ii) $\varphi(v) \in \{12, 13, 14\}$, or (iii) $\varphi(v) \in \{12, 23, 34\}$. In cases (i) and (ii), we proceed as follows. Form H from two copies of G' by adding an edge between the copies of v (with each vertex keeping its list from L). Now H has no 2-fold L -coloring, contradicting Lemma 14. In case (iii), form two copies of G' and L , but in one copy permute the colors in the lists as follows: $1 \rightarrow 3$, $2 \rightarrow 1$, $3 \rightarrow 4$, $4 \rightarrow 2$. Now form H from these two copies by identifying their copies of v . The original list assignment L forces $\varphi(v) \in \{12, 23, 34\}$, but the modified version of L forces $\varphi(v) \in \{13, 14, 24\}$. Thus, H has no coloring from this 4-assignment, again contradicting Lemma 14. \square

Lemma 16. *Let G be a graph with $\mathcal{B}(G) = \{\theta_{2,2,2}, C_{2s}\}$ or $\mathcal{B}(G) = \{C_4, C_{2s}, C_{2t}\}$ and let e be an edge of G not in any cycle. Form G' from G by contracting e . If G is not (4,2)-choosable, then neither is G' .*

Proof. We handle explicitly the case $\mathcal{B}(G) = \{\theta_{2,2,2}, C_{2s}\}$; the case $\mathcal{B}(G) = \{C_4, C_{2s}, C_{2t}\}$ is nearly identical, so we omit it. Let G , e , and G' be as in the statement of the lemma. Let v and w be the endpoints of e , with v closer to the $\theta_{2,2,2}$ and w closer to the C_{2s} . Without loss of generality, we can assume that $v \in V(\theta_{2,2,2})$. Let $B_1 = \theta_{2,2,2}$ and let B'_2 consist of C_{2s} and the path from it to v . Suppose G is not (4,2)-choosable and let L be a 4-assignment showing this. By Corollary 15, L restricted to B_1 must be 2-forcing for v (otherwise v has a coloring that extends to both B_1 and B'_2 , so G is 2-fold L -colorable). We show that if L restricted to B'_2 is 4_{comp} -forcing (resp. 4_{out} -forcing) for v , then it is also 4_{comp} -forcing (resp. 4_{out} -forcing) for w . Thus, by permuting colors on $B'_2 - v$ and identifying w with v in $\theta_{2,2,2}$, we get a 4-assignment L' for G' witnessing that G' is not (4,2)-choosable.

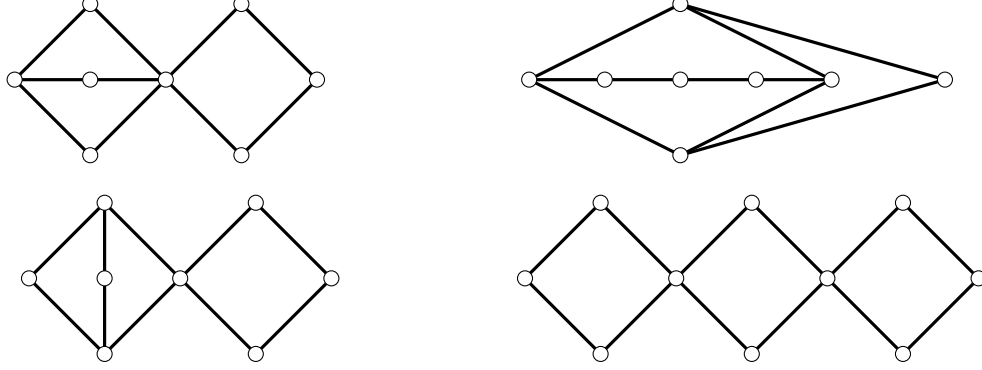

Figure 20: To check that the four infinite families of graphs in cases (vi), (viii), and (ix) of Conjecture 1 are (4,2)-choosable, it suffices to check that the four graphs shown above are (4,2)-choosable.

Suppose L is 4_{comp} -forcing for v . By symmetry, assume $L(v) = 1234$ and L restricted to B'_2 forces $\varphi(v) \notin \{12, 34\}$. Suppose $12 \not\subseteq L(w)$. Now $|L(w) \setminus 12| \geq 3$, so $\varphi(v) = 12$ can be extended to w in at least three ways. By Corollary 15, at least one of these three ways is not forbidden by L on $B'_2 - v$. Thus, L does not force $\varphi(v) \neq 12$, a contradiction. So $12 \subseteq L(w)$. Similarly, $34 \subseteq L(w)$. So $L(w) = 1234$. Since L forces $\varphi(v) \neq 12$, clearly L forces $\varphi(w) \neq 34$. Since L forces $\varphi(v) \neq 34$, also L forces $\varphi(w) \neq 12$. Thus, L forces $\varphi(w) \notin \{12, 34\}$. Hence, L is 4_{comp} -forcing on w , as desired. If instead L is 4_{out} -forcing for v , the proof that L is 4_{out} -forcing for w is very similar. By symmetry, we assume $L(v) = 1234$ and L forces $\varphi(v) \notin \{12, 13\}$. This implies $L(w) = 123\alpha$ and L forces $L(w) \notin \{2\alpha, 3\alpha\}$. By permuting colors on $B'_2 - v$, we get lists on G' such that their restriction to the contraction of B'_2 forces $\varphi(v) \notin \{12, 13\}$ or $\varphi(v) \notin \{12, 34\}$, just like the lists on B'_2 did. So if G is not (4,2)-choosable, then neither is G' . \square

We need one more lemma of Meng, Puleo, and Zhu (it is their Lemma 7.4).

Lemma 17. *Let G be a graph containing a path P on 5 vertices which all have degree 2 in G , and let G' be the graph obtained by deleting the middle vertex of P and merging its neighbors. The original graph G is $(4m, 2m)$ -choosable if and only if the merged graph G' is $(4m, 2m)$ -choosable.*

Lemma 18. *To verify Conjecture 1, it suffices to show that the four graphs in Figure 20 are (4,2)-choosable.*

Proof. By Theorem 13 and the final paragraph of Section 4, to prove the conjecture it suffices to show that all graphs in its cases (vi), (viii), and (ix) are (4,2)-choosable. By Lemma 17 we assume every block C_{2s} or C_{2t} is in fact C_4 , and that every path in case (vi) has length at most 4. By Lemma 16, we assume every edge of G is in a cycle. Finally, the instance of case (vi) where the path of unspecified even length has length 2 is a strong minor of the case where the path has length 4. Thus, we need only consider the latter, which is shown in Figure 20. \square

Next we show that for each graph G in Figure 20, if G is not (4,2)-choosable, then this is witnessed by some 4-assignment L such that $|\cup_{v \in V(G)} L(v)| \leq 8$. This observation was useful in restricting the list assignments that Rabern's program needed to consider. For a graph G , and list assignment L , let $pot(L)$ denote $|\cup_{v \in V(G)} L(v)|$. $pot(L)$

Lemma 19. *Let G be any graph in Figure 20. If G is not (4,2)-choosable, then this is witnessed by some 4-assignment L with $|pot(L)| \leq 8$.*

Proof. Suppose the lemma is false, and let G and L be a counterexample. So $|pot(L)| > 8$. Now $V(G)$ contains a subset $\{x_1, x_2\}$, call it X , such that $G - X$ consists of vertex disjoint paths, each with at most three vertices. Further, if a path P has exactly three vertices, then the interior

vertex of P has no neighbors outside of P . Pick $S \subseteq \text{pot}(L)$ such that $L(x_1) \cup L(x_2) \subseteq S$ and $|S| = 8$. We will find a 4-assignment L' such that $\text{pot}(L') \subseteq S$ and G has no 2-fold L' -coloring.

If any color $\alpha \in \text{pot}(L)$ has a component of G_α that is an isolated vertex v , and $v \notin X$, then replace α in $L(v)$ with a color in a list for some neighbor w of v . Repeat this step until no such α exists. (Eventually this happens, since at each step we decrease the sum of the numbers of components of G_α , taken over all $\alpha \in \text{pot}(L)$.) Now if there exists $\alpha \in \text{pot}(L) \setminus S$ such that G_α has a component C of size at most 2, then we replace α in $L(v)$, for each $v \in C$, with a color $\beta \in S \setminus \cup_{v \in C} L(v)$. (This is possible since $|\cup_{v \in C} L(v)| \leq 2(4) - 1 < |S|$.) Again, repeat this step until it is no longer possible. Finally, suppose there exists $\alpha \in \text{pot}(L) \setminus S$ such that G_α contains a component C (which is a path) on three vertices; let w denote the center vertex of this path. Because of the first sentence in this paragraph, each color in $L(w)$ appears in $L(v)$ for some neighbor v of w . Thus, $|\cup_{x \in C} L(x)| \leq 2(4) - 1 < |S|$. So we can again replace α with some color $\beta \in (S \setminus \cup_{x \in C} L(x))$. By repeating this process, we eventually reach a list assignment L' such that G has a 2-fold L' -coloring only if G has a 2-fold L -coloring; further $\text{pot}(L') \subseteq S$, so $|\text{pot}(L')| \leq 8$. \square

Proof of Main Theorem. In view of Lemma 18, it suffices to show that the four graphs in Figure 20 are (4,2)-choosable. For the three graphs with a cut-vertex, a proof is sketched in Theorem 22 below (and it was also shown by a computer program of Meng, Puleo, and Zhu). For the 2-connected graph, this was checked by a program written by Landon Rabern (and also the program of Meng, Puleo, and Zhu). This completes the proof. \square

Definition 2. For a list assignment L , and a color $\alpha \in \text{pot}(L)$, let G_α denote the subgraph of G induced by vertices with α in their list. Fix a graph G , a list assignment L for G , and $\alpha \in \text{pot}(L)$. Fix a component C of G_α and a color $\beta \in \text{pot}(L) \setminus \cup_{v \in V(C)} L(v)$. A *flattening move* for L consists of replacing α by β in $L(v)$ for each $v \in V(C)$. Let $\#(G)$ denote the number of components in G . A list assignment L is *flat* if, among all list assignments L' that can be formed from L by a sequence of flattening moves, L minimizes $|\text{pot}(L')|$ and, subject to that, minimizes $\sum_{\alpha \in \text{pot}(L')} \#(G_\alpha)$. When L is flat, we typically assume $\text{pot}(L) = \{1, \dots, |\text{pot}(L)|\}$. For a graph G , let $f_k(G, i)$ denote the number of flat k -assignments L for G with $|\text{pot}(L)| = i$ up to isomorphism (this includes renaming colors, as well as automorphisms of G). $f_k(G, i)$

Lemma 20. *Let L and L' be list assignments for G . If L' is formed from L by a sequence of flattening moves, then b -fold L' -colorings of G map injectively to b -fold L -colorings of G .*

Proof. Let G , L , and L' satisfy the hypotheses. Our proof is by induction on the number of flattening moves t in the sequence. The base case, $t = 0$, is trivial. Since a composition of injections is an injection, it suffices to consider the case when $t = 1$. Suppose that L' is formed from L by replacing α by β in $L(v)$ for each $v \in V(C)$, where C is some component of G_α . To map a b -fold L' coloring φ' to a b -fold L -coloring, for each $v \in V(C)$ with $\beta \in \varphi'(v)$, we replace β by α . Clearly this mapping is an injection, since $\alpha \notin \cup_{v \in V(C)} L'(v)$. Further, the image is a b -fold L -coloring, since neither α nor β is used on any neighbor of v in a b -fold L' -coloring. \square

Corollary 21. *To show that G is b -fold a -choosable, it suffices to show that G has a b -fold L -coloring for every flat a -assignment L .*

Theorem 22. *The three graphs in Figure 20 with a cut-vertex are each (4,2)-choosable.*

The proof is tedious, but straightforward given the seven claims below, so we omit many details and simply list the claims. Claims 5 and 9 are proved by case analysis, showing that for each 4-assignment other than those listed in the appendix, we can perform a flattening move. The proof of Claim 5 is fairly short, but that of Claim 9 is longer. The arguments rely heavily on the automorphisms of $\Theta_{2,2,2}$. To emphasize this, we use the notation $K_{2,3}$, rather than $\Theta_{2,2,2}$.

Claim 5. *Every flat 4-assignment L for C_4 has $|\text{pot}(L)| \leq 6$. Further, $f_4(C_4, 6) = 1$, $f_4(C_4, 5) = 2$, and $f_4(C_4, 4) = 1$.*

Claim 6. *Let $G = C_4$ and fix $v \in V(G)$. No 4-fold assignment for G is 3-forcing for v . Let L be a 4-assignment for C_4 . If L is 4-forcing for some vertex $v \in V(C_4)$, then the two colorings of v that L forbids share a common color.*

By Corollary 21, it suffices to prove each statement when L is flat. Claim 5 implies that we only need to check the four 4-assignments constructed in its proof. \diamond

Claim 7. *Let $G = C_4$, with vertices v_1, \dots, v_4 around the cycle. Fix a 4-assignment L ; in addition, forbid two colorings of v_1 that share a common color. Let S be the set of L -colorings of G that avoid the two forbidden colorings of v_1 . Either (i) colorings in S restrict to at least 3 distinct colorings of v_3 or (ii) colorings in S restrict to two colorings of v_3 that use disjoint color sets.*

By Corollary 21, it suffices to prove each statement when L is flat. Claim 5 implies that we only need to check the four 4-assignments L constructed in its proof; for each choice of L we have four choices for v_1 and twelve choices of pairs of colorings to forbid. \diamond

Claim 8. *The 10-vertex graph is $(4,2)$ -choosable.*

This follows directly from Claims 6 and 7. \diamond

Claim 9. *Every flat 4-assignment L for $K_{2,3}$ has $|\text{pot}(L)| \leq 7$. Further, $f_4(K_{2,3}, 7) = 1$, $f_4(K_{2,3}, 6) = 27$, $f_4(K_{2,3}, 5) = 6$, and $f_4(K_{2,3}, 4) = 1$.*

Claim 10. *Let $G = K_{2,3}$ and fix $v \in V(G)$. No 4-fold assignment for G is 2-forcing for v .*

By Corollary 21, it suffices to prove the statement when L is flat. Now Lemma 9 implies that it is enough to check the 35 4-assignments L constructed in its proof. \diamond

Claim 11. *If G is a graph formed from $K_{2,3}$ and C_4 by identifying one vertex of each, then G is $(4,2)$ -choosable.*

Let $G_1 = K_{2,3}$ and $G_2 = C_4$. Fix $v_1 \in V(G_1)$ and $v_2 \in V(G_2)$. Form G by identifying v_1 and v_2 ; denote the new vertex v . Fix a 4-assignment L for G . Let L_1 and L_2 denote the restrictions (respectively) of L to G_1 and G_2 . By Claim 10, list assignment L_1 forbids at most 3 colorings of v_1 . By Claim 6, list assignment L_2 forbids at most 2 colorings of v_2 . Thus, some coloring of v extends to both G_1 and G_2 , which shows that G has a 2-fold L -coloring. \diamond

6 $(2m, m)$ -choosability for general m

In the introduction we mentioned that for every integer m there exist bipartite graphs that are not $(2m, m)$ -choosable. Below we give a construction illustrating this.

Proposition 23. *Fix a positive integer m . There exists a bipartite graph that is not $(2m, m)$ -choosable.*

Proof. Let C be a 4-cycle with vertices v_1, v_2, v_3, v_4 . Let $L(v_1) = L(v_2) = \{1, \dots, 2m\}$. Let $L(v_4) = \{1, \dots, 2m - 2, 2m - 1, 2m + 1\}$, and let $L(v_3) = \{2, \dots, 2m + 1\}$. It is easy to check that C has no m -fold L -coloring φ with $\varphi(v_1) = \{1, \dots, m\}$. By permuting the color classes on v_2, v_3, v_4 , for any $S \subset \{1, \dots, 2m\}$ with $|S| = m$, we can construct a $2m$ -assignment L_S such that $L_S(v_1) = \{1, \dots, 2m\}$ but C has no m -fold L_S -coloring φ_S with $\varphi_S(v_1) = S$. We begin with $\binom{2m}{m}$ disjoint 4-cycles and for each m -element subset S of $\{1, \dots, 2m\}$ assign to some 4-cycle the list assignment L_S . To form G , we identify the copies of v_1 in all 4-cycles, with each vertex in the new graph inheriting its list assignment from its original 4-cycle; call this list assignment L^* , and note that L^* is a $2m$ -assignment. Clearly, the resulting graph G has no m -fold L^* -coloring. Thus, G is not $(2m, m)$ -choosable. \square

Many of the ideas we used to characterize $(4,2)$ -choosable graphs apply more generally. Tuza and Voigt [9] used Rubin's characterization of $(2,1)$ -choosable graphs to prove that they are $(2m, m)$ -choosable for every m . When m is odd, the characterization of $(2m, m)$ -choosable

graphs is simple: they are precisely the (2,1)-choosable graphs. To prove this, we need to show that every $(2m, m)$ -choosable graph is (2,1)-choosable. This result is generally attributed to Voigt [10], although her manuscript does not seem to have been published, and is not widely available. So, for completeness, we include a short argument of Gutner and Tarsi [5].

Lemma 24. *If m is odd and G is $(2m, m)$ -choosable, then G is (2,1)-choosable.*

Proof. Let G be $(2m, m)$ -choosable, for some odd m . Let L be a 2-assignment to G . We show that G is L -colorable. Suppose $L(v) = \{\alpha, \beta\}$. Let $L'(v) = \{\alpha_1, \dots, \alpha_m, \beta_1, \dots, \beta_m\}$. For each vertex $w \in V(G)$ construct $L'(w)$ from $L(w)$ analogously. Since L' is a $2m$ -assignment, by hypothesis G has an m -fold L' -coloring φ' . If $|\varphi'(v) \cap \{\alpha_1, \dots, \alpha_m\}| > \frac{m}{2}$, then let $\varphi(v) = \alpha$; otherwise, let $\varphi(v) = \beta$. Analogously, for each vertex $w \in V(G)$, let $\varphi(w)$ be the color in $L(w)$ that appears most often (with subscripts) in $\varphi'(w)$. Since φ' is proper, so is φ . (The key observation is that if $|\varphi'(v) \cap \{\alpha_1, \dots, \alpha_m\}| > \frac{m}{2}$ and $|\varphi'(w) \cap \{\alpha_1, \dots, \alpha_m\}| > \frac{m}{2}$, then $\varphi'(v) \cap \varphi'(w) \neq \emptyset$, so v and w are non-adjacent.) \square

We have not said much about algorithms thus far. So it is worth mentioning that if we fix m and also bound the number of vertices of degree at least 3 in an input graph G , then given a $2m$ -assignment L for G , we can test in linear time whether G has an m -fold L -coloring.

Theorem 25. *Fix positive integers m and C . Let G and L be given, where G is a graph with at most C vertices of degree at least 3 and L is a $2m$ -assignment. We can check in linear time whether G has an m -fold L -coloring.*

Proof. Let X be the set of vertices of degree at least 3 and $G' = G \setminus X$. Note that G' is a disjoint union of paths. For each path P , we compute the m -fold L -colorings of its endpoints that extend to an m -fold L -coloring of P , as follows.

Let $V(P) = \{v_1, \dots, v_k\}$. For each $i \geq 2$, we compute the m -fold L -colorings of v_1 and v_i that extend to $G[v_1, \dots, v_i]$. Having solved the problem for v_1 and v_{i-1} , we can solve it for v_1 and v_i in constant time. Thus, we can solve the problem for the endpoints of each path P in time linear in the length of P . Now we consider all at most $\binom{2m}{m}^C$ m -fold L -colorings of X and check which of these (if any) extend to all paths in G' . Since m and C are constants, so is $\binom{2m}{m}^C$. Hence, it suffices to check whether a single m -fold L -coloring φ of X extends to G'

Fix an m -fold L -coloring of X . Having preprocessed each path P in G' as above, we can check whether φ extends to P in constant time (searching through the constant-sized results of the preprocessing). Thus, we can check whether φ extends to G' in time linear in the number of paths in G' (which is at most linear in the order of G).

Finally, suppose G has an m -fold L -coloring and we want to construct the coloring. For each path P , for each m -fold L -coloring of v_1 and v_i that extends to $G[v_1, \dots, v_i]$ we store at v_i a pointer to one coloring of v_{i-1} such that these colorings of v_1, v_{i-1}, v_i extend to the path induced by v_1, \dots, v_i . Now, given any m -fold L -colorings of v_1 and v_k that extend to $G[v_1, \dots, v_k]$, it is straightforward to recursively construct such an extension. \square

Acknowledgments

This paper would not exist if not for Conjecture 1, posed by Meng, Puleo, and Zhu. At the author's request, they included their code for checking (4,2)-choosability as an auxiliary file for [7]. Also, most of the "bad" list assignments we use here already appear in their paper. Thanks to the National Security Agency for supporting this work, under NSA Grant H98230-16-0351. Thanks to Howard Community College for its hospitality during the preparation of this paper. Thanks to an anonymous referee for helpful feedback. Finally, thanks to Landon Rabern for his computer program to verify that the 2-connected graph in Figure 20 is (4,2)-choosable.

References

- [1] Noga Alon, Zsolt Tuza, and Margit Voigt. Choosability and fractional chromatic numbers. *Discrete Math.*, 165/166:31–38, 1997. Graphs and combinatorics (Marseille, 1995).
- [2] Daniel W. Cranston. A characterization of $(4,2)$ -choosable graphs. *Preprint, available at: <https://arxiv.org/abs/1708.05488v2>*, 2017.
- [3] Zdeněk Dvořák, Xiaolan Hu, and Jean-Sébastien Sereni. A 4-choosable graph that is not $(8:2)$ -choosable. *Preprint, available at: <https://arxiv.org/abs/1806.03880>*, 2018.
- [4] Paul Erdős, Arthur L. Rubin, and Herbert Taylor. Choosability in graphs. In *Proc. West Coast Conf. on Combinatorics, Graph Theory and Computing, Congressus Numerantium*, volume 26, pages 125–157, 1979.
- [5] Shai Gutner and Michael Tarsi. Some results on $(a:b)$ -choosability. *Discrete Math.*, 309(8):2260–2270, 2009.
- [6] Thomas Mahoney, Jixian Meng, and Xuding Zhu. Characterization of $(2m,m)$ -paintable graphs. *Electron. J. Combin.*, 22(2):Research Paper 2.14, 14, 2015.
- [7] Jixian Meng, Gregory J. Puleo, and Xuding Zhu. On $(4,2)$ -choosable graphs. *Preprint, available at: <https://arxiv.org/abs/1404.6821>*, 2014.
- [8] Jixian Meng, Gregory J. Puleo, and Xuding Zhu. On $(4,2)$ -choosable graphs. *J. Graph Theory*, 85(2):412–428, 2017.
- [9] Zsolt Tuza and Margit Voigt. Every 2-choosable graph is $(2m,m)$ -choosable. *J. Graph Theory*, 22(3):245–252, 1996.
- [10] Margit Voigt. On list colourings and choosability of graphs. 1998.
- [11] Hassler Whitney. Congruent Graphs and the Connectivity of Graphs. *Amer. J. Math.*, 54(1):150–168, 1932.
- [12] Xuding Zhu. On-line list colouring of graphs. *Electron. J. Combin.*, 16(1):Research Paper 127, 16, 2009.

Appendix: Flat 4-assignments for $K_{2,3}$ and C_4

We denote $V(K_{2,3})$ by $\{x_1, x_2, x_3, y_1, y_2\}$, where $d(x_i) = 2$ and $d(y_j) = 3$. We denote $V(C_4)$ by $\{v_1, v_2, v_3, v_4\}$ in order around the cycle. The double lines in each table demark 4-assignments with different pot sizes, and the single lines demark different multisets of sizes of $|V(G_\alpha)|$, over all $\alpha \in \text{pot}(L)$.

$L(x_1)$	$L(x_2)$	$L(x_3)$	$L(y_1)$	$L(y_2)$	$L(x_1)$	$L(x_2)$	$L(x_3)$	$L(y_1)$	$L(y_2)$	$L(v_1)$	$L(v_2)$	$L(v_3)$	$L(v_4)$
1234	2356	4567	1567	2347	1234	2456	3456	2356	1456	1256	1345	3456	2346
3456	1256	1234	1256	3456	1245	2456	3456	2356	1346	1235	1245	1345	2345
1356	2456	1234	1256	3456	1456	2456	3456	2356	1234	1245	1345	2345	2345
3456	1235	1246	1256	3456	1245	3456	2356	2456	1346	1234	1234	1234	1234
3456	1235	1246	1356	2456	1456	3456	2356	2456	1234				
2456	3456	1236	1235	1456	1245	3456	3456	2456	1236				
2456	2356	1346	1235	1456	1245	2456	3456	3456	1236				
1456	2356	2346	1235	1456	1234	2456	3456	3456	1256				
1256	3456	2346	1235	1456	1234	3456	3456	2356	1456				
1256	3456	3456	1256	1234	1356	2456	3456	3456	1234				
1356	2456	3456	1256	1234	1234	1235	1245	1345	2345				
1256	3456	3456	1235	1246	1235	2345	2345	1245	1345				
1356	2456	3456	1235	1246	1235	1245	2345	1345	2345				
1236	1246	3456	1256	3456	1245	2345	2345	1345	2345				
1236	1246	3456	1356	2456	1345	1345	2345	1245	2345				
1236	2456	3456	2356	1456	1245	1345	2345	1345	2345				
1256	2356	3456	2456	1346	1234	1234	1234	1234	1234				
1456	2456	3456	3456	1236									

Table 1: The 35 flat 4-assignments for $K_{2,3}$ and 4 flat 4-assignments for C_4 .