

AN EXPLICIT TWO STEP QUANTIZATION OF POISSON STRUCTURES AND LIE BIALGEBRAS

SERGEI MERKULOV AND THOMAS WILLWACHER

ABSTRACT. We develop a new approach to deformation quantizations of Lie bialgebras and Poisson structures which goes in two steps.

In the first step one associates to any Poisson (resp. Lie bialgebra) structure a so called *quantizable* Poisson (resp. Lie bialgebra) structure. We show explicit transcendental formulae for this correspondence.

In the second step one deformation quantizes a *quantizable* Poisson (resp. Lie bialgebra) structure. We show again explicit transcendental formulae for this second step correspondence (as a byproduct we obtain configuration space models for biassociahedron and bipermutohedron).

In the Poisson case the first step is the most non-trivial one and requires a choice of an associator while the second step quantization is essentially unique, it is independent of a choice of an associator and can be done by a trivial induction. We conjecture that similar statements hold true in the case of Lie bialgebras.

The main new result is a surprisingly simple explicit universal formula (which uses only smooth differential forms) for universal quantizations of finite-dimensional Lie bialgebras.

CONTENTS

1. Introduction	2
1.1. Two classical deformation quantization problems	2
1.2. Deformation quantization of Poisson structures	2
1.3. Deformation quantization of Lie bialgebras	4
1.4. Structure of the paper	5
1.5. Some notation	5
2. Graph complexes and configuration spaces	5
2.1. Directed graph complexes	5
2.2. Oriented graph complexes	7
2.3. On a class of representations of graph complexes	7
2.4. Configuration space model for the operad \mathcal{Holie}_d	9
2.5. Configuration space model for the operad $\mathcal{Mor}(\mathcal{Holie}_d)$	10
3. Transcendental formulae for a class of \mathcal{Holie}_d morphisms	12
3.1. De Rham theories on operads of manifolds with corners	12
3.2. De Rham \mathcal{G} -theories from propagators	13
3.3. Transcendental formula for a class of \mathcal{Holie}_d morphisms	17
3.4. An example	18
3.5. Remark	20
4. A new explicit formula for universal quantizations of Poisson structures	20
4.1. The Kontsevich formula for a formality map	20
4.2. A new explicit formula for the formality map	21
5. Props governing associative bialgebras, Lie bialgebras and the formality maps	22
5.1. Prop of associative bialgebras and its minimal resolution.	22
5.2. Prop governing Lie bialgebras and its minimal resolution	23
5.3. Formality maps as morphisms of props	24
5.4. Polydifferential functor	25
5.5. Properad of quantizable Lie bialgebras	27
5.6. Open problems	30
6. An explicit formula for universal quantizations of Lie bialgebras	30

6.1.	Kontsevich compactified configuration spaces	30
6.2.	Configuration spaces of points in $\mathbb{R} \times \mathbb{R}$	31
6.3.	Configuration space $C_{A;I,J}(\mathcal{H})$ and its compactification	31
6.4.	A class of differential forms on $\overline{C}_{A;I,J}(\mathcal{H})$	32
6.5.	An explicit formula for quantization of Lie bialgebras	36
6.6.	An open problem	42
Appendix A. Some vanishing Lemmas		
A.1.	Lemma on binary vertices	43
A.2.	Vanishing Lemma	44
A.3.	Vanishing Lemma	44
A.4.	Vanishing Lemma	45
A.5.	Proposition	46
A.6.	Lemma	46
Appendix B. Configuration space models for bipermutahedra and biassociahedra		
A.1.	Associahedron, permutahedron and configuration spaces	46
A.2.	Bipermutahedron	50
A.3.	Biassociahedron	51
A.4.	Example: $m + n = 4$	52
A.5.	Example: $m + n = 5$	53
A.6.	From biassociahedra to strongly homotopy bialgebras	55
	References	56

1. Introduction

1.1. Two classical deformation quantization problems. There are two famous deformation quantization problems, one deals with quantization of Poisson structures on finite dimensional manifolds and another with quantization of Lie bialgebras.

A lot is known by now about the first deformation quantization problem: we have an explicit formula for a universal deformation quantization [Ko3], we also know that all homotopy inequivalent universal deformation quantizations are classified by the set of Drinfeld associators and that, therefore, the Grothendieck-Teichmüller group acts on such quantizations.

Also much is known about the second quantization problem. Thanks to Etingof and Kazhdan in [EK] it is proven that, for any choice of a Drinfeld associator, there exists a universal quantization of an arbitrary Lie bialgebra. Later Tamarkin gave a second proof of the Etingof-Kazhdan deformation quantization theorem in [T2], and very recently Severa found a third proof [Se]. The theorem follows furthermore from the more general results of [GY]. All these proofs give us existence theorems for deformation quantization maps, but show no hint on how such a quantization might look like explicitly to any order in \hbar .

In this paper we show a new transcendental explicit formula for universal quantization of finite-dimensional Lie bialgebras. This work is based on the study of compactified configuration spaces in \mathbb{R}^3 which was motivated by (but not identical to) an earlier work of Boris Shoikhet [Sh1]; it gives in particular a new proof of the Etingof-Kazhdan existence theorem. The methods used in the construction of that formula work well also in two dimensions, and give us new explicit formulae for a universal quantization of Poisson structures. Let us explain main ideas of the paper first in this very popular case.

1.2. Deformation quantization of Poisson structures. Let $C^\infty(\mathbb{R}^d)$ be the commutative algebra of smooth functions in \mathbb{R}^n . A *star product* in $C^\infty(\mathbb{R}^n)$ is an associative product,

$$\begin{aligned}
 *_\hbar : C^\infty(\mathbb{R}^n) \times C^\infty(\mathbb{R}^n) &\longrightarrow C^\infty(\mathbb{R}^n) \\
 (f(x), g(x)) &\longrightarrow f *_\hbar g = fg + \sum_{k \geq 1} \hbar^k B_k(f, g)
 \end{aligned}$$

where all operators B_k are bi-differential. One can check that the associativity condition for $*_{\hbar}$ implies that $\pi(f, g) := B_1(f, g) - B_1(g, f)$ is a Poisson structure in \mathbb{R}^n ; then $*_{\hbar}$ is called a *deformation quantization* of $\pi \in \mathcal{T}_{poly}(\mathbb{R}^n)$.

The *deformation quantization problem* addresses the question: given a Poisson structure in \mathbb{R}^n , does there exist a star product $*_{\hbar}$ in $C^\infty(\mathbb{R}^n)$ which is its deformation quantization?

This problem was solved by Maxim Kontsevich [Ko3] by giving an explicit direct map between the two sets

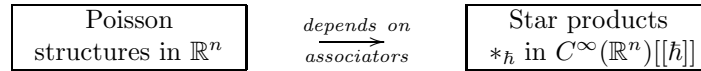

In fact, a stronger correspondence was proven — the formality theorem. Later Dmitry Tamarkin proved [T1] an existence theorem for deformation quantizations which exhibited a non-trivial role of Drinfeld’s associators.

In this paper we consider an intermediate object — a *quantizable* Poisson structure — so that the quantization process splits in two steps as follows

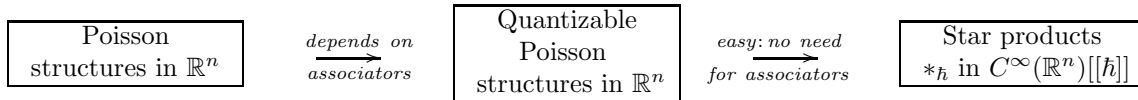

If an ordinary Poisson structure is a Maurer-Cartan element $\pi \in \mathcal{T}_{poly}(\mathbb{R}^n)$ of the classical Schouten bracket $[\cdot, \cdot]_S$,

$$[\pi, \pi]_S = 0,$$

a quantizable Poisson structure π^\diamond is a bivector field in $\mathcal{T}_{poly}(\mathbb{R}^n)[[\hbar]]$ which is Maurer-Cartan element,

$$(1) \quad \frac{1}{2}[\pi^\diamond, \pi^\diamond]_S + \frac{\hbar}{4!}[\pi^\diamond, \pi^\diamond, \pi^\diamond, \pi^\diamond]_4 + \frac{\hbar^2}{6!}[\pi^\diamond, \pi^\diamond, \pi^\diamond, \pi^\diamond, \pi^\diamond, \pi^\diamond]_6 + \dots = 0,$$

a certain $\mathcal{L}ie_\infty$ structure in $\mathcal{T}_{poly}(\mathbb{R}^n)$,

$$\{[\cdot, \dots, \cdot]_{2k} : \mathcal{T}_{poly}(\mathbb{R}^n)^{\otimes 2k} \rightarrow \mathcal{T}_{poly}(\mathbb{R}^n)[3 - 4k]\}_{k \geq 1}$$

which we call a *Kontsevich-Shoikhet $\mathcal{L}ie_\infty$ structure* as it was introduced by Boris Shoikhet in [Sh2] with a reference to an important contribution by Maxim Kontsevich via an informal communication. As the Schouten bracket, this $\mathcal{L}ie_\infty$ structure makes sense in infinite dimensions. It was proven in [W3] that the Kontsevich-Shoikhet structure is *the unique* non-trivial deformation of the standard Schouten bracket in $\mathcal{T}_{poly}(\mathbb{R}^n)$ in the class of universal $\mathcal{L}ie_\infty$ structures which makes sense in *any* (including infinite) dimension (it is a folklore conjecture that in finite dimensions the Schouten bracket $[\cdot, \cdot]$ is rigid, i.e. admits no universal homotopy non-trivial deformations).

A map

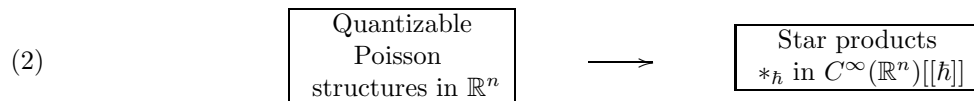

was constructed in [Sh2] for any n (including the case $n = +\infty$) with the help of the hyperbolic geometry and transcendental formulae. It was shown in [W3, B] that this universal map (which comes in fact from a $\mathcal{L}ie_\infty$ morphism) is essentially unique and can, in fact, be constructed by a trivial (in the sense that no choice of an associator is needed) induction.

What is new in our paper is the following Theorem proven in Section 4 below.

1.2.1. Theorem. *For any finite n and any choice of an associator, there is 1-1 correspondence between the two sets,*

$$\boxed{\begin{array}{c} \text{Poisson} \\ \text{structures in } \mathbb{R}^n \end{array}} \leftrightarrow \boxed{\begin{array}{c} \text{Quantizable} \\ \text{Poisson} \\ \text{structures in } \mathbb{R}^n \end{array}}$$

More precisely, there is a $\mathcal{L}ie_\infty$ isomorphism,

$$F : (\mathcal{T}_{poly}(\mathbb{R}^n), [\ , \]_S) \longrightarrow (\mathcal{T}_{poly}(\mathbb{R}^n)[[\hbar]], \{[\ , \ , \dots, \]_{2n}\}_{n \geq 1})$$

from the Schouten algebra to the Kontsevich-Shoikhet one.

We show explicit transcendental formulae for the $\mathcal{L}ie_\infty$ morphism F in (39). Composing this morphism with the essentially unique arrow in (2) we obtain an acclaimed new explicit formula for universal quantization of Poisson structures. In fact we obtain a family of such formulae parameterized by smooth functions on $S^1 := \{(x, y) \in \mathbb{R}^2 | x^2 + y^2 = 1\}$ with compact support in the upper ($y > 0$) half-circle; all the associated maps F are homotopy equivalent to each other.

1.3. Deformation quantization of Lie bialgebras. Let V be a \mathbb{Z} -graded real vector space, and let $\mathcal{O}_V := \odot^\bullet V = \bigoplus_{n \geq 0} \odot^n V$ be the space of polynomial functions on V^* equipped with the standard graded commutative and cocommutative bialgebra structure. If $\mathcal{A}ss\mathcal{B}$ stands for the prop of bialgebras, then the standard product and coproduct in \mathcal{O}_V give us a representation,

$$(3) \quad \rho_0 : \mathcal{A}ss\mathcal{B} \longrightarrow \mathcal{E}nd_{\mathcal{O}_V}.$$

A *formal deformation* of the standard bialgebra structure in \mathcal{O}_V is a continuous morphism of props,

$$\rho_\hbar : \mathcal{A}ss\mathcal{B}[[\hbar]] \longrightarrow \mathcal{E}nd_{\mathcal{O}_V}[[\hbar]],$$

\hbar being a formal parameter, such that $\rho_\hbar|_{\hbar=0} = \rho_0$. It is well-known [Dr] that if ρ_\hbar is a formal deformation of ρ_0 , then $\frac{d\rho_\hbar}{d\hbar}|_{\hbar=0}$ makes the vector space V into a Lie bialgebra, that is, induces a representation,

$$\nu : \mathcal{L}ie\mathcal{B} \longrightarrow \mathcal{E}nd_V$$

of the prop of Lie bialgebras $\mathcal{L}ie\mathcal{B}$ in V . Thus Lie bialgebra structures, ν , in V control infinitesimal formal deformations of ρ_0 . Drinfeld formulated a deformation quantization problem: given ν in V , does ρ_\hbar exist such that $\frac{d\rho_\hbar}{d\hbar}|_{\hbar=0}$ induces ν ? This problem was solved affirmatively in [EK, T1, Se]. In this paper we give a new proof of the Etingof-Kazhdan theorem which shows such an explicit formula in the form $\sum_\Gamma c_\Gamma \Phi_\Gamma$, where the sum runs over a certain family of graphs, Φ_Γ is a certain operator uniquely determined by each graph Γ and c_Γ is an absolutely convergent integral, $\int_{\mathcal{C}_{\bullet, \bullet}(\Gamma)} \Omega_\Gamma$, of a smooth differential form Ω_Γ over a certain configuration space of points in a 3-dimensional subspace, \mathcal{H} , of the Cartesian product, $\overline{\mathbb{H}} \times \overline{\mathbb{H}}$, of two copies of the closed upper-half plane. Our construction goes in two steps,

$$\boxed{\begin{array}{c} \text{Lie bialgebra} \\ \text{structures in } \mathbb{R}^n \end{array}} \longrightarrow \boxed{\begin{array}{c} \text{Quantizable} \\ \text{Lie bialgebra} \\ \text{structures in } \mathbb{R}^n \end{array}} \longrightarrow \boxed{\begin{array}{c} \text{Bialgebra structures} \\ (*_\hbar, \Delta_\hbar) \text{ in } \odot^\bullet(\mathbb{R}^n)[[\hbar]] \end{array}}$$

as in the case of quantization of Poisson structures. We show in §5 an explicit universal formula for the first arrow (behind which lies a $\mathcal{L}ie_\infty$ morphism in the full analogy to the Poisson case), and then in §6 an explicit universal formula for the second arrow. The composition of the two gives us an explicit formula for a universal quantization of an arbitrary finite-dimensional Lie bialgebra, one of the main results of our paper. This result raises, however, open questions on the classification theory of both maps above, and on the graph cohomology description of a quantizable Lie bialgebra structure; here the situation is much less clear than in the Poisson case discussed above.

We remark that an explicit configuration space integral formula (based on a propagator which is a generalized function rather than a smooth differential form) for the quantization of finite dimensional Lie bialgebras was claimed in B. Shoikhet's preprint [Sh1]. Furthermore, an odd analog of the properad governing quantizable Lie bialgebras has been investigated in [KMW].

1.4. Structure of the paper. §2 is a self-consistent reminder on graph complexes and configuration space models for the 1-coloured operad \mathcal{Holie}_d of (degree shifted) strongly homotopy Lie algebras, and for the 2-coloured operad $\mathcal{Mor}(\mathcal{Holie}_d)$ of their morphisms.

In §3 we obtain explicit universal formulae for \mathcal{Lie}_∞ morphisms relating Poisson (resp., Lie bialgebra) structures with their *quantizable* counterparts.

§4 shows a new explicit two-step formula for universal quantization of Poisson structures (depending only on a choice of a smooth function on the circle S^1 with support in the upper half of S^1), and proves classification claims (made in §1.2) about every step in that construction.

§5 reminds key facts about the minimal resolutions, \mathcal{Assb}_∞ and $\mathcal{Lieb}_\infty^{\min}$, of the prop \mathcal{Assb} of associative bialgebras and, respectively, of the prop \mathcal{Lieb} of Lie bialgebras, and introduces a prop $\widehat{\mathcal{Lieb}}_\infty^{\text{quant}}$ of strongly homotopy *quantizable* Lie bialgebras. We use results of §3 to give an explicit transcendental morphism of dg props $\widehat{\mathcal{Lieb}}_\infty^{\text{quant}} \rightarrow \widehat{\mathcal{Lieb}}_\infty^{\min, \circ}$, where $\widehat{\mathcal{Lieb}}_\infty^{\min, \circ}$ is the wheeled closure of the completed version of the dg prop $\widehat{\mathcal{Lieb}}_\infty^{\min}$, and hence an explicit morphism $\widehat{\mathcal{Lieb}}_\infty^{\text{quant}} \rightarrow \widehat{\mathcal{Lieb}}_\infty^{\circ}$ from the prop of quantizable Lie bialgebras into the wheeled closure of the completed prop of ordinary Lie bialgebras.

In §6 we show an explicit transcendental formula for a morphism of props $\mathcal{Assb} \rightarrow \mathcal{D}(\widehat{\mathcal{Lieb}}_\infty^{\text{quant}})$, where \mathcal{D} is the polydifferential endofunctor on props introduced in [MW2], and show that it lifts by induction to a morphism of dg props $\mathcal{Assb}_\infty \rightarrow \mathcal{D}(\widehat{\mathcal{Lieb}}_\infty^{\text{quant}})$. This gives us explicit formulae for a universal quantization of quantizable Lie bialgebras. Combining this formula with the explicit formula from §5, we obtain finally an explicit transcendental formula for a universal quantization of ordinary finite-dimensional Lie bialgebras.

In Appendix A we prove a number of Lemmas on vanishing of some classes of integrals involved into our formula for quantization of Lie bialgebras.

In Appendix B we construct surprisingly simple configuration space models for the bipermutahedron and biassociahedron posets introduced by Martin Markl in [Ma2] following an earlier work by Samson Sanedidze and Ron Umble [SU1].

1.5. Some notation. The set $\{1, 2, \dots, n\}$ is abbreviated to $[n]$; its group of automorphisms is denoted by \mathbb{S}_n ; the trivial one-dimensional representation of \mathbb{S}_n is denoted by $\mathbb{1}_n$, while its one dimensional sign representation is denoted by sgn_n . The cardinality of a finite set A is denoted by $\#A$. For a graph Γ its set of vertices (resp., edges) is denoted by $V(\Gamma)$ (resp., $E(\Gamma)$).

We work throughout in the category of \mathbb{Z} -graded vector spaces over a field \mathbb{K} of characteristic zero. If $V = \bigoplus_{i \in \mathbb{Z}} V^i$ is a graded vector space, then $V[k]$ stands for the graded vector space with $V[k]^i := V^{i+k}$ and s^k for the associated isomorphism $V \rightarrow V[k]$; for $v \in V^i$ we set $|v| := i$. For a pair of graded vector spaces V_1 and V_2 , the symbol $\text{Hom}_i(V_1, V_2)$ stands for the space of homogeneous linear maps of degree i , and $\text{Hom}(V_1, V_2) := \bigoplus_{i \in \mathbb{Z}} \text{Hom}_i(V_1, V_2)$; for example, $s^k \in \text{Hom}_{-k}(V, V[k])$.

For a prop(erad) \mathcal{P} we denote by $\mathcal{P}\{k\}$ a prop(erad) which is uniquely defined by the following property: for any graded vector space V a representation of $\mathcal{P}\{k\}$ in V is identical to a representation of \mathcal{P} in $V[k]$. The degree shifted operad of Lie algebras $\mathcal{Lie}\{d\}$ is denoted by \mathcal{Lie}_{d+1} while its minimal resolution by \mathcal{Holie}_{d+1} ; representations of \mathcal{Lie}_{d+1} are vector spaces equipped with Lie brackets of degree $-d$.

For a right (resp., left) module V over a group G we denote by V_G (resp. ${}^G V$) the \mathbb{K} -vector space of coinvariants: $V/\{g(v) - v \mid v \in V, g \in G\}$ and by V^G (resp. ${}^G V$) the subspace of invariants: $\{v \in V \mid g(v) = v, v \in V\}$. If G is finite, then these spaces are canonically isomorphic as $\text{char}(\mathbb{K}) = 0$.

2. Graph complexes and configuration spaces

2.1. Directed graph complexes. Let $\mathcal{G}_{k,l}$ be a set of directed graphs Γ with k vertices and l edges such that some bijections $V(\Gamma) \rightarrow [k]$ and $E(\Gamma) \rightarrow [l]$ are fixed, i.e. every edge and every vertex of Γ has a numerical label. There is a natural right action of the group $\mathbb{S}_k \times \mathbb{S}_l$ on the set $\mathcal{G}_{k,l}$ with \mathbb{S}_k acting by

relabeling the vertices and \mathbb{S}_l by relabeling the edges. For each fixed integer d , consider a collection of \mathbb{S}_k -modules $\mathcal{D}Gra_d = \{\mathcal{D}Gra_d(k)\}_{k \geq 1}$, where

$$\mathcal{D}Gra_d(k) := \prod_{l \geq 0} \mathbb{K}\langle \mathcal{G}_{k,l} \rangle \otimes_{\mathbb{S}_l} \text{sgn}_l^{\otimes |d-1|} [l(d-1)].$$

It has an operad structure with the composition rule,

$$\begin{aligned} \circ_i : \mathcal{D}Gra_d(p) \times \mathcal{D}Gra_d(q) &\longrightarrow \mathcal{D}Gra_d(p+q-1), \quad \forall i \in [n] \\ (\Gamma_1, \Gamma_2) &\longrightarrow \Gamma_1 \circ_i \Gamma_2, \end{aligned}$$

given by substituting the graph Γ_2 into the i -labeled vertex v_i of Γ_1 and taking the sum over re-attachments of dangling edges (attached before to v_i) to vertices of Γ_2 in all possible ways.

For any operad $\mathcal{P} = \{\mathcal{P}(k)\}_{k \geq 1}$ in the category of graded vector spaces, the linear map

$$\begin{aligned} [,] : \mathcal{P} \otimes \mathcal{P} &\longrightarrow \mathcal{P} \\ (a \in \mathcal{P}(p), b \in \mathcal{P}(q)) &\longrightarrow [a, b] := \sum_{i=1}^p a \circ_i b - (-1)^{|a||b|} \sum_{i=1}^q b \circ_i a \in \mathcal{P}(p+q-1) \end{aligned}$$

makes a graded vector space $\mathcal{P} := \prod_{k \geq 1} \mathcal{P}(k)$ into a Lie algebra [KM]; moreover, these brackets induce a Lie algebra structure on the subspace of invariants $\mathcal{P}^{\mathbb{S}} := \prod_{n \geq 1} \mathcal{P}(k)^{\mathbb{S}_k}$. In particular, the graded vector space

$$\text{dfGC}_d := \prod_{k \geq 1} \text{Gra}_d(k)^{\mathbb{S}_k} [d(1-k)]$$

is a Lie algebra with respect to the above Lie brackets, and as such it can be identified with the deformation complex $\text{Def}(\mathcal{L}ie_d \xrightarrow{0} \text{Gra}_d)$ of the zero morphism. Hence non-trivial Maurer-Cartan elements of $(\text{dfGC}_d, [,])$ give us non-trivial morphisms of operads

$$(4) \quad i : \mathcal{L}ie_d \longrightarrow \mathcal{D}Gra_d.$$

One such non-trivial morphism f is given explicitly on the generator of $\mathcal{L}ie_d$ by [W1]

$$(5) \quad i \left(\begin{array}{c} \text{!} \\ \diagup \quad \diagdown \\ 1 \quad 2 \end{array} \right) = \begin{array}{c} \text{!} \longrightarrow \text{!} \\ \text{!} \longrightarrow \text{!} \end{array} + (-1)^d \begin{array}{c} \text{!} \longrightarrow \text{!} \\ \text{!} \longrightarrow \text{!} \end{array} =: \bullet \longrightarrow \bullet$$

Note that elements of dfGC_d can be identified with graphs from $\mathcal{D}Gra_d$ whose vertices' labels are symmetrized (for d even) or skew-symmetrized (for d odd) so that in pictures we can forget about labels of vertices and denote them by unlabelled black bullets as in the formula above. Note also that graphs from dfGC_d come equipped with an orientation, or , which is a choice of ordering of edges (for d even) or a choice of ordering of vertices (for d odd) up to an even permutation in both cases. Thus every graph $\Gamma \in \text{dfGC}_d$ has at most two different orientations, or and or^{opp} , and one has the standard relation, $(\Gamma, or) = -(\Gamma, or^{opp})$; as usual, the data (Γ, or) is abbreviated by Γ (with some choice of orientation implicitly assumed). Note that the homological degree of graph Γ from dfGC_d is given by $|\Gamma| = d(\#V(\Gamma) - 1) + (1-d)\#E(\Gamma)$.

The above morphism (5) makes $(\text{dfGC}_d, [,])$ into a *differential* Lie algebra with the differential

$$\delta := [\bullet \longrightarrow \bullet,] .$$

This dg Lie algebra contains a dg subalgebra dGC_d spanned by connected graphs with at least bivalent vertices. It was proven in [W1] that

$$H^\bullet(\text{dfGC}_d) = \odot^{\bullet \geq 1} (\text{dGC}_d[-d]) [d]$$

so that there is no loss of generality of working with dGC_d instead of dfGC_d . Moreover, one has an isomorphism of Lie algebras [W1],

$$H^0(\text{dGC}_d) = \mathfrak{gtr}_1,$$

where \mathfrak{gtr}_1 is the Lie algebra of the Grothendieck-Teichmüller group GRT_1 introduced by Drinfeld in the context of deformation quantization of Lie bialgebras. Nowadays, this group play an important role in many areas of mathematics.

2.2. Oriented graph complexes. A graph Γ from the set $\mathcal{G}_{k,l}$ is called *oriented* if it contains no *wheels*, that is, directed paths of edges forming a closed circle; the subset of $\mathcal{G}_{k,l}$ spanned by oriented graphs is denoted by $\mathcal{G}_{k,l}^{or}$. It is clear that the subspace $\mathcal{G}ra_d^{or} \subset \mathcal{D}\mathcal{G}ra_d$ spanned by oriented graphs is a suboperad. The morphism (5) factors through the inclusion $\mathcal{G}ra_d^{or} \subset \mathcal{D}\mathcal{G}ra_d$ so that one can consider a graph complex

$$\mathfrak{fGC}_d^{or} := \text{Def} \left(\mathcal{L}ie_d \xrightarrow{i} \mathcal{G}ra_d^{or} \right)$$

and its subcomplex \mathfrak{GC}_d^{or} spanned by connected graphs with at least bivalent vertices and with no bivalent vertices of the form $\bullet \rightarrow \bullet$. This subcomplex determines the cohomology of the full graph complex, $H^\bullet(\mathfrak{fGC}_d^{or}) = \odot^{\bullet \geq 1}(H^\bullet(\mathfrak{GC}_d^{or})[-d])[d]$. It was proven in [W3] that

$$H^\bullet(\mathfrak{GC}_{d+1}^{or}) = H^\bullet(\mathfrak{dGC}_d).$$

In particular, one has a remarkable isomorphism of Lie algebras, $H^0(\mathfrak{GC}_3^{or}) = \mathfrak{grt}$. It was also proven in [W3] that the cohomology group $H^1(\mathfrak{GC}_2^{or}) = H^1(\mathfrak{dGC}_1)$ is one-dimensional and is spanned by the following graph

$$\Upsilon_4 := \lambda \begin{array}{c} \bullet \\ \swarrow \quad \searrow \\ \bullet \quad \bullet \\ \swarrow \quad \searrow \\ \bullet \end{array} + 2\lambda \begin{array}{c} \bullet \\ \swarrow \quad \searrow \\ \bullet \quad \bullet \\ \swarrow \quad \searrow \\ \bullet \end{array} + \lambda \begin{array}{c} \bullet \\ \swarrow \quad \searrow \\ \bullet \quad \bullet \\ \swarrow \quad \searrow \\ \bullet \end{array} \quad \forall \lambda \in \mathbb{R} \setminus \{0\}.$$

Moreover $H^2(\mathfrak{GC}_2^{or}) = \mathbb{K}$ and is spanned by a graph with four vertices. This means that one can construct by induction a new Maurer-Cartan element in the Lie algebra \mathfrak{GC}_2^{or} (the integer subscript in the summand Υ_n stands for the number of vertices of graphs)

$$(6) \quad \Upsilon_{KS} = \bullet \rightarrow \bullet + \Upsilon_4 + \Upsilon_6 + \Upsilon_8 + \dots$$

as all obstructions have more than 7 vertices and hence do not hit the unique cohomology class in $H^2(\mathfrak{GC}_2^{or})$. Up to gauge equivalence, this new Maurer-Cartan element Υ is the *only* non-trivial deformation of the standard Maurer-Cartan element $\bullet \rightarrow \bullet$. We call this element *Kontsevich-Shoikhet* one as it was first found by Boris Shoikhet in [Sh2] with a reference to an important contribution by Maxim Kontsevich via an informal communication.

2.3. On a class of representations of graph complexes. Consider a formal power series algebra

$$\mathcal{O}_n := \mathbb{K}[[x^1, \dots, x^n]]$$

in n formal homogeneous variables and let $\text{Der}(\mathcal{O}_n)$ be the Lie algebra of continuous derivations of \mathcal{O}_n . Then, for any integer $d \geq 2$, the completed vector space

$$\mathbb{A}_d^{(n)} := \widehat{\odot}^\bullet(\text{Der}(\mathcal{O}_n)[d-1])$$

is canonically a d -algebra, that is, a graded commutative algebra equipped with compatible Lie brackets $[\ , \]_S$ of degree $1-d$ (here $\widehat{\odot}^\bullet$ stands for the completed graded symmetric tensor algebra functor). One can identify $\mathbb{A}_d^{(n)}$ with the ring of formal power series,

$$\mathbb{A}_d^{(n)} := \mathbb{K}[[x^1, \dots, x^n, \psi_1, \dots, \psi_n]]$$

generated by formal variables satisfying the condition

$$|x^i| + |\psi_i| = d-1, \quad d \in \mathbb{Z},$$

Then Lie bracket (of degree $1-d$) is given explicitly by

$$(7) \quad [f_1, f_2]_S = \sum_{i=1}^n \frac{f_1 \overleftarrow{\partial}}{\partial \psi_i} \frac{\overrightarrow{\partial} f_2}{\partial x^i} + (-1)^{|f_1||f_2|+(d-1)(|f_1|+|f_2|)} \frac{f_2 \overleftarrow{\partial}}{\partial \psi_i} \frac{\overrightarrow{\partial} f_1}{\partial x^i}$$

A degree d element $\gamma \in \mathbb{A}_d^{(n)}$ is called *Maurer-Cartan* if it satisfies the condition $[\gamma, \gamma]_S = 0$.

We are interested in an $n \rightarrow \infty$ version of $\mathbb{A}_d^{(n)}$ which retains the above canonical d -algebra structure. Clearly, the sequence of canonical projections of graded vector spaces,

$$\dots \longrightarrow \mathbb{A}_d^{(n+2)} \longrightarrow \mathbb{A}_d^{(n)} \longrightarrow \mathbb{A}_d^{(n-1)}$$

does not respect the above Lie bracket, so that the associated inverse limit $\lim_{\leftarrow} \mathbb{A}_d^{(n)}$ can not be a d -algebra. There is a chain of injections of formal power series algebras,

$$\dots \longrightarrow \mathcal{O}_n \longrightarrow \mathcal{O}_{n+1} \longrightarrow \mathcal{O}_{n+2} \longrightarrow \dots$$

and we denote the associated *direct* limit by

$$\mathcal{O}_\infty := \lim_{n \rightarrow \infty} \mathcal{O}_n.$$

Let V_∞ stand for the infinite-dimensional graded vector space with the infinite basis $\{x_1, x_2, \dots\}$ and set

$$\mathbb{A}_d^\infty := \prod_{m \geq 0} \text{Hom}(\odot^m(V_\infty[1-d]), \mathcal{O}_\infty)$$

This is a vector subspace of the inverse limit

$$\lim_{\leftarrow} \mathbb{A}_d^{(n)} = \mathbb{K}[[x^1, x^2, \dots, \psi_1, \psi_2, \dots]]$$

spanned by formal power series in two infinite sets of graded commutative generators $X = \{x^1, x^2, \dots\}$ and $\Psi = \{\psi_1, \psi_2, \dots\}$ with the property that every monomial in generators from the set Ψ has as a coefficient a formal power series from the ring \mathcal{O}_k for some finite number k . Clearly, the subspace \mathbb{A}_d^∞ is a well-defined d -algebra.

The first interesting for application case has $d = 2$, $|x^i| = 0$ and $|\psi_i| = 1$. The associated 2-algebra $\mathbb{A}_2^{(n)}$ can be identified with the Gerstenhaber algebra $\mathcal{T}_{poly}(\mathbb{R}^n)$ of formal polyvector fields on \mathbb{R}^n so that its Maurer-Cartan are formal power series Poisson structures on \mathbb{R}^n . Its $n \rightarrow \infty$ version \mathbb{A}_2^∞ gives us the Gerstenhaber algebra of polyvector fields on the infinite-dimensional space \mathbb{R}^∞ .

The second interesting example has $d = 3$ and $|x^i| = |\psi_i| = 1$. In this case Maurer-Cartan elements of $\mathbb{A}_3^{(n)}$ satisfying the conditions $\gamma|_{x^i=0} = 0$ and $\gamma|_{\psi_i=0} = 0$, $\forall i \in [n]$, are cubic polynomials

$$\gamma := \sum_{i,j,k \in I} \left(C_{ij}^k \psi_k x^i x^j + \Phi_k^{ij} x^k \psi_i \psi_j \right),$$

and the equation $[\gamma, \gamma] = 0$ implies that the associated to the structure constants Φ_k^{ij} and, respectively, C_{ij}^k linear maps,

$$\Delta : \mathbb{R}^n \rightarrow \wedge^2 \mathbb{R}^n, \quad [,] : \wedge^2 \mathbb{R}^n \rightarrow \mathbb{R}^n$$

define a Lie bialgebra structure in \mathbb{R}^n .

The above Lie brackets $[,]_S$ give us a representation

$$\mathcal{L}ie_d \longrightarrow \mathcal{E}nd_{\mathbb{A}_d^{(n)}}$$

for any $n \geq 1$. In fact, this representation factors through morphism (4) and a canonical representation Φ

$$(8) \quad \begin{array}{ccc} \Phi : & d\mathcal{G}ra_d & \longrightarrow & \mathcal{E}nd_{\mathbb{A}_d^{(n)}} \\ & \Gamma & \longrightarrow & \Phi_\Gamma \end{array}$$

of the operad $d\mathcal{G}ra_d$ in $\mathbb{A}_d^{(n)}$ defined, for any $\Gamma \in d\mathcal{G}ra_d(k)$, by a linear map

$$(9) \quad \Phi_\Gamma : \quad \begin{array}{ccc} \otimes^k \mathbb{A}_d^{(n)} & \longrightarrow & \mathbb{A}_d^{(n)} \\ (f_1, f_2, \dots, f_k) & \longrightarrow & \rho_\Gamma(f_1, f_2, \dots, f_k) \end{array}$$

where

$$\Phi_\Gamma(f_1, \dots, f_k) := m \left(\prod_{e \in E(\Gamma)} \Delta_e(f_1(x, \psi) \otimes f_2(x, \psi) \otimes \dots \otimes f_k(x, \psi)) \right)$$

and, for a directed edge e connecting vertices labeled by integers i and j ,

$$\Delta_e := \sum_{a=1}^n \frac{\partial}{\partial x_{(i)}^a} \otimes \frac{\partial}{\partial \psi_{a(j)}}$$

with the subscript (i) or (j) indicating that the derivative operator is to be applied to the i -th or j -th factor in the tensor product. The symbol m denotes the multiplication map,

$$m : \begin{array}{ccc} \otimes^k \mathbb{A}_d^{(n)} & \longrightarrow & \mathbb{A}_d^{(n)} \\ f_1 \otimes f_2 \otimes \dots \otimes f_k & \longrightarrow & f_1 f_2 \dots f_k. \end{array}$$

The morphism of dg operads (8) induces a morphism of the dg Lie algebras

$$s : \text{dfGC}_d := \text{Def} \left(\mathcal{L}ie_d \xrightarrow{i} d\mathcal{G}ra_d \right) \longrightarrow CE^\bullet \left(\mathbb{A}_d^{(n)}, \mathbb{A}_d^{(n)} \right) := \text{Def} \left(\mathcal{L}ie_d \xrightarrow{\Phi \circ i} \mathcal{E}nd_{\mathbb{A}_d^{(n)}} \right).$$

Here

$$CE^\bullet \left(\mathbb{A}_d^{(n)}, \mathbb{A}_d^{(n)} \right) = \text{Coder} \left(\odot^{\bullet \geq 1}(\mathbb{A}_d^{(n)}[d]) \right)$$

is the standard Chevalley-Eilenberg deformation complex of the Lie algebra $\mathbb{A}_d^{(n)}$, that is, the dg Lie algebra of coderivations of the graded co-commutative coalgebra $\odot^{\bullet \geq 1}(\mathbb{A}_d^{(n)}[d])$. Therefore any Maurer-Cartan element γ in the graph complex dfGC_d gives a Maurer-Cartan element $s(\gamma)$ in $\text{Coder}(\odot^{\bullet \geq 1}(\mathbb{A}_d^{(n)}[d]))$, that is a $\mathcal{H}olie_d$ algebra structure in \mathbb{A}_d^∞ , for any *finite* number n . Moreover, if γ belongs to the Lie subalgebra fGC_d^{or} , then the associated $\mathcal{H}olie_d$ structure remains well-defined in the limit $n \rightarrow +\infty$, i.e. it is well-defined in \mathbb{A}_d^∞ .

2.3.1. Example. The Maurer-Cartan element $\bullet \rightarrow \bullet \in \text{fGC}_d^{\text{or}} \subset \text{fGC}_d$ (see (8)) gives rise to the standard Lie brackets (7) in $\mathbb{A}_d^{(n)}$.

2.3.2. Example. The Maurer-Cartan element $\Upsilon_{KS} \in \text{fGC}_2^{\text{or}}$ from (6) gives rise to a *Kontsevich-Shoikhet* $\mathcal{L}ie_\infty$ structure in $\mathbb{A}_2^{(n)} = \mathcal{T}_{\text{poly}}(\mathbb{R}^n)$,

$$\left\{ [\dots,]_{2k} : (\mathbb{A}_2^{(n)})^{\otimes 2k} \rightarrow \mathbb{A}_2^{(n)}[3-4k] \right\}_{k \geq 1}$$

where

$$[\dots,]_{2k} := \Phi_{\Upsilon_{2k}}.$$

It was introduced by Boris Shoikhet in [Sh2] with a reference to an important contribution by Maxim Kontsevich via a private communication. This $\mathcal{L}ie_\infty$ structure is well defined in the limit $n \rightarrow +\infty$.

We shall consider in the next section some transcendental constructions of Maurer-Cartan elements in fGC_d and fGC_d^{or} in which we shall use heavily the following configuration space models of classical operads.

2.4. Configuration space model for the operad $\mathcal{H}olie_d$. Let

$$\text{Conf}_k(\mathbb{R}^d) := \{p_1, \dots, p_k \in \mathbb{R}^d \mid p_i \neq p_j \text{ for } i \neq j\}$$

be the configuration space of k pairwise distinct points in \mathbb{R}^d , $d \geq 2$. The group $\mathbb{R}^+ \times \mathbb{R}^d$ acts freely on each configuration space $\text{Conf}_k(\mathbb{R}^d)$ for $k \geq 2$,

$$(p_1, \dots, p_k) \longrightarrow (\lambda p_1 + a, \dots, \lambda p_k + a), \quad \forall \lambda \in \mathbb{R}^+, a \in \mathbb{R}^d,$$

so that the space of orbits,

$$C_k(\mathbb{R}^d) := \text{Conf}_k(\mathbb{C}) / \mathbb{R}^+ \times \mathbb{R}^d,$$

a smooth real $(kd - d - 1)$ -dimensional manifold. The space $C_2(\mathbb{R}^d)$ is homeomorphic to the sphere S^{d-1} and hence is compact.

For ≥ 3 the compactified configuration space $\overline{C}_k(\mathbb{R}^d)$ is defined as the closure of an embedding [Ko3, G]

$$\begin{array}{ccc} C_k(\mathbb{R}^d) & \longrightarrow & (S^{d-1})^{k(k-1)} \times (\mathbb{R}\mathbb{P}^2)^{k(k-1)(k-2)} \\ (p_1, \dots, p_k) & \longrightarrow & \prod_{i \neq j} \frac{p_i - p_j}{|p_i - p_j|} \times \prod_{i \neq j \neq l \neq i} [|p_i - p_j| : |p_j - p_l| : |p_i - p_l|] \end{array}$$

The space $\overline{C}_k(\mathbb{C})$ is a smooth (naturally oriented) manifold with corners. Its codimension 1 strata is given by

$$\partial \overline{C}_k(\mathbb{C}) = \bigsqcup_{\substack{A \subset [k] \\ \#A \geq 2}} C_{k-\#A+1}(\mathbb{C}) \times C_{\#A}(\mathbb{C})$$

where the summation runs over all possible proper subsets of $[k]$ with cardinality ≥ 2 . Geometrically, each such stratum corresponds to the A -labeled elements of the set $\{p_1, \dots, p_k\}$ moving very close to each other. If we represent $\overline{\mathcal{C}}_k(\mathbb{R}^d)$ by the (skew)symmetric k -corolla of degree¹ $k + 1 - kd$

$$(10) \quad \begin{array}{c} | \\ \diagup \quad \diagdown \\ 1 \quad 2 \quad 3 \quad \dots \quad k-1 \quad k \end{array} = (-1)^{d|\sigma|} \begin{array}{c} | \\ \diagup \quad \diagdown \\ \sigma(1) \quad \sigma(2) \quad \dots \quad \sigma(k) \end{array}, \quad \forall \sigma \in \mathbb{S}_k, \quad k \geq 2$$

then the boundary operator in the associated face complex of $\overline{\mathcal{C}}_\bullet(\mathbb{R}^d)$ takes a familiar form

$$(11) \quad \partial \begin{array}{c} | \\ \diagup \quad \diagdown \\ 1 \quad 2 \quad 3 \quad \dots \quad k-1 \quad k \end{array} = \sum_{\substack{A \subsetneq [k] \\ \#A \geq 2}} \pm \begin{array}{c} | \\ \diagup \quad \diagdown \\ \dots \quad \dots \\ A \quad [k] \setminus A \end{array}$$

implying the following

2.4.1. Proposition [GJ]. *The fundamental chain complex of the family of compactified configurations spaces, $\{\overline{\mathcal{C}}_k(\mathbb{R}^d)\}_{k \geq 2}$, has the structure of a dg free non-unital operad canonically isomorphic to the operad \mathcal{Holie}_d of degree shifted strongly homotopy Lie algebras.*

2.5. Configuration space model for the operad $\mathcal{M}or(\mathcal{Holie}_d)$. Let $\mathcal{M}or(\mathcal{Holie}_d)$ be a two-coloured operad whose representations in a pair of dg vector spaces V_{in} and V_{out} is a triple (μ_{in}, μ_{out}, F) consisting of \mathcal{Holie}_d structures μ_{in} on V_{in} and μ_{out} on V_{out} , and of a \mathcal{Holie}_d morphism, $F : (V_{in}, \mu_{in}) \rightarrow (V_{out}, \mu_{out})$, between them. There is a configuration space model [Me2] for this operad which plays one of central roles in this paper.

The Abelian group \mathbb{R}^d acts freely,

$$\begin{array}{ccc} Conf_k(\mathbb{C}) \times \mathbb{R}^d & \longrightarrow & Conf_A(\mathbb{C}) \\ (p = \{p_i\}_{i \in [k]}, a) & \longrightarrow & p + a := \{p_i + a\}_{i \in [k]} \end{array}$$

on the configuration space $Conf_k(\mathbb{R}^d)$ for any $k \geq 1$ so that the quotient

$$\mathfrak{C}_A(\mathbb{R}^d) := Conf_A(\mathbb{R}^d) / \mathbb{R}^d$$

is a $k(d-1)$ -dimensional manifold. There is a diffeomorphism,

$$\begin{array}{ccc} \Psi_k : \mathfrak{C}_k(\mathbb{R}^d) & \longrightarrow & C_k(\mathbb{R}^d) \times (0, 1) \\ p & \longrightarrow & \frac{p - p_c}{|p - p_c|} \times \frac{|p - p_c|}{1 + |p - p_c|} \end{array}$$

where

$$p_c := \frac{1}{k}(p_1 + \dots + p_k).$$

Note that the configuration $\frac{p - p_c}{|p - p_c|}$ is invariant under the larger group $\mathbb{R}^+ \rtimes \mathbb{R}^d$ and hence belongs to $C_k(\mathbb{R}^d)$. For any non-empty subset $A \subseteq [n]$ there is a natural map

$$\begin{array}{ccc} \pi_A : \mathfrak{C}_k(\mathbb{C}) & \longrightarrow & \mathfrak{C}_A(\mathbb{C}) \\ p = \{p_i\}_{i \in [k]} & \longrightarrow & p_A := \{p_i\}_{i \in A} \end{array}$$

which forgets all the points labeled by elements of the complement $[k] \setminus A$.

The space $\mathfrak{C}_1(\mathbb{R}^d)$ is a point and hence is compact. For $k \geq 2$ a *semialgebraic compactification* $\overline{\mathfrak{C}}_k(\mathbb{R}^d)$ of $\mathfrak{C}_k(\mathbb{R}^d)$ can be defined as the closure of a composition [Me2],

$$(12) \quad \mathfrak{C}_k(\mathbb{R}^d) \xrightarrow{\prod \pi_A} \prod_{\substack{A \subsetneq [k] \\ \#A \geq 2}} \mathfrak{C}_{\#A}(\mathbb{R}^d) \xrightarrow{\prod \Psi_A} \prod_{\substack{A \subsetneq [k] \\ \#A \geq 2}} C_{\#A}(\mathbb{R}^d) \times (0, 1) \hookrightarrow \prod_{\substack{A \subsetneq [k] \\ \#A \geq 2}} \overline{\mathcal{C}}_{\#A}(\mathbb{R}^d) \times [0, 1].$$

Thus all the limiting points in this compactification come from configurations in which a group or groups of points move too *close* to each other within each group and/or a group or groups of points which are moving too *far* (with respect to the standard Euclidean distance) away from each other. The codimension

¹We prefer working with cochain complexes, and hence adopt gradings accordingly.

one boundary strata in $\widehat{\mathfrak{C}}_n(\mathbb{R}^d)$ correspond to the limit values 0 or $+\infty$ of the parameters $|p - p_c|$, and are given by [Me2]

$$(13) \quad \partial \overline{\mathfrak{C}}_k(\mathbb{R}^d) = \bigsqcup_{\substack{A \subseteq [n] \\ \#A \geq 2}} (\overline{\mathfrak{C}}_{n-\#A+1}(\mathbb{R}^d) \times \overline{\mathfrak{C}}_{\#A}(\mathbb{R}^d)) \bigsqcup_{\substack{[k]=B_1 \sqcup \dots \sqcup B_l \\ 2 \leq l \leq k \\ \#B_1, \dots, \#B_l \geq 1}} (\overline{\mathfrak{C}}_k(\mathbb{R}^d) \times \overline{\mathfrak{C}}_{\#B_1}(\mathbb{R}^d) \times \dots \times \overline{\mathfrak{C}}_{\#B_l}(\mathbb{R}^d))$$

where

- the first summation runs over all possible subsets A of $[k]$ and each summand corresponds to A -labeled elements of the set $\{p_1, \dots, p_k\}$ moving *close* to each other,
- the second summation runs over all possible decompositions of $[k]$ into $l \geq 2$ disjoint non-empty subsets B_1, \dots, B_l , and each summand corresponds to l groups of points (labeled, respectively, by disjoint ordered subsets B_1, \dots, B_l of $[k]$) moving *far* from each other while keeping relative distances within each group finite.

Note that the faces of the type $\overline{\mathfrak{C}}_\bullet(\mathbb{C})$ appear in (13) in two different ways — as the strata describing collapsing points and as the strata controlling groups of points going infinitely away from each other — and they do *not* intersect in $\widehat{\mathfrak{C}}_\bullet(\mathbb{C})$. For that reason one has to assign to these two groups of faces different colours and represent collapsing $\overline{\mathfrak{C}}_k(\mathbb{C})$ -stratum by, say, white corolla with straight legs as in (10), the $\overline{\mathfrak{C}}_k(\mathbb{R})$ -stratum at “infinity” by, say, a version of (10) with “broken” legs,

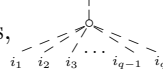

The face $\overline{\mathfrak{C}}_n(\mathbb{C})$ can be represented pictorially by a 2-coloured (skew)symmetric corolla with black vertex,

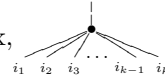

of degree $d(1 - k)$.

Each space $\overline{\mathfrak{C}}_k(\mathbb{R}^d)$ has a natural structure of a smooth manifold with corners.

2.5.1. Proposition [Me2]. *The disjoint union*

$$(14) \quad \mathfrak{C}(\mathbb{R}^d) := \overline{\mathfrak{C}}_\bullet(\mathbb{R}^d) \sqcup \overline{\mathfrak{C}}_\bullet(\mathbb{R}^d) \sqcup \overline{\mathfrak{C}}_\bullet(\mathbb{R}^d)$$

is a 2-coloured operad in the category of semialgebraic manifolds (or smooth manifolds with corners). Its complex of fundamental chains can be identified with the operad $\text{Mor}(\text{Holie}_d)$ which is a dg free non-unital 2-coloured operad generated by the corollas,

$$\text{Mor}(\text{Holie}_d) := \text{Free} \left\langle \begin{array}{c} \text{white corolla with } p \text{ legs} \\ \text{black corolla with } k \text{ legs} \\ \text{white corolla with } q \text{ broken legs} \end{array} \right\rangle_{p, q \geq 2, k \geq 1}$$

and equipped with a differential which is given on white corollas of both colours by formula (11) and on the black corollas by the following formula

$$(15) \quad \partial \left(\text{black corolla with } k \text{ legs} \right) = - \sum_{\substack{A \subseteq [n] \\ \#A \geq 2}} \left(\text{white corolla with } A \text{ legs} \right) \left(\text{black corolla with } [k] \setminus A \text{ legs} \right) + \sum_{l=2}^n \sum_{\substack{[k]=B_1 \sqcup \dots \sqcup B_l \\ \inf B_1 < \dots < \inf B_l}} \pm \left(\text{white corolla with } B_1 \text{ legs} \right) \dots \left(\text{white corolla with } B_l \text{ legs} \right)$$

2.5.2. Example. As $\overline{\mathfrak{C}}_2(\mathbb{R}^n) = S^{d-1}$, the space $\widehat{\mathfrak{C}}_2(\mathbb{R}^d)$ is the closure of the embedding

$$\begin{aligned} \mathfrak{C}_2(\mathbb{R}^d) &\longrightarrow S^{d-1} \times (0, 1) \hookrightarrow S^{d-1} \times [0, +\infty] \\ (p_1, p_2) &\longrightarrow \frac{p_1 - p_2}{|p_1 - p_2|} \times \frac{|p_1 - p_2|}{1 + |p_1 - p_2|} \end{aligned}$$

and hence can be identified with the closed d -dimensional cylinder

$$(16) \quad \bar{\mathcal{C}}_2(\mathbb{R}^d) = \begin{array}{c} S_{out}^{d-1} \\ \text{---} \\ \text{---} \\ \text{---} \\ \text{---} \\ \text{---} \\ S_{in}^{d-1} \end{array} .$$

where S_{in}^{d-1} is the boundary corresponding to $|p_1 - p_2| \rightarrow 0$, and S_{out}^{d-1} is the boundary corresponding to $|p_1 - p_2| \rightarrow +\infty$. This is in accordance with the r.h.s. of (15) for $k = 2$ which is the sum of two terms, the first term corresponding to the bottom “in” sphere S^{d-1} (“two points collapsing to each other”) and upper “out” sphere S^{d-1} (“two points going infinitely far away from each other”).

3. Transcendental formulae for a class of $\mathcal{H}olie_d$ morphisms

3.1. De Rham theories on operads of manifolds with corners. Let $X = \{X_k\}$ be a (a possibly coloured) operad on the category of semialgebraic manifolds (or smooth manifolds with corners), and $\mathfrak{G} = \{\mathfrak{G}(k)\}$ some dg cooperad of graphs with the same set of colours (e.g., the dual cooperad of the operad $\mathcal{D}Gra_d$ or $\mathcal{D}Gra_d^{or}$ from §2). A *de Rham \mathfrak{G} -theory on the operad X* is by definition a collection of \mathbb{S}_n -equivariant (and respecting colours) morphisms of complexes,

$$\begin{array}{ccc} \Omega_k : \mathfrak{G}(k) & \longrightarrow & \Omega^\bullet(X_k) \\ & & \Gamma \longrightarrow \Omega_\Gamma \end{array}$$

where $\Omega^\bullet(X_k)$ stands for the de Rham algebra of piecewise semialgebraic differential forms on X_k , which satisfy the following compatibility condition: for any $k, l \in \mathbb{N}$ and any $i \in [k]$ the associated operad composition

$$\circ_i : X_k \times X_l \longrightarrow X_{k+l-1}$$

and the cooperad co-composition

$$\Delta_i : \mathfrak{G}(k+l-1) \longrightarrow \mathfrak{G}(k) \otimes \mathfrak{G}(l)$$

makes the following diagram commutative,

$$\begin{array}{ccccc} \mathfrak{G}(k+l-1) & \xrightarrow{\Omega_{k+l-1}} & \Omega^\bullet(X_{k+l-1}) & \xrightarrow{\circ_i^*} & \Omega^\bullet(X_k \times X_l) \\ \Delta_i \downarrow & & & \nearrow i & \\ \mathfrak{G}(k) \otimes_{\mathbb{K}} \mathfrak{G}(l) & \xrightarrow{\Omega_k \otimes \Omega_l} & \Omega^\bullet(X_k) \otimes_{\mathbb{K}} \Omega^\bullet(X_l) & & \end{array}$$

where

$$\begin{array}{ccc} i : \Omega^\bullet(X_k) \otimes_{\mathbb{K}} \Omega^\bullet(X_l) & \longrightarrow & \Omega^\bullet(X_k \times X_l) \\ \omega_1 \otimes \omega_2 & \longrightarrow & \omega_1 \wedge \omega_2 \end{array}$$

is the natural inclusion.

3.1.1. Proposition. *Let \mathfrak{G} be the cooperad dual to the operad $\mathcal{D}\mathcal{G}ra_d$ (resp., to $\mathcal{D}\mathcal{G}ra_d^{or}$) equipped with the trivial differential. Then a de Rham \mathfrak{G} -theory on the operad of configuration spaces $\overline{\mathcal{C}}_\bullet(\mathbb{R}^d) = \{\overline{\mathcal{C}}_k(\mathbb{R}^d)\}_{k \geq 2}$ gives rise to the following Maurer-Cartan element*

$$(17) \quad \Upsilon := \sum_{k \geq 2} \sum_{\Gamma \in \mathfrak{G}(k)} \left(\int_{\overline{\mathcal{C}}_k(\mathbb{R}^d)} \Omega_\Gamma \right) \Gamma$$

in the (non-differential) Lie algebra \mathfrak{dfGC}_d (respectively, in \mathfrak{fGC}_d^{or}).

The second summation in (17) runs over the set of generators of the vector space $\mathcal{D}\mathcal{G}ra_d(k)$ (resp., $\mathcal{G}ra_d^{or}(k)$), and we assume $\int_{\overline{\mathcal{C}}_k(\mathbb{R}^d)} \Omega_\Gamma = 0$ if $\deg \Omega_\Gamma \neq \dim \overline{\mathcal{C}}_k(\mathbb{R}^d)$. This proposition is just a reformulation of Theorem 4.2.1 in [Me1] so that we refer to that paper for its proof. It is worth noting that only connected graphs can give a non-zero contribution into the sum (17).

3.2. De Rham \mathfrak{G} -theories from propagators. There is a large class of de Rham \mathfrak{G} -theories on $\overline{\mathcal{C}}_\bullet(\mathbb{R}^d) = \{\overline{\mathcal{C}}_k(\mathbb{R}^d)\}_{k \geq 2}$ constructed as follows. Let ω be an arbitrary differential top degree differential form on the sphere

$$C_2(\mathbb{R}^d) = \overline{\mathcal{C}}_2(\mathbb{R}^d) = S^{d-1}$$

normalized so that

$$\int_{S^{d-1}} \omega = 1.$$

We call such a differential form a *propagator*. For any pair of distinct ordered numbers (i, j) with $i, j \in [k]$, consider a smooth map

$$p_{ij} : \begin{array}{ccc} C_k(\mathbb{R}^d) & \longrightarrow & C_2(\mathbb{R}^d) \\ (p_1, \dots, p_k) & \longrightarrow & \frac{p_i - p_j}{|p_i - p_j|}, \end{array}$$

The pullback $\pi_{ij}^*(\omega)$ defines a degree $d - 1$ differential form on $C_k(\mathbb{R}^n)$ which extends smoothly to the compactification $\overline{\mathcal{C}}_k(\mathbb{R}^d)$. In particular, for any directed graph Γ with k labelled vertices and any edge $e \in E(\Gamma)$ there is an associated differential form $p_e^*(\omega) \in \Omega_{\overline{\mathcal{C}}_k(\mathbb{R}^d)}^{d-1}$, where $p_e := p_{ij}$ if the edge e begins at the vertex labelled by i and ends at the vertex labelled by j . Then, for \mathfrak{G} being the cooperad dual to the operad $\mathcal{D}\mathcal{G}ra_d$, consider a collection of maps

$$\begin{array}{ccc} \Omega_k : \mathfrak{G}(k) & \longrightarrow & \Omega_{\overline{\mathcal{C}}_k(\mathbb{R}^d)}^\bullet \\ \Gamma & \longrightarrow & \Omega_\Gamma := \bigwedge_{e \in E(\Gamma)} \pi_e^*(\omega). \end{array}$$

It defines a de Rham \mathfrak{G} -theory on the operad $\overline{\mathcal{C}}_\bullet(\mathbb{R}^d)$ which in turn gives rise to a Maurer-Cartan element (17) in \mathfrak{fGC}_d which in turn induces a *Holie* _{d} structure in $\mathbb{A}_d^{(n)}$,

$$(18) \quad \mu^\omega = \left\{ \mu_k^\omega : \otimes^n \mathbb{A}_d^{(n)} \longrightarrow \mathbb{A}_d^{(n)} [d + 1 - kd] \right\}$$

given explicitly by

$$(19) \quad \mu_k^\omega = \sum_{\Gamma \in \mathfrak{G}(k)} \left(\int_{\overline{\mathcal{C}}_k(\mathbb{R}^d)} \Omega_\Gamma \right) \Phi_\Gamma.$$

As $\wedge^N \omega = 0$ for sufficiently large N , graphs with too many edges between any pair of vertices do not contribute into the sum in the r.h.s. of (19) so that the sum is finite and the formula is well-defined.

Note that an (oriented) graphs Γ with k vertices can make a non-zero contribution into (17) or into μ_k^ω only if $d - 1 \mid kd - d - 1$, i.e. if and only if $k = (d - 1)l + 2$ for some $l \in \mathbb{N}$; in that case the number of edges of Γ must be equal to $\frac{kd - d - 1}{d - 1} = dl + 1$.

Denote by $\mathcal{G}_{k,l}$ (respectively, $\mathcal{G}_{k,l}^{or}$) the subset of the set $\mathcal{G}_{k,l}$ (respectively, $\mathcal{G}_{k,l}^{or}$) of directed (oriented) graphs consisting of connected graphs Γ such every vertex of Γ has valency ≥ 2 . Then we have the following sharpening of Proposition **3.1.1**.

3.2.1. Proposition. *For any propagator ω on S^{d-1} , $d \geq 2$, there is an associated Maurer-Cartan element*

$$(20) \quad \Upsilon^\omega = \textcircled{1} \rightarrow \textcircled{2} - (-1)^d \textcircled{2} \rightarrow \textcircled{1} + \sum_{l \geq 1} \sum_{\Gamma \in \mathbf{G}_{l(d-1)+2, ld+1}} \left(\int_{\mathcal{C}_{l(d-1)+2}(\mathbb{R}^d)} \bigwedge_{e \in E(\Gamma)} \pi_e^*(\omega) \right) \Gamma$$

in dfGC_d , and an associated \mathcal{Holie}_d algebra structure (18) can have μ_k^ω non-vanishing only for $k = l(d-1) + 2$ for some $l \in \mathbb{N}$, and with μ_2^ω given by the standard Schouten bracket (7).

Proof. It remains to check that (i) disconnected graphs and (ii) connected directed graphs with univalent vertices do not contribute into the sum over $l \geq 1$. Let us show the second claim, the proof of the first claim being analogous (cf. [Ko3]).

Let $\Gamma \in \mathbf{G}_{l(d-1)+2, ld+1}$, $l \geq 1$ be a connected directed graph with a univalent vertex $v \in V(\Gamma)$, and let v' be the unique vertex connected to v by the unique edge $e_{v,v'}$. Note that v' has valency at least 2 (as the Γ is connected and has ≥ 3 vertices) so that there is a vertex $v'' \in V(\Gamma) \setminus v$ which is connected by an edge to v' . Let a $p_{v'}$ and $p_{v''}$ be two different points in \mathbb{R}^d corresponding to the vertices v' and respectively v'' . Using the action of the group $\mathbb{R}^+ \times \mathbb{R}^d$ on \mathbb{R}^d we can put $p_{v'}$ into $0 \in \mathbb{R}^d$ and $p_{v''}$ on the unital sphere S^{d-1} with center at 0. The integral factorizes as follows

$$\int_{\mathcal{C}_{l(d-1)+2}(\mathbb{R}^d)} \bigwedge_{e \in E(\Gamma)} \pi_e^*(\omega) = \int_{\text{Conf}_1(\mathbb{R}^d)} \pi_{e_{v,v'}}^*(\omega) \cdot \int_{M \subset \text{Conf}_{l(d-1)}(\mathbb{R}^d)} \bigwedge_{e \in E(\Gamma) \setminus e_{v,v'}} \pi_e^*(\omega)$$

The form $\bigwedge_{e \in E(\Gamma) \setminus e_{v,v'}} \pi_e^*(\omega)$ has degree $ld(d-1)$ and M is a subspace in $\text{Conf}_{l(d-1)}(\mathbb{R}^d)$ of dimension $ld(d-1) - 1$ (as one of the configuration points, $p_{v''}$, is restricted to lie on S^{d-1}). Hence the form $\bigwedge_{e \in E(\Gamma) \setminus e_{v,v'}} \pi_e^*(\omega)$ vanishes identically on M and the claim is proven. \square

3.2.2. Example: the standard Schouten type bracket. If one chooses the propagator

$$\omega_0 := \text{Vol}_{S^{d-1}}$$

to be the standard homogeneous (normalized to 1) volume form on S^{d-1} then, thanks to Kontsevich's Vanishing Lemma (proven for $d = 2$ case in [Ko3] and for $d \geq 3$ in [Ko1]), all integrals in the sum (20) over $l \geq 1$ vanish so that

$$(21) \quad \Upsilon^{\omega_0} = \textcircled{1} \rightarrow \textcircled{2} - (-1)^d \textcircled{2} \rightarrow \textcircled{1} = =: \bullet \rightarrow \bullet$$

The associated \mathcal{Holie}_d structure μ^{ω_0} in $\mathbb{A}_d^{(n)}$ is just the standard Schouten bracket (7).

3.2.3. Example: a class of $\mathcal{L}ie_\infty$ structures given by oriented graphs. Let $g(x)$ be a non-negative function on the sphere

$$S^{d-1} = \{(x_1, \dots, x_d) \in \mathbb{R}^d \mid x_1^2 + \dots + x_d^2 = 1\}$$

with compact support in the the upper ($x_d > 0$) half of S^{d-1} and normalized so that

$$\int_{S^{d-1}} g \text{Vol}_{S^{d-1}} = 1.$$

We can and will assume from now on that the function $g(x)$ on S^{d-1} is invariant under the reflection in the x_d -axis,

$$\sigma : \{x_i \rightarrow -x_i\}_{1 \leq i \leq d-1}, x_d \rightarrow x_d.$$

so that the propagator

$$(22) \quad \omega_g := g \text{Vol}_{S^{d-1}}$$

satisfies

$$(23) \quad \sigma^*(\omega_g) = (-1)^{d-1} \omega_g$$

It is clear that only *oriented* graphs can give a non-trivial contribution into the associated Maurer-Cartan element (20) (so that $\Upsilon^{\omega_g} \in \text{dfGC}_d^{\text{or}}$) and that the associated \mathcal{Holie}_d structure μ_{ω_g} on $\mathbb{A}_d^{(n)}$ is well-defined in the limit $n \rightarrow +\infty$.

The imposed symmetry property (23) leads to vanishing of many terms in the sum (20).

3.2.4. Proposition. *For any propagator ω_g as above the associated MC element in $\text{dfGC}_d^{\text{or}}$ has the form*

$$(24) \quad \Upsilon^{\omega_g} = \bullet \rightarrow \bullet + \sum_{p \geq 1} \sum_{\Gamma \in \mathcal{G}_{2p(d-1)+2, 2pd+1}^{\text{or}}} \left(\int_{\overline{\mathcal{C}}_{2p(d-1)+2}(\mathbb{R}^d)} \bigwedge_{e \in E(\Gamma)} \pi_e^*(\omega_g) \right) \Gamma$$

so that the associated \mathcal{Holie}_d structure in $\mathbb{A}_d^{(n)}$ can have linear maps $\mu_k^{\omega_g} \neq 0$ only for $k = 2p(d-1) + 2$, $p \in \mathbb{N}$.

Proof. By Proposition 3.2.1, $\mu_k^{\omega_g}$ can be non-zero if and only if $k = (d-1)l + 2$ for some $l \in \mathbb{N}$. Let

$$C_\Gamma := \int_{\overline{\mathcal{C}}_{(d-1)l+2}(\mathbb{R}^d)} \bigwedge_{e \in E(\Gamma)} \pi_e^*(\omega_g)$$

be the weight of a summand $\Gamma \in G_{(d-1)l+2, dl+1}$ in $\mu_{(d-1)l+2}^{\omega_g}$ or in Υ^g . Using the translation freedom we can fix one of the vertices of Γ at $0 \in \mathbb{R}^d$. If σ stands for the reflection in the x_d axis we have (cf. [Ko3, Sh2]),

$$\int_{\sigma(\overline{\mathcal{C}}_{(d-1)l+2}(\mathbb{R}^d))} \bigwedge_{e \in E(\Gamma)} \pi_e^*(\omega) = \int_{\overline{\mathcal{C}}_{(d-1)l+2}(\mathbb{R}^d)} \sigma^*(\pi_e^*(\omega)).$$

As $\sigma(\overline{\mathbb{R}^d_{(d-1)l+2}(\mathbb{C})})$ is equal to $\overline{\mathcal{C}}_{(d-1)l+2}(\mathbb{R}^d)$ with orientation changed by the factor $(-1)^{(k-1)(d-1)}$ and as $\sigma^*(\omega_g) = (-1)^{d-1}\omega_g$, we obtain an equality

$$(-1)^{((d-1)l+2-1)(d-1)} C_\Gamma = (-1)^{(dl+1)(d-1)} C_\Gamma$$

which implies $C_\Gamma = 0$ unless

$$(d-1)l + 1 \equiv dl + 1 \pmod{2\mathbb{Z}}$$

i.e. unless $l = 2p$ for some $p \in \mathbb{N}$. □

3.2.5. Example: a Kontsevich-Shoikhet $\mathcal{L}ie_\infty$ structure. If $d = 2$, then only oriented graphs Γ with even number $2p$ of vertices contribute into Υ^g , and the leading terms are given explicitly by [Sh2]

$$(25) \quad \Upsilon_{KS}^g := \Upsilon^{\omega_g} = \bullet \rightarrow \bullet + \lambda \begin{array}{c} \bullet \\ \diagup \quad \diagdown \\ \bullet \end{array} + 2\lambda \begin{array}{c} \bullet \\ \diagup \quad \diagdown \\ \bullet \end{array} + \lambda \begin{array}{c} \bullet \\ \diagup \quad \diagdown \\ \bullet \end{array} + \dots =: \sum_{p \geq 1} \Upsilon_{2p}$$

for some $\lambda \in \mathbb{R} \setminus 0$. In view of the homotopy uniqueness of the Kontsevich-Shoikhet element $\Upsilon_{KS} \in \text{fGC}_3^{\text{or}}$, the sum Υ_{KS}^g must be gauge equivalent (with the gauge depending on the choice of a function g) to an element Υ_{KS} constructed by induction in §2.2.

Thus the propagator ω_g induces a Kontsevich-Shoikhet \mathcal{Holie}_2 structure μ_{KS}^g in $\mathbb{A}_d^{(2)} = \mathcal{T}_{\text{poly}}(\mathbb{R}^n)$

$$(26) \quad [, \dots,]_{2p} := \sum_{\Gamma \in \mathcal{G}_{2p, 4p-3}^{\text{or}}} \left(\int_{\overline{\mathcal{C}}_{2p}(\mathbb{R}^d)} \bigwedge_{e \in E(\Gamma)} \pi_e^*(\omega_g) \right) \Phi_\Gamma : \mathcal{T}_{\text{poly}}(\mathbb{R}^n)^{\otimes 2p} \rightarrow \mathcal{T}_{\text{poly}}(\mathbb{R}^n)[3-4p]$$

which is isomorphic to the one introduced in [Sh2].

We have two explicit \mathcal{Holie}_d structures in $\mathbb{A}_2^{(n)}$, the standard one (7) corresponding to the propagator ω_0 and the Kontsevich-Shoikhet one ω_g corresponding to the propagator (22). Shoikhet conjectured in [Sh2] that for $d = 2$ these two structures are \mathcal{Holie}_2 isomorphic, i.e. there is a \mathcal{Holie}_2 isomorphism

$$F : (\mathcal{T}_{\text{poly}}(\mathbb{R}^n), [,]_S) \longrightarrow (\mathcal{T}_{\text{poly}}(\mathbb{R}^n), [, \dots,]_{2p}, p \geq 1)$$

Stated in terms of graphs, this conjecture says that as Maurer-Cartan elements in dfGC_2 the expressions (21) and (25) are gauge-equivalent to each other,

$$(27) \quad \Upsilon_S = e^{\text{ad}_\Theta} \Upsilon_{KS}^g = e^{\text{ad}_\Theta} \left(\sum_{p=1}^{\infty} \Upsilon_{2p} \right)$$

for some degree zero element Θ in \mathfrak{fGC}_2 . That this relation holds true is far from obvious. Indeed, let us attempt to construct Θ by induction on the number of vertices (as we managed to construct Υ_{KS} above). The first step is easy — the term Υ_4 is δ -exact in \mathfrak{dfGC}_2 ,

$$\Upsilon_4 = \lambda \delta \left(\begin{array}{c} \bullet \\ \diagup \quad \diagdown \\ \bullet \end{array} + \begin{array}{c} \bullet \\ \diagdown \quad \diagup \\ \bullet \end{array} \right)$$

and we can use the sum of two graphs of degree zero inside the brackets to gauge away Υ_4 . However the next obstruction becomes a *wheeled* graph Υ'_6 from \mathfrak{dfGC}_2 so that starting with the second step all the obstruction classes land in $H^1(\mathfrak{dfGC}_2) = H^1(\mathfrak{GC}_2)$ (rather than in $H^1(\mathfrak{GC}_2^{or})$), the same cohomology group where, according to Kontsevich [Ko2], all the obstructions for the universal deformation quantization of Poisson structures lie. Therefore, the formula for Θ must be as highly non-trivial as the Kontsevich quantization formula in [Ko3]. One of our main results in this paper is such an explicit formula for Θ proving thereby Shoikhet's conjecture (in fact, we show that it holds true for *any* value of the integer parameter d).

An MC element of the \mathcal{Holie}_2 algebra $\mu_{KS}^{\omega_g}$ can be defined (to assure convergence) as a degree 2 formal power series $\pi = \hbar \pi^\diamond(\hbar)$ for some $\pi^\diamond(\hbar) \in \mathcal{T}_{poly}(\mathbb{R}^n)[[\hbar]]$ satisfying the equation

$$\frac{1}{2}[\pi, \pi]_2 + \frac{1}{4!}[\pi, \pi, \pi, \pi]_4 + \dots = 0,$$

or, equivalently,

$$\frac{1}{2}[\pi^\diamond, \pi^\diamond]_2 + \frac{\hbar^2}{4!}[\pi^\diamond, \pi^\diamond, \pi^\diamond, \pi^\diamond]_4 + \frac{\hbar^4}{6!}[\pi^\diamond, \pi^\diamond, \pi^\diamond, \pi^\diamond, \pi^\diamond, \pi^\diamond]_6 + \dots = 0.$$

The equation is invariant under $\hbar \rightarrow -\hbar$ so that it makes sense to look for solutions $\pi^\diamond(\hbar)$ which are also invariant under $\hbar \rightarrow -\hbar$, i.e. which are formal power series in \hbar^2 . Such solutions are precisely what we call quantizable Poisson structures, and making the change $\hbar^2 \rightarrow \hbar$ we arrive at the defining equations in the Subsection 1.2.

3.2.6. Example: a class of Kontsevich-Shoikhet type $\mathcal{L}ie_\infty$ structures in the case $d = 3$. In this case one can apply a refined version **A.5** of Proposition **3.2.4** and write explicitly the associated Maurer-Cartan

$$(28) \quad \Upsilon^{\omega_g} = \begin{array}{c} \bullet \\ \bullet \end{array} + \sum_{p \geq 2} \sum_{\Gamma \in \hat{\mathcal{G}}_{4p+2, 6p+1}^{or}} \left(\int_{\overline{\mathcal{C}}_{4p+2}(\mathbb{R}^3)} \bigwedge_{e \in E(\Gamma)} \pi_e^*(\omega_g) \right) \Gamma$$

and the associated \mathcal{Holie}_3 structure $\mu^{\omega_g} = \{\mu_{4p+2}^{\omega_g}\}_{p \geq 2}$ in $\mathbb{A}_3^{(n)}$ for any $n \in \mathbb{N}$

$$(29) \quad \mu_2 = [\cdot, \cdot]_S \quad \text{and} \quad \mu_{4p+2}^{\omega_g} := \sum_{\Gamma \in \hat{\mathcal{G}}_{4p+2, 6p+1}^{or}} \left(\int_{\overline{\mathcal{C}}_{4p+2}(\mathbb{R}^3)} \bigwedge_{e \in E(\Gamma)} \pi_e^*(\omega_g) \right) \Phi_\Gamma \quad \text{for } p \geq 2.$$

using the subset of graphs $\hat{\mathcal{G}}_{4p+2, 6p+1} \subset \mathcal{G}_{4p+2, 6p+1}$ introduced in the Appendix A. This gives us a 3-dimensional analogue of the Kontsevich-Shoikhet structure on polyvector fields.

Maurer-Cartan elements of the Lie algebra $(\mathbb{A}_3^{(n)}, [\cdot, \cdot]_S)$ are precisely (strongly homotopy) Lie bialgebra structures in the vector space $V = \text{span}\langle x_1, \dots, x_n \rangle$. Maurer-Cartan elements in the continuous \mathcal{Holie}_3 algebra $(\mathbb{A}_3^{(n)}[[\hbar]], \mu^{\omega_g})$, that is, degree 3 elements $\pi^\diamond \in \mathbb{A}_3^{(n)}[[\hbar]]$ satisfying the equation

$$[\pi^\diamond, \gamma^\diamond]_S + \sum_{p \geq 2} \frac{\hbar^p}{(4p+2)!} \mu_{4p+2}^{\omega_g}(\pi^\diamond, \pi^\diamond, \dots, \pi^\diamond) = 0,$$

are called *quantizable Lie bialgebras*. We show in Section 7 below that the latter structures can be easily deformation quantized via an explicit formula. We also show below an explicit formula for a universal (i.e. independent of a particular value of n) \mathcal{Holie}_2 morphism

$$(\mathbb{A}_3^{(n)}, [\cdot, \cdot]_S) \longrightarrow (\mathbb{A}_3^{(n)}[[\hbar]], \mu^{\omega_g}).$$

The two formulae provide us with an explicit universal quantization of ordinary Lie bialgebras.

We shall be interested below in a special class of propagators of type ω_g on S^2 constructed as follows. Consider the upper-half hemisphere,

$$S_+^2 := \{(x, y, z) \in \mathbb{R}^3 \mid x^2 + y^2 + z^2 = 1, z > 0\}$$

and a well-defined smooth map

$$\begin{aligned} \nu_+ : S_+^2 &\longrightarrow S^1 \times S^1 \\ (x, y, z) &\longrightarrow (\text{Arg}(x + iz), \text{Arg}(y + iz)) \end{aligned}$$

Let $\bar{g}(\theta)d\theta$ be a normalized volume form on the circle $S^1 = \{e^{i\theta} \mid \theta \in [0, 2\pi]\}$ as in (22), i.e. the function $\bar{g}(\theta)$ has a compact support in the open interval $(0, \pi)$ and satisfies the standard conditions for $d = 2$ propagator,

$$\bar{g}(\theta) = \bar{g}(\pi - \theta), \quad \int_0^{2\pi} \bar{g}(\theta)d\theta = 1.$$

Then

$$(30) \quad \omega_{\bar{g}} := \nu_+^* (\bar{g}(x + iz)\bar{g}(y + iz)d\text{Arg}(x + iz) \wedge d\text{Arg}(y + iz))$$

is a smooth differential form on S_+^2 which extends by zero to a smooth differential form on S^2 and which satisfies the standard conditions for $d = 3$ propagator,

$$\int_{S^2} \omega_{\bar{g}} = 1,$$

and

$$\begin{aligned} \sigma^*(\omega_{\bar{g}}) &= \sigma^* (\nu_+^* (\bar{g}(x + iz)\bar{g}(y + iz)d\text{Arg}(x + iz) \wedge d\text{Arg}(y + iz))) \\ &= \nu_+^* (\bar{g}(-x + iz)\bar{g}(-y + iz)d\text{Arg}(-x + iz) \wedge d\text{Arg}(-y + iz)) \\ &= \nu_+^* (\bar{g}(x + iz)\bar{g}(y + iz)(-1)^2 d\text{Arg}(x + iz) \wedge d\text{Arg}(y + iz)) \\ &= \omega_{\bar{g}}. \end{aligned}$$

Hence the propagator $\omega_{\bar{g}}$ belongs to the family of propagators² (22) so that all the above claims hold true for $\omega_{\bar{g}}$.

The 1-form

$$\Omega_{\bar{g}}(\theta) := \bar{g}(\theta)d\theta$$

has support in the open interval $(0, \pi)$ and hence it makes sense to consider its *iterated integrals*,

$$(31) \quad \Lambda_{\bar{g}}^{(p)} := \int_0^\pi \underbrace{\Omega_{\bar{g}} \Omega_{\bar{g}} \dots \Omega_{\bar{g}}}_{p \text{ times}}$$

which are some positive real numbers with $\Lambda_{\bar{g}}^{(1)} = 1$.

3.3. Transcendental formula for a class of $\mathcal{H}olie_d$ morphisms. Consider an operad $\mathcal{D}Gra_d$ and its 2-coloured version

$$(32) \quad \underline{\mathcal{D}Gra}_d = (\mathcal{D}Gra_d^{out}, \mathcal{D}Gra_d^{mor}, \mathcal{D}Gra_d^{in})$$

consisting of three copies of $\mathcal{D}Gra_d$: one copy is denoted by $\mathcal{D}Gra_d^{out}$ and has inputs and outputs in “dashed” colour, the second copy is denoted by $\mathcal{D}Gra_d^{mor}$ and has inputs in “solid” colour and the output in the dashed colour, and the third copy is denoted by $\mathcal{D}Gra_d^{in}$ and has both inputs and outputs in the “solid” colour (cf. Proposition 2.5.1). Therefore for any $n, m \in \mathbb{N}$ and any $i \in [n]$ the only non-trivial operadic compositions are of the form

$$\begin{aligned} \circ_i : \mathcal{D}Gra_d^{out}(n) \otimes \mathcal{D}Gra_d^{out}(m) &\longrightarrow \mathcal{D}Gra_d^{out}(n+m-1), & \circ_i : \mathcal{D}Gra_d^{in}(n) \otimes \mathcal{D}Gra_d^{in}(m) &\longrightarrow \mathcal{D}Gra_d^{in}(n+m-1), \\ \circ_i : \mathcal{D}Gra_d^{out}(n) \otimes \mathcal{D}Gra_d^{mor}(m) &\longrightarrow \mathcal{D}Gra_d^{mor}(n+m-1), & \circ_i : \mathcal{D}Gra_d^{mor}(n) \otimes \mathcal{D}Gra_d^{in}(m) &\longrightarrow \mathcal{D}Gra_d^{mor}(n+m-1). \end{aligned}$$

²We apologize for some abuse of notations — the propagator $\omega_{\bar{g}}$ is *not* equal to $\bar{g}\text{Vol}_{S^2}$; the role of the bar in the notation $\omega_{\bar{g}}$ is to emphasize this difference.

Similarly one defines a 2-coloured operad \underline{Gra}_d^{or} of oriented graphs. Let $\underline{\mathfrak{G}}$ and $\underline{\mathfrak{G}}^{or}$ be the cooperads dual to the operads \underline{DGr}_d and \underline{Gra}_d^{or} respectively.

3.3.1. Proposition. *Let $\underline{\mathfrak{G}} = (\mathfrak{G}^{in}, \mathfrak{G}^{mor}, \mathfrak{G}^{out})$ be the 2-coloured cooperad dual to the operad (32). Then a de Rham $\underline{\mathfrak{G}}$ -theory,*

$$\Omega = (\Omega^{in}, \Omega^{mor}, \Omega^{out}) : (\mathfrak{G}^{in}, \mathfrak{G}^{mor}, \mathfrak{G}^{out}) \longrightarrow \left(\Omega_{\underline{\mathfrak{C}}_{\bullet}(\mathbb{R}^d)}^{\bullet}, \Omega_{\underline{\mathfrak{C}}_{\bullet}(\mathbb{R}^d)}^{\bullet}, \Omega_{\underline{\mathfrak{C}}_{\bullet}(\mathbb{R}^d)}^{\bullet} \right)$$

on the 2-coloured operad of compactified configuration spaces $\underline{\mathfrak{C}}(\mathbb{R}^d)$ (see (14)) provides us with a \mathcal{Holie}_d -isomorphism between \mathcal{Holie}_d -algebras,

$$F : \left(\mathbb{A}_d^{(n)}, \mu_{\bullet}^{\Gamma_{in}} \right) \longrightarrow \left(\mathbb{A}_d^{(n)}, \mu_{\bullet}^{\Gamma_{out}} \right) \quad \forall n \in \mathbb{N}$$

associated to Maurer-Cartan elements

$$\Upsilon_{in} := \sum_{k \geq 2} \sum_{\Gamma \in \mathfrak{G}^{in}(k)} \left(\int_{\underline{\mathfrak{C}}_k(\mathbb{R}^d)} \Omega_{\Gamma}^{in} \right) \Gamma \quad \text{and} \quad \Upsilon_{out} := \sum_{k \geq 2} \sum_{\Gamma \in \mathfrak{G}^{out}(k)} \left(\int_{\underline{\mathfrak{C}}_k(\mathbb{R}^d)} \Omega_{\Gamma}^{out} \right) \Gamma$$

in dfGC_d . This isomorphism is given explicitly by the following formulae,

$$(33) \quad F = \left\{ F_k : \otimes^k \mathbb{A}_d^{(n)} \longrightarrow \mathbb{A}_d^{(n)}[d - dk] \right\}_{k \geq 1}$$

where

$$F_k := \sum_{\Gamma \in \mathfrak{G}^{mor}(k)} \left(\int_{\underline{\mathfrak{C}}_k(\mathbb{R}^d)} \Omega_{\Gamma}^{mor} \right) \Phi_{\Gamma}$$

Proof. The claim follows from the de Rham theorem applied to the family of the compactified configuration spaces $\underline{\mathfrak{C}}_{\bullet}(\mathbb{R}^d)$ and Proposition 2.5.1 (see §10.1 in [Me2] for details). \square

3.4. An example. Consider a smooth degree $d-1$ differential form ϖ on $\mathfrak{C}_2(\mathbb{R}^d) = S^{d-1} \times [0, 1]$ such that its restrictions $\omega_{in} := \varpi|_{t=0}$ and $\omega_{out} := \varpi|_{t=1}$ give us top degree differential forms on $\underline{\mathfrak{C}}_2(\mathbb{R}^d) = S^{d-1}$ such that $\int_{S^{d-1}} \omega_{in} = 1$ and $\int_{S^{d-1}} \omega_{out} = 1$. Then the collections of maps, $k \geq 1$,

$$\begin{aligned} \Omega_k^{in} : \mathfrak{G}^{in}(k) &\longrightarrow \Omega_{\underline{\mathfrak{C}}_k(\mathbb{R}^d)}^{\bullet} & \Omega_k^{out} : \mathfrak{G}^{out}(k) &\longrightarrow \Omega_{\underline{\mathfrak{C}}_k(\mathbb{R}^d)}^{\bullet} \\ \Gamma &\longrightarrow \Omega_{\Gamma} := \bigwedge_{e \in E(\Gamma)} \pi_e^*(\omega_{in}) & \Gamma &\longrightarrow \Omega_{\Gamma} := \bigwedge_{e \in E(\Gamma)} \pi_e^*(\omega_{out}) \\ \Omega_k^{mor} : \mathfrak{G}^{mor}(k) &\longrightarrow \Omega_{\underline{\mathfrak{C}}_k(\mathbb{R}^d)}^{\bullet} & & \\ \Gamma &\longrightarrow \Omega_{\Gamma} := \bigwedge_{e \in E(\Gamma)} \pi_e^*(\varpi) & & \end{aligned}$$

define a de Rham $\underline{\mathfrak{G}}$ -theory on the 2-coloured operad $\underline{\mathfrak{C}}(\mathbb{R}^d)$ (see Theorem 10.1.1 in [Me2] for a proof), and hence a \mathcal{Holie}_d isomorphism (33) of the associated \mathcal{Holie}_d algebra structures in $\mathbb{A}_d^{(n)}$ for any n .

The propagator (22) satisfies the following equation

$$\omega_g = \text{Vol}_{S^{d-1}} + d\Psi_g$$

for some degree $d-2$ differential form Ψ_g on S^{d-1} . As $H^{d-2}(S^{d-1})$ equals zero for $d \geq 3$ and \mathbb{R} for $d = 2$, we can (and will) choose Ψ_g in such a way that (cf. (23))

$$\sigma^*(\Psi_g) = (-1)^{d-1} \Psi_g,$$

where $\sigma : S^{d-1} \rightarrow S^{d-1}$ is the reflection in the x_d -axis.

Consider next a differential form on $\mathfrak{C}_2(\mathbb{R}^d)$,

$$\varpi_g := \text{Vol}_{S^{d-1}} \left(\frac{p_1 - p_2}{|p_1 - p_2|} \right) + \frac{|p_1 - p_2|}{1 + |p_1 - p_2|} d\Psi_g \left(\frac{p_1 - p_2}{|p_1 - p_2|} \right) + (-1)^{d-1} \Psi_g \left(\frac{p_1 - p_2}{|p_1 - p_2|} \right) \wedge d \left(\frac{|p_1 - p_2|}{1 + |p_1 - p_2|} \right)$$

As it satisfies the conditions

$$\varpi_g \big|_{S_{in}^{d-1}} = \text{Vol}_{S^{d-1}}, \quad \varpi_g \big|_{S_{out}^{d-1}} = \text{Vol}_{S^{d-1}} + d\Psi_g = \omega_g.$$

and

$$(34) \quad \sigma^*(\varpi_g) := (-1)^{d-1}\varpi_g.$$

the associated $\underline{\mathfrak{G}}$ -theory on $\underline{\mathfrak{C}}(\mathbb{R}^d)$ gives us almost immediately the following result (which for $d = 2$ proves the Shoikhet conjecture).

3.4.1. Theorem. *For any $d \geq 2$ and any $n \geq 1$ there is a $\mathcal{H}olie_d$ isomorphism between the $\mathcal{H}olie_d$ algebras,*

$$F^{\omega_g} : \left(\mathbb{A}_d^{(n)}, [,]_S \right) \longrightarrow \left(\mathbb{A}_d^{(n)}, \mu^{\omega_g} \right)$$

which is given by (33) with $F_k^{\omega_g}$ possibly non-zero only for $k = 1 + 2q(d-1)$, $q \in \mathbb{Z}^{\geq 0}$,

$$(35) \quad F_{1+2q(d-1)}^{\omega_g} = \sum_{\Gamma \in \mathbf{G}_{1+2q(d-1), 2qd}} \left(\int_{\underline{\mathfrak{C}}_k(\mathbb{R}^d)} \bigwedge_{e \in E(\Gamma)} \pi_e^*(\varpi_g) \right) \Phi_\Gamma.$$

Proof. We have only to check that a connected directed graph Γ with all vertices of valency ≥ 2 can give a non-trivial contribution to the above formulae if and only if it belongs to the set $\mathbf{G}_{1+2q(d-1), 2qd}$ for the non-negative integer q .

As $\dim \underline{\mathfrak{C}}_k(\mathbb{R}^d) = kd - d = d(k-1)$ a directed graph Γ with k vertices can have non-zero weight

$$c_\Gamma := \int_{\underline{\mathfrak{C}}_k(\mathbb{R}^d)} \bigwedge_{e \in E(\Gamma)} \pi_e^*(\varpi_g)$$

if and only if its number of edges, say l , satisfies the equation

$$d(k-1) = (d-1)l.$$

Thus $l = pd$ for some $p \in \mathbb{Z}^{\geq 0}$ and hence $k-1 = p(d-1)$. Thus only graphs Γ from $\mathbf{G}_{1+p(d-1), pd}$ can have $c_\Gamma \neq 0$.

Using the translation freedom we can fix one of the vertices of Γ at $0 \in \mathbb{R}^d$. Using the reflection σ in the x_d as in the proof of Proposition 3.2.4 and formula (34), we obtain an equality

$$(-1)^{p(d-1)(d-1)} c_\Gamma = (-1)^{(d-1)pd} c_\Gamma$$

which implies $c_\Gamma = 0$ unless $p = 2q$ for some non-negative integer q . \square

This Theorem gives us an explicit gauge equivalence between between the Maurer-Cartan elements Υ_S and Υ_{KS}^g . We use it below in the case $d = 2$ to show that such gauge equivalences (and hence the homotopy classes of the associated universal $\mathcal{H}olie_d$ morphisms) are classified by the set of Drinfeld associators. In particular, the Grothendieck-Teichmüller group GRT_1 acts effectively and transitively on such gauge equivalences.

3.4.2. Corollary. *Given a Maurer-Cartan element $\pi \in \mathbb{A}_d^{(n)}$,*

$$[\pi, \pi]_S = 0$$

of the Lie algebra $(\mathbb{A}_d^{(n)}, [,]_S)$, the associated formal power series

$$(36) \quad \pi^\diamond = \pi + \sum_{q=1}^{\infty} \frac{\hbar^q}{(1+2q(d-1))!} F_{1+2q(d-1)}^{\omega_g}(\pi, \dots, \pi)$$

in $\mathbb{A}_d^{(n)}[[\hbar]]$ satisfies the equation

$$(37) \quad [\pi^\diamond, \pi^\diamond]_S + \sum_{p \geq 1} \frac{\hbar^p}{(2p(d-1)+2)!} \mu_{2p(d-1)+2}^{\omega_g}(\pi^\diamond, \dots, \pi^\diamond) = 0$$

In particular, the transcendental morphism F^{ω_g} sends ordinary Poisson and Lie bialgebra structures into *quantizable* ones establishing thereby a 1-1 correspondence between their gauge equivalence classes: (i) given an ordinary Poisson/Lie bialgebra structure π in \mathbb{R}^n , the above formal power series gives us a quantizable Poisson/Lie bialgebra structure π° , (ii) given a quantizable Poisson/Lie bialgebra structure π° in \mathbb{R}^n , the initial term $\pi := \pi^\circ|_{\hbar=0}$ is an ordinary Poisson structure/Lie bialgebra.

3.5. Remark. The Kontsevich-Shoikhet $\mathcal{H}olie_2$ structure on polyvector fields and the associated $\mathcal{H}olie_2$ isomorphism (35) have been defined above on the *affine* space \mathbb{R}^n (as the formulae are invariant only under the affine group, not under the group of diffeomorphisms). However both structures can be globalized, i.e. can be well-defined on an arbitrary manifold M using a torsion-free connection on M as they both do not involve graphs with vertices which are univalent or have precisely one incoming edge and precisely one outgoing edge.

4. A new explicit formula for universal quantizations of Poisson structures

4.1. The Kontsevich formula for a formality map. Let $Conf_{n,m}(\overline{\mathbb{H}})$ be the configuration space of injections $z : [m+n] \hookrightarrow \overline{\mathbb{H}}$ of the set $[m+n]$ into the closed upper-half plane such that the following conditions are satisfied

- (i) for $1 \leq i \leq m$ one has $z_i := z(i) \in \mathbb{R} = \partial\overline{\mathbb{H}}$ and $z_1 < z_2 < \dots < z_m$;
- (ii) for $m+1 \leq i \leq m+n$ one has $z_i \in \mathbb{H}$.

The group $\mathbb{R}^+ \times \mathbb{R}$ acts on this configuration space freely via $z_i \rightarrow \lambda z_i + a$, $\lambda \in \mathbb{R}^+$, $a \in \mathbb{C}$, so that the quotient space

$$C_{n,m}(\mathbb{H}) := \frac{Conf_{n,m}(\overline{\mathbb{H}})}{\mathbb{R}^+ \times \mathbb{R}}, \quad 2n+m \geq 2,$$

is a $2n+m-2$ -dimensional manifold. Maxim Kontsevich constructed in [Ko3] its compactification $\overline{C}_{n,m}(\mathbb{H})$ as a smooth manifold with corners, and used it to construct an explicit $\mathcal{H}olie_2$ quasi-isomorphism of dg Lie algebras (for any $n \in \mathbb{N}$),

$$\mathcal{F}^K : (\mathcal{T}_{poly}(\mathbb{R}^n), [\ , \]_S) \longrightarrow (C^\bullet(\mathcal{O}_{\mathbb{R}^n}, \mathcal{O}_{\mathbb{R}^n})[1], d_H, [\ , \]_G)$$

where $(C^\bullet(\mathcal{O}_{\mathbb{R}^n}, \mathcal{O}_{\mathbb{R}^n})[1], d_H)$ is the (degree shifted) Hochschild complex of the graded commutative algebra $\mathcal{O}_{\mathbb{R}^n} = \mathbb{K}[[x_1, \dots, x_n]]$ and $[\ , \]_G$ are the Gerstenhaber brackets. This quasi-isomorphism

$$(38) \quad \mathcal{F}^K = \left\{ \mathcal{F}_{k,l}^K : \otimes^k \mathcal{O}_{\mathbb{R}^n} \otimes^l \mathcal{T}_{poly}(\mathbb{R}^n) \longrightarrow \mathcal{O}_{\mathbb{R}^n} \right\}_{2k+l \geq 2}$$

is given explicitly by

$$\mathcal{F}_{k,l} = \sum_{\Gamma \in G_{k+l, l+2k-2}} \left(\int_{\overline{C}_{l,k}(\mathbb{H})} \bigwedge_{e \in E(\Gamma)} \nu_e^*(\omega_H) \right) \Phi_\Gamma$$

where

- $G_{k+l, l+2k-2}$ is the set of directed graphs with $k+l$ numbered vertices and $l+2k-2$ edges such that the vertices with labels in the range from 1 to k have no outgoing edges, and for any $\Gamma \in G_{k+l, l+2k-2}$ the associated operator $\Phi_\Gamma : \otimes^k \mathcal{O}_{\mathbb{R}^n} \otimes^l \mathcal{T}_{poly}(\mathbb{R}^n) \longrightarrow \mathcal{O}_{\mathbb{R}^n}$ is given explicitly in [Ko3];
- for an edge $e \in \Gamma$ connecting a vertex with label i to the vertex labelled j

$$\nu_e : \overline{C}_{l,k}(\mathbb{H}) \rightarrow \overline{C}_{2,0}(\mathbb{H})$$

is the map forgetting all the points in the configuration space except z_i and z_j ;

- ω_H is a smooth 1-form on $\overline{C}_{2,0}(\mathbb{H})$ given explicitly by

$$\omega_H(z_i, z_j) = \frac{1}{2\pi} d \operatorname{Arg} \frac{z_i - z_j}{\overline{z}_i - \overline{z}_j}$$

4.2. A new explicit formula for the formality map. Note that the 1-form (cf. (22))

$$\omega_g(z_i, z_j) = g \left(\frac{\bar{z}_j - \bar{z}_i}{|z_i - z_j|} \right) d\text{Arg}(\bar{z}_j - \bar{z}_i)$$

is well defined on $\overline{\mathcal{C}}_{2,0}(\mathbb{H})$ so that it makes sense to consider a collection of maps $\bar{\mathcal{F}} = \{\bar{\mathcal{F}}_{k,l}\}_{2k+l \geq 2}$ as in (38) with

$$(39) \quad \bar{\mathcal{F}}_{k,l} := \sum_{\Gamma \in \mathcal{G}_{k+l, l+2k-2}} \left(\int_{\overline{\mathcal{C}}_{l,k}(\mathbb{H})} \bigwedge_{e \in E(\Gamma)} \nu_e^*(\omega_g) \right) \Phi_\Gamma.$$

The propagator ω_g does *not* satisfy Kontsevich's Vanishing Lemma 6.4 in [Ko3] so that many graphs Γ have non-trivial weights on the strata corresponding to groups of points collapsing to a point inside \mathbb{H} ; however all such graphs Γ are easy to describe — they are precisely the ones which generate the Kontsevich-Shoikhet $\mathcal{H}olie_2$ structure $\{[\cdot, \dots, \cdot]_{2p}\}_{p \geq 1}$ in $\mathcal{T}_{poly}(\mathbb{R}^n)$ so that Kontsevich's arguments lead us to the following

4.2.1. Proposition [B]. *The formulae (39) provide us with an explicit $\mathcal{H}olie_2$ quasi-isomorphism of $\mathcal{H}olie_2$ algebras*

$$(40) \quad \bar{\mathcal{F}} : (\mathcal{T}_{poly}(\mathbb{R}^n), \{[\cdot, \dots, \cdot]_{2p}\}_{p \geq 1}) \longrightarrow (C^\bullet(\mathcal{O}_{\mathbb{R}^n}, \mathcal{O}_{\mathbb{R}^n})[1], d_H, [\cdot, \cdot]_G).$$

Moreover, this quasi-isomorphism holds true in infinite dimensions, i.e. in the limit $n \rightarrow +\infty$.

Proof. It remains to show the last claim about the limit $n \rightarrow +\infty$. However it is obvious as the only graphs Γ which can give a non-trivial contribution into the formula (39) are *oriented* graphs, i.e. the ones which have no closed paths of directed edges. \square

The above formulae are transcendental, i.e. involve an integration over configuration spaces. However this $\mathcal{H}olie_2$ quasi-isomorphism can be constructed by a trivial (in the sense, independent of the choice of an associator) induction [W3, B].

4.2.2. Theorem. *For any n (including the limit $n \rightarrow +\infty$) there is, up to homotopy equivalence, a unique $\mathcal{H}olie_2$ quasi-isomorphism of $\mathcal{H}olie_2$ algebras as in (40).*

We refer to [W3] and [B] for two different proofs of this Theorem.

Now we can assemble the previous results into a new proof of the Kontsevich formality theorem which gives us also an new explicit formula for such a formality map (*not* involving the 2-dimensional hyperbolic geometry).

4.2.3. Kontsevich Formality Theorem. *For finite natural number n there is a $\mathcal{H}olie_2$ quasi-isomorphism of dg Lie algebras*

$$\mathcal{F} : (\mathcal{T}_{poly}(\mathbb{R}^n), [\cdot, \cdot]_S) \longrightarrow (C^\bullet(\mathcal{O}_{\mathbb{R}^n}, \mathcal{O}_{\mathbb{R}^n})[1], d_H, [\cdot, \cdot]_G)$$

Proof. Let g be an arbitrary smooth function on the circle S^1 with compact support in the upper half of S^1 and normalized so that $\int_{S^1} g \text{Vol}_{S^1} = 1$. Then there is an associated $\mathcal{H}olie_2$ isomorphism of $\mathcal{H}olie_2$ algebras

$$F : (\mathcal{T}_{poly}(\mathbb{R}^n), [\cdot, \cdot]_S) \longrightarrow (\mathcal{T}_{poly}(\mathbb{R}^n), [\cdot, \dots, \cdot]_{2p}, p \geq 1)$$

given explicitly by formulae (33), and a quasi-isomorphism of $\mathcal{H}olie_2$ algebras (40) given by explicit formulae (39). Hence we obtain the required $\mathcal{H}olie_2$ quasi-isomorphism as the composition

$$(41) \quad \mathcal{F} : (\mathcal{T}_{poly}(\mathbb{R}^n), [\cdot, \cdot]_S) \xrightarrow{F} (\mathcal{T}_{poly}(\mathbb{R}^n), [\cdot, \dots, \cdot]_{2p}, p \geq 1) \xrightarrow{\bar{\mathcal{F}}} (C^\bullet(\mathcal{O}_{\mathbb{R}^n}, \mathcal{O}_{\mathbb{R}^n})[1], d_H, [\cdot, \cdot]_G)$$

which is also given by explicit formulae with weights obtained from integrations on two different families of configuration spaces. \square

It was proven in [Do, W2] that the set of homotopy classes of universal formality maps $\{\mathcal{F}\}$ can be identified with the set of Drinfeld associators, i.e. it is a torsor over the Grothendieck-Teichmüller group GRT . It follows from Theorem 3.4.1 for $d = 2$ that every such a quasi-isomorphism can be split as the composition (41) with, by Theorem 4.2.2, the map $\bar{\mathcal{F}}$ being unique (up to homotopy). Hence we obtain the following result.

4.2.4. Corollary. *The set of homotopy classes of universal $\mathcal{H}olie_2$ isomorphisms*

$$F : (\mathcal{T}_{poly}(\mathbb{R}^n), [\ , \]_S) \longrightarrow (\mathcal{T}_{poly}(\mathbb{R}^n), [\ , \dots, \]_{2p}, p \geq 1), \quad \forall n \in \mathbb{N},$$

can be identified with the set of Drinfeld associators, i.e. it is a torsor over the Grothendieck-Teichmüller group GRT_1 .

We conclude that a construction of a non-commutative associative star product in $\mathcal{O}_{\mathbb{R}^n}$ out of an arbitrary ordinary Poisson structure π can be split in two steps:

STEP 1 Associate to π a quantizable Poisson structure π^\diamond . This step is most non-trivial and requires a choice of an associator; it can be given by an explicit formula (36).

STEP 2 Construct a star product in $\mathcal{O}_{\mathbb{R}^n}$ using the unique (up to homotopy) quantization formulae (39).

We shall use a similar procedure below to obtain explicit and relatively simple formulae for the universal deformation quantization of arbitrary finite-dimensional Lie bialgebras.

5. Props governing associative bialgebras, Lie bialgebras and the formality maps

5.1. Prop of associative bialgebras and its minimal resolution. A prop $\mathcal{A}ssb$ governing associative bialgebras is the quotient,

$$\mathcal{A}ssb := \mathcal{F}ree\langle A_0 \rangle / (R)$$

of the free prop $\mathcal{F}ree\langle A_0 \rangle$ generated by an \mathbb{S} -bimodule $A_0 = \{A_0(m, n)\}^3$,

$$A_0(m, n) := \begin{cases} \mathbb{K}[\mathbb{S}_2] \otimes \mathbb{1}_1 \equiv \text{span} \left\langle \begin{array}{c} 1 \quad 2 \\ \diagdown \quad \diagup \\ \circ \\ \vdots \\ 1 \end{array}, \begin{array}{c} 2 \quad 1 \\ \diagdown \quad \diagup \\ \circ \\ \vdots \\ 1 \end{array} \right\rangle & \text{if } m = 2, n = 1, \\ \mathbb{1}_1 \otimes \mathbb{K}[\mathbb{S}_2] \equiv \text{span} \left\langle \begin{array}{c} 1 \\ \vdots \\ \circ \\ \diagup \quad \diagdown \\ 1 \quad 2 \end{array}, \begin{array}{c} 1 \\ \vdots \\ \circ \\ \diagup \quad \diagdown \\ 2 \quad 1 \end{array} \right\rangle & \text{if } m = 1, n = 2, \\ 0 & \text{otherwise} \end{cases}$$

modulo the ideal generated by relations

$$(42) \quad R : \left\{ \begin{array}{l} \begin{array}{c} 1 \quad 2 \\ \diagdown \quad \diagup \\ \circ \\ \vdots \\ 3 \end{array} - \begin{array}{c} 2 \quad 3 \\ \diagdown \quad \diagup \\ \circ \\ \vdots \\ 1 \end{array} = 0, \quad \begin{array}{c} 1 \quad 3 \\ \diagdown \quad \diagup \\ \circ \\ \vdots \\ 2 \end{array} - \begin{array}{c} 1 \quad 2 \\ \diagdown \quad \diagup \\ \circ \\ \vdots \\ 3 \end{array} = 0, \quad \begin{array}{c} 1 \quad 2 \\ \diagdown \quad \diagup \\ \circ \\ \vdots \\ 1 \end{array} - \begin{array}{c} 1 \quad 2 \\ \diagdown \quad \diagup \\ \circ \\ \vdots \\ 1 \end{array} = 0 \end{array} \right.$$

Note that the relations are not quadratic (it is proven, however, in [MV] that $\mathcal{A}ssb$ is *homotopy Koszul*). A minimal resolution, $(\mathcal{A}ssb_\infty, \delta)$ of $\mathcal{A}ssb$ exists [Ma1] and is generated by an \mathbb{S} -bimodule $A = \{A(m, n)\}_{m, n \geq 1, m+n \geq 3}$,

$$A(m, n) := \mathbb{K}[\mathbb{S}_m] \otimes \mathbb{K}[\mathbb{S}_n][m+n-3] = \text{span} \left\langle \begin{array}{c} \tau(1) \tau(2) \dots \tau(m) \\ \diagdown \quad \diagup \quad \dots \quad \diagdown \quad \diagup \\ \circ \\ \vdots \\ \sigma(1) \sigma(2) \dots \sigma(n) \end{array} \right\rangle_{\substack{\tau \in \mathbb{S}_n \\ \sigma \in \mathbb{S}_m}},$$

The differential δ in $\mathcal{A}ssb_\infty$ is not quadratic, and its explicit value on generic (m, n) -corolla is not known at present, but we can (and will) assume from now on that δ preserves the *path grading* of $\mathcal{A}ssb_\infty$ (which associates to any decorated graph G from $\mathcal{A}ssb_\infty$ the total number of directed paths connecting input legs of G to the output ones).

³Here and everywhere all internal edges and legs in the graphical representation of an element of a prop are assumed to be implicitly oriented from the bottom of a graph to its top.

Let V be a \mathbb{Z} -graded vector space over a field \mathbb{K} of characteristic zero. The associated symmetric tensor algebra $\mathcal{O}_V := \odot^\bullet V = \bigoplus_{n \geq 0} \odot^n V$ comes equipped with the standard graded commutative and co-commutative bialgebra structure, i.e. there a non-trivial representation,

$$(43) \quad \rho_0 : \mathit{Assb} \longrightarrow \mathit{End}_{\mathcal{O}_V}.$$

According to [MV], the (extended) deformation complex

$$C_{GS}^\bullet(\mathcal{O}_V, \mathcal{O}_V) := \mathit{Def} \left(\mathit{Assb} \xrightarrow{\rho_0} \mathit{End}_{\mathcal{O}_V} \right) \simeq \prod_{m, n \geq 1} \mathit{Hom}(\mathcal{O}_V^{\otimes m}, \mathcal{O}_V^{\otimes n})[2 - m - n]$$

and its polydifferential subcomplex $C_{poly}^\bullet(\mathcal{O}_V, \mathcal{O}_V)$ come equipped with a $\mathcal{L}ie_\infty$ algebra structure, $\{\mu_n : \wedge^n C_{GS}^\bullet(\mathcal{O}_V, \mathcal{O}_V) \longrightarrow C_{GS}^\bullet(\mathcal{O}_V, \mathcal{O}_V)[2 - n]\}_{n \geq 1}$, such that μ_1 coincides precisely with the Gerstenhaber-Shack differential [GS]. According to [GS], the cohomology of the complex $(C_{GS}^\bullet(\mathcal{O}_V, \mathcal{O}_V), \mu_1)$ is precisely the deformation complex

$$\mathfrak{g}_V := \mathit{Def}(\mathcal{L}ieb \xrightarrow{0} \mathit{End}_V)$$

controlling deformations of the zero morphism $0 : \mathcal{L}ieb \rightarrow \mathit{End}_V$, where $\mathcal{L}ieb$ is the prop of Lie bialgebras which we discuss below.

5.2. Prop governing Lie bialgebras and its minimal resolution. The prop $\mathcal{L}ieb$ is defined [Dr] as a quotient,

$$\mathcal{L}ieb := \mathit{Free}\langle E_0 \rangle / (R)$$

of the free prop generated by an \mathbb{S} -bimodule $E_0 = \{E_0(m, n)\}$,

$$(44) \quad E_0(m, n) := \begin{cases} \mathit{sgn}_2 \otimes \mathbb{1}_1 \equiv \mathit{span} \left\langle \begin{array}{c} 1 \quad 2 \\ \diagdown \quad / \\ \bullet \\ / \quad \diagdown \\ 1 \end{array} \right\rangle = - \left\langle \begin{array}{c} 2 \quad 1 \\ \diagdown \quad / \\ \bullet \\ / \quad \diagdown \\ 1 \end{array} \right\rangle & \text{if } m = 2, n = 1, \\ \mathbb{1}_1 \otimes \mathit{sgn}_2 \equiv \mathit{span} \left\langle \begin{array}{c} 1 \\ \diagdown \quad / \\ \bullet \\ / \quad \diagdown \\ 1 \quad 2 \end{array} \right\rangle = - \left\langle \begin{array}{c} 1 \\ \diagdown \quad / \\ \bullet \\ / \quad \diagdown \\ 2 \quad 1 \end{array} \right\rangle & \text{if } m = 1, n = 2, \\ 0 & \text{otherwise} \end{cases}$$

modulo the ideal generated by the following relations

$$(45) \quad R : \left\{ \begin{array}{l} \begin{array}{c} 1 \quad 2 \\ \diagdown \quad / \\ \bullet \\ / \quad \diagdown \\ 3 \end{array} + \begin{array}{c} 3 \quad 1 \\ \diagdown \quad / \\ \bullet \\ / \quad \diagdown \\ 2 \end{array} + \begin{array}{c} 2 \quad 3 \\ \diagdown \quad / \\ \bullet \\ / \quad \diagdown \\ 1 \end{array} = 0, \quad \begin{array}{c} 1 \\ \diagdown \quad / \\ \bullet \\ / \quad \diagdown \\ 1 \quad 2 \quad 3 \end{array} + \begin{array}{c} 1 \\ \diagdown \quad / \\ \bullet \\ / \quad \diagdown \\ 3 \quad 1 \quad 2 \end{array} + \begin{array}{c} 1 \\ \diagdown \quad / \\ \bullet \\ / \quad \diagdown \\ 2 \quad 3 \quad 1 \end{array} = 0 \\ \begin{array}{c} 1 \quad 2 \\ \diagdown \quad / \\ \bullet \\ / \quad \diagdown \\ 1 \quad 2 \end{array} - \begin{array}{c} 1 \quad 2 \\ \diagdown \quad / \\ \bullet \\ / \quad \diagdown \\ 1 \quad 2 \end{array} + \begin{array}{c} 1 \quad 2 \\ \diagdown \quad / \\ \bullet \\ / \quad \diagdown \\ 2 \quad 1 \end{array} - \begin{array}{c} 2 \quad 1 \\ \diagdown \quad / \\ \bullet \\ / \quad \diagdown \\ 2 \quad 1 \end{array} + \begin{array}{c} 2 \quad 1 \\ \diagdown \quad / \\ \bullet \\ / \quad \diagdown \\ 1 \quad 2 \end{array} = 0 \end{array} \right.$$

Its minimal resolution, $\mathcal{L}ieb_\infty^{\min}$, is a dg free prop,

$$\mathcal{L}ieb_\infty^{\min} = \mathit{Free}\langle E \rangle,$$

generated by the \mathbb{S} -bimodule $E = \{E(m, n)\}_{m, n \geq 1, m+n \geq 3}$,

$$(46) \quad E(m, n) := \mathit{sgn}_m \otimes \mathit{sgn}_n[m + n - 3] = \mathit{span} \left\langle \begin{array}{c} 1 \quad 2 \quad \dots \quad m-1 \quad m \\ \diagdown \quad \diagup \quad \diagdown \quad \diagup \quad \dots \quad \diagdown \quad \diagup \\ \bullet \\ \diagup \quad \diagdown \quad \diagup \quad \diagdown \quad \dots \quad \diagup \quad \diagdown \\ 1 \quad 2 \quad \dots \quad n-1 \quad n \end{array} \right\rangle,$$

and with the differential given on generating corollas by [MaVo, V]

$$(47) \quad \delta \begin{array}{c} 1 \quad 2 \quad \dots \quad m-1 \quad m \\ \diagdown \quad \diagup \quad \diagdown \quad \diagup \quad \dots \quad \diagdown \quad \diagup \\ \bullet \\ \diagup \quad \diagdown \quad \diagup \quad \diagdown \quad \dots \quad \diagup \quad \diagdown \\ 1 \quad 2 \quad \dots \quad n-1 \quad n \end{array} = \sum_{\substack{[1, \dots, m] = I_1 \sqcup I_2 \\ |I_1| \geq 0, |I_2| \geq 1}} \sum_{\substack{[1, \dots, n] = J_1 \sqcup J_2 \\ |J_1| \geq 1, |J_2| \geq 1}} (-1)^{\sigma(I_1 \sqcup I_2) + |I_1||I_2| + |J_1||J_2|} \begin{array}{c} \overbrace{\begin{array}{c} \dots \\ \diagdown \quad \diagup \\ \bullet \\ \diagup \quad \diagdown \\ \dots \end{array}}^{I_2} \\ \overbrace{\begin{array}{c} \dots \\ \diagdown \quad \diagup \\ \bullet \\ \diagup \quad \diagdown \\ \dots \end{array}}^{I_1} \\ \underbrace{\begin{array}{c} \dots \\ \diagdown \quad \diagup \\ \bullet \\ \diagup \quad \diagdown \\ \dots \end{array}}_{J_1} \quad \underbrace{\begin{array}{c} \dots \\ \diagdown \quad \diagup \\ \bullet \\ \diagup \quad \diagdown \\ \dots \end{array}}_{J_2} \end{array}$$

where $\sigma(I_1 \sqcup I_2)$ and $\sigma(J_1 \sqcup J_2)$ are the signs of the shuffles $[1, \dots, m] \rightarrow I_1 \sqcup I_2$ and, respectively, $[1, \dots, n] \rightarrow J_1 \sqcup J_2$.

Let V be a dg vector space. According to the general theory [MV], there is a one-to-one correspondence between the set of representations, $\{\rho : \mathcal{L}ieb_\infty^{\min} \rightarrow \mathcal{E}nd_V\}$, and the set of Maurer-Cartan elements in the dg Lie algebra

$$(48) \quad \text{Def}(\mathcal{L}ieb_\infty^{\min} \xrightarrow{0} \mathcal{E}nd_V) \simeq \prod_{m,n \geq 1} \wedge^m V^* \otimes \wedge^n V[2-m-n] = \prod_{m,n \geq 1} \odot^m(V^*[-1]) \otimes \odot^n(V[-1])[2] =: \mathfrak{g}_V$$

controlling deformations of the zero map $\mathcal{L}ieb_\infty \xrightarrow{0} \mathcal{E}nd_V$. The differential in \mathfrak{g}_V is induced by the differential in V while the Lie bracket can be described explicitly as follows. First one notices that the completed graded vector space

$$\mathfrak{g}_V[-2] = \prod_{m,n \geq 1} \odot^m(V^*[-1]) \otimes \odot^n(V[-1]) = \widehat{\odot^{\bullet \geq 1}}(V^*[-1]) \oplus V[-1]$$

is naturally a 3-algebra with degree -2 Lie brackets, $\{ , \}$, given on generators by

$$\{sv, sw\} = 0, \quad \{s\alpha, s\beta\} = 0, \quad \{s\alpha, sv\} = \langle \alpha, v \rangle, \quad \forall v, w \in V, \alpha, \beta \in V^*.$$

where $s : V \rightarrow V[-1]$ and $s : V^* \rightarrow V^*[-1]$ are natural isomorphisms. Maurer-Cartan elements in \mathfrak{g}_V , that is degree 3 elements ν satisfying the equation

$$\{\nu, \nu\} = 0,$$

are in 1-1 correspondence with representations $\nu : \mathcal{L}ieb_\infty \rightarrow \mathcal{E}nd_V$. Such elements satisfying the condition

$$\nu \in \odot^2(V^*[-1]) \otimes V[-1] \oplus V^*[-1] \otimes \odot^2(V[-1])$$

are precisely Lie bialgebra structures in V .

The properads $\mathcal{L}ieb$ and $\mathcal{L}ieb_\infty^{\min}$ admit filtrations by the number of vertices and we denote by $\widehat{\mathcal{L}ieb}$ and $\widehat{\mathcal{L}ieb}_\infty^{\min}$ their completions with respect to these filtrations.

5.3. Formality maps as morphisms of props. We introduced in [MW2] an endofunctor \mathcal{D} in the category of augmented props with the property that for any representation of a prop \mathcal{P} in a vector space V the associated prop $\mathcal{D}\mathcal{P}$ admits an induced representation on the graded commutative algebra $\odot^\bullet V$ given in terms of polydifferential operators. More, we proved that

- (i) For any choice of a Drinfeld associator \mathfrak{A} there is an associated highly non-trivial (in the sense that it is non-zero on every generator of $\mathcal{A}ssb_\infty$, see formula (51) below) morphism of dg props,

$$(49) \quad F_{\mathfrak{A}} : \mathcal{A}ssb_\infty \longrightarrow \mathcal{D}\widehat{\mathcal{L}ieb}_\infty^{\min}.$$

where $\mathcal{A}ssb_\infty$ stands for a minimal resolution of the prop of associative bialgebras, and the construction of the polydifferential prop $\mathcal{D}\widehat{\mathcal{L}ieb}_\infty^{\min}$ out of $\widehat{\mathcal{L}ieb}_\infty^{\min}$ is explained below.

- (ii) For any graded vector space V , each morphism $F_{\mathfrak{A}}$ induces a $\mathcal{L}ie_\infty$ quasi-isomorphism (called a *formality map*) between the dg $\mathcal{L}ie_\infty$ algebra

$$C_{GS}^\bullet(\mathcal{O}_V, \mathcal{O}_V) = \text{Def}(\mathcal{A}ssb_\infty \xrightarrow{\rho_0} \mathcal{E}nd_{\mathcal{O}_V})$$

controlling deformations of the standard graded commutative and co-commutative bialgebra structure ρ_0 in \mathcal{O}_V , and the Lie algebra

$$\mathfrak{g}_V = \text{Def}(\mathcal{L}ieb \xrightarrow{0} \mathcal{E}nd_V)$$

controlling deformations of the zero morphism $0 : \mathcal{L}ieb \rightarrow \mathcal{E}nd_V$.

- (iii) For any formality morphism $F_{\mathfrak{A}}$ there is a canonical morphism of complexes

$$\text{fGC}_3^{or} \longrightarrow \text{Def}\left(\mathcal{A}ssb_\infty \xrightarrow{F_{\mathfrak{A}}} \mathcal{D}\widehat{\mathcal{L}ieb}_\infty^{\min}\right)$$

which is a quasi-isomorphism up to one class corresponding to the standard rescaling automorphism of the prop of Lie bialgebras $\mathcal{L}ieb$.

- (iv) The set of homotopy classes of universal formality maps as in (49) can be identified with the set of Drinfeld associators. In particular, the Grothendieck-Teichmüller group $GRT = GRT_1 \rtimes \mathbb{K}^*$ acts faithfully and transitively on such universal formality maps.

In the proof of item (i) in [MW2] we used the Etingof-Kazhdan theorem [EK] which says that any Lie bialgebra can deformation quantized in the sense explained by Drinfeld in [Dr], and which can be reformulated in our language as a morphism of props

$$f_{\mathfrak{A}} : Assb \longrightarrow \widehat{\mathcal{DLieb}}$$

satisfying certain non-triviality condition (see below). This morphism gives us universal quantizations of arbitrary, possibly infinitely dimensional, Lie bialgebras. If one is interested in universal quantization of *finite-dimensional* Lie bialgebras only, then the above morphism should be replaced by a map

$$f^{\circ} : Assb \longrightarrow \widehat{\mathcal{DLieb}}^{\circ}$$

to the polydifferential extension of the *wheeled* closure $\widehat{\mathcal{L}ieb}^{\circ}$ (see [MMS]) of the prop $\widehat{\mathcal{L}ieb}$. The morphism $f_{\mathfrak{A}}$ implies the morphism f° due to the canonical injection $\widehat{\mathcal{DLieb}} \rightarrow \widehat{\mathcal{DLieb}}^{\circ}$, but not vice versa. In this paper we show a new proof of the Etingof-Kazhdan theorem for finite-dimensional Lie bialgebras by giving an explicit formula for the morphism f° above. We also show that the morphism f° can be lifted by a trivial induction to a morphism of dg props

$$(50) \quad F^{\circ} : Assb_{\infty} \longrightarrow \widehat{\mathcal{DLieb}}_{\infty}^{\min, \circ}$$

satisfying the conditions

$$(51) \quad \pi_1 \circ F^{\circ} \left(\begin{array}{c} \overbrace{\text{graph}}^m \\ \text{graph} \\ \underbrace{\text{graph}}_n \end{array} \right) = \lambda \begin{array}{c} \overbrace{\text{graph}}^m \\ \text{graph} \\ \underbrace{\text{graph}}_n \end{array} \quad \text{for some non-zero } \lambda \in \mathbb{R},$$

for all $m + n \geq 3, m, n \geq 1$; here π_1 is the projection to the vector subspace in $\widehat{\mathcal{L}ieb}_{\infty}^{\min, \circ}$ spanned by graphs with precisely one black vertex. Moreover, we conjecture an explicit formula for such an extension F° .

Morphisms of dg props (50) satisfying the condition (51) can be called *formality morphisms in finite dimensions* as every such a morphism gives rise to a quasi-isomorphism of $\mathcal{L}ie_{\infty}$ -algebras introduced in the item (ii) above, but only for *finite-dimensional* graded vector spaces V (cf. [MW2]).

5.4. Polydifferential functor. We refer to [MW2] for a detailed definition of the endofunctor \mathcal{D} . In this paper we apply this functor to the props $\widehat{\mathcal{L}ieb}$ and $\widehat{\mathcal{L}ieb}^{\min}$, their wheeled closures $\widehat{\mathcal{L}ieb}^{\circ}$, $\widehat{\mathcal{L}ieb}_{\infty}^{\min, \circ}$, and their quantized versions $\widehat{\mathcal{L}ieb}^{\text{quant}}$ and $\widehat{\mathcal{L}ieb}_{\infty}^{\text{quant}}$. It is enough to explain the action of \mathcal{D} on the prop $\widehat{\mathcal{L}ieb}_{\infty}^{\min}$, the other cases being completely analogous.

Roughly speaking, $\widehat{\mathcal{DLieb}}_{\infty}^{\min}$ is spanned as a vector space by graphs from $\widehat{\mathcal{L}ieb}_{\infty}^{\min}$ whose input and output legs are labeled by *not necessarily different integers*; input legs labelled by the same integer i we show as attached to a new white *in-vertex* to which we assign label i ; the same procedure applies to output legs giving us new white *out-vertices*. Moreover, we allow these new white in-vertices and out-vertices with no legs attached. For example,

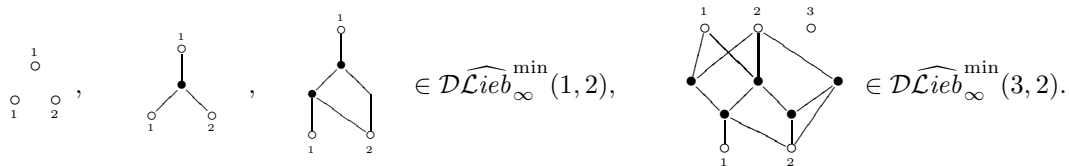

The linear span of graphs obtained in this way from elements of $\widehat{\mathcal{L}ieb}_{\infty}^{\min}$ with n in-vertices and m -out vertices is denoted by $\widehat{\mathcal{DLieb}}_{\infty}^{\min}(m, n)$; it is clearly an $\mathbb{S}_m^{\text{op}} \times \mathbb{S}_n$ module (with elements of the permutation groups acting by relabelling of the in- and out vertices). The \mathbb{S} -bimodule $\widehat{\mathcal{DLieb}}_{\infty}^{\min}(m, n)$ has a natural basis $\{\mathcal{G}_{k; m, n}\}$ where $\mathcal{G}_{k; m, n}$ is the set of oriented graphs with n labelled white in-vertices, m labelled white

out-vertices and k unlabeled internal (black) vertices and with no edges connecting in-vertices directly to out-vertices. Any graph $\Gamma \in \mathcal{G}_{k;m,n}$ has its set of edges $E(\Gamma)$ decomposed canonically into the disjoint union

$$E(\Gamma) = E_{int}(\Gamma) \amalg E_{in}(\Gamma) \amalg E_{out}(\Gamma)$$

where $E_{int}(\Gamma)$ is the subset of edges connecting two internal vertices, $E_{in}(\Gamma)$ is the subset of edges connecting in-vertices to internal ones, and $E_{out}(\Gamma)$ is the subset of edges connecting internal vertices to out-vertices. As a \mathbb{Z} -graded vector space $\widehat{\mathcal{DLieb}}_\infty(m, n)$ is defined by

$$\widehat{\mathcal{DLieb}}_\infty(m, n) = \prod_{k \geq 0} \mathbb{K}\langle \mathcal{G}_{k;m,n}^{or} \rangle$$

where a graph $\Gamma \in \mathcal{G}_{k;m,n}$ is assigned the following homological degree

$$|\Gamma| = 3|V_{int}(\Gamma)| - 2|E_{int}(\Gamma)| - |E_{in}(\Gamma)| - |E_{out}(\Gamma)|.$$

The horizontal composition in $\widehat{\mathcal{DLieb}}_\infty^{\min}$

$$\boxtimes : \widehat{\mathcal{DLieb}}_\infty^{\min}(m, n) \otimes \widehat{\mathcal{DLieb}}_\infty^{\min}(m', n') \longrightarrow \widehat{\mathcal{DLieb}}_\infty^{\min}(m+m', n+n')$$

$$\Gamma \otimes \Gamma' \longrightarrow \Gamma \boxtimes \Gamma'$$

is given just by taking the disjoint union of the graphs Γ and Γ' and relabelling in- and out-vertices of the graph Γ' accordingly. The vertical composition,

$$\circ : \widehat{\mathcal{DLieb}}_\infty^{\min}(m, n) \otimes \widehat{\mathcal{DLieb}}_\infty^{\min}(n, l) \longrightarrow \widehat{\mathcal{DLieb}}_\infty^{\min}(m, l)$$

$$\Gamma \otimes \Gamma' \longrightarrow \Gamma \circ \Gamma',$$

is given by the following two step procedure: (a) erase all n in-vertices of Γ and all n out-vertices of Γ' , (b) take a sum over all possible ways of attaching the hanging out-legs of Γ to hanging in-legs of Γ' (with the same numerical label) as well as to the out-vertices of Γ' , and also attaching the remaining in-legs of Γ' to in-vertices of Γ (see §2.2.2 in [MW2] for more details). For example, a vertical composition of the following two graphs,

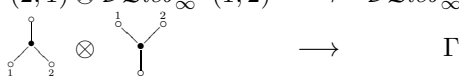
$$\circ : \widehat{\mathcal{DLieb}}_\infty^{\min}(2, 1) \otimes \widehat{\mathcal{DLieb}}_\infty^{\min}(1, 2) \longrightarrow \widehat{\mathcal{DLieb}}_\infty^{\min}(2, 2)$$

is given by the following sum

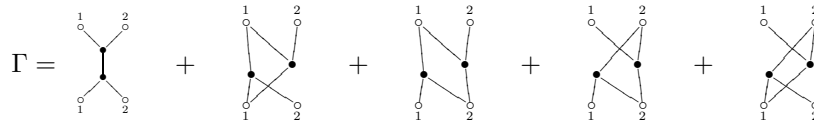

The differential δ in $\widehat{\mathcal{DLieb}}_\infty$ acts only on black vertices and splits them as shown in (47).

For any given representation $\nu : \mathcal{Lieb}_\infty^{\min} \rightarrow \mathcal{E}nd_V$, i.e. for any Maurer-Cartan element ν in the Lie algebra \mathfrak{g}_V , there is an associated representation $\rho_\nu : \widehat{\mathcal{DLieb}}_\infty \rightarrow \mathcal{E}nd_{\mathcal{O}_V}$ in $\mathcal{O}_V = \odot^\bullet V$ given in terms of polydifferential operators as explained in full details in §5.4 of [MW2]. If, for example, $V = \mathbb{R}^n$ with the standard basis denoted by (x_1, \dots, x_n) (so that $\mathcal{O}_V = \mathbb{K}[x_1, \dots, x_n]$), and ν is a Lie bialgebra structure in V with the structure constants for the Lie bracket and, respectively, Lie cobracket given by

$$[x_i, x_j] =: \sum_{k=1}^n C_{ij}^k x_k, \quad \Delta(x_k) = \sum_{i,j=1}^n \Phi_k^{ij} x_i \wedge x_j$$

then one has,

$$\rho^\nu \left(\begin{array}{c} \circ \\ \diagup \quad \diagdown \\ \circ \quad \circ \\ 1 \quad 2 \end{array} \right) : \mathcal{O}_V \otimes \mathcal{O}_V \longrightarrow \mathcal{O}_V$$

$$f_1 \otimes f_2 \longrightarrow \sum_{i,j,k=1}^n x_k C_{ij}^k \frac{\partial f_1}{\partial x_i} \frac{\partial f_2}{\partial x_j}$$

$$\rho^\nu \left(\begin{array}{c} 1 \quad 2 \\ \circ \quad \circ \\ | \quad | \\ \circ \quad \circ \\ 1 \quad 2 \end{array} \right) : \mathcal{O}_V \longrightarrow \mathcal{O}_V \otimes \mathcal{O}_V$$

$$f \longrightarrow \sum_{i,j,k,m,n=1}^n (x_m \otimes x_n) \cdot \Phi_k^{mn} C_{ij}^k \Delta \left(\frac{\partial f_1}{\partial x_i} \frac{\partial f_2}{\partial x_j} \right)$$

while $\rho^\nu \left(\begin{array}{c} \circ \\ | \\ \circ \quad \circ \\ 1 \quad 2 \end{array} \right) : \mathcal{O}_V^{\otimes 2} \rightarrow \mathcal{O}_V$ and $\Delta := \rho^\nu \left(\begin{array}{c} 1 \quad 2 \\ \circ \quad \circ \end{array} \right) : \mathcal{O}_V \rightarrow \mathcal{O}_V^{\otimes 2}$ are the standard commutative multiplication and, respectively, co-commutative comultiplication in \mathcal{O}_V . Representations of the completed props $\widehat{\mathcal{L}ieb}$ and $\widehat{\mathcal{L}ieb}_\infty^{\min}$ (and hence of $\mathcal{D}\widehat{\mathcal{L}ieb}$ and $\mathcal{D}\widehat{\mathcal{L}ieb}_\infty^{\min}$) are considered in the subsection §5.5.4 below — they require an introduction of a formal parameter to insure convergence.

5.5. Properad of quantizable Lie bialgebras. Let us denote by $\widehat{\mathcal{L}ieb}_\infty$ the *non-differential* properad $\widehat{\mathcal{L}ieb}_\infty^{\min}$, i.e. the completed free properad generated by the same \mathbb{S} -bimodule E but with the differential set to zero. Let $\widehat{\mathcal{L}ieb}_\infty^+$ be the free extension of $\widehat{\mathcal{L}ieb}_\infty$ by one extra $(1, 1)$ generator $\begin{array}{c} | \\ \bullet \end{array}$ of homological degree one. In [MW1] (see formula (11) there) we constructed a map of Lie algebras

$$f : \text{dfGC}_3^{or} \longrightarrow \text{Der}(\widehat{\mathcal{L}ieb}_\infty^+)$$

$$\Gamma \longrightarrow \sum_{m,n \geq 1} \sum_{\substack{s:[n] \rightarrow V(\Gamma) \\ \hat{s}:[m] \rightarrow V(\Gamma)}} \begin{array}{c} \begin{array}{c} 1 \quad 2 \quad \dots \quad m \\ \diagdown \quad \diagup \quad \dots \quad \diagdown \quad \diagup \\ \Gamma \\ \diagup \quad \diagdown \quad \dots \quad \diagup \quad \diagdown \\ 1 \quad 2 \quad \dots \quad n \end{array} \end{array}$$

where the second sum in the r.h.s. is taken over all ways of attaching the incoming and outgoing legs to the graph Γ , and then setting to zero every resulting graph if it contains a vertex with valency ≤ 2 or with no input legs or no output legs (there is an implicit rule of signs in-built into this formula and its version in Proposition 5.5.2 below which is completely analogous to the one explained in §7 of [MaVo]). Here $\text{Der}(\widehat{\mathcal{L}ieb}_\infty^+)$ is the Lie algebra of continuous derivations of the topological properad $\widehat{\mathcal{L}ieb}_\infty^+$. Note that for many graphs $\Gamma \in \text{dfGC}_3^{or}$ the associated $(m = 1, n = 1)$ summand $\begin{array}{c} | \\ \Gamma \\ | \end{array}$ in $f(\Gamma)$ can be highly non-trivial, and this phenomenon explains the need for the extension $\widehat{\mathcal{L}ieb}_\infty \rightarrow \widehat{\mathcal{L}ieb}_\infty^+$ above.

If Υ is a Maurer-Cartan element in dfGC_3^{or} , then $f(\Upsilon)$ is a differential in $\widehat{\mathcal{L}ieb}_\infty^+$ which acts on the generating (m, n) -corolla as follows

$$f(\Upsilon) \left(\begin{array}{c} 1 \quad 2 \quad \dots \quad m-1 \quad m \\ \diagdown \quad \diagup \quad \dots \quad \diagdown \quad \diagup \\ \Upsilon \\ \diagup \quad \diagdown \quad \dots \quad \diagup \quad \diagdown \\ 1 \quad 2 \quad \dots \quad n-1 \quad n \end{array} \right) = \sum_{\substack{s:[n] \rightarrow V(\Gamma) \\ \hat{s}:[m] \rightarrow V(\Gamma)}} \begin{array}{c} \begin{array}{c} 1 \quad 2 \quad \dots \quad m \\ \diagdown \quad \diagup \quad \dots \quad \diagdown \quad \diagup \\ \Upsilon \\ \diagup \quad \diagdown \quad \dots \quad \diagup \quad \diagdown \\ 1 \quad 2 \quad \dots \quad n \end{array} \end{array}$$

If Υ is such that the summand $\begin{array}{c} | \\ \Upsilon \\ | \end{array}$ in $f(\Upsilon)$ contains at least one vertex of the form $\begin{array}{c} | \\ \bullet \end{array}$, then the ideal $I^+ \subset \widehat{\mathcal{L}ieb}_\infty^+$ generated by this extra generator $\begin{array}{c} | \\ \bullet \end{array}$ is respected by the differential $f(\Upsilon)$ so that the latter induces a differential in the quotient properad

$$\widehat{\mathcal{L}ieb}_\infty = \widehat{\mathcal{L}ieb}_\infty^+ / I^+.$$

For example, the standard Maurer-Cartan element

$$\Upsilon_S := \bullet \rightarrow \bullet$$

in dfGC_3^{or} does have this property as

$$\Upsilon_S = \begin{array}{c} | \\ \bullet \\ | \\ 1 \end{array}$$

and induces the standard differential δ in $\widehat{\mathcal{L}ieb}_\infty$ given by the formula (47).

Another interesting for us Maurer-Cartan element is given explicitly by (28). It was proven in Lemma **A.1** that every graph $\Gamma \in \hat{\mathbf{G}}_{4p+2,6p+1}$, $p \geq 2$, contributing into Υ^{ω_g} has at least 4 binary vertices so that again

$$\Upsilon^{\omega_g} = \begin{array}{c} 1 \\ | \\ \bullet \\ | \\ \bullet \\ | \\ 1 \end{array}$$

implying that Υ^{ω_g} induces the following differential in $\widehat{\mathcal{L}ieb}_\infty$

$$\delta^{\omega_g} = f(\Upsilon^{\omega_g}) \bmod I^+ = \delta + \sum_{p \geq 2} \sum_{\Gamma \in \hat{\mathbf{G}}_{4p+2,6p+1}^{or}} \sum_{\substack{m, n \geq 1 \\ m+n \geq 4}} \left(\int_{\overline{\mathcal{C}}_{4p+2}(\mathbb{R}^3)} \bigwedge_{e \in E(\Gamma)} \pi_e^*(\omega_g) \right) \sum_{\substack{s: [n] \rightarrow V(\Gamma) \\ \tilde{s}: [m] \rightarrow V(\Gamma)}} \begin{array}{c} 1 \quad 2 \quad \dots \quad m \\ \diagdown \quad \diagup \\ \Gamma \\ \diagup \quad \diagdown \\ 1 \quad 2 \quad \dots \quad n \end{array}.$$

As every graph in the sum over $p \geq 2$ has at least 4 bivalent vertices (see Appendix A), we have, in particular,

$$\delta^{\omega_g} \left(\begin{array}{c} 1 \quad 2 \\ \diagdown \quad \diagup \\ \bullet \\ \diagup \quad \diagdown \\ 1 \end{array} \right) = \delta \left(\begin{array}{c} 1 \quad 2 \\ \diagdown \quad \diagup \\ \bullet \\ \diagup \quad \diagdown \\ 1 \end{array} \right) = 0 \quad , \quad \delta^{\omega_g} \left(\begin{array}{c} 1 \\ | \\ \bullet \\ | \\ 1 \quad 2 \end{array} \right) = \delta \left(\begin{array}{c} 1 \\ | \\ \bullet \\ | \\ 1 \quad 2 \end{array} \right) = 0$$

The first differential δ makes $\widehat{\mathcal{L}ieb}_\infty$ into the standard minimal resolution of the completed properad $\widehat{\mathcal{L}ieb}$ of Lie bialgebras. The second differential δ^{ω_g} makes $\widehat{\mathcal{L}ieb}_\infty$ into a resolution of a properad $\widehat{\mathcal{L}ieb}^{\text{quant}}$ which we call the *properad of quantizable Lie bialgebras* and which can be defined as follows.

By contrast to $\widehat{\mathcal{L}ieb}_\infty^{\min} := (\widehat{\mathcal{L}ieb}_\infty, \delta)$, let us abbreviate from now on

$$\widehat{\mathcal{L}ieb}_\infty^{\text{quant}} := (\widehat{\mathcal{L}ieb}_\infty, \delta^{\omega_g})$$

Let J be the differential closure of the ideal in $\widehat{\mathcal{L}ieb}_\infty^{\text{quant}}$ generated by (m, n) -corollas with $m + n \geq 4$. The quotient

$$\widehat{\mathcal{L}ieb}^{\text{quant}} := \widehat{\mathcal{L}ieb}_\infty^{\text{quant}} / J$$

is a properad which is concentrated in homological degree zero, and which is generated by the \mathbb{S} -bimodule (44) modulo the following three relations,

$$\begin{aligned} 0 &= \begin{array}{c} 1 \quad 2 \\ \diagdown \quad \diagup \\ \bullet \\ \diagup \quad \diagdown \\ 1 \quad 2 \end{array} - \begin{array}{c} 2 \\ | \\ \bullet \\ | \\ 1 \quad 2 \end{array} + \begin{array}{c} 1 \quad 2 \\ \diagdown \quad \diagup \\ \bullet \\ \diagup \quad \diagdown \\ 2 \quad 1 \end{array} - \begin{array}{c} 2 \\ | \\ \bullet \\ | \\ 2 \quad 1 \end{array} + \begin{array}{c} 1 \\ | \\ \bullet \\ | \\ 2 \quad 1 \end{array} + \sum_{p \geq 2} \sum_{\Gamma \in \hat{\mathbf{G}}_{4p+2,6p+1}^{\leq 3}} \left(\int_{\overline{\mathcal{C}}_{4p+2}(\mathbb{R}^3)} \bigwedge_{e \in E(\Gamma)} \pi_e^*(\omega_g) \right) \sum_{\substack{s: [2] \rightarrow V(\Gamma) \\ \tilde{s}: [2] \rightarrow V(\Gamma)}} \begin{array}{c} 1 \quad 2 \\ \diagdown \quad \diagup \\ \Gamma \\ \diagup \quad \diagdown \\ 1 \quad 2 \end{array}, \\ 0 &= \begin{array}{c} 1 \\ | \\ \bullet \\ | \\ 1 \quad 2 \quad 3 \end{array} + \begin{array}{c} 2 \\ | \\ \bullet \\ | \\ 3 \quad 1 \quad 2 \end{array} + \begin{array}{c} 3 \\ | \\ \bullet \\ | \\ 2 \quad 3 \quad 1 \end{array} + \sum_{p \geq 2} \sum_{\Gamma \in \hat{\mathbf{G}}_{4p+2,6p+1}^{\leq 3}} \left(\int_{\overline{\mathcal{C}}_{4p+2}(\mathbb{R}^3)} \bigwedge_{e \in E(\Gamma)} \pi_e^*(\omega_g) \right) \sum_{\substack{s: [2] \rightarrow V(\Gamma) \\ \tilde{s}: [2] \rightarrow V(\Gamma)}} \begin{array}{c} 1 \\ | \\ \Gamma \\ | \\ 1 \quad 2 \quad 3 \end{array}, \\ 0 &= \begin{array}{c} 1 \quad 2 \\ \diagdown \quad \diagup \\ \bullet \\ \diagup \quad \diagdown \\ 1 \quad 3 \end{array} + \begin{array}{c} 3 \quad 1 \\ \diagdown \quad \diagup \\ \bullet \\ \diagup \quad \diagdown \\ 2 \quad 3 \end{array} + \begin{array}{c} 2 \quad 3 \\ \diagdown \quad \diagup \\ \bullet \\ \diagup \quad \diagdown \\ 1 \quad 2 \end{array} + \sum_{p \geq 2} \sum_{\Gamma \in \hat{\mathbf{G}}_{4p+2,6p+1}^{\leq 3}} \left(\int_{\overline{\mathcal{C}}_{4p+2}(\mathbb{R}^3)} \bigwedge_{e \in E(\Gamma)} \pi_e^*(\omega_g) \right) \sum_{\substack{s: [2] \rightarrow V(\Gamma) \\ \tilde{s}: [2] \rightarrow V(\Gamma)}} \begin{array}{c} 1 \quad 2 \quad 3 \\ \diagdown \quad \diagup \\ \Gamma \\ \diagup \quad \diagdown \\ 1 \end{array}, \end{aligned}$$

where $\hat{\mathbf{G}}_{4p+2,6p+1}^{\leq 3}$ is the subset of $\hat{\mathbf{G}}_{4p+2,6p+1}^{or}$ consisting of graphs with vertices of valency ≤ 3 (it was shown in Appendix A that such graphs have precisely 4 bivalent vertices which explains why there no other relations than the ones shown above).

5.5.1. Theorem. *The natural epimorphism of props*

$$\nu : \widehat{\mathcal{L}ieb}_\infty^{\text{quant}} \longrightarrow \widehat{\mathcal{L}ieb}^{\text{quant}}$$

is a quasi-isomorphism.

Proof. The morphism ν respects complete and exhaustive filtrations of both sides by the number of vertices, hence it induces a morphism of the associated spectral sequences,

$$\nu^r : \mathcal{E}^r \widehat{\mathcal{L}ieb}_\infty^{\text{quant}} \longrightarrow \mathcal{E}^r \widehat{\mathcal{L}ieb}^{\text{quant}}$$

The term $\mathcal{E}^0 \widehat{\mathcal{L}ieb}_\infty^{\text{quant}}$ has trivial differential, while the term $\mathcal{E}^1 \widehat{\mathcal{L}ieb}_\infty^{\text{quant}}$ can be identified with the dg prop $\widehat{\mathcal{L}ieb}_\infty^{\text{min}}$ so that $\mathcal{E}^2 \widehat{\mathcal{L}ieb}_\infty^{\text{quant}} = \widehat{\mathcal{L}ieb}$ as an \mathbb{S} -bimodule. On the other hand $\mathcal{E}^2 \widehat{\mathcal{L}ieb}^{\text{quant}}$ can also be identified with $\widehat{\mathcal{L}ieb}$ as an \mathbb{S} -bimodule. Hence the morphism ν^2 is an isomorphism so that, by the Eilenberg-Moore Comparison Theorem 5.5.11 (see §5.5 in [We]), the morphism ν is a quasi-isomorphism. \square

Note that graphs in (35) may contain closed paths of directed edges in general and hence belong to the graph complex dfGC_d rather than to $\text{dfGC}_d^{\text{or}}$. Therefore in order to see the meaning of Theorem 3.4.1 in terms of props one has to consider the wheeled closure [MMS] of the prop $\widehat{\mathcal{L}ieb}_\infty^{\text{min}}$ which we denote by $\widehat{\mathcal{L}ieb}_\infty^{\text{min}, \circ}$; by definition, it is generated by the same \mathbb{S} -bimodule (46) but now using directed graphs with possibly *closed* directed paths of internal edges.

Theorem 3.4.1 implies almost immediately the following

5.5.2. Proposition. *There is a morphism of dg props $\widehat{\mathcal{L}ieb}_\infty^{\text{quant}}$*

$$F : \widehat{\mathcal{L}ieb}_\infty^{\text{quant}} \longrightarrow \widehat{\mathcal{L}ieb}_\infty^{\text{min}, \circ}$$

given by the following transcendental formula (cf. (35))

$$(52) \quad F \left(\begin{array}{c} 1 \ 2 \ \dots \ m-1 \ m \\ \diagdown \ \diagup \ \dots \ \diagdown \ \diagup \\ \cdot \\ \diagup \ \diagdown \ \dots \ \diagup \ \diagdown \\ 1 \ 2 \ \dots \ n-1 \ n \end{array} \right) = \sum_{q \geq 0} \sum_{\Gamma \in \mathbf{G}_{1+4q, 6q}} \left(\int_{\overline{\mathcal{C}}_{1+4q}(\mathbb{R}^d)} \bigwedge_{e \in E(\Gamma)} \pi_e^*(\varpi_g) \right) \sum_{\substack{s: [n] \rightarrow V(\Gamma) \\ \tilde{s}: [m] \rightarrow V(\Gamma)}} \begin{array}{c} 1 \ 2 \ \dots \ m \\ \diagdown \ \diagup \ \dots \ \diagdown \ \diagup \\ \Gamma \\ \diagup \ \diagdown \ \dots \ \diagup \ \diagdown \\ 1 \ 2 \ \dots \ n \end{array}$$

where the third sum in the r.h.s. is taken over all ways of attaching the incoming and outgoing legs to the graph Γ , and we set to zero every resulting graph if it contains a vertex with valency < 3 or with no at least one incoming and at least one outgoing edge.

5.5.3. Corollary. *The explicit morphism F in Proposition 5.5.2 induces an explicit morphism $f : \widehat{\mathcal{L}ieb}_\infty^{\text{quant}} \rightarrow \widehat{\mathcal{L}ieb}_\infty^{\circ}$.*

5.5.4. Representations of $\widehat{\mathcal{L}ieb}_\infty^{\text{quant}}$ and quantizable Lie bialgebras. As properads $\widehat{\mathcal{L}ieb}_\infty^{\text{quant}}$ and $\widehat{\mathcal{L}ieb}_\infty^{\text{min}}$ are vertex completed one must be careful when defining their representations in a dg space V .

Let $F_p \widehat{\mathcal{L}ieb}_\infty^{\text{quant}}$, $F_p \widehat{\mathcal{L}ieb}_\infty^{\text{min}}$, $F_p \widehat{\mathcal{L}ieb}_\infty^{\text{quant}}$ and $F_p \widehat{\mathcal{L}ieb}$ be the sub-properads generated by graphs with $\geq p$ vertices, and let λ be a formal parameter of homological degree zero. By a representation of, say, $\widehat{\mathcal{L}ieb}_\infty^{\text{quant}}$ in a dg vector space V we mean a morphism of properads

$$\rho : \widehat{\mathcal{L}ieb}_\infty^{\text{quant}} \longrightarrow \mathcal{E}nd_V[[\lambda]]$$

such that $\rho(F_p \widehat{\mathcal{L}ieb}_\infty^{\text{quant}}) \subset \lambda^p \mathcal{E}nd_V[[\lambda]]$ where $\mathcal{E}nd_V[[\lambda]]$ is the properad of formal power series in λ with coefficients in $\mathcal{E}nd_V$, and $\lambda^p \mathcal{E}nd_V[[\lambda]] \subset \mathcal{E}nd_V[[\lambda]]$ is a sub-properad generated by formal power series which are divisible by λ^p . Representations of $\widehat{\mathcal{L}ieb}_\infty^{\text{quant}}$, $\widehat{\mathcal{L}ieb}_\infty^{\text{min}}$, $\widehat{\mathcal{L}ieb}$ and of their wheeled versions are defined similarly.

It is clear that there is a 1-1 correspondence between representations of $\widehat{\mathcal{L}ieb}_\infty^{\text{quant}}$ in V and elements $\pi^\diamond \in \mathfrak{g}_V[-2][[\lambda]] \simeq \mathbb{A}_3^{(n)}[[\lambda]]$ (for some n including the case $n = +\infty$) such that the equation holds

$$[\pi^\diamond, \pi^\diamond]_S + \sum_{p \geq 2} \frac{\lambda^{4p}}{(4p+2)!} \mu_{4p+2}^{\omega_g}(\pi^\diamond, \dots, \pi^\diamond) = 0.$$

As this equation involves only powers of λ^4 , it makes sense to introduce $\hbar := \lambda^4$ and consider a subclass of solutions π^\diamond which belong to $\mathbb{A}_3^{(n)}[[\hbar]]$; in the case $V = \mathbb{R}^n$ these are precisely *quantizable Lie bialgebra* structures introduced above.

In the next subsection we construct an explicit morphism of props

$$f^q : \mathcal{A}ssB \longrightarrow \mathcal{D}\widehat{\mathcal{L}ieb}^{\text{quant}}$$

and show that it lifts by a naive induction to a morphism of dg props

$$\mathcal{F}^q : \mathcal{A}ssb_\infty \longrightarrow \mathcal{D}\widehat{\mathcal{L}ieb}_\infty^{\text{quant}}$$

satisfying the boundary condition (51). Such a morphism composed with the explicit isomorphism $\mathcal{D}F : \mathcal{D}\widehat{\mathcal{L}ieb}_\infty^{\text{quant}} \longrightarrow \mathcal{D}\widehat{\mathcal{L}ieb}_\infty^{\text{min}, \circ}$ from Proposition 5.5.2, gives us the required formality map,

$$\mathcal{D}F \circ \mathcal{F}^q : \mathcal{A}ssb_\infty \longrightarrow \mathcal{D}\widehat{\mathcal{L}ieb}_\infty^{\text{min}, \circ}$$

for finite-dimensional Lie bialgebras.

5.6. Open problems. The prop $\widehat{\mathcal{L}ieb}^{\text{quant}}$ and the dg prop $\widehat{\mathcal{L}ieb}_\infty^{\text{quant}}$ have been defined with the help of explicit transcendental formulae. However it is very hard to compute the integrals given in that formulae. For example the weights of the graphs $\gamma_{10}^{2,2}$, $\gamma_{10}^{1,3}$ and $\gamma_{10}^{3,1}$ (the first possibly non-trivial contributions) introduced in the Appendix A involve integrals of top-degree differential forms over 24-dimensional configuration spaces. In principle all these weights might be zero so that $\widehat{\mathcal{L}ieb}_\infty^{\text{quant}}$ might be identical to $\widehat{\mathcal{L}ieb}_\infty^{\text{min}}$. If this is the case, then our explicit formulae for universal quantization of Lie bialgebras become even much simpler — the quantization job would be done solely by the map f^q given by the explicit formulae (57). We conjecture, however, that the situation is quite the opposite:

5.6.1. Conjectures. (i) *The set of homotopy classes of morphisms of dg props $F : \widehat{\mathcal{L}ieb}_\infty^{\text{quant}} \longrightarrow \widehat{\mathcal{L}ieb}_\infty^{\text{min}, \circ}$ is a torsor over the Grothendieck-Teichmuller group GRT.*

(ii) *The set of homotopy classes of morphisms of dg props $\mathcal{F}^q : \mathcal{A}ssb_\infty \longrightarrow \mathcal{D}\widehat{\mathcal{L}ieb}_\infty^{\text{quant}}$ consists of a single point.*

These are open problems which we hope to address in the future. Another open problem is to construct an *explicit* isomorphism of dg props

$$\widehat{\mathcal{L}ieb}_\infty^{\text{quant}} \longrightarrow \widehat{\mathcal{L}ieb}_\infty^{\text{min}},$$

i.e. to construct an analogue of our explicit morphism F in (52) which does *not* involve graphs with wheels.

6. An explicit formula for universal quantizations of Lie bialgebras

6.1. Kontsevich compactified configuration spaces. Let $\overline{\mathbb{H}} = \{z = x + it \in \mathbb{C} | t \geq 0\}$ be the closed upper-half plane. Its open subset $\{z = x + it \in \mathbb{C} | t > 0\}$ is denoted by \mathbb{H} ; we also consider $\partial\overline{\mathbb{H}} := \overline{\mathbb{H}} \setminus \mathbb{H} \simeq \mathbb{R}$. The group $G_2 := \mathbb{R}^+ \rtimes \mathbb{R}$ acts on $\overline{\mathbb{H}}$

$$\begin{aligned} G_2 \times \overline{\mathbb{H}} &\longrightarrow \overline{\mathbb{H}} \\ (\lambda \in \mathbb{R}^+, h \in \mathbb{R}) \times z &\longrightarrow \lambda z + h. \end{aligned}$$

Let A and I be some finite sets, and let

$$\text{Conf}_{A,I}(\overline{\mathbb{H}}) := \{f : A \hookrightarrow \mathbb{H}, i : I \hookrightarrow \partial\overline{\mathbb{H}}\}$$

be the configuration space of injections of A into the upper half-plane, and of I into the real line $\mathbb{R} \simeq \partial\overline{\mathbb{H}}$. This is a smooth manifold of dimension $2\#A + \#I$. The group G_2 acts naturally on it, $(f(A), i(I)) \rightarrow (\lambda f(A) + h, \lambda i(I) + h)$, and this action is free provided $2|A| + |I| \geq 2$. The quotient space

$$C_{A,I}(\mathbb{H}) := \text{Conf}_{A,I}(\overline{\mathbb{H}})/G_2$$

is a smooth manifold of dimension $2|A| + |I| - 2$. Kontsevich constructed in [Ko3] its compactification, $\overline{C}_{A,I}(\mathbb{H})$, which is a smooth manifold with corners, and which we use below for a construction of a new family of compactified configuration spaces. If $A = [k]$ and $I = [n]$, we abbreviate $C_{A,I}(\mathbb{H})$ to $C_{k,n}(\mathbb{H})$.

6.2. Configuration spaces of points in $\mathbb{R} \times \mathbb{R}$. Let $C_n(\mathbb{R})$, $n \geq 2$, be the configuration space of injections $\{p : [n] \rightarrow \mathbb{R}\}$ modulo the action of the group $\mathbb{R}^+ \ltimes \mathbb{R}$ sending an injection p into an injection $\lambda p + \nu$, $\lambda \in \mathbb{R}^+$, $\nu \in \mathbb{R}$. We remind in Appendix B its compactification $\overline{C}_n(\mathbb{R})$ which gives us a geometric realization (in the category of semialgebraic manifolds) of Jim Stasheff's *associahedra*.

Boris Shoikhet introduced in [Sh1] (with a reference to Maxim Kontsevich's informal suggestion) the configuration space $C_{m,n}(\mathbb{R} \times \mathbb{R})$ of pairs of injections $\{p' : [n] \rightarrow \mathbb{R}, [m] \rightarrow \mathbb{R}\}$, $m, n \geq 1$, $m + n \geq 3$, modulo the action of the group $\mathbb{R}^+ \ltimes \mathbb{R}^2$ sending a pair of injections (p', p'') into $(\lambda p' + \nu', \lambda^{-1} p'' + \nu'')$ for any $\lambda \in \mathbb{R}^+$, $\nu', \nu'' \in \mathbb{R}$. We remind its compactification $\overline{C}_{m,n}(\mathbb{R} \times \mathbb{R})$ in Appendix B, and also prove that the family of compactifications $\{\overline{C}_{m,n}(\mathbb{R} \times \mathbb{R})\}$ gives us a geometric realization (in the category of semialgebraic manifolds) of the (pre)biassociahedra posets introduced by Martin Markl in [Ma2] following an earlier work by Samson Sanedlidze and Ron Umble [SU1]. This result gives us a nice combinatorial tool to control the boundary strata of the semialgebraic manifolds $\overline{C}_{m,n}(\mathbb{R} \times \mathbb{R})$.

6.3. Configuration space $C_{A;I,J}(\mathcal{H})$ and its compactification. Let $\mathbb{H}' = \{(x, t) \in \mathbb{R} \times \mathbb{R}^{>0}\}$ and $\mathbb{H}'' = \{(y, \hat{t}) \in \mathbb{R} \times \mathbb{R}^{>0}\}$ be two copies of the upper-half plane, and let $\overline{\mathbb{H}}' = \{(x, t) \in \mathbb{R} \times \mathbb{R}^{\geq 0}\}$ and $\overline{\mathbb{H}}'' = \{(y, \hat{t}) \in \mathbb{R} \times \mathbb{R}^{\geq 0}\}$ be their closures. Consider a subspace $\mathcal{H} \subset \mathbb{H}' \times \mathbb{H}''$ given by the equation $t\hat{t} = 1$, and denote by $\overline{\mathcal{H}}$ its closure under the embedding into $\overline{\mathbb{H}}' \times \overline{\mathbb{H}}''$. The space $\overline{\mathcal{H}}$ has two distinguished lines, $\mathbf{X} := \{(x \in \mathbb{R}, y = 0, t = 0)\}$ and $\mathbf{Y} := \{(x = 0, y \in \mathbb{R}, \hat{t} = 0)\}$; it also has a natural structure of a smooth manifold with boundary.

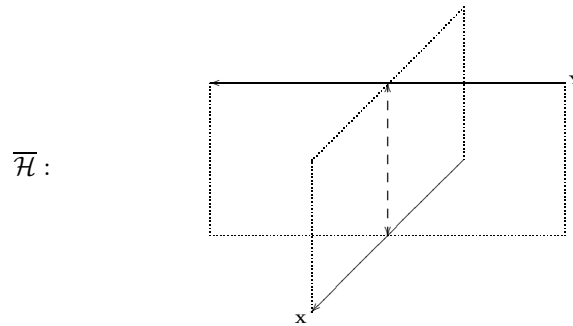

The group $G_3 := \mathbb{R}^+ \ltimes \mathbb{R}^2$ acts on $\overline{\mathcal{H}}$,

$$\begin{array}{ccc} \mathbb{R}^+ \ltimes \mathbb{R}^2 & \times & \overline{\mathcal{H}} & \longrightarrow & \overline{\mathcal{H}} \\ (\lambda, a, b) & \times & (x, y, t) & \longrightarrow & (\lambda x + a, \lambda^{-1} y + b, \lambda t). \end{array}$$

For finite sets A , I and J let us consider a configuration space

$$\text{Conf}_{A;I,J}(\mathcal{H}) := \{i : A \hookrightarrow \mathcal{H}, i' : J \hookrightarrow \mathbf{X}, i'' : I \hookrightarrow \mathbf{Y}\}$$

of injections. This is a $(3\#A + \#I + \#J)$ -dimensional smooth manifold. The group G_3 acts on it smoothly and, in the case $3\#A + \#I + \#J \geq 3$ freely. We assume from now on that conditions $3\#A + \#I + \#J \geq 3$, $\#I \geq 1$ and $\#J \geq 1$ hold true, and denote by

$$C_{A;I,J}(\mathcal{H}) = \text{Conf}_{A;I,J}(\mathcal{H})/G_3$$

the associated smooth manifold of G_3 -orbits. If $A = [k]$, $I = [m]$ and $J = [n]$ for some non-negative integers $k, m, n \in \mathbb{Z}^{\geq 0}$ (with $3k + m + n \geq 3$, $m, n \geq 1$), then we abbreviate $C_{[k];[m],[n]}(\mathcal{H})$ to $C_{k;m,n}(\mathcal{H})$.

A point $p \in C_{A;I,J}(\mathcal{H})$ can be understood as a collection of numbers

$$p = \left\{ \left(x_a, y_a, t_a = \frac{1}{\hat{t}_a} \right), x_\alpha^0, y_\beta^0 \right\}_{a \in [A], \alpha \in [J], \beta \in [I]}$$

defined modulo the following transformation

$$\left\{ (x_a, y_a, t_a), x_\alpha^0, y_\beta^0 \right\} \longrightarrow \left\{ (\lambda x_a + h', \lambda^{-1} y_a + h'', \lambda t_a), \lambda x_\alpha^0 + h', \lambda^{-1} y_\beta^0 + h'' \right\}$$

for some $\lambda \in \mathbb{R}^+$, $h', h'' \in \mathbb{R}$.

The space $C_{0;I,J}(\mathcal{H})$ can be identified with $C_{I,J}(\mathbb{R} \times \mathbb{R}) \simeq C_{m,n}(\mathbb{R} \times \mathbb{R})$ studied in detail in Appendix B, and we define its compactification $\overline{C}_{0;I,J}(\mathcal{H})$ as $\overline{C}_{I,J}(\mathbb{R} \times \mathbb{R})$.

The space $C_{A;I,J}(\mathcal{H})$ with $\#A \geq 1$ admits a canonical projection

$$\pi : C_{A;I,J}(\mathcal{H}) \longrightarrow C_{I,J}(\mathbb{R} \times \mathbb{R})$$

which forgets *internal* points in \mathcal{H} (where we assume $C_{1,1}(\mathbb{R} \times \mathbb{R})$ to be the one point set for consistency), and, for any $a \in A$, the following two projections

$$\begin{aligned} \pi'_a : C_{A;I,J}(\mathcal{H}) &\longrightarrow C_{a,J}(\mathbb{H}') \simeq C_{1,n}(\mathbb{H}) \\ p &\longrightarrow \{z'_\alpha := x_a + it_\alpha, x_\alpha^0\}_{\alpha \in I} \end{aligned}$$

$$\begin{aligned} \pi''_a : C_{k;m,n}(\mathcal{H}) &\longrightarrow C_{1,I}(\mathbb{H}'') \simeq C_{1,m}(\mathbb{H}) \\ p &\longrightarrow \{z''_\alpha := y_a + i\frac{1}{t_\alpha}, y_\beta^0\}_{\beta \in [m]}. \end{aligned}$$

We use these projections to construct the following continuous map for $\#A \geq 1$

$$\begin{aligned} f : C_{A;I,J}(\mathcal{H}) &\longrightarrow \prod_{a \in A} \overline{C}_{a,J}(\mathbb{H}') \times \prod_{a \in A} \overline{C}_{a,I}(\mathbb{H}'') \times \overline{C}_{I,J}(\mathbb{R} \times \mathbb{R}) \times (S^2)^{k(k-1)} \times [0, +\infty]^{k(k-1)(k-2)} \\ p &\longrightarrow \prod_{a \in A} \pi'_a(p) \quad \prod_{a \in A} \pi''_a(p) \quad \pi(p) \quad \prod_{\substack{a,b \in A \\ a \neq b}} \pi_{ab}(p) \quad \prod_{\substack{a,b,c \in A \\ \#\{a,b,c\}=3}} \pi_{abc}(p) \end{aligned}$$

where

$$(53) \quad \begin{aligned} \pi_{ab}(p) &:= \frac{(x_a - x_b, t_a t_b (y_a - y_b), t_a - t_b)}{\sqrt{(x_a - x_b)^2 + (t_a - t_b)^2 + t_a^2 t_b^2 (y_a - y_b)^2}}, \\ \pi_{abc}(p) &:= \frac{\sqrt{(x_a - x_b)^2 + (t_a - t_b)^2 + t_a^2 t_b^2 (y_a - y_b)^2}}{\sqrt{(x_b - x_c)^2 + (t_b - t_c)^2 + t_b^2 t_c^2 (y_b - y_c)^2}}, \end{aligned}$$

Here we assume that the last factor in the r.h.s. is omitted for $k < 3$, and the last two factors are omitted for $k < 2$ (as they have no sense in these cases). It is not hard to check that the above map is an embedding (it is essentially enough to check the cases $C_{1,1,1}(\mathcal{H})$ and $C_{2,1,1}(\mathcal{H})$) so that we can define a *compactified* configuration space $\overline{C}_{A;I,J}(\mathcal{H})$ as the closure of the image of $C_{A;I,J}(\mathcal{H})$ under the map f . It clearly has the structure of an oriented smooth manifold with corners and also of a semi-algebraic manifold.

6.4. A class of differential forms on $\overline{C}_{A;I,J}(\mathcal{H})$. Consider the circle

$$S^1 = \{z \in \mathbb{C} : z = e^{i\theta}, \theta = \text{Arg}(z) \in [0, 2\pi]\}$$

and a 1-form on S^1 of the form $\frac{1}{2\pi} \bar{g}(\theta) d\theta$ which satisfies the conditions

$$\int_0^{2\pi} \frac{1}{2\pi} \bar{g}(\theta) d\theta = 1$$

and

$$\text{supp}(\bar{g}(\theta)) \subset (0, \pi).$$

Thus this 1-form is concentrated in the upper-half of the circle. We shall use this 1-form to construct a class of closed differential forms Ω_Γ on $\overline{C}_{k;n,m}(\mathcal{H})$ parameterized by a set of graphs Γ we describe next.

6.4.1. A family of graphs $\mathcal{G}_{k;m,n}$. The prop $\widehat{\mathcal{DLieb}}^{\text{quant}} = \{\widehat{\mathcal{DLieb}}^{\text{quant}}(m,n)\}$ introduced in §5.4 is identical as graded vector space to the prop $\widehat{\mathcal{Lieb}}_{\infty}^{\text{min}}$ and hence admits the same set $\{\mathcal{G}_{k;m,n}\}$ of basis vectors. For example (we omit labellings of white vertices by integers),

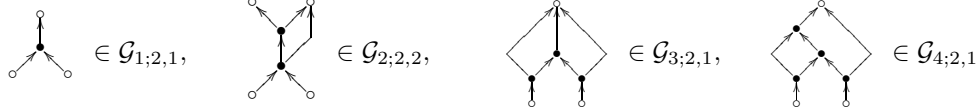

Thus graphs from $\mathcal{G}_{k;m,n}$ admit a flow which we always assume in our pictures to be directed from the bottom to the top (so that there is no need to show directions of the edges anymore). As before, $E_{\text{int}}(\Gamma)$ stands for the set of *internal* edges, $E_{\text{in}}(\Gamma)$ for the set of in-legs, $E_{\text{out}}(\Gamma)$ for the set of out-legs.

6.4.2. From graphs to differential forms. Consider a graph $\Gamma \in \mathcal{G}_{k;m,n}$ with $3k + m + n \geq 3$, and an associated configuration space

$$C(\Gamma) := C_{E_{\text{int}}(\Gamma); E_{\text{out}}(\Gamma), E_{\text{in}}(\Gamma)}(\mathcal{H}) \simeq C_{k;n,m}(\mathcal{H}).$$

Let $\mathbb{C}(\Gamma)$ be a subspace of $C(\Gamma)$ consisting of points

$$p = \left\{ \left(x_a, y_a, t_a = \frac{1}{t_a}, x_{\alpha}^0, y_{\beta}^0 \right) \right\}_{a \in E_{\text{int}}(\Gamma), \alpha \in E_{\text{in}}(\Gamma), \beta \in E_{\text{out}}(\Gamma)}$$

with

$$z'_a(p) := x_a + it_a \neq z'_b(p) := x_b + it_b \quad \text{and} \quad z''_a(p) := y_a + i \frac{1}{t_a} \neq z''_b(p) := y_b + i \frac{1}{t_b} \quad \forall a \neq b \in V_{\text{int}}(\Gamma),$$

i.e. with projections of internal vertices on planes \mathbb{H}' and \mathbb{H}'' being different (so that differential forms $d\text{Arg}(z'_a(p) - z'_b(p))$ and $d\text{Arg}(z''_a(p) - z''_b(p))$ are well-defined on $\mathbb{C}(\Gamma)$).

We define a smooth top degree differential form Ω_{Γ} on $\mathbb{C}(\Gamma)$,

$$(54) \quad \Omega_{\Gamma} := \bigwedge_{e \in E_{\text{in}}(\Gamma)} \omega'_e \wedge \bigwedge_{e \in E_{\text{int}}(\Gamma)} \Omega_e \wedge \bigwedge_{e \in E_{\text{out}}(\Gamma)} \omega''_e$$

where ω'_e and ω''_e are 1-forms and Ω_e is a 2-form defined as follows. Identifying vertices of Γ with their images in $\overline{\mathcal{H}}$ under injections (i, i', i'') , we define,

- (i) for any in-leg $e = \overset{v_1}{\circ} \rightarrow \overset{v_2}{\bullet} \in E_{\text{in}}(\Gamma)$, $\omega'_e := \frac{1}{2\pi} \bar{g} \left(\text{Arg} \left(z'_{v_2} - x_{v_1}^0 \right) \right) d\text{Arg} \left(z'_{v_2} - x_{v_1}^0 \right)$,
- (ii) for any out-leg $e = \overset{v_1}{\bullet} \rightarrow \overset{v_2}{\circ} \in E_{\text{out}}(\Gamma)$, $\omega''_e := \frac{1}{2\pi} \bar{g} \left(\text{Arg} \left(\overline{y_{v_2}^0 - z''_{v_1}} \right) \right) d\text{Arg} \left(\overline{y_{v_2}^0 - z''_{v_1}} \right)$,
- (iii) for any internal edge $e = \overset{v_1}{\bullet} \rightarrow \overset{v_2}{\bullet} \in E_{\text{int}}(\Gamma)$,

$$\Omega_e := \frac{1}{(2\pi)^2} \bar{g} \left(\text{Arg} \left(z'(v_2) - z'(v_1) \right) \right) \bar{g} \left(\text{Arg} \left(\overline{z''(v_2) - z''(v_1)} \right) \right) d\text{Arg} \left(z'(v_2) - z'(v_1) \right) \wedge d\text{Arg} \left(\overline{z''(v_2) - z''(v_1)} \right)$$

As the function \bar{g} has support in the upper-half of the circle, the differential form Ω_{Γ} extends smoothly to the configuration space $C(\Gamma)$ and even to its compactification $\overline{C}(\Gamma) := \overline{C}_{E_{\text{int}}(\Gamma); E_{\text{out}}(\Gamma), E_{\text{in}}(\Gamma)}(\mathcal{H})$.

A subset of $\mathcal{G}_{k;m,n}$ consisting of graphs Γ satisfying the condition

$$3\#E_{\text{int}}(\Gamma) + \#E_{\text{in}}(\Gamma) + \#E_{\text{out}}(\Gamma) = 3k + m + n - 3$$

is denoted by $\mathcal{G}_{k;m,n}^{\text{top}}$ as the associated differential forms Ω_{Γ} give us top-degree forms on the configuration space $\overline{C}(\Gamma)$.

Notice that if a graph $\Gamma \in \mathcal{G}_{k;m,n}$ satisfies the condition

$$3\#E_{\text{int}}(\Gamma) + \#E_{\text{in}}(\Gamma) + \#E_{\text{out}}(\Gamma) = 3k + m + n - 4$$

then the associated differential form Ω_{Γ} has degree $\dim C(\Gamma) - 1$ and hence one can apply the Stokes theorem to $d\Omega_{\Gamma}$ which is a top degree form. As Ω_{Γ} is closed, we obtain

$$0 = \int_{\overline{C}(\Gamma)} d\Omega_{\Gamma} = \int_{\partial\overline{C}(\Gamma)} \Omega_{\Gamma}$$

Let us check in a few concrete examples all the boundary strata in $\partial\overline{C}(\Gamma)$ on which the form Ω_Γ does not vanish identically.

6.4.3. Example. Consider

$$\Gamma = \begin{array}{c} \circ \\ \swarrow \quad \searrow \\ \bullet \\ \swarrow \quad \searrow \\ \circ \end{array} \in \mathcal{G}_{2;2,2}.$$

The associated 7-dimensional configuration space $C(\Gamma)$ is given by the data,

$$(55) \quad \left\{ \left[\begin{array}{l} z'_1 = x_1 + it_1 \\ z'_2 = x_2 + it_2 \\ x_1^0, x_2^0 \in \mathbb{R} \end{array} \right], \left[\begin{array}{l} z''_1 = y_1 + \frac{i}{t_1} \\ z''_2 = y_2 + \frac{i}{t_2} \\ y_1^0, y_2^0 \in \mathbb{R} \end{array} \right] \text{ with } x_1^0 < x_2^0, y_1^0 < y_2^0 \right\}$$

modulo the action of the 3-dimensional group G_3 . The 6-form Ω_Γ is given by

$$\Omega_\Gamma = \Omega'_\Gamma \wedge \Omega''_\Gamma$$

where

$$\Omega'_\Gamma := \Omega_{\bar{g}}(z'_2 - z'_1) \wedge \Omega_{\bar{g}}(z'_1 - x_1^0) \wedge \Omega_{\bar{g}}(z'_1 - x_2^0), \quad \Omega''_\Gamma := \Omega_{\bar{g}}(\overline{z''_2 - z''_1}) \wedge \Omega_{\bar{g}}(\overline{y_1^0 - z''_2}) \wedge \Omega_{\bar{g}}(\overline{y_2^0 - z''_2})$$

and the 1-form $\Omega_{\bar{g}}$ is given by

$$\Omega_{\bar{g}}(z_1 - z_2) := \frac{1}{2\pi} \bar{g}(\text{Arg}(z_1 - z_2)) d\text{Arg}(z_1 - z_2).$$

Let us classify the boundary strata in $\partial\overline{C}(\Gamma)$ on which the form Ω_Γ does not vanish identically.

CASE I. Consider the boundary strata in which two internal vertices collapse into one internal vertex, that is, the limit $\varepsilon \rightarrow 0$ of the configuration in which $(x_1^0, x_2^0, y_1^0, y_2^0)$ stay constant, and

$$\left(z'_a = x_* + it_* + \varepsilon(\mathbf{x}_a + i\mathbf{t}_a), z''_a = y_* + \varepsilon\mathbf{y}_a + \frac{i}{t_* + \varepsilon\mathbf{t}_a} \right)_{a=1,2}$$

It is isomorphic to $C_2(\mathbb{R}^3) \times C(\Gamma/\Gamma_{V_{int}(\Gamma)})$ where $\Gamma_{V_{int}(\Gamma)} = \bullet \rightarrow \bullet$ is the complete subgraph of Γ spanned by the two internal vertices, and

$$\Gamma/\Gamma_{V_{int}(\Gamma)} = \begin{array}{c} \circ \\ \swarrow \quad \searrow \\ \bullet \\ \swarrow \quad \searrow \\ \circ \end{array}$$

is the quotient graph obtained from Γ by collapsing the subgraph $\Gamma_{V_{int}(\Gamma)}$ into a single internal vertex. As we can fix the unique internal vertex at of the latter graph $(x_* = 0, y_* = 0, t_* = 1)$ and

$$\lim_{\varepsilon \rightarrow 0} \text{Arg}(z'_2 - z'_1) = \text{Arg}(\mathbf{x}_2 - \mathbf{x}_1 + i(\mathbf{t}_2 - \mathbf{t}_1))$$

and

$$\begin{aligned} \lim_{\varepsilon \rightarrow 0} \text{Arg}(\overline{z''_2 - z''_1}) &= \lim_{\varepsilon \rightarrow 0} \text{Arg}(\mathbf{y}_2 - \mathbf{y}_1 - \frac{i}{t_* + \varepsilon\mathbf{t}_2} + \frac{i}{t_* + \varepsilon\mathbf{t}_1}) \\ &= \text{Arg}(\mathbf{y}_2 - \mathbf{y}_1 + i(\mathbf{t}_2 - \mathbf{t}_1)) \end{aligned}$$

we obtain a factorization

$$\int_{C_2(\mathbb{R}^3) \times C(\Gamma/\Gamma_{V_{int}(\Gamma)})} \Omega_\Gamma = \int_{C_2(\mathbb{R}^3) = S^2} \omega_{\bar{g}} \cdot \int_{C(\Gamma/\Gamma_{V_{int}(\Gamma)})} \Omega_{\Gamma/\Gamma_{V_{int}(\Gamma)}} = (\Lambda_{\bar{g}}^{(2)})^2.$$

CASE II. Using invariance under the group G_3 we can always assume that the point (x_2, y_2, t_2) is fixed at, say, $(0, 0, 1)$. Thus it remains to consider limit configurations in which the projection z'_1 collapses to a point x_* in the boundary $t = 0$ of $\overline{\mathbb{H}}$,

$$\left(z'_1 = x_* + \varepsilon(\mathbf{x}_1 + i\mathbf{t}_1), z'_2 = x_2 + it_2, z''_1 = \mathbf{y}_1(\varepsilon) + \frac{i}{\varepsilon\mathbf{t}_1}, z''_2 = y_2^* + \frac{i}{t_2} \right) \text{ with } \varepsilon \rightarrow 0.$$

for some function $\mathbf{y}_1^*(\varepsilon)$ of the parameter ε . The limit

$$\lim_{\varepsilon \rightarrow 0} d\text{Arg}(z'_1 - x_1^0) \wedge d\text{Arg}(z'_1 - x_2^0)$$

can be non-zero if and only if the boundary points x_2^0 and x_1^0 also collapse to x_* ,

$$x_1^0 = x_* + \varepsilon \mathbf{x}_1^0, \quad x_2^0 = x_* + \varepsilon \mathbf{x}_2^0,$$

so that we get in that limit

$$\Omega'_\Gamma \xrightarrow{\varepsilon \rightarrow 0} \Omega_{\bar{g}}(z'_2 - x_*) \wedge \Omega_{\bar{g}}(\mathbf{z}'_1 - \mathbf{x}_1^0) \wedge \Omega_{\bar{g}}(\mathbf{z}'_1 - \mathbf{x}_2^0)$$

where $\mathbf{z}_1 = \mathbf{x}_1 + it_1$. To make the form

$$d\text{Arg}(\overline{z''_2 - z_1}) = d\text{Arg}(y_2 - \mathbf{y}_1(\varepsilon) - \frac{i}{t_2} + \frac{i}{\varepsilon t_1})$$

non-zero in the limit $\varepsilon \rightarrow 0$, we have to assume

$$\mathbf{y}_1(\varepsilon) \sim \text{const} + \frac{\mathbf{y}_*}{\varepsilon} \text{ for some } \mathbf{y}_* \in \mathbb{R}$$

and then get in the limit

$$\Omega''_\Gamma \xrightarrow{\varepsilon \rightarrow 0} \Omega_{\bar{g}}(\overline{\mathbf{y}_1 - \mathbf{z}''_1}) \wedge \Omega_{\bar{g}}(\overline{y_1^0 - z''_2}) \wedge \Omega_{\bar{g}}(\overline{y_2^0 - z''_2})$$

where $\mathbf{z}''_1 = \mathbf{y}_1 + \frac{i}{t_1}$. We conclude that this boundary strata is isomorphic to $C_{1;1,2}(\mathcal{H}) \times C_{1;2,1}(\mathcal{H})$ and the integral over it factorizes as follows

$$\int_{C_{1;1,2}(\mathcal{H}) \times C_{1;2,1}(\mathcal{H})} \Omega_{\Gamma_1} = - \int_{C_{1;1,2}(\mathcal{H})} \Omega_{\Gamma_1} \cdot \int_{C_{1;2,1}(\mathcal{H})} \Omega_{\Gamma_2} = -(\Lambda_{\bar{g}}^{(2)})^2,$$

where

$$(56) \quad \Gamma_1 = \begin{array}{c} \circ \\ | \\ \bullet \\ / \quad \backslash \\ \circ \quad \circ \end{array} \quad \Gamma_2 = \begin{array}{c} \circ \quad \circ \\ \backslash \quad / \\ \bullet \\ | \\ \circ \end{array}$$

As expected, $\int_{\partial \overline{C}(\Gamma)} \Omega_\Gamma = -(\Lambda_{\bar{g}}^{(2)})^2 + (\Lambda_{\bar{g}}^{(2)})^2 = 0$.

6.4.4. Example. Consider

$$\Gamma = \begin{array}{c} \circ \quad \circ \\ \backslash \quad / \\ \bullet \quad \bullet \\ / \quad \backslash \\ \circ \quad \circ \end{array} \in \mathcal{G}_{2;2,2}.$$

The associated 7-dimensional configuration space $C(\Gamma)$ is given by the same data as in (55), while the 6-form Ω_Γ is given by

$$\Omega_\Gamma := \Omega_{\bar{g}}(z'_1 - x_1^0) \wedge \Omega_{\bar{g}}(z'_2 - x_2^0) \wedge \Omega_{\bar{g}}(z'_2 - z'_1) \wedge \Omega_{\bar{g}}(\overline{z''_2 - z''_1}) \wedge \Omega_{\bar{g}}(\overline{y_1^0 - z''_1}) \wedge \Omega_{\bar{g}}(\overline{y_1^0 - z''_2})$$

Let us classify again the boundary strata in $\partial \overline{C}(\Gamma)$ which can contribute non-trivially into the vanishing integral $\int_{\partial \overline{C}(\Gamma)} \Omega_\Gamma$.

CASE 0. Consider the boundary configurations in which the internal points stay invariant while (i) $|x_2^0 - x_1^0| \rightarrow 0$, or (ii) $|y_2^0 - y_1^0|$, or (iii) $|x_2^0 - x_1^0| \rightarrow +\infty$, or (iv) $|y_2^0 - y_1^0| \rightarrow +\infty$. The forms Ω_Γ vanishes identically on boundary strata of types (iii) and (iv), while on strata of types (i) and, respectively, (ii) ones obtains the integrals

$$\int_{C_{2;2,1}(\mathcal{H})} \Omega_{\Gamma'_1} \quad \text{and} \quad \int_{C_{2;1,2}(\mathcal{H})} \Omega_{\Gamma'_2}, \quad \text{where} \quad \Gamma'_1 = \begin{array}{c} \circ \quad \circ \\ \backslash \quad / \\ \bullet \quad \bullet \\ / \quad \backslash \\ \circ \quad \circ \end{array}, \quad \Gamma'_2 = \begin{array}{c} \circ \quad \circ \\ / \quad \backslash \\ \bullet \quad \bullet \\ \backslash \quad / \\ \circ \quad \circ \end{array}$$

(which happen to vanish identically — one can use the standard reflection argument to check this claim which plays no role below).

CASE I is exactly the same as Case I in the previous example. The boundary strata is isomorphic to $C_2(\mathbb{R}^3) \times C(\Gamma/\Gamma_{V_{int}(\Gamma)})$ and one has

$$\int_{C_2(\mathbb{R}^3) \times C(\Gamma/\Gamma_{V_{int}(\Gamma)})} \Omega_\Gamma = \int_{C_2(\mathbb{R}^3)} \omega_{\bar{g}} \cdot \int_{C(\Gamma/\Gamma_{V_{int}(\Gamma)})} \Omega_{\Gamma/\Gamma_{V_{int}(\Gamma)}} = (\Lambda_{\bar{g}}^{(2)})^2.$$

CASE II. Using invariance under the group G_3 we can always assume that the point (x_2, y_2, t_2) is fixed at, say, $(0, 0, 1)$. Thus it remains to consider limit configurations in which the projection z'_1 collapses to a point x_* in the boundary $t = 0$ of $\overline{\mathbb{H}}$,

$$\left(z'_1 = x_* + \varepsilon(\mathbf{x}_1 + it_1), z'_2 = x_2 + it_2, z''_1 = \mathbf{y}_1(\varepsilon) + \frac{i}{\varepsilon} \mathbf{t}_1, z''_2 = y_2^* + \frac{i}{t_2} \right) \quad \text{with } \varepsilon \rightarrow 0.$$

for some function $\mathbf{y}_1^*(\varepsilon)$ of the parameter ε . Arguing as in the Case II of the previous example, we conclude that for Ω_Γ not to vanish identically we have to assume

$$x_1^0 = x_* + \varepsilon \mathbf{x}_1^0, \mathbf{y}_1(\varepsilon) = \text{const} + \frac{\mathbf{y}_1}{\varepsilon}, y_1^0 = \text{const} + \frac{\mathbf{y}_1^0}{\varepsilon} \text{ for some } \mathbf{x}_1^0, \mathbf{y}_1, \mathbf{y}_1^0 \in \mathbb{R}$$

so that we get in the limit

$$\lim_{\varepsilon \rightarrow 0} \Omega_\Gamma = -\Omega_{\Gamma_2} \wedge \Omega_{\Gamma_1}$$

where

$$\Omega_{\Gamma_2} := \Omega_{\bar{g}}(\mathbf{z}'_1 - \mathbf{x}_1^0) \wedge \Omega_{\bar{g}}(\overline{\mathbf{y}_1^0 - \mathbf{z}'_1}) \wedge \Omega_{\bar{g}}(\overline{0 - \mathbf{z}''_1}) \quad \text{and} \quad \Omega_{\Gamma_1} := \Omega_{\bar{g}}(\overline{z''_2 - x_*}) \wedge \Omega_{\bar{g}}(\overline{z''_2 - x_2^0}) \wedge \Omega_{\bar{g}}(\overline{y_2^0 - z''_2})$$

are the differential forms associated to the graphs in (56). This boundary stratum is isomorphic to $C_{1;2,1}(\mathcal{H}) \times C_{1;1,2}(\mathcal{H}) = C(\Gamma_2) \times C(\Gamma_1)$ and we get

$$\int_{C_{1;2,1}(\mathcal{H}) \times C_{1;1,2}(\mathcal{H})} \Omega_\Gamma = - \int_{C(\Gamma_2)} \Omega_{\Gamma_2} \cdot \int_{C(\Gamma_1)} \Omega_{\Gamma_1} = -(\Lambda_{\bar{g}}^{(2)})^2.$$

6.4.5. A useful observation. Notice that the only boundary strata in the above two examples which lie in the fibre of the surjection

$$\pi : \overline{\mathcal{C}}(\Gamma) \longrightarrow C_{2,2}(\mathbb{R} \times \mathbb{R})$$

over a generic point in the base and contributes non-trivially into the integral is the boundary strata of type I .

Analyzing similarly the graphs

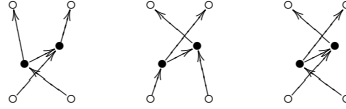

we obtain the following result for sum of the push-forwards along the map $\pi : \overline{\mathcal{C}}(\Gamma) \rightarrow C_{2,2}(\mathbb{R} \times \mathbb{R})$ and its boundary version $\pi_\partial : \partial \overline{\mathcal{C}}(\Gamma) \rightarrow C_{2,2}(\mathbb{R} \times \mathbb{R})$,

$$\begin{aligned} \sum_{\Gamma \in \mathcal{G}_{2;2,2}} \pi_{*\partial}(\Omega_\Gamma) \Gamma &= \pi_*(\Omega_{\Gamma_0}) \left(\begin{array}{c} \text{graph 1} \\ - \text{graph 2} \\ + \text{graph 3} \\ + \text{graph 4} \\ - \text{graph 5} \end{array} \right) \\ &= \pi_*(\Omega_{\Gamma_0}) \delta \Gamma_0 \end{aligned}$$

where δ is the differential in \mathcal{DLieb}_∞ and $\Gamma_0 = \begin{array}{c} \text{graph 1} \\ \cdot \end{array}$.

6.5. An explicit formula for quantization of Lie bialgebras. Let $\mathcal{G}_{k;m,n}^{(3)}$ be a subset of $\mathcal{G}_{k;m,n}$ consisting of graphs forming a basis of the \mathbb{S} -bimodule $\widehat{\mathcal{DLieb}}^{\text{quant}}$ (these graphs have, in particular, all their internal vertices 3-valent).

(possibly empty) subset $I \subset V_{int}(\Gamma)$ of internal points tend in the limit $\varepsilon \rightarrow 0$ to a point $x_* \in \mathbf{X}$,

$$\begin{aligned} z'_i &= x_* + \varepsilon(\mathbf{x}_i + i\mathbf{t}_i), & z''_i &= y_i(\varepsilon) + \frac{i}{\varepsilon\mathbf{t}_i} \quad i \in I, \\ x'_1 &= x_* + \varepsilon\mathbf{x}_1^0 \\ x'_2 &= x_* + \varepsilon\mathbf{x}_2^0 \end{aligned}$$

for some functions $y_i(\varepsilon)$ of the parameter ε (it is easy to see that if $I \neq \emptyset$, then the differential form Ω_Γ has a chance not to vanish identically on such a boundary stratum if and only if $y_i(\varepsilon) \simeq \frac{y_i}{\varepsilon}$ as $\varepsilon \rightarrow 0$ for some $y_i \in \mathbb{R}$).

Consider (as an elementary illustration) a special case $I = \emptyset$ (and denote the associated strata in $\partial_{II}\overline{C}_{k;2,2}(\mathcal{H})$ by $\partial_{II\emptyset}\overline{C}_{k;2,2}(\mathcal{H})$). It is clear that in this case we have

$$\sum_{k \geq 1} \sum_{\Gamma \in \mathcal{G}_{k;2,2}^{(3)}} \left(\int_{\partial_{II\emptyset} C(\Gamma)} \Omega_\Gamma \right) = - \frac{f_{\geq 1}^q \left(\begin{array}{c} \circ \\ \vdots \\ \circ \end{array} \right)}{\begin{array}{c} \circ \\ \vdots \\ \circ \end{array}}$$

An analogue of this formula in the case $|y_2^0 - y_1^0| \rightarrow 0$ while $|x_2^0 - x_1^0|$ stays finite and no internal vertices collapse to the line \mathbf{Y} would be of course the following one

$$\sum_{k \geq 1} \sum_{\Gamma \in \mathcal{G}_{k;2,2}^{(3)}} \left(\int_{\partial_{II\emptyset} C(\Gamma)} \Omega_\Gamma \right) = - \frac{\begin{array}{c} \circ \\ \vdots \\ \circ \end{array}}{f_{\geq 1}^q \left(\begin{array}{c} \circ \\ \vdots \\ \circ \end{array} \right)}$$

where we use fraction type notation for prop compositions introduced in [Mal] e.g.

$$\frac{\begin{array}{c} \circ \\ \vdots \\ \circ \end{array}}{\begin{array}{c} \circ \\ \vdots \\ \circ \end{array}} := \begin{array}{c} \circ \\ \vdots \\ \circ \\ \vdots \\ \circ \end{array}, \quad \frac{\begin{array}{c} \circ \quad \circ \\ \vdots \quad \vdots \\ \circ \quad \circ \end{array}}{\begin{array}{c} \circ \quad \circ \\ \vdots \quad \vdots \\ \circ \quad \circ \end{array}} := \begin{array}{c} \circ \quad \circ \\ \vdots \quad \vdots \\ \circ \quad \circ \\ \vdots \quad \vdots \\ \circ \quad \circ \end{array}$$

The general case is no more difficult. Let $J := V_{int}(\Gamma) \setminus I$ be the complementary subset corresponding to points which have \mathbb{H}^l -projections *not* tending to x_* as $\varepsilon \rightarrow 0$. We can represent each graph Γ in the sum

$$\sum_{k \geq 0} \sum_{\Gamma \in \mathcal{G}_{k;2,2}^{(3)}} \int_{\partial_{II}\overline{C}_{k;2,2}(\mathcal{H})} \Omega_\Gamma \Gamma$$

in the form

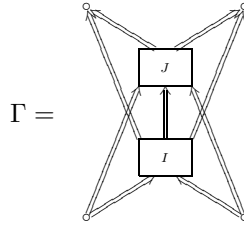

where directed double edges stand for (possibly empty) sets of directed edges. Let Γ' (resp., Γ'') be the element of $\mathcal{DLieb}^{quant}(1, 2)$ (resp., of $\mathcal{DLieb}^{quant}(2, 1)$) defined as the complete subgraph of Γ spanned by vertices from the set I (resp., J), together with *all* edges attached to this set,

$$\Gamma' = \begin{array}{c} \circ \\ \parallel \\ \square \\ \text{I} \\ \text{---} \\ \circ \quad \circ \end{array}, \quad \Gamma'' = \begin{array}{c} \circ \quad \circ \\ \text{---} \\ \square \\ \text{J} \\ \parallel \\ \circ \end{array}$$

Note that out-legs in Γ' are formed by three types of edges in Γ (and denoted in Γ by three different double arrows), the ones which connect vertices of I to the left out-vertex, to the vertices of J , and to the right out-vertex. Similarly, the set of in-legs of Γ'' encompasses three different double arrows in Γ . Many different

graphs Γ produce *identical* associated graphs Γ' and Γ'' and it is easy to describe this family — it is precisely the set of non-vanishing summands in the prop composition $\Gamma'' \circ_1 \Gamma'$. As

$$\Omega_\Gamma|_{\partial_{II}\overline{\mathcal{C}}_{k;2,2}(\mathcal{H})} = \lim_{\varepsilon \rightarrow 0} \Omega_\Gamma = \Omega_{\Gamma'} \wedge \Omega_{\Gamma''}.$$

we finally get

$$\begin{aligned} - \sum_{k \geq 0} \sum_{\Gamma \in \mathcal{G}_{k;2,2}^{(3)}} \int_{\partial_{II}\overline{\mathcal{C}}_{k;2,2}(\mathcal{H})} \Omega_\Gamma &= \sum_{k', k'' \geq 0} \sum_{\Gamma' \in \mathcal{G}_{k';1,2}^{(3)}} \sum_{\Gamma'' \in \mathcal{G}_{k'';2,1}^{(3)}} \left(\int_{\overline{\mathcal{C}}_{k';1,2}(\mathcal{H})} \Omega_{\Gamma'} \right) \cdot \left(\int_{\overline{\mathcal{C}}_{k'';2,1}(\mathcal{H})} \Omega_{\Gamma''} \right) \Gamma'' \circ_1 \Gamma' \\ &= f^q \left(\begin{array}{c} 1 \quad 2 \\ \vdots \\ \circ \\ \vdots \\ 1 \end{array} \right) \circ_1 f^q \left(\begin{array}{c} \vdots \\ \circ \\ \vdots \\ 1 \quad 2 \end{array} \right) \\ &= f^q \left(\begin{array}{c} \circ \\ \vdots \\ \circ \end{array} \right). \end{aligned}$$

Case III. Denote the associated boundary strata by $\partial_{III}\overline{\mathcal{C}}_{k;2,2}(\mathcal{H})$, and consider for concreteness limit configuration with $|y_2^0 - y_1^0| \rightarrow +\infty$ and x_2^0, x_1^0 staying constant (the other subcase can be treated similarly). In general a (possibly empty) subset $I_1 \subset V_{int}(\Gamma)$ (resp., I_2) can collapse to the boundary point x_1^0 (resp., x_2^0), and a (possibly empty) subset $K_1 \subset V_{int}(\Gamma)$ (resp., K_2) can tend as $\varepsilon \rightarrow 0$ to the boundary point y_1^0 (resp., y_2^0),

$$\begin{aligned} z'_{i_1} &= x_1^0 + \varepsilon(\mathbf{x}_{i_1} + i\mathbf{t}_{i_1}), & z''_{i_1} &= y_{i_1}(\varepsilon) + \frac{i}{\varepsilon \mathbf{t}_{i_1}}, & i_1 &\in I_1, \\ z'_{i_2} &= x_2^0 + \varepsilon(\mathbf{x}_{i_2} + i\mathbf{t}_{i_2}), & z''_{i_2} &= y_{i_2}(\varepsilon) + \frac{i}{\varepsilon \mathbf{t}_{i_2}}, & i_2 &\in I_2, \\ y_1^0 &= \frac{\mathbf{y}_1^0}{\varepsilon}, & y_2^0 &= \frac{\mathbf{y}_2^0}{\varepsilon} \\ z'_{k_1} &= x_{k_1} + \frac{i\mathbf{t}_{k_1}}{\varepsilon}, & z''_{k_1} &= \frac{\mathbf{y}_1^0}{\varepsilon} + \varepsilon(\Delta \mathbf{y}_1^0 + \frac{i}{\mathbf{t}_{k_1}}), & k_1 &\in K_1, \\ z'_{k_2} &= x_{k_2} + \frac{i\mathbf{t}_{k_2}}{\varepsilon}, & z''_{k_2} &= \frac{\mathbf{y}_2^0}{\varepsilon} + \varepsilon(\Delta \mathbf{y}_2^0 + \frac{i}{\mathbf{t}_{k_2}}), & k_2 &\in K_2, \\ z'_j &= x_j + it_j, & z''_j &= y_j(\varepsilon) + \frac{i}{t_j}, & j &\in J := V_{int}(\Gamma) \setminus I_1 \sqcup I_2 \sqcup K_1 \sqcup K_2 \end{aligned}$$

for some functions $y_\bullet(\varepsilon)$ of the parameter ε (which we have yet to understand) and some arbitrary constants in bold letters.

We claim that it is enough to consider the case when the sets K_1 and K_2 are both empty. Indeed, if at least one of the sets, say K_1 is not empty, it has a vertex $k \in K_1$ connected by an edge to a vertex i in the set $J \sqcup I_1 \sqcup I_2 \sqcup \{x_1^0\} \sqcup \{x_2^0\}$ which contributes into the form Ω_Γ a factor

$$\lim_{\varepsilon \rightarrow 0} dArg(z'_k - z'_i) = \lim_{\varepsilon \rightarrow 0} dArg\left(x_k + \frac{i\mathbf{t}_k}{\varepsilon} - z'_i\right) \rightarrow 0$$

which vanishes identically. Hence, for $\Omega_\Gamma|_{\partial_{III}\overline{\mathcal{C}}_{k;2,2}(\mathcal{H})}$ not to vanish identically, we can assume that Γ has a form

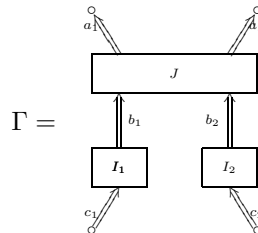

where some edges ingoing into a box can continue as outgoing edges without “hitting” an internal vertex inside the box. Note that no edge can connect a vertex i_1 from I_1 to a vertex i_2 from I_2 as otherwise the differential form Ω_Γ vanishes identically in the limit $\varepsilon \rightarrow 0$ due to the presence of the factor

$$\lim_{\varepsilon \rightarrow 0} d\text{Arg}(z'_{i_1} - z'_{i_2}) = d\text{Arg}(x_1^0 - x_2^0) = 0.$$

If the set J is empty, then Γ takes the form

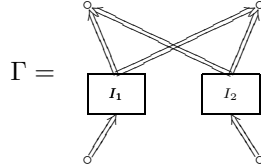

Let $G_{k;2,2} \subset \mathcal{G}_{k;2,2}^{(3)}$ be the subset of graphs of this special form with k internal vertices. It is clear that

$$\sum_{k \geq 0} \sum_{\Gamma \in G_{k;2,2}} \left(\int_{\partial_{II} C(\Gamma)} \Omega_\Gamma \right) = \frac{\text{diagram with two boxes and two crossing edges and internal vertices}}{f^q \left(\text{diagram with one box and two crossing edges and internal vertices} \right) f^q \left(\text{diagram with one box and two crossing edges and internal vertices} \right)}$$

Consider next a more general case $J \neq \emptyset$. Let $J_1 \subset J$ (resp., $J_2 \subset J$) be the subset of vertices which can be connected by a directed path of edges to the out-vertex y_1^0 (resp., y_2^0). At least one of the sets J_1 and J_2 is non-empty. It is easy to see that for $\Omega_\Gamma|_{\partial_{II} \overline{C}_{k;2,2}(\mathcal{H})}$ not to vanish identically, the functions $y_{j_1}(\varepsilon)$ and $y_{j_2}(\varepsilon)$ in the formulae above must be of the form as $\varepsilon \rightarrow 0$,

$$y_{j_1}(\varepsilon) = \frac{\mathbf{y}_1^0}{\varepsilon} + \mathbf{y}_{j_1}, \quad y_{j_2}(\varepsilon) = \frac{\mathbf{y}_2^0}{\varepsilon} + \mathbf{y}_{j_2}, \quad \forall j_1 \in J_1, \forall j_2 \in J_2,$$

for some constants \mathbf{y}_{j_1} and \mathbf{y}_{j_2} . In particular, $J_1 \cap J_2 = \emptyset$, so that for $\Omega_\Gamma|_{\partial_{II} \overline{C}_{k;2,2}(\mathcal{H})}$ not to vanish identically, the graph Γ must be of the form

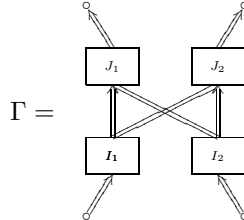

where some edges ingoing into a box can continue as outgoing edges without “hitting” an internal vertex inside the box (note that some of sets I_1 , I_2 , J_1 and J_2 can be empty!).

If Γ is a disjoint union of two graphs, say Γ_1 and Γ_2 , from $\mathcal{G}_{n;1,1}^{or}$, i.e. if it has one of the following two structures,

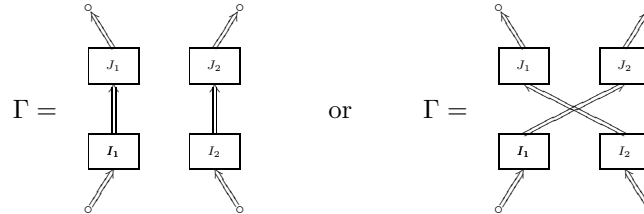

then $\Omega_\Gamma|_{\partial \overline{C}_{k;2,2}(\mathcal{H})} = 0$ because of the following

CLAIM. For any $\Gamma \in \mathcal{G}_{n;1,1}$ the associated integral

$$\int_{C_{n;1,1}(\mathcal{H})} \Omega_\Gamma$$

vanishes. Indeed, let l' be the number of in-legs of Γ , l'' the number of out-legs, and k the number of internal edges. The integral $\int_{\mathcal{C}_{n;1,1}(\mathcal{H})} \Omega_\Gamma$ can be non-zero if and only if Ω_Γ has top degree, i.e. if and only if

$$3n - 3 + 2 = 2k + l' + l''$$

On the other hand, as every internal vertex of Γ is at least trivalent, one must have

$$2k + l + l'' \geq 3n$$

These two equations are incompatible which proves the CLAIM.

Combining all the above observations, we conclude $\Omega_\Gamma|_{\partial_{III}\bar{\mathcal{C}}_{k;2,2}(\mathcal{H})}$ may not vanish identically only on the boundary strata of the form

$$\partial_{I_1, I_2, J_1, J_2} \bar{\mathcal{C}}_{k;2,2}(\mathcal{H}) := \bar{\mathcal{C}}_{\#I_1;2,1} \times \bar{\mathcal{C}}_{\#I_2;2,1} \times \bar{\mathcal{C}}_{\#J_1;1,2} \times \bar{\mathcal{C}}_{\#J_2;1,2}$$

and

$$\Omega_\Gamma|_{\partial_{I_1, I_2, J_1, J_2} \bar{\mathcal{C}}(\Gamma)} = \Omega_{\Gamma_{I_1}} \wedge \Omega_{\Gamma_{I_2}} \wedge \Omega_{\Gamma_{J_1}} \wedge \Omega_{\Gamma_{J_2}}$$

where the graphs Γ_{I_i} and Γ_{J_i} , $i = 1, 2$, are given by,

$$\Gamma_{I_i} = \begin{array}{c} \circ \quad \circ \\ \diagdown \quad \diagup \\ \boxed{I_i} \\ \uparrow \end{array} \in \mathcal{G}_{\#I_i;2,1}^{(3)}, \quad \Gamma_{J_i} = \begin{array}{c} \uparrow \\ \boxed{J_i} \\ \diagdown \quad \diagup \\ \circ \quad \circ \end{array} \in \mathcal{G}_{\#J_i;1,2}^{(3)}.$$

Note that if I_i , respectively J_i , is empty, then we have to set

$$\Gamma_{I_i} = \begin{array}{c} \circ \quad \circ \\ \circ \end{array}, \quad \text{respectively} \quad \Gamma_{J_i} = \begin{array}{c} \circ \\ \circ \quad \circ \end{array}$$

and $\Omega_{\Gamma_{I_i}} = 1$, resp. $\Omega_{\Gamma_{J_i}} = 1$. Therefore we conclude that

$$\sum_{k \geq 0} \sum_{\Gamma \in \mathcal{G}_{k;2,2}^{(3)}} \left(\sum_{\substack{V_{int}(\Gamma) = I_1 \sqcup I_2 \sqcup J_1 \sqcup J_2 \\ |I_1| + |I_2| \geq 1, |J_1| + |J_2| \geq 1}} \int_{\partial_{I_1, I_2, J_1, J_2} \bar{\mathcal{C}}(\Gamma)} \Omega_\Gamma \right) \Gamma = \frac{f^q \left(\begin{array}{c} \circ \\ \diagdown \quad \diagup \\ \circ \end{array} \right) f^q \left(\begin{array}{c} \circ \\ \diagdown \quad \diagup \\ \circ \end{array} \right)}{f^q \left(\begin{array}{c} \circ \\ \diagdown \quad \diagup \\ \circ \end{array} \right) f^q \left(\begin{array}{c} \circ \\ \diagdown \quad \diagup \\ \circ \end{array} \right)} = f^{ex} \left(\begin{array}{c} \circ \quad \circ \\ \diagdown \quad \diagup \\ \circ \quad \circ \\ \diagdown \quad \diagup \\ \circ \quad \circ \end{array} \right)$$

where the middle expression means the fraction type composition in the prop $\mathcal{Lieb}^{\text{quant}}$. Finally, we conclude

$$\begin{aligned} 0 &= \sum_{k \geq 0} \sum_{\Gamma \in \mathcal{G}_{k;2,2}^{(3)}} \left(\int_{\partial \bar{\mathcal{C}}_{k;2,2}(\mathcal{H})} \Omega_\Gamma \right) \Gamma \\ &= \sum_{k \geq 0} \sum_{\Gamma \in \mathcal{G}_{k;2,2}^{(3)}} \left(\int_{\partial_{II} \bar{\mathcal{C}}_{k;2,2}(\mathcal{H})} \Omega_\Gamma \right) \Gamma + \sum_{k \geq 0} \sum_{\Gamma \in \mathcal{G}_{k;2,2}^{(3)}} \left(\int_{\partial_{III} \bar{\mathcal{C}}_{k;2,2}(\mathcal{H})} \Omega_\Gamma \right) \Gamma \\ &= \sum_{k \geq 0} \sum_{\Gamma \in \mathcal{G}_{k;2,2}^{(3)}} \left(\int_{\partial_{II} \bar{\mathcal{C}}_{k;2,2}(\mathcal{H})} \Omega_\Gamma \right) + \sum_{k \geq 0} \sum_{\Gamma \in \mathcal{G}_{k;2,2}^{(3)}} \sum_{\substack{V_{int}(\Gamma) = I_1 \sqcup I_2 \sqcup J_1 \sqcup J_2 \\ |I_1| + |I_2| \geq 1, |J_1| + |J_2| \geq 1}} \left(\int_{\partial_{I_1, I_2, J_1, J_2} \bar{\mathcal{C}}(\Gamma)} \Omega_\Gamma \right) \Gamma \\ &= f^{ex} \left(\begin{array}{c} 1 \quad 2 \\ \diagdown \quad \diagup \\ \circ \\ \diagdown \quad \diagup \\ 1 \quad 2 \end{array} + \begin{array}{c} 1 \quad 2 \\ \diagdown \quad \diagup \\ \circ \quad \circ \\ \diagdown \quad \diagup \\ \circ \quad \circ \end{array} \right) \end{aligned}$$

which proves claim (iii). \square

6.5.2. Main Corollary. *Composition of the explicit morphism (57) with the explicit morphism $\mathcal{D}(f)$ (see §5.5.3(ii)) gives us an explicit transcendental morphism of props*

$$(59) \quad \mathcal{D}(f) \circ f^q : \mathit{Assb} \longrightarrow \widehat{\mathcal{L}ieb}^\circ$$

and hence an explicit universal quantization of finite-dimensional Lie bialgebras. The main purpose of this paper is achieved.

6.5.3. Other Corollaries. (i) As the differential 2-forms ω_g and ϖ_g used in the constructions of the maps f^q and f are simple, *graphs with multiple edges do not contribute into the map (59)*. Essentially this observation says that *our universal quantization formula does not involve graphs which contain a subgraph*

of the form . It also follows from our explicit formula that all graphs with at least one black vertex contributing to the universal quantization morphism are *connected*.

(ii) *The explicit map (57) lifts by a trivial induction to a morphism of dg props \mathcal{F}^q which fits into a commutative diagram,*

$$\begin{array}{ccc} \mathit{Assb}_\infty & \xrightarrow{\mathcal{F}^q} & \mathcal{D}\widehat{\mathcal{L}ieb}_\infty^{\text{quant}} \\ p \downarrow & & \downarrow \pi \\ \mathit{Assb} & \xrightarrow{f^q} & \mathcal{D}\widehat{\mathcal{L}ieb}^{\text{quant}} \end{array}$$

and which satisfies the condition

$$\pi_1 \circ \mathcal{F}^q \left(\begin{array}{c} \overbrace{\phantom{\text{graph}}}^m \\ \text{graph} \\ \underbrace{\phantom{\text{graph}}}^n \end{array} \right) = \lambda \begin{array}{c} \overbrace{\phantom{\text{graph}}}^m \\ \text{graph} \\ \underbrace{\phantom{\text{graph}}}^n \end{array} \quad \text{for some non-zero } \lambda \in \mathbb{R},$$

for all $m + n \geq 3$, $m, n \geq 1$. Here π_1 is the projection to the vector subspace in $\mathcal{D}\widehat{\mathcal{L}ieb}_\infty^{\text{quant}}$ spanned by graphs with precisely one black vertex.

This claim is obvious as surjections p and π^q are quasi-isomorphisms.

(iii) Composition of the maps \mathcal{F}^q and $\mathcal{D}(F)$, where F is given by the explicit formula (52), gives us a formality map

$$\mathcal{D}(F) \circ \mathcal{F}^q : \mathit{Assb}_\infty \longrightarrow \mathcal{D}\widehat{\mathcal{L}ieb}_\infty^\circ$$

and hence a universal quantization of finite-dimensional strongly homotopy Lie bialgebras.

6.6. An open problem. The above Corollary(ii) gives us an inductive extension of the explicit morphism (57) to some morphism of dg props $\mathcal{F}^q : \mathit{Assb}_\infty \rightarrow \widehat{\mathcal{L}ieb}_\infty^{\text{quant}}$. Can this extension be given by an explicit formula similar to the one for f^q ? Here is a conjectural answer.

6.6.1. Conjecture. *There is a morphism of props*

$$(60) \quad \mathcal{F}^q : \mathit{Assb}_\infty \longrightarrow \mathcal{D}\widehat{\mathcal{L}ieb}_\infty^{\text{quant}}$$

given explicitly on the generators of Assb_∞ as follows,

$$\mathcal{F}^q \left(\begin{array}{c} \overbrace{\phantom{\text{graph}}}^m \\ \text{graph} \\ \underbrace{\phantom{\text{graph}}}^n \end{array} \right) := \sum_{k \geq 1} \sum_{\Gamma \in \mathcal{G}_{k;m,n}^{\text{pr}}} \left(\int_{\overline{\mathcal{C}}_{k;m,n}(\mathcal{H})} \Omega_\Gamma \right) \Gamma + \begin{cases} \begin{array}{c} \circ \quad \circ \\ \circ \end{array} & \text{if } m = 2, n = 1 \\ \begin{array}{c} \circ \\ \circ \quad \circ \\ \circ \quad \circ \end{array} & \text{if } m = 1, n = 2 \\ 0 & \text{otherwise} \end{cases}$$

where the differential form Ω_Γ is defined in (54).

Let us provide a strong evidence for this conjecture elucidating a particular problem which requires a better understanding.

By construction of the compactified space $\overline{\mathcal{C}}_{k;m,n}(\mathcal{H})$, we have a natural semialgebraic fibration (see [HLTV])

$$\pi : \overline{\mathcal{C}}_{k;m,n}(\mathcal{H}) \longrightarrow \overline{\mathcal{C}}_{m,n}(\mathbb{R} \times \mathbb{R})$$

and hence a push-forward map of piecewise semi-algebraic differential forms

$$\pi_* : \Omega_{\overline{\mathcal{C}}_{k;m,n}(\mathcal{H})}^\bullet \longrightarrow \Omega_{\overline{\mathcal{C}}_{m,n}(\mathbb{R} \times \mathbb{R})}^\bullet$$

such that for any semialgebraic chain

$$\phi : M \rightarrow \overline{\mathcal{C}}_{m,n}(\mathbb{R} \times \mathbb{R})$$

the integral

$$\int_M \phi^*(\pi_*(\Omega_\Gamma))$$

is well-defined (i.e. convergent) for any $\Gamma \in \mathcal{G}_{k;m,n}$. Hence we can consider an $\mathbb{S}_m^{op} \times \mathbb{S}_n$ equivariant map

$$(61) \quad \begin{array}{ccc} \Phi_n^m : & \text{Chains}(\overline{\mathcal{C}}_{m,n}) & \longrightarrow & \widehat{\mathcal{L}ieb}_\infty^{\text{quant}}(m,n) \\ \phi : M \rightarrow \overline{\mathcal{C}}_{m,n}(\mathbb{R} \times \mathbb{R}) & \longrightarrow & \sum_{k \geq 0} \sum_{\Gamma \in \mathcal{G}_{k;m,n}} & \left(\int_M \phi^*(\pi_*(\Omega_\Gamma)) \right) \Gamma \end{array}$$

Note that in our grading conventions the chain complex $(\text{Chains}(\overline{\mathcal{C}}_{m,n}), \partial)$ is non-positively graded so that the standard boundary differential ∂ has degree $+1$. Using arguments almost identical to the ones employed in the proof of Theorem **6.5.1** one can show the following

6.6.2. Theorem. *For any $m, n \geq 1$ with $m + n \geq 3$ the collection of maps $\Phi_n^m : \text{Chains}(\overline{\mathcal{C}}_{m,n}) \longrightarrow \widehat{\mathcal{L}ieb}_\infty^{\text{quant}}(m,n)$ commutes with the differentials,*

$$\delta^{\omega_{\overline{\mathcal{C}}}} \circ \Phi_n^m = \Phi_n^m \circ \partial$$

and hence gives us an equivariant morphism of differential $\frac{1}{2}$ -props

$$\Phi : \text{Chains}(\overline{\mathcal{C}}_{\bullet,\bullet}(\mathbb{R} \times \mathbb{R})) \rightarrow \widehat{\mathcal{D}Lieb}_\infty^{\text{quant}}.$$

The restriction of the map Φ to the Sanedlidze-Umble cell complex $(\text{Cell}(\mathbf{K}_\bullet), \partial_{\text{cell}}) \subset \text{Chains}(\overline{\mathcal{C}}_{\bullet,\bullet}(\mathbb{R} \times \mathbb{R}))$ (see Appendix B) gives us precisely the map \mathcal{F}^q in the Conjecture **6.6.2**. This map respects the differentials but at the moment we can not claim it respects *all* prop compositions as the isomorphism $(\text{Cell}(\mathbf{K}_\bullet), \partial_{\text{cell}}) \simeq \text{Assb}_\infty$ (which is claimed in [SU1]) should be understood better in this context.

APPENDIX A. Some vanishing Lemmas

Let ω_g be a top degree form on S^2 given by (22) for $d = 3$. We shall prove some vanishing results for the weights

$$C_\Gamma = \int_{\overline{\mathcal{C}}_{4p+2}(\mathbb{R}^3)} \bigwedge_{e \in E(\Gamma)} \pi_e^*(\omega_g)$$

of graphs $\Gamma \in \mathcal{G}_{4p+2,6p+1}$ with $p \geq 1$ contributing to the formulae given in Proposition **3.2.4**.

A.1. Lemma on binary vertices. *Any graph $\Gamma \in \mathcal{G}_{4p+2,6p+1}$ with $p \geq 1$ has at least 4 binary vertices. Moreover, if $\Gamma \in \mathcal{G}_{4p+2,6p+1}$ has precisely 4 binary vertices, then all other vertices must be trivalent.*

Proof. For a vertex $v \in V(\Gamma)$ its valency can be represented as the sum $2 + \Delta v$ for some non-negative integer Δv . The graph Γ has $12p + 2$ half-edges so we have an equality

$$\sum_{v \in V(\Gamma)} (2 + \Delta v) = 2 + 12p,$$

i.e.

$$\sum_{v \in V(\Gamma)} \Delta v = 2 + 12p - 2(2 + 4p) = 4p - 2$$

Therefore at most $4p - 2$ vertices can have $\Delta v \geq 1$ which implies that Γ has at least $4p + 2 - (4p - 2) = 4$ binary vertices. Moreover, if Γ has precisely 4 bivalent vertices, then the remaining $4p - 2$ vertices v must have $\Delta v = 1$. \square

Therefore every graph in $\Gamma \in \mathbf{G}_{4p+2,6p+1}$ with $p \geq 1$ has at least four complete⁴ subgraphs of one of the following forms,

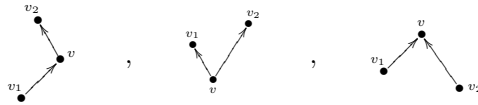

where the vertex v has no other attached edges except the ones shown in the pictures.

A.2. Vanishing Lemma. *If $\Gamma \in \mathbf{G}_{4p+2,6p+1}$ with $p \geq 1$ admits a binary vertex v of the form*

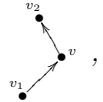

then its weight C_Γ vanishes.

Proof. We assume here that the propagators are chosen $O(2)$ -anti-invariantly, i.e., invariantly for the $SO(2)$ action on the sphere S^2 , and anti-invariantly for a reflection across a plane containing both poles. Now, integrating over the position of (the point in a configuration associated to) vertex v , the above graph yields a 1-form on the configuration space of v_1 and v_2 , i.e., on S^2 . This 1-form is easily checked to be $O(2)$ -anti-invariant, and furthermore closed by Stokes' Theorem. Using standard cylindrical coordinates (Z, ϕ) the $O(2)$ -anti-invariance implies that the form can be written as

$$f(Z)d\phi.$$

for some function $f(Z)$, vanishing at the sphere's poles $Z = \pm 1$ to ensure continuity. The closedness then implies that in fact $f(Z) \equiv 0$. \square

A.3. Vanishing Lemma. *If $\Gamma \in \mathbf{G}_{4p+2,6p+1}$ admits a 3-vertex complete graph (with any possible choice of directions of edges),*

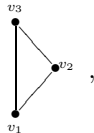

as a subgraph, then its weight C_Γ vanishes.

Proof. The integrand $\Omega_\Gamma := \bigwedge_{e \in E(\Gamma)} \pi_e^*(\omega_g)$ is invariant under the action of the gauge group $p \rightarrow \mathbb{R}^+ p + \mathbb{R}^3$ on points in \mathbb{R}^3 . Hence we can place vertex v_1 at $0 \in \mathbb{R}^3$, and normalized the Euclidean distance $|v_2 - v_1|$ to be equal to 1. Then the 6-form

$$\pi_{v_1, v_2}^*(\omega_g) \wedge \pi_{v_1, v_3}^*(\omega_g) \wedge \pi_{v_2, v_3}^*(\omega_g)$$

depends only on 5 parameters and hence vanishes identically for degree reasons. Hence the form Ω_Γ is zero. \square

⁴For a graph Γ and its pair of vertices $v_1, v_2 \in V(\Gamma)$ denote by $E_\Gamma(v_1, v_2)$ the set of edges connecting v_1 to v_2 . A subgraph Γ' of graph Γ is called *complete* if between any pair of its vertices $v_1, v_2 \in V(\Gamma')$ we have $E_{\Gamma'}(v_1, v_2) = E_\Gamma(v_1, v_2)$.

A.4. Vanishing Lemma. *Assume $\Gamma \in \mathcal{G}_{4p+2,6p+1}$ has two bivalent vertices v' and v'' connected by an edge. Then its weight C_Γ vanishes.*

Proof. It is enough to consider the case when orientations on the subgraph containing v' and v'' and their neighbouring (not necessarily binary) vertices v_1 and v_2 are as in the following oriented graph,

$$\Gamma_{v_1, v', v'', v_2} := \begin{array}{c} \bullet \\ \swarrow \quad \searrow \\ v_1 \quad v'' \quad v_2 \\ \swarrow \quad \searrow \\ \bullet \end{array},$$

for all other inequivalent choices the vanishing claim follows from Lemma **A.2**, and, in the case $v_1 = v_2$, from Lemma **A.3**.

Let us fix all vertices of the graph except v' and v'' . We can also fix without loss of generality the vertex v_1 at $0 \in \mathbb{R}^3$ and the vertex v_2 at the unit Euclidean distance from v_1 . Consider a projection

$$(62) \quad \pi : \overline{C}(\Gamma_{v_1, v', v'', v_2}) \longrightarrow C_{v_1, v_2}(\mathbb{R}^3)$$

and the function

$$f := \pi_* \left(\underbrace{\pi_{v_1, v'}^*(\omega_g) \wedge \pi_{v'', v''}^*(\omega_g) \wedge \pi_{v'', v_2}^*(\omega_g)}_{\Omega_{\Gamma_{v_1, v', v'', v_2}}} \right)$$

on $C_{v_1, v_2}(\mathbb{R}^3)$. By the generalized Stokes Theorem,

$$d \circ \pi_* = \pm \pi_* \circ d + \pi_{\partial*},$$

so that we have

$$(63) \quad df = \pi_{\partial*} \left(\Omega_{\Gamma_{v_1, v', v'', v_2}} \right) = \alpha_*(\Omega_{\Gamma_{v_1, v', v'', v_2}}) - \beta_*(\Omega_{\Gamma_{v_1, v, v_2}}) + \gamma_*(\Omega_{\Gamma_{v_1, v', v_2}})$$

where

$$\Gamma_{v_1, v'', v_2} := \begin{array}{c} \bullet \\ \swarrow \quad \searrow \\ v_1 \quad v'' \quad v_2 \\ \swarrow \quad \searrow \\ \bullet \end{array}, \quad \Gamma_{v_1, v, v_2} := \begin{array}{c} v_2 \\ \swarrow \quad \searrow \\ v_1 \quad v \end{array}, \quad \Gamma_{v_1, v', v_2} := \begin{array}{c} \bullet \\ \swarrow \quad \searrow \\ v_1 \quad v' \quad v_2 \\ \swarrow \quad \searrow \\ \bullet \end{array}$$

and

$$\alpha : C(\Gamma_{v_1, v'', v_2}) \rightarrow C_{v_1, v_2}(\mathbb{R}^3), \quad \beta : C(\Gamma_{v_1, v, v_2}) \rightarrow C_{v_1, v_2}(\mathbb{R}^3), \quad \gamma : C(\Gamma_{v_1, v', v_2}) \rightarrow C_{v_1, v_2}(\mathbb{R}^3)$$

are the natural forgetful maps. By Lemma **A.2**, the middle term $\beta_*(\Omega_{\Gamma_{v_1, v, v_2}})$ vanishes. On the other hand the sum,

$$\alpha_*(\Omega_{\Gamma_{v_1, v'', v_2}}) + \gamma_*(\Omega_{\Gamma_{v_1, v', v_2}})$$

equals the push down,

$$p_* \left(\pi_{v_1, v}^*(\omega_g) \wedge \pi_{v, v_2}^*(\omega_g) \right)$$

of the 4-form $\pi_{v_1, v}^*(\omega_g) \wedge \pi_{v, v_2}^*(\omega_g)$ along the 3-dimensional fiber of the natural projection,

$$p : C_{v_1, v, v_2}(\mathbb{R}^3) \longrightarrow C_{v_1, v_2}(\mathbb{R}^3).$$

The latter vanishes by the standard argument using the reflection in the line through vertices v_1 and v_2 (cf. [Ko1]).

Therefore we conclude that

$$df = 0,$$

i.e. the function f is a constant independent of a particular position of the vertex v_2 (on the sphere). Let us choose v_2 to lie in the (x, t) -plane. Then the reflection in this plane preserves the orientation of the fiber of the map (62) but changes the differential form

$$\Omega_{\Gamma_{v_1, v', v'', v_2}} \longrightarrow -\Omega_{\Gamma_{v_1, v', v'', v_2}}.$$

Hence $f = 0$ and the proof is completed. \square

Let $\hat{\mathcal{G}}_{4p+1, 6p+1}^{or}$ be the subset of the set of oriented graphs $\hat{\mathcal{G}}_{4p+1, 6p+1}^{or}$ consisting of graphs Γ which have no

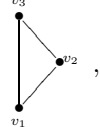
- binary vertices of arity $(1, 1)$, i.e. of the form 
- no complete subgraphs of the form ,
- no two binary vertices connected by an edge.

We proved in this Appendix the following

A.5. Proposition. *In the case $d = 3$ Proposition 3.2.4 holds true with the set of graphs $G_{4p+2,6p+1}^{or}$ replaced by its subset $\hat{G}_{4p+1,6p+1}^{or}$.*

A quick inspection of the case $p = 1$ shows that there are no graphs in $\hat{G}_{6,7}^{or}$ which satisfy the above three properties so that one gets the following

A.6. Lemma. *The set $\hat{G}_{6,7}^{or}$ is empty.*

In the case $p = 2$ one has non-trivial examples, e.g.

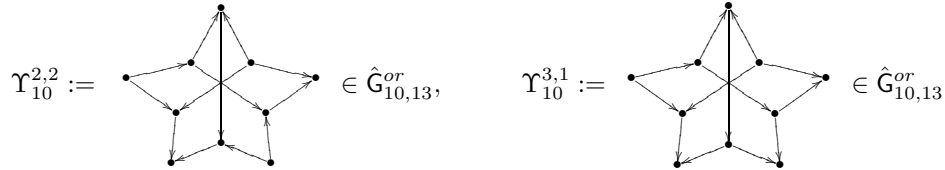

The first graph $\Upsilon_{10}^{2,2}$ has two binary vertices have type $(2, 0)$ and two binary vertices of type $(0, 2)$. The second graph $\Upsilon_{10}^{3,1}$ has three vertices of type $(2, 0)$ and one vertex of type $(0, 2)$. Reversing all arrows in $\Upsilon_{10}^{3,1}$ one obtains a graph

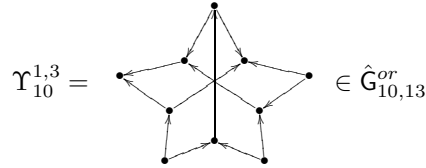

with three vertices of type $(0, 2)$ and one vertex of type $(2, 0)$.

APPENDIX B. Configuration space models for bipermutahedra and biassociahedra

A.1. Associahedron, permutahedron and configuration spaces. Here we remind two well-known constructions [St, Ko3, LTV] (see also lecture notes [Me2]) which will be used later. Let

$$\text{Conf}_n(\mathbb{R}) := \{[n] \hookrightarrow \mathbb{R}\},$$

be the space of all possible injections of the set $[n] := \{1, 2, \dots, n\}$ into the real line \mathbb{R} . This space is a disjoint union of $n!$ connected components each of which is isomorphic to the space

$$\text{Conf}_n^o(\mathbb{R}) = \{x_1 < x_2 < \dots < x_n\}.$$

The set $\text{Conf}_n(\mathbb{R})$ has a natural structure of an oriented n -dimensional manifold with orientation on $\text{Conf}_n^o(\mathbb{R})$ given by the volume form $dx_1 \wedge dx_2 \wedge \dots \wedge dx_n$; orientations of all other connected components are then fixed once we assume that the natural smooth action of \mathbb{S}_n on $\text{Conf}_n(\mathbb{R})$ is orientation preserving. In fact, we can (and often do) label points by an arbitrary finite set I , that is, consider the space of injections of sets,

$$\text{Conf}_I(\mathbb{R}) := \{I \hookrightarrow \mathbb{R}\}.$$

A 2-dimensional Lie group $G_2 = \mathbb{R}^+ \ltimes \mathbb{R}$ acts freely on $Conf_n(\mathbb{R})$ by the law,

$$\begin{array}{ccc} Conf_n(\mathbb{R}) & \times & \mathbb{R}^+ \ltimes \mathbb{R} & \longrightarrow & Conf_n(\mathbb{R}) \\ p = \{x_1, \dots, x_n\} & & (\lambda, \nu) & \longrightarrow & \lambda p + \nu := \{\lambda x_1 + \nu, \dots, \lambda x_n + \nu\}. \end{array}$$

The action is free so that the quotient space,

$$C_n(\mathbb{R}) := Conf_n(\mathbb{R})/G_2, \quad n \geq 2,$$

is naturally an $(n - 2)$ -dimensional real oriented manifold equipped with a smooth orientation preserving action of the group \mathbb{S}_n . In fact,

$$C_n(\mathbb{R}) = C_n^o(\mathbb{R}) \times \mathbb{S}_n$$

with orientation, Ω_n , defined on $C_n^o(\mathbb{R}) := Conf_n^o(\mathbb{R})/G_2$ as follows: identify $C_n^o(\mathbb{R})$ with the subspace of $Conf_n^o(\mathbb{R})$ consisting of points $\{0 = x_1 < x_2 < \dots < x_n = 1\}$ and then set $\Omega_n := dx_2 \wedge \dots \wedge dx_{n-1}$.

The space $C_2(\mathbb{R})$ is closed as it is the disjoint union, $C_2(\mathbb{R}) \simeq \mathbb{S}_2$, of two points. The topological compactification, $\overline{C}_n(\mathbb{R})$, of $C_n(\mathbb{R})$ for higher n can be defined as $\overline{C}_n^o(\mathbb{R}) \times \mathbb{S}_n$ where $\overline{C}_n^o(\mathbb{R})$ is, by definition, the closure of an embedding,

$$\begin{array}{ccc} C_n^o(\mathbb{R}) & \longrightarrow & (\mathbb{R}\mathbb{P}^2)^{n(n-1)(n-2)} \\ (x_1, \dots, x_n) & \longrightarrow & \prod_{\#\{i,j,k\}=3} [|x_i - x_j| : |x_i - x_k| : |x_j - x_k|]. \end{array}$$

Its codimension one strata are given by

$$\partial \overline{C}_n^o(\mathbb{R}) = \bigsqcup_A \overline{C}_{n-\#A+1}^o(\mathbb{R}) \times \overline{C}_{\#A}^o(\mathbb{R}),$$

where the union runs over *connected* proper subsets, A , of the ordered set $\{1, 2, \dots, n\}$. The associated collection $\overline{\mathcal{C}}(\mathbb{R}) = \{\overline{C}_n(\mathbb{R})\}$ is a free operad in the category with the set of generators,

$$\left\{ C_n^o(\mathbb{R}) \simeq \begin{array}{c} \text{---} \\ \diagup \quad \diagdown \\ \text{---} \end{array} \right\}_{n \geq 2}$$

With the above graphical notations for the generators, the compactified configuration space is the disjoint union of sets parameterized by planar rooted (equivalently, directed) trees

$$\overline{C}_n^o(\mathbb{R}) = \coprod_{T \in Tree_n} T(\mathbb{R})$$

where $Tree_n$ is the set of all planar trees with n input legs whose vertices are at least trivalent (i.e. have at least two input half-edges)⁵ and

$$T(\mathbb{R}) := \prod_{v \in V(T)} C_{\#v}^o(\mathbb{R})$$

is a set, better to say, a tree “decorated” by sets. In this decomposition the one-vertex tree corresponds to the big open cell $C_n^o(\mathbb{R}) \subset \overline{C}_n^o(\mathbb{R})$, while trees with larger number of vertices to the boundary components of the closed topological space $\overline{C}_n^o(\mathbb{R})$. Therefore the compactified space $\overline{C}_n^o(\mathbb{R})$ is homeomorphic, as a stratified topological space, to the n -th Stasheff associahedron \mathcal{K}_n , and associated to $\overline{C}_n(\mathbb{R})$ the operad of fundamental chains gives the minimal resolution, $\mathcal{A}ss_\infty$, of the operad of associative algebras.

The trees parameterizing the boundary strata of $\overline{C}_n^o(\mathbb{R})$ can also be used to define a structure of a smooth manifold with corners on $\overline{C}_n^o(\mathbb{R})$ [Ko3]. In particular, a decoration of internal edges of such a tree T with

⁵The set of internal edges of a rooted tree is denoted by $E(T)$, its set of legs by $Leg(G)$, and the set of vertices by $V(T)$; for example, picture (64) below shows a rooted tree (with directions of edges tacitly chosen to run from bottom to the top) with $\#E(T) = 3$, $\#Leg(T) = 7$ and $\#V(T) = 4$. There is a natural partial order on the set $V(T)$: $v_1 > v_2$ if and only if there is a directed path of internal edges starting at v_2 and ending at v_1 . The set $Tree_n$ also admits a partial order: $T_1 > T_2$ if and only if T_2 can be obtained from T_1 by contraction of at least one internal edge.

The configuration space model for the permutahedron was given in [LTV]. In our context (when we want to keep freedom of interpreting the limit configurations either as collapsing or as exploded) it is useful to consider the closure, $\widehat{C}_n^o(\mathbb{R})$, of $C_n^o(\mathbb{R})$ under the following embedding (cf. [LTV]),

$$\begin{aligned} C_n^o(\mathbb{R}) &\longrightarrow (\mathbb{R}\mathbb{P}^2)^{n(n-1)(n-2)} \times [0, \infty]^{n(n-1)(n-2)(n-3)} \\ (x_1, \dots, x_n) &\longrightarrow \prod_{\#\{i,j,k\}=3} [|x_i - x_j| : |x_i - x_k| : |x_j - x_k|] \times \prod_{\#\{i,j,k,l\}=4} \frac{|x_i - x_j|}{|x_k - x_l|} \end{aligned}$$

where $[0, \infty]$ is a 1-dimensional compact smooth manifold with corners with a defining coordinate chart given by

$$\begin{aligned} [0, \infty] &\longrightarrow [0, 1] \\ t &\longrightarrow \frac{t}{t+1} \end{aligned}$$

The set $\widehat{C}_n^o(\mathbb{R})$ is the disjoint union of sets parameterized by planar rooted level trees

$$\widehat{C}_n^o(\mathbb{R}) = \coprod_{T \in \mathcal{LTree}_n} T(\mathbb{R}),$$

and, as a smooth manifold with corners, can be identified with the permutahedron \mathcal{P}_{n-1} . For example, the following level trees,

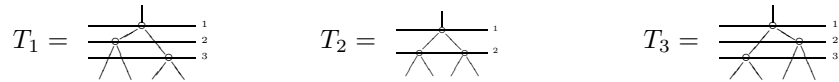

encode, respectively, the following limit configurations (as well as coordinate charts near the limit configurations) in $\mathcal{P}_3 = \widehat{C}_4^o(\mathbb{R})$:

- (i) T_1 corresponds to the point in \mathcal{P}_3 obtained in the limit $\varepsilon_1, \varepsilon_2 \rightarrow +0$ from the configurations,

$$x_1 = -1 - \varepsilon_1, \quad x_2 = -1 + \varepsilon_1, \quad x_3 = 1 - \varepsilon_1 \varepsilon_2, \quad x_4 = 1 + \varepsilon_1 \varepsilon_2,$$

- (ii) T_2 corresponds to the 1-dimensional strata in \mathcal{P}_3 obtained in the limit $\varepsilon \rightarrow +0$ from the configurations,

$$x_1 = -1 - \varepsilon x, \quad x_2 = -1 + \varepsilon x, \quad x_3 = 1 - \varepsilon x, \quad x_4 = 1 + \varepsilon x, \quad x = \frac{x_4 - x_3}{x_2 - x_1} \in (0, +\infty).$$

- (iii) T_3 corresponds to the point in \mathcal{P}_3 obtained in the limit $\varepsilon_1, \varepsilon_2 \rightarrow +0$ from the configurations,

$$x_1 = -1 - \varepsilon_1 \varepsilon_2, \quad x_2 = -1 + \varepsilon_1 \varepsilon_2, \quad x_3 = 1 - \varepsilon_2, \quad x_4 = 1 + \varepsilon_2,$$

For future reference we outline a general pattern which associates to a limit configuration, $p = \lim\{x_1, \dots, x_n\}$, in $\widehat{C}_n^o(\mathbb{R})$ a *levelled tree*:

- there is a natural projection $\pi : \widehat{C}_n^o(\mathbb{R}) \rightarrow \overline{\mathcal{C}}_n^o(\mathbb{R})$ which associates to p its image $\pi(p)$ in the associahedron and hence a unique maximal (with respect to the standard partial order in the poset \mathcal{Tree}_n) unlevelled n -tree $T \in \mathcal{Tree}_n$ such that $p \in T(\mathbb{R}) \subset \widehat{C}_n^o(\mathbb{R})$; the legs of T are naturally labelled by the set $[n]$.
- every vertex v of the unlevelled tree T from (a) stands for a collection of points $\{x_{i_v} \in \mathbb{R}\}_{i_v \in H(v)}$ parameterized by the set $H(v)$ of input half edges at $v \in T_p$ which collapse to a single point x_v in \mathbb{R} ; we introduce an equivalence relation in the set $V(T_p)$ of vertices of the tree T_p : $v' \sim v''$ if and only if $\lim \frac{|x_{i_{v'}} - x_{j_{v'}}|}{|x_{k_{v''}} - x_{l_{v''}}|}$ is a non-zero finite number for some (and hence all) $i_{v'} \neq j_{v'} \in H(v')$ and $k_{v''} \neq l_{v''} \in H(v'')$; the associated equivalence classes $[v']$ are called *levels*; we say that equivalent vertices *lie on the same level*;
- the natural partial ordering in the set of vertices, $V(T_p)$, induces a well-defined *total* ordering on the set of its levels. Indeed, if v' and v'' belong to different levels, then either $\lim \frac{|x_{i_{v'}} - x_{j_{v'}}|}{|x_{k_{v''}} - x_{l_{v''}}|} = +\infty$ (in which case the level $[v']$ lies above the level $[v'']$ in the standard pictorial representation of a tree) or $\lim \frac{|x_{i_{v'}} - x_{j_{v'}}|}{|x_{k_{v''}} - x_{l_{v''}}|} = 0$ (in which case the level $[v']$ lies below the level $[v'']$).

As a result we get a natural partition of the permutahedron,

$$\widehat{C}_n^o(\mathbb{R}) = \coprod_{(T,L) \in \mathcal{L}Tree_n} T(\mathbb{R}) \times (\mathbb{R}^+)^{|L|},$$

parameterized by leveled trees; by analogy to the case of the associahedron, one can use this partition to introduce a smooth (with corners) atlas on $\widehat{C}_n^o(\mathbb{R})$ in which each leveled tree (T, L) (with edges decorated by sufficiently small parameters and with levels decorated by arbitrary non-negative parameters) gives us a coordinate chart near the boundary strata $T(\mathbb{R}) \times (\mathbb{R}^+)^{|L|} \subset \widehat{C}_n^o(\mathbb{R})$. Thus $\widehat{C}_n^o(\mathbb{R}) = \mathcal{P}_{n-1}$ can be given a structure of smooth manifold with corners (we do not use in this paper a finer fact that \mathcal{P}_{n-1} can be identified with a polytope).

A.2. Bipermutahedron. In this and the next subsections we give a configuration space interpretation of the bipermutahedron and biassociahedron posets, \mathcal{P}_n^m and, respectively, \mathcal{K}_n^m , which were introduced and studied by Martin Markl in [Ma2]. We show that these posets can be identified with the boundary posets of certain smooth manifolds with corners (which come equipped with a natural structure of semialgebraic manifolds).

Consider a configuration space

$$Conf_{m,n}^o(\mathbb{R} \times \mathbb{R}) := Conf_m^o(\mathbb{R}) \times Conf_n^o(\mathbb{R}).$$

A point $p \in Conf_{m,n}^o(\mathbb{R} \times \mathbb{R})$ is a pair (p', p'') of collections of real numbers,

$$p' = \{x_1 < \dots < x_m\}, \quad p'' = \{y_1 < \dots < y_n\}.$$

The group $G_3 := R^+ \rtimes \mathbb{R}^2$ acts freely on $Conf_{m,n}^o(\mathbb{R} \times \mathbb{R})$ for all $m + n \geq 3$ by rescalings and translations,

$$\begin{array}{ccc} G_3 & \times & Conf_{m,n}^o(\mathbb{R} \times \mathbb{R}) & \longrightarrow & Conf_{m,n}^o(\mathbb{R} \times \mathbb{R}) \\ (\lambda, a, b) & & (p', p'') & \longrightarrow & (\lambda p' + a; \lambda^{-1} p'' + b) \end{array}.$$

The space of orbits,

$$C_{m,n}(\mathbb{R} \times \mathbb{R}) := \frac{Conf_{m,n}^o(\mathbb{R} \times \mathbb{R})}{G_3}$$

is a $(m + n - 3)$ -dimensional oriented manifold. It is clear that

$$C_{1,n}(\mathbb{R} \times \mathbb{R}) = C_{n,1}(\mathbb{R} \times \mathbb{R}) = C_n^o(\mathbb{R})$$

and we define their compactifications $\widehat{C}_{1,n}(\mathbb{R} \times \mathbb{R})$ and $\widehat{C}_{n,1}(\mathbb{R} \times \mathbb{R})$ as the permutahedron $\widehat{C}_n^o(\mathbb{R})$. For $m, n \geq 2$, there are canonical projections

$$\pi' : C_{m,n}(\mathbb{R} \times \mathbb{R}) \rightarrow C_m(\mathbb{R}), \quad \pi'' : C_{m,n}(\mathbb{R} \times \mathbb{R}) \rightarrow C_n(\mathbb{R})$$

which can be used to construct the following embedding

$$\begin{array}{ccccccc} C_{m,n}(\mathbb{R} \times \mathbb{R}) & \longrightarrow & \widehat{C}_m(\mathbb{R}) & \times & \widehat{C}_n(\mathbb{R}) & \times & [0, \infty]^{\frac{nm(n-1)(m-1)}{4}} \\ (p', p'') & \longrightarrow & p' & \times & p'' & \times & \prod_{i>j, \alpha>\beta} |x_i - x_j| |y_\alpha - y_\beta| \end{array}$$

and define the compactified configuration space $\widehat{C}_{m,n}(\mathbb{R} \times \mathbb{R})$ as the closure of the image of $C_{m,n}(\mathbb{R} \times \mathbb{R})$ under this embedding. By analogy to the case of permutahedra, the compact space $\widehat{C}_{m,n}(\mathbb{R} \times \mathbb{R})$ can be given naturally a structure of a smooth manifold with corners; in particular, this space comes with a stratification,

$$\widehat{C}_{m,n}(\mathbb{R} \times \mathbb{R}) \supset \partial \widehat{C}_{m,n}(\mathbb{R} \times \mathbb{R}) \supset \partial^2 \widehat{C}_{m,n}(\mathbb{R} \times \mathbb{R}) \supset \dots,$$

and it is not hard to check that the associated to this stratification poset is precisely the bipermutohedron poset \mathcal{P}_n^m from [Ma2]. Let us first recall from [Ma2] the definition of the poset \mathcal{P}_n^m , $m \geq 1$, $n \geq 1$, $m + n \geq 3$. For $m, n \geq 2$ the set \mathcal{P}_n^m is defined as the set of all triples, $(T^\uparrow, T_\downarrow, \ell)$, consisting of an up rooted tree

$T^\uparrow \in \mathcal{T}ree_n$, of a down-rooted tree $T_\downarrow \in \mathcal{T}ree_m$, and a strictly order preserving⁶ surjective *level function* $\ell : V(T^\uparrow) \cup V(T_\downarrow) \rightarrow [l]$. For example

$$\in \mathcal{P}_4^3$$

We define

$$|\ell| := -l + \sum_{i=1}^l \ell^{-1}(i).$$

The set \mathcal{P}_n^m is partially ordered: $(T^\uparrow, T_\downarrow, \ell) > (\tilde{T}^\uparrow, \tilde{T}_\downarrow, \tilde{\ell})$ if the latter can be obtained from the former by contraction of levels. The posets \mathcal{P}_n^1 and \mathcal{P}_1^n are identified with $\mathcal{L}Tree_n$ but their elements are still represented as *pairs* of trees with the help of the singular tree $|$ which has no vertices, for example

$$\in \mathcal{P}_3^1.$$

To each (limit) configuration, $p = \lim\{x_1, \dots, x_n\}$, in $\widehat{C}_{m,n}(\mathbb{R} \times \mathbb{R})$ we associate a uniquely defined leveled bi-tree from \mathcal{P}_m^n by a procedure which is completely analogous to the one described at the end of §A.1.1 and get, therefore, a decomposition,

$$(65) \quad \widehat{C}_{m,n}(\mathbb{R} \times \mathbb{R}) = \coprod_{(T^\uparrow, T_\downarrow, \ell) \in \mathcal{P}_m^n} T^\uparrow(\mathbb{R}) \times T_\downarrow(\mathbb{R}) \times (\mathbb{R}^+)^{|\ell|}.$$

This decomposition can be used to define a smooth (with corners) atlas on the bipermutohedron $\widehat{C}_{m,n}(\mathbb{R} \times \mathbb{R})$.

A.3. Biassociahedron. Compactifications $\overline{C}_{1,n}(\mathbb{R} \times \mathbb{R})$ and $\overline{C}_{n,1}(\mathbb{R} \times \mathbb{R})$ of the configuration spaces $C_{1,n}(\mathbb{R} \times \mathbb{R})$ and respectively $C_{n,1}(\mathbb{R} \times \mathbb{R})$ are defined as the associahedron $\overline{C}_n^o(\mathbb{R})$. For $m, n \geq 2$ we define a compactification $\overline{C}_{m,n}(\mathbb{R} \times \mathbb{R})$ of the configuration space $C_{m,n}(\mathbb{R} \times \mathbb{R})$ as the closure of the image of $C_{m,n}(\mathbb{R} \times \mathbb{R})$ under the following embedding (cf. [Sh1]),

$$\begin{aligned} C_{m,n}(\mathbb{R} \times \mathbb{R}) &\longrightarrow \overline{C}_m(\mathbb{R}) \times \overline{C}_n(\mathbb{R}) \times [0, \infty]^{\frac{nm(n-1)(m-1)}{4}} \\ (p', p'') &\longrightarrow p' \times p'' \times \prod_{i>j, \alpha>\beta} |x_i - x_j| |y_\alpha - y_\beta| \end{aligned}$$

There is a natural surjection

$$P : \widehat{C}_{m,n}(\mathbb{R} \times \mathbb{R}) \longrightarrow \overline{C}_{m,n}(\mathbb{R} \times \mathbb{R})$$

so that the partition (65) induces a partition of $\overline{C}_{m,n}(\mathbb{R} \times \mathbb{R})$. The induced partition is again parameterized by pairs of trees with an extra structure. The difference of the compactification formula for $\overline{C}_{m,n}(\mathbb{R} \times \mathbb{R})$ from the one for $\widehat{C}_{m,n}(\mathbb{R} \times \mathbb{R})$ is that we have no factors $\frac{|x_i - x_j|}{|x_k - x_l|}$ and $\frac{|y_\alpha - y_\beta|}{|y_\gamma - y_\delta|}$ which measure relative speeds of collapsing/exploding groups of points belonging solely to one of the factors in $\mathbb{R} \times \mathbb{R}$. Hence the projection P applied to the stratum $T^\uparrow(\mathbb{R}) \times T_\downarrow(\mathbb{R}) \times (\mathbb{R}^+)^{|\ell|}$ contracts to single points those factors of \mathbb{R}^+ which correspond to the levels $i \in [l]$ which have the property that either $\ell^{-1}(i) \cap V(T_\uparrow) = \emptyset$ or $\ell^{-1}(i) \cap V(T_\downarrow) = \emptyset$. However such levels do not disappear completely from the induced stratification formula as it still makes sense to compare $\ell^{-1}(i)$ with $\ell^{-1}(j)$ in the cases when $\ell^{-1}(i) \cap V(T_\uparrow) = \emptyset$ and $\ell^{-1}(j) \cap V(T^\uparrow) = \emptyset$. Thus after the projection P the level function on $V(T^\uparrow) \sqcup V(T_\downarrow)$ gets transformed into a so called *zone function* [Ma2] which, by definition, is a surjection,

$$\zeta : V(T^\uparrow) \sqcup V(T_\downarrow) \longrightarrow [l]$$

satisfying the following conditions:

- (i) if $v < u$, then $\zeta(v) \leq \zeta(u)$,
- (ii) for any pair of different elements $i, j \in [l]$ with $\zeta^{-1}(i)$ and $\zeta^{-1}(j)$ containing vertices from *both* sets $V(T^\uparrow)$ and $V(T_\downarrow)$, then $i < j$ implies $v < u$ for every vertex $v \in \zeta^{-1}(i)$ and every vertex $u \in \zeta^{-1}(j)$ such that the relation $v < u$;

⁶i.e. if $v > u$ then $\ell(v) > \ell(u)$.

- (iii) there is no $i \in [l]$ such that both subsets $\zeta^{-1}(i)$ and $\zeta^{-1}(i+1)$ belong to $V(T^\uparrow)$ or both belong to $V(T_\downarrow)$.

Elements $i \in [l]$ with $\zeta^{-1}(i) \cap V(T^\uparrow) \neq \emptyset$ and $\zeta^{-1}(i) \cap V(T_\downarrow) \neq \emptyset$ are called *barriers* and are depicted as solid horizontal lines. Elements $i \in [l]$ with $\zeta^{-1}(i) \cap V(T^\uparrow) = \emptyset$ are called *down-zones*, while elements $\zeta^{-1}(i) \cap V(T_\downarrow) = \emptyset$ are called *up-zones*; they are depicted as dashed horizontal lines. Thus condition (i) says that the zone function is order preserving, condition (ii) says that it is strictly order preserving on barriers, and condition (iii) says that there are no adjacent zones of the same type. Here are examples,

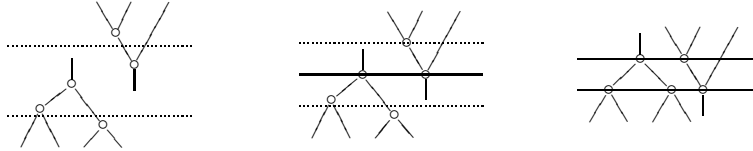

of a fixed pair of trees and three different zone functions on the set of their vertices. For a zone function ζ on $V(T^\uparrow) \sqcup V(T_\downarrow)$ we denote by $B(\zeta)$ the set of its barriers, and by $|\zeta|$ the non-negative integer,

$$|\zeta| := -l + \sum_{i \in B(\zeta)} \#\zeta^{-1}(i).$$

The compactified configuration space $\overline{C_{m,n}}(\mathbb{R} \times \mathbb{R})$, the *biassociahedron* (cf. [Ma2]), comes therefore equipped with the induced stratification

$$(66) \quad \overline{C_{m,n}}(\mathbb{R} \times \mathbb{R}) = \bigcup_{(T^\uparrow, T_\downarrow, \zeta)} T^\uparrow(\mathbb{R}) \times T_\downarrow(\mathbb{R}) \times (0, +\infty)^{|\zeta|}$$

which is parameterized by the poset \mathcal{K}_m^n consisting of triples $(T^\uparrow, T_\downarrow, \zeta)$. Therefore we often denote $\overline{C_{m,n}}(\mathbb{R} \times \mathbb{R})$ by \mathcal{K}_m^n . This decomposition can be used to define in a standard way a smooth (with corners) atlas on the biassociahedron $\mathcal{K}_m^n = \overline{C_{m,n}}(\mathbb{R} \times \mathbb{R})$ such that the associated poset

$$\overline{C_{m,n}}(\mathbb{R} \times \mathbb{R}) \supset \partial \overline{C_{m,n}}(\mathbb{R} \times \mathbb{R}) \supset \partial^2 \overline{C_{m,n}}(\mathbb{R} \times \mathbb{R}) \supset \dots,$$

is precisely the poset \mathcal{K}_n^m from [Ma2].

A.4. Example: $m+n=4$. This is the first non-trivial case. It is clear that

$$\overline{C_{3,1}}(\mathbb{R} \times \mathbb{R}) \simeq \overline{C_{1,3}}(\mathbb{R} \times \mathbb{R}) \simeq \overline{C_3}(\mathbb{R}) \simeq [0, 1].$$

Therefore in the cases $(m=1, n=2)$ and $(m=2, n=1)$ the combinatorics of the natural stratification of the compactified configuration spaces can be coded by the following pairs of trees (each pair is equipped with the only possible zone function),

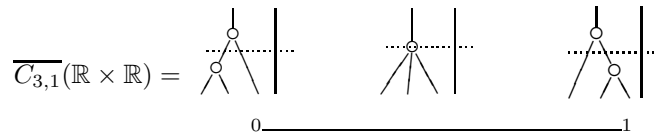

The left pair corresponds to the point $0 \in [0, 1]$, the middle one to the open interval $(0, 1)$, and the right pair of trees to the point $1 \in [0, 1]$. Turning the trees above upside down, we get a “pairs of trees” stratification of $\overline{C_{1,3}}(\mathbb{R} \times \mathbb{R})$. The trees are not leveled, but it will be useful to understand these trees as trivially *zoned* (cf. [Ma2]), i.e. as the ones in which all vertices are assigned one and the same zone value 1. We shall see below examples of trees with more than one zone.

The compactification formula says that $\overline{C_{2,2}}(\mathbb{R} \times \mathbb{R})$ is the closure of the embedding,

$$\begin{aligned} C_{2,2}(\mathbb{R} \times \mathbb{R}) &\longrightarrow [0, +\infty] \\ (x_1, x_2), (y_1, y_2) &\longrightarrow |x_2 - x_1| |y_2 - y_1| \end{aligned}$$

Thus $\overline{C_{2,2}}(\mathbb{R} \times \mathbb{R}) \simeq [0, 1]$, and the stratification $[0, 1] = 0 \sqcup (0, 1) \sqcup 1$ can be represented in terms of the pair of trees and three possible zone functions as follows,

$$\overline{C_{2,2}}(\mathbb{R} \times \mathbb{R}) = \begin{array}{c} \begin{array}{ccc} \begin{array}{c} \diagup \quad \diagdown \\ \text{---} \quad \text{---} \\ \diagdown \quad \diagup \end{array} & \begin{array}{c} \diagup \quad \diagdown \\ \text{---} \quad \text{---} \\ \diagdown \quad \diagup \end{array} & \begin{array}{c} \diagup \quad \diagdown \\ \text{---} \quad \text{---} \\ \diagdown \quad \diagup \end{array} \\ \hline 0 & & 1 \end{array} \end{array}$$

The left pair of trees corresponds to the limit $\varepsilon \rightarrow 0$ configuration

$$(x_1 = -\varepsilon, x_2 = \varepsilon), (y_1 = -1, y_2 = 1) \sim (x_1 = -1, x_2 = 1), (y_1 = -\varepsilon, y_2 = \varepsilon),$$

with $|x_2 - x_1||y_2 - y_1| \rightarrow 0$. The middle pair of trees corresponds to the generic configurations,

$$(x_1 = -x, x_2 = x), (y_1 = -y, y_2 = y) \sim (x_1 = -\varepsilon x, x_2 = \varepsilon x), (y_1 = -\frac{1}{\varepsilon}y, y_2 = \frac{1}{\varepsilon}y), \quad x, y \in \mathbb{R}^+,$$

with $|x_2 - x_1||y_2 - y_1|$ a positive finite number (so that $|x_2 - x_1| \sim |y_2 - y_1|$ and the associated vertices are on the same level). The right pair of trees corresponds to the limit $\varepsilon \rightarrow 0$ of the configuration

$$(x_1 = -1, x_2 = 1), (y_1 = -\frac{1}{\varepsilon}, y_2 = \frac{1}{\varepsilon}) \sim (x_1 = -\frac{1}{\varepsilon}, x_2 = \frac{1}{\varepsilon}), (y_1 = -1, y_2 = 1)$$

with $|x_2 - x_1||y_2 - y_1| \rightarrow +\infty$.

A.5. Example: $m + n = 5$. The cases $(m = 1, n = 4)$ and $(m = 4, n = 1)$ are completely analogous to the example discussed above. The cases $(m = 2, n = 3)$ and $(m = 3, n = 2)$ are similar so that we shall study in detail only one of them. The compactification $\overline{C_{3,2}}(\mathbb{R} \times \mathbb{R})$ is the closure of the embedding,

$$\begin{array}{ccc} C_{3,2}(\mathbb{R} \times \mathbb{R}) & \longrightarrow & \mathbb{RP}^2 \quad \times \quad [0, +\infty]^3 \\ (x_1, x_2, x_3), (y_1, y_2) & \longrightarrow & [|x_1 - x_2| : |x_1 - x_3| : |x_2 - x_3|] \quad \times \quad \begin{cases} |x_2 - x_1||y_2 - y_1| \\ |x_3 - x_1||y_2 - y_1| \\ |x_2 - x_3||y_2 - y_1| \end{cases} \end{array}$$

There are three possible pairs of trees in this case,

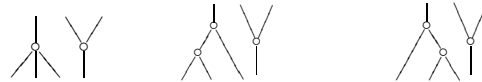

To check claim (66) we have to consider the list of all possible zone functions on these pairs, together with the associated boundary strata.

1) To the zone function  we associate, in accordance with (66), the 2-dimensional big cell

$$C_{3,2}(\mathbb{R} \times \mathbb{R}) \simeq \left\{ \begin{array}{l} (x_1 = 0, x_2 = x, x_3 = 1) \\ (y_1 = -y, y_2 = y) \end{array} \right\} \simeq (0, 1) \times (0, +\infty)$$

2) The zone function  corresponds to the 1-dimensional cell



$$\lim_{\varepsilon \rightarrow 0} \left\{ \begin{array}{l} (x_1 = 0, x_2 = x, x_3 = 1) \\ (y_1 = -\varepsilon, y_2 = \varepsilon) \end{array} \right\} \simeq (0, 1)$$

3) The zone function  corresponds to the 1-dimensional cell

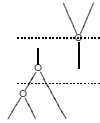
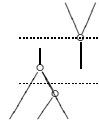

$$\lim_{\varepsilon \rightarrow 0} \left\{ \begin{array}{l} (x_1 = 0, x_2 = x, x_3 = 1) \\ (y_1 = -\frac{1}{\varepsilon}, y_2 = \frac{1}{\varepsilon}) \end{array} \right\} \simeq (0, 1)$$

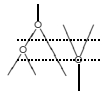
4) The zone functions  and, respectively,  correspond to 2 points which are boundaries of the closure of the strata 2) in $\overline{C_{3,2}}(\mathbb{R} \times \mathbb{R})$, i.e. they correspond, respectively, to the following two limit configuration

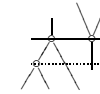

$$\lim_{\varepsilon_1, \varepsilon_2 \rightarrow 0} \left\{ \begin{array}{l} (x_1 = 0, x_2 = \varepsilon_1, x_3 = 1) \\ (y_1 = -\varepsilon_2, y_2 = \varepsilon_2) \end{array} \right. \quad \lim_{\varepsilon_1, \varepsilon_2 \rightarrow 0} \left\{ \begin{array}{l} (x_1 = 0, x_2 = 1 - \varepsilon_1, x_3 = 1) \\ (y_1 = -\varepsilon_2, y_2 = \varepsilon_2) \end{array} \right.$$

5) The zone functions  and, respectively,  correspond to 2 points which are boundaries of the closure of the strata 3) in $\overline{C_{3,2}}(\mathbb{R} \times \mathbb{R})$, i.e. they correspond, respectively, to the following two limit configuration

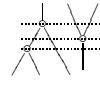

$$\lim_{\varepsilon_1, \varepsilon_2 \rightarrow 0} \left\{ \begin{array}{l} (x_1 = 0, x_2 = \varepsilon_1, x_3 = 1) \\ (y_1 = -\frac{1}{\varepsilon_1 \varepsilon_2}, y_2 = \frac{1}{\varepsilon_1 \varepsilon_2}) \end{array} \right. \quad \lim_{\varepsilon_1, \varepsilon_2 \rightarrow 0} \left\{ \begin{array}{l} (x_1 = 0, x_2 = 1 - \varepsilon_1, x_3 = 1) \\ (y_1 = -\frac{1}{\varepsilon_1 \varepsilon_2}, y_2 = \frac{1}{\varepsilon_1 \varepsilon_2}) \end{array} \right.$$

6) The zone functions  and, respectively,  correspond, respectively, to the following 1-dimensional cells,

$$\lim_{\varepsilon \rightarrow 0} \left\{ \begin{array}{l} (x_1 = 0, x_2 = \varepsilon, x_3 = 1) \\ (y_1 = -y, y_2 = y) \end{array} \right. \simeq (0, +\infty) \quad \lim_{\varepsilon \rightarrow 0} \left\{ \begin{array}{l} (x_1 = 0, x_2 = 1 - \varepsilon, x_3 = 1) \\ (y_1 = -y, y_2 = y) \end{array} \right. \simeq (0, +\infty)$$

7) The zone functions  and, respectively,  correspond, respectively, to the following points in $\overline{C_{3,2}}(\mathbb{R} \times \mathbb{R})$,

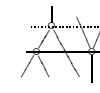
$$\lim_{\varepsilon_1, \varepsilon_2 \rightarrow 0} \left\{ \begin{array}{l} (x_1 = 0, x_2 = \varepsilon_1 \varepsilon_2, x_3 = 1) \\ (y_1 = -\frac{1}{\varepsilon_2}, y_2 = \frac{1}{\varepsilon_2}) \end{array} \right. \quad \lim_{\varepsilon_2 \rightarrow 0} \left\{ \begin{array}{l} (x_1 = 0, x_2 = 1 - \varepsilon_1 \varepsilon_2, x_3 = 1) \\ (y_1 = -\frac{1}{\varepsilon_2}, y_2 = \frac{1}{\varepsilon_2}) \end{array} \right.$$

8) The zone functions  and, respectively,  correspond, respectively, to the following 1-dimensional cells,

$$\lim_{\varepsilon \rightarrow 0} \left\{ \begin{array}{l} (x_1 = 0, x_2 = \varepsilon, x_3 = 1) \\ (y_1 = -\frac{y}{\varepsilon}, y_2 = \frac{y}{\varepsilon}) \end{array} \right. \simeq (0, +\infty) \quad \lim_{\varepsilon \rightarrow 0} \left\{ \begin{array}{l} (x_1 = 0, x_2 = 1 - \varepsilon, x_3 = 1) \\ (y_1 = -\frac{y}{\varepsilon}, y_2 = \frac{y}{\varepsilon}) \end{array} \right. \simeq (0, +\infty)$$

This list exhaust all possible natural strata of and all possible triples $(T^\uparrow \in \mathcal{T}ree_3, T_\downarrow \in \mathcal{T}ree_2, \zeta)$. The stratification formula (66) holds true in this case. Not surprisingly, $\overline{C_{3,2}}(\mathbb{R} \times \mathbb{R})$ is the hexagon from the multiplihedra family [Ma2, SU1]

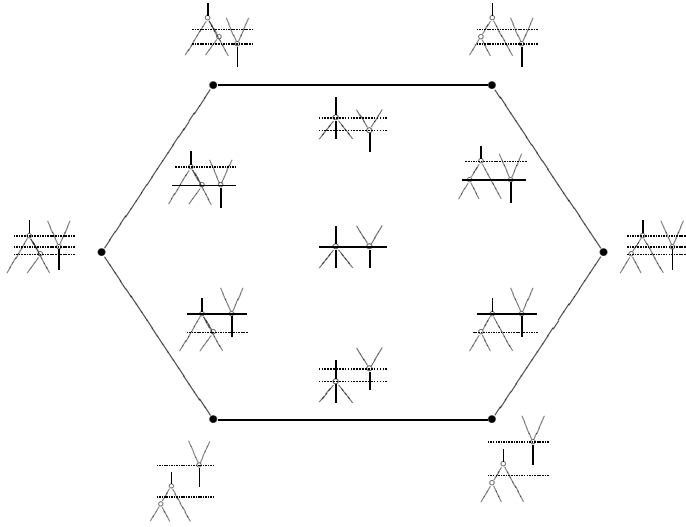

FIG. 1: BIASSOCIAHEDRON K_3^2

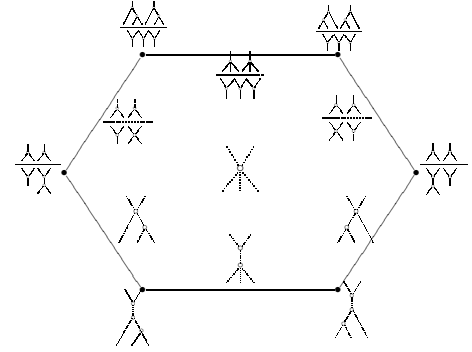

FIG. 2: $r_3^2(\mathcal{F}Chains(K_3^2))$

A.6. From biassociahedra to strongly homotopy bialgebras. As we saw in the previous subsection, the biassociahedron K_m^n is a smooth manifold with corners which comes equipped with a boundary stratification parameterized by Markl’s poset \mathcal{K}_m^n . In fact, we constructed K_m^n as a closed semi-algebraic subset in the product of copies of 2-spheres S^2 and the intervals $[0, 1]$. Hence K_m^n comes equipped with a structure of a semialgebraic set (which is finer than just the structure of a smooth manifold with corners). Kontsevich and Soibelman introduced in the Appendix 8 of [KS] a suitable theory of singular chains for such semialgebraic spaces X (see [HLTV] for full details); in this theory $Chains(X)$ is a vector space of a field \mathbb{K} group generated by (equivalence classes) of semialgebraic maps $f : Y \rightarrow X$ from oriented compact semialgebraic spaces Y . As in [KS] we assume that the semialgebraic chain complex $(Chains(X), \partial)$ is negatively graded so that the boundary operator has degree $+1$.

This canonical stratification of the biassociahedron K_m^n in terms of zoned trees gives us (i) an obvious $\frac{1}{2}$ -structure on the collection of dg \mathbb{S} -bimodules $\{Chains(K_m^n)\}_{m,n \in \mathbb{N}}$, and (ii) a $\frac{1}{2}$ -subprop $\mathcal{F}Chains(K_m^n) \subset Chains(K_m^n)$ spanned by fundamental chains which is called the dg $\frac{1}{2}$ -prop of *fundamental or cellular chains* of the biassociahedron. Unfortunately, the \mathbb{S} -submodule $\{\mathcal{F}Chains(K_m^n)\}_{m,n \in \mathbb{N}}$ is not a prop. Martin Markl constructed by induction a collection $r = \{r_m^n\}$ of linear *monomorphisms* of graded vector spaces in [Ma2],

$$r_m^n : \mathcal{F}Chains(K_m^n) \hookrightarrow AssB_\infty,$$

The image under r_3^2 of generators of $\mathcal{F}Chains(K_3^2)$ is given in FIG. 2. As we see from this example, the monomorphism r is not even homogeneous: the upper edge of K_3^2 (which is a degree -1 element in $\mathcal{F}Chains(K_3^2)$) gets mapped into a degree -2 element⁷ $\frac{\text{tree diagram}}{\text{tree diagram}}$ in $AssB_\infty$. Thus we can not use the map

r to make $\mathcal{F}Chains(K_\bullet)$ into a prop (however the collection of maps $\{r_\bullet\}$ respects $\frac{1}{2}$ -prop compositions in the dg \mathbb{S} -bimodules $\mathcal{F}Chains(K_\bullet)$ and $AssB_\infty$).

It is not hard to see how the complex $\mathcal{F}Chains(K_3^2)$ should be modified in order to make the map $r_3^2 : \mathcal{F}Chains(K_3^2) \rightarrow AssB_\infty$ into a degree zero morphism of *complexes*. One has to subdivide the upper edge of K_3^2 into the union of two edges by adding a new vertex in the middle. Equivalently, one has to replace the degree -2 element

$\frac{\text{tree diagram}}{\text{tree diagram}}$ with a *sum* of degree -1 elements, $\frac{\text{tree diagram}}{\text{tree diagram}}$, where Δ stands for a A_∞ diagonal

⁷We also use here fraction notations for elements of $AssB_\infty$ introduced in [Ma1].

[SU2, MS],

$$\Delta \begin{array}{c} \diagup \\ \diagdown \end{array} = \begin{array}{c} \diagup \\ \diagdown \end{array} \otimes \begin{array}{c} \diagup \\ \diagdown \end{array} + \begin{array}{c} \diagup \\ \diagdown \end{array} \otimes \begin{array}{c} \diagup \\ \diagdown \end{array}$$

After this subdivision one reads from \mathcal{K}_3^2 the correct formula for the value of the differential in $Ass\mathcal{B}_\infty$,

$$\delta \begin{array}{c} \diagup \\ \diagdown \end{array} = \begin{array}{c} \diagup \\ \diagdown \end{array} - \begin{array}{c} \diagdown \\ \diagup \end{array} + \begin{array}{c} \diagup \\ \diagdown \end{array} - \frac{\begin{array}{c} \diagup \\ \diagdown \end{array} \begin{array}{c} \diagup \\ \diagdown \end{array}}{\begin{array}{c} \diagdown \\ \diagup \end{array} \begin{array}{c} \diagdown \\ \diagup \end{array}} + \frac{\begin{array}{c} \diagup \\ \diagdown \end{array} \begin{array}{c} \diagup \\ \diagdown \end{array}}{\begin{array}{c} \diagdown \\ \diagup \end{array} \begin{array}{c} \diagdown \\ \diagup \end{array}} - \frac{\begin{array}{c} \Delta \\ \diagdown \end{array}}{\begin{array}{c} \diagdown \\ \diagup \end{array} \begin{array}{c} \diagdown \\ \diagup \end{array}}$$

on the (2, 3)-corolla.

Note that the definition of the Ass_∞ diagonal Δ involves choices so that the best one can hope for is to find a (non-uniquely) defined cellular refinement, $(Cell(\mathcal{K}_\bullet), \partial_{cell})$, of the fundamental chain complex of the biassociahedron together with a monomorphism complexes

$$r : Cell(\mathcal{K}_\bullet) \longrightarrow Ass\mathcal{B}_\infty$$

such that the free properad generated by “big” cells \mathcal{K}_n^m and equipped with the differential ∂_{cell} can be identified via r with some minimal resolution $Ass\mathcal{B}_\infty$ of $Ass\mathcal{B}$. The existence of such an intermediate complex

$$\mathcal{F}Chains(\mathcal{K}_\bullet) \subset Cell(\mathcal{K}_\bullet) \subset Chains(\mathcal{K}_\bullet)$$

was claimed by Samson Saneyidze and Ron Umble in [SU1].

REFERENCES

- [B] T. Backman, *Configuration spaces, props and wheel-free deformation quantization*, PhD thesis (2016), Stockholm University.
- [Do] V. Dolgushev, *Stable Formality Quasi-isomorphisms for Hochschild Cochains I*. preprint (2011). arXiv:1109.6031.
- [Dr] V. Drinfeld, *On some unsolved problems in quantum group theory*. In: Lecture Notes in Math., Springer, **1510** (1992), 1-8.
- [G] G. Gaiffi, *Compactifications of configuration spaces*, In: Algebraic Geometry Seminars, 1998-1999 (Pisa), Scuola Normale Superiore di Pisa,
- [EK] P. Etingof and D. Kazhdan. *Quantization of Lie bialgebras, I*. Selecta Math. (N.S.) **2** (1996), 1-41.
- [GJ] E. Getzler and J.D.S. Jones, *Operads, homotopy algebra, and iterated integrals for double loop spaces*, preprint hep-th/9403055.
- [GS] M. Gerstenhaber and S.D. Schack, *Bialgebra cohomology, deformations, and quantum groups*. Proc. Nat. Acad. Sci. USA, **87** (1990), 478-481.
- [GY] G. Ginot and S. Yalin, *Deformation theory of bialgebras, higher Hochschild cohomology and formality*. Preprint, arXiv:1606.01504.
- [HLT] R. M. Hardt, P. Lambrechts, V. Turchin, and I. Volić, *Real homotopy theory of semi-algebraic sets*, Algebr. Geom. Topol. **11** (2011), no. 5, 2477-2545.
- [KM] M. Kapranov and Yu.I. Manin, *Modules and Morita theorem for operads*. Amer. J. Math. **123** (2001), no. 5, 811-838.
- [KMW] A. Khoroshkin, S. Merkulov and T. Willwacher, *On Quantizable Odd Lie Bialgebras*. Lett Math Phys **106** (2016), no 9, pp. 1199–1215.
- [Ko1] M. Kontsevich, *Feynman diagrams and low-dimensional topology*. In Progr. Math., vol. 120, Birkhuser, Basel, 1994, pp. 97 - 121.
- [Ko2] M. Kontsevich, *Formality Conjecture*, D. Sternheimer et al. (eds.), Deformation Theory and Symplectic Geometry, Kluwer 1997, 139-156.
- [Ko3] M. Kontsevich, *Deformation quantization of Poisson manifolds*, Lett. Math. Phys. **66** (2003), 157-216.
- [KS] M. Kontsevich and Y. Soibelman, *Deformations of algebras over operads and the Deligne conjecture*. In Conference Moshe Flato 1999, Vol. I (Dijon), volume 21 of Math. Phys. Stud., pages 255-307. Kluwer Acad. Publ., Dordrecht, 2000.
- [LTV] P. Lambrechts, V. Turchin and I. Volic, *Associahedron, cyclohedron, and permutohedron as compactifications of configuration spaces*, Bull. Belg. Math. Soc. Simon Stevin **17** (2010), no. 2, 303-332.
- [Ma1] M. Markl, *A resolution (minimal model) of the prop for bialgebras*, J. Pure Appl. Algebra **205** (2006), no. 2, 34117374.
- [Ma2] M. Markl, *Bipermutahedron and biassociahedron*, arXiv:1209.5193
- [MMS] M. Markl, S. Merkulov and S. Shadrin, *Wheeled props and the master equation*, preprint math.AG/0610683, J. Pure and Appl. Algebra **213** (2009), 496-535.
- [MaVo] M. Markl and A.A. Voronov, *PROPPed-up graph cohomology*. Algebra, arithmetic, and geometry: in honor of Yu. I. Manin. Vol. II, 24917281, Progr. Math., 270, Birkhuser Boston, Inc., Boston, MA, 2009.
- [MS] M. Markl and S. Shnider, *Associahedra, cellular W-construction and products of A_∞ -algebras*, Transactions of the AMS **358**, Number 6 (2005) 2353-2372.
- [Me1] S.A. Merkulov, *Exotic automorphisms of the Schouten algebra of polyvector fields*, arXiv:0809.2385 (2008)

- [Me2] S.A. Merkulov, *Operads, configuration spaces and quantization*. In: “Proceedings of Poisson 2010, Rio de Janeiro”, Bull. Braz. Math. Soc., New Series **42**(4) (2011), 1-99.
- [Me3] S.A. Merkulov, *Formality Theorem for Quantizations of Lie Bialgebras*, Letters in Mathematical Physics, Volume 106, Issue 2 (2016) 169-195.
- [MV] S.A. Merkulov and B. Vallette, *Deformation theory of representations of prop(erad)s I & II*, Journal für die reine und angewandte Mathematik (Qrelle) **634**, 51-106, & **636**, 123-174 (2009)
- [MW1] S.A. Merkulov and T. Willwacher, *Deformation theory of Lie bialgebra properads*, preprint arXiv:1512.05252 (2015)
- [MW2] S.A. Merkulov and T. Willwacher, *Classification of universal formality maps for quantizations of Lie bialgebras*, preprint arXiv:1605.01282 (2016)
- [RW] C. Rossi and T. Willwacher, *P. Etingof’s conjecture about Drinfeld associators*, preprint arXiv:1404.2047 (2014)
- [SU1] S. Sanedlidze and R. Umble, *Matrads, biassociahedra, and A_∞ -bialgebras*, Homology, Homotopy Appl., **13**(1) (2011), 1-57.
- [SU2] S. Sanedlidze and R. Umble, *Diagonals on the permutahedra, multiplihedra and associahedra*, Homology, Homotopy and Applications **6** (2004) 363-411.
- [Se] P. Ševera, *Quantization of Lie bialgebras revisited*, arXiv:1401.6164 (2014)
- [Sh1] B. Shoikhet, *An explicit formula for the deformation quantization of Lie bialgebras*, arXiv:math.QA/0402046.
- [Sh2] B. Shoikhet, *An L_∞ algebra structure on polyvector fields*, preprint arXiv:0805.3363, (2008).
- [St] J.D. Stasheff. *On the homotopy associativity of H -spaces, I II*. Trans. Amer. Math. Soc., **108** (1963), 272–292 & 293–312.
- [T1] D.E. Tamarkin, *Another proof of M. Kontsevich formality theorem*, math.QA/9803025, Lett. Math. Phys. **66** (2003) 65-72.
- [T2] D.E. Tamarkin, *Quantization of lie bialgebras via the formality of the operad of little disks*, GAFA Geom. funct. anal. **17** (2007), 537-604.
- [V] B. Vallette, *A Koszul duality for props*, Trans. Amer. Math. Soc., **359** (2007), 4865–4943.
- [We] C.A. Weibel. An introduction to homological algebra, CUP, 2003.
- [W1] T. Willwacher, *M. Kontsevich’s graph complex and the Grothendieck-Teichmueller Lie algebra*, Invent. Math. **200** (2015) 671-760.
- [W2] T. Willwacher, *Stable cohomology of polyvector fields*, Math. Res. Lett. **21**, No. 6 (2014), 1501-1530.
- [W3] T. Willwacher, *Oriented graph complexes*, Comm. Math. Phys. **334** (2015), no. 3, 1649–1666.
- [W4] T. Willwacher, *Models for the n -Swiss Cheese operads*, preprint arXiv:1506.07021 (2015).

SERGEI MERKULOV: MATHEMATICS RESEARCH UNIT, LUXEMBOURG UNIVERSITY, GRAND DUCHY OF LUXEMBOURG
E-mail address: sergei.merkulov@uni.lu

THOMAS WILLWACHER: INSTITUTE OF MATHEMATICS, UNIVERSITY OF ZURICH, ZURICH, SWITZERLAND
E-mail address: thomas.willwacher@math.uzh.ch