

Target Set Selection in Dense Graph Classes

Pavel Dvořák

Computer Science Institute, Charles University, Prague, Czech Republic
koblich@iuuk.mff.cuni.cz

Dušan Knop

Department of Theoretical Computer Science, Faculty of Information Technology,
Czech Technical University in Prague, Prague, Czech Republic
dusan.knop@fit.cvutcz

Tomáš Toufar

Computer Science Institute, Charles University, Prague, Czech Republic
toufi@iuuk.mff.cuni.cz

Abstract

In this paper we study the TARGET SET SELECTION problem from a parameterized complexity perspective. Here for a given graph and a threshold for each vertex the task is to find a set of vertices (called a target set) which activates the whole graph during the following iterative process. A vertex outside the active set becomes active if the number of so far activated vertices in its neighborhood is at least its threshold.

We give two parameterized algorithms for a special case where each vertex has the threshold set to the half of its neighbors (the so-called MAJORITY TARGET SET SELECTION problem) for parameterizations by the neighborhood diversity and the twin cover number of the input graph.

We complement these results from the negative side. We give a hardness proof for the MAJORITY TARGET SET SELECTION problem when parameterized by (a restriction of) the modular-width – a natural generalization of both previous structural parameters. We also show the TARGET SET SELECTION problem parameterized by the neighborhood diversity or by the twin cover number is W[1]-hard when there is no restriction on the thresholds.

2012 ACM Subject Classification Theory of computation → Fixed parameter tractability

Keywords and phrases parameterized complexity, target set selection, dense graphs

Funding *Pavel Dvořák*: The research leading to these results has received funding from the European Research Council under the European Union’s Seventh Framework Programme (FP/2007-2013) / ERC Grant Agreement n. 616787.

Dušan Knop: Research partly supported by the OP VVV MEYS funded project CZ.02.1.01/0.0/0.0/16_019/0000765 “Research Center for Informatics”.

1 Introduction

We study the TARGET SET SELECTION problem (also called DYNAMIC MONOPOLIES), using a notation according to Kempe et al. [18], from parameterized complexity perspective. Let $G = (V, E)$ be a graph, $S \subseteq V$, and $f: V \rightarrow \mathbb{N}$ be a *threshold function*. The *activation process* arising from the set $S_0 = S$ is an iterative process with resulting sets S_0, S_1, \dots such that for $i \geq 0$

$$S_{i+1} = S_i \cup \{v \in V : |N(v) \cap S_i| \geq f(v)\},$$

where by $N(v)$ we denote the set of vertices adjacent to v . Note that after at most $n = |V|$ rounds the activation process has to stabilize – that is, $S_n = S_{n+i}$ for all $i > 0$. We say that the set S is a *target set* if $S_n = V$ (for the activation process $S = S_0, \dots, S_n$).

TARGET SET SELECTION

Input: A graph $G = (V, E)$, $f: V \rightarrow \mathbb{N}$, and a positive integer $b \in \mathbb{N}$.
Task: Find a target set $S \subseteq V$ of size at most b or report that there is no such set.

We call the input integer b the *budget*. The problem interpretation and computational complexity clearly may vary depending on the input function f . There are three important settings studied – namely constant, majority, and a general function. If the threshold function f is the majority (i.e., $f(u) = \lceil \deg(u)/2 \rceil$ for every vertex $u \in V$), we denote the problem as MAJORITY TARGET SET SELECTION.

Motivation The TARGET SET SELECTION problem was introduced by Domingos and Richardson [10] in order to study influence of direct marketing on a social network. It is noted therein that it captures e.g. *viral marketing* [24]. The TARGET SET SELECTION problem is important also from the graph theoretic viewpoint, since it generalizes many well known NP-hard problems on graphs. These problems include

- VERTEX COVER [4] – set $f(v) = \deg(v)$ for all $v \in V$.
- IRREVERSIBLE k -CONVERSION SET [11], k -NEIGHBORHOOD BOOTSTRAP PERCOLATION [2] – the TARGET SET SELECTION problem with all thresholds fixed to a constant value k .

1.1 Previous Results

The TARGET SET SELECTION problem received attention of researchers in theoretical computer science in the past years. A general upper bound on the number of selected vertices under majority constraints is $|V|/2$ [1]. The TARGET SET SELECTION problem admits an FPT algorithm when parameterized by the vertex cover number [22]. A $t^{\mathcal{O}(w)}$ poly(n) algorithm is known, where w is the tree-width of the input graph and t is an upper-bound on the threshold function [3], that is, $f(v) \leq t$ for every vertex v . This is essentially optimal, as the TARGET SET SELECTION problem parameterized by the path-width is W[1]-hard for majority [6] and general functions [3]. The TARGET SET SELECTION problem is solvable in linear time on trees [4] and more generally on block-cactus graphs [5]. The optimization variant of the TARGET SET SELECTION problem is hard to approximate [4] within a polylogarithmic factor. For more and less recent results we refer the reader to a survey by Peleg [23]. Cicalese et al. [8, 7], considered versions of the problem in which the number of rounds of the activation process is bounded. For graphs of bounded clique-width, given parameters a, b, ℓ , they gave polynomial-time algorithms (XP algorithms) to determine whether there exists a target set of size b , such that at least a vertices are activated in at most ℓ rounds. Recently, Hartmann [16] gave a single-exponential FPT algorithm for TARGET SET SELECTION parameterized by clique-width when all thresholds are bounded by a constant.

1.2 Our Results

In this work we generalize some results obtained by Nichterlein et al. [22]. Chopin et al. [6] essentially proved that in sparse graph classes (such as graphs with the bounded tree-width) parameterized complexity of the MAJORITY TARGET SET SELECTION problem is the same

as for the TARGET SET SELECTION problem¹. For these graph classes, it is not hard to see that e.g. if the threshold for vertex v is set above the majority (i.e., $f(v) > \lceil \deg(v)/2 \rceil$), then we may add $2(f(v) - \lceil \deg(v)/2 \rceil)$ vertices neighboring v only and the parameter stays unchanged whereas the threshold of v dropped to majority. However, this is not true in general for dense graph classes. We demonstrate this phenomenon for the parameterization by the neighborhood diversity. We show an FPT algorithm for a function which generalizes both constant and majority threshold functions. We call this function uniform (and the corresponding problem UNIFORM TARGET SET SELECTION), see the next section for a proper definition. Roughly speaking, all vertices belonging to a same part of a graph decomposition must possess the same value of the threshold function. In slight contrast to previous results, we derive an FPT algorithm that, instead of the maximal threshold value t , depends on the size of the image of the threshold function for graphs having bounded neighborhood diversity.

► **Theorem 1.** *There is an FPT algorithm for the UNIFORM TARGET SET SELECTION problem parameterized by the neighborhood diversity of the input graph.*

However, the problem is hard if the threshold function is not restricted. We prove W[1]-hardness of the problem and also a lower bound of algorithm running time based on ETH. The Exponential-Time Hypothesis (ETH) of Impagliazzo and Paturi [17] asserts that there is no $2^{o(n)}$ algorithm solving the SATISFIABILITY problem, where n is the number of variables.

► **Theorem 2.** *The TARGET SET SELECTION problem is W[1]-hard parameterized by the neighborhood diversity of the input graph. Moreover, unless ETH fails, there is no algorithm of running time $f(k)n^{o(k/\log k)}$ solving TARGET SET SELECTION, where k is the neighborhood diversity of the input graph.*

The complexity of the MAJORITY TARGET SET SELECTION problem is not resolved for parameterization by the cluster vertex deletion number [6] (the number of vertices whose removal from the graph results in a collection of disjoint cliques). We have a positive result for a slightly stronger parameterization - the twin cover number. We assume that the edge set between the deletion set and the rest of the graph is somewhat homogeneous, that is, two adjacent vertices in the cluster graph (i.e., a disjoint union of cliques) are true twins.

► **Theorem 3.** *There is an FPT algorithm for the UNIFORM TARGET SET SELECTION problem parameterized by the twin cover number of the input graph.*

► **Theorem 4.** *The TARGET SET SELECTION problem is W[1]-hard parameterized by the twin cover number of the input graph. Moreover, unless ETH fails, there is no algorithm of running time $f(k)n^{o(k/\log k)}$ solving TARGET SET SELECTION, where k is the twin cover number of the input graph.*

Previous result [6] implies that the parameterized complexity of the TARGET SET SELECTION and the MAJORITY TARGET SET SELECTION problems is the same in graphs with bounded clique-width. Of course, much more is known – the proof therein shows that the MAJORITY TARGET SET SELECTION problem is W[1]-hard on graphs of the bounded tree-depth (even though only the tree-width is claimed). We show that this is also the case for parameterization by the (restricted) modular-width which is a parameter generalizing both the neighborhood diversity and the twin cover number.

¹ There is an FPT algorithm for both problems parameterized by the vertex cover number, but the problems parameterized by the tree-width are W[1]-hard

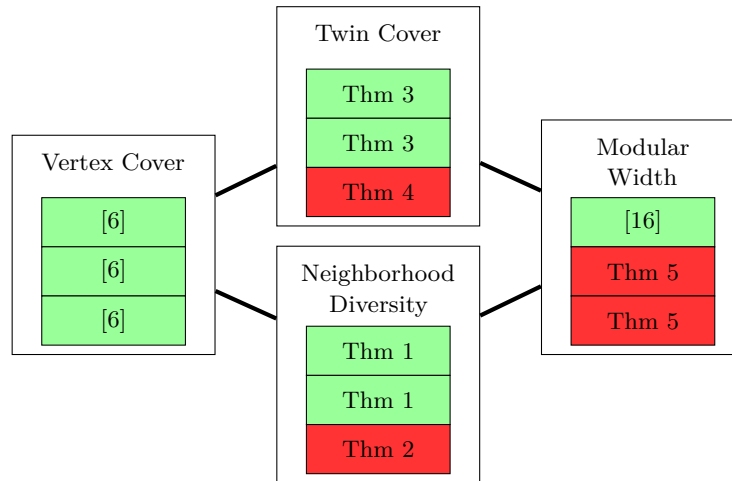

■ **Figure 1** A map of considered parameterizations and specializations of the TARGET SET SELECTION problem. The three boxes represent from the top the constant threshold TARGET SET SELECTION, MAJORITY TARGET SET SELECTION, and TARGET SET SELECTION problems. Green (light gray) boxes represent FPT algorithms, red (dark gray) boxes represent W[1]-hardness result.

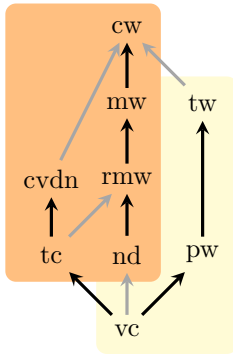

■ **Figure 2** A map of the considered parameters. A black arrow stands for a linear upper bound, while a gray arrow stands for an exponential upper bound. That is, if a graph G has $vc(G) \leq k$, then $nd(G) \leq 2^k + k$.

► **Theorem 5.** *The MAJORITY TARGET SET SELECTION problem is W[1]-hard parameterized by the modular-width of the input graph. Moreover, unless ETH fails, there is no algorithm of running time $f(k)n^{o(k/\log k)}$ solving MAJORITY TARGET SET SELECTION, where k is the modular-width of the input graph.*

2 Preliminaries

In this section we give formal definitions of several graph parameters used in this work. To get better acquainted with these parameters and their relations, we provide a Hasse diagram of the considered parameters in Figure 2.

For a graph $G = (V, E)$ the set $U \subseteq V$ is called a *vertex cover* of G if for every edge $e \in E$ it holds that $e \cap U \neq \emptyset$. The *vertex cover number* of a graph, denoted as $vc(G)$, is the least integer k for which there exists a vertex cover of size k .

As the vertex cover number is (usually) too restrictive, many authors focused on defining other (i.e., weaker) structural parameters. Three most well-known parameters of this kind are the path-width, the tree-width (introduced by Robertson and Seymour [25]), and the clique-width (introduced by Courcelle et al. [9]). Classes of graphs with the bounded tree-width

(respectively the path-width) are contained in the so-called sparse graph classes.

There are (more recently introduced) structural graph parameters which also generalize the vertex cover number but, in contrast with e.g. the tree-width, these parameters focus on dense graphs. First, up to our knowledge, of these parameters is the *neighborhood diversity* defined by Lampis [19].

Neighborhood Diversity We say that two distinct vertices u, v are of the same *neighborhood type* if they share their respective neighborhoods, that is, when $N(u) \setminus \{v\} = N(v) \setminus \{u\}$.

► **Definition 6** (Neighborhood diversity [19]). *A graph $G = (V, E)$ has the neighborhood diversity at most w ($\text{nd}(G) \leq w$) if there exists a decomposition $\mathcal{D}_{\text{nd}} = (C_i)_{i=1}^w$ of $V = C_1 \dot{\cup} \dots \dot{\cup} C_w$ (we call the sets C_i types) such that all vertices in a type have the same neighborhood type (i.e., are twins).*

Note that every type induces either a clique or an independent set in G and two types are either joined by a complete bipartite graph or no edge between vertices of the two types is present in G . Thus, we use a notion of a *type graph*, that is, a graph T_G representing the graph G and its neighborhood diversity decomposition in the following way. The vertices of the type graph T_G are the types C_1, \dots, C_w and two such vertices are joined by an edge if all the vertices of corresponding types are adjacent. It is possible to compute the neighborhood diversity of a graph in linear time [19].

Twin Cover If two vertices u, v have the same neighborhood type and $e = \{u, v\}$ is an edge of the graph, we say that e is a *twin edge*.

► **Definition 7** (Twin cover number [14]). *A set of vertices $T \subseteq V$ is a twin cover of a graph $G = (V, E)$ if for every edge $e \in E$ either $T \cap e \neq \emptyset$ or e is a twin edge. We say that G has the twin cover number t ($\text{tc}(G) = t$) if the size of a minimum twin cover of G is t .*

Note that after removing T from the graph G , the resulting graph is a disjoint union of cliques – we call them *twin cliques*. Moreover, for every vertex v in T and a twin clique C it holds that v is either adjacent to every vertex in C or to none of them. A *twin cover decomposition* $\mathcal{D}_{\text{tc}} = (C_i)_{i=1}^t$ of a graph G is a partition of $V(G)$ such that each C_i is either a vertex of the twin cover or a twin clique.

Note that the twin cover number can be upper-bounded by the vertex cover number. The structure of graphs with bounded twin cover is very similar to the structure of graphs with bounded vertex cover number. Thus, there is a hope that many of known algorithms for graphs with bounded vertex cover number can be easily turned into algorithms for graphs with bounded twin cover number [14].

Uniform Threshold Function As it is possible to compute the neighborhood diversity (or the twin cover) decomposition in polynomial time (or FPT-time, respectively), we may assume that the decomposition is given in the input. Given a decomposition \mathcal{D} (\mathcal{D}_{nd} or \mathcal{D}_{tc}) a threshold function $f: V(G) \rightarrow \mathbb{N}$ is *uniform with respect to \mathcal{D}* if $f(u) = f(v)$ for every $u, v \in C$ and every $C \in \mathcal{D}$. Observe that this notion generalizes the previously studied model [6] in which the threshold function is required to satisfy $f(u) = f(v)$ whenever $|N(u)| = |N(v)|$, since this indeed holds if $u, v \in C$ and $C \in \mathcal{D}$. It is not hard to see that the uniform function generalizes both the constant and the majority functions for the twin cover number and the neighborhood diversity.

Moreover, if $f(v)$ is bounded by a constant c for all $v \in V(G)$, then there exists \mathcal{D}_{nd} with $|\mathcal{D}_{\text{nd}}| \leq c \cdot \text{nd}(G)$ such that f is uniform with respect to \mathcal{D}_{nd} . We stress here that this construction is not legal for the twin cover decompositions. UNIFORM TARGET SET SELECTION is a variant of TARGET SET SELECTION, where the input instance (G, f, b, \mathcal{D}) is restricted in such a way that the function f is uniform with respect to \mathcal{D} .

Modular-width Both the neighborhood diversity and the twin cover number are generalized by the modular-width. Here we deal with graphs created by an algebraic expression that uses the following four operations:

1. Create an isolated vertex.
2. The *disjoint union* of two graphs, that is from graphs $G = (V, E), H = (W, F)$ create a graph $(V \cup W, E \cup F)$.
3. The *complete join* of two graphs, that is from graphs $G = (V, E), H = (W, F)$ create a graph with vertex set $V \cup W$ and edge set $E \cup F \cup \{\{v, w\} : v \in V, w \in W\}$. Note that the edge set of the resulting graph can be also written as $E \cup F \cup (V \times W)$.
4. The *substitution operation* with respect to a template graph T with vertex set $\{v_1, v_2, \dots, v_k\}$ and graphs G_1, G_2, \dots, G_k created by an algebraic expression; here $G_i = (V_i, E_i)$ for $i = 1, 2, \dots, k$. The substitution operation, denoted by $T(G_1, G_2, \dots, G_k)$, results in the graph on vertex set $V = V_1 \cup V_2 \cup \dots \cup V_k$ and edge set

$$E = E_1 \cup E_2 \cup \dots \cup E_k \cup \bigcup_{\{v_i, v_j\} \in E(T)} \{\{u, v\} : u \in V_i, v \in V_j\}.$$

► **Definition 8** (Modular-width [13]). *Let A be an algebraic expression that uses only operations 1–4 above. The width of the expression A is the maximum number of operands used by any occurrence of operation 4 in A . The modular-width of a graph G , denoted $\text{mw}(G)$, is the least positive integer k such that G can be obtained from such an algebraic expression of width at most k .*

An algebraic expression of width $\text{mw}(G)$ can be computed in linear time [26].

Restricted Modular-width We would like to introduce here a restriction of the modular-width that still generalizes both the neighborhood diversity and the twin cover number. The algebraic expression used to define a graph G may contain the substitution operation at most once and if it contains the substitution operation it has to be the last operation in the expression. However, there is no limitation for the use of operations 1–3.

3 Positive Results

In this section we give proofs of Theorem 1 and 3. In the first part we discuss the crucial property of dense structural parameters we study here – the uniformity of neighborhoods. This, opposed to e.g. the cluster vertex deletion number, allows us to design parameterized algorithms. In this section by a decomposition \mathcal{D} we mean a neighborhood diversity decomposition or a twin cover decomposition.

► **Lemma 9.** *Let $G = (V, E)$ be a graph, \mathcal{D} be a decomposition of G , $S \subseteq V$ be a target set, and f be a uniform threshold function with respect to \mathcal{D} . Let $C \in \mathcal{D}$ and $S_0 = S, S_1, \dots$ be an activation process arising from S . There exists $j_C \in \mathbb{N}_0$ such that:*

1. For all $i < j_C$ holds that $S_i \cap C = S_0 \cap C$.
2. For all $i \geq j_C$ holds that $S_i \cap C = C$.

Proof. For $i = 0$ clearly holds Part 1. Moreover, if $S_0 \cap C = C$, then $j_C = 0$ and the lemma holds.

Now suppose there is $u \in V(C) \setminus S_0$ which is activated in the round j . All vertices in $V(C) \setminus S_0$ have the same threshold as v and the same neighborhood. Thus, all vertices in $V(C) \setminus S_0$ is activated in the round j as well and we can define j_C as j . ◀

Let $C \in \mathcal{D}$. For a threshold function f which is constant on C we define $f'(C)$ as $f(v)$ for arbitrary vertex v in C . We say that C is *activated in round* j_C , given by Lemma 9. We denote $a_i^S(v)$ the number $|S_{i-1} \cap N(v)|$, i.e., the number of active neighbors of v in the round $i - 1$ in the activation process arising from the set S . Thus, a vertex v is activated in the first round i when $a_i^S(v) \geq f(v)$ holds but $a_{i-1}^S(v) < f(v)$. We can suppose that for every vertex $v \in V(G)$ holds that $f(v) \leq \deg(v)$, otherwise there is clearly no target set for G .

3.1 Uniformity and Twin Cover

In this subsection we present an algorithm for UNIFORM TARGET SET SELECTION parameterized by the twin cover number.

Trivial Bounds on the Minimum Target Set Let $G = (V, E)$ be a graph with a twin cover T of size t and let C_1, C_2, \dots, C_q be the twin cliques of G . For a twin clique C by $N(C)$ we denote the common twin cover neighborhood, that is, $N(v) \cap T$ for any $v \in C$. We show there is a small number of possibilities how the optimal target set can look like. Let $b_C = \max(f'(C) - |N(C)|, 0)$ for a twin clique C . Observe that we need to select at least b_C vertices of the twin clique C to any target set.

The first preprocessing we do here is with twin cliques C having $N(C) = \emptyset$. Clearly, since TARGET SET SELECTION is solvable in polynomial time on a clique C , we can remove C from G and reduce the budget b accordingly. Thus, from now we assume $N(C) \neq \emptyset$ for all twin cliques C .

▶ **Observation 10.** *If the minimum target set of G has size s , then $B \leq s \leq B + t$ for $B = \sum_{i=1}^q b_{C_i}$.*

Proof. Let S be a target set for G of size s . Suppose there is a twin clique C such that $|S \cap V(C)| = p < b_C$. It means that $b_C > 0$. Let $v \in C \setminus S$. Note that $p < |V(C)|$ as $f'(C) \leq |C| + |N(C)|$. Thus, the vertex v exists. For the vertex v it holds that $a_i^S(v) \leq p + |N(C)|$ for every round i of the activation process. Thus, the vertex v is never activated because $p + |N(C)| < b_C + |N(C)| = f'(C)$ and S is not a target set. On the other hand, if we put b_C vertices from each twin clique C into a set S' , then the set $S' \cup T$ is a target set because every vertex not in S' is activated in the first round. ◀

Structure of the Solution Let $(G, f, b, \mathcal{D}_{tc})$ be an instance of UNIFORM TARGET SET SELECTION with $tc(G) = t$. By Observation 10, if $b < \sum b_C$, then we automatically reject. On the other hand, if $b \geq t + \sum b_C$, then we automatically accept. Let $w = b - \sum b_C$. Thus, to find a target set of size b we need to select w *excess vertices* from the twin cliques and the twin cover. We will show there are at most $g(t)$ interesting choices for these w excess vertices for some computable function g and those choices can be efficiently generated. Since we can check if a given set $S \subseteq V(G)$ is a target set in polynomial time, we conclude there is an FPT algorithm for UNIFORM TARGET SET SELECTION.

We start with an easy preprocessing. Let C be a twin clique with $b_C > 0$. We select b_C vertices $V' \subseteq C$ and remove them from the graph G . We also decrease the threshold value

by b_C of every vertex which was adjacent to V' (recall that vertices in V' have the same neighborhood type, thus any vertex adjacent to some vertex in V' is adjacent to all vertices in V'). Formally, we get an equivalent instance $(G_1, f_1, b - b_C, \mathcal{D}'_{tc})$, where G_1 is G without vertices V' , \mathcal{D}'_{tc} is \mathcal{D}_{tc} restricted to $V(G_1)$ and

$$f_1(v) = \begin{cases} f(v) & v \notin N_G(V') \\ f(v) - b_C & v \in N_G(V'). \end{cases}$$

It is easy to see that the instances $(G, f, b, \mathcal{D}_{tc})$ and $(G_1, f_1, b - b_C, \mathcal{D}'_{tc})$ are equivalent, since any target set for G needs at least b_C vertices in the twin clique C due to Observation 10. Note that the function f_1 is uniform with respect to \mathcal{D}'_{tc} ; which follows from the same fact as for the function f . We repeat this process for all twin cliques. Furthermore, if there is a vertex v with $f_1(v) \leq 0$, we delete it and decrease $f_1(w)$ by 1 for each $w \in N(v)$. From now on, we suppose that the instance $(G, f', b, \mathcal{D}_{tc})$ is already preprocessed. Thus, for every twin clique C it holds that $b_C = 0$ and $f'(C) \leq |N(C)| \leq t$.

We say that a twin clique C is of a *type* (Q, r) for $Q \subseteq T$ and $1 \leq r \leq t$ if $Q = N(C)$ and $f'(C) = r$. Note that there are at most $t \cdot 2^t$ distinct types of the twin cliques.

We start to create a possible target set S of size b . We add w_1 (for some $w_1 \leq w$) vertices from the twin cover T to S (there are at most 2^t such choices). Now we need to select $w_2 = w - w_1$ excess vertices from twin cliques to S .

The number of the twin cliques of one type may be large. Thus, for the twin cliques we need some more clever way than try all possibilities. The intuition is that if we want to select some excess vertices from a clique of type (Q, r) it is a “better” choice to select the vertices from large cliques of type (Q, r) . We assign to each type (Q, r) a number $w_{(Q,r)}$ how many excess vertices would be in twin cliques of type (Q, r) . We prove that it suffices to distribute $w_{(Q,r)}$ excess vertices among the $w_{(Q,r)}$ largest twin cliques of the type (Q, r) .

► **Definition 11.** Let C_1, \dots, C_p be twin cliques of type (Q, r) ordered by the size in a descending order, i.e., for all $1 \leq i < p$ it holds that $|C_i| \geq |C_{i+1}|$. We say that a target set has a hole (C_i, C_j) for $j > i$ if $|S \cap C_i| = 0$ and $|S \cap C_j| \geq 1$. A target set is (Q, r) -leaky if it has a hole and it is (Q, r) -compact otherwise.

Our goal is to prove that if there is a target set S which is (Q, r) -leaky, then there is also a target set R which is (Q, r) -compact and $|R| = |S|$. After that we prove that there is only small number of compact targets, thus we can try all of them.

► **Lemma 12.** Suppose S is a target set for a graph G with a threshold function f and S is (Q, r) -leaky for some twin clique type (Q, r) . Then, there is a target set \tilde{S} such that:

1. It holds that $|\tilde{S}| = |S|$.
2. The sets \tilde{S} and S differ only at the twin cliques of the type (Q, r) .
3. The set \tilde{S} is (Q, r) -compact.

As the proof is a bit technical, we postpone it after we finish the algorithm using the above lemma.

Finishing the Algorithm By Lemma 12 we know that if there is a (Q, r) -leaky target set S , then there is a (Q, r) -compact target set \tilde{S} of the same size. Moreover, sets S and \tilde{S} differ only at the twin cliques of the type (Q, r) . Thus, if we repeat the procedure for all types, we get a target set without any hole. To summarize how to distribute w excess vertices:

1. Pick w_1 vertices from the twin cover T , in total 2^t choices.

2. Distribute $w_2 = w - w_1$ excess vertices among $t \cdot 2^t$ types of the twin cliques, in total $(t \cdot 2^t)^t = 2^{\mathcal{O}(t^2)}$ choices.
3. Distribute $w_{(Q,r)}$ excess vertices among the $w_{(Q,r)}$ largest cliques of type (Q, r) , in total t^t choices.

By this we create $2^{\mathcal{O}(t^2)}$ candidates for a target set. For each candidate we test whether it is a target set for G or not. If any candidate set is a target set, then we find a target set of size b . If no candidate set is a target set, then by argumentation above we know the graph G has no target set of size (at most) b . This finishes the proof of Theorem 3.

Proof of Lemma 12

Delayed Activation Process For a better analyzing the activation process we introduce a little bit more general notion. Besides the threshold function we also have a delay function $d: V(G) \rightarrow \mathbb{N}$. Let $S \subseteq V(G)$. The *delayed activation process* arising from the set S is $S = S_0, S_1, \dots$, where

$$S_{i+1} = S_i \cup \{v \in V : |N(v) \cap S_i| \geq f(v) \text{ and } i+1 \geq d(v)\}.$$

Thus, a vertex v cannot be activated before the round $d(v)$. We say the set S is a *delayed target set* if there is some j such that $S_j = V(G)$. Note that a target set is a special case of a delayed target set for a delay function $d(v) = 0$ for all vertices $v \in V(G)$.

► **Observation 13.** *Let S be a delayed target set for a graph G , a threshold function f , and a delay function d . Then, S is a target set for the graph G and the threshold function f .*

Proof. The delayed condition of vertex activation is more restrictive than the condition for the standard activation process. Suppose a vertex v is activated in the round i during a delayed activation process. Then, the vertex v is certainly activated during the round i of the standard activation process at the latest. ◀

Now we are ready to prove Lemma 12. The idea of the proof is to create the target set \tilde{S} from S by removing vertices from C_j and adding the same number of vertices from C_i for any hole (C_i, C_j) .

Proof of Lemma 12. Let T be a twin cover of the graph G . Let C_1, \dots, C_p be order of all twin cliques of the type (Q, r) as in Definition 11 and let (C_i, C_j) be a hole in the target set S . Let $\mathcal{S} = (S = S_0, S_1, \dots)$ be an activation process arising from S and the clique C_j is activated in the round j' and the clique C_i in the round i' of the activation process \mathcal{S} .

First, we show that $j' \leq i'$. Since C_i is activated in the round i' and $S_{i'-1} \cap C_i = \emptyset$, there is $f'(C_i)$ active vertices in $Q \subseteq T$ in the round $i' - 1$. Since $f'(C_j) = f'(C_i) \leq |S_{i'} \cap Q|$, the clique C_j is activated at most in the round i' (i.e., $C_j \subseteq S_{i'}$). Therefore, $j' \leq i'$.

We create a delayed target set R from S by removing vertices from C_j and adding the same number of vertices from C_i ; see Figure 3. Formally,

$$R = (S \setminus C_j) \cup X,$$

where $X \subseteq C_i$ and $|X| = |S \cap C_j|$. Let $Y \subseteq C_i \setminus X$ such that $|Y| = |C_j \setminus S|$. We set the delay function d as follows

$$d(v) = \begin{cases} j' & v \in Y, \\ i' & v \in (C_i \setminus (X \cup Y)) \cup C_j, \\ 0 & \text{otherwise.} \end{cases}$$

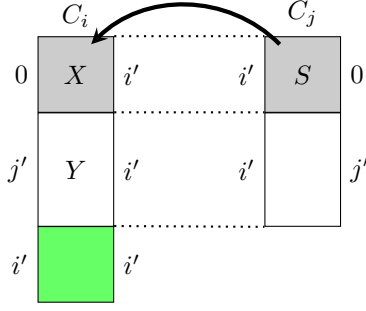

■ **Figure 3** An illustration of how we create the set R from the set S . There are rounds when the parts of cliques are activated during the activation process \mathcal{S} or \mathcal{R} on the right or left, respectively.

Let $\mathcal{R} = (R = R_0, R_1, \dots)$ be an activation process arising from the set R . The meaning of the delay d is that parts of the clique C_i (the sets X and Y) will behave in the activation process \mathcal{R} in the same manner as the clique C_j in the activation process \mathcal{S} .

Proof.

1. For every k it holds that $S_k \cap T \subseteq R_k \cap T$ and $S_k \cap C \subseteq R_k \cap C$ for every twin clique C different from C_i and C_j .
2. For every vertex v in the cliques C_i and C_j holds that $v \in R_{d(v)}$.

◁

Immediate corollary of Claim 3.1 is that R is a delayed target set such that $|R| = |S|$. By Observation 13, we get that R is also a target set. The set R contains at least one less hole than the set S . Therefore, if we repeat this procedure we eventually get the sought (Q, r) -compact target set \tilde{S} . ◀

Proof of Claim 3.1. We prove Claim 3.1 by induction on the number of round k . It is clear it holds for $k = 0$ because of the construction of the set $R_0 = R$. Now suppose it holds for $k \geq 0$ and we will prove it for $k + 1$. Recall that for every vertex v not in the cliques C_i and C_j holds that $d(v) = 0$. Let $v \in (S_{k+1} \setminus S_k) \cap T$. Let \mathcal{C}_v be the set of twin cliques C such that $v \in N(C)$ and $T_v = T \cap N(v)$, i.e., the neighbors of v in T . Then,

$$a_{k+1}^S(v) = \sum_{C \in \mathcal{C}_v} |S_k \cap C| + |S_k \cap T_v| \geq f(v).$$

Suppose $v \notin Q$. Then, by induction hypothesis (Part 1 in the claim), it holds that

$$f(v) \leq a_{k+1}^S(v) = \sum_{C \in \mathcal{C}_v} |S_k \cap C| + |S_k \cap T_v| \leq \sum_{C \in \mathcal{C}_v} |R_k \cap C| + |R_k \cap T_v| = a_{k+1}^R(v).$$

Therefore, $v \in R_{k+1} \cap T$.

Now suppose $v \in Q$. We distinguish three cases: $k + 1 \leq j'$, $j' < k + 1 \leq i'$, and $i' < k + 1$. Suppose $k + 1 \leq j'$. Thus, the vertex v is activated at most in the same round as the clique C_j in the activation process \mathcal{S} . Note that in the activation process \mathcal{R} the only active neighbors of the vertex v in the clique C_i and C_j are those vertices in the set X (which has the same size as $S_0 \cap C_j$). Then,

$$\begin{aligned} f(v) \leq a_{k+1}^S(v) &= \sum_{C \in \mathcal{C}_v} |S_k \cap C| + |S_k \cap T_v| \\ &= \sum_{C \in \mathcal{C}_v \setminus \{C_i, C_j\}} |S_k \cap C| + |S_0 \cap C_j| + |S_k \cap T_v| \\ &\leq \sum_{C \in \mathcal{C}_v \setminus \{C_i, C_j\}} |R_k \cap C| + |X| + |R_k \cap T_v| = a_{k+1}^R(v). \end{aligned}$$

Thus, $v \in R_{k+1}$. The other cases are similar, now suppose that $j' < k + 1 \leq i'$, i.e., the vertex v is activated in the activation process \mathcal{S} after the clique C_j but before the clique C_i . We consider this case only if $j' < i'$. In the activation process \mathcal{R} the vertices in X and Y are the only active vertices in the cliques C_i and C_j (recall that $|X| + |Y| = |C_j|$).

$$\begin{aligned} f(v) &\leq a_{k+1}^S(v) = \sum_{C \in \mathcal{C}_v} |S_k \cap C| + |S_k \cap T_v| = \sum_{C \in \mathcal{C}_v \setminus \{C_i, C_j\}} |S_k \cap C| + |C_j| + |S_k \cap T_v| \\ &\leq \sum_{C \in \mathcal{C}_v \setminus \{C_i, C_j\}} |R_k \cap C| + |X| + |Y| + |R_k \cap T_v| = a_{k+1}^R(v) \end{aligned}$$

The last case $i' < k + 1$ is when the vertex v is activated after the activation of both cliques C_i and C_j in the both processes.

$$\begin{aligned} f(v) &\leq a_{k+1}^S(v) = \sum_{C \in \mathcal{C}_v} |S_k \cap C| + |S_k \cap T_v| \\ &= \sum_{C \in \mathcal{C}_v \setminus \{C_i, C_j\}} |S_k \cap C| + |C_j| + |C_i| + |S_k \cap T_v| \\ &\leq \sum_{C \in \mathcal{C}_v \setminus \{C_i, C_j\}} |R_k \cap C| + |C_j| + |C_i| + |R_k \cap T_v| = a_{k+1}^R(v). \end{aligned}$$

In all three cases the vertex v has more than $f(v)$ active neighbors in the round $k + 1$ of the process \mathcal{R} . Therefore, $v \in R_{k+1}$.

Now let $v \in (S_{k+1} \setminus S_k) \cap C$ for some twin clique $C \neq C_i, C_j$. Let (Q', r') be a type of C . Thus by induction hypothesis,

$$f(v) \leq a_{k+1}^S(v) = |S_0 \cap C| + |S_k \cap Q'| \leq |R_0 \cap C| + |R_k \cap Q'| = a_{k+1}^R(v).$$

Therefore, $v \in R_{k+1}$.

It remains to prove the claim about the cliques C_i and C_j . It is clear that for a vertex $v \in X$ holds that $v \in R_0$.

Let $v \in C_j$, thus $d(v) = i'$. In the activation process \mathcal{S} the clique C_i is activated in the round i' , thus $f'(C_i) \leq |S_{i'-1} \cap Q|$. The cliques C_i and C_j have the same type, thus $f(v) = f'(C_i)$. Therefore by induction hypothesis,

$$f(v) \leq |S_{i'-1} \cap Q| \leq |R_{i'-1} \cap Q| = a_{i'}^R(v)$$

and the clique C_j is activated in the round i' of the activation process \mathcal{R} because of the delay.

The proof for a vertex $u \in C_i \setminus R_0$ is similar. Again we use that $f(u) = f'(C_j)$. Let $u \in Y$, i.e., $d(u) = j'$. If $C_j \setminus S = \emptyset$, then the set Y is empty as well and there is nothing to prove for this case. The clique C_j was activated in the round j' of the activation process \mathcal{S} . Thus,

$$f(u) = f'(C_j) \leq |S_0 \cap C_j| + |S_{j'-1} \cap Q| \leq |R_0 \cap C_i| + |R_{j'-1} \cap Q| = a_{j'}^R(u).$$

The vertex u is activated in the round j' of the activation process \mathcal{R} . Let $u' \in C_i \setminus (X \cup Y)$, i.e., $d(u') = i'$. The clique C_i (included the vertex u') was activated in the round i' of the activation process \mathcal{S} . Thus,

$$f(u') \leq a_{i'}^S = |S_{i'-1} \cap Q| \leq |R_{i'-1} \cap Q| = a_{i'}^R(u').$$

Thus, the vertex u is activated in the round $d(u') = i'$, which finishes the proof of Claim 3.1. \blacktriangleleft

3.2 Neighborhood Diversity

In this section we prove the UNIFORM TARGET SET SELECTION problem admits an FPT algorithm on graphs of the bounded neighborhood diversity. We again use Lemma 9. Note that in each round of the activation process at least one type has to be activated. This implies that there are at most $\text{nd}(G)$ rounds of the activation process. We use this fact to model the whole activation process as an integer linear program which is then solved using Lenstra's celebrated result.

► **Theorem 14** ([20, 12]). *Let p be a number of integral variables in a mixed integer linear program and let L be a number of bits needed to encode the program. Then it is possible to find an optimal solution in time $\mathcal{O}(p^{2.5p} \text{poly}(L))$ and a space polynomial in L .*

There has to be an order in which the types are activated in order to activate the whole graph. Since there are $t = \text{nd}(G)$ types, we can try all such orderings. Let us fix an order \prec on types. To construct the ILP we further need to know which types are fully activated at the beginning, since for these types we will not need to check there are enough neighbors activated in their round. Denote by c_0 the number of such types. Once the order \prec is fixed the set of fully activated types at the beginning is determined by c_0 . Since c_0 can attain values $0, \dots, t$ we can try all $t + 1$ possibilities. Now, with both \prec and c_0 fixed, denote the set of the types activated in the beginning by \mathcal{D}_0 .

Observe further that, as the vertices in a type share all neighbors, the only thing that matters is the number of activated vertices in each type and not the actual vertices activated. Thus, we have variables x_C which correspond to the number of vertices in type C selected into a target set S .

Let C be a type and n_C be the number of vertices in C . Since we know when C is activated, we know how many active vertices are in C in each round. In C there are x_C vertices before the activation of C and n_C after the activation. To formulate the integer linear program we denote the set of types by \mathcal{D} and we write $D \in N(C)$ if the two corresponding vertices in the type graph T_G are connected by an edge.

$$\begin{aligned}
& \text{minimize} && \sum_{C \in \mathcal{D}} x_C \\
& \text{subject to} && f'(C) \leq \sum_{D \prec C, D \in N(C)} n_D + \sum_{D \succ C, D \in N(C)} x_D && \forall C \in \mathcal{D} \setminus \mathcal{D}_0 \text{ } C \text{ indep.} \\
& && f'(C) \leq x_C + \sum_{D \prec C, D \in N(C)} n_D + \sum_{D \succ C, D \in N(C)} x_D && \forall C \in \mathcal{D} \setminus \mathcal{D}_0 \text{ } C \text{ clique} \\
& \text{where} && 0 \leq x_C < n_C && \forall C \in \mathcal{D} \setminus \mathcal{D}_0 \\
& && x_C = n_C && \forall C \in \mathcal{D}_0
\end{aligned}$$

As there are at most $t!$ orders of the set \mathcal{D} and $t + 1$ choices of c_0 , the UNIFORM TARGET SET SELECTION problem can be solved in time $(t + 1)t!t^{\mathcal{O}(t)} \text{poly}(n) = t^{\mathcal{O}(t)} \text{poly}(n)$. Thus, we have proven Theorem 1.

4 Hardness

In this section we prove hardness results for TARGET SET SELECTION. We prove the following problems are W[1]-hard.

1. TARGET SET SELECTION parameterized by the neighborhood diversity.

2. MAJORITY TARGET SET SELECTION parameterized by the modular-width.
3. TARGET SET SELECTION parameterized by the twin cover number.

Moreover unless ETH fails, there is no algorithm of running time $f(k)n^{o(k/\log k)}$ for the problems above, where k is the appropriate parameter. We use an FPT reduction from the following problem.

COLORED SUBGRAPH ISOMORPHISM (CSI)

Input: A k -partite graph $G = (V_1 \dot{\cup} \dots \dot{\cup} V_k, E)$, a graph H such that $V(H) = \{1, \dots, k\}$.

Task: Is H isomorphic to a (colored) subgraph of G ? I.e., is there an injective mapping $\phi: V(H) \rightarrow V(G)$ such that $\{\phi(u), \phi(v)\} \in E(G)$ for each $\{u, v\} \in E(H)$ and $\phi(i) \in V_i$ for each $i \in V(H)$?

If (G, H) is a *yes*-instance of CSI, then we say that G contains a colored copy of H .

► **Theorem 15** (Marx [21, Corollary 6.1]). *The CSI problem is W[1]-hard for the parameter tree width of H . Moreover, if there is a recursively enumerable class \mathcal{H} of graphs with unbounded treewidth, an algorithm \mathbb{A} , and an arbitrary function f such that \mathbb{A} correctly decides every instance of CSI with the graph H in \mathcal{H} in time $f(k) \cdot |V(G)|^{o(\text{tw}(H)/\log \text{tw}(H))}$, then ETH fails.*

It is known that there are infinitely many 3-regular graphs such that each such graph H has treewidth $\Theta(k)$ (cf. [15, Proposition 1, Theorem 5]). Using the class of 3-regular graphs as \mathcal{H} in the above theorem, we derive the following corollary.

► **Corollary 16.** *If there is an algorithm \mathbb{A} and a function f such that \mathbb{A} correctly decides every instance of COLORED SUBGRAPH ISOMORPHISM with the graph H being 3-regular in time $f(k) \cdot |V(G)|^{o(k/\log k)}$, then ETH fails.*

Thus, from now we suppose the graph H is 3-regular. Let (G, H) be an instance of CSI. We will present three FPT reductions to TARGET SET SELECTION such that the sizes of the resulting graphs G' will be polynomial in $|V(G)|$ and the appropriate parameters will be bounded by $\mathcal{O}(k)$. We refer to the sets V_c as to *color classes* of G and to a set E_{cd} as to edges between the color classes V_c and V_d . Note that we can suppose all color classes have the same size and E_{cd} is not empty if and only if $\{c, d\} \in E(H)$. In the CSI problem we need to select exactly one vertex from each color class V_c and exactly one edge from each (nonempty) set E_{cd} . Moreover, we have to make certain that if $\{u, v\} \in E_{cd}$ is a selected edge, then $u \in V_c$ and $v \in V_d$ are the selected vertices. This selection of vertices and edges and the checking of their incidence needs to be captured in the reductions to TARGET SET SELECTION.

4.1 Neighborhood Diversity

For an easier notation during the reduction, we denote the size of an arbitrary color class V_c by $n + 1$. Similarly, we denote $m_{cd} + 1 = |E_{cd}|$. Thus, we have $V_c = \{v_0^c, \dots, v_n^c\}$ and $E_{cd} = \{e_0^{cd}, \dots, e_{m_{cd}}^{cd}\}$. We describe a reduction from the graph G to an instance (G', f, b) of TARGET SET SELECTION such that $\text{nd}(G')$ is $\mathcal{O}(k)$.

4.1.1 Overview

As the proof is quite long and technical we overview main ideas contained in the proof here. We encode a vertex v_i^c in a color class V_c of the graph G by two numbers i and $n - i$. The

selection gadget for V_c has two parts: pos and neg. We select the $v_i^c \in V_c$ for the copy of H if and only if we select to a target set i vertices in the pos part of the gadget for V_c and $n - i$ vertices in the neg part. We proceed with encoding of edges similarly, however, edges are encoded by multiples of sufficiently large number q . I.e., we select the ℓ -th edge in E_{cd} for the copy of H if and only if we select $q\ell$ in the pos part of the gadget for E_{cd} and $q(m_{cd} - \ell)$ in the neg part. We will create three types of gadgets: for selection vertices, for selection edges, and gadgets which check that the selected vertices are incident to the selected edges.

The incidence check is done by the following idea. The incidence gadget for V_c and E_{cd} contains 2 vertices $u^{cd}(\ell)$ and $w^{cd}(\ell)$ for each edge $e_\ell^{cd} \in E_{cd}$. The vertices $u^{cd}(\ell)$ are connected to the pos parts of the selection gadgets for V_c and E_{cd} and the vertices $w^{cd}(\ell)$ are connected to the neg parts. Let v_i^c be the vertex of e_ℓ^{cd} which is in V^c . The threshold $f(u^{cd}(\ell))$ is set to $i + q\ell$ and $f(w^{cd}(\ell)) = n - i + q(m_{cd} - \ell)$.

Now suppose we selected $v_j^c \in V_c$ and the edge e_ℓ^{cd} for the copy of H and the vertices $u = u^{cd}(\ell)$ and $w = w^{cd}(\ell)$ were activated during the activation process in G' . The vertex u is connected to j selected neighbors in the pos part of the vertex selection gadget and to $q\ell$ selected neighbors in the pos part of the edge selection gadget. Since $f(u) = i + q\ell$, it must hold that $j \geq i$. Similarly, the vertex w is connected to $n - j + q(m_{cd} - \ell)$ selected vertices in the neg parts of the selection gadgets and $f(w) = n - i + q(m_{cd} - \ell)$. Thus, we have $j \leq i$. Therefore, if we check that the vertices u and w are activated during the activation process we can verify that $i = j$ and the vertex v_j^c is actually incident to the edge e_ℓ^{cd} . To make this incidence check actually work, we need that

$$f(u^{cd}(\ell)) < f(u^{cd}(\ell')) \Leftrightarrow \ell < \ell' \quad \text{and} \quad f(w^{cd}(\ell)) < f(w^{cd}(\ell')) \Leftrightarrow \ell' < \ell.$$

This can be done by setting q to $2n$, which is sufficiently large. Now, we proceed with the formal description of the reduction. We point out that all types of G' in the neighborhood diversity decomposition are independent sets.

4.1.2 Selection Gadget $L(s)$

First, we describe gadgets of the graph G' for selecting vertices and edges of the graph G . For an overview of the gadget please refer to Figure 4. The gadget $L(s)$ is formed by two types L -neg and L -pos of equal size s (the number s will be determined later); we refer to these two types as the *selection part*. For a vertex v in the selection part we set the value $f(v)$ to the degree of v . It means that if some vertex v from the selection part is not selected into the target set, then all neighbors of v have to be active before the vertex v can be activated by the activation process. The selection gadget L is connected to the rest of the graph using only vertices from the selection part. The last part of the gadget L is formed by the type L -guard of $s + 1$ vertices connected to both types in the selection parts. For each vertex v in L -guard type we set $f(v) = s$.

► **Lemma 17.** *Suppose there is a selection gadget $L(s)$ in the graph G' . We claim that exactly s vertices of the gadget L are needed to be selected in the target set S to activate the vertices in the L -guard type. Moreover, these s vertices have to be selected from the selection part of L .*

Proof. Let $S' = V(L) \cap S$, i.e., vertices of the target set S in the gadget L . First, suppose $|S'| < s$ or $|S'| = s$ and some vertex u of L -guard is in S' . Since there are $s + 1$ vertices in L -guard, there is a vertex v in the L -guard type such that $v \notin S'$. Let V^p be vertices of the selection part of L . The vertex v has neighbors only in V^p and the threshold of v

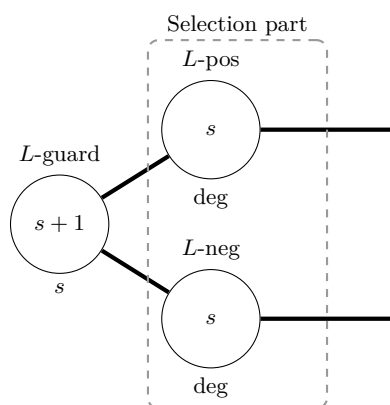

■ **Figure 4** An overview of the selection gadget $L(s)$. Numbers in circles denote numbers of vertices in each type and numbers under circles denote thresholds of vertices in each type.

is s . Note that $|V^p \cap S'| < s$. Thus, at least one vertex $w \in V^p \setminus S'$ needs to be activated during the activation process before the vertex v is activated. However, $f(w) = \deg(w)$ for $w \in V^p$. Therefore, the vertex w has to be activated after the vertex v is activated. That is a contradiction and $|V^p \cap S'| \geq s$ must hold. When S' contains s vertices from the selection part of L , then it is easy to see that the all vertices in L -guard type are activated in the first round of the activation process. ◀

Numeration of Vertices and Edges For every color class V_c we create a selection gadget $L_c = L(n)$. We select a vertex $v_i^c \in V_c$ to the colored copy of H if i vertices in the L_c -pos type and $n - i$ vertices in the L_c -neg type of the gadget L_c are selected into the target set.

The selection of edges is similar, however, a bit more complicated. For every set E_{cd} we create a selection gadget L_{cd} of kind $L(qm_{cd})$. We select an edge $e_j^{cd} \in E_{cd}$ to the colored copy of H if qj vertices in the L_{cd} -pos type of the gadget L_{cd} are selected into the target set (and $q(m_{cd} - j)$ vertices in the L_{cd} -neg are selected into the target set). Suppose s vertices in the L_{cd} -pos type are selected into the target set. If s is not divisible by q , then it is an invalid selection. We introduce a new gadget such that s has to be divisible by q .

4.1.3 Multiple Gadget $M(q, s)$

A multiple gadget $M(q, s)$ consists of a selection gadget $L(qs)$ and three other types: M -pos, M -neg of s vertices, and M -guard of qs vertices. The type M -pos is connected to the type L -pos and the type M -neg is connected to the type L -neg. The type M -guard is connected to the types M -pos and M -neg. Still, the rest of graph G' is connected only to the types L -pos and L -neg. Let $\{u_1, \dots, u_s\}$ and $\{w_1, \dots, w_s\}$ be vertices in M -pos type and M -neg type, respectively. We set thresholds $f(u_i) = f(w_i) = qi$. For each vertex v in M -guard we set $f(v) = s$. For an example of multiple gadget see Figure 5.

► **Lemma 18.** *Suppose there is a multiple gadget $M(q, s)$ in the graph G' . Let L be a selection gadget in M . We claim that exactly qs vertices of the gadget L are needed to be selected in the target set S to activate the types L -guard, M -pos, M -neg and M -guard. Moreover, these qs vertices have to be selected from the selection part of L and the numbers of vertices selected in L -pos and L -neg types are divisible by q .*

Proof. By Lemma 17, we know that qs selected vertices in the types L -pos and L -neg are needed to activate the L -guard type. Suppose there are z vertices in the L -pos type selected into a target set and z is not divisible by q . It follows there are $qs - z$ selected vertices

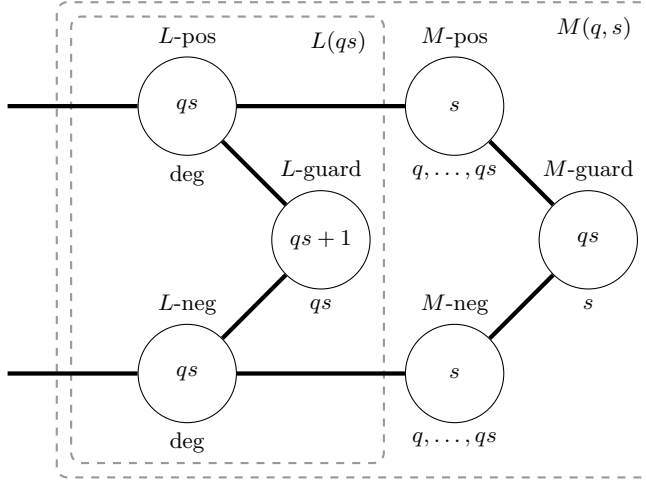

■ **Figure 5** An overview of the multiple gadget $M(q, s)$.

in L -neg. Thus, $z = qa + r$, $0 < r < q$ and $qs - z = q(s - a) - r$. Let $\{u_1, \dots, u_s\}$ and $\{w_1, \dots, w_s\}$ be vertices in the M -pos type and in the M -neg type, respectively. Recall that $f(u_i) = f(w_i) = qi$. Thus, vertices u_1, \dots, u_a and w_1, \dots, w_{s-a-1} are activated in the first round of the activation process.

We claim that no other vertices in the gadget M would be activated during the activation process. Vertices in the M -guard type have only $s - 1$ activated vertices among their neighbors and have the threshold s . Vertices in L -pos and L -neg have thresholds equal to their degrees. Thus, they have to be activated after all vertices in M -pos and M -neg are activated. Vertices u_{a+1}, \dots, u_s in the M -pos type and w_{s-a}, \dots, w_s in the M -neg type cannot be activated unless some of their neighbors are activated.

Now suppose that $r = 0$, i.e., $z = qa$ and $qs - z = q(s - a)$. Vertices u_1, \dots, u_a and w_1, \dots, w_{s-a} are activated in the first round. All vertices in the M -guard type are activated in the second round because they have s activated vertices among their neighbors. Recall that the maximum threshold in the M -pos and the M -neg type is qs . Since there are qs vertices in M -guard, every vertex in the types M -pos and M -neg has at least qs activated vertices among its neighbors. Therefore, the rest of vertices in the types M -pos and M -neg are activated in the third round. ◀

4.1.4 Incidence Gadget

So far we described how we encode in graph G' selecting vertices and edges to the colored copy of H . It remains to describe how we encode the correct selection, i.e., if $v \in V_c$ and $e \in E_{cd}$ are selected vertex and edge to the colored copy of H , then $v \in e$. We create a selection gadget $L_c(n)$ for each color class V_c . We set the number q to $2n$ and create a multiple gadget M_{cd} of kind $M(2n, m_{cd})$ (with selection gadget L_{cd}) for each set E_{cd} . We join gadgets L_c and M_{cd} through an incidence gadget $I_{c:cd}$. See Figure 6, for better understanding how the incidence gadget is connected to the selection and multiple gadgets. The incidence gadget $I_{c:cd}$ has three types $I_{c:cd}$ -pos and $I_{c:cd}$ -neg of $m_{cd} + 1$ vertices each and $I_{c:cd}$ -guard of $n + 2nm_{cd}$ vertices. We connect the $I_{c:cd}$ -guard type to the types $I_{c:cd}$ -pos and $I_{c:cd}$ -neg. Furthermore, we connect the type $I_{c:cd}$ -pos to the types L_c -pos and L_{cd} -pos. Similarly, we connect the type $I_{c:cd}$ -neg to the types L_c -neg and L_{cd} -neg.

We set thresholds of all vertices in the $I_{c:cd}$ -guard type to $m_{cd} + 2$. Recall there are $m_{cd} + 1$ edges in the set E_{cd} . Thus, we can associate edges in E_{cd} with vertices in $I_{c:cd}$ -pos

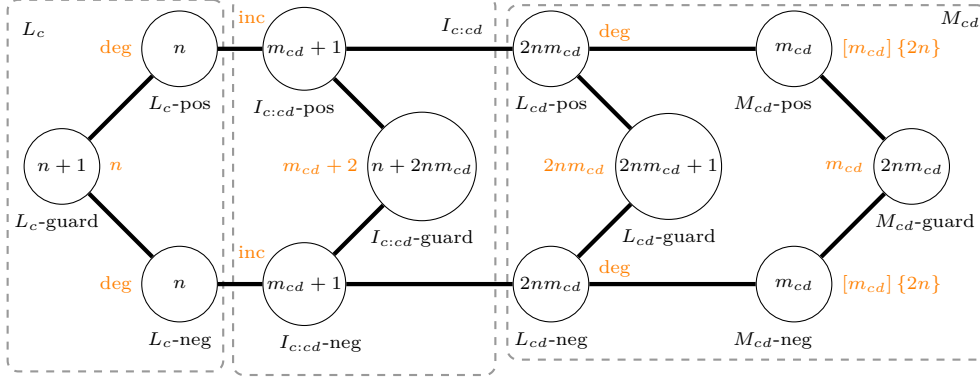

■ **Figure 6** An overview of the reduction. The number inside a type is the number of vertices of the type. The threshold of vertices in a type is displayed next to the type in orange (light-gray).

($I_{c:cd}$ -neg respectively) one-to-one. I.e., $V(I_{c:cd}$ -pos) = $\{u_\ell : e_\ell \in E_{cd}\}$ and $V(I_{c:cd}$ -neg) = $\{w_\ell : e_\ell \in E_{cd}\}$. Let $v_i^c \in V_c$ and $e_j^{cd} \in E_{cd}$ with $v_i^c \in e_j^{cd}$. Recall that selecting v_i^c and e_j^{cd} into the colored copy of H is encoded as selecting i vertices in L_c -pos type and $2nj$ vertices in L_{cd} -pos type into the target set. We set threshold of u_j to $i + 2nj$ and threshold of w_j to the “opposite” value $n - i + 2n(m_{cd} - j)$.

Since we set the coefficient q to $2n$, for each edge $e_j \in E_{cd}$ and each vertex $v_i \in V_c$ the sum $i + 2nj$ is unique. Thus, every vertex in $I_{c:cd}$ -pos ($I_{c:cd}$ -neg) has a unique threshold. We will use this number to check the incidence.

We described how from the graph G with k color classes (instance of CSI) we create the graph G' with the threshold function f (input for TARGET SET SELECTION). We join the gadgets L_c and M_{cd} by an incidence gadget $I_{c:cd}$ (gadgets L_d and M_{cd} are joint by a gadget $I_{d:cd}$). Let $\bar{m} = \sum_{\{c,d\} \in E(H)} m_{cd}$. To finish the construction of the instance of TARGET SET SELECTION, we set the budget b to $kn + 2n\bar{m}$.

4.1.5 Finishing the Reduction

It is easy to see the following observations follow directly from the construction of G' .

► **Observation 19.** *The graph G' has polynomial size in the size of the graph G and can be constructed in time polynomial in $|V(G)|$.*

► **Observation 20.** *The neighborhood diversity of the graph G' is $\mathcal{O}(k)$.*

► **Theorem 21.** *If the graph G contains a colored copy of H , then G' with the threshold function f contains a target set of size b .*

Proof. Let K be a colored copy of H in the graph G . We construct a set $S \subseteq V(G')$. Let $v_i^c \in V(K) \cap V_c$. We add i vertices in the L_c -pos type and $n - i$ in the L_c -neg type into the set S . Let $e_j^{cd} \in E(K) \cap E_{cd}$. For the set E_{cd} we have a multiple gadget M_{cd} and there is a selection gadget L_{cd} inside M_{cd} . We add $2nj$ vertices in the L_{cd} -pos type and $2n(m_{cd} - j)$ vertices in the L_{cd} -neg into the set S . We have n vertices in S for every color class V_c and $2nm_{cd}$ vertices in S for every edge set E_{cd} . Thus, $|S| = kn + 2n\bar{m} = b$.

We claim the set S is a target set. We analyze the selection gadget L_c , the multiple gadget M_{cd} (with the L_{cd} selection gadget), and the incidence gadget $I_{c:cd}$. All vertices in the types L_c -guard and L_{cd} -guard are activated in the first round (see the proof of Lemma 17).

All vertices in the types M_{cd} -neg, M_{cd} -pos and M_{cd} -guard are activated during the first three rounds – for details see the proof of Lemma 18.

Recall $V(I_{c:cd}\text{-pos}) = \{u_\ell : e_\ell \in E_{cd}\}$ and $V(I_{c:cd}\text{-neg}) = \{w_\ell : e_\ell \in E_{cd}\}$. The threshold of $u_\ell \in V(I_{c:cd}\text{-pos})$ is $2n\ell + \ell'$ for some $\ell' \in \{0, \dots, n\}$. There are $2nj + i$ vertices activated in the types L_{cd} -pos and L_c -pos. Vertices u_0, \dots, u_{j-1} are activated in the first round because their thresholds are strictly smaller than $2nj$. The threshold of u_j is $2nj + i$ because this vertex corresponds to the incidence $v_i \in e_j$. Thus, the vertex u_j is activated in the first round as well. Vertices $u_{j+1}, \dots, u_{m_{cd}}$ have thresholds bigger than $2n(j+1)$ and cannot be activated in the first round. By the same analysis we get that vertices $w_j, \dots, w_{m_{cd}}$ in the $I_{c:cd}$ -neg type are activated in the first round.

In the first round there are $m_{cd} + 2$ activated vertices in the types $I_{c:cd}$ -pos and $I_{c:cd}$ -neg altogether. All vertices in the $I_{c:cd}$ -guard type are activated in the second round because they have threshold $m_{cd} + 2$. The maximum threshold in the $I_{c:cd}$ -pos ($I_{c:cd}$ -neg) type is $n + 2nm_{cd}$. Thus, the rest of vertices in the types $I_{c:cd}$ -pos and $I_{c:cd}$ -neg are activated in the third round because they have $n + 2nm_{cd}$ active neighbors in the $I_{c:cd}$ -guard type.

All vertices outside the types L_c -pos, L_c -neg, L_{cd} -pos, and L_{cd} -neg are activated during the first three rounds. Let U be a set of vertices which are not activated during the first three rounds. Note that U is an independent set and for every $u \in U$ holds that $f(u) = \deg(u)$. Therefore, vertices in U are activated in the fourth round. \blacktriangleleft

► **Theorem 22.** *If the graph G' with the threshold function f contains a target set of size b , then G contains a colored copy of H .*

Proof. Let S be a target set of the graph G of size b . There are k selection gadgets $L(n)$ in G' . By Lemma 17, the set S has to contain at least n vertices in the selection part of every gadget $L(n)$. There is also a selection gadget $L(2nm_{cd})$ in multiple gadgets M_{cd} for each $\{c, d\} \in E(H)$. By Lemma 18, the set S has to contain at least $2nm_{cd}$ vertices in the selection part of every gadget $L(2nm_{cd})$ in M_{cd} . Since $|S| = b = kn + 2n\bar{m}$, there is no other vertex in S .

Now, for every V_c and E_{cd} we select a vertex (or an edge, respectively). We select a vertex $v_i^c \in V_c$ if $|V(L_c\text{-pos}) \cap S| = i$. We select an edge $e_j^{cd} \in E_{cd}$ if $|V(L_{cd}\text{-pos}) \cap S| = 2nj$. By Lemma 17 and 18, we know that this selection is well-defined. We claim that if $v = v_i^c \in V_c$ is the selected vertex and $e = e_j^{cd} \in E_{cd}$ is the selected edge, then $v \in e$.

For a contradiction suppose $v \notin e$. We analyze the incidence gadget $I_{c:cd}$. Let $V(I_{c:cd}\text{-pos}) = \{u_0, \dots, u_{m_{cd}}\}$ and $V(I_{c:cd}\text{-neg}) = \{w_0, \dots, w_{m_{cd}}\}$. Vertices in the type $I_{c:cd}$ -pos have $i + 2nj$ active neighbors. Vertices in the type $I_{c:cd}$ -neg have $n - i + 2n(m_{cd} - j)$ active neighbors. As we say in the proof of the previous theorem, vertices u_0, \dots, u_{j-1} and $w_{j+1}, \dots, w_{m_{cd}}$ are activated in the first round and vertices $u_{j+1}, \dots, u_{m_{cd}}$ and w_0, \dots, w_{j-1} are not activated.

It remains to analyze the vertices u_j and w_j . Suppose u_j is activated in the first round. Thus, $f(u_j) = i' + 2nj < i + 2nj$. Note that $i' < i$ because we suppose $v \notin e$. For the threshold of w_j holds

$$f(w_j) = n - i' + 2n(m_{cd} - j) > n - i + 2n(m_{cd} - j).$$

Since the vertex w_j has $n - i + 2n(m_{cd} - j)$ active neighbors (i.e., $|N(w_j) \cap S_0| = n - i + 2n(m_{cd} - j)$), the vertex w_j cannot be activated in the first round. Thus, at least one of the vertices u_j, w_j is not activated in the first round.

Any vertex of the type $I_{c:cd}$ -guard cannot be activated in the second round because they have threshold $m_{cd} + 2$ and they have at most $m_{cd} + 1$ active neighbors in the first round.

Vertices of the type $I_{c:cd}$ -guard have to be activated after some other vertices in the types $I_{c:cd}$ -pos or $I_{c:cd}$ -neg are activated. Let W be the neighbors of $I_{c:cd}$ -pos or $I_{c:cd}$ -neg that are not from $I_{c:cd}$ -guard. By the construction, the vertices of W are only in the selection parts of the gadgets. Thus, for every $w \in W$ holds that $f(w) = \deg(w)$. There are no vertices in the neighborhood of $I_{c:cd}$ -pos and $I_{c:cd}$ -neg which would be activated during the activation process and the vertices of the type $I_{c:cd}$ -guard stay inactive during the whole process. Therefore, S is not a target set, which is a contradiction. ◀

Theorem 2 is a corollary of Theorem 21 and 22 and Observation 19 and 20.

4.2 Modular-width

In fact this can be seen as a clever twist of the ideas contained in the proof of Theorem 2. There are some nodes of the neighborhood diversity decomposition already operating in the majority mode – e.g. guard vertices – these we keep untouched. For vertices with threshold set to their degree one has to “double” the number of vertices in the neighborhood. Finally, one has to deal with types having different thresholds for each of its vertices, which is quite technical. Here we exploit the property of the previous proof – that these vertices naturally come in pairs and that it is possible to replace each of these vertices by a collection of cliques. This ensures that even if the neighborhood is the same some vertices get activated and some not.

As already noted, we reduce the instance (G, H) of CSI into an instance (G', b) of MAJORITY TARGET SET SELECTION. The graph G' consists of several different types of gadgets. Throughout the description of gadgets, we use the following terminology. The vertices that are adjacent to vertices outside of the gadget (that introduces them) are referred to as *interface vertices*, the other vertices of the gadget are *internal vertices*. The vertices outside of the gadget that are adjacent to its interface part are *neighboring vertices of the gadget*. As we try to adapt the previous reduction to work in a “majority” regime, we need to know how many neighboring vertices gadgets have, to make gadgets work properly.

4.2.1 Selection Gadget $L(s, r)$

This gadget (together with an appropriate budget value) ensures that every target set encodes a number from 0 to s . The parameter r denotes the number of neighboring vertices, that is, we assume that each interface vertex has exactly r neighbors not in the gadget. The gadget consists of the following five types (see Figure 7 for an overview of the construction):

- Two independent sets each of size s called L -pos and L -neg (selection part of the gadget).
- One independent set of size $3s$ called L -guard.
- One independent set of size $r + 3s$ called L -doubling.
- One independent set of size $2s$ called L -end.

The L -guard type is connected to L -pos and L -neg, L -doubling is connected to L -pos, L -neg, and L -end. The L -pos and the L -neg types form the interface part of the gadget. The next definition gives us a useful tool for showing a lower bound on a number of vertices of a gadget that need to be in every target set.

► **Definition 23.** Let J be a gadget in G' and let \overline{V}_J be the set $V(G') \setminus V(J)$. The deficit $\text{def}_J(v)$ of a vertex $v \in V(J)$ with respect to J is defined as

$$\text{def}_J(v) = \begin{cases} 0 & \text{if } |N(v) \cap \overline{V}_J| \geq \deg(v)/2 \\ \lceil \deg(v)/2 \rceil - |N(v) \cap \overline{V}_J| & \text{otherwise.} \end{cases}$$

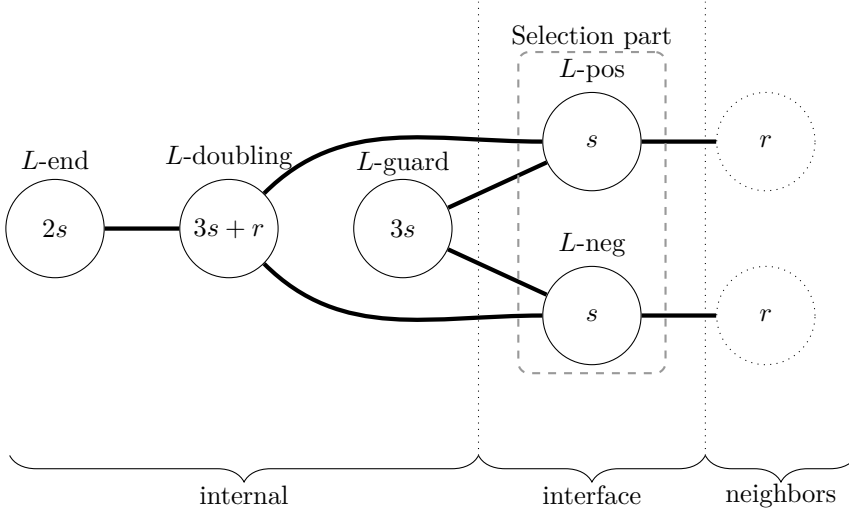

■ **Figure 7** An overview of the selection gadget $L(s, r)$ for MAJORITY TARGET SET SELECTION

We usually say just the deficit of a vertex v when the gadget J is clear from the context.

In other words, deficit determines how many neighbors of v in J we need to activate, provided that every vertex outside of J is already activated. Note that for an internal vertex, its deficit is exactly its threshold. For an interface vertex, its deficit is its threshold decreased by a number of adjacent vertices outside J .

The following lemma gives us a lower bound on how many elements of J need to be in any target set.

► **Lemma 24.** *If all vertices in a gadget J have deficit at least d and $S \subseteq V(G')$ is a set with $|S \cap V(J)| < d$, then S is not a target set.*

Proof. We show a stronger statement that $S' = S \cup \overline{V_J}$ is not a target set. We see that every vertex $v \in V(J)$ has at most $|S \cap V(J)| + |N(v) \cap \overline{V_J}|$ neighbors in S' ; which is at most $d - 1 + |N(v) \cap \overline{V_J}|$. However, from the definition of deficit and the assumption that deficit is at least d we have $\lceil \deg(v)/2 \rceil \geq |N(v) \cap \overline{V_J}| + d$. Thus, no vertex in J has enough active neighbors and the activation process for S' terminates immediately. ◀

The following is then a simple consequence.

► **Lemma 25.** *Let $L = L(s, r)$ be a selection gadget in the graph G' . If $S \subseteq V(G')$ contains less than s vertices in $V(L)$, then S is not a target set.*

Proof. We examine the values of deficits for vertices in gadget L . The degrees of vertices in L -end, L -doubling, and L -guard are $3s + r$, $4s$, and $2s$, respectively, and therefore their deficits are $(3s + r)/2$, $2s$, and s , respectively. The vertices in L -pos and L -neg have degree $6s + 2r$ and so their threshold is $3s + r$. As they have r neighbors in $\overline{V_L}$, their deficit is $3s$. We see that every vertex has the deficit at least s . The lemma follows from Lemma 24. ◀

► **Lemma 26.** *Let $L = L(s, r)$ be a selection gadget in G' and suppose $S \subseteq V(G')$ is a target set that contains exactly s vertices from $V(L)$. Then, the following holds.*

1. *The vertices of $V(L) \cap S$ are in the selection part of the gadget L .*
2. *Suppose that v is a vertex in the selection part of L but not in S . The vertex v cannot be activated before all neighboring vertices of L adjacent to v are activated.*

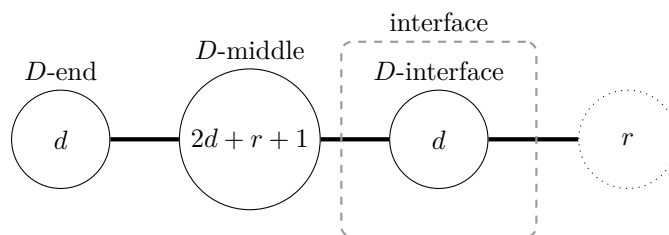

■ **Figure 8** An overview of the threshold decrease gadget for MAJORITY TARGET SET SELECTION

Proof. The only vertices with deficit s are in the L -guard part, others have their deficit strictly higher. Suppose S contains less than s vertices from the neighborhood of L -guard (i.e., from the selection part of $L - L$ -pos or L -neg). To activate L -guard some other vertices in the selection part have to be activated. Suppose further that the activation process manages to activate the rest of the graph, i.e., all r neighbors of the gadget L are activated. Even in this case, the vertices in the selection part have at most $s + r$ active neighbors and their threshold is $3s + r$. Thus, L -doubling has to be activated. However, vertices in L -doubling have threshold $2s$ and they have at most s active neighbors. To activate L -doubling, the L -end type has to be activated. Again, vertices L -end have threshold strictly higher than s and they have at most s active neighbors. Therefore, the activation process would stop and the only way how to proceed is that S contains s vertices in the selection part of L (L -pos and L -neg).

For the second part, we can assume $v \in V(L\text{-pos}) \setminus S$, since the gadget is symmetric. From Part 1 we already know that the set S contains only vertices from the selection part. Thus, L -guard is activated in the first round. To activate v , other r vertices has to be activated. Since S does not intersect L -doubling and L -end, those types can be activated after L -pos and L -neg. Thus, the neighboring vertices of L connected to v has to be activated before v . ◀

4.2.2 Threshold Decrease Gadget $D(d, r)$

The purpose of a threshold decrease gadget $D(d, r)$ is to ensure there are d active vertices in its interface part. This can be also viewed as effectively decreasing the threshold of neighboring vertices by $d/2$, since if it works as described, then it adds d neighbors to the neighborhood of the gadget all of which are activated. The parameter r again determines the number of neighboring vertices.

The gadget consists of the following three types (see Figure 8 for an overview):

- The independent set of size d called D -interface.
- The independent set of size $2d + r + 1$ called D -middle.
- The independent set of size d called D -end.

The type D -middle is connected to D -interface and D -end.

► **Lemma 27.** *Let $D = D(d, r)$ be a threshold decrease gadget in the graph G' . If $S \subseteq V(G)$ contains less than d vertices in $V(D)$ then S is not a target set. Moreover, $S \cap V(D)$ is a subset of vertices in D -interface and D -end.*

Proof. Let S_D denote $S \cap V(D)$. Again we can assume that vertices in $\overline{V_D}$ are in S . The deficit of vertices in the D -end part is $(2d + r + 1)/2 > d$, the deficit of vertices in the D -middle part is d , and the deficit of vertices in D -interface part is $(2d + 2r + 1)/2 > d$. Therefore, by

Lemma 24 the set S is not a target set. The moreover part of the lemma follows immediately, since the only part with deficit exactly d is the D -middle part and therefore S must contain d vertices in its neighborhood. \blacktriangleleft

Note that we can choose how we distribute d vertices in S between D -end and D -interface. The next lemma states that for determining the existence of a target set, it is enough to consider sets S that have d vertices in D -interface.

► **Lemma 28.** *Let $D = D(d, r)$ be a threshold decrease gadget in the graph G' . If S is a target set, then the set $S' = (S \setminus V(D)) \cup V(D\text{-interface})$ is a target set and $|S'| \leq |S|$.*

Proof. We first verify that $|S'| \leq |S|$. The sets S and S' coincide on $V(G') \setminus V(D)$. From Lemma 27 we have that $|S \cap V(D)| \geq d$. From the definition of S' we see that $|S' \cap V(D)| = d$. Putting these three observations together, we obtain that $|S'| \leq |S|$.

Now observe that if we start the activation process with the set S' the vertex set of the gadget D activates after two rounds. In particular, we have $S \subseteq S'_2$. Consequently, the activation process starting from the set S' must activate all the vertices activated in the activation process starting from the set S . Since S was a target set, so is S' . \blacktriangleleft

We set the budget b in such a way that it exactly covers all selection gadget and all threshold decrease gadgets. This means that if any element of S is outside of the selection part of the selection gadgets or outside of the D -interface or the D -end part of the threshold decrease gadgets, then S is not a target set. By Lemma 28, we know that we can ignore S intersecting any D -end part. This motivates the following definition.

► **Definition 29.** *We say that a set $S \subseteq V(G')$ is hopeful if all its elements lie in the selection parts of selection gadgets and in the interface parts of threshold decrease gadgets.*

When the budget is set as mentioned, it follows from Lemma 25, Lemma 27, and Lemma 28 that if we want to decide whether there exists a target set, it is sufficient to consider only hopeful sets.

► **Definition 30.** *Let $S \subseteq V(G')$ be a hopeful set and $L = L(s, r)$ be a selection gadget in G' . If there are i elements of S in L -pos and $s - i$ elements of S in L -neg, we say that S represents the number i in L .*

4.2.3 Check Gadget $C(Z, s)$

The parameter s is a positive integer and $Z \subseteq \{0, \dots, s\}$. The gadget has two interface parts C -pos and C -neg that will be connected to the pos and neg parts of selection gadgets. The gadget is constructed in such a way that it is activated if and only if the sum of the numbers represented by connected selection gadgets is in Z .

We start with few auxiliary definitions. An i -clique group is the graph $(2(s - i) + 1) \times K_{2i+1}$ (i.e., disjoint union of $2(s - i) + 1$ cliques, each of size $2i + 1$). The *weight* of an i -clique group is the number of vertices of the group and is denoted by $w_s(i) = (2(s - i) + 1) \cdot (2i + 1)$.

The graph C_Z is defined as a disjoint union of z -clique groups for each $z \in Z$. The graph \overline{C}_Z is defined as a disjoint union of $(s - z)$ -clique groups for each $z \in Z$. The z -clique group in C_Z and the $(s - z)$ -clique group in \overline{C}_Z are referred to as *complementary clique groups*. Note that the clique group and its complementary clique group have the same weight.

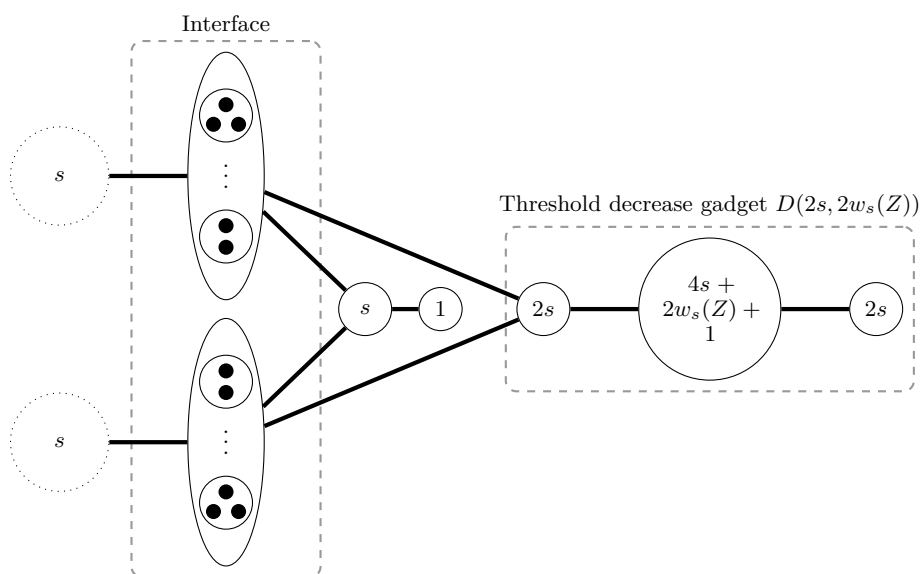

■ **Figure 9** An overview of Check gadget $C(Z, s)$ for MAJORITY TARGET SET SELECTION

The *weight of the set Z* is defined as

$$w_s(Z) = \sum_{z \in Z} w_s(z).$$

The gadget $C(Z, s)$ consists of the following parts (see Figure 9 for overview):

- Interface parts C -pos and C -neg that are formed by C_Z and \overline{C}_Z , respectively.
- Independent set C -guard of size s that is connected to the parts C -pos and C -neg.
- A single vertex connected to C -guard.
- A threshold decrease gadget $D_C = D(2s, 2w_s(Z))$ with its interface part connected to C -pos and C -neg.

► **Lemma 31.** *Let $C = C(Z, s)$ be a check gadget in the graph G' and let $L_1 = L(s_1, r_1), \dots, L_h = L(s_h, r_h)$ be selection gadgets that are connected to C in such a way that each L_i -pos is connected to C -pos and each L_i -neg is connected to C -neg. We additionally require that $\sum s_i = s$ and no other gadget is connected to C . Furthermore, let S be a hopeful set that represents numbers ℓ_1, \dots, ℓ_h in gadgets L_1, \dots, L_h , respectively. Then, the gadget C is activated if and only if $\ell_1 + \dots + \ell_h \in Z$.*

Proof. First notice that due to Lemma 26 Part 2, no vertex in L_i can be activated before C -pos and C -neg are fully activated. Let us set $\ell = \ell_1 + \dots + \ell_h$.

Proof. The i -clique group K in C_Z is activated in the first round if and only if $i \leq \ell$. The $(s - i)$ -clique group \overline{K} in \overline{C}_Z is activated in the first round if and only if $s - i \leq s - \ell$. ◁

The degree of vertices in the i -clique group K is $4s + 2i$; there are s neighbors in the adjacent selection gadgets, s neighbors in the C -guard part, $2s$ neighbors in the adjacent threshold decrease gadget, and $2i$ neighbors within the clique itself. Therefore, the threshold of vertices in the i -clique group is $2s + i$. We know that $2s$ vertices in the neighborhood of K are already activated due to the threshold decrease gadget D_C . Thus, at least i other vertices need to be activated for the i -clique to be activated. Since S is hopeful, these vertices can be only in the pos parts of the adjacent selection gadgets. From the assumption of the lemma, we know

that there are ℓ such vertices, which gives us that the clique group activates if and only if $\ell \geq i$.

To prove the second part, it is enough to observe that exactly $s - \ell$ vertices are activated in the neg parts of the selection gadgets $L_1 \dots, L_h$ because S is hopeful. The rest follows by a similar argument.

Proof. If a clique group K is not activated in the first round, then its complementary clique group \overline{K} is activated in the first round. \triangleleft

Suppose that K is an i -clique group. This means that \overline{K} is an $(s - i)$ -clique group. If K is not activated in the first round, then we have $i > \ell$ by Claim 4.2.3. But then $s - i < s - \ell$ and again by Claim 4.2.3 the clique group \overline{K} is activated in the first round.

Observe that the complementary clique groups K and \overline{K} have the same number of vertices and at least one of them is activated after the first round by Claim 4.2.3.

Proof. The i -clique group K in C_Z and its complementary clique group \overline{K} are activated in the first round if and only if $\ell = i$ and therefore $\ell \in Z$. \triangleleft

From Claim 4.2.3 we see that both K and \overline{K} are activated in the first round if and only if $i \leq \ell$ and $s - i \leq s - \ell$, which together gives $i = \ell$. We put an i -clique group into C_Z if and only if $i \in Z$, which finishes the proof of the claim.

Proof. If $\ell \notin Z$, the activation process in C stops after the first round. \triangleleft

If $\ell \notin Z$, by Claim 4.2.3 we see that there is no pair of complementary clique groups K, \overline{K} such that both of them are activated in the first round. But then C -guard cannot be activated, as less than half of its neighbors are activated. Note that the interface vertices of the gadget C have to be activated in order to activate the rest of the vertices in adjacent selection gadgets (by Lemma 26).

Proof. If $\ell \in Z$, the whole gadget C is activated in three rounds. \triangleleft

We can only consider vertices outside of threshold decrease gadgets; it is straightforward to check that if S is hopeful, all threshold decrease gadgets are activated in two rounds.

If $\ell \in Z$, then by Claim 4.2.3 a pair of complementary clique groups K, \overline{K} are both activated in the first round. Thus, a strict majority of vertices in C -pos and C -neg are activated in the first round. This causes the C -guard to be activated in the second round. In the third round, the single vertex connected to C -guard is activated. Moreover, all remaining clique groups are activated, as they have at least $3s$ activated neighbors in total ($2s$ from the threshold decrease gadget, s from C -guard); see Claim 4.2.3. This finishes the proof of Lemma 31. \blacktriangleleft

4.2.4 Multiple Gadget $M(s, q, r)$

The last gadget used is a multiple gadget. It is a variant of selection gadget; similarly to the selection gadget, every target set represents an integer between 0 and qs . However, the multiple gadget additionally ensures that the number is a multiple of q . The last parameter r determines the number of neighboring vertices, as usual. The gadget M consists of a selection gadget $L = L(qs, r + w_{qs}(Q_{q,s}))$ and a check gadget $C = C(Q_{q,s}, qs)$, where $Q_{q,s} = \{0, q, 2q, \dots, sq\}$. Observe that the multiple gadget contains a threshold decrease gadget $D(2qs, w_{qs}(Q_{q,s}))$ as a part of the check gadget $C(Q_{q,s}, qs)$. The type L -pos is connected to C -pos and L -neg is connected to C -neg. The interface of M is the interface of the gadget L , i.e., L -pos and L -neg.

► **Lemma 32.** *Let $M = M(s, q, r)$ be a multiple gadget in G' . If $S \subseteq V(G)$ satisfies $|S \cap V(M)| < 3qs$, then S is not a target set.*

Proof. If $|S \cap V(M)| < 3qs$, then at least one of the following necessarily happens.

- The selection gadget in M has less than qs vertices from S . Then by Lemma 25 we have that S is not a target set.
- The threshold decrease gadget in M has less than $2qs$ vertices from S . By Lemma 27 again S is not a target set.

◀

► **Lemma 33.** *Let $M = M(s, q, r)$ be a multiple gadget in G' with the selection gadget L and let $S \subseteq V(G')$ be a target set with $|S \cap V(M)| = 3qs$. Then, the following holds.*

1. *The qs vertices of S are in the L -pos and L -neg types.*
2. *Suppose v is a vertex in M -interface but not in S . The vertex v cannot be activated before all neighboring vertices of M adjacent to v are activated.*
3. *The number of vertices of $|S \cap V(L\text{-pos})|$ is a multiple of q .*

Proof. For a proof of Part 1 first observe that qs vertices of S must be in the selection gadget in M . There cannot be more by the fact that we have $3qs$ vertices in total and by Lemma 27; on the other hand, there cannot be less by Lemma 25. Now these qs vertices must be in L -pos and L -neg by Lemma 26 Part 1.

Part 2 follows immediately from Lemma 26 Part 2.

Finally for Part 3, if $|S \cap V(L\text{-pos})|$ is not a multiple of q , then the check gadget of M cannot be activate by Lemma 31 and hence S is not a target set. ◀

4.2.5 Finishing the Reduction

We finally have all building blocks for the reduction. The graph G' is constructed as follows (the numbers $r_c, r_{cd}, r_{c:cd}$ will be computed later).

- For each color class V_c we have a selection gadget $L_c = L(n, r_c)$.
- For each edge class E_{cd} we have a multiple gadget $M_{cd} = M(m_{cd}, 2n, r_{cd})$, where $m_{cd} = |E_{cd}|$.
- For each ordered pair (c, d) of vertices of H such that $\{c, d\} \in E(H)$, we have a check gadget $I_{c:cd} = C(Z_{c:cd}, r_{c:cd})$. The $I_{c:cd}$ -pos part of is connected to L_c -pos and M_{cd} -pos. The type $I_{c:cd}$ -neg is connected analogously.

We numerate vertices in each class V_c by numbers from 0 to n and edges in each class E_{cd} by numbers from 0 to m_{cd} . Then if $V_c = \{v_0, \dots, v_n\}$ and $E_{cd} = \{e_0, \dots, e_{m_{cd}}\}$, we set

$$Z_{c:cd} = \{i + 2nj : v_i \in e_j\}.$$

It remains to compute the numbers r_c, r_{cd} , and $r_{c:cd}$. The number $r_{c:cd}$ is $n + 2nm_{cd}$, as $I_{c:cd}$ -pos is adjacent to L_c -pos and M_{cd} -pos.

The gadget M_{cd} is adjacent to $I_{c:cd}$ and $I_{d:cd}$. To determine r_{cd} , we need to count the number of vertices of the pos types in both incident gadgets. This can be expressed by the weight function giving

$$r_{cd} = w_{r_{c:cd}}(Z_{c:cd}) + w_{r_{d:cd}}(Z_{d:cd}).$$

Finally, the gadget L_c is adjacent to $I_{c:cd}$ for every $d \in N_H(c)$. analogously, we get

$$r_c = \sum_{d \in N_H(c)} w_{r_{c:cd}}(Z_{c:cd}).$$

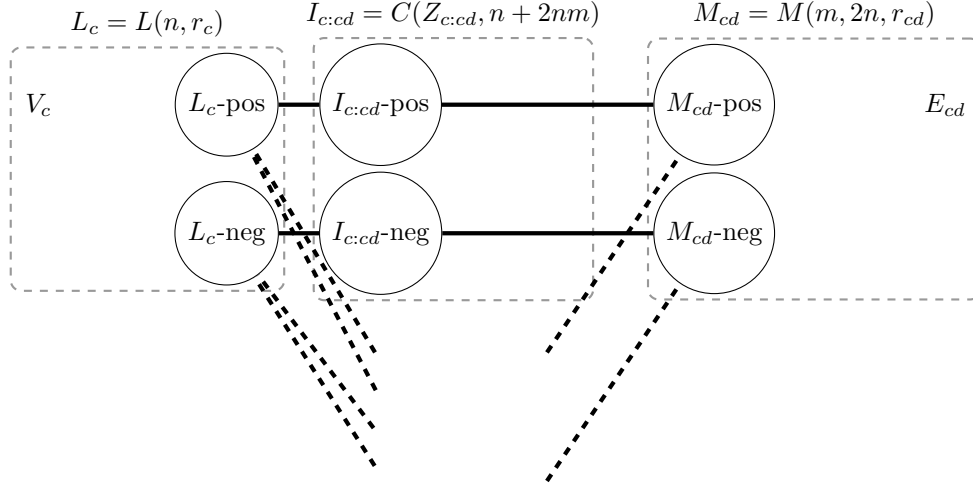

■ **Figure 10** Overview of the reduction.

The budget b is set as

$$b = nk + 6n \cdot \bar{m} + 2n|E(H)| + 4n \cdot \bar{m},$$

where \bar{m} is again $\sum_{\{c,d\} \in E(H)} m_{cd}$. The first term nk is for k selection gadgets $L(n, r_c)$ corresponding to the color classes. The second term accounts the multiple gadgets $M(m_{cd}, 2n, r_{cd})$ corresponding to the edge sets E_{cd} ; each of them requires at least $6nm_{cd}$ vertices of a target set by Lemma 32. The last two terms are for threshold decrease gadgets $D(2(2m_{cd}n + n), w_{2m_{cd}n+n}(Z_{c:cd}))$ inside each check gadget $I_{c:cd} = C(Z_{c:cd}, 2m_{cd}n + n)$.

We verify that G' has size polynomial in $|V(G)|$. Observe that the size of each gadget is polynomial in its parameters, and the parameters are polynomial with respect to $|V(G)|$. Since we have $\mathcal{O}(k)$ gadgets, the whole graph G' has size polynomial in $|V(G)|$, since $k \leq |V(G)|$. Moreover, the graph G' can be clearly constructed in polynomial time.

We turn our attention to the restricted modular width of G' . Consider a graph \hat{G} obtained by replacing each pos and neg part of each check gadget in G' by an independent set of the same size. It is easy to verify that \hat{G} is a graph of neighborhood diversity $\mathcal{O}(k)$; every gadget in \hat{G} has neighborhood diversity bounded by a constant. As each pos or neg part of the check gadget in G' is a cluster graph, we can obtain G' from the type graph $T_{\hat{G}}$ by an appropriate substitution operation. This gives us an algebraic expression proving the restricted modular width of G' is $\mathcal{O}(k)$.

► **Lemma 34.** *The graph G contains a colored copy of H if and only if G' has a target set of size b .*

Proof. First, suppose that G contains a colored copy of H . Denote by ℓ_c the number of the selected vertex in V_c in the numeration we fixed before. Similarly denote by ℓ_{cd} the number of edge that connects the selected vertices in V_c and V_d .

The target set is constructed as follows.

1. Put ℓ_c vertices of L_c -pos and $n - \ell_c$ vertices of L_c -neg into S .
2. Put $2n\ell_{cd}$ vertices of M_{cd} -pos and $2m_{cd}n - 2n\ell_{cd}$ vertices of M_{cd} into S .
3. Put all vertices of the interface part of every threshold decrease gadget into S .

By the choice of b , we see that $|S| = b$. We claim that S is a target set.

By Lemma 31, the check gadget $C(Q_{2n, m_{cd}}, 2nm_{cd})$ in M_{cd} is activated in three rounds as ℓ_{cd} is a multiple of $2n$ and hence is in $Q_{2n, m_{cd}}$. Similarly, as the vertex $v \in V_c$ corresponding to ℓ_c is incident to the edge $e \in E_{cd}$ corresponding to ℓ_{cd} , the gadget $I_{c:cd}$ is activated in three rounds again by Lemma 31, since the number $\ell_c + 2n\ell_{cd}$ is in $Z_{c:cd}$.

We now analyze the gadget $L_c = L(n, r_c)$. The part L_c -guard is activated in the first round. In the third round, all neighboring check gadgets are activated. Since those gadgets together with L_c -guard constitute exactly the half of the neighbors of every vertex in L_c -pos or L_c -neg, these parts are activated in the round four. It is now easy to see that the remaining two types (L_c -doubling and L_c -end) are activated in the rounds five and six.

The argument for the gadget $M_{cd} = M(m_{cd}, 2n, r_{cd})$ is analogous – in the third round, all check gadgets (including the one inside M_{cd}) are activated and again this is enough to activate the M_{cd} -pos and M_{cd} -neg parts in the round four. The rest of the gadget again is activated in the round six. This proves that S is a target set.

For the opposite direction, suppose that we have a target set S in G' with $|S| \leq b$. We know that without loss of generality we may assume that S is hopeful. Let ℓ_c be the number represented by S in V_c and $2n\ell_{cd}$ the number represented by S in M_{cd} . We know the number represented by S in M_{cd} is a multiple of $2n$ by Lemma 33. Now we pick ℓ_c -th vertex from each color class V_c . We claim that those vertices form a solution to the original instance of CSI.

Since S is a target set, we obtain from Lemma 31 that $\ell_c + 2n\ell_{cd} \in Z_{c:cd}$. Note that a number $z \in Z_{c:cd}$ is of the form $z = i + 2nj$ and the number i and j are uniquely determined by z alone; simply take $i = z \bmod 2n$ and $j = z \operatorname{div} 2n$. This means that number $\ell_c + 2n\ell_{cd}$ is in Z if and only if a vertex $v \in V_c$ corresponding to the number ℓ_c is incident to an edge $e \in E_{cd}$ corresponding to the number ℓ_{cd} . Thus, we have proved that the set of vertex obtained from S indeed form a solution to (G, H, ψ) . ◀

This finishes the proof of Theorem 5.

4.3 Twin Cover

As usual, we enumerate vertices in color classes V_c and edges in sets E_{cd} and design vertex, edge, and incidence gadgets based on this enumeration. This time all the gadgets are cliques and we encode the input instance into sizes of parts of these cliques with different thresholds. It is worth noting that in each such clique the number of different vertex thresholds is at most eleven. The resulting instance (G', f, b) of TARGET SET SELECTION is equivalent to the instance (G, H) of CSI and $\operatorname{tc}(G') = \mathcal{O}(k)$.

4.3.1 Construction

Let $c, d \in V(H)$. As we assume $|V_c| = |V_d|$, we denote this common value as $n - 1$ for technical reason. Thus, we can denote the vertices in V_c as v_1^c, \dots, v_{n-1}^c . As we mentioned, we have no control on the number of edges in E_{cd} – it is upper bounded by $(n - 1)^2$.

We arbitrarily orient edges of H . For a vertex c by $\deg^+(c)$ we denote the *in-degree* of c , that is, number of ingoing arcs towards c in this orientation; analogously by $\deg^-(c)$ is the *out-degree* of c . Since H is 3-regular, $\deg(c) = \deg^+(c) + \deg^-(c) = 3$ for every vertex $c \in V(H)$. We divide the vertices of H into 3 groups according to their in-degree and out-degree. For $s \in \{+, -\}$, let $V^s \subseteq V(H)$ be a set of vertices $c \in V(H)$ such that $\deg^s(c) = 3$ and $V^r = V(H) \setminus (V^+ \cup V^-)$.

Vertex Gadget Let $c \in V(H)$ and let $v = v_i^c$ be the i -th vertex in V_c . We first introduce few constants that will later allow us to verify the proof of the correctness of our reduction. Let $\gamma_s = 21$, $\gamma_\ell = 10$, and $\Gamma = \gamma_s + \gamma_\ell + 1$ (γ_s will denote the size of a vertex set which we will call a selector, γ_ℓ will denote the size of a vertex set which we will call class validator and denote L). For the vertex v we create a clique C_v . The size of C_v and thresholds of the vertices in C_v depend on $\deg^-(c)$ and $\deg^+(c)$. The main idea is that in the activation process we first check the incidence of vertices and outgoing arcs and then we check the incidence of ingoing arcs. Thus, for example if $c \in V^+$ (i.e., $\deg^-(c) = 0$), then there is no need to check incidence between selected $v \in V_c$ and outgoing edges. The vertices in C_v are divided into several groups. The sizes of the groups and thresholds of vertices in the group are in the following table.

Name	$c \in V^r$		$c \in V^-$		$c \in V^+$	
	Size	Threshold	Size	Threshold	Size	Threshold
selector	γ_s	$\deg - \gamma_s + 1$	γ_s	$\deg - \gamma_s + 1$	γ_s	$\deg - \gamma_s + 1$
starter	1	γ_s	1	γ_s	1	γ_s
1.	i	Γ	i	Γ	$2n + i$	Γ
2.	$n - i$	$i + \Gamma + \deg^-(c)$	$n - i$	$i + \Gamma + 3$		
3.	$n - i$	$n + \Gamma + \deg^-(c) + 1$	$n - i$	$n + \Gamma + 4$		
4.	i	$2n - i + \Gamma + 2 \deg^-(c) + 1$	i	$2n - i + \Gamma + 7$		
5.	i	$2n + \Gamma + 2 \deg^-(c) + 2$	$n^3 + 2n$	$2n + \Gamma + 8$		
6.	$n - i$	$2n + i + \Gamma + 2 \deg^-(c) + \deg^+(c) + 2$			$n - i$	$2n + i + \Gamma + 3$
7.	$n - i$	$3n + \Gamma + 2 \deg^-(c) + \deg^+(c) + 3$			$n - i$	$3n + \Gamma + 4$
8.	i	$4n - i + \Gamma + 2 \deg^-(c) + 2 \deg^+(c) + 3$			i	$4n - i + \Gamma + 7$
9.	n^3	$4n + \Gamma + 10$			n^3	$4n + \Gamma + 8$

By \deg in the selector vertices threshold is meant the degree of selector vertices not the degree of $c \in V(H)$. If $c \notin V^r$, then the vertex gadget has smaller number of groups than in the general case. Note that $i, j < n$ thus every group is non-empty. We denote all vertices in all cliques C_u for all $u \in V_c$ by U_c . Observe that all of the cliques in U_c are of the same size $n^3 + 4n + \gamma_s + 1$, independent on the value of i .

Edge Gadget Let $e' = (c, d) \in E(H)$. Again, we first introduce few constants. Let $\delta_s = 17$, $\delta_\ell = 8$, and $\Delta = \delta_s + \delta_\ell + 1$. For each edge $e = \{u, v\} \in E_{cd}$ we create a clique C_e . Let $u = v_i^c$ and $v = v_j^d$. There are again eleven groups of vertices in C_e . The sizes of the groups and thresholds of vertices in the group are in the following table.

Name	Size	Threshold
selector	δ_s	$\deg - \delta_s + 1$
starter	1	δ_s
1.	$n - i$	Δ
2.	i	$n - i + \Delta + 1$
3.	i	$n + \Delta + 2$
4.	$n - i$	$n + i + \Delta + 3$
5.	$n - j$	$2n + \Delta + 4$
6.	j	$3n - j + \Delta + 5$
7.	j	$3n + \Delta + 6$
8.	$n - j$	$3n + j + \Delta + 7$
9.	n^4	$4n + \Delta + 8$

All vertices of these cliques are denoted by $U_{e'}$. Observe that all of the cliques in $U_{e'}$ are of the same size $n^4 + 4n + \delta_s + 1$, independent on the value of i or j .

We set the budget b to $\gamma_s \cdot k + \delta_s \cdot |E(H)|$. This will allow us to select one vertex (by adding all of its selector vertices) from each color class V_c as well as one edge from each edge set E_{cd} .

Twin Cover Vertices So far our graph is a cluster graph and thus admits a twin cover of size 0. Now, we are going to add few vertices (forming the twin cover of the constructed graph) in order to connect these pieces together and the reduction to work. For each edge $e' = (c, d) \in E(H)$ we add four *checker* vertices defined in the following table.

Name	Symbol	Threshold
Outgoing lower checker	$\ell^-(c, e')$	$n + \gamma_s + \delta_s + 2$
Outgoing upper checker	$u^-(c, e')$	$3n + \gamma_s + \delta_s + 2$
Ingoing lower checker	$\ell^+(d, e')$	$5n + \gamma_s + \delta_s + 2$
Ingoing upper checker	$u^+(d, e')$	$7n + \gamma_s + \delta_s + 2$

The outgoing checkers $\ell^-(c, e')$ and $u^-(c, e')$ are both connected to all vertices in U_c and $U_{e'}$. Similarly, the ingoing checkers $\ell^+(d, e')$ and $u^+(d, e')$ are both connected to all vertices in U_d and $U_{e'}$. Note that for each vertex $c \in V(H)$ there are $2 \cdot \deg^-(c)$ outgoing checkers and $2 \cdot \deg^+(c)$ ingoing checkers connected to U_c . The checker vertices will check if the selection of vertices in V_c and V_d is consistent with the selection of edge in E_{cd} . For each type of checkers we add one checker validator vertex defined in the following table.

Name	Symbol	Threshold
Outgoing lower checker validator	$\tilde{\ell}^-$	$k \cdot (n + \gamma_s + 1) + E(H) \cdot (n + \delta_s + 2)$
Outgoing upper checker validator	\tilde{u}^-	$k \cdot (2n + \gamma_s + 1) + E(H) \cdot (2n + \delta_s + 2)$
Ingoing lower checker validator	$\tilde{\ell}^+$	$k \cdot (3n + \gamma_s + 1) + E(H) \cdot (3n + \delta_s + 2)$
Ingoing upper checker validator	\tilde{u}^+	$k \cdot (4n + \gamma_s + 1) + E(H) \cdot (4n + \delta_s + 2)$

All four checker validators are connected to all twin cliques (i.e., the vertices in U_c and $U_{e'}$ for each $c \in V(H)$ and $e' \in E(H)$). Further, each checker validator is connected to all checkers of corresponding type, i.e., $\tilde{\ell}^-$ is connected to all outgoing lower checkers $\ell^-(c, e')$, \tilde{u}^- is connected to all outgoing upper checkers $u^-(c, e')$ etc. The purpose of the checker validators is that if some checker is not activated due to an invalid selection, then the corresponding checker validator is not activated as well and it will stop the activation process in the whole graph G' .

Next, for each $c \in V(H)$ we add γ_ℓ *class validator* vertices L_c and γ_s *sentry* vertices R_c . The class validator vertices L_c and the sentry vertices R_c are connected to all vertices in U_c . The threshold of class validator vertices L_c is $\gamma_s + 1$ and the threshold of sentry vertices R_c is set to the clique size in U_c , i.e., $n^3 + 4n + \gamma_s + 1$.

Similarly, for each $e' \in E(H)$ we add δ_ℓ *class validator* vertices $L_{e'}$ and δ_s *sentry* vertices $R_{e'}$. The class validator vertices $L_{e'}$ and the sentry vertices $R_{e'}$ are connected to all vertices in $U_{e'}$. The threshold of class validator vertices $L_{e'}$ is $\delta_s + 1$ and the threshold of sentry vertices $R_{e'}$ is set to the clique size in $U_{e'}$, i.e., $n^4 + 4n + \delta_s + 1$.

The purpose of class validator vertices is that vertices only from one clique C_v in each U_c are selected to the target set. The intended meaning of sentry vertices is to be activated when for each $c \in V(H)$ one vertex gadget C_v in U_c is activated and for each $e' \in E(H)$ one edge gadget C_e in $U_{e'}$ is activated. After that the sentry vertices will help to activate the remaining (i.e., not selected) gadgets.

Let τ denote the number of non-selector vertices constructed so far. We finish the construction by adding $b + \gamma_s$ *special* vertices with threshold $\tau + b$ and we connect these to every vertex constructed so far. These vertices play an important role in our reduction as they ensure that any target set consists of selector vertices only (see Lemma 36). Recall that b is linear in k . Thus, the twin cover of the constructed graph has size

$$\text{tc}(G') \leq (\gamma_s + \gamma_\ell) \cdot k + (4 + \delta_\ell + \delta_s) \cdot |E(H)| + b + \gamma_s + 4 = \mathcal{O}(k).$$

4.3.2 Subgraph Gives Target Set

Suppose G contains a colored copy of H given by a mapping $\phi: V(H) \rightarrow V(G)$. We put the following selector vertices to the set S .

- Let $c \in V(H)$ and $v = \phi(c) \in V(G)$. We put all γ_s selector vertices from C_v into S .
- Let $(c, d) \in E(H)$ and $u = \phi(c), v = \phi(d)$. By property of ϕ we know that $e = \{u, v\} \in E(G)$. We put all δ_s selector vertices from C_e into S .

It is clear that $|S| = b$. We claim that S forms a target set for the graph G' constructed in the previous section. The high-level description of the activation process is that first the vertices in C_v and C_e cliques with checkers and checker validators are activated for the selected $v \in V(G)$ and $e \in E(G)$. Then, the sentry vertices are activated which causes activation of all vertex and edge gadgets without the selector vertices. At the end the special vertices and remaining selector vertices are activated.

Let $V^* = \{\phi(c) | c \in V(H)\}$ and let $E^* = \{\{\phi(c), \phi(d)\} | (c, d) \in E(H)\}$ be the sets vertices and edges of G selected by ϕ . Let $\bar{u} \in V_c \setminus V^*$ and $\bar{e} \in E_{c'd'} \setminus E^*$ and $e' = (c', d') \in E(H)$. Note that for the vertex \bar{u} and the edge \bar{e} the minimal threshold in $C_{\bar{u}}$ is γ_s and in $C_{\bar{e}}$ it is δ_s . Thus, some vertices in these cliques can be activated after at least γ_s (or δ_s) vertices in their neighborhood in twin cover are activated. We will show that these neighborhood vertices of $C_{\bar{u}}$ (or $C_{\bar{e}}$) are activated in the order:

1. γ_ℓ (or δ_ℓ) class validator vertices L_c (or $L_{e'}$).
2. 6 (or 4) checkers and 4 checker validators.
3. γ_s (or γ_s) sentry vertices R_c (or $R_{e'}$).
4. $b + \gamma_s$ special vertices.

Since $21 = \gamma_s > 10 + \gamma_\ell = 20$, the first vertex in $C_{\bar{u}}$ is activated after the sentry vertices R_c are activated. By similar argument, the same holds for $C_{\bar{e}}$, i.e., the first vertex in $C_{\bar{e}}$ is activated after the sentry vertices $R_{e'}$.

Let $e' = (c, d) \in E(H)$, $u = v_i^c \in V^*$, $v = v_j^d \in V^*$, and $e = \{u, v\} \in E^*$, i.e., u and v are the selected vertices from V_c and V_d and e is the selected edge from E_{cd} incident to u and v . We describe the activation process from the point of view of u, v , and e , i.e., the following rounds holds for every $u^* \in V^*$, $\hat{c} \in V(H)$, $e^* \in E^*$, and $\hat{e} \in E(H)$, not only for u, v, c, d, e , and e' . In what follows please refer to Figure 11.

S_1 : Starters. In C_u and C_v the starter vertex is activated because there are γ_s active selector vertices in C_u and in C_v . Similarly, the starter vertex in C_e is activated.

S_2 : Class validators. The class validator vertices L_c and L_d are activated because there are $\gamma_s + 1$ active vertices in C_u and C_v . Similarly, the class validator vertices $L_{e'}$ are activated.

S_3 : First groups. In C_u the first groups are activated because there are $\gamma_s + 1$ active vertices in C_u (selector and starter) and γ_ℓ active class validators in the neighborhood of C_u . Similarly, the first group in C_e and in C_v is activated.

S_4 : Outgoing lower checkers. The lower checker $\ell(c, e')$ of threshold $n + \gamma_s + \delta_s + 2$ is activated. It has $i + \gamma_s + 1$ active neighbors in C_u and $n - i + \delta_s + 1$ active neighbors in C_e .

S_5 : Second groups. There are $\deg^-(c)$ active outgoing lower checkers in the neighborhood of C_u and $\deg^-(d)$ active outgoing lower checkers in the neighborhood of C_v (and γ_ℓ active class validators L_c and L_d). Thus, the second group in C_u is activated, since in total there are

$$i + \gamma_s + 1 + \deg^-(c) + \gamma_\ell = i + \Gamma + \deg^-(c)$$

active vertices in their neighborhood. Similarly, if $\deg^-(d) \neq 0$, the second group in C_v is activated as well. There is one active outgoing lower checker in the neighborhood of C_e , thus the second group of C_e is activated.

S_6 : Outgoing lower checker validator. For each $\hat{c} \in V(H)$ there is exactly one clique $C \in U_{\hat{c}}$ such that there are $n + \gamma_s + 1$ active vertices in C (selector, starter and first two groups). Similarly, for each $\hat{e} \in E(H)$ there is exactly one clique $C' \in U_{\hat{e}}$ such that there are $n + \delta_s + 1$ active vertices C' . Further, for each $\hat{e} = (\hat{c}, \hat{d}) \in E(H)$ the outgoing lower checker $\ell^-(\hat{c}, \hat{e})$ is active. Thus, the outgoing lower checker validator $\tilde{\ell}^-$ is activated as it has

$$k \cdot (n + \gamma_s + 1) + |E(H)| \cdot (n + \delta_s + 2)$$

active neighbors.

S_7 : Third groups. There are $\deg^-(c)$ active lower checkers and the active outgoing lower checker validator $\tilde{\ell}^-$ in the neighborhood of C_u . Thus, the third group of threshold $n + \Gamma + \deg^-(c) + 1$ in C_u is activated. Similarly, if $\deg^-(d) \neq 0$, the third group in C_v is activated. There is one active lower checker and $\tilde{\ell}^-$ in the neighborhood of C_e , thus the third group of C_e is activated as well.

S_8 : Outgoing upper checkers. The outgoing upper checker $u^-(c, e')$ of threshold $3n + \gamma_s + \delta_s + 2$ is activated. It has $2n - i + \gamma_s + 1$ active neighbors in C_u and $n + i + \delta_s + 1$ active neighbors in C_e .

S_9 : Fourth groups. There are $\deg^-(c)$ active outgoing lower checkers, $\deg^-(c)$ active outgoing upper checkers and active $\tilde{\ell}^-$ in the neighborhood of C_u . Thus, the fourth group in C_u is activated. Similarly, if $\deg^-(d) \neq 0$, the fourth group in C_v is activated. There are two active outgoing checkers and active $\tilde{\ell}^-$ in the neighborhood of C_e , thus the fourth group of C_e is activated as well.

S_{10} : Outgoing upper checker validator. The vertex \tilde{u}^- has $2n + \gamma_s + 1$ active neighbors in each $U_{\hat{c}}$ (there is one clique with active selector, starter and first four groups) and $2n + \gamma_s + 1$ active neighbors in each $U_{\hat{e}}$. Further, there are $|E(H)|$ active outgoing upper checkers in the neighborhood of \tilde{u}^- . Thus, the vertex \tilde{u}^- is activated.

S_{11} – S_{18} : Groups 5–8, ingoing checkers and ingoing checker validators. In the next 8 rounds ingoing checkers and corresponding checker validators with the groups 5–8 are activated in the similar manner as the group 1–4 with outgoing checkers and checker validators. Note that if $c \in V^-$, then in the round 11, the whole clique C_u is activated and in the round 12 the sentry vertices R_c are activated. Furthermore, other non-selector vertices in U_c are activated in subsequent rounds 13–18 (for the description of similar process for $c \in V^r$ see rounds 21–30 below). Then, nothing is activated in such classes until the round 32.

S_{19} : Ninth groups. There are all 6 active checkers and all 4 active checker validators in the neighborhood of C_u , thus the ninth group is activated (if $c \notin V^-$) and same for C_v .

There are all 4 active checkers all 4 active checker validators in the neighborhood of C_e , thus the ninth group of C_e is activated.

S_{20} : Sentries. Up until now we have activated the following vertices:

- The vertex gadget C_v of size $n^3 + 4n + \gamma_s + 1$ and the vertex gadget C_u .
- The edge gadget C_e of size $n^4 + 4n + \delta_s + 1$.
- All checkers, checker validators and class validators.

Every sentry vertex $r \in R_c$ has $n^3 + 4n + \gamma_s + 1$ active neighbors – namely, the clique C_v . Thus, all sentry vertices in R_c are activated. Similarly, all sentry vertices in R_d and $R_{e'}$ are activated.

S_{21} – S_{30} : Non-selector vertices. Every vertex gadget has $10 + \gamma_s + \gamma_\ell$ active neighbors (6 checkers, 4 checker validators, γ_ℓ class validators and γ_s sentry vertices). Thus, every vertex gadget in U_c (if $c \notin V^-$) without the selector vertices is activated group by group in 10 rounds (see Figure 11). The sentry vertices substitute the selector vertices during this phase. The non-selector vertices in U_d are activated in the similar way. If $d \in V^+$ then non-selector vertices in U_d are activated in 6 rounds (and then no vertex is activated in U_d till the round S_{32}). Every edge gadget in $U_{e'}$ has $8 + \delta_s + \delta_\ell$ active neighbors and is activated in the same way as each vertex gadget.

S_{31} : Special vertices. All τ non-selector and non-special vertices are active. Since b selector vertices are active from the beginning, the special vertices are activated.

S_{32} : Guard. All vertices except selector vertices not in S are active. Note that, each selector vertex has threshold its degree minus the number of selector vertices in its neighborhood. Thus, all remaining selector vertices are activated and $S_{32} = V(G')$.

Thus, we prove the following theorem.

► **Theorem 35.** *If G contains a colored copy of H , then G' with the threshold function f contains a target set of size b .* ◀

4.3.3 Target Set Gives Subgraph

In this section we want to prove the converse implication of Theorem 35. Let S be a target set of G' and $|S| \leq b$. First, we want to prove that basically the only possibility is that S corresponds to a (valid) selection of vertices and edges (i.e., S contains all selector vertices of exactly one vertex or edge gadget in each class). We prove this in the following lemmata.

► **Lemma 36.** *The set S consists of b selector vertices.*

Proof. Suppose the set S does not contain b selector vertices. Note that there are at least γ_s special vertices not in S . Let T be the set of all special vertices not in S . We show that S cannot activate vertices in T . Let v be a selector vertex which is not in S . By our construction, the vertex v has at most γ_s other selector vertices as neighbors. Since $f(v) \geq \deg(v) - \gamma_s + 1$ (note that $f(v) = \deg(v) - \gamma_s + 1$ for a selector vertex in a vertex gadget and $f(v) = \deg(v) - \delta_s + 1$ for a selector vertex in an edge gadget; furthermore, $\gamma_s \geq \delta_s$), the vertex v is activated after at least one vertex in T is activated.

Thus, any selector vertex which is not in S can be activated only after at least one vertex in T activated. However, the vertices in T have threshold $\tau + b$. Therefore, even if all non-selector vertices are activated, at least b selector vertices have to be in S . ◀

Before we prove that in each set U_z (for $z \in V(H) \cup E(H)$) there is a correct number of selector vertices in S we first observe few facts about the last rounds of the activation process arising from a set of selector vertices S . In order to give more properties (in fact,

more “local” ones) the set S must fulfill it helps us if we understand the last rounds of the activation process as it mainly deals with the globally connected vertices forming the twin cover. This allows us to prove the sought properties more in a local way.

► **Lemma 37.** *The following holds in the activation process arising from S :*

1. *Selector vertices not in S are activated in the last round of the activation process.*
2. *Special vertices are activated in the last but one round.*

Proof. The threshold of special vertices is $\tau + b$, thus they can be activated when all τ non-selector vertices are activated. The selector vertices have their threshold set exactly to the number of their non-selector neighbors and they are connected to the special vertices. Thus, selectors not in S have to be activated after the special vertices. We conclude the activation of these two groups of vertices takes place in the last two rounds of the activation process arising from S . ◀

In particular, the above lemma implies that even if a single (group of) sentry vertices is not activated before the special vertices and the selector vertices not in S , the activation process arising from S terminates before all of the vertices are active and thus S is not a target set. Let $z \in V(H) \cup E(H)$. For a clique C in U_z we denote the non-empty group with the highest number as the *last group* (for $z \in V^-$ the last group is the fifth group and for $z \notin V^-$ the last group is the ninth group).

► **Lemma 38.** *Let $z \in V(H) \cup E(H)$. In the activation process arising from S , the sentry vertices in R_z can be activated after the last group of at least one clique in U_z is activated.*

Proof. Suppose $z \in V(H)$. Then, the threshold of vertices in R_z is larger than n^3 . The size of each clique C_v in U_z without the last group is $4n + \gamma_s + 1$ and there are $n - 1$ cliques in U_z . Thus, even if all cliques in U_z without the last groups are activated, the sentry vertices in R_z can not be activated, since $n^3 > (4n + \gamma_s + 1)(n - 1)$ for $n \geq 6$ and the only neighborhood of R_z are the special vertices and vertices in U_z .

The proof for $z \in E(H)$ is analogous. There are at most n^2 cliques in U_z and each cliques without the last group has $4n + \delta_s + 1$ vertices. Since the thresholds of sentry vertices in R_z is at least n^4 , the lemma follows. ◀

Now, we are ready to finish the first part of the proof – namely, that the selection indeed corresponds to a selection of vertices and edges in the original instance of CSI.

► **Lemma 39.** *For each $c \in V(H)$ there is exactly one vertex $v \in V_c$ such that $V(C_v) \cap S$ contains exactly γ_s selectors in the vertex gadget C_v . For each $(c, d) \in E(H)$ there is exactly one edge $e \in E_{cd}$ such that $V(C_e) \cap S$ contains exactly δ_s selectors in the edge gadget C_e .*

Proof. We prove the lemma for edges $E(H)$ (the proof for vertices $c \in V(H)$ follows in a similar way but we have to distinguish cases if c is in V^- or not). Suppose there is $e' = (c, d) \in E(H)$ such that for all $e \in E_{cd}$ holds $|V(C_e) \cap S| < \delta_s$. We prove the sentry vertices $R_{e'}$ are never activated. Let us assume all 4 checker, all 4 checker validators and the class validator $L_{e'}$ are activated. Thus, in each C_e all groups but selectors not in S and the last one are activated in 9 rounds. However, the last group in C_e can not be activated. The last group has the following active neighbors:

- $4n$ vertices in the groups 1–8 in C_e .
- 1 starter vertex in C_e .
- Strictly less than δ_s selectors in C_e .
- δ_ℓ class validators $L_{e'}$.

■ 4 checkers and 4 checker validators.

In total the last group has strictly less than $4n + 1 + \delta_s + \delta_\ell + 8 = 4n + \Delta + 8$, which is the threshold of the last group. Thus, the last group in any C_e in $U_{e'}$ can be activated after some sentry vertex in $R_{e'}$, or special vertex or selector vertex in $C_e \setminus S$ is activated. However, this cannot happen due to Lemma 37 and 38.

Thus, for each $z \in V(H) \cup E(H)$ there is at least one clique $C \in U_z$ such that $|C \cap S| \geq \delta_s$ (or γ_s if $z \in V(H)$). Since the size of b is $\gamma_s \cdot k + \delta_s \cdot |E(H)|$, these inequalities are actually tight and the lemma follows. ◀

By Lemma 39, the set S contains:

1. For each vertex $c \in V(H)$ exactly γ_s selector vertices in exactly one C_v in U_c .
2. For each edge $e' \in E(H)$ exactly δ_s selector vertices in exactly one C_e in $U_{e'}$.

Thus, we can define mappings $\phi: V(H) \rightarrow V(G)$ and $\phi_E: E(H) \rightarrow E(G)$ such that

$$\begin{aligned} \phi(c) &= v \text{ if } v \in V_c \text{ and } |C_v \cap S| = \gamma_s \text{ and} \\ \phi_E((c, d)) &= e \text{ if } e \in E_{cd} \text{ and } |C_e \cap S| = \delta_s. \end{aligned}$$

It remains to prove the mapping ϕ is a solution to the instance of CSI. The next lemma shows that ϕ maps edges of H to the edges of G .

► **Lemma 40.** *For each $(c, d) \in E(H)$ it holds that $\phi_E((c, d)) = \{\phi(c), \phi(d)\}$.*

Proof. We prove this by a more detailed examination of the activation process arising from the set S . Let $e = \phi_E(e')$ for $e' = (c, d) \in E(H)$. Let $u = \phi(c)$ and $v = \phi(d)$. We will prove that $u, v \in e$.

We claim the outgoing checkers connected to C_e are activated if and only if $u \in e$. Let $u = v_i^c$ for some $i \in \mathbb{N}$ and let $e \cap \{v_1^c, \dots, v_{n-1}^c\} = v_j^c$. We will prove that $i = j$. We observe that the activation process begins by following the lines of the proof of Theorem 35. In the first round the starter vertex in C_u is activated, then the class validator vertices are activated and then the first group of vertices in C_u is activated in the third round. Thus, there are $i + \gamma_s + 1$ active vertices in U_c by now. Similarly for e – there are $n - j + \delta_s + 1$ vertices activated in C_e . The vertices in the neighborhood of C_e with the lowest threshold is the outgoing lower checker $\ell^-(c, e')$.

Now suppose that $n - j + i < n$, i.e., the checker $\ell(c, e')$ can not be activated in the round 4. Consequently, the second groups of C_e and C_u are not activated in the round 5. There can be some cliques C in U_z for some $z \in V(H) \cup E(H)$ such that the second group of C is activated in the round 5 (if an appropriate number of outgoing lower checkers connected to C were activated in the round 4). We claim in this moment the activation process stops. In the round 6 the outgoing lower checker validator $\tilde{\ell}^-$ should be activated. However, to activate $\tilde{\ell}^-$ the selector, starter and first two groups of one clique C in U_z for each $z \in V(H) \cup E(H)$ and all outgoing lower checkers have to be active. The second group of C_e and C_u and the checker $\ell(c, e')$ are not active, thus $\tilde{\ell}^-$ can not be activated. To continue with the activation process, to activate the third group of any gadget clique C the vertex $\tilde{\ell}^-$ needs to be activate. Therefore, the activation process stops in the round 5.

On the other hand, if $i + n - j \geq n$ (i.e., $j \leq i$), the lower checker vertex is activated. The activation process proceed as it is described in the previous section. The outgoing upper checker $u^-(c, e')$ should be activated in the round 8. If it is not activated, then the activation process stops latest in the round 9 by the same argument as we presented for the outgoing lower checker. Otherwise, if $u^-(c, e')$ is activated, then $2n - i + n + j \geq 3n$ (i.e., $j \geq i$). Thus, we prove that if S is a target set, then $u \in e$.

The argument for $v \in e$ is similar, only ingoing checker vertices $\ell(d, e')$ and $u(d, e')$ and ingoing checker validators $\tilde{\ell}^+$ and \tilde{u}^+ are used. ◀

This finishes the proof of Theorem 4.

5 Conclusions

We have generalized ideas of previous works [3, 22] for the TARGET SET SELECTION problem. The presented results give a new idea how to encode selecting vertices and edges in the COLORED SUBGRAPH ISOMORPHISM problem for showing W[1]-hardness and ETH-lower bound. In particular, only few problems are known to be W[1]-hard when parameterized by neighborhood diversity – which is the case for the TARGET SET SELECTION problem. We are not aware of other positive results concerning the number of different thresholds instead of the threshold upper-bound.

We would like to point out that in our proofs of W[1]-hardness the activation process terminates after constant number of rounds (independent of the parameter value and the size of the input graph). This is true also for all reductions given by Chopin et al. [6].

References

- 1 Eyal Ackerman, Oren Ben-Zwi, and Guy Wolfowitz. Combinatorial model and bounds for target set selection. *Theoretical Computer Science*, 411(44):4017 – 4022, 2010. doi:10.1016/j.tcs.2010.08.021.
- 2 József Balogh, Béla Bollobás, and Robert Morris. Bootstrap percolation in high dimensions. *Combinatorics, Probability & Computing*, 19(5-6):643–692, 2010. doi:10.1017/S0963548310000271.
- 3 Oren Ben-Zwi, Danny Hermelin, Daniel Lokshtanov, and Ilan Newman. Treewidth governs the complexity of target set selection. *Discrete Optimization*, 8(1):87 – 96, 2011. Parameterized Complexity of Discrete Optimization.
- 4 Ning Chen. On the approximability of influence in social networks. *SIAM Journal on Discrete Mathematics*, 23(3):1400–1415, 2009.
- 5 Chun-Ying Chiang, Liang-Hao Huang, Bo-Jr Li, Jiaojiao Wu, and Hong-Gwa Yeh. Some results on the target set selection problem. *Journal of Combinatorial Optimization*, 25(4):702–715, 2013. doi:10.1007/s10878-012-9518-3.
- 6 Morgan Chopin, André Nichterlein, Rolf Niedermeier, and Mathias Weller. Constant thresholds can make target set selection tractable. *Theory Comput. Syst.*, 55(1):61–83, 2014. doi:10.1007/s00224-013-9499-3.
- 7 Ferdinando Cicalese, Gennaro Cordasco, Luisa Gargano, Martin Milanič, Joseph Peters, and Ugo Vaccaro. Spread of influence in weighted networks under time and budget constraints. *Theoretical Computer Science*, 586:40–58, 2015.
- 8 Ferdinando Cicalese, Gennaro Cordasco, Luisa Gargano, Martin Milanič, and Ugo Vaccaro. Latency-bounded target set selection in social networks. *Theoretical Computer Science*, 535:1–15, 2014.
- 9 Bruno Courcelle, Johann A. Makowsky, and Udi Rotics. Linear time solvable optimization problems on graphs of bounded clique width. In *WG 98*, pages 1–16, London, UK. Springer-Verlag. URL: <http://dl.acm.org/citation.cfm?id=647679.732157>.
- 10 Pedro Domingos and Matt Richardson. Mining the network value of customers. In *ACM SIGKDD*, pages 57–66. ACM, 2001.
- 11 Paul A. Dreyer Jr. and Fred S. Roberts. Irreversible k-threshold processes: Graph-theoretical threshold models of the spread of disease and of opinion. *Discrete Applied Mathematics*, 157(7):1615–1627, 2009. doi:10.1016/j.dam.2008.09.012.

- 12 András Frank and Éva Tardos. An application of simultaneous diophantine approximation in combinatorial optimization. *Combinatorica*, 7(1):49–65, 1987. doi:10.1007/BF02579200.
- 13 Jakub Gajarský, Michael Lampis, and Sebastian Ordyniak. Parameterized algorithms for modular-width. In *IPEC 2013*, pages 163–176, 2013. doi:10.1007/978-3-319-03898-8_15.
- 14 Robert Ganian. Twin-cover: Beyond vertex cover in parameterized algorithmics. In *IPEC 2011*, pages 259–271, 2011. doi:10.1007/978-3-642-28050-4_21.
- 15 Martin Grohe and Dániel Marx. On tree width, bramble size, and expansion. *J. Combin. Theory Ser. B*, 99(1):218–228, 2009. doi:10.1016/j.jctb.2008.06.004.
- 16 Tim A. Hartmann. Target Set Selection Parameterized by Clique-Width and Maximum Threshold. In *SOFSEM 2018*, pages 137–149. Springer International Publishing, 2018.
- 17 Russell Impagliazzo and Ramamohan Paturi. On the complexity of k-sat. *J. Comput. Syst. Sci.*, 62(2):367–375, 2001.
- 18 David Kempe, Jon Kleinberg, and Éva Tardos. Maximizing the spread of influence through a social network. In *ACM SIGKDD*, pages 137–146. ACM, 2003.
- 19 Michael Lampis. Algorithmic meta-theorems for restrictions of treewidth. *Algorithmica*, 64(1):19–37, 2012. doi:10.1007/s00453-011-9554-x.
- 20 Hendrik W. Lenstra, Jr. Integer programming with a fixed number of variables. *Mathematics of Operations Research*, 8(4):538–548, 1983. doi:10.1287/moor.8.4.538.
- 21 Dániel Marx. Can you beat treewidth? *Theory of Computing*, 6(1):85–112, 2010. doi:10.4086/toc.2010.v006a005.
- 22 André Nichterlein, Rolf Niedermeier, Johannes Uhlmann, and Mathias Weller. On tractable cases of target set selection. *Social Netw. Analys. Mining*, 3(2):233–256, 2013. doi:10.1007/s13278-012-0067-7.
- 23 David Peleg. Local majorities, coalitions and monopolies in graphs: A review. *Theor. Comput. Sci.*, 282(2):231–257, 2002. doi:10.1016/S0304-3975(01)00055-X.
- 24 Matthew Richardson and Pedro Domingos. Mining knowledge-sharing sites for viral marketing. In *ACM SIGKDD*, KDD '02, pages 61–70, New York, NY, USA, 2002. ACM. doi:10.1145/775047.775057.
- 25 Neil Robertson and Paul D. Seymour. Graph minors. ii. algorithmic aspects of tree-width. *Journal of Algorithms*, 7(3):309 – 322, 1986. doi:http://dx.doi.org/10.1016/0196-6774(86)90023-4.
- 26 Marc Tedder, Dereck G. Corneil, Michel Habib, and Christophe Paul. Simpler linear-time modular decomposition via recursive factorizing permutations. In *ICALP 2008*, pages 634–645, 2008. doi:10.1007/978-3-540-70575-8_52.

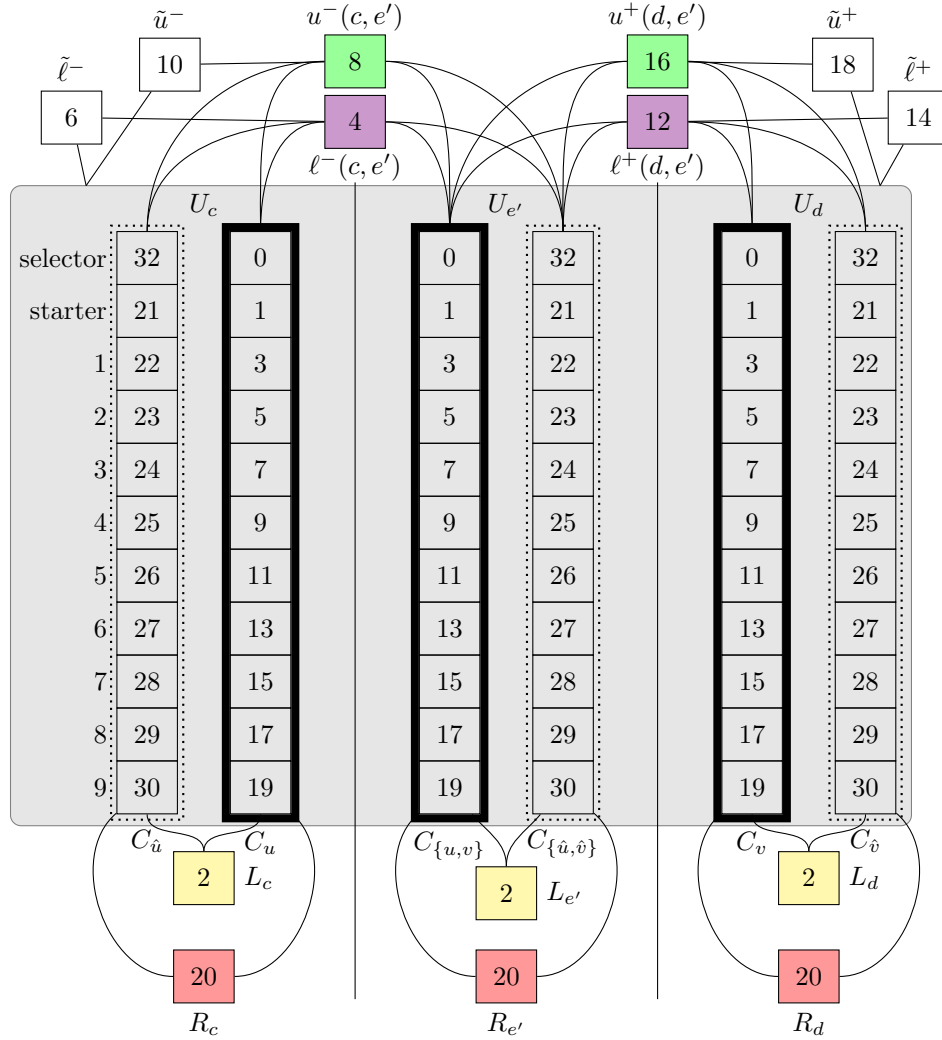

■ **Figure 11** A schema of an activation process for a Yes-instance of CSI. If there is an edge between two groups of vertices, this indicates that every vertex of one group is adjacent to every vertex in the other group. A rectangle represents a group of vertices and a number ℓ stands for activation in the round S_ℓ . Vertices in the twin cover have the following colors: class validators yellow, lower checkers violet, upper checkers green, class sentry vertices light red, and checker validators white (special vertices are omitted). Groups in vertex and edge gadgets are in the same order as in the table. For simplicity we only depict two vertex gadgets from $\phi^{-1}(c)$ and $\phi^{-1}(d)$ with $\deg^-(c), \deg^-(d) \in \{1, 2\}$; the selected vertex gadget has bold borders. Finally, the gray area “contains” all the twin-cliques (the vertices in U_c and $U_{e'}$ for each $c \in V(H)$ and $e' \in E(H)$).