

# Robustness of DC Power Networks under Weight Control

Qin Ba      Ketan Savla

## Abstract

We study, possibly distributed, robust weight control policies for DC power networks that change link susceptances or *weights* within specified operational range in response to balanced disturbances to the supply-demand vector. The margin of robustness for a given control policy is defined as the radius of the largest  $\ell_1$  ball in the space of balanced disturbances under which the link flows can be asymptotically contained within their specified limits. For centralized control policies, there is no post-disturbance dynamics, and hence the control design as well as margin of robustness are obtained from solution to an optimization problem, referred to as the *weight control problem*, which is non-convex in general. We establish relationship between feasible sets for DC power flow and associated network flow, which is used to establish an upper bound on the margin of robustness in terms of the min cut capacity. This bound is proven to be tight if the network is tree-like, or if the lower bound of the operation range of weight control is zero. An explicit expression for the flow-weight Jacobian is derived and is used to devise a projected sub-gradient algorithm to solve the relaxed weight control problem. An exact multi-level programming approach to solve the weight control problem for reducible networks, based on recursive application of equivalent bilevel formulation for relevant class of non-convex network optimization problems, is also proposed. The lower level problem in each recursion corresponds to replacing a sub-network by a (virtual) link with equivalent weight and capacities. The equivalent capacity function for tree-reducible networks is shown to possess a strong quasi-concavity property, facilitating easy solution to the multilevel programming formulation of the weight control problem. Robustness analysis for natural decentralized control policies that decrease weights on overloaded links, and increase weights on underloaded links with increasing flows is provided for parallel networks. Illustrative simulation results for a benchmark IEEE network are also included.

## I. INTRODUCTION

Robustness to man-made and natural disturbances is becoming an important consideration in the design and operation of critical infrastructure networks, such as the power grid, in part due to potential catastrophic consequences caused by ensuing cascading failures which can also affect other dependent systems. Disturbances to power networks are usually in the form of line failures and fluctuations in the supply-demand profile, *e.g.*, due to renewables. From a control design perspective, the objective is to ensure that variations in power flow quantities caused by such

The authors are with the Sonny Astani Department of Civil and Environmental Engineering at the University of Southern California, Los Angeles, CA. {qba, ksavla}@usc.edu. They were supported in part by NSF CAREER ECCS Project No. 1454729. Partial results from this paper appeared as [1]. This paper contains proofs and other technical details missing in [1], as well as several new results.

external disturbances do not violate physical constraints such as exceeding line thermal limits or voltage collapse. The most well-studied control strategies range from load/frequency/voltage control to changing, usually shedding, of supply and demand, possibly combined with intentional islanding of smaller sections of a power network.

In this paper, we consider a DC model for (transmission) power networks, which is subject to balanced disturbances to the supply-demand vector, *i.e.*, disturbance vectors whose entries add up to zero. Such disturbances can result, *e.g.*, from the tripping of an active line. Alternately, one could attribute such disturbances to the residual of actual disturbances which can not be handled by other control means. We consider the relatively less studied control strategy that uses information about link flows and susceptances, or *weights*, and disturbance, to change line weights in order to ensure that the line flows remain within prescribed limits. The control policies can be constrained in the available information, *e.g.*, in the decentralized case, the controller on a given link has access only to information about the weight and flow on itself. The only dynamics in this paper are to be attributed to distributed control settings, where each controller has incomplete information, thereby leading to iterative control actions. The margin of robustness of a given control policy is defined as the radius of the largest  $\ell_1$  ball in the space of balanced disturbances under which the link flows can be asymptotically contained within their specified limits. This notion of margin of robustness is related to *system loadability*, *e.g.*, see [2], which quantifies deviations in supply-demand vector in terms of percentage of the nominal, *i.e.*, pre-disturbance, value under which the system remains feasible. The objective of this paper is to compute margin of robustness of weight control strategies, and to design control policies which are provably maximally robust.

The weight control strategy in this paper is motivated by FACTS devices, which allow online control of line properties in power networks. These devices are typically expensive, with the cost depending on the range of operation, *e.g.*, see [3]. This has motivated research on optimal placement of a given number of FACTS devices, *e.g.*, see [3], [4]. In our framework, such economic aspects can be incorporated implicitly by constraining the control to change line weights within specified limits. The formal analysis in this paper is to be contrasted with previous work on coordinated control of FACTS devices, *e.g.*, see [5], to improve system loadability, or usage of FACTS devices to improve efficiency [6] and security [7]. Use of FACTS devices in the context of the optimal power flow problem has also been explored, *e.g.*, see [8]. However, none of these or related works, to the best of our knowledge, provide formal performance guarantees.

The weight control problem in this paper is related to the so called impedance interdiction problem which has been studied for DC power flow models in [9]. The objective in such interdiction problems is to analyze the vulnerability of power networks against an adversary who changes the susceptances of power lines subject to budget constraints. The weight control problem in this paper can also be considered to be relaxation of the transmission switching and network topology optimization problem for power networks, *e.g.*, see [10], where the objective is to choose a subset among all possible links, subject to connectivity constraints, that allow to transfer power between given load and supply nodes, subject to thermal capacity constraints. The non-triviality of this problem can be attributed to non-monotonicity of power flow with respect to changes in demand-supply profile or changes in graph topology of the network (see Example 2 for simple illustrations). In the topology control problem, the control actions associated

with every link only take binary values corresponding to on/off status of the link, or equivalently corresponding to the weight of that link being equal to either zero or its nominal value. On the other hand, in our weight control problem, we allow a continuum of control actions that includes these two values.

In the centralized case, when our model has no post-disturbance dynamics, computation of margin of robustness and design of robust weight control strategies can be posed as an optimization problem, referred to as the *weight control problem*, which is non-convex in general. The solution to this problem also gives an upper bound on the margin of robustness for any, including decentralized, weight control policies. We establish relationship between feasible sets for DC power flow and associated network flow, which is used to establish an upper bound on the margin of robustness in terms of the min cut capacity. This bound is proven to be tight if the network is tree-like, or if the lower bound of the operation range of weight control is zero, *i.e.*, allowing for disconnecting links.

We propose a projected sub-gradient algorithm to solve the weight control problem for multiplicative disturbances. A key component of this algorithm is the flow-weight Jacobian, *i.e.*, a matrix whose elements give the sensitivities of link flows with respect to link weights. We provide an explicit expression for this Jacobian, and make connections with existing results that characterize change in link flows due to removal of links for DC power flow models, *e.g.*, see [11]–[13].

We also provide a multilevel programming approach to solve the weight control problem for reducible networks. Specifically, we first identify a class of network optimization problems which can be equivalently converted into a bilevel formulation over two sub-networks which have only two nodes in common, and one of which does not contain any supply-demand nodes, with the possible exception of the common nodes. The upper and lower level optimization problems, although both non-convex, are shown to have similar structure and lead to significant computational savings when solving the weight control problem using an exhaustive search method. Interestingly, the lower level problem can be interpreted as defining *equivalent capacities* of the underlying sub-network for a given *equivalent weight* of the same sub-network. While the latter is reminiscent of the notion of equivalent resistance from circuit theory, the former appears to be novel. While the equivalent capacities are expectedly dependent on the weight of the underlying network, a remarkable aspect of this definition is that this dependence can be expressed entirely in terms of the equivalent weight of the underlying sub-network.

The proposed bilevel formulation can be applied recursively in a nested fashion to yield a multilevel framework, where each iteration of bilevel formulation results in additional computational savings. Further computational savings are possible when the network is tree-reducible, *i.e.*, when it can be reduced to a tree by sequentially replacing series and parallel sub-networks with equivalent, in terms of weight and capacity, links. This is because series and parallel (meta-)networks are proven to admit an invariance of a certain strong quasi-concavity property from the equivalent capacity function of their constituent links to the equivalent capacity function of the network itself; and the strong quasi-concavity property of the equivalent capacity function is shown to facilitate its explicit computation.

We then study robustness properties of a couple of *natural* decentralized control policies. Under the first controller, weight on an overloaded link is decreased if its weight is greater than the lower limit of the operation range. Such a controller is proven to be maximally robust for parallel networks if the initial weight is no less than a solution to the

weight control problem. We then consider a second controller which augments the first controller by additionally increasing weight *altruistically* on an underloaded link if the flow on it is increasing and if its weight is less than the upper limit of the operation range. Such a controller is proven to be maximally robust for parallel networks with two links.

In summary, the paper makes several novel contributions. First, a novel robust control problem is formulated where the control strategy consists of changing link weights in response to possibly decentralized information about link flows, weights and disturbance. We then establish connection between the margin of robustness and cut capacities of associated flow network. Second, we provide an explicit expression for the flow-weight Jacobian. While being of independent interest, its utility is demonstrated in a projected gradient descent algorithm to solve the problem for multiplicative disturbances. Third, we identify a class of non-convex network optimization problems which can be equivalently formulated as bilevel problems, and identify conditions under which the robust control problem belongs to this class. The notion of equivalent capacity is introduced, which possibly of independent interest, is shown to correspond to the lower level problem, and is shown to possess a strong quasi-concavity property for series and parallel networks. The input-output invariance of this property for series and parallel networks allows efficient computation of equivalent capacity, and hence solution to the robust control problem, for tree-reducible networks. Fourth, we provide robustness guarantees for a couple of natural decentralized control policies for parallel networks. Illustrative simulations on an IEEE benchmark network are also provided.

The rest of the paper is organized as follows. Section II formally states the robust weight control problem, formulates an optimization problem for robust control design and margin of robustness computation for centralized control policies, and establishes connection with classical network flow problems. Section IV provides an explicit expression for the flow-weight Jacobian and a gradient descent algorithm that utilizes it. Section V describes a multi-level programming approach for solving the robust control problem for centralized control policies under multiplicative disturbances and introduces the definition of equivalent capacity function for a network. Section VI-B establishes input-output invariance of a strong quasi-concavity property for series and parallel network and utilizes it to efficiently solve the multilevel formulation of the robust control problem for tree reducible networks. Section VII provides robustness guarantees for a couple of natural decentralized weight control policies. Illustrative simulation results are provided in Section VIII. Concluding remarks and comments on directions for future research are provided in Section IX. A few technical lemmas are collected in the Appendix.

We conclude this section by defining a few key notations to be used throughout the paper.  $\mathbb{R}$ ,  $\mathbb{R}_{\geq 0}$ ,  $\mathbb{R}_{> 0}$ ,  $\mathbb{R}_{\leq 0}$  and  $\mathbb{R}_{< 0}$  will stand for real, non-negative real, strictly positive real, non-positive real, and strictly negative real, respectively, and  $\mathbb{N}$  denotes the set of natural numbers.  $\mathbf{0}$  and  $\mathbf{1}$  will denote the vector of all zeros and all ones, respectively, where the size of the vector will be clear from the context. Given two vectors  $a, b \in \mathbb{R}^n$ ,  $a \leq b$  (resp.,  $a < b$ ) would imply  $a_i \leq b_i$  (resp.,  $a_i < b_i$ ) for all  $i \in \{1, \dots, n\}$ . Given a vector  $a \in \mathbb{R}^n$ ,  $\mathbf{diag}(a)$  denotes a diagonal matrix, whose diagonal entries correspond to elements of  $a$ , and  $a_B$  denotes the sub-vector of  $a$  corresponding to the subset  $B \subset \{1, \dots, n\}$ . We refer the reader to standard textbooks on graph theory, e.g., [14], for a thorough overview of key concepts and definitions for graphs – we recall a few important ones here for

the sake of completeness. A directed multigraph is the pair  $(\mathcal{V}, \mathcal{E})$  of a finite set  $\mathcal{V}$  of nodes, and of a multiset  $\mathcal{E}$  of links consisting of ordered pairs of nodes (*i.e.*, we allow for parallel links between a pair of nodes). We adopt the convention that a directed multigraph does not contain a self-loop. A simple directed graph is a directed graph  $(\mathcal{V}, \mathcal{E})$  having no multiple edges or self-loops. A directed path in a digraph is a sequence of vertices in which there is a (directed) edge pointing from each vertex in the sequence to its successor in the sequence. A directed cycle is a directed path (with at least one edge) whose first and last vertices are the same. If  $i = (v_1, v_2) \in \mathcal{E}$  is a link, where  $v_1, v_2 \in \mathcal{V}$ , we shall write  $\sigma(i) = v_1$  and  $\tau(i) = v_2$  for its tail and head node, respectively. The sets of outgoing and incoming links of a node  $v \in \mathcal{V}$  will be denoted by  $\mathcal{E}_v^+ := \{i \in \mathcal{E} : \sigma(i) = v\}$  and  $\mathcal{E}_v^- := \{i \in \mathcal{E} : \tau(i) = v\}$  respectively. The **sign** function is defined as  $\text{sign}(x) = +1$  if  $x > 0$ ,  $= -1$  if  $x < 0$ , and  $= 0$  if  $x = 0$ . Given a map  $f : X \rightarrow Y$ ,  $\mathcal{R}(f)$  will denote the range of  $f$ . With slight abuse of notation, we will also use  $\mathcal{R}(A)$  to denote the range space of matrix  $A$ . A function  $f : X \rightarrow \mathbb{R}$  is quasiconvex if, for all  $x_1, x_2 \in X$  and  $\theta \in [0, 1]$ , we have  $f(\theta x_1 + (1 - \theta)x_2) \leq \max\{f(x_1), f(x_2)\}$ .  $f$  is quasiconcave if  $-f$  is quasiconvex.

## II. PROBLEM FORMULATION

In this section, we formulate the problem of robust weight control, and provide preliminary results. We start by reviewing the DC power flow model.

### A. DC Power Flow Model

In the DC power flow model, it is assumed that the transmission lines are lossless and the voltage magnitudes at nodes are constant at 1.0 unit. Power flow on links is bidirectional; however, it is convenient to model the graph topology of the power network by a *directed* multigraph  $\mathcal{G} = (\mathcal{V}, \mathcal{E})$ , where the directions assigned to the links are arbitrary. We make the following assumption on the graph topology throughout the paper.

**Assumption 1.**  $\mathcal{G}$  is weakly connected.

Assumption 1 is without loss of generality because the results of this paper can be applied to every connected component of  $\mathcal{G}$ . The graph topology is associated with a node-link incidence matrix  $A \in \{-1, 0, +1\}^{\mathcal{V} \times \mathcal{E}}$  that is consistent with the directions of links in  $\mathcal{E}$ , *i.e.*, for all  $v \in \mathcal{V}$  and  $i \in \mathcal{E}$ ,  $A_{vi}$  is equal to  $-1$  if  $v = \tau(i)$ , is equal to  $+1$  if  $v = \sigma(i)$ , and is equal to zero otherwise. The links are associated with a flow vector  $f \in \mathbb{R}^{\mathcal{E}}$ , and the nodes are associated with phase angles  $\phi \in \mathbb{R}^{\mathcal{V}}$  and a supply-demand vector  $p \in \mathbb{R}^{\mathcal{V}}$ . The sign of components of  $f$  are to be interpreted as being consistent with the directional convention chosen for links in  $\mathcal{E}$ . The direction of the flow on link  $i$  is in the same or opposite direction of link  $i$  for  $f_i > 0$  and  $f_i < 0$ , respectively. A component of  $p$  is positive (*resp.*, negative) if the corresponding node is associated with a generator (*resp.*, load). Throughout the paper, we shall assume that the supply-demand vector is *balanced*, *i.e.*,

**Assumption 2.**  $\mathbf{1}^T p = 0$ .

Assumptions 1 and 2 will be standing assumptions throughout the paper. We also associate with the network a vector  $w \in \mathbb{R}_{>0}^{\mathcal{E}}$  whose components give link susceptances. Hereafter, we shall refer to the susceptances as *weights* on the links. We let  $W = \mathbf{diag}(w) \in \mathbb{R}_{>0}^{\mathcal{E} \times \mathcal{E}}$  denote the matrix representation of  $w$ . We define the Laplacian of a network as follows.

**Definition 1.** *Given a network with directed multigraph  $\mathcal{G} = (\mathcal{V}, \mathcal{E})$  having node-link incidence matrix  $A \in \{-1, 0, +1\}^{\mathcal{V} \times \mathcal{E}}$  and weight matrix  $W \in \mathbb{R}_{>0}^{\mathcal{E} \times \mathcal{E}}$ , its weighted Laplacian matrix is defined as*

$$L_{\mathcal{G}}(W) := AWA^T.$$

For brevity in notation, we shall drop explicit dependence of  $L$  on  $W$  or  $\mathcal{G}$  when clear from the context.

**Remark 1.**

- (a) *While the Laplacian matrix is usually defined for networks with simple directed graphs, Definition 1 considers the general directed multigraph setting. Several distinct networks can have the same Laplacian – we elaborate on this in Section A in the Appendix.*
- (b) *The Laplacian of a network does not depend on the specific choice of directionality for links.*

In a DC power network, the quantities defined above are related by Kirchhoff's law and Ohm's law as follows:

$$\begin{aligned} Af &= p \\ f &= WA^T\phi \end{aligned} \tag{1}$$

The next result provides an explicit expression for  $f$  satisfying (1).

**Lemma 1.** *Consider a power network with directed multigraph  $\mathcal{G} = (\mathcal{V}, \mathcal{E})$  having node-link incidence matrix  $A \in \{-1, 0, +1\}^{\mathcal{V} \times \mathcal{E}}$ , line weights  $w \in \mathbb{R}_{>0}^{\mathcal{E}}$  and supply-demand vector  $p \in \mathbb{R}^{\mathcal{V}}$ . There exists a unique  $f \in \mathbb{R}^{\mathcal{E}}$  satisfying (1), and is given by:*

$$f = WA^T L^\dagger p =: f^{\mathcal{G}}(w, p) \tag{2}$$

where  $L^\dagger$  is the Moore-Penrose pseudo-inverse of  $L$ .

*Proof:* Substituting the second equation into the first in (1), we get  $L\phi = p$ . Note that  $L$  is positive semidefinite and has rank  $n - 1$ , and that the null space of  $L$  and  $L^\dagger$  is  $\text{span}\{\mathbf{1}\}$  [15]. Since  $p$  satisfies Assumption 2,  $p$  is in the range space of  $L$ , and hence the solution to  $L\phi = p$  is given by  $\phi = L^\dagger p + \bar{\phi}\mathbf{1}$ , where  $\bar{\phi}$  is an arbitrary scalar. Since  $A^T\mathbf{1} = 0$ , the flow solution is unique:  $f = WA^T\phi = WA^T L^\dagger p$ . ■

We shall drop explicit dependence of  $f$  on  $\mathcal{G}$ ,  $w$  or  $p$  when clear from the context.

**Remark 2.**

- (a) *In the proof of Lemma 1, the particular phase angle solution  $L_{\mathcal{G}}^\dagger p$  is the minimum norm solution and is orthogonal to  $\mathbf{1}$ , and the flow solution in (2) is the minimum weighted norm solution satisfying the flow conservation constraint, i.e., the first equation in (1) (see Section B in the Appendix for more details).*

(b) In [9], a result similar to (2) is provided as  $f = W\tilde{A}^T(\tilde{A}W\tilde{A}^T)^{-1}\tilde{p}$ , where  $\tilde{A}$  and  $\tilde{p}$  are one row reduced versions of  $A$  and  $p$ , respectively.

We are interested in *feasible* flows, *i.e.*, flows that satisfy the following lower and upper line capacity constraints

$$c^l \leq f \leq c^u \quad (3)$$

We call a network *feasible* if the flows on all its links are feasible. Throughout this paper, we make the following rather natural assumption on line capacities:

**Assumption 3.**  $c^l < \mathbf{0} < c^u$

The capacities  $c^l$  and  $c^u$  are typically symmetrical about  $\mathbf{0}$ . We adopt the following natural standing assumption throughout the paper.

**Assumption 4.** The initial flow  $f_0 = f(w_0, p_0)$  satisfies  $c^l \leq f_0 \leq c^u$ .

### B. Weight Control Policies and the Margin of Robustness

We are interested in quantifying disturbances on the supply-demand vector under which (3) continues to be satisfied, using  $w$  as control. Disturbances will be modeled by change in the supply-demand vector. We assume that the disturbance induces a one-shot change to the system (as opposed to being a process). Formally, under a disturbance, the supply-demand vector changes irreversibly, at time  $t = 0$ , from a nominal value  $p_0$  to a value  $p_\Delta = p_0 + \Delta$ , with  $\mathbf{1}^T \Delta = 0$ , and hence  $\mathbf{1}^T p_\Delta = 0$ . We emphasize that the disturbance happens only at  $t = 0$ , and is not a process. Such a balanced disturbance can be caused, *e.g.*, by removal of a link from the network. The network responds by changing the weights dynamically, which in turn also induces dynamics in the line flows due to (2). This dynamics can be written as:

$$\dot{w}_i(t) = u_i(\mathcal{W}(t), \mathcal{F}(t), \Delta) \quad (4)$$

where  $\mathcal{W}(t) = \{w(\kappa) : \kappa \in [0, t]\}$ , and  $\mathcal{F}(t) = \{f(w(\kappa)) : \kappa \in [0, t]\}$  are the historical values of line weights and flows, respectively, through time  $t$ . The weight control in (4) is required to satisfy the following constraints

$$\mathbf{0} \leq w^l \leq w \leq w^u \quad (5)$$

where  $w^l$  and  $w^u$  are the lower and upper limits, respectively, for the operation range of the weight controller. The dynamical system (4) will be called *feasible* under a given disturbance  $\Delta$  and control policy  $u$  if (3) is satisfied asymptotically. For a given network  $\mathcal{G} = (\mathcal{V}, \mathcal{E})$  with initial weight  $w_0 \in \mathbb{R}_{>0}^{\mathcal{E}}$ , link weight bounds  $w^l \in \mathbb{R}_{\geq 0}^{\mathcal{E}}$  and  $w^u \in \mathbb{R}_{>0}^{\mathcal{E}}$ , link capacity bounds  $c^l \in \mathbb{R}_{< 0}^{\mathcal{E}}$  and  $c^u \in \mathbb{R}_{> 0}^{\mathcal{E}}$ , and initial supply-demand vector  $p_0 \in \mathbb{R}^{\mathcal{V}}$ , the *margin of robustness* of a given control policy  $u$  is defined as

$$R(u, \mathcal{G}, w_0, w^l, w^u, c^l, c^u, p_0) := \sup\{\beta \geq 0 : (4) \text{ is feasible under } u \quad \forall \Delta \text{ s. t. } \|\Delta\|_1 \leq \beta\}. \quad (6)$$

The choice of the  $\ell_1$  norm in (6) is justified because we consider only balanced disturbances, and therefore  $\|\Delta\|_1$  is equal to twice the cumulative deviation in supply (or demand). The following example provides a simple illustration of the increase in margin of robustness when the line weights are controllable.

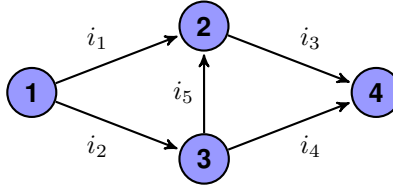

Fig. 1: Network used in Examples 1 and 2.

**Example 1.** Consider the network shown in Figure 1 with  $w^u = [1 \ 3 \ 1 \ 1 \ 1]^T$ ,  $w^l$  the same as  $w^u$ , except for  $w_2^l = 0$ ;  $c^u = -c^l = [1 \ 1 \ 1 \ 0.5 \ 1]^T$  and  $p_0 = [1 \ 0 \ 0 \ -1]^T$ . The flow corresponding to weight  $w^u$  and load  $p_0$  is  $f(w^u, p_0) = [0.33 \ 0.67 \ 0.44 \ 0.56 \ 0.11]^T$  which is infeasible due to the excessive flow on link  $e_4$ . However, the flow under the same load  $p_0$  but with weight  $w^l$  is  $f(w^l, p_0) = [1.00 \ 0 \ 0.67 \ 0.33 \ -0.33]^T$  which is feasible.

Choosing  $w_i = 0$  for some link  $i$ , e.g., for link 2 in Example 1, corresponds to disconnecting that link. Such *line tripping* strategies have been considered in the context of cascading failures [16]–[18].

Our objectives in this paper are: (i) to provide a framework for tractable computation of (approximations of)

$$R^*(\mathcal{U}, \mathcal{G}, w_0, w^l, w^u, c^l, c^u, p_0) := \sup_{u \in \mathcal{U}} R(u, \mathcal{G}, w_0, w^l, w^u, c^l, c^u, p_0) \quad (7)$$

for a given class  $\mathcal{U}$  of control policies, and (ii) to find  $u^* \in \mathcal{U}$  such that  $R(u^*, \mathcal{G}, w_0, w^l, w^u, c^l, c^u, p_0)$  is a close approximation of, if not equal to  $R^*(\mathcal{U}, \mathcal{G}, w_0, w^l, w^u, c^l, c^u, p_0)$ . We shall drop explicit dependence of  $R$  and  $R^*$  on,  $u$ ,  $\mathcal{U}$ ,  $\mathcal{G}$ ,  $w_0$ ,  $w^l$ ,  $w^u$ ,  $c^l$ ,  $c^u$ , or  $p_0$  when clear from the context.

In this paper, we specifically consider cases when  $\mathcal{U}$  is the set of centralized or *decentralized* control policies. The latter corresponds to control policies satisfying  $u_i(\mathcal{W}(t), \mathcal{F}(t), \Delta) \equiv u_i(\mathcal{W}_i(t), \mathcal{F}_i(t))$ , i.e., controller on link  $i$  has access to the historical values of weights and flows only on link  $i$ , and no information about disturbance.

### C. Upper Bound on the Margin of Robustness

It is easy to see that  $R^*(\mathcal{U})$  with  $\mathcal{U}$  being the set of centralized policies (that have access to information about disturbance  $\Delta$ ) serves as an upper bound to  $R^*(\mathcal{U})$  for any class of control policies, including decentralized control policies.

Under a centralized control policy, the new link weights  $w^*(\Delta)$  in response to disturbance  $\Delta$  are chosen instantaneously, i.e., there is no dynamics in  $w$ . The centralized policy then corresponds to setting  $w^*(\Delta)$  to be equal to any  $w \in \mathbb{R}_{\geq 0}^E$  satisfying:

$$\begin{aligned} c^l &\leq f(w, p_\Delta) \leq c^u \\ w^l &\leq w \leq w^u \end{aligned} \quad (8)$$



if (8) is feasible, and (arbitrarily) equal to  $w^u$  otherwise. Here,  $f(w, p_\Delta)$  is as given in (2). The margin of robustness of such a centralized policy can be easily seen to be equal to the solution of the following optimization problem:

$$\nu^*(\mathcal{G}, w^l, w^u, c^l, c^u, p_0) := \min_{\delta: \|\delta\|_1=1, \mathbf{1}^T \delta=0} \nu(\delta, \mathcal{G}, w^l, w^u, c^l, c^u, p_0) \quad (9)$$

where

$$\begin{aligned} \nu(\delta, \mathcal{G}, w^l, w^u, c^l, c^u, p_0) = & \max_{w \in \mathbb{R}_{\geq 0}^{\mathcal{E}}; \mu \geq 0} \mu \\ \text{subject to} & \quad c^l \leq f(w, p_0 + \mu\delta) \leq c^u \\ & \quad w^l \leq w \leq w^u \end{aligned} \quad (10)$$

For brevity, the explicit dependence of  $\nu(\delta, \mathcal{G}, w^l, w^u, c^l, c^u, p_0)$  and  $\nu^*(\mathcal{G}, w^l, w^u, c^l, c^u, p_0)$  on  $\mathcal{G}$ ,  $w^l$ ,  $w^u$ ,  $c^l$ ,  $c^u$  or  $p_0$  is dropped when clear from the context. Notice while a control policy and its margin of robustness may depend on the initial weight  $w_0$ , the upper bound, as defined in (9)-(10) does not. (9) differs from (8) only in parameterization of the set of disturbances in terms of disturbances on a unit  $\ell_1$ -ball and magnitude  $\nu$ . (10) only considers disturbances along the direction  $\delta$  and  $\nu(\delta, \mathcal{G})$  gives the maximal magnitude of such disturbances under which the system can be made feasible within the specified operation range on  $w$ . (9) then considers all possible directions of balanced disturbances and  $\nu^*(\mathcal{G})$  is an upper bound on every, including decentralized, control policies as we show next.

**Lemma 2.** *For a network with directed multigraph  $\mathcal{G} = (\mathcal{V}, \mathcal{E})$ , link weight bounds  $w^l \in \mathbb{R}_{\geq 0}^{\mathcal{E}}$  and  $w^u \in \mathbb{R}_{> 0}^{\mathcal{E}}$ , link capacity bounds  $c^l \in \mathbb{R}_{< 0}^{\mathcal{E}}$  and  $c^u \in \mathbb{R}_{> 0}^{\mathcal{E}}$ , and initial supply-demand vector  $p_0 \in \mathbb{R}^{\mathcal{V}}$ , there exists a  $\Delta \in \mathbb{R}^{\mathcal{V}}$  with  $\|\Delta\|_1$  arbitrarily greater than  $\nu^*(\mathcal{G})$  such that the system (4) is infeasible under every, including decentralized, control policy  $u$ .*

*Proof:* Let  $(\delta^*, \nu^*)$  correspond to an optimal solution of (9). It is easy to see that for  $(\delta^*, \nu^*(1 + \epsilon))$ ,  $\epsilon > 0$ , there is no feasible  $w$  in (9), and hence the system is infeasible under the perturbation  $\Delta = (1 + \epsilon)\nu^*\delta^*$  under any control policy  $u$ . Since this is true for every  $\epsilon > 0$ , this gives the lemma. ■

Lemma 2 implies that  $R^* \leq \nu^*$ , or equivalently,  $R(u) \leq \nu^*$  for all  $u$ . The next example shows that  $\|\Delta\|_1 > R^*$  is not sufficient for infeasibility.

**Example 2.** *Consider the network shown in Figure 1, with  $c^u = -c^l = 5.5 \mathbf{1}$ , and  $w^l = w^u = [1 \ 3 \ 3 \ 1 \ 1]^T = w$  (say). This implies that the only admissible control policy is the trivial  $u \equiv \mathbf{0}$ . The flow corresponding to load  $p_0 = [8 \ 0 \ 0 \ -8]^T$  is  $f(w, p_0) = [3.2 \ 4.8 \ 4.8 \ 3.2 \ 1.6]^T$  which is feasible. Consider two perturbations  $\Delta_1 = [1.5 \ -0.5 \ 0.5 \ -1.5]^T$  and  $\Delta_2 = [2 \ -2 \ 2 \ -2]^T$ . Note that  $\|\Delta_1\|_1 = 4 < 8 = \|\Delta_2\|_1$ . The flows under these perturbations are  $f(w, p_{\Delta_1}) = [3.95 \ 5.55 \ 5.55 \ 3.95 \ 2.1]^T$  and  $f(w, p_{\Delta_2}) = [4.6 \ 5.4 \ 5.4 \ 4.6 \ 2.8]^T$ . Since  $f(w, p_{\Delta_1})$  is infeasible,  $R^* \leq \|\Delta_1\|_1 = 4$ . However, the flow under  $\Delta_2$ , whose norm is greater than  $R^*$  is feasible. Note also that, element-wise,  $\Delta_1$  and  $\Delta_2$  have the same signs, and magnitude of  $\Delta_1$  is smaller than  $\Delta_2$ . In other words,  $\Delta_2$  dominates  $\Delta_1$  element-wise, and yet the system is feasible under  $\Delta_2$ , but not under  $\Delta_1$ . Such non-*

monotonicity is directly attributable to non-monotonicities of flow distribution with respect to the supply-demand vector in power networks.

### III. RELATIONSHIP BETWEEN MARGIN OF ROBUSTNESS AND MIN-CUT CAPACITY

In the weight control problem (9)-(10), the flexibility of controlling weight enables us to adjust the flow distribution over the networks to maximize the margin of robustness. This is similar to a classical network flow problem of choosing a feasible flow distribution to optimize a given cost function. In this section, we formally investigate the relationship between the weight control and the network flow problem. We show that, under appropriate conditions, the weight control problem (10) is equivalent to a network flow problem with the margin of robustness for a given disturbance being the objective function. We use this relationship to make connections between the margin of robustness of a given DC power network and the min cut capacity of a certain associated flow network. These results are reminiscent of our previous work in [19], [20] on robustness of transport networks.

We begin by exploring the relationship between feasible flow sets for network flow and weight controlled DC power networks.

#### A. Relationship between Feasible Flow Sets for Network Flow and Weight Controlled DC Power Network

The difference between a flow network and a DC power network is in their different physics: classical network flow has capacity and flow conservation constraints, whereas DC power networks have additional constraints in the form of Ohm's law. Let us define the set of *feasible flow* for flow networks,  $\mathcal{F}_1$ , and for weight controlled DC networks,  $\mathcal{F}_2$ , as follows <sup>1</sup>:

$$\begin{aligned}\mathcal{F}_1 &:= \{f \in \mathbb{R}^{\mathcal{E}} \mid Af = p, c^l \leq f \leq c^u\} \\ \mathcal{F}_2 &:= \{f \in \mathbb{R}^{\mathcal{E}} \mid \exists w \in [w^l, w^u], \phi \in \mathbb{R}^{\mathcal{V}}, \text{ s.t. } Af = p, c^l \leq f \leq c^u, f = wA^T\phi\}\end{aligned}$$

Since  $\mathcal{F}_2$  has additional constraints, it is straightforward to see that  $\mathcal{F}_2 \subseteq \mathcal{F}_1$ .

For a network with directed graph  $\mathcal{G} = (\mathcal{V}, \mathcal{E})$ , a cycle  $\mathcal{C}$ , is a subset of  $\mathcal{E}$  that forms a loop.  $\mathcal{C}$  consists of forward link set  $\mathcal{C}_F$  and backward link set  $\mathcal{C}_B$ , where the *forward links* and *backward links* are the links along clockwise and counter-clockwise direction of  $\mathcal{C}$ , respectively [21]. We say that a flow  $f \in \mathbb{R}^{\mathcal{E}}$  contains a *circulation* if there exists a cycle  $\mathcal{C}$  such that  $f_i > 0$  for all  $i \in \mathcal{C}_F$  and  $f_i < 0$  for all  $i \in \mathcal{C}_B$ . Let  $\mathcal{F}_0 := \{f \in \mathbb{R}^{\mathcal{E}} \mid f \text{ does not contain a circulation}\}$ . We then have the following relationship between  $\mathcal{F}_0$ ,  $\mathcal{F}_1$  and  $\mathcal{F}_2$ .

**Proposition 1.** For a network with undirected multigraph  $\mathcal{G} = (\mathcal{V}, \mathcal{E})$ , link weight bounds  $w^l \in \mathbb{R}_{\geq 0}^{\mathcal{E}}$  and  $w^u \in \mathbb{R}_{> 0}^{\mathcal{E}}$ , link capacity bounds  $c^l \in \mathbb{R}_{< 0}^{\mathcal{E}}$  and  $c^u \in \mathbb{R}_{> 0}^{\mathcal{E}}$ , and supply-demand vector  $p \in \mathbb{R}^{\mathcal{V}}$ ,

$$\mathcal{F}_2 \subseteq \mathcal{F}_1 \cap \mathcal{F}_0 \tag{11}$$

<sup>1</sup>In contrast to standard convention, we do not include non-negativity constraints in  $\mathcal{F}_1$  since the underlying graph is undirected. The non-negativity constraints can be imposed on the directed graph formed by a simple *extension*: for every undirected link in  $\mathcal{G}$ , there are two directed links in the extended directed graph.

Moreover,

- 1) if  $\mathcal{G}$  is a tree, then  $\mathcal{F}_1 = \mathcal{F}_2$
- 2) if  $w^l = 0$ , then  $\mathcal{F}_2 = \mathcal{F}_1 \cap \mathcal{F}_0$

*Proof:* Since  $\mathcal{F}_2 \subseteq \mathcal{F}_1$ , in order to prove (11), it is sufficient to prove that  $f \in \mathcal{F}_0$  for all  $f \in \mathcal{F}_2$ , i.e., a feasible flow for a DC network does not contain a circulation. This is proven by contradiction as follows. For a flow  $f \in \mathcal{F}_2$ , suppose there exists a circulation on a cycle  $\mathcal{C}$ . Applying Ohm's law on all the links in  $\mathcal{C}$ , we then get that  $f_i/w_i = \phi_{\sigma(i)} - \phi_{\tau(i)}$  for all  $i \in \mathcal{C}_F$ , and  $-f_i/w_i = \phi_{\sigma(i)} - \phi_{\tau(i)}$  for all  $i \in \mathcal{C}_B$ . Taking summation over all links in  $\mathcal{C}$ , we then get that

$$0 < \sum_{i \in \mathcal{C}_F} f_i/w_i - \sum_{i \in \mathcal{C}_B} f_i/w_i = \sum_{i \in \mathcal{C}_F} \phi_{\tau(i)} + \sum_{i \in \mathcal{C}_B} \phi_{\sigma(i)} - \sum_{i \in \mathcal{C}_F} \phi_{\sigma(i)} - \sum_{i \in \mathcal{C}_B} \phi_{\tau(i)} = 0.$$

where the inequality is due to the definition of circulation, and the last equality to zero is due to the definition of a cycle. This leads to a contradiction.

In order to prove (1), it is sufficient to prove that  $\mathcal{F}_1 \subseteq \mathcal{F}_2$ , i.e.,  $f \in \mathcal{F}_2$  for any  $f \in \mathcal{F}_1$  for a tree network. Pick arbitrary  $f \in \mathcal{F}_1$  and  $w \in [w^l, w^u]$ . It is sufficient to show that the constraint  $f = wA^T\phi$  is satisfied for some  $\phi \in \mathbb{R}^{\mathcal{V}}$ . Let  $\bar{A}$  be the subvector and submatrix of  $\phi$  and  $A$  respectively with the first row removed. Since  $\mathcal{G}$  is a tree,  $A$  has independent columns, and  $\bar{A}$  is full rank. Let  $\bar{\phi} := (\bar{A}^T)^{-1}w^{-1}f \in \mathbb{R}^{|\mathcal{V}|-1}$ . It is then easy to see that  $f = wA^T\phi$  is satisfied for  $\phi := [0 \ \bar{\phi}^T]^T$ .

In order to prove (1), it is sufficient to prove that  $\mathcal{F}_1 \cap \mathcal{F}_0 \subseteq \mathcal{F}_2$ . Pick arbitrary  $f \in \mathcal{F}_1 \cap \mathcal{F}_0$ . To prove  $f \in \mathcal{F}_2$  is to show there exist  $w \in [w^l, w^u]$  and  $\phi$  such that the constraint  $f = wA^T\phi$  is satisfied. We now construct such  $w$  and  $\phi$  as follows. Maintain the directions of links with positive flow and reverse the directions of links with negative flow. Since  $f \in \mathcal{F}_0$ , there is no directed cycle in the network with the new direction assigned. Hence, there exists a topological ordering of the nodes in  $\mathcal{V}$ . Pick a strictly decreasing sequence  $(\phi_1, \dots, \phi_{|\mathcal{V}|})$ , and assign it the nodes as per the topological ordering. Let  $\tilde{w}_i := f_i/(\phi_{\sigma(i)} - \phi_{\tau(i)}) > 0$  for all  $i \in \mathcal{E}$ . Finally, choose the link weights as:  $w = \eta\tilde{w}$ , where  $\eta = \min_{i \in \mathcal{E}} w_i^u/w_i > 0$ . ■

**Remark 3.** If the underlying undirected graph  $\mathcal{G}$  of a network is a tree, then the flow solution to (1) is uniquely determined by the flow conservation equation  $Af = p$  and hence changing weight  $w$  does not affect the value of  $f$ . Therefore, as we show in Section III-B, the weight control problem (10) of a such a network reduces to a network flow problem.

### B. Relating Margin of Robustness to Min-Cut Capacity

Proposition 1 implies that, for a network whose underlying graph is a tree, (9)-(10) is equivalent to:

$$\nu_0^* := \min_{\delta: \|\delta\|_1=1, \mathbf{1}^T\delta=0} \nu_0(\delta) \quad (12)$$

where

$$\begin{aligned} \nu_0(\delta) := & \max_{\mu \geq 0, f} \mu \\ \text{subject to} & Af = p_0 + \mu\delta \\ & c^l \leq f \leq c^u \end{aligned} \quad (13)$$

If the underlying graph is not a tree, a feasible flow  $f \in \mathcal{F}_1$  can contain circulations, i.e.,  $f \notin \mathcal{F}_0$ , and hence  $f \notin \mathcal{F}_2$  by Proposition 1. In this case, it is possible to eliminate circulations from  $f$  to obtain a  $\tilde{f} \in \mathcal{F}_1 \cap \mathcal{F}_0$  as follows. Set  $\tilde{f} = f$ . While  $\tilde{f}$  contains a circulation for some cycle  $\mathcal{C}$ , update  $\tilde{f} = \tilde{f} - \min_{i \in \mathcal{C}} \tilde{f}_i \mathbf{1}_{\mathcal{C}}$ , where  $\mathbf{1}_{\mathcal{C}}$  is a binary vector containing one for entries corresponding to  $\mathcal{C}$ , and zero otherwise. Moreover, it is easy to see that, if  $(\mu, f)$  is feasible for (13), then  $(\mu, \tilde{f})$  is also feasible. Proposition 1 implies that the flow obtained by removing circulation satisfies  $\tilde{f} \in \mathcal{F}_2$  if  $w^l = 0$ . Therefore, (9)-(10) is equivalent to (12)-(13) when  $w^l = 0$ .

In summary, if the underlying graph of a network is a tree or  $w^l = 0$ , then the nonconvex problem (9)-(10) is equivalent to (12)-(13), whose inner problem (13) is convex. Indeed, (13) is a classical network flow problem and can be solved efficiently for a given disturbance  $\delta$ . However, computational tractability of the minimax problem (12)-(13) is not readily apparent. The next result establishes a useful property of  $\nu_0(\delta)$ , which in turn will lead to an efficient solution methodology for (12)-(13).

**Lemma 3.** *For a network with directed multigraph  $\mathcal{G} = (\mathcal{V}, \mathcal{E})$ , link capacity bounds  $c^l \in \mathbb{R}_{<0}^{\mathcal{E}}$  and  $c^u \in \mathbb{R}_{>0}^{\mathcal{E}}$ , and initial supply-demand vector  $p_0 \in \mathbb{R}^{\mathcal{V}}$ ,  $\nu_0(\delta)$  defined in (13) is quasiconcave.*

*Proof:* Given arbitrary  $\delta_1$  and  $\delta_2$ , we show that  $\nu_0(\theta\delta_1 + (1-\theta)\delta_2) \geq \min\{\nu_0(\delta_1), \nu_0(\delta_2)\}$  for all  $\theta \in [0, 1]$ . Let  $u_1^* = \nu_0(\delta_1)$  and  $u_2^* = \nu_0(\delta_2)$ . Without loss of generality, assume  $u_1^* \leq u_2^*$  and we need to prove  $\nu_0(\theta\delta_1 + (1-\theta)\delta_2) \geq u_1^*$ . It is sufficient to show that  $u = u_1^*$  is feasible to (13) when  $\delta = \theta\delta_1 + (1-\theta)\delta_2$ .

When  $\delta = \theta\delta_1 + (1-\theta)\delta_2$ ,  $u = u_1^*$ , the equality constraint becomes

$$\begin{aligned} Af &= p_0 + u_1^*(\theta\delta_1 + (1-\theta)\delta_2) = \theta(p_0 + u_1^*\delta_1) + (1-\theta)(p_0 + u_1^*\delta_2) \\ &= \theta Af_1^* + (1-\theta)Af_2' \end{aligned}$$

where  $f_1^*$  and  $f_2'$  are some flow on the network under disturbed supply-demand vector  $p_0 + u_1^*\delta_1$  and  $p_0 + u_1^*\delta_2$ , respectively. By setting  $f = \theta f_1^* + (1-\theta)f_2'$ , the flow conservation constraint is satisfied. For feasibility of  $(\theta\delta_1 + (1-\theta)\delta_2, u_1^*)$ , what remains to be shown is that such  $f$  satisfies the capacity constraint. It is sufficient to show that there exist  $f_1^*$  and  $f_2'$  that are feasible.  $f_1^*$  can be selected as the optimal solution to (13) corresponding to  $u_1^*$  and hence feasible. In order to see that there exists feasible  $f_2'$ , note that the feasible set of (13) is a polyhedron,  $\nu = 0$ ,  $f = f_0$  and  $\nu = \nu_2^*$  and  $f = f_2^*$  are feasible, where  $f_2^*$  is the optimal flow solution corresponding to  $u_2^*$ , and  $u_1^* \leq u_2^*$  is convex combination of 0 and  $u_2^*$ . Therefore,  $\nu_0(\theta\delta_1 + (1-\theta)\delta_2, \mathcal{G}_t) \geq u_1^*$  and  $\nu_0(\delta)$  is quasiconcave. ■

**Lemma 4.** *Consider a network with directed multigraph  $\mathcal{G} = (\mathcal{V}, \mathcal{E})$ , link capacity bounds  $c^l \in \mathbb{R}_{<0}^{\mathcal{E}}$  and  $c^u \in \mathbb{R}_{>0}^{\mathcal{E}}$ , and initial supply-demand vector  $p_0 \in \mathbb{R}^{\mathcal{V}}$ . Then,  $\nu_0^*$  defined in (12) is equal to  $\min_{\delta \in \Delta_0} \nu_0(\delta)$ , where  $\Delta_0 := \{\delta \in \mathbb{R}^{\mathcal{V}} \mid \exists s, t \in \mathcal{V}, \delta_s = 1/2, \delta_t = -1/2, \delta_v = 0 \forall v \in \mathcal{V} \setminus \{s, t\}\}$ , and  $\nu_0(\delta)$  is as defined in (13).*

*Proof:* The feasible set  $\{\delta \in \mathbb{R}^{\mathcal{V}} \mid \|\delta\|_1 = 1, \mathbf{1}^T \delta = 0\}$  for (12) is a polytope. We now show that  $\{\delta \in \mathbb{R}^{\mathcal{V}} \mid \|\delta\|_1 = 1, \mathbf{1}^T \delta = 0\}$  is the convex hull of set  $\Delta_0$ . The result then follows by using Lemma 3, and Lemma 16 (in the Appendix).

Pick an arbitrary  $\delta \in \mathbb{R}^{\mathcal{V}}$  with  $\|\delta\|_1 = 1$  and  $\mathbf{1}^T \delta = 0$ . We now show that there exist  $\{\eta_k\}$  and  $\{\delta_k^0\}$  satisfying  $\eta_k \geq 0$  and  $\delta_k^0 \in \Delta_0$  for all  $k$ , and  $\sum_k \eta_k = \|\delta\|_1 = 1$ . Let  $\tilde{\delta} = \delta$ , and  $k = 1$ . While  $\tilde{\delta} \neq \mathbf{0}$ , do the following. Let  $\mathcal{V}^+ := \{v \mid \tilde{\delta}_v > 0\}$ ,  $\mathcal{V}^- := \{v \mid \tilde{\delta}_v < 0\}$ , and pick  $v^* \in \operatorname{argmin}_{v \in \mathcal{V}^+ \cup \mathcal{V}^-}$ , and let  $\eta_k := 2|\tilde{\delta}_{v^*}|$ . If  $v^* \in \mathcal{V}^+$ , then let  $\tilde{\delta}_{v^*} = \tilde{\delta}_{v^*} - \eta_k/2$ , pick arbitrary  $v' \in \mathcal{V}^-$ , and let  $\tilde{\delta}_{v'} = \tilde{\delta}_{v'} + \eta_k/2$ .  $\delta_k^0$  is then chosen such that  $\delta_{k,v^*}^0 = 1/2$ ,  $\delta_{k,v'}^0 = -1/2$ , and  $\delta_{k,v}^0 = 0$  for all  $v \in \mathcal{V} \setminus \{v^*, v'\}$ . One can similarly choose  $\delta_k^0$  when  $v^* \in \mathcal{V}^-$ . We then set  $k = k + 1$ , and repeat the process for selecting  $\delta_k^0$  and  $\eta_k$  while  $\tilde{\delta} \neq \mathbf{0}$ . ■

Lemma 4 implies that, in order to solve (12)-(13), it is sufficient to consider a finite number of disturbance directions  $\delta \in \Delta_0$ , each with only one positive and one negative component. Then a naive solution strategy to compute  $\nu^*$  for a network with tree topology or  $w^l = 0$  is to solve (13) for all the disturbance directions in  $\Delta_0$  and then take the minimum. However, by using the Max-Flow-Min-Cut theorem, *e.g.*, [22, Theorem 8.6], one can execute this step in a simpler way as we describe next. In order to do this, we first construct a flow network associated with the given network, where we recall the standing Assumption 4.

**Definition 2** (Associated Flow Network). *Consider a network with directed multigraph  $\mathcal{G} = (\mathcal{V}, \mathcal{E})$ , link weight bounds  $w^l \in \mathbb{R}_{\geq 0}^{\mathcal{E}}$  and  $w^u \in \mathbb{R}_{> 0}^{\mathcal{E}}$ , link capacity bounds  $c^l \in \mathbb{R}_{< 0}^{\mathcal{E}}$  and  $c^u \in \mathbb{R}_{> 0}^{\mathcal{E}}$ , initial supply-demand vector  $p_0 \in \mathbb{R}^{\mathcal{V}}$ , and initial weights  $w_0 \in [w^l, w^u]$ . Let  $f_0$  be the corresponding initial flow, as given by (2). The associated flow network  $(\mathcal{G}^{\text{fl}}, c^{\text{fl}})$  consists of a directed graph  $\mathcal{G}^{\text{fl}} = (\mathcal{V}, \mathcal{E}^{\text{fl}})$ , where  $\mathcal{E}^{\text{fl}}$  is the union of  $\mathcal{E}$  and as well as reversed versions of links in  $\mathcal{E}$ , and link capacities  $c^{\text{fl}}$  defined as  $c_i^{\text{fl}} := c_i^u - f_{0,i}$  if  $i \in \mathcal{E}$ , and  $c_i^{\text{fl}} := -c_i^l + f_{0,i}$  if  $i \in \mathcal{E}^{\text{fl}} \setminus \mathcal{E}$ . Assumption 4 imply that  $c^{\text{fl}} \geq 0$ .*

A *cut* in  $\mathcal{G}^{\text{fl}}$  is a partition of the node set  $\mathcal{V}$  into two nonempty subsets:  $\mathcal{V}_c$  and its complement  $\mathcal{V} \setminus \mathcal{V}_c$  [23]<sup>2</sup>. *Cut capacity* is a function  $C : 2^{\mathcal{V}} \setminus \{\emptyset \cup \mathcal{V}\} \times \mathbb{R}_{\geq 0}^{\mathcal{E}} \rightarrow \mathbb{R}_{\geq 0}$  over the cuts and flow capacities and defined as:

$$C(\mathcal{V}_c, c^{\text{fl}}) = \sum_{i: \sigma(i) \in \mathcal{V}_c, \tau(i) \notin \mathcal{V}_c} c_i^{\text{fl}}$$

The min-cut capacity  $C_{\min}(\mathcal{G}^{\text{fl}}, c^{\text{fl}})$  of  $\mathcal{G}^{\text{fl}}$  is the minimum cut capacity among all cuts in  $\mathcal{G}^{\text{fl}}$ , *i.e.*,  $C_{\min}(\mathcal{G}^{\text{fl}}, c^{\text{fl}}) = \min_{\emptyset \subsetneq \mathcal{V}_c \subsetneq \mathcal{V}} C(\mathcal{V}_c, c^{\text{fl}})$ . The next proposition relates the margin of robustness to the min-cut capacity of the associated flow network.

**Proposition 2.** *Consider a network with directed multigraph  $\mathcal{G} = (\mathcal{V}, \mathcal{E})$ , link weight bounds  $w^l \in \mathbb{R}_{\geq 0}^{\mathcal{E}}$  and  $w^u \in \mathbb{R}_{> 0}^{\mathcal{E}}$ , link capacity bounds  $c^l \in \mathbb{R}_{< 0}^{\mathcal{E}}$  and  $c^u \in \mathbb{R}_{> 0}^{\mathcal{E}}$ , initial supply-demand vector  $p_0 \in \mathbb{R}^{\mathcal{V}}$ , and initial link weights  $w_0 \in [w^l, w^u]$ . Then, its margin of robustness  $\nu^*(\mathcal{G})$  is upper bounded as  $\nu^*(\mathcal{G}) \leq 2C_{\min}(\mathcal{G}^{\text{fl}}, c^{\text{fl}})$ , where  $(\mathcal{G}^{\text{fl}}, c^{\text{fl}})$  is the associated flow network (cf. Definition 2). Moreover, if  $\mathcal{G}$  is a tree or  $w^l = 0$ , then  $\nu^*(\mathcal{G}) = 2C_{\min}(\mathcal{G}^{\text{fl}}, c^{\text{fl}})$ .*

<sup>2</sup> A cut is denoted as  $\mathcal{V}_c - \mathcal{V} \setminus \mathcal{V}_c$  cut. It is uniquely determined by and determines a node set  $\mathcal{V}_c$ . The partition is ordered in the sense that the cut  $\mathcal{V}_c - \mathcal{V} \setminus \mathcal{V}_c$  is distinct from the cut  $\mathcal{V} \setminus \mathcal{V}_c - \mathcal{V}_c$ .

In particular, if  $\mathcal{G}$  is a tree, then  $\nu^*(\mathcal{G}) = 2 \min_{i \in \mathcal{E}} \{f_{0,i} - c_i^l, c_i^u - f_{0,i}\}$ , where  $f_0$  is the initial flow, as given by (2).

*Proof:* We first prove the equality for the case when  $\mathcal{G}$  is a tree or  $w^l = 0$ . In this case,  $\nu^*(\mathcal{G}) = \nu_0^*$ , and hence it is equivalent to proving  $\nu_0^* = 2(\mathcal{G}^{\text{fl}}, c^{\text{fl}})$ . Following Lemma 4, for a given  $\delta \in \Delta_0$  with  $\delta_s = 1/2$ ,  $\delta_t = -1/2$  and  $\delta_v = 0$  for all  $v \in \mathcal{V} \setminus \{s, t\}$ , the Max-Flow-Min-Cut theorem, e.g. [22, Theorem 8.6], implies that  $\nu_0(\delta) = 2 \min_{\mathcal{V}_c: s \in \mathcal{V}_c, t \notin \mathcal{V}_c} C(\mathcal{V}_c, c^{\text{fl}})$ . Therefore,  $\nu_0^* = \min_{\delta \in \Delta_0} \nu_0(\delta) = 2 \min_{\emptyset \subsetneq \mathcal{V}_c \subsetneq \mathcal{V}} C(\mathcal{V}_c, c^{\text{fl}}) = 2C_{\min}(\mathcal{G}^{\text{fl}}, c^{\text{fl}})$ .

It is easy to see that  $\nu^*(\mathcal{G})$  is upper bounded by the margin of robustness for a network with the same attributes for  $(\mathcal{G}, w^u, c^l, c^u, p_0, w_0)$  and  $w^l = 0$  (since it expands the feasible set in (10)). We have already shown in the previous paragraph that the latter is equal to  $2C_{\min}(\mathcal{G}^{\text{fl}}, c^{\text{fl}})$ .

The exact expression of  $\nu^*(\mathcal{G})$  when  $\mathcal{G}$  is a tree follows from the fact that, in this case, each link separates the network, and hence  $C_{\min}(\mathcal{G}^{\text{fl}}, c^{\text{fl}}) = \min_{i \in \mathcal{E}^n} c_i^{\text{fl}}$ . ■

There exists an extensive literature on efficient computation of min-cut capacity, which can be used to provide upper bound or exact characterization of the margin of robustness under special cases, as per Proposition 2. However, computing the exact value of margin of robustness in the general case requires solution to the non-convex problem (9). In Sections IV and V, we propose methodologies to compute this margin for more general networks: we provide a projected gradient descent algorithm (Section IV-C) for multiplicative disturbances, and a multilevel programming approach (Section V) for nongenerative disturbances.

#### IV. THE MULTIPLICATIVE DISTURBANCE CASE

In this section, we restrict our attention to the class of disturbances that are multiplicative. Formally, we let the set of  $\delta$  over which the minimum is taken in (9) be  $\{p_0/\|p_0\|_1, -p_0/\|p_0\|_1\}$ . Let  $\nu_M^*$  denote the corresponding solution to (9) for such a restriction of  $\delta$ . For  $\delta = p_0/\|p_0\|_1$  and  $\delta = -p_0/\|p_0\|_1$ , the set of disturbed supply-demand vectors can be parameterized as  $(1 + \mu/\|p_0\|_1)p_0$  and  $(1 - \mu/\|p_0\|_1)p_0$ , respectively. Therefore, letting  $\alpha = 1 + \mu/\|p_0\|_1$  and  $\alpha = \mu/\|p_0\|_1 - 1$ , respectively, for these two cases, solution to (9) can be obtained from:

$$\begin{aligned} & \max_{w \in \mathbb{R}_{>0}^n; \alpha \geq 0} && \alpha \\ & \text{subject to} && c^l \leq \alpha f(w, p_0) \leq c^u \\ & && w^l \leq w \leq w^u \end{aligned} \tag{14}$$

and a counterpart of (14) where  $p_0$  is replaced with  $-p_0$  as follows. Let  $\alpha_+^*$  denote the optimal solution to (14), and let  $\alpha_-^*$  denote the optimal solution to the counterpart of (14) where  $p_0$  is replaced with  $-p_0$ . Then,  $\nu_M^*$  can be written as:

$$\nu_M^* = \|p_0\|_1 \min\{\alpha_+^* - 1, \alpha_-^* + 1\}. \tag{15}$$

The assumed feasibility of the pre-disturbance state of the network (cf. Assumption 4) implies that  $\alpha_+^* \geq 1$ , and hence (15) is well-defined.

**Remark 4.** When the flow capacities are symmetrical, i.e.,  $|c^l| = |c^u|$ , we have  $\alpha_+^* = \alpha_-^*$ , and (15) is reduced to  $\nu^* = \|p_0\|_1(\nu_+^* - 1)$ . For the general case of asymmetrical flow capacities,  $\alpha_+^* \neq \alpha_-^*$ . Small disturbances in the  $-p_0$  direction decrease the supply and demand and hence the link flows, and are therefore favorable. However, if  $\alpha_-^* < \alpha_+^* - 2$ , then (15) implies that the margin of robustness under disturbances in the  $-p_0$  direction is less than that under disturbances in the  $+p_0$  direction.

We now present a gradient descent algorithm as a solution methodology for (14) which is nonconvex in general. The descent direction depends on flow-weight Jacobian, which we discuss next. In particular, we provide an exact expression for the flow-weight Jacobian which could be of independent interest.

#### A. The Flow-weight Jacobian

Let  $J(w) = \left[ \frac{\partial f(w)}{\partial w} \right] \in \mathbb{R}^{\mathcal{E} \times \mathcal{E}}$  be the flow-weight Jacobian for the flow function  $f(w)$  in (2). We provide an explicit expression for  $J(w)$  in the next result, whose proof depends on [24, Theorem 4.3]. For the sake of completeness, we reproduce this result from [24] and also provide a concise proof in Appendix D.

**Proposition 3.** For a network with directed multigraph  $\mathcal{G} = (\mathcal{V}, \mathcal{E})$  with node-link incidence matrix  $A$ , link weights  $w \in \mathbb{R}_{>0}^{\mathcal{E}}$ , and supply-demand vector  $p \in \mathbb{R}^{\mathcal{V}}$ , the flow-weight Jacobian is given by:

$$J(w) = (I - WA^T L^\dagger A) \text{diag}(A^T L^\dagger p) \quad (16)$$

*Proof:* The Laplacian  $L(w) = AWA^T$  is Fréchet differentiable [25] with respect to  $w_i$  for all  $i \in \mathcal{E}$ . Indeed, the corresponding derivative is given by

$$\frac{\partial L}{\partial w_i} = \frac{\partial(AWA^T)}{\partial w_i} = a_i a_i^T \quad (17)$$

where  $a_i$  is the  $i$ -th column of matrix  $A$ . Since  $L(w)$  is a Laplacian, it has a constant rank  $= |\mathcal{V}| - 1$  for all  $w \in \mathbb{R}_{>0}^{\mathcal{E}}$ . Therefore, Theorem 3 in the Appendix implies that the derivative of  $L^\dagger$  is given by:

$$\frac{\partial L^\dagger}{\partial w_i} = -L^\dagger \frac{\partial L}{\partial w_i} L^\dagger + L^\dagger L^{\dagger T} \frac{\partial L^T}{\partial w_i} (I - LL^\dagger) + (I - L^\dagger L) \frac{\partial L^T}{\partial w_i} L^{\dagger T} L^\dagger \quad (18)$$

In order to simplify (18), using singular value decomposition, one can write  $LL^\dagger = L^\dagger L = UU^T$ , where  $U$  is a  $n \times (n - 1)$  orthogonal matrix, whose columns are all orthogonal to  $\mathbf{1}$ , where  $n = |\mathcal{V}|$ . Therefore,  $I - LL^\dagger$  and  $I - L^\dagger L$  are both projection matrices onto  $\mathbf{1}$ . That is,  $I - LL^\dagger = \mathbf{1}_{n \times n} / n = I - L^\dagger L$ , where  $\mathbf{1}_{n \times n}$  is a matrix all of whose entries are one. Therefore, using (17), and noting that  $a_i^T \mathbf{1} = 0$ ,

$$\frac{\partial L^T}{\partial w_i} (I - LL^\dagger) = a_i a_i^T \frac{\mathbf{1}_{n \times n}}{n} = 0 = (I - L^\dagger L) \frac{\partial L^T}{\partial w_i} \quad (19)$$

Substituting (17) and (19) in (18), we get that

$$\frac{\partial L^\dagger}{\partial w_i} = -L^\dagger \frac{\partial L}{\partial w_i} L^\dagger = -L^\dagger a_i a_i^T L^\dagger \quad (20)$$

Therefore, the  $i$ -th column of the Jacobian is:

$$\begin{aligned} J_i(w) &= \frac{\partial f(w)}{\partial w_i} = \frac{\partial W}{\partial w_i} A^T L^\dagger p + W A^T \frac{\partial L^\dagger}{\partial w_i} p \\ &= a_i^T L^\dagger p e_i - W A^T L^\dagger a_i a_i^T L^\dagger p \end{aligned} \quad (21)$$

where  $e_i$  is the vector whose  $i$ -th component is equal to one, and all other entries are zero. When written in matrix form, (21) gives (16). ■

**Remark 5.**

(a) The expression for the  $i$ -th column of Jacobian, as given in (21), has the following useful interpretation.

Substituting  $a_i^T L^\dagger p = f_i/w_i$  in (21), we get that

$$J_i(w) = \frac{f_i}{w_i} e_i - W A^T L^\dagger \frac{f_i}{w_i} a_i \quad (22)$$

Recall that the entries of the column  $J_i(w)$  give the sensitivities of flows on various links with respect to change in weight on link  $i$ . The first term on the right hand side of (22) is non-zero only when computing sensitivity of flow on link  $i$  with respect to changes in  $w_i$ , and hence is local in nature. The non-locality in the sensitivity comes from the second term, which is equal to the flow distribution in the network corresponding to power injection of magnitude  $f_i/w_i$  at the tail node  $\sigma(i)$ , and power withdrawal of the same magnitude from the head node  $\tau(i)$ .

(b) Using (22), one can show that

$$\begin{aligned} Jw &= \sum_{i \in \mathcal{E}} w_i J_i(w) = \sum_{i \in \mathcal{E}} f_i (e_i - W A^T L^\dagger a_i) = f - W A^T L^\dagger A f \\ &= f - W A^T L^\dagger p = 0 \end{aligned}$$

where the fourth and fifth equalities follow from (1) and (2) respectively. Since  $i$ -th row of  $J$  is the gradient of  $f_i(w)$ , this implies that the gradient of  $f_i(w)$ ,  $i \in \mathcal{E}$ , is orthogonal to the radial direction  $w$ . In other words, the link flows are invariant under uniform scaling of the link weights.

Computing sensitivity of link flows with respect to link weights, via (16), requires considerable computation, especially for large networks. However, some entries of the Jacobian in (16) exhibit sign-definiteness, as stated in the next result.

**Proposition 4.** For a network with directed multigraph  $\mathcal{G} = (\mathcal{V}, \mathcal{E})$ , weights  $w \in \mathbb{R}_{>0}^{\mathcal{E}}$ , and supply-demand vector  $p \in \mathbb{R}^{\mathcal{V}}$ , the flow-weight Jacobian in (16) satisfies the following for all  $i \in \mathcal{E}$ :  $\mathbf{sign}(J_{ki}(w)) \in \mathbf{sign}(f_i) \cup \{0\}$  for all  $k \in \{i\} \cup \mathcal{E}_{\sigma(i)}^- \cup \mathcal{E}_{\tau(i)}^+$  and  $\mathbf{sign}(J_{ki}(w)) \in -\mathbf{sign}(f_i) \cup \{0\}$  for all  $k \in \{\mathcal{E}_{\sigma(i)}^+ \cup \mathcal{E}_{\tau(i)}^-\} \setminus \{i\}$ .

*Proof:* We provide proof for the case when  $f_i > 0$ ; the case when  $f_i \leq 0$  follows along similar lines. (22) implies that

$$J_{ii}w_i = f_i - f_i w_i a_i^T L^\dagger a_i, \quad J_{ki}w_i = -f_i w_k a_k^T L^\dagger a_i \quad (23)$$

for all  $k \neq i$  characterized in the lemma.



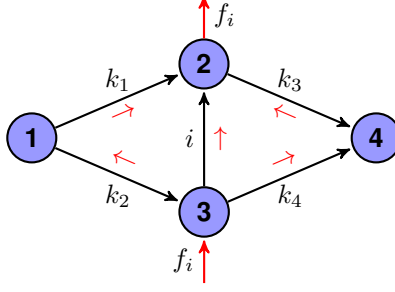

Fig. 2: Illustration of signs of  $\partial f/\partial w_i$ : red arrows alongside each link denote the flow direction on the corresponding link under the supply-demand vector  $f_i a_i$ ; for every link  $\neq i$ , if the red arrow alongside a link aligns with the link direction, then the corresponding component of  $\partial f/\partial w_i$  is negative, and positive otherwise. Correspondingly,  $\partial f_{k_1}/\partial w_i > 0$ ,  $\partial f_{k_4}/\partial w_i < 0$ ,  $\partial f_{k_2}/\partial w_i > 0$ ,  $\partial f_{k_3}/\partial w_i > 0$ . We always have  $\partial f_i/\partial w_i > 0$ .

Recalling Remark 5 (a) that  $f_i w_k a_k^T L^\dagger a_i$  can be interpreted as the flow on link  $k$  under supply-demand vector  $f_i a_i$ , for which  $\sigma(i)$  (node 3 in Fig. 2) and  $\tau(i)$  (node 2 in Fig. 2) are the only supply and demand nodes. It is easy to see that when a network has only one supply node and only one load node, then the phase angles at the supply and the load nodes are largest and smallest, respectively, among phase angles associated with all the nodes. This implies that for all  $k \in \mathcal{E}_{\sigma(i)}^-$  (link  $k_2$  in Fig. 2) and  $k \in \mathcal{E}_{\tau(i)}^+$  (link  $k_3$  in Fig. 2), *i.e.*, links incoming to  $\sigma(i)$  and outgoing from  $\tau(i)$ , the phase angle difference along the direction of such links, *i.e.*,  $a_k^T L^\dagger f_i a_i$ , and hence  $w_k a_k^T L_G^\dagger f_i a_i$  is non-positive, and therefore (23) implies that  $J_{ki} w_i$ , and hence  $J_{ki}$ , for such links is non-negative. Similarly, one can show that for all  $k \in \mathcal{E}_{\sigma(i)}^+ \setminus \{i\}$  (link  $k_4$  in Fig. 2) and  $k \in \mathcal{E}_{\tau(i)}^- \setminus \{i\}$  (link  $k_1$  in Fig. 2), *i.e.*, links outgoing from  $\sigma(i)$  and incoming to  $\tau(i)$ ,  $J_{ki}$  is non-positive.

Recalling again that  $f_i w_j a_j^T L_G^\dagger a_i$  is the flow on link  $j$  under supply-demand vector  $f_i a_i$ , flow conservation at node  $\sigma(i)$  can be written as

$$f_i + \sum_{j \in \mathcal{E}_{\sigma(i)}^-} f_i w_j a_j^T L_G^\dagger a_i = f_i w_i a_i^T L_G^\dagger a_i + \sum_{j \in \mathcal{E}_{\sigma(i)}^+ \setminus \{i\}} f_i w_j a_j^T L_G^\dagger a_i$$

The discussion in the second paragraph of this proof implies that terms inside the summation in left and right hand side are non-positive and non-negative respectively, implying that  $f_i - f_i w_i a_i^T L_G^\dagger a_i$  is non-negative. Therefore, (23) implies that  $J_{ii} \geq 0$ . ■

### Remark 6.

- (a) For a given choice of directionality of links in  $\mathcal{E}$ , Proposition 4 implies that, if  $f_i \geq 0$ , then an infinitesimal increase in the weight of link  $i$  will not decrease flow on link  $i$  or on links incoming to the tail node of  $i$  or outgoing from the head node of  $i$ , and it will not increase flow on links outgoing from tail node of  $i$  or incoming to head node of  $i$ . The conclusions are opposite when  $f_i \leq 0$ . We emphasize that these changes in flows are not in terms of absolute values, *e.g.*, a change of  $f_j$  from  $-3$  to  $-2$  is an increase in  $f_j$ .

- (b) Proposition 4 can be interpreted as generalization of existing results, e.g., see [12], that study the effect of removal of a link on flows in neighboring links. We elaborate on this point further in Section IV-B.
- (c) From a weight control perspective, Proposition 4 implies that the direction of change in link flows on neighboring links due to change in weight in link  $i$  can be computed in a completely decentralized fashion, which maybe be useful to develop a decentralized weight control heuristic. However, partly because this decentralized computation can be done only for immediately neighboring links, and partly because directions of change in link flow on a given link due to weight changes of other links are not necessarily aligned, such a heuristic can not be expected to be optimal in general.

### B. A Multigraph Perspective for the Flow-weight Jacobian

Definition 10 in Appendix A describes the notion of a reduced simple digraph corresponding to a multigraph, which allows us to see how distinct networks can have the same Laplacian. We now introduce a one-link extension of a given (possibly multi-) graph to facilitate alternate derivation of the expression of the Jacobian  $J(w)$  in Proposition 3. Such a construct will also help us to generalize the notion of the flow-weight Jacobian by allowing to study the change in link flows due to non-infinitesimal changes in weights, e.g., caused by addition or removal of links.

Given a graph  $\mathcal{G} = (\mathcal{V}, \mathcal{E})$  with link weights  $w \in \mathbb{R}_{>0}^{\mathcal{E}}$ , its one-link extension corresponding to link  $i \in \mathcal{E}$  and  $\Delta w_i \in [0, w_i]$ , denoted as  $\mathcal{G}^{\text{ex}}(w_i - \Delta w_i, \Delta w_i)$ , is obtained from  $\mathcal{G}$  by replacing link  $i$  with two parallel links with weights  $w_i - \Delta w_i$  and  $\Delta w_i$  (see Figure 3 for an illustration). In order to emphasize the dependence on link  $i$  and its weight  $w_i$ , we denote the original graph as  $\mathcal{G}(w_i)$ . Clearly,  $\mathcal{G}(w_i - \Delta w_i) = \mathcal{G}^{\text{ex}}(w_i - \Delta w_i, 0)$ , and  $\mathcal{G}(w_i)$  and  $\mathcal{G}^{\text{ex}}(w_i - \Delta w_i, 0)$  both have the same reduced simple graph (cf. Definition 10). Therefore, using Lemma 13 in Appendix A, we have that

$$L_{\mathcal{G}(w_i - \Delta w_i)} = L_{\mathcal{G}^{\text{ex}}(w_i - \Delta w_i, 0)}, \quad L_{\mathcal{G}(w_i)} = L_{\mathcal{G}^{\text{ex}}(w_i - \Delta w_i, \Delta w_i)} \quad (24)$$

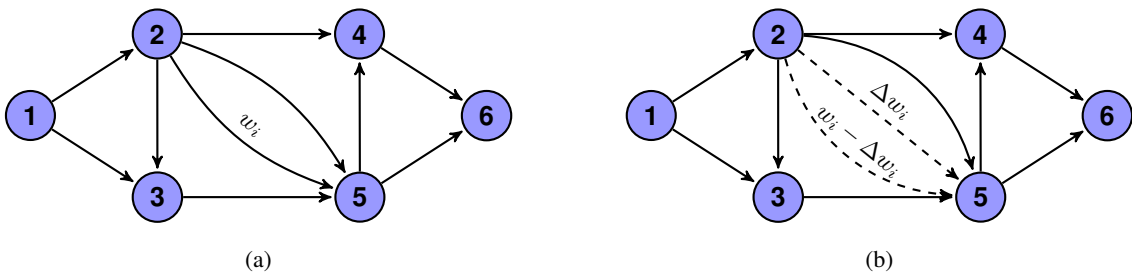

Fig. 3: Illustration of one-link extension of a graph. (a) A graph  $\mathcal{G}(w_i)$  with weight  $w_i$  on lower link (2, 5). (b) The one-link extension  $\mathcal{G}^{\text{ex}}(w_i - \Delta w_i, \Delta w_i)$  of  $\mathcal{G}(w_i)$  corresponding to the lower link (2, 5).

Since  $\mathcal{G}^{\text{ex}}(w_i - \Delta w_i, 0)$  is obtained from  $\mathcal{G}^{\text{ex}}(w_i - \Delta w_i, \Delta w_i)$  by removing the link with weight  $\Delta w_i$ , [26,

Lemma 2] implies that

$$L_{\mathcal{G}^{\text{ex}}(w_i - \Delta w_i, 0)}^\dagger - L_{\mathcal{G}^{\text{ex}}(w_i - \Delta w_i, \Delta w_i)}^\dagger = \frac{\Delta w_i}{1 - \theta_i} L_{\mathcal{G}^{\text{ex}}(w_i - \Delta w_i, \Delta w_i)}^\dagger a_i a_i^\top L_{\mathcal{G}^{\text{ex}}(w_i - \Delta w_i, \Delta w_i)}^\dagger \quad (25)$$

where  $\theta_i := \Delta w_i a_i^\top L_{\mathcal{G}^{\text{ex}}(w_i - \Delta w_i, \Delta w_i)}^\dagger a_i$ . Combining (24) and (25), and rearranging, we get that

$$\frac{1}{\Delta w_i} \left( L_{\mathcal{G}(w_i)}^\dagger - L_{\mathcal{G}(w_i - \Delta w_i)}^\dagger \right) = -\frac{1}{1 - \theta_i} L_{\mathcal{G}(w_i)}^\dagger a_i a_i^\top L_{\mathcal{G}(w_i)}^\dagger$$

Therefore, noting that  $\theta_i \rightarrow 0^+$  as  $\Delta w_i \rightarrow 0^+$ , we have

$$\lim_{\Delta w_i \rightarrow 0^+} \frac{1}{\Delta w_i} \left( L_{\mathcal{G}(w_i)}^\dagger - L_{\mathcal{G}(w_i - \Delta w_i)}^\dagger \right) = -L_{\mathcal{G}(w_i)}^\dagger a_i a_i^\top L_{\mathcal{G}(w_i)}^\dagger$$

One can similarly show that the right hand side derivative is the same, thereby giving (20).

While the above discussion illustrates the utility of a multigraph perspective to find out sensitivity of link flows with respect to link weights, the same perspective can also be used to compute change in link flows due to non-infinitesimal change in the link weights. First note that the change in link flows due to decrease in link weights by  $\Delta w_i > 0$  can be computed using (21) as  $\Delta f = \int_{w_i}^{w_i - \Delta w_i} J_i(\kappa) d\kappa$ . However, due to the dependence of  $J(w)$  on the pseudo-inverse of  $L$ , it is not possible to get an explicit expression for this integral in general. Alternately, the multigraph perspective implies that  $\Delta f$  is equal to the difference in link flows between  $\mathcal{G}^{\text{ex}}(w_i - \Delta w_i, \Delta w_i)$  and  $\mathcal{G}^{\text{ex}}(w_i - \Delta w_i, 0)$ . The latter corresponds to change in link flows due to removal of the link with weight  $\Delta w_i$  in  $\mathcal{G}^{\text{ex}}(w_i - \Delta w_i, \Delta w_i)$ . Therefore, (2) and (25) imply that

$$\Delta f = \frac{\Delta w_i a_i^\top L_{\mathcal{G}(w_i)}^\dagger p}{1 - \theta_i} W A_{\mathcal{G}(w_i)} L_{\mathcal{G}(w_i)}^\dagger a_i$$

The above equation can also be obtained by using the sensitivity factor of changes in phase angles to flows on removed links in [27].

### C. A Projected Sub-gradient Algorithm

We now utilize the flow-weight Jacobian derived in Section IV-A to design a projected sub-gradient algorithm for solving (14). In order to re-write (14) and its counter part for  $-p_0$  succinctly, we consider the following notion of *effective* line capacity. Given flow  $f$ , for all  $i \in \mathcal{E}$ :

$$c_i := \begin{cases} c_i^u & \text{if } f_i \geq 0 \\ c_i^l & \text{if } f_i < 0 \end{cases} \quad \text{for } \delta = \frac{p_0}{\|p_0\|_1}; \quad c_i := \begin{cases} -c_i^l & \text{if } f_i \geq 0 \\ -c_i^u & \text{if } f_i < 0 \end{cases} \quad \text{for } \delta = -\frac{p_0}{\|p_0\|_1}. \quad (26)$$

(14) can then be equivalently written as:

$$\begin{aligned} & \underset{w \in \mathbb{R}_{\geq 0}^{\mathcal{E}}}{\text{minimize}} && \max_{i \in \mathcal{E}} \frac{f_i(w)}{c_i} \\ & \text{subject to} && w^l \leq w \leq w^u \end{aligned} \quad (27)$$

Let  $\ell(w) := \text{argmax}_{i \in \mathcal{E}} f_i(w)/c_i$  be the links corresponding to the maximum value of  $f_i(w)/c_i$ . A projected sub-gradient method, along the lines of [28, Section 2.1.2], for solving (27) is then given by:

$$w(t+1) = \underset{w^l \leq w \leq w^u}{\text{argmin}} \left( \max_{i \in \ell(w(t))} \frac{J_i(w(t)) \cdot (w - w(t))}{c_i} + \frac{1}{2\eta_t} (w - w(t))^\top (w - w(t)) \right) \quad (28)$$

where  $\eta_t > 0$  is the step-size. (28) gives an unweighted version of projected gradient iteration – it can be generalized by incorporating an appropriate positive definite weighting matrix into the regularization term, e.g., see [28, Section 2.1.2].

Convergence analysis for projected sub-gradient algorithms for convex optimization problems is a well-studied topic, e.g., see [29]. However, extensions to non-convex problems, as is the case with (14), is still an ongoing work. We report supporting numerical evidence for the convergence of the proposed algorithm in (28) in Section VIII, and postpone formal analysis to future work.

## V. THE NONGENERATIVE DISTURBANCE CASE: A MULTILEVEL PROGRAMMING APPROACH

In Section IV, we presented results for multiplicative disturbances. In this section, we consider a more general setting of *nongenerative disturbances*, defined next.

**Definition 3.** For a network with directed multigraph  $\mathcal{G} = (\mathcal{V}, \mathcal{E})$  and supply-demand vector  $p \in \mathbb{R}^{\mathcal{V}}$ , a balanced disturbance  $\Delta \in \mathbb{R}^{\mathcal{V}}$  is called *nongenerative with respect to  $p$*  if  $p_v = 0$  implies  $\Delta_v = 0$  for all  $v \in \mathcal{V}$ .

Let the set of all nongenerative disturbances with respect to  $p \in \mathbb{R}^{\mathcal{V}}$  be denoted as  $\Delta_{NG}(p) \subset \mathbb{R}^{\mathcal{V}}$ . The projected sub-gradient algorithm formulated in Section IV-C, besides being restricted to multiplicative disturbances, can not guarantee an optimal solution because of the non-convexity of (14). In addition to expanding the set of admissible disturbances, in this section, we also develop a solution methodology with favorable computational properties. The computational complexity of exhaustive search methods for solving (9)-(10) and (14) grows exponential in the number of links. In this section, we introduce novel notions of network reduction, which when applied to reducible networks (cf. Definition 4) gives a multi-level formulation of (9)-(10). While the optimization problem at each level is still non-convex, the resulting decomposition of the original monolithic problem in (9)-(10) yields computational savings when using exhaustive search for finding solution.

We start by identifying a sufficient condition under which a certain class of optimization problems admit an equivalent bilevel formulation.

### A. An Equivalent Bilevel Formulation

Given continuous maps  $q_i : \mathbb{R}^n \rightarrow \mathbb{R}$ ,  $i \in \{1, \dots, m\}$ , a generic feasibility problem can be written as:

$$\text{Find } x \in D \subset \mathbb{R}^n \text{ s.t. } q_i(x) \leq 0, \quad \forall i \in \{1, \dots, m\} \quad (29)$$

where  $D$  is the domain of  $n$ -dimensional variable  $x$ .

We are interested in  $(q_1, \dots, q_m)$  for which there exist partitions<sup>3</sup>  $\{\mathcal{I}_1, \mathcal{I}_2\}$  and  $\{\mathcal{J}_1, \mathcal{J}_2\}$  of  $\{1, \dots, n\}$  and  $\{1, \dots, m\}$ , respectively, and continuous maps  $h_1 : D^{\mathcal{I}_1} \times \mathbb{R} \rightarrow \mathbb{R}$  and  $h_2 : D^{\mathcal{I}_2} \rightarrow \mathbb{R}$ , such that (29) is equivalent

<sup>3</sup>That is,  $\mathcal{I}_1 \cup \mathcal{I}_2 = \{1, 2, \dots, n\}$ ,  $\mathcal{I}_1 \cap \mathcal{I}_2 = \emptyset$ ,  $\mathcal{J}_1 \cup \mathcal{J}_2 = \{1, 2, \dots, m\}$  and  $\mathcal{J}_1 \cap \mathcal{J}_2 = \emptyset$ .

to finding  $(x_{\mathcal{I}_1}, x_{\mathcal{I}_2}, y_1, y_2) \in D^{\mathcal{I}_1} \times D^{\mathcal{I}_2} \times \mathbb{R} \times \mathbb{R}$  satisfying:

$$\begin{aligned} q_i(x_{\mathcal{I}_1}, y_2) &\leq 0, \quad \forall i \in \mathcal{J}_1 \\ q_i(x_{\mathcal{I}_2}, y_1) &\leq 0, \quad \forall i \in \mathcal{J}_2 \\ y_1 &= h_1(x_{\mathcal{I}_1}, y_2) \\ y_2 &= h_2(x_{\mathcal{I}_2}) \end{aligned} \tag{30}$$

In (30),  $x_{\mathcal{I}_1}$ ,  $x_{\mathcal{I}_2}$  and  $D^{\mathcal{I}_1}$ ,  $D^{\mathcal{I}_2}$  denote subvectors and domains of  $x$  corresponding to indices in  $\mathcal{I}_1$  and  $\mathcal{I}_2$ , respectively. The next result gives an equivalent bilevel formulation of (30).

**Proposition 5.** *Let  $q_i$ ,  $i \in \{1, \dots, m\}$ ,  $h_1$  and  $h_2$  be continuous functions. Then, the following are true:*

(a) *there exists a  $(x_{\mathcal{I}_1}, x_{\mathcal{I}_2}, y_1, y_2) \in D^{\mathcal{I}_1} \times D^{\mathcal{I}_2} \times \mathbb{R} \times \mathbb{R}$  satisfying (30) if and only if there exists a  $(x_{\mathcal{I}_1}, y_2) \in D^{\mathcal{I}_1} \times D_2$  satisfying the following:*

$$\begin{aligned} q_i(x_{\mathcal{I}_1}, y_2) &\leq 0 \quad \forall i \in \mathcal{J}_1 \quad \text{where} \quad G(y_2) := \{z \in \mathbb{R} \mid q_i(x_{\mathcal{I}_2}, z) \leq 0 \quad \forall i \in \mathcal{J}_2 \\ h_1(x_{\mathcal{I}_1}, y_2) &\in G(y_2) \quad \text{for some } x_{\mathcal{I}_2} \in D^{\mathcal{I}_2} \text{ satisfying } h_2(x_{\mathcal{I}_2}) = y_2 \} \end{aligned} \tag{31}$$

and  $D_2 = \mathcal{R}(h_2)$  is the domain of  $y_2$ . Moreover, for every  $y_2 \in D_2$ , the set  $G(y_2)$  is closed.

(b) *the set  $G(y_2)$  is convex for all  $y_2 \in D_2$  if*

- *for all  $x_{\mathcal{I}_2} \in D^{\mathcal{I}_2}$  and  $i \in \mathcal{J}_2$ ,  $q_i(x_{\mathcal{I}_2}, z)$  is quasiconvex with respect to  $z$ ; and*
- *there exists a  $z_0 \in \mathbb{R}$  such that  $q_i(x_{\mathcal{I}_2}, z_0) \leq 0$  for all  $x_{\mathcal{I}_2} \in D^{\mathcal{I}_2}$  and  $i \in \mathcal{J}_2$ .*

*Proof:*

(a) We refer to the feasibility problem on the left side of (31) as (31)-L.

Consider a  $(\tilde{x}_{\mathcal{I}_1}, \tilde{x}_{\mathcal{I}_2}, \tilde{y}_1, \tilde{y}_2)$  which satisfies (30). This implies that the first equation in (31)-L is satisfied by  $(\tilde{x}_{\mathcal{I}_1}, \tilde{y}_2)$ , and that  $z = \tilde{y}_1 = h_1(\tilde{x}_{\mathcal{I}_1}, \tilde{y}_2) \in G(\tilde{y}_2)$  with  $x_{\mathcal{I}_2} = \tilde{x}_{\mathcal{I}_2}$ .

Now consider a  $(\hat{x}_{\mathcal{I}_1}, \hat{y}_2)$  which satisfies (31)-L. Therefore,  $(\hat{x}_{\mathcal{I}_1}, \hat{y}_2)$  readily satisfies the first inequality in (30). Let  $\hat{y}_1 := h_1(\hat{x}_{\mathcal{I}_1}, \hat{y}_2)$ , then  $\hat{y}_1 \in G(\hat{y}_2)$ . Therefore,  $G(\hat{y}_2)$  is not empty and there exists at least one  $\hat{x}_{\mathcal{I}_2}$  such that  $h_2(\hat{x}_{\mathcal{I}_2}) = \hat{y}_2$  and  $q_i(\hat{x}_{\mathcal{I}_2}, \hat{y}_1) \leq 0$  for all  $i \in \mathcal{J}_2$ . That is to say,  $(\hat{x}_{\mathcal{I}_1}, \hat{x}_{\mathcal{I}_2}, \hat{y}_1, \hat{y}_2)$  satisfies (30).

Now we show that  $G(y_2)$  is a closed set for every  $y_2 \in D_2$ . Pick an arbitrary convergent sequence  $\{z_r\}$  in the set  $G(y_2)$ . It is sufficient to prove that  $z^* = \lim_{r \rightarrow +\infty} z_r \in G(y_2)$ . Suppose  $z^* \notin G(y_2)$ , then  $\exists k \in \mathcal{J}_2$  s.t.  $q_k(x, z^*) > 0, \forall x \in D^{\mathcal{I}_2}$  satisfying  $h_2(x) = y_2$ . Continuity of  $q_k$  then implies that  $q_k(x, z_r) > 0$ , and hence implying  $z_r \notin G(y_2)$ , for all sufficiently large  $r$ . This leads to a contradiction.

(b) The second condition implies that  $z_0 \in G(y_2) \subset \mathbb{R}$  for all  $y_2 \in D_2$ . Since  $G(y_2)$  is close for all  $y_2 \in D_2$ , let  $g^l(y_2) := \min G(y_2)$  and  $g^u(y_2) := \max G(y_2)$ , then  $g^l(y_2) \leq z_0 \leq g^u(y_2)$  for all  $y_2 \in D_2$ . Proving convexity of the set  $G(y_2)$  is equivalent to proving that  $[g^l(y_2), z_0] \subset G(y_2)$  and  $[z_0, g^u(y_2)] \subset G(y_2)$ . We provide details for the first set; the proof for the second set follows similarly.

Consider a  $x_{\mathcal{I}_2}^* \in D^{\mathcal{I}_2}$  satisfying  $h_2(x_{\mathcal{I}_2}^*) = y_2$  and  $q_i(x_{\mathcal{I}_2}^*, g^l(y_2)) \leq 0$  for all  $i \in \mathcal{J}_2$ ; closedness of the set  $G(y_2)$  implies well-posedness of  $x_{\mathcal{I}_2}^*$ . We also have  $q_i(x_{\mathcal{I}_2}^*, z_0) \leq 0$  for all  $i \in \mathcal{J}_2$  by assumption. Since

$q_i(x_{\mathcal{I}_2}, z)$  is quasiconvex with respect to  $z$  for all  $x_{\mathcal{I}_2} \in D^{\mathcal{I}_2}$  and  $i \in \mathcal{J}_2$ ,

$$q_i(x_{\mathcal{I}_2}^*, \theta g^l(y_2) + (1 - \theta)z_0) \leq \max\{q_i(x_{\mathcal{I}_2}^*, g^l(y_2)), q_i(x_{\mathcal{I}_2}^*, z_0)\} \leq 0 \quad \forall \theta \in [0, 1], \forall i \in \mathcal{J}_2$$

Since  $y_2$  is arbitrary,  $[g^l(y_2), z_0] \subset G(y_2)$  for all  $y_2 \in D_2$ . ■

**Remark 7.** Proposition 5 can be extended along the following directions:

- 1) The second condition in Proposition 5(b) can be relaxed as follows: for every  $y_2 \in D_2$ , there exists  $x_{\mathcal{I}_2}^{*,l}, x_{\mathcal{I}_2}^{*,u} \in D^{\mathcal{I}_2}$  and  $z_l, z_u \in \mathbb{R}$  satisfying: (i)  $h(x_{\mathcal{I}_1}^{*,s}) = y_2$  and  $q_i(x_{\mathcal{I}_2}^{*,s}, g^s(y_2)) \leq 0$  for  $s \in \{l, u\}$ ,  $i \in \mathcal{J}_2$ ; and (ii)  $q_i(x_{\mathcal{I}_2}^{*,s}, z_s) \leq 0$ , for  $s \in \{l, u\}$ ,  $i \in \mathcal{J}_2$ ; and (iii)  $z_l \geq z_u$ .
- 2) The set  $G(y_2)$  is not necessarily bounded, i.e., it is possible that  $g^l(y_2) = -\infty$  or  $g^u(y_2) = +\infty$ . For example, if (30) is feasible and  $q_i(x_{\mathcal{I}_2}, z)$  is nondecreasing (respectively, nonincreasing) with respect to  $z$  for all  $x_{\mathcal{I}_2} \in D^{\mathcal{I}_2}$  and  $i \in \mathcal{J}_2$ , then it is straightforward to see that  $g^l(y_2) = -\infty$  (respectively,  $g^u(y_2) = +\infty$ ). In this case, the second condition in Proposition 5(b) is trivially satisfied by  $z_0 = -\infty$  (respectively,  $z_0 = +\infty$ ).

Proposition 5 can be straightforwardly extended to optimization problems as follows.

**Proposition 6.** Let  $q_i(x_{\mathcal{I}_2}, z)$  be quasiconvex with respect to  $z$  for all  $x_{\mathcal{I}_2} \in \mathbb{R}^{\mathcal{I}_2}$ ,  $i \in \mathcal{J}_2$  and  $z_0 \in \mathbb{R}$  be such that  $q_i(x_{\mathcal{I}_2}, z_0) \leq 0$  for all  $x_{\mathcal{I}_2} \in D^{\mathcal{I}_2}$ ,  $i \in \mathcal{J}_2$ . Then, for every  $q_0 : D^{\mathcal{I}_1} \times \mathbb{R} \rightarrow \mathbb{R}$ ,

$$\begin{aligned} & \max_{\substack{x_{\mathcal{I}_1} \in D^{\mathcal{I}_1}, x_{\mathcal{I}_2} \in D^{\mathcal{I}_2} \\ y_1 \in \mathbb{R}, y_2 \in \mathbb{R}}} q_0(x_{\mathcal{I}_1}, y_2) \\ & \text{subject to} \quad q_i(x_{\mathcal{I}_1}, y_2) \leq 0, \quad \forall i \in \mathcal{J}_1 \\ & \quad \quad \quad q_i(x_{\mathcal{I}_2}, y_1) \leq 0, \quad \forall i \in \mathcal{J}_2 \\ & \quad \quad \quad y_1 = h_1(x_{\mathcal{I}_1}, y_2) \\ & \quad \quad \quad y_2 = h_2(x_{\mathcal{I}_2}) \end{aligned} \tag{32}$$

is equal to

$$\begin{aligned} & \max_{x_{\mathcal{I}_1} \in D^{\mathcal{I}_1}, y_2 \in D_2} q_0(x_{\mathcal{I}_1}, y_2) \\ & \text{subject to} \quad q_i(x_{\mathcal{I}_1}, y_2) \leq 0, \quad \forall i \in \mathcal{J}_1 \quad \text{where} \quad g^l(y_2) := \min G(y_2) \\ & \quad \quad \quad g^l(y_2) \leq h_1(x_{\mathcal{I}_1}, y_2) \leq g^u(y_2) \quad \quad \quad g^u(y_2) := \max G(y_2) \end{aligned} \tag{33}$$

and,  $D_2, G(y_2)$  are as defined in Proposition 5.

**Remark 8.** (a) The conditions in Proposition 5(a) do not guarantee that the set  $G(y_2)$  is non-empty for every  $y_2 \in D_2$ . However, under the additional condition of the existence of  $z_0$ , as in Propositions 5(b) and 6, the set  $G(y_2)$  is guaranteed to be non-empty for all  $y_2 \in D_2$ . In particular, this implies that  $g^l(y_2)$  and  $g^u(y_2)$  in Proposition 6 are well-defined.

- (b) Proposition 6 provides an equivalent bilevel formulation in (33) for a class of optimization problems described in (32).  $(x_{\mathcal{I}_1}, y_1)$  and  $(x_{\mathcal{I}_2}, z)$  are the upper and lower level variables, respectively.
- (c) When solving by exhaustive search, the bilevel formulation in (33) offers computational advantage over the original formulation in (32) as follows. The number of non-redundant variables in (32) is  $|\mathcal{I}_1| + |\mathcal{I}_2|$ . Therefore, the computational complexity in solving (32) by exhaustive search is exponential in  $|\mathcal{I}_1| + |\mathcal{I}_2|$ . On the other hand, the computational complexity associated with computing  $g^l(y_2)$  and  $g^u(y_2)$ , for every  $y_2$ , in the lower level problem in (33) is exponential in  $|\mathcal{I}_2|$ . Thereafter, the computational complexity of the upper level problem is exponential in  $|\mathcal{I}_1| + 1$ . Therefore, the complexity of solving the bilevel problem is exponential in  $\max\{|\mathcal{I}_1| + 1, |\mathcal{I}_2|\}$ , which is much less than that of (32). One can further reduce the computational complexity by extension to multilevel formulation, e.g., by recursive bilevel formulation of the lower level problem in (33). This multilevel extension will be explained in the context of the central problem (9)-(10) of this paper in Section V-C.

#### B. A Novel Network Reduction and its Relationship to the Equivalent Bilevel Formulation

In this subsection, we investigate conditions under which Proposition 6 can be applied to (9)-(10) to get an equivalent bilevel formulation. We first transform (10) into the form of (32), where the link weight  $w$  will play the role of  $x$  and  $D^{\mathcal{E}} = [w^l, w^u]$  will be its domain. The partition and structure of constraints underlying (32) will be made possible if the network and the nodes carrying non-zero demand and supply are relatively sparse. This condition is formalized in the following definition of *reducible networks*.

**Definition 4.** A network with directed multigraph  $\mathcal{G} = (\mathcal{V}, \mathcal{E})$  is called *reducible* about  $v_1 \in \mathcal{V}$  and  $v_2 \in \mathcal{V}$  under supply-demand vector  $p \in \mathbb{R}^{\mathcal{V}}$  if there exists a partition:  $\mathcal{G} = \mathcal{G}_1 \cup \mathcal{G}_2$ , with  $\mathcal{G}_1 = (\mathcal{V}_1, \mathcal{E}_1)$  and  $\mathcal{G}_2 = (\mathcal{V}_2, \mathcal{E}_2)$ , both satisfying Assumption 1, and  $\mathcal{V}_1 \cup \mathcal{V}_2 = \mathcal{V}$ ,  $\mathcal{V}_1 \cap \mathcal{V}_2 = \{v_1, v_2\}$ ,  $\mathcal{E}_1 \cup \mathcal{E}_2 = \mathcal{E}$ ,  $\mathcal{E}_1 \cap \mathcal{E}_2 = \emptyset$  and  $|\mathcal{E}_2| \geq 2$ , such that the supply-demand vector  $p$  is supported only on  $\mathcal{V}_1$ .  $\mathcal{G}_2$  is referred to as the *reducible component* and  $\tilde{\mathcal{G}}_1 = (\mathcal{V}_1, \tilde{\mathcal{E}}_1)$  is referred to as a *reduction* of  $\mathcal{G}$ , where  $\tilde{\mathcal{E}}_1 = \mathcal{E}_1 \cup (v_1, v_2)$ , and  $(v_1, v_2)$  is an additional (virtual) link, not originally present in  $\mathcal{G}$ .

**Remark 9.** In Definition 4,

- (a) reducibility of a network depends both on its topology as well as the location of the supply and demand nodes;
- (b) if  $(v_1, v_2)$  is a link (or corresponds to several links when  $\mathcal{G}$  is a multigraph), then it can be assigned arbitrarily to either  $\mathcal{E}_1$  or  $\mathcal{E}_2$ ; in this case the reduction process will result in an additional link  $(v_1, v_2)$  in  $\tilde{\mathcal{E}}_1$ ;
- (c) the supply-demand vector  $p$  can be non-zero at  $v_1$  or  $v_2$ .

We now describe a reduction procedure for a reducible network, e.g., as illustrated in Fig. 4. Specifically, this network will be decomposed into two smaller sub-networks  $\tilde{\mathcal{G}}_1$  and  $\mathcal{G}_2$ ;  $(v_1, v_2)$  is a virtual link with equivalent weight  $w_{\text{eq}} = \mathcal{H}(w_{\mathcal{E}_2}, \mathcal{G}_2, v_1, v_2)$  as defined in Definition 5, and  $\mathcal{G}_2$  has a virtual supply-demand vector supported on nodes  $v_1$  and  $v_2$ . The reduction is equivalent (cf. Lemma 5) in the sense that, the flows on links in  $\mathcal{E}$  obtained from Lemma 1, is the same as the flows on corresponding links in  $\mathcal{E}_1$  and  $\mathcal{E}_2$  by applying Lemma 1 to sub-networks

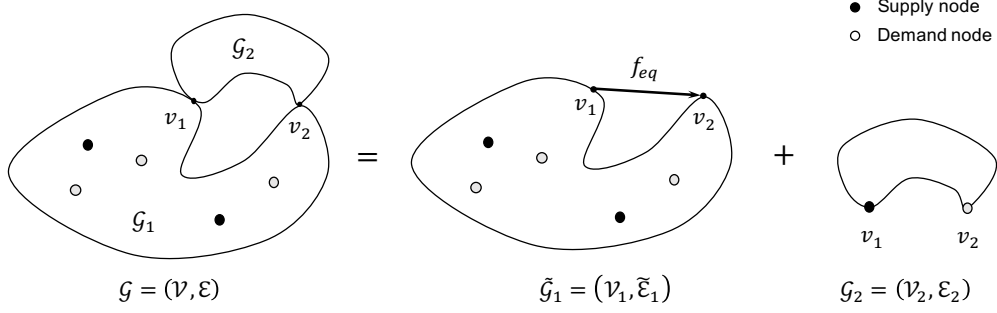

Fig. 4: Illustration of a reducible network

$\tilde{\mathcal{G}}_1$  and  $\mathcal{G}_2$ , respectively. The flow on the virtual link is given by:

$$f_{\text{eq}} = \sum_{i \in \mathcal{E}_{v_1}^+ \cap \mathcal{E}_2} f_i - \sum_{i \in \mathcal{E}_{v_1}^- \cap \mathcal{E}_2} f_i = \sum_{i \in \mathcal{E}_{v_2}^- \cap \mathcal{E}_2} f_i - \sum_{i \in \mathcal{E}_{v_2}^+ \cap \mathcal{E}_2} f_i. \quad (34)$$

and the virtual supply-demand on  $\mathcal{G}_2$  is  $f_{\text{eq}} a_{v_1 v_2}$ , where  $a_{v_1 v_2} \in \{-1, 0, +1\}^{\mathcal{V}_2}$  is such that its  $v_1$ -th component is  $+1$ ,  $v_2$ -th component is  $-1$ , and all the other components are zero.

**Lemma 5.** Consider a network with directed multigraph  $\mathcal{G} = (\mathcal{V}, \mathcal{E})$ , link weights  $w \in \mathbb{R}_{>0}^{\mathcal{E}}$  and a supply-demand vector  $p \in \mathbb{R}^{\mathcal{V}}$ . If  $\mathcal{G}$  is that is reducible (cf. Definition 4) about  $v_1, v_2 \in \mathcal{V}$  under  $p$ , the link flows  $f^{\mathcal{G}}$  in  $\mathcal{G}$ , are equal to the corresponding link flows  $f^{\tilde{\mathcal{G}}_1}$  and  $f^{\mathcal{G}_2}$  in sub-networks  $\tilde{\mathcal{G}}_1$  and  $\mathcal{G}_2$ , respectively. Formally,

$$\begin{aligned} f_{\text{eq}} &= f_{v_1 v_2}^{\tilde{\mathcal{G}}_1}(w_{\tilde{\mathcal{E}}_1}, p_{\mathcal{V}_1}) \\ f_i^{\mathcal{G}}(w, p) &= f_i^{\tilde{\mathcal{G}}_1}(w_{\tilde{\mathcal{E}}_1}, p_{\mathcal{V}_1}) \quad \forall i \in \mathcal{E}_1 \\ f_i^{\mathcal{G}}(w, p) &= f_i^{\mathcal{G}_2}(w_{\mathcal{E}_2}, a_{v_1 v_2}) f_{\text{eq}} \quad \forall i \in \mathcal{E}_2 \end{aligned} \quad (35)$$

where  $w_{\tilde{\mathcal{E}}_1}$  and  $w_{\mathcal{E}_2}$  are the weight matrices associated with sub-networks  $\tilde{\mathcal{G}}_1$  and  $\mathcal{G}_2$ , respectively, and  $p_{\mathcal{V}_1}$  is the sub-vector of  $p$  corresponding to nodes in  $\mathcal{V}_1$ .

*Proof:* Noting that the components of the supply-demand vector at nodes in  $\mathcal{V}_2$  are zero, Ohm's and Kirchhoff's laws for links  $\mathcal{E}_2$  and nodes  $\mathcal{V}_2$  in  $\mathcal{G}_2$  can be written as:

$$w_i(\phi_{\sigma(i)} - \phi_{\tau(i)}) = f_i^{\mathcal{G}} \quad \forall i \in \mathcal{E}_2, \quad \sum_{i \in \mathcal{E}_v^+ \cap \mathcal{E}_2} f_i^{\mathcal{G}} - \sum_{i \in \mathcal{E}_v^- \cap \mathcal{E}_2} f_i^{\mathcal{G}} = 0 \quad \forall v \in \mathcal{V}_2 \setminus \{v_1, v_2\}. \quad (36)$$

(36), along with (34), are the same equations as one would get by writing Kirchhoff's and Ohm's law for  $\mathcal{G}_2$  under supply-demand vector  $f_{\text{eq}} a_{v_1 v_2}$ . Taking this latter interpretation of (34) and (36), Lemma 1 and its proof then gives the flow solution on links in  $\mathcal{G}_2$  in (35), i.e.,  $f_i^{\mathcal{G}} = f_i^{\mathcal{G}_2}(w_{\mathcal{E}_2}, f_{\text{eq}} a_{v_1 v_2}) = f_{\text{eq}} f_i^{\mathcal{G}_2}(w_{\mathcal{E}_2}, a_{v_1 v_2})$ . Moreover, if  $\phi_{\mathcal{V}_2}$  denotes the sub-vector of  $\phi$  corresponding to nodes in  $\mathcal{V}_2$ , then we have  $\phi_{\mathcal{V}_2} = f_{\text{eq}} L_{\mathcal{G}_2}^\dagger a_{v_1 v_2}$ , and hence

$$\phi_{v_1} - \phi_{v_2} = a_{v_1 v_2}^T \phi_{\mathcal{V}_2} = f_{\text{eq}} a_{v_1 v_2}^T L_{\mathcal{G}_2}^\dagger a_{v_1 v_2} = f_{\text{eq}} / w_{\text{eq}} \quad (37)$$



$f_{\text{eq}}$  and (37) can be seen as the flow on and Ohm's law for the virtual link  $(v_1, v_2)$ , respectively. Now writing Ohm's and Kirchhoff's laws for  $\mathcal{G}_1$ , we get

$$\begin{aligned} w_i(\phi_{\sigma(i)} - \phi_{\tau(i)}) &= f_i^{\mathcal{G}} \quad \forall i \in \mathcal{E}_1, & \sum_{i \in \mathcal{E}_v^+} f_i^{\mathcal{G}} - \sum_{i \in \mathcal{E}_v^-} f_i^{\mathcal{G}} &= p_v \quad \forall v \in \mathcal{V}_1 \setminus \{v_1, v_2\} \\ \sum_{j \in \mathcal{E}_{v_1}^+ \cap \mathcal{E}_1} f_j^{\mathcal{G}} - \sum_{i \in \mathcal{E}_{v_1}^- \cap \mathcal{E}_1} f_i^{\mathcal{G}} + f_{\text{eq}} &= 0 & \sum_{i \in \mathcal{E}_{v_2}^+ \cap \mathcal{E}_2} f_i^{\mathcal{G}} + \sum_{i \in \mathcal{E}_{v_2}^- \cap \mathcal{E}_2} f_i^{\mathcal{G}} - f_{\text{eq}} &= 0 \end{aligned} \quad (38)$$

where we use the definition of  $f_{\text{eq}}$  in (37). As  $f_{\text{eq}}$  is interpreted to be the flow on a virtual link  $(v_1, v_2)$ , (37) and (38) become Ohm's and Kirchhoff's laws for  $\tilde{\mathcal{G}}_1$ . The expression for  $f_i^{\mathcal{G}}$ ,  $i \in \mathcal{E}_1$  and  $f_{\text{eq}}$ , in (35) now follows from Lemma 1 and its proof.  $\blacksquare$

(37) motivates the following definition of equivalent weight.

**Definition 5** (Equivalent Weight). *Given a network with directed multigraph  $\mathcal{G} = (\mathcal{V}, \mathcal{E})$ , link weights  $w \in \mathbb{R}_{>0}^{\mathcal{E}}$ , the equivalent weight between two given nodes  $v_1, v_2 \in \mathcal{V}$  is defined as:*

$$\mathcal{H}(w, \mathcal{G}, v_1, v_2) := \frac{1}{a_{v_1 v_2}^{\text{T}} L_{\mathcal{G}}^{\dagger} a_{v_1 v_2}} \quad (39)$$

where  $a_{v_1 v_2} \in \{-1, 0, +1\}^{\mathcal{V}}$  is such that its  $v_1$ -th component is  $+1$ , the  $v_2$ -th component is  $-1$ , and all the other components are zero.

**Remark 10.** *Definition 5 is well-posed, i.e.,  $a_{v_1 v_2}^{\text{T}} L_{\mathcal{G}}^{\dagger} a_{v_1 v_2} > 0$  for all (connected) networks  $\mathcal{G}$  and  $v_1, v_2 \in \mathcal{V}$ . This is because,  $L_{\mathcal{G}}^{\dagger}$  is positive definite in space  $\mathbb{R}^{\mathcal{E}} \setminus \text{span}\{\mathbf{1}\}$ .*

At times, when the graph  $\mathcal{G}$  and nodes  $v_1$  and  $v_2$  are clear from the context, we shall denote the equivalent weight simply by  $\mathcal{H}(w)$  for brevity.  $\mathcal{H}(w)$  is generalization of rather standard formulae for equivalent resistances for serial and parallel connections from circuit theory, which we briefly state next for completeness.

**Example 3** (Equivalent Weight for Serial and Parallel Networks). *For a network consisting only of  $m$  parallel links from node  $v_1$  to node  $v_2$ , with weights  $w_i$  ( $i = 1, 2, \dots, m$ ), the equivalent weight between  $v_1$  and  $v_2$ , as given by (39), is*

$$\mathcal{H}(w) = \left( [1, -1] \begin{bmatrix} \sum_{i=1}^m w_i & -\sum_{i=1}^m w_i \\ -\sum_{i=1}^m w_i & \sum_{i=1}^m w_i \end{bmatrix}^{\dagger} \begin{bmatrix} 1 \\ -1 \end{bmatrix} \right)^{-1} = \sum_{i=1}^m w_i$$

Similarly, for a network consisting only of  $m$  links in series from node  $v_1$  to node  $v_2$ , with weights  $w_i$  ( $i = 1, 2, \dots, m$ ), the equivalent weight, as given by (39) is  $(\sum_{i=1}^m 1/w_i)^{-1}$ .

*The expressions for the equivalent weight in these two canonical cases, as given by (39), are the same as standard formulae from circuit theory.*

For given  $\mathcal{G} = (\mathcal{V}, \mathcal{E})$ , and  $v_1, v_2 \in \mathcal{V}$ , monotonicity of  $\mathcal{H}(w)$  with respect to components of  $w$  follows from Rayleigh's monotonicity law, e.g., see [30, Section 1.4]. Nevertheless, for the sake of completeness, and also to describe an alternate short proof based on the techniques developed in Section IV-A, we state this result next.

**Lemma 6.** For a network with underlying graph  $\mathcal{G} = (\mathcal{V}, \mathcal{E})$  and weight  $w \in \mathbb{R}^{\mathcal{E}}$ , the equivalent weight function between any two nodes  $v_1, v_2 \in \mathcal{V}$ , as defined in (39), satisfies the following:

$$\frac{\partial}{\partial w_i} \mathcal{H}(w, \mathcal{G}, v_1, v_2) \geq 0, \quad \forall i \in \mathcal{E}, \quad w \in \mathbb{R}_{>0}^{\mathcal{E}}$$

*Proof:* Let  $\hat{\mathcal{H}}(w) := a_{v_1 v_2}^{\text{T}} L^\dagger a_{v_1 v_2}$ . The lemma then follows from:

$$\frac{\partial \hat{\mathcal{H}}(w)}{\partial w_i} = a_{v_1 v_2}^{\text{T}} \frac{\partial L^\dagger}{\partial w_i} a_{v_1 v_2} = -a_{v_1 v_2}^{\text{T}} L^\dagger a_i a_i^{\text{T}} L^\dagger a_{v_1 v_2} = -\left(a_i^{\text{T}} L^\dagger a_{v_1 v_2}\right)^2 \leq 0$$

where the second equality is due to (20). In the above equation,  $a_{v_1 v_2}$  has the same meaning as in Definition 5, and  $a_i$  is the  $i$ -th column of the node-link incidence matrix  $A$  associated with  $\mathcal{G}$ .  $\blacksquare$

**Remark 11.** (a) Example 3 implies that the equivalent weight function is strictly monotone for series and parallel networks.

(b) Monotonicity of  $\mathcal{H}$  from Lemma 6 along with its continuity implies that  $\mathcal{H}(w)$  is not necessarily a one-to-one map from  $[w^l, w^u] \subset \mathbb{R}_{>0}^{\mathcal{E}}$  to  $[\mathcal{H}(w^l), \mathcal{H}(w^u)] \subset \mathbb{R}_{>0}$ .

It is easy to see that the equivalent network reduction implied by Lemma 5 reduces computational complexity for computing link flows by decomposing the original network into sub-networks. We now show that such a decomposition approach is naturally aligned with Proposition 6, and leads to reduction in computational complexity of the weight control problem (9)-(10) by formulating an equivalent bilevel problem (cf. Remark 8(c)). We first note that the network reduction implemented for the nominal supply-demand vector  $p_0$  is also valid for nongenerative disturbances (cf. Definition 3) associated with  $p_0$ . Hence, Lemma 5 is also applicable for all nongenerative disturbances. Therefore, one can rewrite the constraints in (10) as:

$$\begin{aligned} c_i^l &\leq f_i^{\tilde{\mathcal{G}}_1}(w_{\tilde{\mathcal{E}}_1}, p_{\Delta}, \mathcal{V}_1) \leq c_i^u \quad \forall i \in \mathcal{E}_1 \\ c_i^l &\leq f_{\text{eq}} f_i^{\mathcal{G}_2}(w_{\mathcal{E}_2}, a_{v_1 v_2}) \leq c_i^u \quad \forall i \in \mathcal{E}_2 \\ f_{\text{eq}} &= f_{v_1 v_2}^{\tilde{\mathcal{G}}_1}(w_{\tilde{\mathcal{E}}_1}, p_{\Delta}, \mathcal{V}_1) \\ w_{\text{eq}} &= \mathcal{H}(w_{\mathcal{E}_2}) \end{aligned} \tag{40}$$

where we recall that  $p_{\Delta} = p_0 + \Delta$  is the disturbed supply-demand vector and  $p_{\Delta, \mathcal{V}_1}$  is the subvector corresponding to node set  $\mathcal{V}_1$  of  $p_{\Delta}$ . The analogy between (32) and  $\{(10), (40)\}$  is more apparent now:  $\mathcal{I}_1 \equiv \mathcal{E}_1$  and  $\mathcal{I}_2 \equiv \mathcal{E}_2$ ,  $x_{\mathcal{I}_1} \equiv w_{\mathcal{E}_1} \cup \{\Delta\}$  and  $x_{\mathcal{I}_2} \equiv w_{\mathcal{E}_2}$ ,  $y_1 \equiv f_{\text{eq}}$  and  $y_2 \equiv w_{\text{eq}}$ ,  $q_i(x_{\mathcal{I}_1}, y_2) \equiv f_i^{\tilde{\mathcal{G}}_1}(w_{\tilde{\mathcal{E}}_1}, p_{\Delta}, \mathcal{V}_1)$  for all  $i \in \mathcal{E}_1$  and  $q_i(x_{\mathcal{I}_2}, y_1) \equiv f_{\text{eq}} f_i^{\mathcal{G}_2}(w_{\mathcal{E}_2}, a_{v_1 v_2})$  for all  $i \in \mathcal{E}_2$ <sup>4</sup>,  $h_1(x_{\mathcal{I}_1}, y_2) \equiv f_{v_1 v_2}^{\tilde{\mathcal{G}}_1}(w_{\tilde{\mathcal{E}}_1}, p_{\Delta}, \mathcal{V}_1)$  and  $h_2(x_{\mathcal{I}_2}) \equiv \mathcal{H}(w_{\mathcal{E}_2})$ . Since  $q_i(\cdot, y_1)$  is a linear function with respect to  $y_1$  for all  $w_{\mathcal{E}_2} \in D^{\mathcal{E}_2}$  (recall  $D^{\mathcal{E}_2} = [w_{\mathcal{E}_2}^l, w_{\mathcal{E}_2}^u]$ ) and  $i \in \mathcal{E}_2$ , both  $q_i(\cdot, y_1)$  and  $-q_i(\cdot, y_1)$  are quasiconvex with respect to  $y_1$  for all  $i \in \mathcal{E}_2$ . Furthermore, it is straightforward to see that

$$c_i^l \leq q_i(\cdot, 0) = 0 \leq c_i^u \quad \forall i \in \mathcal{E}_2 \tag{41}$$

<sup>4</sup>Every constraint in  $\mathcal{E}_1$  and  $\mathcal{E}_2$  corresponds to two constraints in the formulation of (32), i.e.,  $c_i^l \leq q_i(\cdot) \leq c_i^u$  corresponds to  $q_i(\cdot) - c_i^u \leq 0$  and  $-q_i(\cdot) + c_i^l \leq 0$ .

Therefore, proposition 6 can then be applied and gives the following result.

**Proposition 7.** *Consider a network with directed multigraph  $\mathcal{G} = (\mathcal{V}, \mathcal{E})$ , lower and upper link weights  $w^l \in \mathbb{R}_{>0}^{\mathcal{E}}$  and  $w^u \in \mathbb{R}_{>0}^{\mathcal{E}}$  respectively, a supply-demand vector  $p \in \mathbb{R}^{\mathcal{V}}$ . If  $\mathcal{G}$  is reducible (cf. Definition 4) about  $v_1, v_2 \in \mathcal{V}$  under  $p$  and the disturbances are nongenerative (cf. 3), then (14) is equal to the following*

$$\begin{aligned} \min_{\delta \in \Delta_{NG}(p_0)} \quad & \max_{\substack{\mu \geq 0 \\ w_{\mathcal{E}_1} \in D^{\mathcal{E}_1} \\ w_{\text{eq}} \in D_2}} \quad & \mu \\ \text{subject to} \quad & c_i^l \leq f_i^{\tilde{\mathcal{G}}_1}(w_{\tilde{\mathcal{E}}_1}, p_0 + \mu\delta) \leq c_i^u \quad \forall i \in \mathcal{E}_1 \\ & g^l(w_{\text{eq}}) \leq f_{v_1 v_2}^{\tilde{\mathcal{G}}_1}(w_{\tilde{\mathcal{E}}_1}, p_0 + \mu\delta) \leq g^u(w_{\text{eq}}) \end{aligned} \quad (42)$$

where  $D^{\mathcal{E}_1} := [w_{\mathcal{E}_1}^l, w_{\mathcal{E}_1}^u]$ ,  $D_2 := [\mathcal{H}(w_{\mathcal{E}_2}^l), \mathcal{H}(w_{\mathcal{E}_2}^u)]$ ,  $g^l(w_{\text{eq}}) := \min G(w_{\text{eq}})$  and  $g^u(w_{\text{eq}}) := \max G(w_{\text{eq}})$  with the set  $G(w_{\text{eq}})$  defined as:

$$G(w_{\text{eq}}) := \{z \in \mathbb{R} \mid c_{\mathcal{E}_2}^l \leq z f^{\mathcal{G}_2}(w_{\mathcal{E}_2}, a_{v_1 v_2}) \leq c_{\mathcal{E}_2}^u \text{ for some } w_{\mathcal{E}_2} \in D^{\mathcal{E}_2} \text{ satisfying } \mathcal{H}(w_{\mathcal{E}_2}) = w_{\text{eq}}\}$$

where  $D^{\mathcal{E}_2} := [w_{\mathcal{E}_2}^l, w_{\mathcal{E}_2}^u]$ .

Noting the structural similarity between the two inequality constraints in the upper level problem in (42), it is compelling to interpret  $g^l(w_{\text{eq}})$  and  $g^u(w_{\text{eq}})$  as the *equivalent capacities* (lower and upper respectively) of the equivalent virtual link  $(v_1, v_2)$ .

**Definition 6** (Equivalent Capacities). *Consider a network consisting of directed multigraph  $\mathcal{G} = (\mathcal{V}, \mathcal{E})$ , lower and upper bounds on link weights  $w^l \in \mathbb{R}_{>0}^{\mathcal{E}}$  and  $w^u \in \mathbb{R}_{>0}^{\mathcal{E}}$ , respectively, and link lower and upper capacity functions  $c_i^l : [w_i^l, w_i^u] \rightarrow \mathbb{R}_{<0}$  and  $c_i^u : [w_i^l, w_i^u] \rightarrow \mathbb{R}_{>0}$ ,  $i \in \mathcal{E}$ , respectively. Between any two nodes  $v_1, v_2 \in \mathcal{V}$  and for a given equivalent weight  $w_{\text{eq}} \in [\mathcal{H}(w_{\mathcal{E}_2}^l, \mathcal{G}, v_1, v_2), \mathcal{H}(w_{\mathcal{E}_2}^u, \mathcal{G}, v_1, v_2)]$ , the corresponding equivalent lower capacity  $C^l(w_{\text{eq}})$  and upper capacity  $C^u(w_{\text{eq}})$  are defined as:*

$$C^l(w_{\text{eq}}, \mathcal{G}, v_1, v_2) := \min G(w_{\text{eq}}); \quad C^u(w_{\text{eq}}, \mathcal{G}, v_1, v_2) := \max G(w_{\text{eq}}) \quad (43)$$

where

$$G(w_{\text{eq}}) := \{z \in \mathbb{R} \mid c^l \leq z f(w, a_{v_1 v_2}) \leq c^u \text{ for some } w \in [w^l, w^u] \text{ satisfying } \mathcal{H}(w, \mathcal{G}, v_1, v_2) = w_{\text{eq}}\}$$

and  $a_{v_1 v_2} \in \{-1, 0, +1\}^{\mathcal{V}}$  is such that its  $v_1$ -th component is  $+1$ , the  $v_2$ -th component is  $-1$ , and all the other components are zero.

For brevity in notations, we drop the dependence of  $C^l$  and  $C^u$  on  $\mathcal{G}$ ,  $v_1$  or  $v_2$ , when clear from the context.

**Remark 12.**

(a) Note that the link capacity functions in Definition 6 are assumed to be weight-dependent. This general setup allows definition of equivalent capacity to be applicable to networks whose links themselves could be equivalent

links for some underlying sub-network. This feature is specifically used in extending the bilevel formulation to a multilevel framework in Section V-C.

- (b) Remarkably, the equivalent capacity can be expressed concisely in terms of the equivalent weight, as opposed to the entire weight vector  $w_{\mathcal{E}_2}$ . This considerably reduces the complexity of the weight control problem (9)-(10).
- (c) Computing the equivalent capacities for a given  $w_{\text{eq}}$  between two nodes  $v_1$  and  $v_2$  of a network  $\mathcal{G}$  is equivalent to solving the weight control problem (14) for  $\mathcal{G}$  with a single supply node  $v_1$ , a single demand node  $v_2$ , and under multiplicative disturbances – however, with the additional equality constraint  $\mathcal{H}(\mathcal{G}, w, v_1, v_2) = w_{\text{eq}}$ . Therefore, when the network contains only one supply node and one demand node, finding the equivalent capacity functions  $\mathcal{C}^l$  and  $\mathcal{C}^u$  can be considered to be a generalization of solving  $\alpha_-^*$  and  $\alpha_+^*$  in (14). More specifically,

$$\alpha_+^* = \max_{\mathcal{H}(w^l) \leq w_{\text{eq}} \leq \mathcal{H}(w^u)} \mathcal{C}^u(w_{\text{eq}}); \quad \alpha_-^* = - \min_{\mathcal{H}(w^l) \leq w_{\text{eq}} \leq \mathcal{H}(w^u)} \mathcal{C}^l(w_{\text{eq}})$$

### C. A Nested Bilevel Approach for Multilevel Formulation

For a reducible network as per Definition 4, Proposition 7 shows that the weight control problem (9)-(10) can be transformed into a bilevel optimization problem (42), in which the lower level problem involves finding the equivalent lower and upper capacity functions of an appropriate subnetwork. We now extend this to a multilevel framework.

A comparison with (9)-(10) reveals that the upper level problem (42) is indeed the same as (9)-(10) written for the sub-network  $\tilde{\mathcal{G}}_1$ , where the equivalent link  $(v_1, v_2)$  has weight  $w_{\text{eq}} = \mathcal{H}(w_{\mathcal{E}_2}) \in [\mathcal{H}(w_{\mathcal{E}_2}^l), \mathcal{H}(w_{\mathcal{E}_2}^u)]$  and weight dependent lower and upper capacities  $\mathcal{C}^l(w_{\text{eq}})$  and  $\mathcal{C}^u(w_{\text{eq}})$ , respectively. If the reduced sub-network  $\tilde{\mathcal{G}}_1 =: \mathcal{G}^{(1)}$  is also reducible as per Definition 4, with its sub-networks  $\mathcal{G}_1^{(1)}$  and  $\mathcal{G}_2^{(1)}$ , one can apply Proposition 6 to (42) to get an equivalent bilevel formulation for  $\mathcal{G}^{(1)}$  if: (a)  $q_i$  for  $i \in \mathcal{E}_2^{(1)} = \tilde{\mathcal{E}}_1$  are quasiconvex, and (b) the equivalent lower and upper capacity functions for links in  $\mathcal{G}_2^{(1)}$  are strictly negative and positive respectively, as in (41). (a) is satisfied trivially as before because of linearity of  $q_i$ , and (b) follows from the next result.

**Lemma 7.** Consider a network consisting of directed multigraph  $\mathcal{G} = (\mathcal{V}, \mathcal{E})$ , lower and upper bounds on link weights  $w^l \in \mathbb{R}_{>0}^{\mathcal{E}}$  and  $w^u \in \mathbb{R}_{>0}^{\mathcal{E}}$ , respectively, and link lower and upper capacity functions  $c_i^l : [w_i^l, w_i^u] \rightarrow \mathbb{R}_{<0}$  and  $c_i^u : [w_i^l, w_i^u] \rightarrow \mathbb{R}_{>0}$ ,  $i \in \mathcal{E}$ , respectively. The equivalent lower capacity  $\mathcal{C}^l(w_{\text{eq}})$  and upper capacity  $\mathcal{C}^u(w_{\text{eq}})$  between two given nodes  $v_1, v_2 \in \mathcal{V}$  satisfy the following:

$$\mathcal{C}^l(w_{\text{eq}}) < 0 < \mathcal{C}^u(w_{\text{eq}}) \quad \forall w_{\text{eq}} \in [\mathcal{H}(w^l), \mathcal{H}(w^u)]$$

*Proof:* Since  $c_i^l < 0 < c_i^u$  for all  $i \in \mathcal{E}$ , we have  $0 \in G(w_{\text{eq}})$  in Definition 6. It is easy to see that, for  $z_0 = \min_{i \in \mathcal{E}} \{-\max_{w_i^l \leq w_i \leq w_i^u} c_i^l(w_i), \min_{w_i^l \leq w_i \leq w_i^u} c_i^u(w_i)\} > 0$ , we have  $\mathcal{C}^l(w_{\text{eq}}) \leq -z_0 < 0 < z_0 < \mathcal{C}^u(w_{\text{eq}})$  for all  $w_{\text{eq}} \in [\mathcal{H}(w^l), \mathcal{H}(w^u)]$ . This is true because  $|f_i(w, a_{v_1 v_2})| \leq 1$  for all  $i \in \mathcal{E}$  from Lemma 15 in Appendix B. ■

A recursive application of this procedure leads to an equivalent multilevel formulation for the original weight control problem in (42); the process stops when the sub-network corresponding to the upper level problem, referred

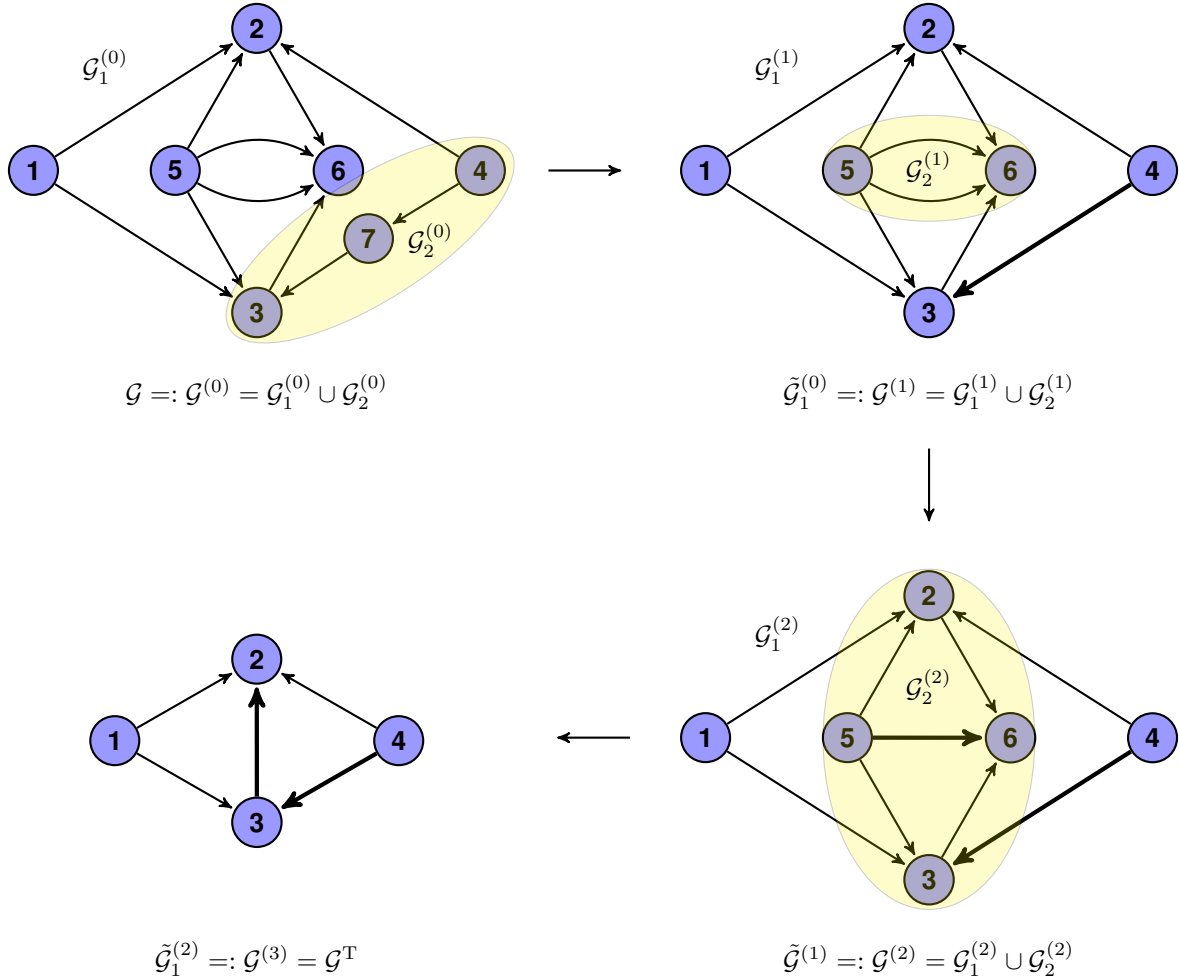

Fig. 5: Illustration of recursive network reduction, where the supply node set is  $\{1, 4\}$  and the demand node set is  $\{2, 3\}$ ; the thick edges denote the equivalent links. The original network  $\mathcal{G}$  is reduced into the terminal network  $\mathcal{G}^T$  in three reductions: (1) subnetwork  $\mathcal{G}_2^{(0)} \rightarrow$  link  $(4, 3)$ ; (2) subnetwork  $\mathcal{G}_2^{(1)} \rightarrow$  link  $(5, 6)$ ; (3) subnetwork  $\mathcal{G}_2^{(2)} \rightarrow$  link  $(3, 2)$ .  $\mathcal{G}^k := \tilde{\mathcal{G}}_1^{(k-1)}$  is the resulting network after  $k$ th reduction. Notice the first and the second reduction can be implemented in parallel and the terminal network  $\mathcal{G}^T = \mathcal{G}^{(3)}$  is not reducible.

to as the *terminal network*, is not reducible, as per Definition 4. The resulting multilevel hierarchy consists of a series of a collection of lower level problems, and an upper level problem corresponding to the last recursion. We appropriately then refer to the former as *reduction problems* and the latter as the *terminal problem*. The reduction problem  $\mathbf{P}_r$  is formalized next in Problem 1, and the terminal problem is the generalized weight control problem

**P** (cf. Problem 2) on the terminal network.

---

**Problem 1:** Reduction problem  $\mathbf{P}_r$

---

$$(\mathcal{G}, w^l, w^u, c^l, c^u, v_1, v_2) \longrightarrow \boxed{\mathbf{P}_r} \longrightarrow (w_{v_1 v_2}^l, w_{v_1 v_2}^u, c_{v_1 v_2}^l, c_{v_1 v_2}^u)$$

**input** network  $\mathcal{G} = (\mathcal{V}, \mathcal{E})$  with link weights bounds  $w^l \in \mathbb{R}_{>0}^{\mathcal{E}}$  and  $w^u \in \mathbb{R}_{>0}^{\mathcal{E}}$ , link capacity functions  $c_i^l : [w_i^l, w_i^u] \rightarrow \mathbb{R}_{<0}$  and  $c_i^u : [w_i^l, w_i^u] \rightarrow \mathbb{R}_{>0}$  for  $i \in \mathcal{E}$ , and nodes  $v_1, v_2 \in \mathcal{V}$ .

**output** equivalent lower and upper weight bounds:  $w_{v_1 v_2}^l = \mathcal{H}(w^l)$  and  $w_{v_1 v_2}^u = \mathcal{H}(w^u)$ , where  $\mathcal{H}$  is as in Definition 5; equivalent lower and upper capacity functions:  $c_{v_1 v_2}^l = \mathcal{C}^l : [w_{v_1 v_2}^l, w_{v_1 v_2}^u] \rightarrow \mathbb{R}_{<0}$  and  $c_{v_1 v_2}^u = \mathcal{C}^u : [w_{v_1 v_2}^l, w_{v_1 v_2}^u] \rightarrow \mathbb{R}_{>0}$ , where  $\mathcal{C}^l(w_{\text{eq}})$  and  $\mathcal{C}^u(w_{\text{eq}})$  are as in Definition 6.

---



---

**Problem 2:** Generalized weight control problem  $\mathbf{P}$

---

$$(\mathcal{G}, w^l, w^u, c^l, c^u, p_0) \longrightarrow \boxed{\mathbf{P}} \longrightarrow \nu^*(\mathcal{G})$$

**input** network  $\mathcal{G} = (\mathcal{V}, \mathcal{E})$  with link weights bounds  $w^l \in \mathbb{R}_{>0}^{\mathcal{E}}$  and  $w^u \in \mathbb{R}_{>0}^{\mathcal{E}}$ , link capacity functions  $c_i^l : [w_i^l, w_i^u] \rightarrow \mathbb{R}_{<0}$  and  $c_i^u : [w_i^l, w_i^u] \rightarrow \mathbb{R}_{>0}$  for  $i \in \mathcal{E}$ , and initial supply-demand vector  $p_0 \in \mathbb{R}^{\mathcal{V}}$

**output** margin of robustness:  $\nu^*(\mathcal{G}) = \nu^*(\mathcal{G}, w^l, w^u, c^l, c^u, p_0)$ , which is obtained by solving (9) and (10) with weight dependent capacities.

---

Figure 5 provides an illustration for a sample network, where the process of replacing  $\mathcal{G}_2^{(0)}$  with an equivalent link in  $\mathcal{G}_1^{(1)} := \tilde{\mathcal{G}}_1^0$  corresponds to solving the reduction problem  $\mathbf{P}_r$  with input comprising of weights and capacities bounds for links associated with  $\mathcal{G}_2^{(0)}$ , and the terminal problem corresponds to the weight control problem  $\mathbf{P}$  for  $\mathcal{G}^T = \mathcal{G}^{(3)}$ . The formal description of the multilevel programming formulation in terms of recursive solution to reduction problems and solution to the terminal problem is provided in Algorithm 1.

## VI. AN EFFICIENT SOLUTION METHODOLOGY FOR THE MULTILEVEL PROGRAMMING FORMULATION

In this section, we show that the two types of problems in the multilevel formulation for the weight control problem (*i.e.*, reduction and terminal problems) can be solved explicitly for *tree reducible networks*.

### A. Tree reducible network

**Definition 7** (Tree reducible network). *A network with directed multigraph  $\mathcal{G} = (\mathcal{V}, \mathcal{E})$  and supply-demand vector  $p \in \mathbb{R}^{\mathcal{V}}$  is called tree reducible (see also [31]) if there exists a sequence consisting of the following three operations*

---

**Algorithm 1:** Multilevel programming formulation.

---

**input** : network  $\mathcal{G} = (\mathcal{V}, \mathcal{E})$  with link weights bounds  $w^l \in \mathbb{R}_{>0}^{\mathcal{E}}$  and  $w^u \in \mathbb{R}_{>0}^{\mathcal{E}}$ , link capacity bounds

$c^l \in \mathbb{R}_{<0}^{\mathcal{E}}$  and  $c^u \in \mathbb{R}_{>0}^{\mathcal{E}}$ , and supply-demand vector  $p_0 \in \mathbb{R}^{\mathcal{V}}$

**output:** margin of robustness  $\nu^*(\mathcal{G})$

**initialization:**  $k = 0$ ,  $\mathcal{G}^{(0)} = \mathcal{G}$ ,  $(w^l)^{(0)} = w^l$ ,  $(w^u)^{(0)} = w^u$ ,  $(c^l(\cdot))^{(0)} \equiv c^l$ ,  $(c^u(\cdot))^{(0)} \equiv c^u$  ;

**while**  $\mathcal{G}^{(k)}$  is reducible under  $p_0$  about  $v_1^{(k)}, v_2^{(k)} \in \mathcal{V}$  **do**

implement network decomposition and obtain subnetworks  $\mathcal{G}_1^{(k)} = (\mathcal{V}^{(k)}, \mathcal{E}_1^{(k)})$  and  $\mathcal{G}_2^{(k)} = (\mathcal{V}_2^{(k)}, \mathcal{E}_2^{(k)})$

such that  $\mathcal{G}^{(k)} = \mathcal{G}_1^{(k)} \cup \mathcal{G}_2^{(k)}$ ;

solve  $\mathbf{P}_r$  with input  $(\mathcal{G}_2^{(k)}, (w^l)^{(k)}, (w^u)^{(k)}, (c^l)^{(k)}, (c^u)^{(k)}, v_1^{(k)}, v_2^{(k)})$  and obtain output

$\left( (w_{v_1^{(k)} v_2^{(k)}}^l)^{(k+1)}, (w_{v_1^{(k)} v_2^{(k)}}^u)^{(k+1)}, (c_{v_1^{(k)} v_2^{(k)}}^l)^{(k+1)}, (c_{v_1^{(k)} v_2^{(k)}}^u)^{(k+1)} \right)$  ;

$\mathcal{E}^{(k+1)} = \mathcal{E}_1^{(k)} \cup (v_1^{(k)}, v_2^{(k)})$ ,  $\mathcal{G}^{(k+1)} = (\mathcal{V}_1^{(k)}, \mathcal{E}^{(k+1)})$ ,  $(w_i^s)^{(k+1)} = (w_i^s)^{(k)}$ ,  $(c_i^s)^{(k+1)} = (c_i^s)^{(k)}$  for all

$i \in \mathcal{E}^{(k)}$  and  $s \in \{l, u\}$  ;

$k = k + 1$ ;

**end**

solve  $\mathbf{P}$  and obtain  $\nu^*(\mathcal{G}) = \nu^* \left( \mathcal{G}^{(k)}, (w_{\mathcal{E}^{(k)}}^l)^{(k)}, (w_{\mathcal{E}^{(k)}}^u)^{(k)}, (c_{\mathcal{E}^{(k)}}^l)^{(k)}, (c_{\mathcal{E}^{(k)}}^u)^{(k)}, p_0 \right)$  ;

**return**  $\nu^*(\mathcal{G})$

---

through which the undirected graph  $\mathcal{G}^u = (\mathcal{V}, \mathcal{E}^u)$  corresponding to  $\mathcal{G}$  can be reduced to a tree<sup>5</sup>:

- 1) Degree-one reduction: delete a degree<sup>6</sup> one vertex with  $p_v = 0$  and its incident edge.
- 2) Series reduction: delete a degree two vertex  $v_2$  and its two incident edges  $\{v_1, v_2\}$  and  $\{v_2, v_3\}$ , and add a new edge  $\{v_1, v_3\}$ .
- 3) Parallel reduction: if a node pair has multiple, i.e., two or more, links between them, then remove one of those links.

In particular, if the terminal network produced from the above three reduction operations contains only one link, then we call the original network  $\mathcal{G}$  link reducible.

Same as the definition of reducible network (cf. Definition 4 and Remark 4), the definition of a tree reducible network involves conditions on the graph topology as well as the locations of supply and demands nodes. For example, a network consisting of the graph in Fig. 6 is tree reducible if the supply and demand nodes only include  $v_1$  and  $v_4$ , while it is not tree reducible if  $v_1$  and  $v_2$  are the supply nodes and  $v_4$  is the demand node.

It is straightforward to see, e.g., as in Remark 3, that, for a network with tree topology, the link flows are independent of link weights. The next result shows that, for a tree reducible network, the link flow *directions* are independent of link weights.

<sup>5</sup>An undirected graph is called a tree if any two nodes are connected by at most one path.

<sup>6</sup>In an undirected graph, degree of a node is equal to the number of links incident on it.

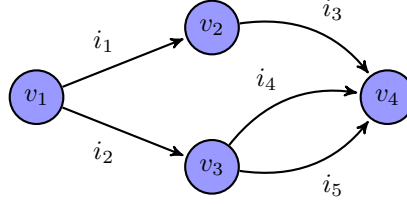

Fig. 6: A candidate graph topology for tree reducible network

**Lemma 8.** For a tree reducible network consisting of directed multigraph  $\mathcal{G} = (\mathcal{V}, \mathcal{E})$  and supply-demand vector  $p \in \mathbb{R}^{\mathcal{V}}$ ,

$$\mathbf{sign}(f_i(w, p)) = \mathbf{sign}(f_i(\tilde{w}, p)) \quad \forall i \in \mathcal{E}, w, \tilde{w} \in \mathbb{R}_{>0}^{\mathcal{E}}$$

*Proof:* It is clear that the above result holds for a tree, as a special case of tree reducible networks. For a general tree reducible network, the result follows from invariance of flow direction in the three operations in the definition of tree reducible networks. In degree-one reduction, the link removed has flow equal zero. In series reduction,  $\mathbf{sign}(f_{v_1 v_2}(w, p)) = \mathbf{sign}(f_{v_2 v_3}(w, p)) = \mathbf{sign}(f_{v_1 v_3}(w, p))$  for all  $w > 0$ . In parallel reduction, the removed link has the same direction of flow as the remaining links. ■

**Remark 13.** Lemma 8 implies that, for a tree reducible network with a given supply-demand vector  $p \in \mathbb{R}^{\mathcal{V}}$ , one can choose direction convention for links such that  $f(w, p) \geq 0$  for all  $w > 0$ . We implicitly adopt this convention for the rest of this section<sup>7</sup>.

Recall from Section V-C that a reduction problem in the multilevel formulation is (an equality constrained) weight control problem for a subnetwork of the original network. Since the original network is assumed to be tree reducible, this subnetwork is link reducible. Therefore, Remark 13 implies that the reduction problem for the network, *i.e.*, a problem of the kind (43), can be simplified as

$$\begin{aligned} \mathcal{C}^l(w_{\text{eq}}) = \min_{z \in \mathbb{R}, w \in \mathbb{R}^{\mathcal{E}}} z & & \mathcal{C}^u(w_{\text{eq}}) = \max_{z \in \mathbb{R}, w \in \mathbb{R}^{\mathcal{E}}} z \\ \text{subject to } w^l \leq w \leq w^u & & \text{subject to } w^l \leq w \leq w^u \\ \mathcal{H}(w, \mathcal{G}, v_1, v_2) = w_{\text{eq}} & & \mathcal{H}(w, \mathcal{G}, v_1, v_2) = w_{\text{eq}} \\ z f(w, a_{v_1 v_2}) \geq c^l & & z f(w, a_{v_1 v_2}) \leq c^u \end{aligned} \quad (44)$$

where  $\mathcal{G} = (\mathcal{V}, \mathcal{E})$  is the network's underlying graph and  $w_{\text{eq}} \in \mathcal{R}(\mathcal{H}(w, \mathcal{G}, v_1, v_2))$ . By setting  $z' := -z$  in the problem for  $\mathcal{C}^l(w_{\text{eq}})$ , it is straightforward to see that it is the same problem as that for  $\mathcal{C}^u(w_{\text{eq}})$ . Setting  $c := -c^l$

<sup>7</sup>We emphasize that the lower and upper capacities  $c^l$  and  $c^u$ , respectively, are defined with respect to chosen direction convention.



for  $\mathcal{C}^l(w_{\text{eq}})$ , and  $c := c^u$  for  $\mathcal{C}^u(w_{\text{eq}})$ , the two problem instances in (44) can be uniformly written as follows.

$$\begin{aligned}
\mathcal{C}(w_{\text{eq}}) &= \max_{z \in \mathbb{R}, w \in \mathbb{R}^{\mathcal{E}}} z \\
\text{subject to} & \quad w_i^l \leq w \leq w_i^u \\
& \quad z \leq \frac{c_i(w_i)}{f_i(w, a_{v_1} v_2)} \quad \forall i \in \mathcal{E} \\
& \quad \mathcal{H}(w, \mathcal{G}, v_1, v_2) = w_{\text{eq}}
\end{aligned} \tag{45}$$

We begin by focusing on solving the following *simplified version of the reduction problem* (45):

$$\begin{aligned}
g(w_{\text{eq}}) &= \max_{\alpha \in \mathbb{R}, w \in \mathbb{R}^{\mathcal{E}}} \alpha \\
\text{subject to} & \quad w_i^l \leq w_i \leq w_i^u \quad \forall i \in \mathcal{E} \\
& \quad \alpha \leq \psi_i(w_i) \quad \forall i \in \mathcal{E} \\
& \quad \mathcal{H}(w, \mathcal{G}, v_1, v_2) = w_{\text{eq}}
\end{aligned} \tag{46}$$

for given  $w_{\text{eq}} \in \mathcal{R}(\mathcal{H}(w, \mathcal{G}, v_1, v_2))$  and functions  $\psi_i : \mathbb{R}_{>0} \rightarrow \mathbb{R}_{>0}$ ,  $i \in \mathcal{E}$ , representing the second set of inequalities in (45). Note that the second set of inequalities in (46) are separable across links, whereas they are not in (45). This *simplification* will be shown to be lossless. We shall then devise a methodology that sequentially uses solution to (46) for parallel and serial networks, to obtain an iterative scheme to solve (45).

### B. Input-output Properties of the Simplified Version of the Reduction Problem

In order to develop the sequential procedure, we interpret (46) to be defining an *output* function  $g(w_{\text{eq}})$  with link level functions  $\psi_i(w_i)$ ,  $i \in \mathcal{E}$  as *input*. We next introduce a property which will be shown to be invariant from the input functions to the output function, and will be helpful to compute the function  $g(w_{\text{eq}})$  specified by (46).

**Definition 8** ( $\mathcal{S}_0$  function). *A function  $\psi : [x^l, x^u] \subset \mathbb{R} \rightarrow \mathbb{R}$  is called a  $\mathcal{S}_0$  function if it is continuous, and there exist  $\underline{x} \in [x^l, x^u]$  and  $\bar{x} \in [x^l, x^u]$  such that  $\psi(x)$  is strictly increasing over  $[x^l, \underline{x}]$ , constant over  $[\underline{x}, \bar{x}]$ , and strictly decreasing over  $[\bar{x}, x^u]$ . We shall sometimes refer to  $\underline{x}$  and  $\bar{x}$  as first and second transition points (w.r.t.  $\mathcal{S}_0$  property), respectively, of  $\psi(x)$ .*

Figure 7 provides an example of a  $\mathcal{S}_0$  function. It is easy to see that a  $\mathcal{S}_0$  function is also quasiconcave, but the converse is not true in general.

**Proposition 8.** *Consider a network consisting of graph topology  $\mathcal{G} = (\mathcal{V}, \mathcal{E})$ , lower and upper bounds on link weights  $w^l \in \mathbb{R}_{>0}^{\mathcal{E}}$  and  $w^u \in \mathbb{R}_{>0}^{\mathcal{E}}$  respectively and supply and demand node  $v_1, v_2 \in \mathcal{V}$  respectively. If the equivalent weight function  $\mathcal{H}(w, \mathcal{G}, v_1, v_2)$  is strictly monotone with respect to  $w$  for this network, and  $\psi_i(w_i)$  is a  $\mathcal{S}_0$  function for all  $i \in \mathcal{E}$ , then the  $g(w_{\text{eq}})$  function defined by (46) is also a  $\mathcal{S}_0$  function.*

*Proof:* In general,  $\mathcal{H}(w)$  is not one-to-one, i.e., there could exist  $\tilde{w}, \tilde{\tilde{w}} \in [w^l, w^u]$ ,  $\tilde{w} \neq \tilde{\tilde{w}}$ , such that  $\mathcal{H}(\tilde{w}) = \mathcal{H}(\tilde{\tilde{w}})$ . However, the strict monotonicity of  $\mathcal{H}(w)$  implies that the only feasible points of (46) for  $w_{\text{eq}}^l := \mathcal{H}(w^l)$  and

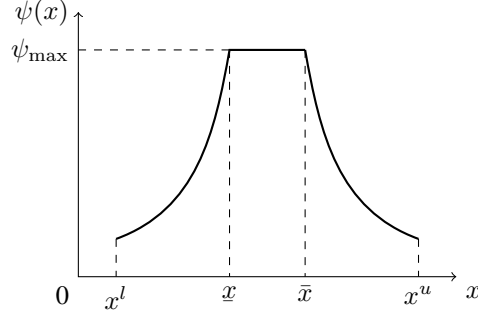

Fig. 7: A sample  $\mathcal{S}_0$  function.

$w_{\text{eq}}^u := \mathcal{H}(w^u)$  are  $(\min_{i \in \mathcal{E}} \psi_i(w_i^l), w^l)$  and  $(\min_{i \in \mathcal{E}} \psi_i(w_i^u), w^u)$  respectively, and that  $w_{\text{eq}} \in [w_{\text{eq}}^l, w_{\text{eq}}^u]$  for all  $w \in [w^l, w^u]$ . Hence  $g(w_{\text{eq}}^l) = \min_{i \in \mathcal{E}} \psi_i(w_i^l)$  and  $g(w_{\text{eq}}^u) = \min_{i \in \mathcal{E}} \psi_i(w_i^u)$ . Let  $g_{\text{max}} := \max_{w_{\text{eq}} \in [w_{\text{eq}}^l, w_{\text{eq}}^u]} g(w_{\text{eq}})$ , then  $g(w_{\text{eq}}^l) =: g^l \leq g_{\text{max}}$  and  $g(w_{\text{eq}}^u) =: g^u \leq g_{\text{max}}$ . Motivated by this, and with the objective of ultimately proving  $\mathcal{S}_0$  property of  $g(w_{\text{eq}})$ , we construct inverse functions of  $g(w_{\text{eq}})$  over  $[g^l, g_{\text{max}}]$  and  $[g^u, g_{\text{max}}]$ . We denote these inverse functions as  $\hat{g}^+ : [g^l, g_{\text{max}}] \rightarrow [w_{\text{eq}}^l, w_{\text{eq}}^u]$  and  $\hat{g}^- : [g^u, g_{\text{max}}] \rightarrow [w_{\text{eq}}^l, w_{\text{eq}}^u]$ , respectively. We construct these inverses as compositions:

$$\hat{g}^+(x) = \mathcal{H} \circ \omega^+(x) \quad \hat{g}^-(x) = \mathcal{H} \circ \omega^-(x) \quad (47)$$

where  $\mathcal{H}$  is the equivalent weight function from (39), and  $\omega^+ : [g^l, g_{\text{max}}] \rightarrow [w^l, w^u]$  and  $\omega^- : [g^u, g_{\text{max}}] \rightarrow [w^l, w^u]$  are defined as: for all  $i \in \mathcal{E}$ ,

$$\omega_i^+(x) := \begin{cases} w_i^l & \text{if } x \leq \psi_i(w_i^l) \\ \min\{w_i : \psi_i(w_i) = x\} & \text{if } x > \psi_i(w_i^l) \end{cases} \quad (48)$$

$$\omega_i^-(x) := \begin{cases} w_i^u & \text{if } x \leq \psi_i(w_i^u) \\ \max\{w_i : \psi_i(w_i) = x\} & \text{if } x > \psi_i(w_i^u) \end{cases}$$

It is easy to see that

$$g_{\text{max}} = \min_{i \in \mathcal{E}} \max_{w_i \in [w_i^l, w_i^u]} \psi_i(w_i) \quad (49)$$

Combining (49) with the fact that  $\psi_i$  is a  $\mathcal{S}_0$  function for all  $i \in \mathcal{E}$ , the definitions in (48) imply that, for all  $i \in \mathcal{E}$ ,

$$\omega_i^+(x) \in [w_i^l, w_i] \subseteq [w_i^l, w_i^u] \quad \& \quad x \leq \psi_i(\omega_i^+(x)), \quad \forall x \in [g^l, g_{\text{max}}] \quad (50)$$

$$\omega_i^-(x) \in [\bar{w}_i, w_i^u] \subseteq [w_i^l, w_i^u] \quad \& \quad x \leq \psi_i(\omega_i^-(x)), \quad \forall x \in [g^u, g_{\text{max}}]$$

where we refer to Definition 8 for notations  $\underline{w}$  and  $\bar{w}$ . Moreover, since  $\psi_i(w_i) \in \mathcal{S}_0$ , for all  $i \in \mathcal{E}$ ,  $\omega_i^+$  is nondecreasing and  $\omega_i^-$  is nonincreasing, and, it is easy to see that, for every  $x \in [g^l, g_{\text{max}}]$ , there exists at least one  $i \in \mathcal{E}$  such that  $\omega_i^+(x)$  is strictly increasing, and that, for every  $x \in [g^u, g_{\text{max}}]$ , there exists at least one  $i \in \mathcal{E}$  such that  $\omega_i^-(x)$  is strictly decreasing. This combined with the strictly increasing property of  $\mathcal{H}(w)$  implies that  $\hat{g}^+ : [g^l, g_{\text{max}}] \rightarrow [w_{\text{eq}}^l, w_{\text{eq}}^u]$  and  $\hat{g}^- : [g^u, g_{\text{max}}] \rightarrow [w_{\text{eq}}^l, w_{\text{eq}}^u]$  are strictly increasing and strictly decreasing

bijections, respectively. Moreover, it is easy to see that  $w_{\text{eq}}^l \leq \hat{g}^+(g_{\text{max}}) \leq \hat{g}^-(g_{\text{max}}) \leq w_{\text{eq}}^u$ , where the middle inequality follows from (47), (48), and the strict monotonicity of  $\mathcal{H}$ .

In the remainder of the proof, our strategy for proving that  $g(w_{\text{eq}})$  is a  $\mathcal{S}_0$  function is as follows: we show that (i)  $\hat{g}^+$  is the inverse of  $g(w_{\text{eq}})$  over  $w_{\text{eq}} \in [w_{\text{eq}}^l, \hat{g}^+(g_{\text{max}})]$ , (ii)  $\hat{g}^-$  is the inverse of  $g(w_{\text{eq}})$  over  $w_{\text{eq}} \in [\hat{g}^-(g_{\text{max}}), w_{\text{eq}}^u]$ , and (iii)  $g(w_{\text{eq}}) \equiv g_{\text{max}}$  over  $w_{\text{eq}} \in [\hat{g}^+(g_{\text{max}}), \hat{g}^-(g_{\text{max}})]$ . In particular,  $\hat{g}^+(g_{\text{max}})$  and  $\hat{g}^-(g_{\text{max}})$  will play the role of  $\underline{x}$  and  $\bar{x}$  (cf. Definition 8) in proving that  $g(w_{\text{eq}})$  is a  $\mathcal{S}_0$  function. The proof for (i) and (ii) are similar, and hence we provide details only for (i).

In order to show that  $\hat{g}^+$  is the inverse of  $g(w_{\text{eq}})$  over  $w_{\text{eq}} \in [w_{\text{eq}}^l, \hat{g}^+(g_{\text{max}})]$ , we show that  $g(\hat{g}^+(x)) = x$  for all  $x \in [g^l, g_{\text{max}}]$ . In order to show this, we show that, for all  $x \in [g^l, g_{\text{max}}]$ ,  $(x, \omega^+(x))$  is the unique optimizer for (46) corresponding to  $w_{\text{eq}} = \hat{g}^+(x)$ . (47) and (50) readily imply that  $(x, \omega^+(x))$  is feasible for (46). Therefore, for all  $x \in [g^l, g_{\text{max}}]$ ,

$$g(\hat{g}^+(x)) \geq x \quad (51)$$

Consider an arbitrary  $\tilde{w} \in [w^l, w^u]$  such that  $\tilde{w} \neq \omega^+(x)$  and  $\mathcal{H}(\tilde{w}) = \hat{g}^+(x) = \mathcal{H}(\omega^+(x))$ . It is sufficient to show that  $\tilde{\alpha} < x$  for all  $\tilde{\alpha}$  such that  $(\tilde{\alpha}, \tilde{w})$  is feasible to (46). For  $x = g^l$ , by definition  $\omega^+(x) = w^l$  and  $\mathcal{H}(\omega^+(x)) = w_{\text{eq}}^l$ . Strict monotonicity of  $\mathcal{H}$  implies that  $(x, \omega^+(x))$  is the only feasible point and hence the unique optimizer of (46). For all  $x \in (g^l, g_{\text{max}}]$ <sup>8</sup>, it is clear from the definition of  $g^l$  and  $g_{\text{max}}$  that the set  $\{i \in \mathcal{E} \mid x > \psi_i(w_i^l)\}$  is not empty. Since  $\tilde{w}_k \geq w_k^l = w_k^+(x)$  for all  $k \in \{i \in \mathcal{E} \mid x \leq \psi_i\}$ , if  $\tilde{w}_k \geq \omega^+(x)$  for all  $k \in \{i \in \mathcal{E} \mid x > \psi_i(w_i^l)\}$ , strict monotonicity of  $\mathcal{H}$  implies  $\mathcal{H}(\tilde{w}) > \mathcal{H}(\omega^+(x))$ . That is to say, in order to satisfy  $\mathcal{H}(\tilde{w}) = \mathcal{H}(\omega^+(x))$  and  $\tilde{w} \neq \omega^+(x)$ , there is at least one  $k \in \{i \in \mathcal{E} \mid x > \psi_i(w_i^l)\}$  such that  $\tilde{w}_k < \omega_k^+(x) \leq w_k$ . Using this along with the fact that  $\psi_k$  is a  $\mathcal{S}_0$  function, and hence  $\psi_k$  is strictly increasing in  $[w_k^l, w_k]$ , we get  $\psi_k(\tilde{w}_k) < \psi_k(\omega_k^+(x)) = x$ , where the equality is due to the implication of  $\psi_k(w_k^l) < x$  in (48). Therefore, the last inequality constraint in (46) implies that  $\tilde{\alpha} < x$  for all feasible  $\tilde{\alpha}$ . In other words,  $(g(w_{\text{eq}}), \omega^+(g(w_{\text{eq}})))$  is the unique solution to (46) for all  $w_{\text{eq}} \in [w_{\text{eq}}^l, \hat{g}^+(g_{\text{max}})]$ . Similar result is true for  $w_{\text{eq}} \in [\hat{g}^-(g_{\text{max}}), w_{\text{eq}}^u]$ .

Recall that  $g_{\text{max}}$  is the maximum value of  $g(w_{\text{eq}})$  over all  $w_{\text{eq}}$ . Therefore, in order to show that  $g(w_{\text{eq}}) \equiv g_{\text{max}}$  for all  $w_{\text{eq}} \in [\hat{g}^+(g_{\text{max}}), \hat{g}^-(g_{\text{max}})]$ , it suffices to show that, for every  $w_{\text{eq}} \in [\hat{g}^+(g_{\text{max}}), \hat{g}^-(g_{\text{max}})]$ , there exists a  $\tilde{w} \in [w^l, w^u]$  such that  $(g_{\text{max}}, \tilde{w})$  is feasible for (46). Since, by definition in (47),  $\mathcal{H}(\omega^+(g_{\text{max}})) = \hat{g}^+(g_{\text{max}})$  and  $\mathcal{H}(\omega^-(g_{\text{max}})) = \hat{g}^-(g_{\text{max}})$ , continuity and monotonicity of  $\mathcal{H}$  implies that, for all  $w_{\text{eq}} \in [\hat{g}^+(g_{\text{max}}), \hat{g}^-(g_{\text{max}})]$ , there exists  $\tilde{w} \in [\omega^+(g_{\text{max}}), \omega^-(g_{\text{max}})]$  satisfying  $\mathcal{H}(\tilde{w}) = w_{\text{eq}}$ . Moreover, the  $\mathcal{S}_0$  property of  $\psi_i$  implies that  $g_{\text{max}} \leq \psi_i(w_i)$  for all  $w_i \in [\omega_i^+(g_{\text{max}}), \omega_i^-(g_{\text{max}})]$ . This shows that  $(g_{\text{max}}, \tilde{w})$  is feasible for (46).

Finally, the continuity of  $g(w_{\text{eq}})$  follows from the continuity of the inverse functions  $\hat{g}^+$  and  $\hat{g}^-$ , which in turn follows from the continuity of  $\mathcal{H}$  from (39), and continuity of  $\omega^+$  and  $\omega^-$  from (48) implied by the continuity of  $\psi_i$ 's being  $\mathcal{S}_0$  functions. ■

The solution to (46) is not unique in general for an arbitrary  $w_{\text{eq}}$ . However, it is unique for  $w_{\text{eq}}$  within a certain range, as shown in the above proof and summarized in Remark 14.

<sup>8</sup> It is possible that  $g_{\text{max}} = g^l$ . In this case, considering the case  $x = g^l$  is sufficient.

**Remark 14.**

- (a) (46) has unique solution  $(g(w_{\text{eq}}), \omega^+(g(w_{\text{eq}})))$  and  $(g(w_{\text{eq}}), \omega^-(g(w_{\text{eq}})))$  for any  $w_{\text{eq}} \in [w_{\text{eq}}^l, \hat{g}^+(g_{\text{max}})]$  and  $w_{\text{eq}} \in [\hat{g}^-(g_{\text{max}}), w_{\text{eq}}^u]$ , respectively.
- (b)  $\omega^+(g(w_{\text{eq}}))$  is nondecreasing w.r.t.  $w_{\text{eq}}$  for  $w_{\text{eq}} \in [w_{\text{eq}}^l, \hat{g}^+(g_{\text{max}})]$ , since by definition  $\omega^+$  is nondecreasing function and  $\mathcal{S}_0$  property of  $g(w_{\text{eq}})$  implies that  $g(w_{\text{eq}})$  is strictly increasing for  $w_{\text{eq}} \in [w_{\text{eq}}^l, \hat{g}^+(g_{\text{max}})]$ .  $\omega^-(g(w_{\text{eq}}))$  is nondecreasing w.r.t.  $w_{\text{eq}}$  for  $w_{\text{eq}} \in [\hat{g}^-(g_{\text{max}}), w_{\text{eq}}^u]$  due to similar reason.

The proof of Proposition 8 implies that the solution to (46) is given by:

$$g(w_{\text{eq}}) = \begin{cases} \mathbf{inv} \hat{g}^+(w_{\text{eq}}) & w_{\text{eq}}^l \leq w_{\text{eq}} < \hat{g}^+(g_{\text{max}}) \\ g_{\text{max}} & \hat{g}^+(g_{\text{max}}) \leq w_{\text{eq}} \leq \hat{g}^-(g_{\text{max}}) \\ \mathbf{inv} \hat{g}^-(w_{\text{eq}}) & \hat{g}^-(g_{\text{max}}) < w_{\text{eq}} \leq w_{\text{eq}}^u \end{cases} \quad (52)$$

where  $\mathbf{inv} \hat{g}^+$  and  $\mathbf{inv} \hat{g}^-$  are the inverses of  $\hat{g}^+$  and  $\hat{g}^-$ , respectively, as defined in (47),  $g_{\text{max}}$  is defined in (49).

Proposition 8 implies that  $g$  is continuous. However, it may not be differentiable in general. Let

$$g'(w_{\text{eq}}^-) := \lim_{\Delta w_{\text{eq}} \uparrow 0} \frac{g(w_{\text{eq}} + \Delta w_{\text{eq}}) - g(w_{\text{eq}})}{\Delta w_{\text{eq}}}, \quad g'(w_{\text{eq}}^+) := \lim_{\Delta w_{\text{eq}} \downarrow 0} \frac{g(w_{\text{eq}} + \Delta w_{\text{eq}}) - g(w_{\text{eq}})}{\Delta w_{\text{eq}}} \quad (53)$$

be the left and right derivatives, respectively. We provide derivation for explicit expressions of these derivatives in the appendix. These expressions are used in Sections VI-C and VI-D to provide an explicit solution for series and parallel networks.

**C. Series Networks**

In a series network,  $|\mathcal{V}| = |\mathcal{E}| + 1$ . A series network consisting of three links is shown in Fig. 8.

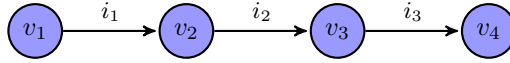

Fig. 8: A three link series network

Consider a series network with  $n+1$  nodes numbered  $v_1, \dots, v_{n+1}$  such that  $(v_j, v_{j+1}) \in \mathcal{E}$  for all  $j \in \{1, \dots, n\}$ , and link weights  $w \in \mathbb{R}_{>0}^n$ . As already shown in Example 3, the equivalent weight function between  $v_1$  and  $v_{n+1}$  is given by  $\mathcal{H}(w) = \sum_{i=1}^n (1/w_i)^{-1}$ . Moreover, the flow on any link  $i \in \{1, \dots, n\}$  is equal to one when a unit flow enters at node  $v_1$  and leaves at  $v_{n+1}$ , i.e.,  $f_i(w, a_{v_1 v_n}) = 1$ . Therefore, (45) can be simplified for a series network as (54), which gives the equivalent capacity function between nodes  $v_1$  and  $v_{n+1}$ .

$$\begin{aligned} \mathcal{C}(w_{\text{eq}}) &= \max_{z \in \mathbb{R}, w \in \mathbb{R}_{>0}^n} z \\ \text{subject to} \quad & w_i^l \leq w_i \leq w_i^u \\ & z \leq c_i(w_i), \quad i \in \{1, \dots, n\} \\ & \left( \sum_{i=1}^n \frac{1}{w_i} \right)^{-1} = w_{\text{eq}} \end{aligned} \quad (54)$$

For constant link capacities, i.e.,  $c_i(w_i) \equiv c_i$ ,  $i \in \mathcal{E}$ , then it is easily to see that  $\mathcal{C}(w_{\text{eq}}) = \min_{i \in \{1, \dots, n\}} c_i$ . For weight-dependent capacities, we now establish a functional property of  $\mathcal{C}(w_{\text{eq}})$ , which is a stronger version of the  $\mathcal{S}_0$  property defined in Definition 8.

**Definition 9.** A function  $\psi : [x^l, x^u] \subset \mathbb{R}_{>0} \rightarrow \mathbb{R}$  is called a  $\mathcal{S}_1$  function if it is a  $\mathcal{S}_0$  function (cf. Definition 8), and if there exists a  $x^o \in [x^l, \underline{x}]$  such that  $\min \partial\psi(x) > \psi(x)/x$  for all  $x \in [x^l, x^o]$  and  $\min \partial\psi(x) = \psi(x)/x$  for all  $x \in [x^o, \underline{x}]$ , where  $\underline{x}$  is the first transition point, w.r.t.  $\mathcal{S}_0$  property,  $\partial\psi(x)$  denotes the set of subgradients of  $\psi(x)$ . We shall sometimes refer to  $x^o$  and  $\underline{x}$  as first and second transition points (w.r.t.  $\mathcal{S}_1$  property), respectively, of  $\psi(x)$ .

**Remark 15.** Note that, in Definition 9, we allow  $x^o = \underline{x}$ , in which case, the only requirement for a  $\mathcal{S}_0$  function to be  $\mathcal{S}_1$  is that  $\min \partial\psi(x) > \psi(x)/x$  for all  $x \in [x^l, \underline{x}]$ .

Definition 9 clearly implies that, if  $\psi(x)$  is a  $\mathcal{S}_1$  function, then it is also a  $\mathcal{S}_0$  function. The next result extends the  $\mathcal{S}_0$  implication also to  $\psi(x)/x$ .

**Lemma 9.** If  $\psi : [x^l, x^u] \subset \mathbb{R}_{>0} \rightarrow \mathbb{R}_{>0}$  is a  $\mathcal{S}_1$  function, then  $\psi(x)/x : [x^l, x^u] \subset \mathbb{R}_{>0} \rightarrow \mathbb{R}_{>0}$  is a  $\mathcal{S}_0$  function.

*Proof:* Let  $\tilde{\psi}(x) := \psi(x)/x$ . The continuity of  $\tilde{\psi}(x)$  follows from that of  $\psi(x)$ . Then, the left and right derivative of  $\tilde{\psi}(x)$  are, respectively, given by:

$$\tilde{\psi}'(x^-) = \frac{\psi'(x^-)x - \psi(x)}{x^2}, \quad \tilde{\psi}'(x^+) = \frac{\psi'(x^+)x - \psi(x)}{x^2} \quad (55)$$

Note that these two derivatives completely specify the set of subgradients of  $\tilde{\psi}(x)$ . Since  $\psi(x)$  is a  $\mathcal{S}_1$  function, we have  $\min \partial\psi(x) > \psi(x)/x$  for all  $x \in [x^l, x^o]$ . Therefore, (55) implies that  $\tilde{\psi}'(x^-)$  and  $\tilde{\psi}'(x^+)$  are both strictly positive, and hence  $\tilde{\psi}(x)$  is strictly increasing over  $[x^l, x^o]$ . For  $x \in (x^o, \underline{x})$ , (55) implies that  $\tilde{\psi}'(x^-) = \tilde{\psi}'(x^+) = 0$ , i.e.,  $\tilde{\psi}(x)$  is constant. Since  $\psi(x)$  is also a  $\mathcal{S}_0$  function,  $\psi'(x^-)$  and  $\psi'(x^+)$  are both nonpositive for  $x \in (\underline{x}, x^u]$ . Therefore, (55) implies that  $\tilde{\psi}'(x^-)$  and  $\tilde{\psi}'(x^+)$  are both strictly negative, and hence  $\tilde{\psi}(x)$  is strictly decreasing over  $(\underline{x}, x^u]$ . Collecting these facts, we establish that  $\tilde{\psi}(x)$  is a  $\mathcal{S}_0$  function. We conclude the proof by emphasizing that the transition points required for the  $\mathcal{S}_0$  property of the  $\tilde{\psi}$  function are the points corresponding to  $x^o$  and  $\underline{x}$  used in specifying the  $\mathcal{S}_1$  property of  $\psi$  (cf. Definition 9). ■

**Remark 16.** The proof of Lemma 9 implies that the first and second transition points, w.r.t.  $\mathcal{S}_1$  property, of  $\psi(x)$  i.e.,  $x^o$  and  $\underline{x}$ , are the first and second transition points, w.r.t.  $\mathcal{S}_0$  property, of  $\psi(x)/x$ , respectively.

**Lemma 10.** Consider a network consisting of series graph topology  $\mathcal{G} = (\mathcal{V}, \mathcal{E})$ , where  $\mathcal{V} = \{v_1, \dots, v_{n+1}\}$  and  $\mathcal{E} = \{(v_1, v_2), \dots, (v_n, v_{n+1})\}$ , and lower and upper bounds on link weights  $w^l \in \mathbb{R}_{>0}^n$  and  $w^u \in \mathbb{R}_{>0}^n$  respectively. If the link capacity functions  $c_i(w_i)$  are  $\mathcal{S}_1$  for all  $i \in \{1, \dots, n\}$ , then the equivalent capacity function between  $v_1$  and  $v_{n+1}$ , as given by (54), is also a  $\mathcal{S}_1$  function.

*Proof:* Since  $c_i$  are  $\mathcal{S}_1$  functions for all  $i \in \{1, \dots, n\}$ , by definition, they are also  $\mathcal{S}_0$  functions. Therefore,

Proposition 8 implies that  $\mathcal{C}(w_{\text{eq}})$ , as given by (54), is also a  $\mathcal{S}_0$  function. In order to prove that  $\mathcal{C}(w_{\text{eq}})$  is a  $\mathcal{S}_1$  function, we need to show that there exists  $w_{\text{eq}}^o \in [w_{\text{eq}}^l, w_{\text{eq}}]$  such that  $\min \partial \mathcal{C}(w_{\text{eq}}) > \mathcal{C}(w_{\text{eq}})/w_{\text{eq}}$  for  $w_{\text{eq}} \in [w_{\text{eq}}^l, w_{\text{eq}}^o]$  and  $\min \partial \mathcal{C}(w_{\text{eq}}) = \mathcal{C}(w_{\text{eq}})/w_{\text{eq}}$  for  $w_{\text{eq}} \in [w_{\text{eq}}^o, w_{\text{eq}}]$ .

We now show that there exist  $w_{\text{eq}}^o \in [w_{\text{eq}}^l, w_{\text{eq}}]$  such that  $\mathcal{C}'(w_{\text{eq}}^+) > \mathcal{C}(w_{\text{eq}})/w_{\text{eq}}$  for  $w_{\text{eq}} \in [w_{\text{eq}}^l, w_{\text{eq}}^o]$  and  $\mathcal{C}'(w_{\text{eq}}^+) = \mathcal{C}(w_{\text{eq}})/w_{\text{eq}}$  for  $w_{\text{eq}} \in [w_{\text{eq}}^o, w_{\text{eq}}]$ . Similar results hold true for  $\mathcal{C}'(w_{\text{eq}}^-)$ . Since  $\min \partial \mathcal{C}(w_{\text{eq}}) = \min\{\mathcal{C}'(w_{\text{eq}}^-), \mathcal{C}'(w_{\text{eq}}^+)\}$ , this then completes the proof.

Noting the expression for the equivalent weight function in (54), we get that

$$\frac{\partial \mathcal{H}(w)}{\partial w_i} = \frac{1}{w_i^2} \left( \sum_{i=1}^n \frac{1}{w_i} \right)^{-2} = \frac{w_{\text{eq}}^2}{w_i^2}.$$

Substituting into (91), we get

$$\begin{aligned} \mathcal{C}'(w_{\text{eq}}^+) &= \left( \sum_{i \in \tilde{\mathcal{K}}^+(\mathcal{C}(w_{\text{eq}}))} \frac{w_{\text{eq}}^2}{c'_i(w_i^+) w_i^2} \right)^{-1} \Big|_{w=\omega^+(\mathcal{C}(w_{\text{eq}}))} \geq \frac{\mathcal{C}(w_{\text{eq}})}{w_{\text{eq}}^2} \left( \sum_{i \in \tilde{\mathcal{K}}^+(\mathcal{C}(w_{\text{eq}}))} \frac{1}{w_i} \right)^{-1} \Big|_{w=\omega^+(\mathcal{C}(w_{\text{eq}}))} \\ &\geq \frac{\mathcal{C}(w_{\text{eq}})}{w_{\text{eq}}^2} \left( \frac{1}{w_{\text{eq}}} \right)^{-1} = \frac{\mathcal{C}(w_{\text{eq}})}{w_{\text{eq}}} \end{aligned}$$

where the first inequality follows from the fact that, since  $c_i(w_i) \in \mathcal{S}_1$ ,  $c'_i(w_i^+) w_i \geq \min \partial c_i(w_i) w_i \geq c_i(w_i)$ , and by definition,  $c_i(\omega_i^+(\mathcal{C}(w_{\text{eq}}))) = \mathcal{C}(w_{\text{eq}})$  for all  $i \in \tilde{\mathcal{K}}^+(\mathcal{C}(w_{\text{eq}}))$ , and it is equality if and only if  $\omega_i(\mathcal{C}(w_{\text{eq}})) \geq w_i^o$  for all  $i \in \tilde{\mathcal{K}}^+(\mathcal{C}(w_{\text{eq}}))$ . The second inequality is equality if and only if  $\tilde{\mathcal{K}}^+(\mathcal{C}(w_{\text{eq}})) = \mathcal{E}$ . If for some  $\tilde{w}_{\text{eq}} \in [w_{\text{eq}}^l, w_{\text{eq}}]$ , both inequalities are equalities, *i.e.*,  $\omega_i(\mathcal{C}(w_{\text{eq}})) \geq w_i^o$  for all  $i \in \mathcal{E}$  and  $\tilde{\mathcal{K}}^+(\mathcal{C}(w_{\text{eq}})) = \mathcal{E}$ , then  $\mathcal{C}'(w_{\text{eq}}^+) = \mathcal{C}(w_{\text{eq}})/w_{\text{eq}}$  holds for all  $w_{\text{eq}} \in [\tilde{w}_{\text{eq}}, w_{\text{eq}}]$ . This is because of the nondecreasing property of function  $\omega(\mathcal{C}(\cdot))$  (cf. Remark 14(b)) and  $\tilde{\mathcal{K}}^+(\mathcal{C}(\cdot))$  (by definition). Therefore, there exists  $w_{\text{eq}}^o \in [w_{\text{eq}}^l, w_{\text{eq}}]$  such that the both the inequalities are strict for  $w_{\text{eq}} \in [w_{\text{eq}}^l, w_{\text{eq}}^o]$  and is equality for  $w_{\text{eq}} \in [w_{\text{eq}}^o, w_{\text{eq}}]$ . ■

#### D. Parallel Networks

We now focus on networks with parallel graph topology, *i.e.*, when  $\mathcal{G} = (\mathcal{V}, \mathcal{E})$ , where  $\mathcal{V} = \{v_1, v_2\}$ , and all the links in  $\mathcal{E}$  are from  $v_1$  to  $v_2$ . An example is shown in Fig. 9.

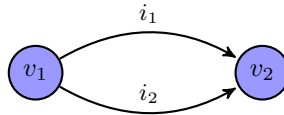

Fig. 9: A two link parallel network

Consider a parallel network with  $n$  links from node  $v_1$  to node  $v_2$ , and link weights  $w \in \mathbb{R}_{>0}^n$ . As already shown in Example 3, the equivalent weight function between  $v_1$  and  $v_2$  is given by  $\mathcal{H}(w) = \sum_{i=1}^n w_i$ . With unit supply and demand on  $v_1$  and  $v_2$ , the flow on link  $i$  is  $f_i = w_i/w_{\text{eq}}$ . Substituting  $f_i = w_i/w_{\text{eq}}$  into (45) and letting

$\tilde{z} = z/w_{\text{eq}}$ , the equivalent capacity function between nodes  $v_1$  and  $v_2$  takes the following simple form:

$$\begin{aligned} \frac{\mathcal{C}(w_{\text{eq}})}{w_{\text{eq}}} &= \max_{\tilde{z} \in \mathbb{R}, w \in \mathbb{R}_{>0}^n} \tilde{z} \\ \text{subject to} \quad &w_i^l \leq w_i \leq w_i^u \\ &\tilde{z} \leq c_i(w_i)/w_i \quad \forall i \in \{1, \dots, n\} \\ &\sum_{i=1}^n w_i = w_{\text{eq}} \end{aligned} \tag{56}$$

The following result is the equivalent of Lemma 10 for parallel networks.

**Lemma 11.** *Consider a network consisting of parallel graph topology  $\mathcal{G} = (\mathcal{V}, \mathcal{E})$ , where  $\mathcal{V} = \{v_1, v_2\}$  and all the links in  $\mathcal{E}$  are from  $v_1$  to  $v_2$ , and lower and upper bounds on link weights are  $w^l \in \mathbb{R}_{>0}^n$  and  $w^u \in \mathbb{R}_{>0}^n$  respectively. If the link capacity functions  $c_i(w_i)$  are  $\mathcal{S}_1$  for all  $i \in \{1, \dots, n\}$ , then the equivalent capacity function  $\mathcal{C}(w_{\text{eq}})$  between  $v_1$  and  $v_2$ , as given by (56), is also a  $\mathcal{S}_1$  function.*

*Proof:* Since  $c_i(w_i)$  are  $\mathcal{S}_1$  functions for all  $i \in \{1, \dots, n\}$ , Lemma 9 implies that  $c_i(w_i)/w_i$  are  $\mathcal{S}_0$  functions and Remark 16 implies that the second transition point of  $c_i(w_i)/w_i$  w.r.t.  $\mathcal{S}_0$  property is the first transition point  $w_i$  of  $c_i(w_i)$  w.r.t.  $\mathcal{S}_0$  property and  $\max_{w_i^l \leq w_i \leq w_i^u} c_i(w_i)/w_i = c_i(w_i)/w_i$ . Proposition 8 and its proof then implies that  $g(w_{\text{eq}}) := \mathcal{C}(w_{\text{eq}})/w_{\text{eq}}$  is a  $\mathcal{S}_0$  function and  $g(w_{\text{eq}}^l) = \min_{i \in \mathcal{E}} c_i(w_i^l)/w_i^l$ ,  $g(w_{\text{eq}}^u) = \min_{i \in \mathcal{E}} c_i(w_i^u)/w_i^u$ , and  $g_{\text{max}} = \min_{i \in \mathcal{E}} c_i(w_i)/w_i$ . Let  $w_{\text{eq}}$  and  $\bar{w}_{\text{eq}}$  denote the first and second transition points, respectively, w.r.t.  $\mathcal{S}_0$  property, for  $g(w_{\text{eq}})$ . In order to establish  $\mathcal{S}_1$  property of  $\mathcal{C}(w_{\text{eq}})$ , we look at its left and right derivatives:

$$\mathcal{C}'(w_{\text{eq}}^+) = g(w_{\text{eq}}) + w_{\text{eq}} g'(w_{\text{eq}}^+), \quad \mathcal{C}'(w_{\text{eq}}^-) = g(w_{\text{eq}}) + w_{\text{eq}} g'(w_{\text{eq}}^-) \tag{57}$$

Therefore, combining (57) with  $\mathcal{S}_0$  property of  $g(w_{\text{eq}})$ , we get that:  $\mathcal{C}'(w_{\text{eq}}^+) > g(w_{\text{eq}}) = \mathcal{C}(w_{\text{eq}})/w_{\text{eq}}$  for all  $w_{\text{eq}} \in [w_{\text{eq}}^l, w_{\text{eq}}]$ ;  $g'(w_{\text{eq}}) \equiv 0$ , and hence  $\mathcal{C}'(w_{\text{eq}}) = g(w_{\text{eq}}) = \mathcal{C}(w_{\text{eq}})/w_{\text{eq}}$ , for  $w_{\text{eq}} \in (w_{\text{eq}}, \bar{w}_{\text{eq}})$ . Moreover, using (91), for  $w_{\text{eq}} \in (\bar{w}_{\text{eq}}, w_{\text{eq}}^u]$ ,

$$\begin{aligned} g'(w_{\text{eq}}^+) &= \left( \sum_{i \in \mathcal{K}^-(g(w_{\text{eq}}))} \frac{1}{(c_i(w_i^+)/w_i)^'} \right)^{-1} \Big|_{w=\omega^-(g(w_{\text{eq}}))} = \left( \sum_{i \in \mathcal{K}^-(g(w_{\text{eq}}))} \frac{w_i}{c_i'(w_i^+) - c_i(w_i)/w_i} \right)^{-1} \Big|_{w=\omega^-(g(w_{\text{eq}}))} \\ &\leq -g(w_{\text{eq}}) \left( \sum_{i \in \mathcal{K}^-(g(w_{\text{eq}}))} w_i \right)^{-1} \Big|_{w=\omega^-(g(w_{\text{eq}}))} \leq -g(w_{\text{eq}}) \left( \sum_{i=1}^n w_i \right)^{-1} \Big|_{w=\omega^-(g(w_{\text{eq}}))} = -g(w_{\text{eq}})/w_{\text{eq}} \end{aligned} \tag{58}$$

where the first inequality follows from the fact that, by definition of  $\mathcal{K}^-$ ,  $c_i(\omega_i^-(g(w_{\text{eq}})))/\omega_i^-(g(w_{\text{eq}})) = g(w_{\text{eq}})$  for all  $i \in \mathcal{K}^-(g(w_{\text{eq}}))$ , and

$$c_i'(w_i^+) \Big|_{w=\omega^-(g(w_{\text{eq}}))} \leq 0 \quad \forall w_{\text{eq}} \in (\bar{w}_{\text{eq}}, w_{\text{eq}}^u] \tag{59}$$

(59) is because of the following. Due to the  $\mathcal{S}_0$  property of function  $g(w_{\text{eq}})$ ,  $g(w_{\text{eq}}) \in [g(w_{\text{eq}}^u), g_{\text{max}}]$  for  $w_{\text{eq}} \in (\bar{w}_{\text{eq}}, w_{\text{eq}}^u]$ . Remark 16 implies that the second transition point, w.r.t.  $\mathcal{S}_0$  property, of  $c_i(w_i)/w_i$  is equal to the first

transition point,  $w_i$ , w.r.t.  $\mathcal{S}_0$  property, of  $c_i(w_i)$ . This, combined with the second equation in (50), further implies that  $\omega_i^-(g(w_{\text{eq}})) \geq w_i$  for  $g(w_{\text{eq}}) \in [g(w_{\text{eq}}^u, g_{\text{max}})]$  i.e.,  $w_{\text{eq}} \in (\bar{w}_{\text{eq}}, w_{\text{eq}}^u]$ . Thereafter, the  $\mathcal{S}_0$  property of  $c_i$  implies (59).

Now we consider conditions for (59) taking equalities. The second inequality in (58) takes equality if and only if  $\mathcal{K}^- = \mathcal{E}$ . Considering  $\mathcal{K}^- = \mathcal{E}$ , the first inequality in (58) takes equality for  $\bar{w}_{\text{eq}} \leq w_{\text{eq}} \leq \hat{g}^-(\max_{i \in \mathcal{E}} c_i(\bar{w}_i)/\bar{w}_i)$ . Furthermore,  $\mathcal{K}^-(g(\cdot))$  is nonincreasing and Remark 14 (b) implies that  $\omega_i^-(g(w_{\text{eq}}))$  is nondecreasing for  $w_{\text{eq}} \in (\bar{w}_{\text{eq}}, w_{\text{eq}}^u]$ . Therefore, there exists  $\tilde{w}_{\text{eq}} \in [\bar{w}_{\text{eq}}, w_{\text{eq}}^u]$  such that for  $\bar{w}_{\text{eq}} \leq w_{\text{eq}} \leq \tilde{w}_{\text{eq}}$ ,  $g'(w_{\text{eq}}^+) = -g(w_{\text{eq}})/w_{\text{eq}}$  and hence  $\mathcal{C}'(w_{\text{eq}}^+) = 0$  from (57); and for  $\tilde{w}_{\text{eq}} < w_{\text{eq}} \leq w_{\text{eq}}^u$ ,  $g'(w_{\text{eq}}^+) < -g(w_{\text{eq}})/w_{\text{eq}}$  and hence  $\mathcal{C}'(w_{\text{eq}}^+) < 0$  from (57). One can show similar properties also for  $\mathcal{C}'(w_{\text{eq}}^-)$ , thereby proving that  $\mathcal{C}(w_{\text{eq}})$  is a  $\mathcal{S}_1$  function. ■

We now provide a characterization of the equivalent capacity function for a parallel network whose links have constant, i.e., weight-independent, capacities, in Example 4. This example generalizes our earlier work [1], where we compute only the maximum of the equivalent capacity function for parallel networks as solution to an optimization problem.

**Example 4** (Equivalent capacity for parallel networks with weight-independent link capacities). *Consider a parallel network with  $n$  links from node  $v_1$  to node  $v_2$ . Let the lower and upper bounds on link weights be  $w^l \in \mathbb{R}_{>0}^n$  and  $w^u \in \mathbb{R}_{>0}^n$  respectively, and let the link capacities be  $c_i > 0$ ,  $i \in \{1, \dots, n\}$ . Then, for every  $i \in \{1, \dots, n\}$ ,  $c_i$  is a  $\mathcal{S}_1$  function, with  $w_i^l = w_i^o = \underline{w}_i$ . Let  $\mathcal{C}(w_{\text{eq}})$  be the equivalent capacity function and hence  $g(w_{\text{eq}}) := \mathcal{C}(w_{\text{eq}})/w_{\text{eq}}$  is the solution to (56) for this network. Lemma 11 implies that  $\mathcal{C}(w_{\text{eq}})$  and  $g(w_{\text{eq}})$  are  $\mathcal{S}_1$  and  $\mathcal{S}_0$  functions, respectively. Let  $w_{\text{eq}}^o$ ,  $w_{\text{eq}}$  and  $\bar{w}_{\text{eq}}$  be the first and second transition points, w.r.t.  $\mathcal{S}_1$  property, and the second transition point, w.r.t.  $\mathcal{S}_0$  property, of  $\mathcal{C}(w_{\text{eq}})$ , respectively. Remark 16 implies that  $w_{\text{eq}}^o$  and  $w_{\text{eq}}$  are the first and second transition points, w.r.t.  $\mathcal{S}_0$  property, of  $g(w_{\text{eq}})$ , respectively.*

With  $w_{\text{eq}}^l = \sum_{i=1}^n w_i^l$  and  $w_{\text{eq}}^u = \sum_{i=1}^n w_i^u$ , it is easy to see that  $w_{\text{eq}}^o = w_{\text{eq}}^l$ ,

$$g_{\text{max}} = g(w_{\text{eq}}^l) = \min_{i \in \{1, \dots, n\}} c_i/w_i^l \quad (60)$$

and  $g(w_{\text{eq}}^u) = \min_{i \in \{1, \dots, n\}} c_i/w_i^u$ . Since  $\mathcal{H}(w) = \sum_{i=1}^n w_i$ , the inverse function in (47) satisfies  $\hat{g}^-(x) = \sum_{i=1}^n \omega_i^-(x)$  for all  $x \in [\min_{i \in \{1, \dots, n\}} c_i/w_i^u, \min_{i \in \{1, \dots, n\}} c_i/w_i^l]$ . Indeed,  $\omega_i^-(x)$  can be explicitly written as  $\omega_i^-(x) = \min\{c_i/x, w_i^u\}$ . Therefore,  $\hat{g}^-(x)$  can be written as:

$$w_{\text{eq}} = \hat{g}^-(x) = \frac{1}{x} \sum_{i: w_i^u > c_i/x} c_i + \sum_{i: w_i^u \leq c_i/x} w_i^u \quad (61)$$

Note  $\hat{g}^-(x)$  is decreasing. By definition,  $w_{\text{eq}} = \hat{g}^-(g_{\text{max}}) \in [w_{\text{eq}}^l, w_{\text{eq}}^u]$ . It is straightforward that  $\hat{g}^-(g_{\text{max}}) \leq w_{\text{eq}}^u$ , and (60) implies that  $c_i/g_{\text{max}} \geq w_i^l$  for all  $i \in \{1, \dots, n\}$ , and hence  $\hat{g}^-(g_{\text{max}}) \geq \sum_{i=1}^n w_i^l = w_{\text{eq}}^l$ . For  $w_{\text{eq}} \in [w_{\text{eq}}^l, w_{\text{eq}}]$ ,  $g(w_{\text{eq}}) = g_{\text{max}}$ . For  $w_{\text{eq}} \in [w_{\text{eq}}, w_{\text{eq}}^u]$ , the monotonicity of  $\hat{g}^-$  implies that  $\{i \mid w_i^u > c_i/g(w_{\text{eq}})\} = \{i \mid w_{\text{eq}} < \hat{g}^-(c_i/w_i^u)\}$ . Therefore, (61) implies that

$$g(w_{\text{eq}}) = \mathbf{inv} \hat{g}^-(g(w_{\text{eq}})) = \frac{\sum_{i: w_{\text{eq}} < \hat{g}^-(c_i/w_i^u)} c_i}{w_{\text{eq}} - \sum_{i: w_{\text{eq}} \geq \hat{g}^-(c_i/w_i^u)} w_i^u} \quad (62)$$

Based on these calculations, the equivalent capacity function is characterized as follows:



For  $w_{\text{eq}} \in [w_{\text{eq}}^l, w_{\text{eq}}]$ ,

$$\mathcal{C}(w_{\text{eq}}) = w_{\text{eq}} g_{\text{max}} = w_{\text{eq}} \min_{i \in \{1, \dots, n\}} c_i / w_i^l \quad (63)$$

which is a linear function with slope  $\min_{i \in \{1, \dots, n\}} c_i / w_i^l$ .

If  $w_i^u > c_i / g_{\text{max}}$  for all  $i \in \{1, \dots, n\}$ , i.e.,  $g_{\text{max}} > \max_{i \in \{1, \dots, n\}} c_i / w_i^u$ , then (61) implies that  $\hat{g}^-(x) = \sum_{i=1}^n c_i / x$  for all  $x \in [\max_{i \in \{1, \dots, n\}} c_i / w_i^u, g_{\text{max}}]$ . Equivalently, for all  $w_{\text{eq}} \in [w_{\text{eq}}, \hat{g}^-(\max_{i \in \{1, \dots, n\}} c_i / w_i^u)]$ , we get  $g(w_{\text{eq}}) = \sum_{i=1}^n c_i / w_{\text{eq}}$ , and hence

$$\mathcal{C}(w_{\text{eq}}) = w_{\text{eq}} g(w_{\text{eq}}) = \sum_{i=1}^n c_i \quad (64)$$

It is straightforward to see that  $\bar{w}_{\text{eq}} = \max\{\hat{g}^-(g_{\text{max}}), \hat{g}^-(\max_{i \in \{1, \dots, n\}} c_i / w_i^u)\} \in [w_{\text{eq}}, w_{\text{eq}}^u]$ .

Finally, for  $w_{\text{eq}} \in [\bar{w}_{\text{eq}}, w_{\text{eq}}^u]$

$$\mathcal{C}(w_{\text{eq}}) = w_{\text{eq}} g(w_{\text{eq}}) = \frac{w_{\text{eq}}}{w_{\text{eq}} - \sum_{i: w_{\text{eq}} \geq \hat{g}^-(c_i / w_i^u)} w_i^u} \sum_{i: w_{\text{eq}} < \hat{g}^-(c_i / w_i^u)} c_i \quad (65)$$

In summary, (63), (64) and (65) completely characterize the equivalent capacity function for parallel networks, and an illustration is provided in Fig. 10. Every point in the curve in Fig. 10  $(w_{\text{eq}}, \mathcal{C}(w_{\text{eq}}))$  corresponds to an optimal solution of weight  $w$  to (45) for a parallel network with constant capacities on all the links and equivalent weight  $w_{\text{eq}}$ . In general, this optimal solution is not unique. However, since  $w_{\text{eq}}$  is the second transition point of function  $c_i / w_i$  w.r.t.  $\mathcal{S}_0$  property in this case, Remark 14 implies that the optimal solution is unique and nondecreasing for  $w_{\text{eq}} \in [w_{\text{eq}}, w_{\text{eq}}^u]$ . This is summarized in Remark 17. As shown in Fig. 10,  $\alpha^*$ , being the maximum of function  $\mathcal{C}(w_{\text{eq}})$ , can be computed explicitly, which in turn implies that the margin of robustness for parallel networks can be computed explicitly.

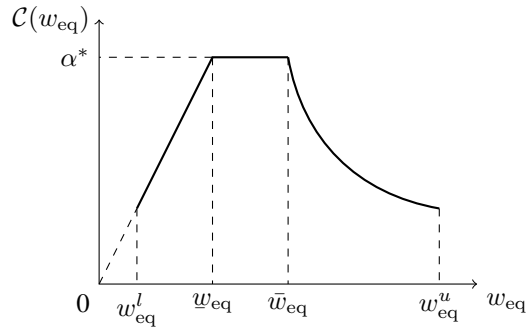

Fig. 10: Equivalent capacity function for a parallel network consisting of links with constant capacities.

**Remark 17.** For a parallel network with constant capacity on each link,  $\omega^-(g(w_{\text{eq}})) = \min\{c_i / g(w_{\text{eq}}), w_i^u\}$  is the unique optimal solution to (56) and is nondecreasing for  $w_{\text{eq}} \in [w_{\text{eq}}, w_{\text{eq}}^u]$ , where  $g(w_{\text{eq}})$  is shown in (62).

### E. Computing Margin of Robustness for Tree Reducible Networks

Using Lemmas 10 and 11, and Definition 6, one sees that, for parallel and series networks, the equivalent capacity functions are  $\mathcal{S}_1$  functions. Indeed, one can use Lemmas 10 and 11 recursively to show  $\mathcal{S}_1$  property for the equivalent capacity function for a broader class of networks. In order to see this, consider the network illustrated in Figure 6 where  $p_{v_1} = -p_{v_4} > 0$ , and  $p_{v_2} = p_{v_3} = 0$ .

Lemma 11 (and Example 4) imply that the capacity of an equivalent link, say  $i_{4,5}$  corresponding to links  $i_4$  and  $i_5$ , is weight-dependent, and the capacity function for the equivalent link  $i_{4,5}$  is a  $\mathcal{S}_1$  function. Lemma 10 then implies that the equivalent capacity function for the equivalent link  $i_{2,4,5}$  corresponding to links  $i_2$  and  $i_{4,5}$  is also a  $\mathcal{S}_1$  function. The same property also holds true for equivalent link  $i_{1,3}$  corresponding to  $i_1$  and  $i_3$ . Finally, the equivalent capacity function between nodes  $v_1$  and  $v_4$  corresponding to links  $i_{1,3}$  and  $i_{2,4,5}$  can also be shown to be  $\mathcal{S}_1$  by Lemma 11. Specific numerical examples are provided in Section VIII-B. In summary, for the network in Figure 6, the  $\mathcal{S}_1$  property is invariant from the capacities at individual link to equivalent capacity functions associated with intermediate equivalent parallel and series reductions, finally to the one associated with the equivalent link corresponding to the entire network. Since  $\mathcal{S}_1$  implies  $\mathcal{S}_0$ , (52) then gives a computationally efficient recursive procedure to compute the equivalent capacity function of the entire network in terms of capacities of individual links. Recalling that, for a given network, computing the equivalent capacity is the same as solving the reduction problem, the above procedure can also be used to solve the reduction problem for tree reducible network.

**Theorem 1.** *Consider the reduction problem (45) on a link reducible network  $\mathcal{G} = (\mathcal{V}, \mathcal{E})$ , with lower and upper bounds on link weights as  $w^l \in \mathbb{R}_{>0}^n$  and  $w^u \in \mathbb{R}_{>0}^n$  respectively. Then, its solution function  $\mathcal{C}(w_{\text{eq}})$  is a  $\mathcal{S}_1$  function.*

Finally, the margin of robustness for a tree reducible network can be computed using the multilevel approach from Section V as follows. Recall from Section V-C that the multilevel formulation consists of multiple reduction problems, and a single terminal problem. Theorem 1 along with (52) provides an explicit solutions to the reduction problems. Since the original network is tree reducible, the terminal problem is over a tree. Even though this tree has weight dependent capacity functions on the links, Proposition 2 can be used to solve the terminal problem, and hence gives the margin of robustness. Specifically, for a tree network  $\mathcal{G} = (\mathcal{V}, \mathcal{E})$  with link capacity functions  $\mathcal{C}_i^l(w_i)$  and  $\mathcal{C}_i^u(w_i)$ ,  $i \in \mathcal{E}$ , one can use Proposition 2 with  $c_i^l := \min_{w_i} \mathcal{C}_i^l(w_i)$  and  $c_i^u := \max_{w_i} \mathcal{C}_i^u(w_i)$  to compute the margin of robustness.

## VII. DECENTRALIZED CONTROL POLICIES

In Sections II-VI, we described various approaches to compute the margin of robustness for a centralized control policy (which has information about link flows and weights, disturbances, as well as link flow capacities and operational range of weights), and we recall that this is an upper bound for any control policy. In this section, we analyze the robustness of decentralized policies, for parallel networks, that do not require information about the disturbance or link capacities, and moreover weight bounds information is private to each link.

Consider a parallel network consisting of  $n$  links from the supply node to the demand node. Let the magnitude of supply/demand be equal to  $\alpha \geq 0$ . We first specialize the margin of robustness computation to this setting. Since Remark 12 (d) implies that the margin of robustness for a parallel network is related to the maximum of equivalent capacity over all feasible equivalent weights, Example 4 implies that the margin of robustness for a parallel network is given by:

$$\alpha^* = \max_{w_{\text{eq}}^l \leq w \leq w_{\text{eq}}^u} \mathcal{C}(w_{\text{eq}}) = g_{\max} \hat{g}^-(g_{\max}) = g_{\max} \sum_{i: w_i^u < c_i/g_{\max}} w_i^u + \sum_{i: w_i^u \geq c_i/g_{\max}} c_i \quad (66)$$

where we recall  $g_{\max} = \min_{i \in \{1, \dots, n\}} c_i/w_i^l = 1/(\max_i w_i^l/c_i)$  and other notations used in (66) from Example 4. Moreover, an optimizer in (66) is  $w_{\text{eq}}^{\text{opt}} = \hat{g}^-(g_{\max}) = \sum_{i=1}^n \min\{c_i/g_{\max}, w_i^u\}$ , with the corresponding link weights given by

$$w_i^{\text{opt}} = w_i^-(g_{\max}) = \min\{c_i \max w_i^l/c_i, w_i^u\}. \quad (67)$$

Indeed, for a parallel network, since all disturbances are of multiplicative type, and the link flows for a parallel network are explicitly given by  $f_i = \alpha w_i / (\sum_{j=1}^n w_j)$ , it is easy to see from (14), as is also shown in [1, Section III-B], that the margin of robustness for a parallel network is equal to the following:

$$\begin{aligned} & \max_{\alpha \in \mathbb{R}, w \in \mathbb{R}^n} \alpha \\ & \text{subject to } w^l \leq w \leq w^u \\ & f_i = \frac{w_i}{\sum_{j=1}^n w_j} \alpha \quad \forall i \in \{1, \dots, n\} \\ & 0 \leq f \leq c \end{aligned} \quad (68)$$

Remark 17 implies that  $w^{\text{opt}}$  defined in (67) is the minimal optimal solution to (68), as summarized in Remark 18.

**Remark 18.** For a  $n$  link parallel network with constant capacities,  $w^{\text{opt}}$  defined in (67) is the minimal optimal solution to (68), i.e.,  $\tilde{w}_i \geq w_i^{\text{opt}}$  for all  $i \in \{1, \dots, n\}$  and all optimal solution  $\tilde{w}$  of (68).

The decentralized control policies considered in this paper are partially inspired by the implication of Proposition 4 for a parallel network that, the decrease in the weight of a link leads to a decrease in flow on that link but an increase in flow on the parallel links connecting the same nodes. While this implication of Proposition 4 does not necessarily extend to the case when multiple links change weights simultaneously, we identify conditions under which the decentralized control policies considered in this paper are provably robust, i.e., their margin of robustness is equal to the quantity computed in (66), or equivalently the optimal value of (68).

We now state two control policies and analyze their robustness within the dynamical framework of (4).

### A. A Memoryless Controller

Consider the following control policy: for all  $i \in \{1, \dots, n\}$

$$u_i^1(w_i(t), f_i(t)) = \begin{cases} -\lambda_i & f_i(t) > c_i \text{ \& } w_i(t) > w_i^l \\ 0 & \text{otherwise} \end{cases} \quad (69)$$

where  $\lambda_i > 0$  is an arbitrary constant denoting the rate of decrease of  $w_i$ .

Since  $w(t)$  is nonincreasing under  $u^1$  and is lower bounded by  $w^l$ , the dynamics in (4) always converges to an equilibrium under  $u^1$ . This is formally stated next.

**Lemma 12.** *Consider a network consisting of a directed multigraph  $\mathcal{G} = (\mathcal{V}, \mathcal{E})$ , with lower and upper bounds on link weights as  $w^l \in \mathbb{R}_{\geq 0}^n$  and  $w^u \in \mathbb{R}_{> 0}^n$ , respectively. Then, for every  $\lambda \in \mathbb{R}_{> 0}^{\mathcal{E}}$ , and  $w(0) \in [w^l, w^u]$ , there exists  $w^* \in [w^l, w(0)] \subseteq [w^l, w^u]$ , such that, under the dynamics in (4) with the controller  $u^1$  in (69),  $\lim_{t \rightarrow +\infty} w(t) = w^*$ .<sup>9</sup>*

The flow  $f(w^*)$  at the equilibrium  $w^*$  established in Lemma 12 may not necessarily satisfy  $f(w^*) \in [0, c]$  under all supply/demand  $\alpha$ . We next characterize the upper limit on this quantity and compare it with respect to the upper bound  $\alpha^*$ .

Unless otherwise stated explicitly, in this section, we adopt the shorthand notation  $\min_i$  and  $\max_i$  to imply minimum and maximum, respectively, over  $\{1, \dots, n\}$ . Let

$$r_i := w_i(0)/c_i, \quad i \in \{1, \dots, n\} \quad (70)$$

Without loss of generality, label the links in increasing order of  $r_i$ , i.e.,  $r_1 \leq r_2 \leq \dots \leq r_n$ . Let

$$r^* := \max_i \frac{w_i^l}{c_i} = \frac{1}{g_{\max}} \quad (71)$$

Since  $w(0) \geq w^l$ ,  $r_n = \max_i w_i(0)/c_i \geq \max_i w_i^l/c_i$  and therefore  $r^* \leq r_n$ . Let  $\bar{k} := \min \{j \in \{1, \dots, n\} \mid r_j \geq r^*\}$ .

This implies that

$$r_{\bar{k}-1} < r^* \leq r_{\bar{k}} \quad (72)$$

Consider the following functions:

$$V_k := \frac{1}{r_k} \sum_{i=1}^{k-1} w_i(0) + \sum_{i=k}^n c_i, \quad k \in \{1, \dots, n\}, \quad V^* := \frac{1}{r^*} \sum_{i=1}^{\bar{k}-1} w_i(0) + \sum_{i=\bar{k}}^n c_i \quad (73)$$

(73) implies that  $V_1 = \sum_{i=1}^n c_i$  and, when  $r^* \leq r_1$ ,  $\bar{k} = 1$  and  $V^* = \sum_{i=1}^n c_i = V_1$ . Since  $r_k \leq r_{k+1}$ ,  $V_k$  is nonincreasing in  $k$ :

$$V_{k+1} = \frac{1}{r_{k+1}} \sum_{i=1}^k w_i(0) + \sum_{i=k+1}^n c_i \leq \frac{1}{r_k} \sum_{i=1}^{k-1} w_i(0) + \frac{w_k(0)}{r_k} + \sum_{i=k+1}^n c_i = V_k$$

Similarly, we can show that

$$V_{\bar{k}} \leq V^* < V_{\bar{k}-1} \quad (74)$$

<sup>9</sup>Notice that Lemma 12 is stated for a general, i.e., not necessarily parallel, networks.

**Theorem 2.** Consider a parallel network consisting of  $n$  links, with lower and upper bounds on link weights as  $w^l \in \mathbb{R}_{>0}^n$  and  $w^u \in \mathbb{R}_{>0}^n$ , respectively, link capacities  $c \in \mathbb{R}_{>0}^n$ , and supply/demand with magnitude  $\alpha \geq 0$ . Then, for every  $\lambda \in \mathbb{R}_{>0}^n$  and  $w(0) \in [w^l, w^u]$ , there exists  $w^* \in [w^l, w(0)] \subseteq [w^l, w^u]$ , such that, under the dynamics in (4) with the controller  $u^1$  in (69),  $w(t)$  monotonically converges to  $w^* \in [w^l, w(0)] \subseteq [w^l, w^u]$ . Moreover,

(i) if  $\alpha \in [0, V_n]$ , then  $w^* = w(0)$  and  $f(w^*) \in [0, c]$ ;

(ii) if  $\alpha \in (V_n, V^*]$  then

$$w_i^* = \begin{cases} w_i(0) & 1 \leq i \leq \hat{k} - 1 \\ \hat{r} c_i & \hat{k} \leq i \leq n \end{cases} \quad (75)$$

where  $\hat{k} := \min \{j \in \{1, \dots, n\} \mid \alpha \geq V_j\}$ ,

$$\hat{r} := \begin{cases} \frac{\sum_{i=1}^{\hat{k}-1} w_i(0)}{\alpha - \sum_{i=\hat{k}}^n c_i} & \alpha < V_1 \\ r_1 & \alpha = V_1 = V^* \end{cases} \quad (76)$$

and  $f(w^*) \in [0, c]$ ;

(iii) if  $\alpha > V^*$  then  $f(w^*) \notin [0, c]$

where  $V_j$  and  $V^*$  are as defined in (73).

*Proof:* Monotonic convergence of  $w(t)$  follows from Lemma 12. If  $\alpha \in [0, V_n]$ , then the initial flow on link  $i \in \{1, \dots, n\}$  is given by:

$$f_i(0) = \frac{w_i(0)}{\sum_{j=1}^n w_j(0)} \alpha \leq \frac{w_i(0)}{\sum_{j=1}^n w_j(0)} \frac{\sum_{j=1}^n w_j(0)}{r_n} \leq c_i$$

i.e., the system is feasible at  $t = 0$ . Therefore, if  $\alpha \leq V_n$ , then  $u^1(t) \equiv 0$ , and hence the equilibrium is  $w^* = w(0)$ .

This establishes part (i) in the theorem.

If  $\alpha > V_1 = \sum_{i=1}^n c_i$ , then it is trivially  $f(w) \notin [0, c]$  for any  $w$ . Hence  $\alpha \leq V_1$  is considered in the following proof. Moreover, we emphasize that since  $V^* \leq V_1$ ,  $\alpha < V_1$  is satisfied in case (ii) if  $V^* < V_1$ . The definition of  $\hat{k}$  implies that  $V_{\hat{k}} \leq \alpha < V_{\hat{k}-1}$ . This, combined with (76) and (73), implies that  $\hat{r} \geq 0$ , and hence  $w^* \geq 0$ , for all  $\alpha \in (V_n, V_1)$ . (73) and (70) imply that

$$\frac{1}{r_{\hat{k}}} \sum_{i=1}^{\hat{k}-1} w_i(0) \leq \alpha - \sum_{i=\hat{k}}^n c_i < \frac{1}{r_{\hat{k}-1}} \sum_{i=1}^{\hat{k}-1} w_i(0)$$

Therefore, the definition of  $\hat{r}$  in (76) implies that,

$$\hat{r} \leq r_{\hat{k}}, \quad \forall \alpha \in (V_n, V_1] \quad (77)$$

In writing (77), we used the fact that, when  $\alpha = V_1$ , then  $\hat{k} = 1$ , and hence  $r_{\hat{k}} = r_1 = \hat{r}$ . Additionally,

$$\hat{r} > r_{\hat{k}-1}, \quad \forall \alpha \in (V_n, V_1) \quad (78)$$

We now establish the following claims: with  $w^*$  as given in (75),

(I) for  $V_n < \alpha \leq V_1$   $[w^*, w(0)]$  is positively invariant under (4) with controller  $u^1$ ;

(II) for  $\alpha \in (V_n, V^*]$ ,

- (a)  $w^* \in [w^l, w(0)]$ ,
- (b)  $w^*$  is the only equilibrium in  $[w^*, w(0)]$ ,
- (c)  $f(w^*) \in [0, c]$

(III) for  $V^* < \alpha \leq V_1$ ,  $f(w) \notin [0, c]$  for all  $w \in [w^*, w(0)] \cap [w^l, w(0)]$ .

(I) and (II) establish part (ii) of the theorem, whereas (I) and (III) establish part (iii).

Proof of (I): Since  $w(t) \leq w(0)$  for all  $t \geq 0$  under controller  $u^1$ , it suffices to show that  $w(t) \geq w^*$  for all  $t \geq 0$  under  $u^1$ . Assume by contradiction that this is not true. Continuity of  $w(t)$  then implies that there exists  $t_1 > 0$  and  $\hat{i} \in \{1, \dots, n\}$  such that  $w(t) \geq w^*$  for all  $t \in [0, t_1]$ ,  $w_{\hat{i}}(t_1) = w_{\hat{i}}^*$  and  $\dot{w}_{\hat{i}}(t_1) < 0$ . The latter implies that  $f_{\hat{i}}(t_1) > c_{\hat{i}}$ . However,

$$f_{\hat{i}}(t_1) = \frac{w_{\hat{i}}(t_1)}{\sum_{j=1}^n w_j(t_1)} \alpha \leq \frac{w_{\hat{i}}^*}{\sum_{j=1}^n w_j^*} \alpha \quad (79)$$

If  $\alpha < V_1$ , then (75), (76) and (79) imply  $f_{\hat{i}}(t_1) \leq w_{\hat{i}}^*/\hat{r}$ . For  $j \in \{1, \dots, \hat{k} - 1\}$ , (70), (76), (77) and (78) imply  $w_j^*/\hat{r} = w_j(0)/\hat{r} = c_j r_j/\hat{r} \leq c_j$ . For  $j \in \{\hat{k}, \dots, n\}$ ,  $w_j^*/\hat{r} = c_j$ . These together imply  $f_{\hat{i}}(t_1) \leq c_{\hat{i}}$ , giving a contradiction.

If  $\alpha = V_1$ , then  $\hat{k} = 1$ , and therefore (75) and (76) imply  $w^* = r_1 c$ . Using this with (79) implies  $f_{\hat{i}}(t_1) \leq c_{\hat{i}} \alpha / (\sum_{j=1}^n c_i) = c_{\hat{i}}$ , again giving a contradiction.

Proof of (II-a): Following (75), we only need to show that  $w_i^* \in [w_i^l, w_i(0)]$  for  $i \in \{\hat{k}, \dots, n\}$ . It is sufficient to show that  $r^* \leq \hat{r} \leq r_{\hat{k}}$ . This is because  $\hat{r} \geq r^*$  combined with (71) implies that  $\hat{r} \geq w_i^l/c_i$ , and hence  $w_i^* \geq w_i^l$ , for all  $i \in \{\hat{k}, \dots, n\}$ ; and  $\hat{r} \leq r_{\hat{k}}$ , which has already been established in (77), combined with the non-decreasing property of the sequence  $\{r_k\}_{k=1}^n$  implies  $\hat{r} \leq r_i$ , and hence  $w_i^* \leq w_i(0)$  for all  $i \in \{\hat{k}, \dots, n\}$ , from (70). Since  $\alpha \in (V_n, V^*]$ , (74) implies  $\hat{k} \geq \bar{k}$ . If  $\hat{k} = \bar{k}$ , then  $\alpha - \sum_{i=\hat{k}}^n c_i \leq V^* - \sum_{i=\bar{k}}^n c_i = (\sum_{i=1}^{\bar{k}-1} w_i(0))/r^*$ . (76) then implies  $\hat{r} \geq r^*$ . If  $\hat{k} > \bar{k}$ , i.e.,  $\hat{k} - 1 \geq \bar{k}$ , then the non-decreasing property of  $\{r_k\}_{k=1}^n$  implies  $r_{\hat{k}-1} \geq r_{\bar{k}}$ , which when combined with (78) and (72) implies  $\hat{r} > r^*$  if  $\alpha < V_1$ . On the other hand, if  $\alpha = V_1$ , then  $\hat{r} = r^* = r_1$ . This completes the proof for  $w^* \in [w^l, w(0)]$ . Combining this with the definition of  $w^*$  in (75) implies that

$$w_i(t) \equiv w_i(0), \quad i \in \{1, \dots, \hat{k} - 1\} \quad (80)$$

If  $\alpha = V_1$ , then  $\hat{k} = 1$ , the set  $\{1, \dots, \hat{k} - 1\}$  is empty. However, in this case,  $w_1^* = r_1 c_1 = w_1(0)$ . Therefore,

$$w_1(t) \equiv w_1(0), \quad \forall \alpha \in (V_n, V_1]. \quad (81)$$

Proof of (II-b): By contradiction, suppose  $\tilde{w} \in [w^*, w(0)] \setminus \{w^*\}$  is also an equilibrium. (80) and (81) imply there exists  $\mathcal{E}' \subset \{\max\{2, \hat{k}\}, \dots, n\}$  such that  $\tilde{w}_i > w_i^*$  for all  $i \in \mathcal{E}'$ , and  $\tilde{w}_i = w_i^*$  for  $i \notin \mathcal{E}'$  (we have already proven  $w(t) \geq w^*$  for all  $t \geq 0$ ). Therefore,

$$\sum_{i \in \mathcal{E}'} f_i(\tilde{w}) = \frac{\sum_{i \in \mathcal{E}'} \tilde{w}_i}{\sum_{j \in \mathcal{E}'} \tilde{w}_j + \sum_{j \notin \mathcal{E}'} w_j^*} \alpha > \frac{\sum_{i \in \mathcal{E}'} w_i^*}{\sum_{j=1}^n w_j^*} \alpha = \sum_{i \in \mathcal{E}'} c_i$$

where the inequality is due to the fact that  $\{1, \dots, n\} \setminus \mathcal{E}'$  is nonempty, and the equality follows from the same argument used in the proof of (I): if  $\alpha < V_1$ , then  $\alpha / (\sum_{j=1}^n w_j^*) = 1/\hat{r}$ , and hence  $(\sum_{i \in \mathcal{E}'} w_i^*) \alpha / (\sum_{j=1}^n w_j^*) =$

$\sum_{i \in \mathcal{E}'} w_i^*/\hat{r} = \sum_{i \in \mathcal{E}'} c_i$ ; if  $\alpha = V_1 = \sum_{i=1}^n c_i$ , then  $\hat{k} = 1$ ,  $w^* = r_1 c$ , and hence  $(\sum_{i \in \mathcal{E}'} w_i^*)\alpha / (\sum_{j=1}^n w_j^*) = \sum_{i \in \mathcal{E}'} c_i$ . Therefore, there exists at least one  $j \in \mathcal{E}'$  such that  $f_j(\tilde{w}) > c_j$ . This, combined with the fact that  $\tilde{w}_i > w_i^* \geq w_i^l$  for all  $i \in \mathcal{E}'$ , implies that  $\tilde{w}$  can not be an equilibrium under  $u^1$ .

**Proof of (II-c):** For any  $i \in \{1, \dots, n\}$ ,  $f_i(w_i^*) = w_i^*\alpha / (\sum_{j=1}^n w_j^*)$ . Along the same argument used in the proof of (I), we have:

If  $\alpha < V_1$ , then  $\alpha / (\sum_{j=1}^n w_j^*) = 1/\hat{r}$ , and therefore  $f_i(w_i^*) = w_i^*/\hat{r}$ . This is equal to  $c_i$  for  $i \in \{\hat{k}, \dots, n\}$ , from (75). For  $i \in \{1, \dots, \hat{k} - 1\}$ , since  $\hat{r} > r_{\hat{k}-1} \geq r_i$  from (77) and non-decreasing property of  $\{r_k\}_{k=1}^n$ , we have,  $f_i(w_i^*) = w_i(0)/\hat{r} \leq w_i(0)/r_i = c_i$  from (70).

If  $\alpha = V_1$ , then  $\hat{k} = 1$ , and hence  $w^* = r_1 c$ . Therefore,  $f_i(w_i^*) = c_i$  for all  $i \in \{1, \dots, n\}$ .

**Proof of (III):** If  $\alpha \in (V^*, V_1)$ , then  $2 \leq \hat{k} \leq \bar{k}$ . If  $\alpha = V_1$ , then  $\hat{k} = 1$ ,  $\hat{r} = r_1$  and  $w^* = r_1 c$ . In particular,  $w_1^* = r_1 c_1 = w_1(0)$ . Therefore, for convenience, we can set  $\hat{k} = 2$  for  $\alpha = V_1$  and (75) remains valid. In summary, we set the convention that  $\bar{k} \geq \hat{k} \geq 2$  for all  $\alpha \in (V^*, V_1]$ . Consequently, the set  $\{1, \dots, \hat{k} - 1\}$  is not empty, and, using similar argument as in the proof of (II-b), it can be shown that  $\sum_{i=\hat{k}}^n f_i(w) > \sum_{i=\bar{k}}^n c_i$  for any  $w \in [w^*, w(0)] \setminus \{w^*\}$ , i.e.,  $f(w) \notin [0, c]$  for all  $w$  in  $[w^*, w(0)]$  other than  $w^*$ . Furthermore,  $w^* \notin [w^l, w(0)]$ . This is because of the following: Since  $r^* > r_{\bar{k}-1}$  from (72), maximum of  $\{w_i^l/c_i\}_{i=1}^n$  occurs in  $\{\bar{k}, \dots, n\}$ . If  $\tilde{k}$  denotes one such maximizer, then  $\tilde{k} \geq \bar{k} \geq \hat{k}$ . Therefore,  $w_{\tilde{k}}^l > c_{\tilde{k}}\hat{r} = w_{\tilde{k}}^*$ , where the inequality is due to  $r^* > \hat{r}$ , which can be shown using argument similar to the one in the proof of (II-a), and the equality is due to the definition of  $w_{\tilde{k}}^*$  for  $\tilde{k} \geq \hat{k}$  from (75). ■

Theorem 2 implies that the margin of robustness of  $u^1$  is equal to  $V^*$ . The following proposition states sufficient conditions for  $u^1$  to be maximally robust, i.e., sufficient conditions for  $V^* = \alpha^*$ .

**Proposition 9.** Consider a parallel network consisting of  $n$  links, with lower and upper bounds on link weights as  $w^l \in \mathbb{R}_{>0}^{\mathcal{E}}$  and  $w^u \in \mathbb{R}_{>0}^{\mathcal{E}}$ , respectively, link capacities  $c \in \mathbb{R}_{>0}^n$ . Then, for every  $\lambda \in \mathbb{R}_{>0}^n$  and  $w(0) \in [w^l, w^u]$ , we have  $R(u^1) = V^* = \alpha^*$  (cf. (66) and (73)) if and only if  $w(0) \geq w^{\text{opt}}$ , where  $w^{\text{opt}}$  is an optimal solution to (68), as defined in (67).

*Proof:* Let  $\mathcal{E}_0 := \{i \in \{1, \dots, n\} \mid w_i^u/c_i < r^* = \max_i w_i^l/c_i\}$ . (66) and (67) then imply that  $\alpha^* = \sum_{i \in \mathcal{E}_0} w_i^u/r^* + \sum_{i \notin \mathcal{E}_0} c_i$  and

$$w_i^{\text{opt}} = w_i^u, \quad \forall i \in \mathcal{E}_0; \quad w_i^{\text{opt}} = c_i r^*, \quad \forall i \in \{1, \dots, n\} \setminus \mathcal{E}_0 \quad (82)$$

We need to show that  $w(0) \geq w^{\text{opt}}$  is necessary and sufficient condition for:

$$V^* = \frac{1}{r^*} \sum_{i=1}^{\bar{k}-1} w_i(0) + \sum_{i=\bar{k}}^n c_i = \frac{1}{r^*} \sum_{i \in \mathcal{E}_0} w_i^u + \sum_{i \notin \mathcal{E}_0} c_i = \alpha^* \quad (83)$$

Since  $w(0) \leq w^u$ , by definition  $\mathcal{E}_0 \subseteq \{1, \dots, \bar{k} - 1\}$ . Moreover, by definition  $w_i(0)/r^* < c_i$  for  $i \leq \bar{k} - 1$ . Therefore, it is straightforward to see that (83) is true if and only if: (i)  $\mathcal{E}_0 = \{1, \dots, \bar{k} - 1\}$ ; and (ii)  $w_i(0) = w_i^u$  for all  $i \in \mathcal{E}_0$ . Since  $\mathcal{E}_0 \subseteq \{1, \dots, \bar{k} - 1\}$ , (i) is equivalent to  $\{1, \dots, n\} \setminus \mathcal{E}_0 \subseteq \{\bar{k}, \dots, n\}$ , which is further equivalent

to  $w_i(0) \geq c_i r^*$  for all  $i \in \{1, \dots, n\} \setminus \mathcal{E}_0$ . Therefore, considering the definition of  $w^{\text{opt}}$  from (82), conditions (i) and (ii) can be succinctly written as  $w(0) \geq w^{\text{opt}}$ . ■

**Remark 19.**

- (a) *Since the controller  $u^1$  only decreases weights, the initial weight must be greater than at least one optimal solution of weight in order for the controller  $u^1$  to be maximally robust. Remark 18 implies that the condition  $w(0) \geq w^{\text{opt}}$  is not conservative because  $w^{\text{opt}}$  is the minimal optimal solution.*
- (b) *Since  $w^u \geq w^{\text{opt}}$ , Proposition 9 implies that  $u^1$  is maximally robust for parallel networks if  $w(0) = w^u$ .*
- (c) *Referring to Theorem 2, the weights on links in set  $\{1, \dots, \max\{1, \hat{k} - 1\}\}$  does not change under  $u^1$ , whereas the weights on links in set  $\{\max\{2, \hat{k}\}, \dots, n\}$  potentially changes, and indeed these links become capacitated at the equilibrium  $w^*$ .*
- (d)  $\lambda_i$  in (69) can be arbitrary and time varying.

**B. Controller with Memory**

We now present a control policy which augments  $u^1$  by increasing weight on link  $i$  when the flow  $f_i$  is increasing. The control policy is formally stated as follows: for all  $i \in \{1, \dots, n\}$ ,

$$u_i^2(w_i(t), f_i(t)) = \begin{cases} -\lambda_i & f_i(t) > c_i \ \& \ w_i(t) > w_i^l \\ \lambda_i & f_i(t) < c_i \ \& \ \dot{f}_i(t^-) > 0 \\ & \ \& \ w_i(t) < w_i^u \\ 0 & \text{otherwise} \end{cases} \quad (84)$$

where  $\lambda_i > 0$  is an arbitrary constant, and  $\dot{f}_i(t^-) := \lim_{\Delta t \rightarrow 0^-} (f_i(t + \Delta t) - f_i(t)) / \Delta t$  is the left derivative of  $f_i(t)$ . The control policy in (84) has a natural altruistic interpretation as follows: the controller on link  $i$  takes an action when either the flow on link  $i$  exceeds its capacity, or it sees an increase in the flow on link  $i$ . In particular, in the latter case, controller  $i$  increases weight on link  $i$  in order to further increase the flow on link  $i$ , and thereby possibly avoiding infeasibility on other links. For parallel networks, if the disturbance at  $t = 0$  leads to increase in supply/demand, then it leads to increase in flows on all links. In such a case, under  $u^2$ ,

$$\dot{f}_i(0^-) > 0, \quad \forall i \in \{1, \dots, n\} \quad (85)$$

The maximal robustness of  $u^2$  for  $n = 2$  links is proven next.

**Proposition 10.** *Consider a parallel network consisting of 2 links, with lower and upper bounds on link weights as  $w^l \in \mathbb{R}_{>0}^2$  and  $w^u \in \mathbb{R}_{>0}^2$ , respectively, link capacities  $c \in \mathbb{R}_{>0}^2$ , and supply/demand with magnitude  $\alpha \geq 0$ . Then, for every  $\lambda \in \mathbb{R}_{>0}^2$  and  $w(0) \in [w^l, w^u]$ , under the dynamics in (4) with the controller  $u^2$  in (84), if  $\alpha < \alpha^*$  (cf. (66)), then  $\lim_{t \rightarrow +\infty} f(w(t)) \in [0, c]$ .*

*Proof:* Assumption 4 implies that, if the disturbance decreases the supply/ demand  $\alpha$ , then the flow on each link decreases, and hence  $u^2(t) \equiv 0$ . Therefore, the system is feasible. Hence, we only consider disturbances that increase  $\alpha$ , in which case (85) applies.



For  $n = 2$ , the optimal solution characterized in (66) and (67) can be explicitly written as shown in Table I.

Configuration	$(w_1^{\text{opt}}, w_2^{\text{opt}})$	$\alpha^*$
$c_1/c_2 < w_1^l/w_2^u$	$(w_1^l, w_2^u)$	$c_1(1 + w_2^u/w_1^l)$
$w_1^l/w_2^u \leq c_1/c_2 \leq w_1^u/w_2^l$	$w_1/w_2 = c_1/c_2$	$c_1 + c_2$
$c_1/c_2 > w_1^u/w_2^l$	$(w_1^u, w_2^l)$	$c_2(1 + w_1^u/w_2^l)$

TABLE I: Explicit characterization of  $\alpha^*$  and  $w^{\text{opt}}$  from (66) and (67), respectively, for  $n = 2$ .

(I) If  $\alpha < (w_1(0) + w_2(0)) \min\{c_1/w_1(0), c_2/w_2(0)\}$ , then it is straightforward to see that  $f(0) < c$ . Note that, due to (85), this does not imply  $u^2(0) = 0$ . Accordingly, we consider the following three cases.

(I-A) If  $w(0) = w^u$ , then  $u^2(t) \equiv 0$ , and hence  $\lim_{t \rightarrow +\infty} f(w(t)) = f(0) \in [0, c]$ .

(I-B) If  $w_1(0) < w_1^u$  and  $w_2(0) = w_2^u$ , then  $u_1(0) = \lambda_1 > 0$  and  $u_2(0) = 0$ .  $w_1(t)$  keeps increasing and  $w_2(t)$  stays unchanged, and consequently  $f_1(t)$  and  $f_2(t)$  keep increasing and decreasing, respectively, until either one of the following happens at some time  $\bar{t}$ :  $w_1(\bar{t}) = w_1^u$  or  $f_1(\bar{t}) = c_1$ . The weights do not change thereafter, and hence  $f_1(t) \leq c_1$  and  $f_2(t) < c_2$ , for all  $t \geq \bar{t}$ . The argument for the other scenario  $w_1(0) = w_1^u$  and  $w_2(0) < w_2^u$  is symmetrical.

(I-C) If  $w(0) < w^u$ , then  $u^2(0) = \lambda$  and hence  $\dot{f}_1(0^+) = -\dot{f}_2(0^+) = \alpha(\lambda_1 w_2(0) - \lambda_2 w_1(0)) / (w_1 + w_2)^2$ .

(I-C-i) If  $w_1(0)/w_2(0) = \lambda_1/\lambda_2$ , then  $\dot{f}_1(0^+) = \dot{f}_2(0^+) = 0$ , and hence  $u^2(t) \equiv 0$ .

(I-C-ii) If  $w_1(0)/w_2(0) < \lambda_1/\lambda_2$ , then  $\dot{f}_1(0^+) > 0$  and  $\dot{f}_2(0^+) < 0$ . This implies that  $w_1(t)$  keeps increasing and  $w_2(t)$  stays unchanged at  $t = 0$ , and hence the asymptotic behavior is the same as in Case (I-B).

Similar argument can be made for the other scenario when  $w_1(0)/w_2(0) > \lambda_1/\lambda_2$ .

(II) If  $\alpha = (w_1(0) + w_2(0)) \min\{c_1/w_1(0), c_2/w_2(0)\}$ , then  $f_1(0) = c_1$  or  $f_2(0) = c_2$ . Without loss of generality, assume  $f_2(0) = c_2$  and  $f_1(0) < c_1$ , in which case,  $w_1(t)$  keeps increasing and  $w_2(t)$  remains unchanged at  $t = 0$ , and the asymptotic behavior is the same as in Case (I-B).

(III) If  $(w_1(0) + w_2(0)) \min\{c_1/w_1(0), c_2/w_2(0)\} < \alpha \leq \alpha^*$ , then either  $f_1(0) > c_1$  and  $f_2(0) < c_2$ , or  $f_1(0) < c_1$  and  $f_2(0) > c_2$ . Without loss of generality, assume  $f_1(0) > c_1$  and  $f_2(0) < c_2$ . This implies  $c_1/c_2 < w_1(0)/w_2(0) \leq w_1^u/w_2^l$ . Then  $u_1(0) = -\lambda_1 < 0$  and  $u_2(0) = \lambda_2 > 0$ . Thereafter,  $w_1(t)$  and  $f_1(t)$  keep decreasing until either one of the following happens at  $t_1$ : (e1)  $w_1(t_1) = w_1^l$  or (e2)  $f_1(t_1) = c_1$ ; and  $w_2(t)$  and  $f_2(t)$  keep increasing until either one of the following happens at  $t_2$ : (e3)  $w_2(t_2) = w_2^u$  or (e4)  $f_2(t_2) = c_2$ .

We now consider the two cases:  $t_1 < t_2$  and  $t_2 < t_1$  separately (ties are broken arbitrarily).

(III-A)  $t_1 < t_2$ : we consider two sub-cases depending on which of (e1) or (e2) happens first.

(e1)  $w_1(t_1) = w_1^l$ ,  $f_1(t_1) \geq c_1$ ,  $f_2(t_1) < c_2$  and  $w_2(t_1) < w_2^u$ . In this case,  $w_1$  stops decreasing at  $t_1$ , but  $w_2$  keeps increasing until  $t_2$  when (e3) or (e4) happens.

If (e3) happens before (e4), then  $f_1(t_2) = \alpha w_1^l / (w_1^l + w_2^u) \leq c_1$ . Since (e4) has not occurred, then

$f_2(t_2) \leq c_2$ , and since the weights are at the boundary at  $t_2$ , they do not change thereafter.

If (e4) happens before (e3), then  $f_2(t_2) = c_2$ , and therefore,  $f_1(t_2) = \alpha - f_2(t_2) \leq c_1 + c_2 - f_2(t_2) \leq c_1$ .

(e2)  $f_1(t_1) = c_1$ ,  $w_1(t_1) \geq w_1^l$ ,  $f_2(t_1) < c_2$  and  $w_2(t_1) < w_2^u$ . In this case,  $w_1$  stops decreasing at  $t_1$ , but  $w_2$  keeps increasing until  $t_2$  when (e3) or (e4) happens. It is straightforward to see that the system is feasible under both of these scenarios.

(III-B)  $t_2 < t_1$ : we consider two sub-cases depending on which of (e3) or (e4) happens first.

(e3)  $w_2(t_2) = w_2^u$ ,  $w_1(t_2) > w_1^l$ ,  $f_1(t_2) > c_1$  and  $f_2(t_2) < c_2$ . In this case,  $w_2$  stops increasing at  $t_2$ , but  $w_1$  keeps decreasing until  $t_1$  when (e1) or (e2) happens. Indeed, in this case, (e2) always precedes (e1). This is because,  $\alpha \leq \alpha^*$  implies that, in all the relevant (*i.e.*, first and second) configurations in Table I,  $\alpha w_1^l / (w_1^l + w_2^u) \leq c_1$ . When (e2) happens,  $f_1(t_1) = c_1$ , and  $f_2(t_1) = \alpha - f_1(t_1) \leq c_1 + c_2 - f_1(t_1) \leq c_2$ .

(e4) This is not possible because (e4) never precedes (e2). This is because, by contradiction, if it does, then  $f_2(t_2) = c_2$  and  $f_1(t_2) > c_1$  implying  $\alpha = f_1(t_2) + f_2(t_2) > c_1 + c_2 \geq \alpha^*$ . ■

**Remark 20.**

- (a) Proposition 10 implies that  $u^2$  is maximally robust for parallel networks with 2 links. Moreover, this maximal robustness property of  $u^2$ , unlike  $u^1$ , does not require extra conditions on  $w(0)$ .
- (b) For parallel networks with 2 links, the action of the controller  $u^2$  can be shown to be a descent algorithm to solve (27).
- (c) Note that the proof of Proposition 10 implies that, under any disturbances, the asymptotic link weights under  $u^2$  are on the boundary in many scenarios. It is possible to address this feature by proper selection of  $\lambda_i$ ,  $i \in \{1, \dots, n\}$ , and by extending the criterion for a link to increase the weight. Robustness analysis under such extensions to general parallel networks will be reported in future.

**Remark 21.** For both  $u^1$  and  $u^2$ , it can be shown that the results of Theorem 2, Proposition 9 and Proposition 10 hold true for the case when  $w^l = 0$ .

## VIII. SIMULATIONS

We report numerical estimates of margin of robustness obtained from the various optimization methods proposed in this paper, along with the decentralized control policy  $u^1$  on a standard IEEE benchmark network, as well as equivalent capacity functions for the network shown in Figure 6. All the simulations were performed using Matlab 2015b on a desktop with the following configurations: Intel(R) Core(TM) i7-6700K CPU 4.00GHz and 16GB RAM.

### A. Margin of Robustness Estimates

Consider the IEEE 39 bus system shown in Figure 11 with the supply-demand vector  $p_0$  chosen to be such that  $p_{0,39} = 1$ ,  $p_{0,4} = -1$  and  $p_{0,v} = 0$  for every other node  $v$ . The corresponding terminal network obtained by the

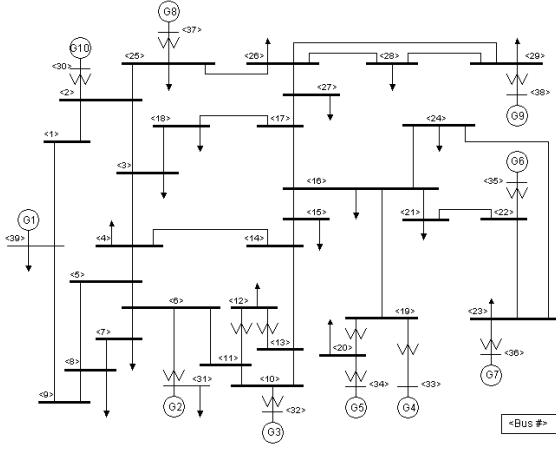

Fig. 11: IEEE 39 bus system

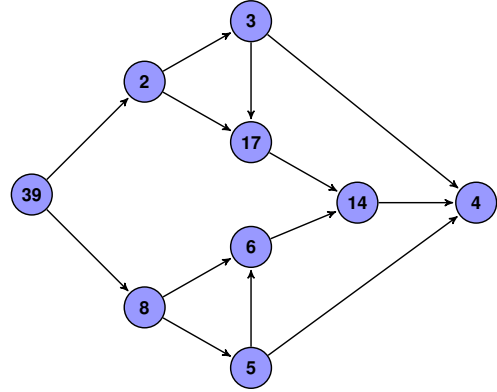

Fig. 12: The terminal network for IEEE 39 bus system

multilevel formulation is shown in Figure 12. The flow capacities on every link were chosen to be symmetrical:  $c^u = -c^l = 2.600 \mathbf{1}$ .  $w^u$  was selected to be the value of susceptances for this network provided by [32]. We consider multiplicative disturbances, *i.e.*, disturbances of the form  $\alpha p_0$ ,  $\alpha \in \mathbb{R}$ . For this case,  $\alpha^*$  is obtained by solving (14). The margin of robustness,  $\nu_M^*$  in this case can be obtained from  $\alpha^*$  using (15). Therefore, we present our results in this section in terms of  $\alpha^*$ .

Without weight control, *i.e.*, when  $w^l = w^u$ ,  $\alpha^* = 4.725$ . Under weight control, Proposition 2 implies that  $\alpha^* \leq 5.200$ . We compared the solution to (14) obtained from the following three methods:

- 1) exhaustive search method for the original as well as the multilevel formulation as described in Algorithm 1;
- 2) random search method for the original as well as the multilevel formulation as described in Algorithm 1;
- 3) sub-gradient projection method described in Section IV-C.

For the exhaustive search method, the set  $[w^l, w^u]$  is discretized with resolution 0.5, and the cost function is evaluated at each of these discrete points according to a natural lexicographical order. In the random search method, the points for evaluation of the cost function are chosen random according to a uniform distribution over  $[w^l, w^u]$ . For both these methods, we choose  $w^l = 0.95w^u$ .

For the exhaustive search method, the average time for evaluation of a single feasible for the original and the multilevel formulation was  $1.24 \times 10^{-4}$  and  $7.68 \times 10^{-5}$  seconds respectively, illustrating the computational gains per evaluation from the network reduction procedure underlying the multilevel formulation. For the original formulation, due to the large number of feasible discrete points, it was found to be impractical to exhaustively evaluate the cost function at each of these discrete points. However, for the multilevel formulation, the exhaustive search method terminated in about 59.3 hours yielding  $\alpha^* \approx 4.806$ .

For the random search method, we performed 10 runs, each for 30 minutes. The average and the maximum values of  $\alpha^*$  obtained for the original formulation are 4.825 and 4.822 respectively, and for the multilevel formulation are 4.831 and 4.830 respectively. These values also illustrate computational advantage of the multilevel formulation.

For the projected sub-gradient method, a larger controllable weight range was used by setting  $w^l = 0.5w^u$  and the step size of the descent method was chosen to be 0.2. The estimates of  $\alpha^*$  using this method for different initial points were found to be 5.200, which matches the upper bound. This suggests convergence of the projected sub-gradient method to an optimal solution. This is to be contrasted with possible theoretical results which only ensure convergence to a critical point. These observations, along with better performance of random search in comparison to exhaustive search suggest that optimal solutions are dense. Further analysis of this aspect is left to future work.

Under controller  $u^1$  with  $w(0) = w^u$ , the estimate of  $\alpha^*$  was also found to be 5.200, suggesting optimality of  $u^1$  for this setting. This is to be contrasted with point 2) in Remark 19 (b), which guarantees optimality of  $u^1$  only for parallel networks.

### B. Equivalent Capacities for Tree Reducible Networks

Consider the network shown in Fig. 6 with nodes  $v_1$  and  $v_4$  being the supply and demand nodes, respectively, and the weights bounds and link capacities are selected as follows:  $w^l = [4 \ 3 \ 4 \ 1 \ 2]^T$ ,  $w^u = [9 \ 10 \ 18 \ 5 \ 8]^T$ , and  $c = [16 \ 18 \ 20 \ 10 \ 10]^T$ . The equivalent capacities for sub-networks formed during the sequential reduction process described in Section VI, are illustrated in Figure 13. Note that each of the equivalent capacity function is  $\mathcal{S}_1$  function.

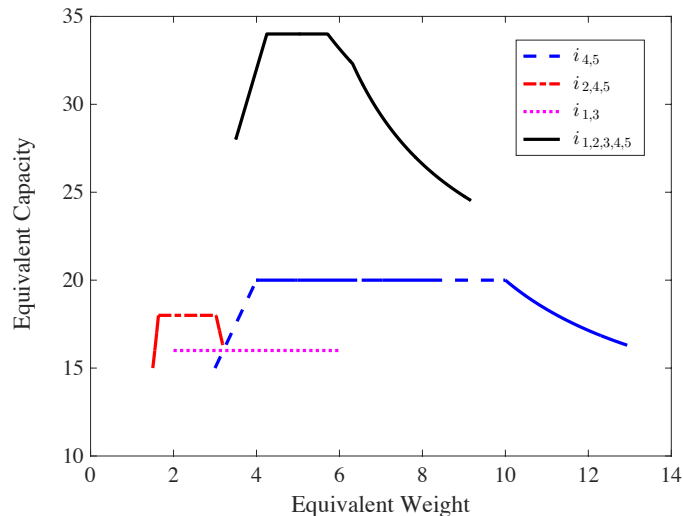

Fig. 13: The equivalent capacity functions in the process of tree reduction for the network shown in Fig. 6.

## IX. CONCLUSION AND FUTURE WORK

In this paper, we studied robustness of control policies for DC power networks, that use information about link flows and weights, and disturbance to change line weights in order to ensure that the line flows remain within

prescribed limits. Robust control design in the centralized case can be cast as an optimization problem, which is non-convex in general. We proposed a gradient descent algorithm for multiplicative perturbations, and a multilevel programming approach, which lead to substantial computational savings when adopting exhaustive search solution technique for reducible networks. We also presented robustness analysis of natural decentralized control policies. Beyond the robust weight control problem, the paper makes a few contributions which are of independent interest, including exact derivation of the flow-weight Jacobian, characterization of a class of decomposable non-convex network optimization problems, and formalization of the notion of equivalent transmission capacity for a DC power network. The results of this paper collectively provide a new set of analytical tools for DC power networks in general, and for online susceptance control in particular.

This paper opens up several directions for future research. We plan to investigate extensions of the proposed methodologies, possibly under suitable approximations, when key assumptions in this paper are relaxed. This includes generalization to the case of additive disturbances and to networks which are not reducible. Designing distributed control policies for non-parallel networks with provable robustness guarantees is also an important direction of research. Finally, we plan to evaluate the performance of the proposed control policies on AC power flow models, possibly under linear approximations, *e.g.*, as proposed in [33].

#### REFERENCES

- [1] Q. Ba and K. Savla, "On decentralized robust weight control for DC power networks," in *American Control Conference*, (Boston, MA), pp. 5933–5938, 2016.
- [2] R. P. Klump and T. J. Overbye, "Assessment of transmission system loadability," *Power Systems, IEEE Transactions on*, vol. 12, no. 1, pp. 416–423, 1997.
- [3] M. Saravanan, S. M. R. Slochanal, P. Venkatesh, and J. P. S. Abraham, "Application of particle swarm optimization technique for optimal location of FACTS devices considering cost of installation and system loadability," *Electric Power Systems Research*, vol. 77, no. 3, pp. 276–283, 2007.
- [4] S. Gerbex, R. Cherkaoui, and A. J. Germond, "Optimal location of multi-type FACTS devices in a power system by means of genetic algorithms," *Power Systems, IEEE Transactions on*, vol. 16, no. 3, pp. 537–544, 2001.
- [5] G. Hug-Glanzmann and G. Andersson, "Decentralized optimal power flow control for overlapping areas in power systems," *Power Systems, IEEE Transactions on*, vol. 24, no. 1, pp. 327–336, 2009.
- [6] S. Singh and A. David, "Optimal location of FACTS devices for congestion management," *Electric Power Systems Research*, vol. 58, no. 2, pp. 71–79, 2001.
- [7] S. Gerbex, R. Cherkaoui, and A. Germond, "Optimal location of FACTS devices to enhance power system security," in *Power Tech Conference Proceedings, 2003 IEEE Bologna*, vol. 3, pp. 7–pp, IEEE, 2003.
- [8] W. Shao and V. Vittal, "LP-based OPF for corrective FACTS control to relieve overloads and voltage violations," *IEEE Transactions on Power Systems*, vol. 21, no. 4, pp. 1832–1839, 2006.
- [9] D. Bienstock and A. Verma, "The n-k problem in power grids: New models, formulations, and numerical experiments," *SIAM Journal on Optimization*, vol. 20, no. 5, pp. 2352–2380, 2010.
- [10] K. W. Hedman, S. S. Oren, and R. P. O'Neill, "A review of transmission switching and network topology optimization," in *2011 IEEE power and energy society general meeting*, pp. 1–7, IEEE, 2011.
- [11] A. J. Wood and B. F. Wollenberg, *Power generation, operation, and control*. John Wiley & Sons, 2012.
- [12] C. Lai and S. H. Low, "The redistribution of power flow in cascading failures," in *51st Annual Allerton Conference on Communication, Control, and Computing*, pp. 1037–1044, 2013.
- [13] D. Bienstock, *Electrical Transmission System Cascades and Vulnerability: An Operations Research Viewpoint*, vol. 22. SIAM, 2016.

- [14] R. Diestel, “Graph theory, volume 173 of graduate texts in mathematics,” 2005.
- [15] U. Von Luxburg, “A tutorial on spectral clustering,” *Statistics and computing*, vol. 17, no. 4, pp. 395–416, 2007.
- [16] H. You, V. Vittal, and Z. Yang, “Self-healing in power systems: an approach using islanding and rate of frequency decline-based load shedding,” *Power Systems, IEEE Transactions on*, vol. 18, no. 1, pp. 174–181, 2003.
- [17] H. You, V. Vittal, and X. Wang, “Slow coherency-based islanding,” *Power Systems, IEEE Transactions on*, vol. 19, no. 1, pp. 483–491, 2004.
- [18] G. Andersson, P. Donalek, R. Farmer, N. Hatziaargyriou, I. Kamwa, P. Kundur, N. Martins, J. Paserba, P. Pourbeik, J. Sanchez-Gasca, *et al.*, “Causes of the 2003 major grid blackouts in north america and europe, and recommended means to improve system dynamic performance,” *Power Systems, IEEE Transactions on*, vol. 20, no. 4, pp. 1922–1928, 2005.
- [19] G. Como, K. Savla, D. Acemoglu, M. A. Dahleh, and E. Frazzoli, “Robust distributed routing in dynamical networks – part I: Locally responsive policies and weak resilience,” *IEEE Trans. on Automatic Control*, vol. 58, no. 2, pp. 317–332, 2013.
- [20] G. Como, K. Savla, D. Acemoglu, M. A. Dahleh, and E. Frazzoli, “Robust distributed routing in dynamical networks – part II: Strong resilience, equilibrium selection and cascaded failures,” *IEEE Trans. on Automatic Control*, vol. 58, no. 2, pp. 333–348, 2013.
- [21] D. Bertsimas and J. N. Tsitsiklis, *Introduction to linear optimization*, vol. 6. Athena Scientific Belmont, MA, 1997.
- [22] B. Korte and J. Vygen, *Combinatorial Optimization: Theory and Algorithms*. Springer, 2002.
- [23] D. P. Bertsekas, *Network optimization: continuous and discrete models*. Athena Scientific Belmont, 1998.
- [24] G. H. Golub and V. Pereyra, “The differentiation of pseudo-inverses and nonlinear least squares problems whose variables separate,” *SIAM Journal on numerical analysis*, vol. 10, no. 2, pp. 413–432, 1973.
- [25] D. Behmardi and E. Nayeri, “Introduction of Fréchet and Gâteaux derivative,” *Applied Mathematical Sciences*, vol. 2, no. 20, pp. 975–980, 2008.
- [26] Q. Ba and K. Savla, “A dynamic programming approach to optimal load shedding control of cascading failure in DC power networks.” Extended version. Available at <http://www-bcf.usc.edu/~ksavla/papers/Ba.Savla.CDC16-ext.pdf>.
- [27] B. Wollenberg and A. Wood, “Power generation, operation and control,” *John Wiley&Sons, Inc.*, pp. 264–327, 1996.
- [28] D. P. Bertsekas, *Convex optimization algorithms*. Athena Scientific Belmont, 2015.
- [29] D. P. Bertsekas, *Nonlinear programming*. Athena scientific Belmont, 1999.
- [30] P. Snell and P. Doyle, “Random walks and electric networks,” *Free Software Foundation*, 2000.
- [31] I. Gitler and F. Sagols, “On terminal delta-wye reducibility of planar graphs,” *Networks*, vol. 57, no. 2, pp. 174–186, 2011.
- [32] R. D. Zimmerman, C. E. Murillo-Sánchez, and R. J. Thomas, “Matpower: Steady-state operations, planning, and analysis tools for power systems research and education,” *Power Systems, IEEE Transactions on*, vol. 26, no. 1, pp. 12–19, 2011.
- [33] C. Coffrin and P. Van Hentenryck, “A linear-programming approximation of AC power flows,” *INFORMS Journal on Computing*, vol. 26, no. 4, pp. 718–734, 2014.
- [34] R. T. Rockafellar, *Convex Analysis*. Princeton University Press, 1970.

## APPENDIX

### A. Laplacian Matrix of Reduced Simple Graphs

Consider the following notion of a simple graph corresponding to a given multigraph.

**Definition 10** (Reduced Simple Graph). *Given a multigraph  $\mathcal{G} = (\mathcal{V}, \mathcal{E})$ , the corresponding reduced simple graph is denoted as  $\mathcal{G}^s = (\mathcal{V}^s, \mathcal{E}^s)$ , where  $\mathcal{V}^s = \mathcal{V}$ , and  $\mathcal{E}^s \subseteq \mathcal{E}$  is constructed as follows. For every node pair  $\{v_1, v_2\} \in \mathcal{V} \times \mathcal{V}$ , for all the links from  $v_1$  to  $v_2$  in  $\mathcal{E}$ , there exists only one link from  $v_1$  to  $v_2$  in  $\mathcal{E}^s$ ; if there is no link from  $v_1$  to  $v_2$  in  $\mathcal{E}$ , then there is no link from  $v_1$  to  $v_2$  in  $\mathcal{E}^s$ . For every  $i \in \mathcal{E}^s$ , let  $\mathcal{M}_i$  be the corresponding links in  $\mathcal{E}$ . The weight matrix for  $\mathcal{G}^s$ , denoted as  $W^s \in \mathbb{R}_{>0}^{\mathcal{E}^s \times \mathcal{E}^s}$ , is defined as  $w_i^s := \sum_{j \in \mathcal{M}_i} w_j$  for all  $i \in \mathcal{E}^s$ .*

Let  $A_{\mathcal{G}^s}$  denote the node-link incidence matrix of  $\mathcal{G}^s$ . The next result states that the weighted Laplacians of  $\mathcal{G}$  and  $\mathcal{G}^s$  are equal.

**Lemma 13.** Let  $L_G$  and  $L_{G^s}$  be the weighted Laplacian matrices associated with a multigraph  $G$  and its reduced simple graph  $G^s$  (cf. Definition 10), respectively. Then,  $L_G = L_{G^s}$ .

*Proof:* Definition 1 of the Laplacian implies that

$$L_{G^s} = A_{G^s} W^s A_{G^s}^T = \sum_{i \in \mathcal{E}^s} a_i^s w_i^s a_i^{sT} = \sum_{i \in \mathcal{E}^s} a_i^s \left( \sum_{j \in \mathcal{M}_i} w_j \right) a_i^{sT} = \sum_{j \in \mathcal{E}} a_j w_j a_j^T = L_G$$

where  $a_i^s$  is the  $i$ -th column of  $A_{G^s}$ ,  $a_j$  is the  $j$ -th column of  $A$ ,  $w_i^s$  is the  $i$ -th diagonal element of  $w^s$ , and the fourth equality is due to the fact that  $a_j = a_i^s$  for all  $j \in \mathcal{M}_i$ ,  $i \in \mathcal{E}^s$ . ■

### B. Flow Solution for DC Power Network

Lemma 1 gives the link flows for a DC power network for given link weights and supply-demand vector. One can alternately obtain these link flows as solution to a quadratic program, as formalized next.

**Lemma 14.** Consider a network with graph topology  $\mathcal{G} = (\mathcal{V}, \mathcal{E})$ , link weights  $w \in \mathbb{R}_{>0}^{\mathcal{E}}$  and supply-demand vector  $p \in \mathbb{R}^{\mathcal{V}}$ . The unique solution  $f \in \mathbb{R}^{\mathcal{E}}$  satisfying (1) is the solution to the following:

$$\begin{aligned} \min_{z \in \mathbb{R}^{\mathcal{E}}} \quad & z^T W^{-1} z \\ \text{subject to} \quad & Az = p \end{aligned} \tag{86}$$

*Proof:* With  $z_w := W^{-1/2} z$  and  $A_w := AW^{1/2}$ , (86) can be rewritten as  $\min_{z_w \in \mathbb{R}^{\mathcal{E}}} z_w^T z_w$  subject to  $A_w z_w = p$ , i.e., finding the minimum 2-norm solution to  $A_w z_w = p$ . Since  $p$  is balanced, and the network is connected, the minimum 2-norm solution is given by  $f_w^* = A_w^\dagger p = A_w^T (A_w A_w^T)^\dagger p = A_w^T L^\dagger p$ . Reversing the scaling by  $W^{1/2}$ , this can be rewritten as  $W^{-1/2} f^* = W^{1/2} A^T L^\dagger p$ , i.e.,  $f^* = WA^T L^\dagger p$ , which has been shown in Lemma 1 to be the unique  $f \in \mathbb{R}^{\mathcal{E}}$  satisfying (1). ■

**Remark 22.** Lemma 14 is proved in [12] through a different method, using Lagrange multipliers.

The following result shows that the flow on every link, under a DC power flow model, is no greater than the total supply/demand. The latter is equal to  $\|p\|_1/2$ .

**Lemma 15.** Consider a network with graph topology  $\mathcal{G} = (\mathcal{V}, \mathcal{E})$ , link weights  $w \in \mathbb{R}_{>0}^{\mathcal{E}}$  and supply-demand vector  $p \in \mathbb{R}^{\mathcal{V}}$ . The unique solution  $f \in \mathbb{R}^{\mathcal{E}}$  to (1) satisfies

$$|f_i(w, p)| \leq \|p\|_1/2, \quad \forall i \in \mathcal{E}$$

*Proof:* Let  $\tilde{\mathcal{E}}$  be the union of links in  $\mathcal{E}$  with positive flows and reverse of links in  $\mathcal{E}$  with negative flows. Note that  $\tilde{\mathcal{E}}$  does not contain links with zero flow, and that the flows on links in  $\tilde{\mathcal{E}}$  is positive, i.e.,  $\tilde{f} > 0$ . Therefore, in order to show the lemma, we need to show that  $\tilde{f}_i \leq \|p\|_1/2$  for all  $i \in \tilde{\mathcal{E}}$ .

It is easy to see that  $\tilde{\mathcal{G}} := (\mathcal{V}, \tilde{\mathcal{E}})$  does not contain cycles. This is because, for every cycle  $\mathcal{C} \in \tilde{\mathcal{E}}$ , one can construct a different flow  $\tilde{f}' := \tilde{f} - \mathbf{1}_{\mathcal{C}} \min_{j \in \mathcal{C}} \tilde{f}_j$  for  $\tilde{\mathcal{E}}$ , and hence the corresponding flow  $f'$  for the original graph  $\mathcal{G}$ . This construction of  $\tilde{f}'$  implies that  $|f'| \leq |f|$ , with the inequality being strict on at least one component,

and hence  $f'^T W^{-1} f' < f^T W^{-1} f$ , and that  $f'$  also satisfies flow conservation, *i.e.*, it is a feasible point for (86). Lemma 14 then leads to a contradiction that  $f$  is the solution to (1).

Since  $\tilde{\mathcal{G}}$  does not contain cycles, every path in  $\tilde{\mathcal{G}}$  containing  $i \in \tilde{\mathcal{E}}$  is a supply-demand path. Therefore, for all  $i \in \tilde{\mathcal{E}}$ ,  $\tilde{f}_i$  is no greater than the sum of supply/demand associated with paths containing  $i$ , which in turn is no greater than the sum of total supply/demand in the network, *i.e.*,  $\|p\|_1/2$ . ■

### C. Minimizing A Quasi-concave Function over A Polytope

A *polytope* is the convex hull of finitely many points  $\{b_1, \dots, b_m\}$  [34, p. 12].

**Lemma 16.** *Let  $h : \mathbb{R}^n \rightarrow \mathbb{R}$  be a quasi-concave function and  $S \subset \mathbb{R}^n$  be a polytope whose elements can be expressed as convex combinations of  $b_1, \dots, b_m$ . Then,  $\min_{x \in S} h(x) = \min_{i \in \{1, \dots, m\}} h(b_i)$ .*

*Proof:* We prove by contradiction. Suppose  $\operatorname{argmin}_{x \in S} h(x) \cap \{b_1, \dots, b_m\} = \emptyset$ . Since  $S$  is the convex hull of  $\{b_1, \dots, b_m\}$ , for any  $x^* \in \operatorname{argmin}_{x \in S} h(x)$ , there exist  $\eta_k \geq 0, k \in \{1, \dots, m\}$ , with  $\sum_{k=1}^m \eta_k = 1$  such that  $x^* = \sum_{k=1}^m \eta_k b_k$ . Since  $x^* \notin \{b_1, \dots, b_m\}$  by assumption, we have  $\eta_k < 1$  for all  $k \in \{1, \dots, m\}$ . Quasi-concavity of  $h(x)$  then implies:

$$h(x^*) = h\left(\sum_{k=1}^m \eta_k b_k\right) = h\left(\eta_1 b_1 + (1 - \eta_1) \sum_{k=2}^m \frac{\eta_k}{1 - \eta_1} b_k\right) \geq \min\{h(b_1), h\left(\sum_{k=2}^m \frac{\eta_k}{1 - \eta_1} b_k\right)\} \quad (87)$$

where, in the second equality, it is easy to see that, due to  $\sum_{k=2}^m \eta_k = 1 - \eta_1$ , we have  $\sum_{k=2}^m \frac{\eta_k}{1 - \eta_1} b_k \in S$ . Recursive application of (87) then implies  $h(x^*) \geq \min_{k \in \{1, \dots, m\}} h(b_k)$ <sup>10</sup>, giving a contradiction. ■

### D. Derivative of Pseudoinverse of Laplacian Matrix

The following is an adaptation of the result from [24] on the derivative of the pseudo-inverse of a matrix.

**Theorem 3.** *Let  $\mathcal{X} \subset \mathbb{R}$  be an open set, and  $P(x) \in \mathbb{R}^{m \times n}$ ,  $x \in \mathcal{X}$ , be a Fréchet differentiable matrix function with local constant rank in  $\mathcal{X}$ . Then for any  $x \in \mathcal{X}$ ,*

$$\frac{dP^\dagger(x)}{dx} = -P^\dagger \frac{dP}{dx} P^\dagger + P^\dagger P^{\dagger T} \frac{dP^T}{dx} (I - PP^\dagger) + (I - P^\dagger P) \frac{dP^T}{dx} P^{\dagger T} P^\dagger$$

where  $P^\dagger$  is the pseudo-inverse of  $P$ .

*Proof:* The local constant rank condition ensures that  $P^\dagger(x)$  and  $P(x)$  are continuous and differentiable in the calculations to follow. Since  $P^\dagger$  is the pseudo-inverse of matrix  $P$ , we have  $PP^\dagger P = P$  and  $P^\dagger PP^\dagger = P^\dagger$ . Then

$$\frac{dP}{dx} = \frac{d(PP^\dagger P)}{dx} = \frac{d(PP^\dagger)}{dx} P + PP^\dagger \frac{dP}{dx}$$

Multiplying from the right by  $P^\dagger$  and re-arranging, we get

$$\frac{d(PP^\dagger)}{dx} (PP^\dagger) = \frac{dP}{dx} P^\dagger - PP^\dagger \frac{dP}{dx} P^\dagger = (I - PP^\dagger) \frac{dP}{dx} P^\dagger$$

<sup>10</sup>If  $\eta_k = 0$  for some  $k \in \{1, \dots, m\}$ , then we exclude  $h(b_k)$  for that  $k$  from the minimization.



Since  $(PP^\dagger)(PP^\dagger) = PP^\dagger$  and  $PP^\dagger$  is symmetric,

$$\begin{aligned} \frac{d(PP^\dagger)}{dx} &= \frac{d(PP^\dagger)^2}{dx} = \frac{d(PP^\dagger)}{dx}(PP^\dagger) + (PP^\dagger)\frac{d(PP^\dagger)}{dx} \\ &= \frac{d(PP^\dagger)}{dx}(PP^\dagger) + \left[ \frac{d(PP^\dagger)}{dx}(PP^\dagger) \right]^\top \\ &= (I - PP^\dagger)\frac{dP}{dx}P^\dagger + P^{\dagger\top}\frac{dP^\top}{dx}(I - PP^\dagger) \end{aligned} \quad (88)$$

Likewise, we can get

$$\frac{d(P^\dagger P)}{dx} = P^\dagger\frac{dP}{dx}(I - P^\dagger P) + (I - P^\dagger P)\frac{dP^\top}{dx}P^{\dagger\top} \quad (89)$$

Since  $P^\dagger = P^\dagger PP^\dagger$ , we have following identities.

$$\frac{dP^\dagger}{dx} = \frac{d(P^\dagger PP^\dagger)}{dx} = \frac{dP^\dagger}{dx}PP^\dagger + P^\dagger\frac{d(PP^\dagger)}{dx} \quad (90a)$$

$$\frac{dP^\dagger}{dx} = \frac{d(P^\dagger PP^\dagger)}{dx} = \frac{d(P^\dagger P)}{dx}P^\dagger + P^\dagger P\frac{dP^\dagger}{dx} \quad (90b)$$

$$\frac{dP^\dagger}{dx} = \frac{d(P^\dagger PP^\dagger)}{dx} = \frac{dP^\dagger}{dx}PP^\dagger + P^\dagger\frac{dP}{dx}P^\dagger + P^\dagger P\frac{dP^\dagger}{dx} \quad (90c)$$

Computing (90a) + (90b) – (90c), and substituting the resulting expression in (88) and (89), gives the theorem. ■

### E. Derivatives of $g(w_{\text{eq}})$

In this section, we provide explicit expression for the derivatives defined in (53). The derivatives depend on active links, which for the left derivative of  $g$ , are defined as  $\mathcal{K}^+(x) := \{i \in \mathcal{E} \mid \psi_i(w_i^l) < x\}$  for  $x \in [g^l, g_{\max}]$ , and  $\mathcal{K}^-(x) := \{i \in \mathcal{E} \mid \psi_i(w_i^u) < x\}$  for  $x \in [g^u, g_{\max}]$ . The left derivative, for  $w_{\text{eq}} \in (w_{\text{eq}}^l, \hat{g}^+(g_{\max}))$ , is then given by:

$$g'(w_{\text{eq}}^-) = \frac{1}{\hat{g}^{+\prime}(x^-)} \Big|_{x=g(w_{\text{eq}})} = \left( \sum_{i \in \mathcal{K}^+(g(w_{\text{eq}}))} \frac{\partial \mathcal{H}(w)/\partial w_i}{\psi'_i(w_i^-)} \right)^{-1} \Big|_{w=\omega^+(g(w_{\text{eq}}))}$$

where  $\hat{g}^{+\prime}(x^-)$  and  $\psi'_i(w_i^-)$  denote left derivatives, similar to  $g'(w_{\text{eq}}^-)$ ; the first equality is because  $\hat{g}^+$  is inverse of  $g$ , and the second equality follows from chain rule. Following along the same lines, all the left and right derivatives

of  $g$  are gathered as:

$$\begin{aligned}
 g'(w_{\text{eq}}^-) &= \begin{cases} \left( \sum_{i \in \mathcal{K}^+(g(w_{\text{eq}}))} \frac{\partial \mathcal{H}(w)/\partial w_i}{\psi'_i(w_i^-)} \right)^{-1} \Big|_{w=\omega^+(g(w_{\text{eq}}))} & w_{\text{eq}} \in (w_{\text{eq}}^l, \hat{g}^+(g_{\text{max}})] \\ 0 & w_{\text{eq}} \in (\hat{g}^+(g_{\text{max}}), \hat{g}^-(g_{\text{max}})] \\ \left( \sum_{i \in \tilde{\mathcal{K}}^-(g(w_{\text{eq}}))} \frac{\partial \mathcal{H}(w)/\partial w_i}{\psi'_i(w_i^-)} \right)^{-1} \Big|_{w=\omega^-(g(w_{\text{eq}}))} & w_{\text{eq}} \in (\hat{g}^-(g_{\text{max}}), w_{\text{eq}}^u] \end{cases} \\
 g'(w_{\text{eq}}^+) &= \begin{cases} \left( \sum_{i \in \tilde{\mathcal{K}}^+(g(w_{\text{eq}}))} \frac{\partial \mathcal{H}(w)/\partial w_i}{\psi'_i(w_i^+)} \right)^{-1} \Big|_{w=\omega^+(g(w_{\text{eq}}))} & w_{\text{eq}} \in [w_{\text{eq}}^l, \hat{g}^+(g_{\text{max}})) \\ 0 & w_{\text{eq}} \in [\hat{g}^+(g_{\text{max}}), \hat{g}^-(g_{\text{max}})) \\ \left( \sum_{i \in \mathcal{K}^-(g(w_{\text{eq}}))} \frac{\partial \mathcal{H}(w)/\partial w_i}{\psi'_i(w_i^+)} \right)^{-1} \Big|_{w=\omega^-(g(w_{\text{eq}}))} & w_{\text{eq}} \in [\hat{g}^-(g_{\text{max}}), w_{\text{eq}}^u) \end{cases}
 \end{aligned} \tag{91}$$

where  $\tilde{\mathcal{K}}^+(x) := \{i \in \mathcal{E} \mid \psi_i(w_i^l) \leq x\}$  for  $x \in [g^l, g_{\text{max}}]$ , and  $\tilde{\mathcal{K}}^-(x) := \{i \in \mathcal{E} \mid \psi_i(w_i^u) \leq x\}$  for  $x \in [g^u, g_{\text{max}}]$ .