

# The $Z$ -invariant massive Laplacian on isoradial graphs

Cédric Boutillier\*      Béatrice de Tilière†      Kilian Raschel‡

March 4, 2022

## Abstract

We introduce a one-parameter family of massive Laplacian operators  $(\Delta^{m(k)})_{k \in [0,1]}$  defined on isoradial graphs, involving elliptic functions. We prove an explicit formula for the inverse of  $\Delta^{m(k)}$ , the massive Green function, which has the remarkable property of only depending on the local geometry of the graph, and compute its asymptotics. We study the corresponding statistical mechanics model of random rooted spanning forests. We prove an explicit local formula for an infinite volume Boltzmann measure, and for the free energy of the model. We show that the model undergoes a second order phase transition at  $k = 0$ , thus proving that spanning trees corresponding to the Laplacian introduced by Kenyon [Ken02] are critical. We prove that the massive Laplacian operators  $(\Delta^{m(k)})_{k \in (0,1)}$  provide a one-parameter family of  $Z$ -invariant rooted spanning forest models. When the isoradial graph is moreover  $\mathbb{Z}^2$ -periodic, we consider the spectral curve of the characteristic polynomial of the massive Laplacian. We provide an explicit parametrization of the curve and prove that it is Harnack and has genus 1. We further show that every Harnack curve of genus 1 with  $(z, w) \leftrightarrow (z^{-1}, w^{-1})$  symmetry arises from such a massive Laplacian.

## 1 Introduction

An *isoradial graph*  $G = (V, E)$  is a planar embedded graph such that all faces are inscribable in a circle of radius 1. In this paper we introduce a one-parameter family of *massive Laplacian operators*  $(\Delta^{m(k)})_{k \in [0,1]}$  defined on infinite isoradial graphs, and study its remarkable properties. The massive Laplacian operator  $\Delta^{m(k)} : \mathbb{C}^V \rightarrow \mathbb{C}^V$  involves elliptic functions, it is defined by

$$(\Delta^{m(k)} f)(x) = \sum_{y \sim x} \rho(\theta_{xy} | k) [f(x) - f(y)] + m^2(x|k) f(x), \quad (1)$$

---

\*Laboratoire de Probabilités et Modèles Aléatoires, Université Pierre et Marie Curie, 4 place Jussieu, F-75005 Paris. Email: [cedric.boutillier@upmc.fr](mailto:cedric.boutillier@upmc.fr)

†Laboratoire d'Analyse et de Mathématiques Appliquées, Université Paris-Est Créteil, 61, avenue du Général de Gaulle F-94010 Créteil. Email: [beatrice.taupinart-de-tiliere@upec.fr](mailto:beatrice.taupinart-de-tiliere@upec.fr)

‡CNRS, Laboratoire de Mathématiques et Physique Théorique, Université de Tours, Parc de Grandmont, F-37200 Tours. Email: [kilian.raschel@lmpt.univ-tours.fr](mailto:kilian.raschel@lmpt.univ-tours.fr)

where  $k \in [0, 1)$  is the elliptic modulus,  $\theta_{xy} = \bar{\theta}_{xy} \frac{2K}{\pi}$ , the constant  $K = K(k)$  is the complete elliptic integral of the first kind, and  $\bar{\theta}_{xy}$  is an angle naturally assigned to the edge  $xy$  in the isoradial embedding of  $\mathbf{G}$ . The conductance  $\rho(\theta_{xy}|k)$  and the mass  $m^2(x|k)$  are given by

$$\rho(\theta_{xy}|k) = \text{sc}(\theta_{xy}|k), \quad (2)$$

$$m^2(x|k) = \sum_{y \sim x} [\text{A}(\theta_{xy}|k) - \rho(\theta_{xy}|k)], \quad (3)$$

where  $\text{sc}$  is one of Jacobi's twelve elliptic functions and the function  $\text{A}$ , related to integrals of squared Jacobi elliptic functions, is defined in Equation (8). More details are to be found in Section 2.2.

The first of the main results is an explicit formula for the inverse operator, namely for the massive Green function  $G^{m(k)}$ , see also Theorem 12 for a detailed version.

**Theorem 1.** *Let  $\mathbf{G}$  be an infinite isoradial graph, and let  $k \in (0, 1)$ . Then, for every pair of vertices  $x, y$  of  $\mathbf{G}$ , the massive Green function  $G^{m(k)}(x, y)$  has the following explicit expression:*

$$G^{m(k)}(x, y) = \frac{k'}{4i\pi} \int_{\mathbf{C}_{x,y}} \mathbf{e}_{(x,y)}(u|k) du, \quad (4)$$

where  $k' = \sqrt{1 - k^2}$ ,  $\mathbf{e}_{(x,y)}(\cdot|k)$  is the discrete massive exponential function,  $\mathbf{C}_{x,y}$  is a vertical contour on the torus  $\mathbb{T}(k) = \mathbb{C}/(4K\mathbb{Z} + 4iK'\mathbb{Z})$  whose direction is given by the angle of the ray  $\mathbb{R}\vec{x}\vec{y}$ .

Before describing the context of Theorem 1, let us give its main features.

- The discrete exponential function  $\mathbf{e}_{(x,y)}(\cdot|k)$  is defined in Section 3.3 using a path of the embedded graph from  $x$  to  $y$ . This implies that the expression (4) for  $G^{m(k)}(x, y)$  is *local*, meaning that it remains unchanged if the isoradial graph  $\mathbf{G}$  is modified away from a path from  $x$  to  $y$ . This is a remarkable fact since, when computing the inverse of a discrete operator, one expects the geometry of the whole graph to be involved.
- There is no periodicity assumption on the graph  $\mathbf{G}$ .
- The discrete massive exponential function is explicit and has a product structure; it has identified poles, so that computations can be performed using the residue theorem, see Appendix B for some examples.
- The explicit expression (4) is suitable for asymptotic analysis. Using a saddle-point analysis, we prove explicit exponential decay of the Green function, see Theorem 14.

**Context.** Local formulas for inverse operators have first been proved in [Ken02]. Kenyon considers two operators on isoradial graphs: the Laplacian with conductances  $(\tan(\bar{\theta}_e))_{e \in \mathbf{E}}$  and the Kasteleyn operator arising from the bipartite dimer model with edge-weights  $(2 \sin(\bar{\theta}_e))$ .

In the same vein, the first two authors of this paper proved a local formula for the inverse Kasteleyn operator of a non-bipartite dimer model corresponding to the critical Ising model defined on isoradial graphs [BdT10].

The two papers [Ken02, BdT10] have the common feature of considering *critical* models: the polynomial decay of the inverse Kasteleyn operator proves that the bipartite dimer model is indeed critical; Ising weights of [BdT10] have recently been proved to be critical [Li12, CD13, Lis14]; Laplacian conductances are called critical (although it not so clear from [Ken02] why they should be). This led to the belief that existence of a local formula for an inverse operator is related to the geometric property of the embedded isoradial graph *and* criticality of the underlying model. In this paper, we go further and prove a local formula for a one-parameter family of *non-critical* models. Indeed, underlying the massive Laplacian is the model of rooted spanning forests, which is *not* critical, as explained in Section 6.

The idea of the proof of the local formula for the inverse of the Laplacian operator  $\Delta$  given in [Ken02] is the following: find a one-parameter family of local complex-valued functions in the kernel of  $\Delta$ , define its inverse  $G$  as a contour integral of these functions against a singular function, and choose the contour of integration in such a way that  $\Delta G = \text{Id}$ . The problem is that this proof neither provides a way of choosing the weights of the operator, nor a criterion for existence of a one-parameter family of local functions, nor a way to find them, if they exist. This is why one of the main contributions of this paper is to actually define a one-parameter family of weights for the massive Laplacian, and to find local functions in its kernel, which allow to prove a local formula for its inverse.

Note that when the parameter  $k$  is equal to 0, the mass (3) is 0, the elliptic function  $\text{sc}(\theta)$  becomes  $\tan(\theta)$ , and we recover the Laplacian considered in [Ken02]. In this case, the discrete massive exponential function becomes the exponential function introduced in [Mer04] and used in the local formula for the Green function of [Ken02].

**Random rooted spanning forests.** The massive Laplacian operator is naturally related to the statistical mechanics model of *rooted spanning forests*. Indeed, when the graph  $\mathbf{G}$  is finite, by Kirchhoff's matrix-tree theorem, the determinant of  $\Delta^{m(k)}$  is the partition function  $Z_{\text{forest}}^k(\mathbf{G})$ , *i.e.*, the weighted sum of rooted spanning forests of  $\mathbf{G}$ , whose weights depend on the conductances (2) and masses (3). In Section 6, we prove the following results.

- Theorem 34 proves an explicit expression for an infinite volume rooted spanning forest Boltzmann measure of the graph  $\mathbf{G}$ , involving the massive Laplacian matrix and the massive Green function of Theorem 1. The proof follows the approach of [BP93]. This measure inherits the *locality* property of Theorem 1, *i.e.*, the probability that a finite subset of edges/vertices belongs to a rooted spanning forest is unchanged if the graph is modified away from this subset.
- Assume that the infinite isoradial graph  $\mathbf{G}$  is  $\mathbb{Z}^2$ -periodic, and consider the natural exhaustion  $(\mathbf{G}_n = \mathbf{G}/n\mathbb{Z}^2)_{n \geq 1}$  of  $\mathbf{G}$  by toroidal graphs. The *free energy*  $F_{\text{forest}}^k$  of the spanning forest model is minus the exponential growth rate of the partition function  $Z_{\text{forest}}^k(\mathbf{G}_n)$ , as  $n$  tends to infinity. We prove an explicit formula for  $F_{\text{forest}}^k$ , see also Theorem 36. It has the property of

not involving the combinatorics of the graph. Indeed it is a sum over edges of the graph  $G_1$  of quantities only depending on the angle  $\theta_e$  assigned to the edge  $e$  in the isoradial embedding.

**Theorem 2.** *For every  $k \in (0, 1)$ , the free energy  $F_{\text{forest}}^k$  of the rooted spanning forest model on the infinite,  $\mathbb{Z}^2$ -periodic, isoradial graph  $G$ , is equal to:*

$$F_{\text{forest}}^k = |\mathbf{V}_1| \int_0^K 4H'(2\theta) \log \text{sc}(\theta) d\theta + \sum_{e \in E_1} \int_0^{\theta_e} \frac{2H(2\theta) \text{sc}'(\theta)}{\text{sc}(\theta)} d\theta, \quad (5)$$

where  $H$  is the function defined in Equation (9).

- When  $k = 0$ ,  $F_{\text{forest}}^0$  is equal to the normalized determinant of the Laplacian operator of [Ken02]; it is also the free energy of the corresponding spanning tree model. Performing an asymptotic expansion around  $k = 0$  of (5), we prove in Theorem 38 that the rooted spanning forest model has a *second order phase transition at  $k = 0$* . In particular, this gives a proof that the spanning tree model corresponding to the Laplacian considered in [Ken02] is indeed *critical*. Note that the non-analyticity of the free energy at  $k = 0$  does not come from that of the weights or masses. Indeed, the latter are analytic around the origin, see Lemma 7.

- Recall that the infinite volume rooted spanning forest Boltzmann measure inherits the locality property of Theorem 1. From the point of view of statistical mechanics, this specific feature is expected from models defined on isoradial graphs that are *Z-invariant*. Although already present in the work of Kenelly [Ken99] and Onsager [Ons44], the notion of *Z*-invariance has been extensively developed by Baxter, see [Bax78, Bax86] and also [AYP02, PAY06, Ken04]. *Z*-invariance imposes a strong locality constraint on the model: invariance of the partition function under star-triangle moves, see Figure 3 and Section 6.4.1 for definition, or equivalently invariance of the probability measure under these moves. This suggests a locality property of the measure, but it does not provide a way of finding explicit local formulas. Using 3-dimensional consistency of the massive Laplacian operator (Proposition 8), we prove the following, see also Theorem 41.

**Theorem 3.** *For every  $k \in [0, 1)$ , the statistical mechanics model of rooted spanning forests on isoradial graphs, with conductances (2) and masses (3), is *Z*-invariant.*

**The case of periodic isoradial graphs, Harnack curves of genus 1.** Suppose further that the isoradial graph  $G$  is  $\mathbb{Z}^2$ -periodic. The *massive Laplacian characteristic polynomial*, denoted  $P_{\Delta^{m(k)}}(z, w)$ , is the determinant of the matrix  $\Delta^{m(k)}(z, w)$ , which is the matrix of the massive Laplacian  $\Delta^{m(k)}$  restricted to the graph  $G_1$  with extra weights  $z^{\pm 1}, w^{\pm 1}$  along non trivial cycles of the torus. Of particular interest is the zero locus of this polynomial, otherwise known as the *spectral curve of the massive Laplacian*:  $\mathcal{C}^k = \{(z, w) \in \mathbb{C}^2 : P_{\Delta^{m(k)}}(z, w) = 0\}$ . We provide an explicit parametrization of this curve, and combining Proposition 21 and Theorem 25, we prove that this curve has remarkable properties.

**Theorem 4.** *For every  $k \in (0, 1)$ , the spectral curve  $\mathcal{C}^k$  of the massive Laplacian  $\Delta^{m(k)}$  is a Harnack curve of genus 1.*

This is reminiscent of the rational parametrization of critical dimer spectral curves on periodic, bipartite, isoradial graphs of [KO06], corresponding to the genus 0 case. We further prove the following result, see also Theorem 26.

**Theorem 5.** *Every Harnack curve with  $(z, w) \leftrightarrow (z^{-1}, w^{-1})$  symmetry arises as the spectral curve of the characteristic polynomial of the massive Laplacian  $\Delta^{m(k)}$  on some periodic isoradial graph, for some  $k \in (0, 1)$ .*

This can be compared to the fact proved in [KO06] that any genus 0 Harnack curve, whose amoeba contains the origin, is the spectral curve of a critical dimer model on a bipartite isoradial graph.

Since the spectral curve  $\mathcal{C}^k$  has genus 1, the amoeba's complement has a single bounded component. In Proposition 28, we prove that the area of the bounded component grows continuously from 0 to  $\infty$  as  $k$  grows from 0 to 1.

Using the Fourier approach, the massive Green function can be expressed using the characteristic polynomial. This approach also works for other choices of weights, and one cannot see from the formula that the locality property is satisfied. In Section 5.5.1, we relate the Fourier approach and Theorem 1 by proving that our choice of weights allow for an astonishing change of variable. Note that this relation was not understood in the papers [Ken02, BdT11, dT07].

## Outline of the paper.

- **Section 2: Generalities.** Review of main notions underlying the paper: isoradial graphs and elliptic functions.
- **Section 3: Massive Laplacian on isoradial graphs.** Introduction of the one-parameter family of massive Laplacian operators ( $\Delta^{m(k)}$ ), depending on the elliptic modulus  $k \in [0, 1)$ . Proof of 3-dimensional consistency. Definition of the discrete massive exponential function. Proof that it defines a family of massive harmonic functions.
- **Section 4: Massive Green function on isoradial graphs.** Theorem 12 proves the local formula for the massive Green function  $G^{m(k)}$ , and Theorem 14 proves asymptotic exponential decay.
- **Section 5: The case of  $\mathbb{Z}^2$ -periodic isoradial graphs.** Definition of the characteristic polynomial of the massive Laplacian operators, of the Newton polygon of the characteristic polynomial. Proof of confinement results for the Newton polygon. Definition of the spectral curve  $\mathcal{C}^k$  and its amoeba. Explicit parametrization of the spectral curve and proof that it has geometric genus 1. Theorem 25 shows that the spectral curve  $\mathcal{C}^k$  is Harnack and Theorem 26 proves that every genus 1, Harnack curve with  $(z, w) \leftrightarrow (z^{-1}, w^{-1})$  symmetry arises from such a massive Laplacian. Consequences of the Harnack property on the amoeba of the spectral curve. Proof of the growth of the area of the bounded component of the amoeba's complement. Derivation of the local

formula of Theorem 12 from the Fourier approach. Asymptotics of the Green function using the approach of [PW13].

- **Section 6: Random rooted spanning forests on isoradial graphs.** Definition of the statistical mechanics model of rooted spanning forests. Theorem 34 proves an explicit, *local* expression for an infinite volume Boltzmann measure involving the Green function of Theorem 12. Theorem 36 proves an explicit, *local* expression for the free energy of the model, and Theorem 38 shows a second order phase transition at  $k = 0$  in the rooted spanning forest model. At  $k = 0$ , one recovers the Laplacian considered in [Ken02]. We thus provide a proof that the corresponding spanning tree model is critical. Theorem 41 proves that our one-parameter family of massive Laplacian defines a one-parameter family of  $Z$ -invariant spanning forest models.
- **Sections A, B, C and D.** Appendices for elliptic functions, explicit computations of the massive Green function,  $Z$ -invariance, rooted spanning forests and random walks.

*Acknowledgments:* We warmly thank Erwan Brugallé for very helpful discussions on Harnack curves. We acknowledge support from the Agence Nationale de la Recherche (projet MAC2: ANR-10-BLAN-0123) and from the Région Centre-Val de Loire (projet MADACA). We thank the referee for her/his useful comments and suggestions which led us to improve the presentation of this paper. We also thank her/him for the arguments allowing to greatly simplify the proof of Proposition 6 and of Theorem 41.

## 2 Generalities

In this section we review two of the main notions underlying this work: isoradial graphs and elliptic functions.

### 2.1 Isoradial graphs

Isoradial graphs, whose name comes from the paper [Ken02], see also [Duf68, Mer01] are defined as follows. A planar graph  $G = (V, E)$  is *isoradial*, if it can be embedded in the plane in such a way that all internal faces are inscribable in a circle, with all circles having the same radius, and such that all circumcenters are in the interior of the faces, see Figure 1 (top left). From now on, when we speak of an isoradial graph  $G$ , we mean an isoradial graph *together* with an isoradial embedding also denoted by  $G$ . Given an infinite isoradial graph  $G$ , an isoradial embedding of the dual graph  $G^*$  is obtained by taking as dual vertices the circumcenters of the corresponding faces, see Figure 1 (bottom left).

#### 2.1.1 Diamond graph, angles and train-tracks

The *diamond graph*, denoted  $G^\diamond$ , is constructed from an isoradial graph  $G$  and its dual  $G^*$ . Vertices of  $G^\diamond$  are those of  $G$  and those of  $G^*$ . A dual vertex of  $G^*$  is joined to all primal

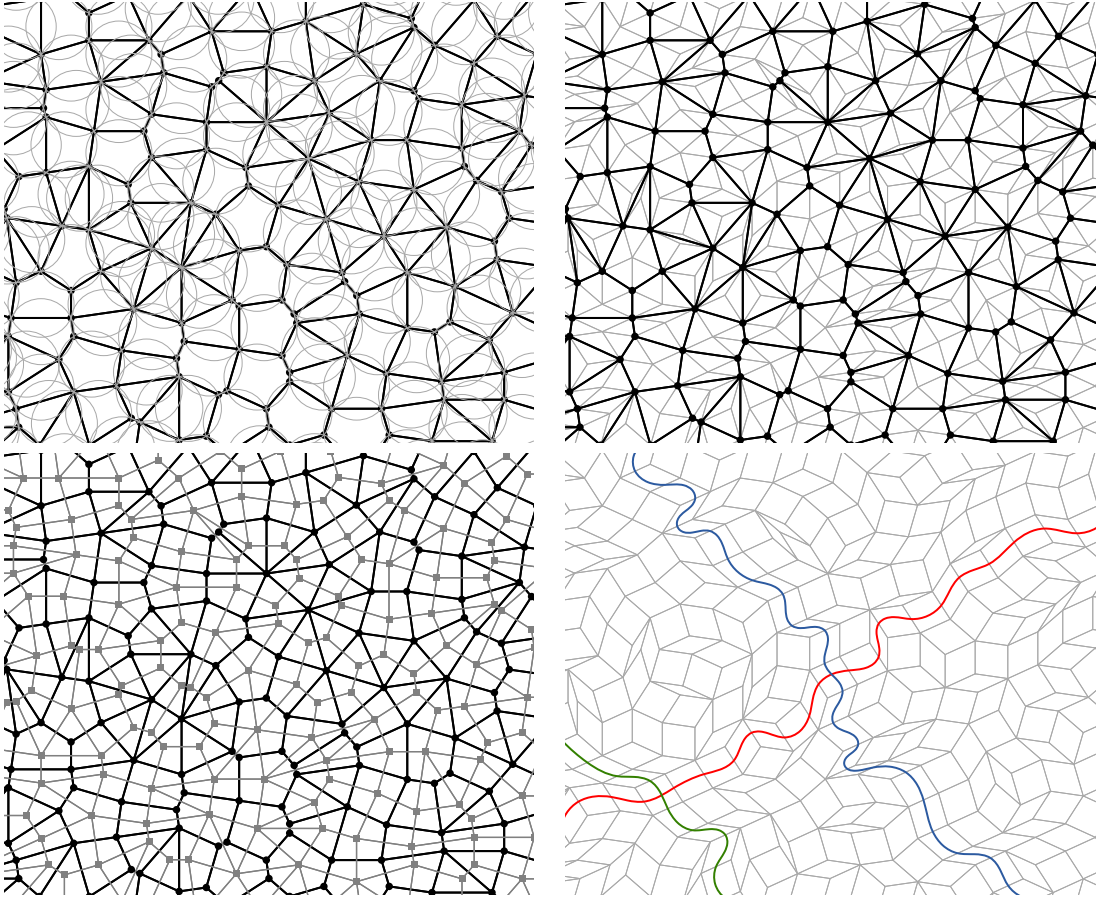

Figure 1: Top left: piece of an infinite isoradial graph  $G$  (in black) with the circumcircles of the faces. Top right: the same piece of infinite graph  $G$  with its diamond graph  $G^\diamond$ . Bottom left: the isoradial graph superimposed with its dual graph, whose vertices are the centers of the circumcircles. Bottom right: the diamond graph with a few train-tracks pictured as paths of the dual graph of  $G^\diamond$ .

vertices on the boundary of the corresponding face, see Figure 1 (top right). Since edges of the diamond graph  $G^\diamond$  are radii of circles, they all have length 1, and can be assigned a direction  $\pm e^{i\bar{\alpha}}$ . Note that faces of  $G^\diamond$  are side-length 1 rhombi.

Using the diamond graph, angles can naturally be assigned to edges of the graph  $G$  as follows. Every edge  $e$  of  $G$  is the diagonal of exactly one rhombus of  $G^\diamond$ , and we let  $\bar{\theta}_e$  be the half-angle at the vertex it has in common with  $e$ , see Figure 2. Note that we have  $\bar{\theta}_e \in (0, \frac{\pi}{2})$ , because circumcircles are assumed to be in the interior of the faces. From now on, we actually ask more and suppose that there exists  $\varepsilon > 0$ , such that  $\bar{\theta}_e \in (\varepsilon, \frac{\pi}{2} - \varepsilon)$ . We also assign two rhombus vectors to the edge  $e$ , denoted  $e^{i\bar{\alpha}_e}$  and  $e^{i\bar{\beta}_e}$ , see Figure 2, and we assume that  $\bar{\alpha}_e, \bar{\beta}_e$

satisfy  $\frac{\bar{\beta}_e - \bar{\alpha}_e}{2} = \bar{\theta}_e$ .

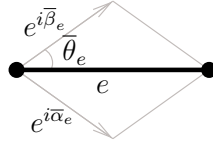

Figure 2: An edge  $e$  of  $G$  is the diagonal of a rhombus of  $G^\diamond$ , defining the angle  $\bar{\theta}_e$  and the rhombus vectors  $e^{i\bar{\alpha}_e}$  and  $e^{i\bar{\beta}_e}$ .

A *train-track* of an infinite isoradial graph  $G$  is a bi-infinite chain of adjacent rhombi of  $G^\diamond$  which does not turn: on entering a face, it exits along the opposite edge [KS05]. As a consequence, each rhombus in a train-track has an edge parallel to a fixed direction  $\pm e^{i\bar{\alpha}}$ , known as the *direction of the train-track*. Train-tracks are also known as *de Bruijn lines* in the field of non-periodic tilings [dB81a, dB81b], or *rapidity lines* in integrable systems [Bax86]; the terminology *line* refers to the representation of train-tracks as paths of the dual graph of  $G^\diamond$ , see Figure 1 (bottom right). In [KS05], they are used to give a necessary and sufficient condition for a planar graph to have an isoradial embedding.

A train-track is said to *separate* two vertices  $x$  and  $y$  of  $G^\diamond$  if every path connecting  $x$  and  $y$  crosses this train-track. A path from  $x$  to  $y$  in  $G^\diamond$  is said to be *minimal* if all its edges cross train-tracks separating  $x$  from  $y$ , and each such train-track is crossed exactly once. An example of minimal path and non-minimal one is given in Figure 7.

### 2.1.2 Isoradial graphs as monotone surfaces of the hypercubic lattice

An isoradial graph  $G$  is said to be *quasicrystalline* if the number  $\ell$  of possible directions  $\pm e^{i\bar{\alpha}}$  assigned to edges of its diamond graph  $G^\diamond$  is finite;  $\ell$  is known as the *dimension* of the isoradial graph. The degree of a vertex of  $G$  is at most  $2\ell$ , and at a vertex of its diamond graph  $G^\diamond$ , there can be edges with direction  $\pm e^{i\bar{\alpha}_1}, \dots, \pm e^{i\bar{\alpha}_\ell}$ . The graph  $G^\diamond$  can then be seen as the projection of a monotone surface in  $\mathbb{Z}^\ell$ , see [Thu90] for  $\ell = 3$ , and also for example [BMS05, BFR08], where the lattice  $\mathbb{Z}^\ell$  is spanned by unit vectors  $e_1, \dots, e_\ell$ , *i.e.*, the image by the linear map  $e_j \mapsto e^{i\bar{\alpha}_j}$ . Rhombic faces of  $G^\diamond$  are images of square 2-faces of  $\mathbb{Z}^\ell$ . Since the surface is monotone, any path on the graph  $G^\diamond$  can be lifted to a nearest-neighbor path in  $\mathbb{Z}^\ell$ .

### 2.1.3 Natural operations on isoradial graphs

**Train-track tilting.** Recall that a direction  $\pm e^{i\bar{\alpha}}$  is assigned to every train-track of  $G$ . If we slightly change the angle  $\bar{\alpha}$ , so that none of the rhombi of the train-track becomes flat during the deformation, we get a new isoradial embedding of the graph  $G$ . The structure of the graph has not changed, however, if quantities are defined through geometric characteristics of the



isoradial embedding (*e.g.*, the angles of the rhombi as is the case in this article), then this operation provides a continuous one-parameter family of transformations for these quantities. This operation is called *train-track tilting*. It is introduced in [Ken02] and used in the proof of Theorem 36 in Section 6.3.

**Star-triangle transformation.** If  $G$  has a *star*, that is a vertex of degree 3, it can be replaced by a *triangle* by removing the vertex and connecting its three neighbors. The graph obtained in this way is still isoradial: its diamond graph is obtained by performing a *cubic flip* in  $G^\diamond$ , see Figure 3. This operation is involutive.

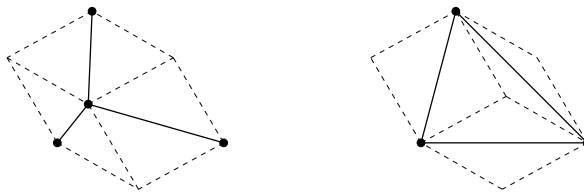

Figure 3: Star-triangle transformation in an isoradial graph  $G$  and underlying cubic-flip in the diamond graph  $G^\diamond$

The star-triangle transformation is locally transitive in the following sense: if  $B$  is a bounded, connected domain obtained as the union of faces of  $G^\diamond$ , then any other tiling of  $B$  with rhombi of the same edge-length can be obtained from the initial one by a sequence of cubic flips [Ken93]. As a consequence, two isoradial graphs coinciding outside of a bounded domain can be transformed into one another by a sequence of star-triangle transformations.

This operations has a natural geometric interpretation from the monotone surface point of view: a cubic flip corresponds to locally deforming the monotone surface so that it uses different 2-faces to go around the same 3-cube of  $\mathbb{Z}^\ell$ .

If  $G$  has no location where such an operation can be performed, it means that there is no triple of train-tracks intersecting eachother. However, if a pair of train-tracks are going to infinity by staying at distance one in  $G^{\diamond*}$ , then we can insert a rhombus “at infinity” to create a location where to perform this transformation.

This operation, connected to the third Reidemeister move in knot theory, plays an important role in integrable systems in two dimensions, and is closely related to the Yang-Baxter equations [PAY06].

## 2.2 Elliptic functions

This article strongly relies on Jacobi elliptic functions, which we now present. Useful formulas are given in Appendix A, our reference is the book of Lawden [Law89] and the one of Abramowitz and Stegun [AS64].

**Elliptic modulus and quarter periods.** Let  $k \in [0, 1]$ , referred to as the *elliptic modulus*, and let  $k' = \sqrt{1 - k^2}$  be the complementary elliptic modulus. The *complete elliptic integral of the first kind*, denoted  $K = K(k)$ , and the *complete elliptic integral of the second kind*, denoted  $E = E(k)$ , are defined by:

$$K = K(k) = \int_0^{\pi/2} \frac{1}{\sqrt{1 - k^2 \sin^2 \tau}} d\tau, \quad E = E(k) = \int_0^{\pi/2} \sqrt{1 - k^2 \sin^2 \tau} d\tau.$$

The complementary integrals are  $K' = K'(k) = K(k')$  and  $E' = E'(k) = E(k')$ . They satisfy Legendre's identity [Law89, 3.8.29]:

$$EK' + E'K - KK' = \frac{\pi}{2}. \quad (6)$$

**Jacobi elliptic functions.** There are twelve Jacobi elliptic functions, each of them corresponds to an arrow drawn from one corner of a rectangle to another, see Figure 4. The corners of the rectangle are labeled, by convention, s, c, d and n. These points respectively correspond to the origin 0,  $K$  on the real axis,  $K + iK'$ , and  $iK'$  on the imaginary axis. The numbers  $K$  and  $iK'$  are called the quarter periods. The twelve Jacobi elliptic functions are then  $\text{pq}(\cdot|k)$ , where each of p and q is a different one of the letters s, c, d, n. The Jacobi elliptic functions are then the unique doubly periodic, meromorphic functions on  $\mathbb{C}$ , satisfying the following properties [AS64, Chapter 16]:

- There is a simple zero at the corner p, and a simple pole at the corner q.
- The step from p to q is equal to half a period of the function  $\text{pq}(\cdot|k)$ . The function  $\text{pq}(\cdot|k)$  is also periodic in the other two directions, with a period such that the distance from p to one of the other corners is a quarter period.
- The coefficient of the leading term in the expansion of  $\text{pq}(u|k)$  in ascending powers of  $u$  about  $u = 0$  is 1. In other words, the leading term is  $u$ ,  $1/u$  or 1, according to whether  $u = 0$  is a zero, a pole or an ordinary point.

For instance, the function  $\text{sc}(\cdot|k)$  (which is the most important Jacobi elliptic function here) has a simple zero at 0 (with residue 1), a simple pole at  $K$ , and is doubly periodic with periods  $2K$  and  $4iK'$ .

Jacobi functions  $\text{pq}(\cdot|k)$  also satisfy anti-periodicity relations: if  $2L \in \{2K, 2iK', 2K + 2iK'\}$  is not a period, then  $\text{pq}(\cdot + 2L|k) = -\text{pq}(\cdot|k)$ , see [AS64, 16.2 and 16.8].

**Degenerate elliptic functions.** Elliptic functions contain as limiting cases trigonometric functions ( $k = 0$ ) and hyperbolic functions ( $k = 1$ ). For instance,  $\text{sc}$  degenerates for  $k = 0$  into  $\tan$  and for  $k = 1$  into  $\sinh$ ;  $\text{dn}$  degenerates for  $k = 0$  to 1, see [AS64, 16.6]. Note that one of the periods goes to infinity: for  $k = 0$  we have  $K = \pi/2$  and  $K' = \infty$ , while for  $k = 1$ ,  $K = \infty$  and  $K' = \pi/2$ ; explaining why the limit functions are periodic in one direction only. From now on, we suppose that the elliptic modulus  $k$  is in  $[0, 1)$ .

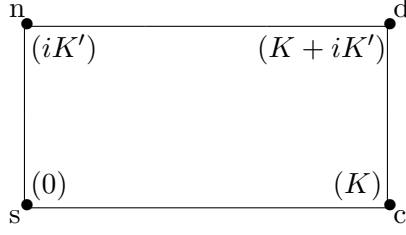

Figure 4: The rectangle  $[0, K] + [0, iK']$  and the four corners labeled s, c, d, n.

**Integrals of squared Jacobi elliptic functions.** Following [AS64, 16.25.1], we introduce

$$\forall u \in \mathbb{C}, \quad \text{Dc}(u|k) = \int_0^u \text{dc}^2(v|k) \, dv. \quad (7)$$

Since  $\text{dc}^2(\cdot|k)$  has no residue at its poles, the function  $\text{Dc}(\cdot|k)$  is meromorphic on  $\mathbb{C}$ . It is related to Jacobi epsilon function [AS64, 16.26.7].

The definition of the massive Laplacian of Section 3 involves the function  $A(\cdot|k)$ , defined as

$$\forall u \in \mathbb{C}, \quad A(u|k) = \frac{1}{k'} \left( \text{Dc}(u|k) + \frac{E - K}{K} u \right). \quad (8)$$

The function  $A(\cdot|k)$  is periodic in the direction  $2K$  and quasi-periodic in  $2iK'$ , see (62) and (63).

The explicit expression of the Green function of Theorem 12 involves the function  $H(\cdot|k)$ , defined from the function  $A(\cdot|k)$  by

$$\forall u \in \mathbb{C}, \quad H(u|k) = \frac{-ik'K'}{\pi} A\left(\frac{iu}{2} \middle| k'\right). \quad (9)$$

Properties and identities satisfied by the functions  $A(\cdot|k)$  and  $H(\cdot|k)$  are stated in Lemmas 44 and 45 of Appendix A.2.

**One-parameter family of angles.** Finally, we define a one-parameter family of angles, depending on the elliptic modulus. For every  $k \in [0, 1)$  and every edge  $e$  of  $\mathbf{G}$ ,

$$\theta_e = \bar{\theta}_e \frac{2K}{\pi} \in (0, K), \quad \alpha_e = \bar{\alpha}_e \frac{2K}{\pi}, \quad \beta_e = \bar{\beta}_e \frac{2K}{\pi}.$$

Since the elliptic modulus is fixed, the dependence in  $k$  is not made explicit in the notation  $\theta_e, \alpha_e, \beta_e$ .

### 3 Massive Laplacian on isoradial graphs

In Section 3.1, we introduce a one-parameter family  $(\Delta^{m(k)})_{k \in [0,1]}$  of massive Laplacian operators defined on an infinite isoradial graph  $\mathbf{G}$ , involving elliptic functions. We prove that the mass is non-negative and that the conductances and mass are analytic at  $k = 0$ . Then, in Section 3.2, we show that the equation  $\Delta^{m(k)} f = 0$  satisfies *3-dimensional consistency*. Finally, in Section 3.3, we introduce the *discrete  $k$ -massive exponential function*, which induces a family of massive harmonic functions. The latter play a key role in the explicit formula for the massive Green function.

In the whole of this section, we let  $\mathbf{G}$  be an infinite isoradial graph, and we fix an elliptic modulus  $k \in [0, 1)$ . Let us introduce some notation for edges and angles around a vertex  $x$  of  $\mathbf{G}$  of degree  $n$ : denote by  $e_1 = xx_1, \dots, e_n = xx_n$  edges incident to  $x$ ; for every edge  $e_j$ , denote by  $\bar{\theta}_j$  its rhombus half-angle and by  $e^{i\bar{\alpha}_j}, e^{i\bar{\alpha}_j+1}$  its two rhombus vectors, see Figure 5.

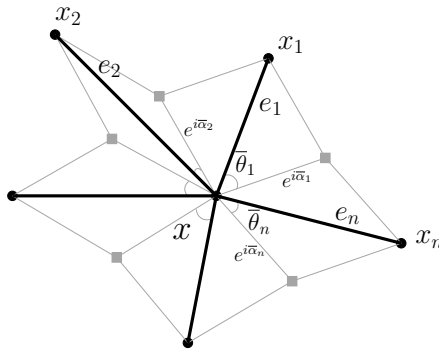

Figure 5: Notation for edges and angles around a vertex  $x$  of  $\mathbf{G}$  of degree  $n$ .

#### 3.1 Definitions

**Definition 3.1.** Suppose that edges of the graph  $\mathbf{G}$  are assigned positive *conductances*  $(\rho(e))_{e \in \mathbf{E}}$  and that vertices are assigned (squared) *masses*  $(m^2(x))_{x \in \mathbf{V}}$ . Then, the *massive Laplacian operator*  $\Delta^m : \mathbb{C}^{\mathbf{V}} \rightarrow \mathbb{C}^{\mathbf{V}}$  is defined by:

$$\begin{aligned} (\Delta^m f)(x) &= \sum_{y \sim x} \rho(xy)[f(x) - f(y)] + m^2(x)f(x), \\ &= d(x)f(x) - \sum_{y \sim x} \rho(xy)f(y), \end{aligned} \tag{10}$$

where  $d(x) = m^2(x) + \sum_{y \sim x} \rho(xy)$ . The massive Laplacian operator is represented by an infinite matrix, also denoted  $\Delta^m$ , whose rows and columns are indexed by vertices of  $\mathbf{G}$ , and

whose coefficients are given by:

$$\forall x, y \in \mathbf{V}, \quad \Delta^m(x, y) = \begin{cases} -\rho(xy) & \text{if } y \sim x, \\ d(x) & \text{if } y = x, \\ 0 & \text{otherwise.} \end{cases}$$

A function  $f$  in  $\mathbb{C}^{\mathbf{V}}$  is *massive harmonic* on  $\mathbf{G}$  if  $\Delta^m f = 0$ .

We now introduce a one-parameter family of conductances and masses, indexed by the elliptic modulus  $k \in [0, 1)$ .

**Definition 3.2.** To every edge  $e$  of  $\mathbf{G}$ , assign the *conductance*  $\rho(e) = \rho(\theta_e|k)$ , defined by:

$$\rho(\theta_e|k) = \text{sc}(\theta_e|k). \quad (11)$$

To every vertex  $x$  of degree  $n$  of  $\mathbf{G}$ , assign the *mass*  $m^2(x) = m^2(x|k)$ , defined by:

$$m^2(x|k) = \sum_{j=1}^n [A(\theta_j|k) - \rho(\theta_j|k)] \Leftrightarrow d(x|k) = \sum_{j=1}^n A(\theta_j|k), \quad (12)$$

where  $d(x|k)$  is the *diagonal term* at the vertex  $x$ , and  $A(\cdot|k)$  is given by Equation (8).

The main object studied in this paper is the corresponding *k-massive Laplacian operator* denoted by  $\Delta^{m(k)}$ , defined by:

$$(\Delta^{m(k)} f)(x) = \sum_{j=1}^n [A(\theta_j|k)f(x) - \text{sc}(\theta_j|k)f(x_j)]. \quad (13)$$

**Notation.** From now on, to simplify notation, we only keep the dependence in  $k$  in statements and omit it in proofs, writing  $\Delta^m$ ,  $\rho(\theta_e) = \text{sc}(\theta_e)$ ,  $m^2(x)$ ,  $d(x) = \sum_{j=1}^n A(\theta_j)$ .

From Definition 3.2, it is not clear that the mass is non-negative and that the conductance and mass are analytic at  $k = 0$ . This is proved in the next two results.

**Proposition 6.** *For every  $k \in [0, 1)$  and every vertex  $x$  of  $\mathbf{G}$ ,  $m^2(x|k) \geq 0$ ; it is equal to 0 if and only if  $k = 0$ .*

*Proof.* Returning to the definition of  $m^2(x)$ , see (12), it suffices to show that each term  $A(\theta_j) - \text{sc}(\theta_j)$  is positive when  $k > 0$  and equal to 0 when  $k = 0$ , for  $\theta_j \in (0, K)$ . Consider the function  $f(u) := A(u) - \text{sc}(u)$  on  $[0, K]$ . Then  $f(0) = 0$  by definition (8). To prove that  $f(K) = 0$ , we observe that as  $u \rightarrow 0$ , using (51) and (60),

$$f(K - u) = A(K - u) - \text{sc}(K - u) = -A(u) + \frac{\text{dc}(u) - \text{cn}(u)}{k' \text{sn}(u)} = O(u) + \frac{O(u^2)}{u + O(u^3)} \rightarrow 0.$$

Moreover, using formulas (57) and (64), we have

$$\frac{d^2 f(u)}{du^2} = \frac{d}{du} \left( \frac{dc^2(u)}{k'} - \frac{K-E}{k'K} - dc(u) nc(u) \right) = -\frac{sn(u)}{cn^3(u)} (k' - dn(u))^2.$$

When  $k > 0$ , the second derivative of  $f$  is negative on  $(0, K)$  implying that  $f$  is strictly concave on  $(0, K)$  and thus positive. When  $k = 0$ , the first derivative of  $f$  is identically 0 so that  $f$  is constant and equal to 0.  $\square$

**Lemma 7.** *For every edge  $e$  and every vertex  $x$  of  $\mathbf{G}$ , the conductance  $\rho(\theta_e|k)$  and the mass  $m^2(x|k)$  are analytic at  $k = 0$ .*

*Proof.* We use the expansion [AS64, 16.23.9] of  $sc$  in terms of the nome  $q = \exp(-\pi K'/K)$ :

$$\rho(\theta_e|k) = sc(\bar{\theta}_e \frac{2K(k)}{\pi} |k) = \frac{\pi}{2k'K(k)} \tan(\bar{\theta}_e) + \frac{2\pi}{k'K(k)} \sum_{n=1}^{\infty} (-1)^n \frac{q^{2n}}{1+q^{2n}} \sin(2n\bar{\theta}_e).$$

Since  $1/k'$ ,  $K$  and  $q$  are analytic at 0 [AS64, 17.3.11 and 17.3.21] for  $K$  and  $q$ , respectively we obtain the analyticity of the conductances.

The addition formula (61) for  $A$  reduces the analyticity of the masses to those of the conductances, thereby concluding the proof.  $\square$

**Example:**  $\mathbf{G} = \mathbb{Z}^2$ . For every edge  $e$ , we have  $\bar{\theta}_e = \frac{\pi}{4}$ , i.e.,  $\theta_e = \frac{K}{2}$ , implying by [Law89, 2.4.10] that  $\rho(e) = sc(\frac{K}{2}) = \frac{1}{\sqrt{k'}}$ . Moreover, using (12) we have, for every vertex  $x$ ,

$$m^2(x) = 4 \left( A\left(\frac{K}{2}\right) - sc\left(\frac{K}{2}\right) \right) = 2 \left( 1 - \frac{1}{\sqrt{k'}} \right)^2,$$

where to derive  $A(\frac{K}{2})$  we have used (60) with  $u = \frac{K}{2}$  and again [Law89, 2.4.10].

In particular, the analyticity of the conductances and masses around  $k = 0$  ( $k' = 1$ ) proved in Lemma 7 is straightforward in this case.

## 3.2 Massive harmonic functions and the star-triangle transformation

Proposition 8 below proves that the equation  $\Delta^{m(k)} f = 0$  satisfies *3-dimensional consistency* [BS08], meaning that massive harmonic functions are compatible under star-triangle transformations of the underlying graph defined in Section 2.1.3.

Let us denote by  $\mathbf{G}_{\mathbf{Y}}$  a finite or infinite isoradial graph containing a star, and by  $\mathbf{G}_{\Delta}$  the isoradial graph obtained from  $\mathbf{G}_{\mathbf{Y}}$  by performing a star-triangle transformation. The vertex set of  $\mathbf{G}_{\mathbf{Y}}$  is the vertex set of  $\mathbf{G}_{\Delta}$  plus  $x_0$ , see Figure 6.

**Proposition 8.**  $\bullet$  *Let  $f$  be a function on  $\mathbf{G}_{\mathbf{Y}}$ . If  $f$  is massive harmonic at  $x_0$ , then for all vertices  $x$  of  $\mathbf{G}_{\Delta}$ ,  $(\Delta_{\mathbf{G}_{\mathbf{Y}}}^{m(k)} f)(x) = (\Delta_{\mathbf{G}_{\Delta}}^{m(k)} f)(x)$ .*

- Conversely, let  $f$  be a function on  $G_\Delta$ . Then there is a unique way of extending it to the vertex  $x_0$  in such a way that  $f$  is massive harmonic at  $x_0$  and  $(\Delta_{G_Y}^{m(k)} f)(x) = (\Delta_{G_\Delta}^{m(k)} f)(x)$  for all vertices  $x$  of  $G_\Delta$ .

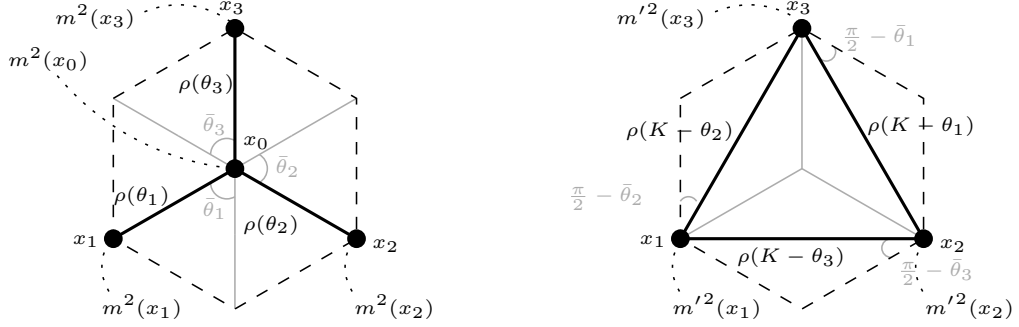

Figure 6: *Star-triangle transformation* and notation. If an isoradial graph  $G_Y$  has a *star* (left), *i.e.*, a vertex  $x_0$  of degree 3, it can be transformed into a new isoradial graph  $G_\Delta$  having a *triangle* (right) connecting the three neighbors  $x_1, x_2, x_3$  of  $x_0$ , by performing a cubic-flip on the underlying diamond graph  $G^\diamond$ , and vice-versa.

*Proof.* Refer to Figure 6 for notation of vertices and weights of the star/triangle. Consider a function  $f$  on  $G_Y$ , and also denote by  $f$  its restriction to  $G_\Delta$ . Every vertex  $x$  which is not one of  $x_1, x_2, x_3, x_0$  has the same neighbors in  $G_Y$  and  $G_\Delta$ , so that:

$$(\Delta_{G_Y}^m f)(x) = (\Delta_{G_\Delta}^m f)(x).$$

Therefore, we only need to consider what happens at vertices  $x_1, x_2, x_3, x_0$ . Suppose that we have proved the following:

$$\forall i \in \{1, 2, 3\}, \quad \rho(\theta_j)\rho(\theta_k)(\Delta_{G_\Delta}^m f - \Delta_{G_Y}^m f)(x_i) = \Delta_{G_Y}^m f(x_0), \quad (14)$$

where  $\{i, j, k\} = \{1, 2, 3\}$ . Then, the first part of Proposition 8 immediately follows.

For the second part, consider a function  $f$  on  $G_\Delta$ . Asking that its extension to  $G_Y$  is massive harmonic at  $x_0$  requires that

$$\Delta_{G_Y}^m f(x_0) = [m^2(x_0) + \sum_{\ell=1}^3 \rho(\theta_\ell)]f(x_0) - \sum_{\ell=1}^3 \rho(\theta_\ell)f(x_\ell) = 0,$$

which determines the value of  $f$  at  $x_0$ . But then, by Equation (14), the Laplacian on  $G_Y$  of  $f$  coincides with the one of  $f$  on  $G_\Delta$  at the vertices  $x_1, x_2, x_3$ , which concludes the proof of the second part.

We are thus left with proving Equation (14). Fix  $i \in \{1, 2, 3\}$ , and let  $\mathcal{O}_i$  be the contribution to the massive Laplacian evaluated at  $x_i$ , coming from vertices outside of the triangle/star. It is common to both graphs, and returning to Expression (10), we have

$$\begin{aligned}(\Delta_{\mathbb{G}_\Upsilon}^m f)(x_i) &= [m^2(x_i) + \rho(\theta_i)]f(x_i) - \rho(\theta_i)f(x_0) + \mathcal{O}_i, \\(\Delta_{\mathbb{G}_\Delta}^m f)(x_i) &= [m'^2(x_i) + \sum_{\ell \neq i} \rho(K - \theta_\ell)]f(x_i) - \rho(K - \theta_j)f(x_k) - \rho(K - \theta_k)f(x_j) + \mathcal{O}_i.\end{aligned}$$

Using Equation (72) of Appendix A,

$$m'^2(x_i) - m^2(x_i) = \rho(\theta_i) - \sum_{\ell \neq i} \rho(K - \theta_\ell) - k' \rho(K - \theta_j) \rho(K - \theta_k) \rho(\theta_i),$$

and taking the difference yields that  $(\Delta_{\mathbb{G}_\Delta}^m f)(x_i) - \Delta_{\mathbb{G}_\Upsilon}^m f$  is equal to

$$-\rho(K - \theta_j)f(x_k) - \rho(K - \theta_k)f(x_j) - k' \rho(K - \theta_j) \rho(K - \theta_k) \rho(\theta_i) f(x_i) + \rho(\theta_i) f(x_0).$$

Multiplying this equation by  $k' \rho(\theta_j) \rho(\theta_k)$ , using the fact that  $k' \rho(K - \theta_\ell) \rho(\theta_\ell) = 1$  (see Identity (51)), and  $k' \prod_{\ell=1}^3 \rho(\theta_\ell) = m^2(x_0) + \sum_{\ell=1}^3 \rho(\theta_\ell)$  (see Equation (71)), we conclude:

$$k' \rho(\theta_j) \rho(\theta_k) (\Delta_{\mathbb{G}_\Delta}^m f - \Delta_{\mathbb{G}_\Upsilon}^m f)(x_i) = [m^2(x_0) + \sum_{\ell=1}^3 \rho(\theta_\ell)] f(x_0) - \sum_{\ell=1}^3 \rho(\theta_\ell) f(x_\ell) = (\Delta_{\mathbb{G}_\Upsilon} f)(x_0). \quad \square$$

When extending  $f$  from  $\mathbb{G}_\Delta$  to  $\mathbb{G}_\Upsilon$ , we have four equations which could individually determine the value of  $f(x_0)$ : the massive harmonicity condition at  $x_0$ , and the three equations from (14). The remarkable fact, proved in Proposition 8, is that all these conditions give the same result; this is also known as *3-dimensional consistency* of the equation  $\Delta^{m(k)} f = 0$ , because of the geometric interpretation of the star-triangle transformation on quasicrystalline isoradial graphs seen as monotone surfaces in  $\mathbb{Z}^\ell$  [BS08]. This condition is then sufficient to ensure  $\ell$ -dimensional consistency, in the following sense: let  $(\mathbb{G}_n)_n$  be a sequence of isoradial graphs where two successive graphs differ by a star-triangle transformation, representing a discrete sequence of monotone surfaces in  $\mathbb{Z}^\ell$ . Then, by Proposition 8, from a massive harmonic function  $f_0$  on  $\mathbb{G}_0$  one can construct, in a consistent way, a harmonic function  $f_n$  on  $\mathbb{G}_n$ , for every  $n$ . In particular, if the sequence  $(\mathbb{G}_n)_n$  spans the whole  $\ell$ -dimensional lattice  $\mathbb{Z}^\ell$  (namely, for every vertex of  $\mathbb{Z}^\ell$ , there exists an  $n$  such that this vertex is in the monotone surface  $\mathbb{G}_n$ ), then a massive harmonic function on  $\mathbb{G}_0$  can uniquely be extended to  $\mathbb{Z}^\ell$ , and its restriction to any monotone surface, viewed as an isoradial graph, is again massive harmonic.

This property is in the spirit of integrable equations on quad-graphs discussed in [ABS03, BS08]. Our massive Laplacian satisfies a so-called *three-leg equation*, using the terminology of [ABS03], as shown in the forthcoming Equation (17), but it does not fit in their classification of *three-leg integrable equations*, because it does not satisfy their symmetry requirement and does not allow to define values on  $\mathbb{G}^*$ .



### 3.3 The discrete $k$ -massive exponential function

In this section we introduce the *discrete  $k$ -massive exponential function*. In Proposition 11, we prove that it defines a family of massive harmonic functions. This is one of the key facts needed to prove the local formula for the massive Green function of Theorem 12.

#### 3.3.1 Definition

**Definition 3.3.** The *discrete  $k$ -massive exponential function* or simply *massive exponential function*, denoted  $\mathbf{e}_{(\cdot, \cdot)}(\cdot|k)$ , is a function from  $\mathbb{V}^\diamond \times \mathbb{V}^\diamond \times \mathbb{C}$  to  $\mathbb{C}$ . Consider a pair of vertices  $x, y$  of  $\mathbb{G}^\diamond$ , and an edge-path  $x = x_1, \dots, x_n = y$  of the diamond-graph  $\mathbb{G}^\diamond$  from  $x$  to  $y$ ; let  $e^{i\bar{\alpha}_j}$  be the vector corresponding to the edge  $x_j x_{j+1}$ , see Figure 7. Then  $\mathbf{e}_{(x,y)}(\cdot|k)$  is defined inductively along the edges of the path as follows. For every  $u \in \mathbb{C}$ ,

$$\mathbf{e}_{(x_j, x_{j+1})}(u|k) = i\sqrt{k'} \operatorname{sc}(u_{\alpha_j}|k), \quad \mathbf{e}_{(x,y)}(u|k) = \prod_{j=1}^{n-1} \mathbf{e}_{(x_j, x_{j+1})}(u|k), \quad (15)$$

where  $u_\alpha = \frac{u-\alpha}{2}$ , and recall that  $\alpha_j = \bar{\alpha}_j \frac{2K}{\pi}$ .

Note that when  $k = 0$ , one recovers the discrete exponential function of [Mer04], see also [Ken02] after the change of variable  $z = e^{iu}$ .

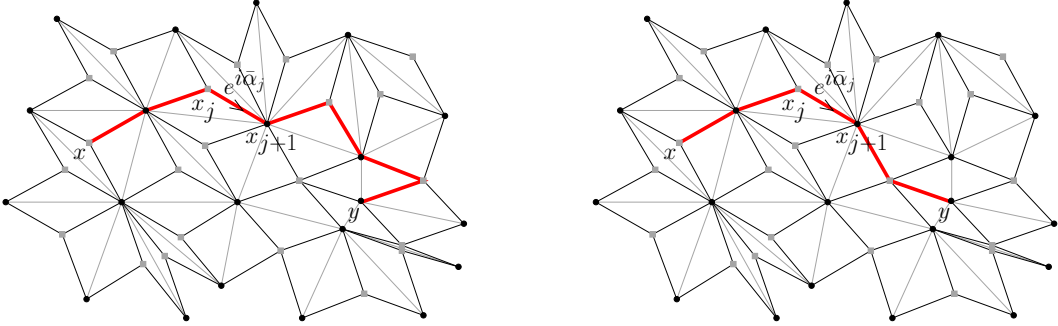

Figure 7: Examples of paths of  $\mathbb{G}^\diamond$  from  $x$  to  $y$  used to compute the discrete massive exponential function  $\mathbf{e}_{(x,y)}(\cdot|k)$ . The path on the right is minimal, whereas the one on the left is not.

**Lemma 9.** *The discrete  $k$ -massive exponential function is well defined, that is, for every pair of vertices  $x, y$  of  $\mathbb{G}^\diamond$ , and for every  $u \in \mathbb{C}$ ,  $\mathbf{e}_{(x,y)}(u|k)$  is independent of the choice of edge-path from  $x$  to  $y$ .*

*Proof.* If  $(x, y)$  is an edge of  $\mathbb{G}^\diamond$  corresponding to a vector  $e^{i\bar{\alpha}}$ , then the edge  $(y, x)$  corresponds to the vector  $e^{i\bar{\alpha}+\pi} = e^{i\bar{\alpha}+2K}$ . Observing that  $u_{\alpha+2K} = u_\alpha - K$ , we deduce by (51):

$$\mathbf{e}_{(y,x)}(u|k) = i\sqrt{k'} \operatorname{sc}(u_{\alpha+2K}|k) = i\sqrt{k'} \times \frac{-1}{k' \operatorname{sc}(u_\alpha|k)} = \mathbf{e}_{(x,y)}(u|k)^{-1}.$$

This implies that the product of the local factors around any rhombus is equal to 1. Indeed, the contribution of a side of the rhombus comes with its inverse, which is the contribution of the opposite side. Therefore, the product of every closed path in  $\mathbf{G}^\diamond$  is equal to 1.  $\square$

*Remark 10.* A consequence of Definition 3.3 and Lemma 9 is that the zeros (resp. poles) of  $\mathbf{e}_{(x,y)}(\cdot|k)$  are encoded by the steps of a minimal path from  $x$  to  $y$ . Specifically, if the steps of a minimal path from  $x$  to  $y$  are  $\{e^{i\bar{\alpha}_\ell}\}_\ell$ , then the zeros (resp. poles) are  $\{\alpha_\ell\}_\ell$  and  $\{\alpha_\ell + 4iK'\}_\ell$  (resp.  $\{\alpha_\ell + 2K\}_\ell$  and  $\{\alpha_\ell + 2K + 4iK'\}_\ell$ ).

The construction of a discrete massive harmonic function from a starting point, by successive multiplication by local factors along any path is called a *discrete zero curvature representation* of the solutions of the equation  $\Delta^{m(k)}f = 0$ , see [BS08, Chapter 6] for analogous constructions. This property, together with 3-dimensional consistency proved in Proposition 8, means that the massive Laplacian  $\Delta^{m(k)}$  is *discrete integrable*.

### 3.3.2 Restriction of the domain of definition

Recall from Section 2.2 that the elliptic function  $\text{sc}(\cdot|k)$  is doubly-periodic with period  $2K$  and  $4iK'$ . Therefore the parameter  $u$  of the massive exponential function  $\mathbf{e}_{(x,y)}(u|k)$  defined in (15) can be seen as living on the torus  $\mathbb{C}/(4K\mathbb{Z} + 8iK'\mathbb{Z})$ . However, on this torus, the function  $u \mapsto \text{sc}(u_\alpha|k)$  satisfies  $\text{sc}((u + 4iK')_\alpha|k) = \text{sc}(u_\alpha + 2iK'|k) = -\text{sc}(u_\alpha|k)$ .

If both vertices  $x$  and  $y$  belong to  $\mathbf{G}$ , the number of  $\text{sc}$  factors in the definition of  $\mathbf{e}_{(x,y)}(u|k)$  is even, implying that  $\mathbf{e}_{(x,y)}(\cdot|k)$  is an elliptic function with period  $4K$  and  $4iK'$ . In the following, when working with the massive exponential function restricted to pairs of vertices of  $\mathbf{G}$ , we suppose that the parameter  $u$  belongs to the torus  $\mathbb{T}(k) := \mathbb{C}/(4K\mathbb{Z} + 4iK'\mathbb{Z})$ .

### 3.3.3 Massive exponential functions are massive harmonic functions

The next proposition proves the key property of the discrete massive exponential function, *i.e.*, that it defines a family of massive harmonic functions.

**Proposition 11.** *For every  $u \in \mathbb{T}(k)$ , the massive exponential function  $\mathbf{e}_{(x,y)}(u|k)$  is massive harmonic on  $\mathbf{G}$  in each variable  $x$  and  $y$ . Namely,*

$$\forall x \in \mathbf{V}, \quad \Delta^{m(k)} \mathbf{e}_{(\cdot,x)}(u|k) = \Delta^{m(k)} \mathbf{e}_{(x,\cdot)}(u|k) = 0.$$

*Proof.* Let  $y$  be a vertex of  $\mathbf{G}$ . Since  $\Delta^m$  is symmetric and  $\mathbf{e}_{(x,y)}(u + 2K) = \mathbf{e}_{(y,x)}(u)$ , it is enough to prove that for every vertex  $x$  of  $\mathbf{G}$ ,  $(\Delta^m \mathbf{e}_{(\cdot,y)}(u))(x) = 0$ . Suppose that  $x$  has degree  $n$  and denote by  $x_1, \dots, x_n$  the vertices incident to  $x$ , by  $e_1, \dots, e_n$  and  $\theta_1, \dots, \theta_n$ , the corresponding edges and rhombus angles, see Figure 5. By definition of the massive exponential function, we have  $\mathbf{e}_{(x_j,y)}(u) = \mathbf{e}_{(x_j,x)}(u) \mathbf{e}_{(x,y)}(u)$ . As a consequence, using (13),

$$(\Delta^m \mathbf{e}_{(\cdot,y)}(u))(x) = \left( \sum_{j=1}^n [A(\theta_j) - \text{sc}(\theta_j) \mathbf{e}_{(x_j,x)}(u)] \right) \mathbf{e}_{(x,y)}(u).$$

It thus suffices to prove that the prefactor

$$\sum_{j=1}^n [A(\theta_j) - \text{sc}(\theta_j) \mathbf{e}_{(x_j, x)}(u)] = 0. \quad (16)$$

Replacing the exponential function by its definition, and referring to Figure 5 for the notation of the rhombus vectors, we have for every  $j$

$$\begin{aligned} A(\theta_j) - \text{sc}(\theta_j) \mathbf{e}_{(x_j, x)}(u) &= A\left(\frac{\alpha_{j+1} - \alpha_j}{2}\right) + k' \text{sc}(\theta_j) \text{sc}(u_{\alpha_j + 2K}) \text{sc}(u_{\alpha_{j+1} + 2K}) \\ &= A(u_{\alpha_j + 2K}) - A(u_{\alpha_{j+1} + 2K}), \text{ by (61) of Lemma 44.} \end{aligned} \quad (17)$$

By Section 2.1.1, the angles  $\alpha_j, \alpha_{j+1}$  are such that  $\frac{\alpha_{j+1} - \alpha_j}{2} = \theta_j$ . This implies that

$$(\alpha_{n+1} + 2K) - (\alpha_1 + 2K) = \sum_{j=1}^n \alpha_{j+1} - \alpha_j = 2 \sum_{j=1}^n \theta_j = 4K.$$

We thus have,  $u_{\alpha_1 + 2K} = u_{\alpha_{n+1} + 2K} + 2K$ . Summing over  $j$  we obtain:

$$\begin{aligned} \sum_{j=1}^n [A(\theta_j) - \text{sc}(\theta_j) \mathbf{e}_{(x_j, x)}(u)] &= \sum_{j=1}^n [A(u_{\alpha_j + 2K}) - A(u_{\alpha_{j+1} + 2K})] \\ &= A(u_{\alpha_{n+1} + 2K} + 2K) - A(u_{\alpha_{n+1} + 2K}) = 0, \end{aligned}$$

where in the last equality we have used Equation (62) of Lemma 44 in Appendix A.2.  $\square$

## 4 Massive Green function on isoradial graphs

In the whole of this section, we let  $\mathbf{G}$  be an infinite isoradial graph, and fix an elliptic modulus  $k \in (0, 1)$ . We consider the inverse  $G^{m(k)}$  of the massive Laplacian operator  $\Delta^{m(k)}$ , that is the *massive Green function*, whose definition we recall in Section 4.1. In Theorem 12 of Section 4.2, we prove an *explicit local formula* for the massive Green function. Then, in Theorem 14 of Section 4.3, using a saddle-point analysis, we prove explicit asymptotic exponential decay of the Green function.

### 4.1 Definition

The space of functions on  $\mathbf{V}$  with finite support is endowed with a natural scalar product:  $\langle f, g \rangle = \sum_{x \in \mathbf{V}} \overline{f(x)} g(x)$ , which can be completed into the Hilbert space  $L^2(\mathbf{V})$ .

The operator  $(\Delta^{m(k)})$ , defines a symmetric bilinear form on  $L^2(\mathbf{V})$ , called the *energy form* or *Dirichlet form*  $\mathcal{E}(\cdot, \cdot | k)$ :

$$\mathcal{E}(f, g | k) = \frac{1}{2} \langle f, (\Delta^{m(k)})g \rangle = \frac{1}{2} \sum_{x \in \mathbf{V}} m^2(x | k) \overline{f(x)} g(x) + \sum_{y \sim x} \rho(\theta_{xy} | k) \overline{(f(x) - f(y))} (g(x) - g(y)).$$

Note that the condition imposed on rhombus half-angles, namely that they are in  $(\varepsilon, \frac{\pi}{2} - \varepsilon)$  for some  $\varepsilon > 0$ , implies that the degree of vertices is uniformly bounded, and that conductances  $(\rho(\theta_e))$  are uniformly bounded away from 0 and infinity. Moreover, since  $k > 0$ , masses  $(m^2(x))$  are also uniformly bounded. Therefore, there exist two constants  $c, C > 0$  such that for all  $f \in L^2(\mathbf{V})$ ,

$$c\langle f, f \rangle \leq \langle f, (\Delta^{m(k)})f \rangle \leq C\langle f, f \rangle.$$

As a consequence, the inverse of  $\Delta^{m(k)}$ , called the *massive Green function* and denoted by  $G^{m(k)}$ , is well defined, and can be expressed from the semigroup  $(e^{-t\Delta^{m(k)}})_{t \geq 0}$  as:

$$G^{m(k)} = \int_0^\infty e^{-t\Delta^{m(k)}} dt.$$

For every  $f \in L^2(\mathbf{V})$ ,  $G^{m(k)}f \in L^2(\mathbf{V})$ , and  $G^{m(k)}$  is uniquely characterized by the fact that for any functions  $f, g$  in  $L^2(\mathbf{V})$ ,  $\mathcal{E}(G^{m(k)}f, g|k) = \langle f, g \rangle$ .

Like the massive Laplacian, the massive Green function can be seen as an infinite symmetric matrix with rows and columns indexed by vertices of  $\mathbf{G}$  as follows:

$$\forall x, y \in \mathbf{V}, \quad G^{m(k)}(x, y) = (G^{m(k)}\delta_y)(x).$$

Note that for any vertex  $y$  of  $\mathbf{G}$ ,  $x \mapsto G^{m(k)}(x, y)$  belongs to  $L^2(\mathbf{V})$ . In particular,

$$\lim_{x \rightarrow \infty} G^{m(k)}(x, y) = 0.$$

## 4.2 Local formula for the massive Green function

Theorem 12 proves an explicit formula for the massive Green function  $G^{m(k)}$ . Notable features of this theorem are explained in the introduction and briefly recalled in Remark 13.

**Theorem 12.** *Let  $\mathbf{G}$  be an infinite isoradial graph. Then, for every pair of vertices  $x, y$  of  $\mathbf{G}$ , the massive Green function  $G^{m(k)}(x, y)$  has the following explicit expression:*

$$G^{m(k)}(x, y) = \frac{k'}{4i\pi} \int_{\mathcal{C}_{x,y}} \mathbf{e}_{(x,y)}(u|k) du, \quad (18)$$

where the contour of integration  $\mathcal{C}_{x,y}$  is the vertical closed path  $\varphi_{x,y} + [0, 4iK'(k)]$  on  $\mathbb{T}(k)$ , winding once vertically and directed upwards, and  $\bar{\varphi}_{x,y} = \frac{\pi}{2K} \varphi_{x,y}$  is the angle of the ray  $\mathbb{R}\vec{x}\vec{y}$ , see Figure 8.

Alternatively, the massive Green function  $G^{m(k)}(x, y)$  can be expressed as

$$G^{m(k)}(x, y) = \frac{k'}{4i\pi} \oint_{\gamma_{x,y}} H(u|k) \mathbf{e}_{(x,y)}(u|k) du, \quad (19)$$

where the function  $H$  is defined in Equation (9),  $\gamma_{x,y}$  is a trivial contour on the torus, not crossing  $\mathcal{C}_{x,y}$  and containing in its interior all the poles of  $\mathbf{e}_{(x,y)}(\cdot|k)$  and the pole of  $H(\cdot|k)$ , see Figure 8.

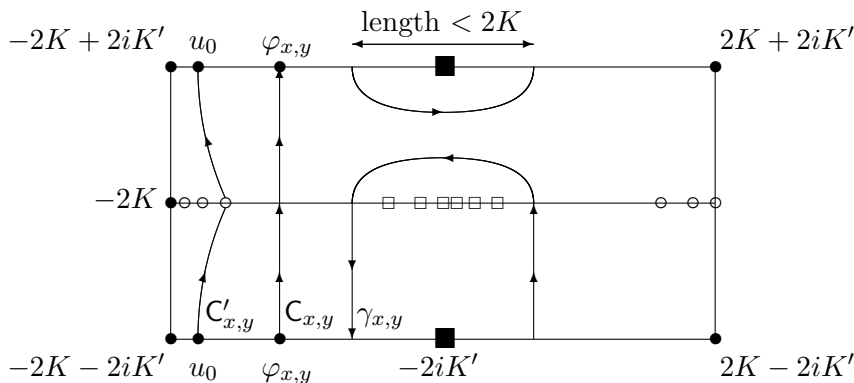

Figure 8: The fundamental rectangle  $[-2K, 2K] + i[-2K', 2K']$  with a representation of the integration contours  $C_{x,y}$  and  $\gamma_{x,y}$  of the Green function in (18) and (19), the poles of the exponential function  $e_{(x,y)}(\cdot|k)$  (white squares), the zeros of  $e_{(x,y)}(\cdot|k)$  (white bullets), the pole of the function  $H(\cdot|k)$  in (19) (black square), the saddle point  $u_0$  and the steepest descent contour  $C'_{x,y}$  used in the proof of Theorem 14.

*Remark 13.*

- Formula (18) has the remarkable feature of being *local*, meaning that the Green function  $G^{m(k)}(x, y)$  is computed using geometric information of a path from  $x$  to  $y$  only. This feature is inherited from the massive exponential function, see Definition 3.3. Note also, that there is no periodicity assumption on the graph  $G$ , and that explicit computations can be performed using the residue theorem, see Formulas (20), (21) and (22). More details and a description of the context, in particular the papers [Ken02] and [BdT11], can be found in the introduction.
- In the limiting case  $k \rightarrow 0$ , the torus becomes an infinite cylinder ( $K \rightarrow \pi/2$  and  $K' \rightarrow \infty$ ), the contour of integration  $\gamma_{x,y}$  becomes an infinite (vertical) straight line, and one has  $H(u) \rightarrow u/(2\pi)$  thanks to Lemma 45 of Appendix A.2. In this way, we formally obtain the following expression for the massless Green function:

$$G^{m(0)}(x, y) = \frac{1}{8i\pi^2} \int_{\gamma_{x,y}} u e_{(x,y)}(u|0) du.$$

This expression, after the change of variable  $z = -e^{iu}$ , is exactly the one given by Kenyon in [Ken02, Theorem 7.1]. Strictly speaking, the limit of (18) when  $k$  goes to 0 is infinite, which can be expected, since when  $k = 0$ , the mass vanishes and the corresponding random walk is recurrent. However, if the diagonal is subtracted, one can take the limit, make sense of the change of variable, and recover Kenyon's expression.

- Note that we can add to  $H$  in (19) any elliptic function  $f$  on  $\mathbb{T}(k)$  without changing the result. Indeed, the sum of residues of  $f e_{(x,y)}$  on  $\mathbb{T}(k)$  is equal to zero.

*Proof.* Let us first prove the equality between expressions (18) and (19). The function  $H$  is multivalued because of a horizontal period. By Lemma 45 of Appendix A.2, a determination of  $H$  on  $\mathbb{T}(k) \setminus \mathbb{C}_{x,y}$  is meromorphic on this domain, it has a single pole at  $2iK'$ , and the jump across  $\mathbb{C}_{x,y}$  is constant and equal to 1. We start from expression (19). On the torus  $\mathbb{T}(k)$  deprived of  $\mathbb{C}_{x,y}$  and from the poles of  $H e_{(x,y)}$ ,  $\gamma_{x,y}$  is homologically equivalent to two vertical contours, one on each side of  $\mathbb{C}_{x,y}$ , with different orientations. The sum of the integrals of  $H e_{(x,y)}$  on these two vertical contours is equal to the integral along  $\mathbb{C}_{x,y}$  of the jump of  $H e_{(x,y)}$  across  $\mathbb{C}_{x,y}$ , which is equal to  $e_{(x,y)}$ . We thus obtain expression (18).

The vertex  $y$  is considered fixed. Denote by  $f(x)$  the common value of the right hand side of (18) and (19). Using the idea of the argument of [Ken02], we now prove that  $f(x)$  is the Green function  $G^m(x, y)$ . We first show that  $(\Delta^m f)(x) = \delta_y(x)$ . The argument is separated into two cases.

**Case  $x \neq y$ .** Denote by  $e^{i\bar{\alpha}_1}, \dots, e^{i\bar{\alpha}_n}$  the unit vectors coding the edges of  $\mathbb{G}^\diamond$  around  $x$ , and by  $x_1, \dots, x_n$  the neighbors of  $x$  in  $\mathbb{G}$  listed counterclockwise, such that  $x_j = x + e^{i\bar{\alpha}_j} + e^{i\bar{\alpha}_{j+1}}$ . For definiteness, we chose  $e^{i\bar{\alpha}_1}$  to be the first vector when going counterclockwise around  $x$ , starting from the segment  $[y, x]$ , and we have  $\bar{\alpha}_{j+1} = \bar{\alpha}_j + 2\bar{\theta}_j$ , where  $\bar{\theta}_j \in (\varepsilon, \pi/2 - \varepsilon)$  is the the rhombus half-angle of the edge  $xx_j$ .

The poles of the function  $e_{(x,y)}(u)$  are encoded by the steps of a minimal path from  $x$  to  $y$ . If the steps of the minimal path are  $\{e^{i\bar{\alpha}_\ell}\}$ , the poles are  $\{\alpha_\ell + 2K\}$ , see Remark 10 and Figure 8. According to [BdT11, Lemma 17], the steps are contained in a sector of angle not larger than  $\pi$ , avoiding the half-line  $\mathbb{R}^+ \vec{y}\vec{x}$ . As a consequence, the poles  $\{\alpha_\ell + 2K\}$  can be chosen in an interval of length not larger than  $2K$  and not touching the contour  $\mathbb{C}_{x,y}$  used for the integration in (18) (see again Figure 8). The contour  $\mathbb{C}_{x,y}$  can be moved to the left or to the right as long as it does not cross any of these poles.

In the function  $e_{(x_j,y)}(u) = e_{(x_j,x)}(u) e_{(x,y)}(u)$ , we have (at most) a subset of the poles of  $e_{(x,y)}(u)$  (since one of the poles of  $e_{(x,y)}(u)$  can be canceled by a zero of  $e_{(x_j,x)}(u)$ ), plus those associated to  $e_{(x_j,x)}(u)$ , which are  $\alpha_j, \alpha_{j+1}$ . The whole set of poles  $\{\alpha_\ell + 2K, \alpha_j\}$  avoids a sector to which we can move all the contours  $\mathbb{C}_{x,y}$  and  $\mathbb{C}_{x_1,y}, \dots, \mathbb{C}_{x_n,y}$ , without crossing any pole, and thus use the same contour of integration  $\mathbb{C}$  for  $f(x)$  and  $f(x_j)$ . By linearity of the integral, we thus have

$$(\Delta^m f)(x) = \left( \frac{k'}{4i\pi} \Delta^m \int_{\mathbb{C}} \exp_{(\cdot,y)}(u) du \right) (x) = \frac{k'}{4i\pi} \int_{\mathbb{C}} [\Delta^m \exp_{(\cdot,y)}(u)](x) du.$$

By Proposition 11, the term in square brackets on the right-hand side is zero, and we conclude that  $f$  is massive harmonic outside of  $y$ .

**Case  $x = y$ .** By definition of the massive Laplacian, we have

$$(\Delta^m f)(x) = d(x)f(x) - \sum_{j=1}^n \rho(\theta_j) f(x_j).$$

The values of  $f$  at  $x$  and its neighbors  $x_j$  are obtained by a direct computation of the integral defining  $f$  with the residue theorem, explicited in Lemma 46 of Appendix B:

$$f(x_j) = H(\alpha_j) - H(\alpha_{j+1}) + \frac{k'K'}{\pi} \mathbf{e}_{(x_j,x)}(2iK'), \quad f(x) = \frac{k'K'}{\pi},$$

with the convention that  $\alpha_{n+1} = \alpha_1 + 4K$ . By Equation (16),

$$\frac{k'K'}{\pi} \left( d(x) - \sum_{j=1}^n \rho(\theta_j) \mathbf{e}_{(x_j,x)}(2iK') \right) = 0,$$

so that the remaining terms are

$$(\Delta^m f)(x) = \sum_{j=1}^n H(\alpha_{j+1}) - H(\alpha_j) = H(\alpha_1 + 4K) - H(\alpha_1) = 1,$$

where in the last equality, we used the first point of Lemma 45.

In the forthcoming Proposition 18, we prove that  $f(x)$  decays (exponentially fast) to zero. Since  $G^m(x, y)$  also goes to zero when  $x$  goes to infinity, and has the same massive Laplacian as  $f$ , the difference  $G^m(\cdot, y) - f$  tends to zero at infinity and is harmonic: by the maximum principle,  $f$  has to be equal to  $G^m(\cdot, y)$ .  $\square$

**Examples.** Formula (19) of Theorem 12 allows for explicit computations using the residue theorem. We now list a few special values. Details are given in Lemma 46 of Appendix B.

- For every vertex  $x$  of  $\mathbf{G}$ ,

$$G^{m(k)}(x, x) = \frac{k'K'}{\pi}. \quad (20)$$

Note that this value does not depend on  $x$ , and is a function of  $k$  only.

- Let  $x, y$  be two adjacent vertices of  $\mathbf{G}$ , and let  $\theta$  be the rhombus half-angle of the edge  $xy$ , then

$$G^{m(k)}(x, y) = \frac{K' \operatorname{dn}(\theta)}{\pi} - \frac{H(2\theta)}{\operatorname{sc}(\theta)}. \quad (21)$$

- In the limit  $k \rightarrow 0$ ,

$$\lim_{k \rightarrow 0} (G^{m(k)}(x, x) - G^{m(k)}(x, y)) = \frac{\theta}{\pi \tan \theta}, \quad (22)$$

which is the value obtained by Kenyon [Ken02, Section 7.2] in the critical case.

### 4.3 Asymptotics of the Green function

In this section, we suppose that the graph  $\mathbf{G}$  is quasicrystalline and compute asymptotics of the Green function  $G^{m(k)}(x, y)$  when the graph distance in  $\mathbf{G}^\diamond$  between  $x$  and  $y$  is large.

Under the quasicrystalline assumption, the number of directions  $\pm e^{i\bar{\alpha}}$  assigned to edges of the diamond graph  $\mathbf{G}^\diamond$  is finite, and  $\mathbf{G}^\diamond$  can be seen as the projection of a monotone surface in  $\mathbb{Z}^\ell$ , see Section 2.1.2. The distance between two vertices  $x$  and  $y$  of  $\mathbf{G}$ , measured as the length of a minimal path, is thus the graph distance between  $x$  and  $y$  seen as vertices of  $\mathbf{G}^\diamond$ . It is also the graph distance in  $\mathbb{Z}^\ell$  between the corresponding points on the monotone surface, and we denote it by  $|x - y|$ , where  $x - y \in \mathbb{Z}^\ell$  is the vector between the points on the surface.

In order to state Theorem 14, we need the following notation. By [BdT11, Lemma 17], the set  $\{\alpha_1, \dots, \alpha_p\}$  of zeros of  $e_{(x,y)}(u)$  is contained in an interval of length  $2K - 2\varepsilon$ , for some  $\varepsilon > 0$ . Let us denote by  $\alpha$  the midpoint of this interval. We also need the function  $\chi$  defined by

$$\chi(u) = \frac{1}{|x - y|} \log\{e_{(x,y)}(u + 2iK')\},$$

which is analytic in the cylinder  $\mathbb{R}/(4K\mathbb{Z}) + (-2iK', 2iK')$ .

**Theorem 14.** *Let  $\mathbf{G}$  be a quasicrystalline isoradial graph. When the distance  $|x - y|$  between vertices  $x$  and  $y$  of  $\mathbf{G}$  is large, we have*

$$G^{m(k)}(x, y) = \frac{k'}{2\sqrt{2\pi|x - y|\chi''(u_0|k)}} e^{[x-y]\chi(u_0|k)} \cdot (1 + o(1)), \quad (23)$$

where  $u_0$  is the unique  $u \in \alpha + (-K + \varepsilon, K - \varepsilon)$  such that  $\chi'(u|k) = 0$ , and  $\chi(u_0|k) < 0$ .

For periodic isoradial graphs, a geometric interpretation of  $u_0$  is provided in Section 5.5.2.

The proof consists in applying the saddle-point method to the contour integral expression (18) given in Theorem 12. Note that the approach is different from [Ken02], where the author obtains asymptotics of the Green function by the Laplace method, as there are no saddle-points in the critical case. The proof of Theorem 14 is split as follows. In Lemma 15, we first show that there is a unique  $u \in \alpha + (-K + \varepsilon, K - \varepsilon)$  such that  $\chi'(u|k) = 0$ . Then, in Lemma 16 we prove that  $\chi(u_0|k) < 0$ , implying exponential decay of the Green function. Finally, we conclude the proof of Theorem 14. Note that Lemmas 15 and 16 do not use the quasicrystalline assumption.

Let us introduce some notation. Denote by  $N_j$  the number of times a step  $e^{i\bar{\alpha}_j}$  is taken in a minimal path from  $x$  to  $y$ , so that  $N_1 + \dots + N_p = |x - y|$ . Using Equation (15), one has

$$e_{(x,y)}(u) = \left\{ i\sqrt{k'} \operatorname{sc} \left( \frac{u - \alpha_1}{2} \right) \right\}^{N_1} \times \dots \times \left\{ i\sqrt{k'} \operatorname{sc} \left( \frac{u - \alpha_p}{2} \right) \right\}^{N_p}.$$

With  $n_j = N_j/|x - y|$ , the function  $\chi$  is equal to

$$\chi(u) = n_1 \log \left\{ \sqrt{k'} \operatorname{nd} \left( \frac{u - \alpha_1}{2} \right) \right\} + \dots + n_p \log \left\{ \sqrt{k'} \operatorname{nd} \left( \frac{u - \alpha_p}{2} \right) \right\}, \quad (24)$$



where we used (54) to simplify  $e_{(x,y)}(u + 2iK')$ . Because of the logarithm,  $\chi$  is not meromorphic on  $\mathbb{T}(k)$ , but is meromorphic (and even analytic) in the cylinder  $\mathbb{R}/(4K\mathbb{Z}) + (-2iK', 2iK')$ .

**Lemma 15.** *There is a unique  $u_0$  in  $\alpha + (-K + \varepsilon, K - \varepsilon)$  such that  $\chi'(u|k) = 0$ .*

*Proof.* Rotating  $\mathbb{G}$ , we assume that  $\alpha = 0$ . Using [Law89, 2.5.8], the equation of Lemma 15 is equivalent to:

$$n_1 \frac{\operatorname{sn} \cdot \operatorname{cn}}{\operatorname{dn}} \left( \frac{u - \alpha_1}{2} \right) + \cdots + n_p \frac{\operatorname{sn} \cdot \operatorname{cn}}{\operatorname{dn}} \left( \frac{u - \alpha_p}{2} \right) = 0. \quad (25)$$

The above function is meromorphic on the torus  $\mathbb{T}(k)$ . By Landen's ascending transformation (see (58) of Appendix A), Equation (25) can be rewritten in a simpler way, as follows:

$$n_1 \operatorname{sn}(v - \gamma_1|\ell) + \cdots + n_p \operatorname{sn}(v - \gamma_p|\ell) = 0, \quad (26)$$

where  $\ell$  and  $\mu$  are defined in (58), and we have noted  $v = \frac{(1+\mu)u}{2}$  and  $\gamma_i = \frac{(1+\mu)\alpha_i}{2}$ .

Using the relation (59) between  $K, K'$  and  $K(\ell), K'(\ell)$ , and the identity  $(1 + \mu)(1 + \ell) = 2$ , under the change of variable, the torus  $\mathbb{T}(k)$  becomes  $\tilde{\mathbb{T}}(\ell) = \mathbb{C}/(4K(\ell)\mathbb{Z} + 2iK'(\ell)\mathbb{Z})$ , and the  $\gamma_i$ 's are in  $(-K(\ell) + \tilde{\varepsilon}, K(\ell) - \tilde{\varepsilon})$ . Hereafter we shall replace  $\tilde{\varepsilon}$  by  $\varepsilon$ .

Let  $f$  be the function  $f(v) = 2(1 + \mu)\chi'(\frac{2v}{1+\mu})$  defined on the left-hand side of Equation (26). We now show that  $f$  has a unique zero on the interval  $(-K(\ell) + \varepsilon, K(\ell) - \varepsilon)$ .

First notice that in the degenerate case  $\ell = 0$  this is obvious: the addition formula for the sine function gives the unique solution  $v = \arctan\left(\frac{\sum_{j=1}^p n_j \sin(\gamma_j)}{\sum_{j=1}^p n_j \cos(\gamma_j)}\right) \in (-\pi/2, \pi/2)$ . In the other degenerate case  $\ell = 1$ ,  $\operatorname{sn}$  becomes the hyperbolic tangent function, and (26) is a sum of  $p$  increasing functions on  $\mathbb{R}$ , which obviously has a unique zero on  $\mathbb{R}$ . The situation is more complicated in the remaining cases  $\ell \in (0, 1)$ , where we show that:

1.  $f$  has  $2p$  simple poles in  $\tilde{\mathbb{T}}(\ell)$  (and thus also  $2p$  zeros in  $\tilde{\mathbb{T}}(\ell)$ , counted with multiplicities);
2.  $f$  has at least one zero in the interval  $(-K(\ell) + \varepsilon, K(\ell) - \varepsilon) \subset \tilde{\mathbb{T}}(\ell)$ , and at least one zero in  $(K(\ell) + \varepsilon, 3K(\ell) - \varepsilon) \subset \tilde{\mathbb{T}}(\ell)$ ;
3.  $f$  has at least  $2p - 2$  zeros on  $-iK'(\ell) + \mathbb{R}/(4K(\ell)\mathbb{Z})$ .

From 1, 2 and 3 it immediately follows that the zero of (26) on  $(-K(\ell) + \varepsilon, K(\ell) - \varepsilon)$  is unique.

Point 1 is clear: each function  $n_i \operatorname{sn}(v - \gamma_i|\ell)$  has two simple poles, at points congruent to  $\gamma_i - iK'(\ell)$  and  $\gamma_i - iK'(\ell) + 2K(\ell)$ . The poles cannot compensate for different values of  $i$ , since the  $\gamma_i$ 's are in an interval whose length is strictly less than  $2K(\ell)$ .

The intermediate value theorem yields Point 2. At  $v = -K(\ell) + \varepsilon$  (resp.  $v = K(\ell) - \varepsilon$ ), each  $\operatorname{sn}(v - \gamma_i|\ell)$  is negative (resp. positive). We thus have at least one solution in  $(-K(\ell) + \varepsilon, K(\ell) - \varepsilon)$ . Since  $\operatorname{sn}(v + 2K(\ell)|\ell) = -\operatorname{sn}(v|\ell)$ , the same holds in the interval  $(K(\ell) + \varepsilon, 3K(\ell) - \varepsilon)$ .

We now prove Point 3. In an interval of the form  $-iK'(\ell) + [\gamma_i, \gamma_j]$ , where  $\gamma_i$  and  $\gamma_j$  are consecutive, the function  $f$  has at least one zero. Indeed, evaluating  $f$  at  $-iK' + v$  and using the addition formula (55) for sn by a quarter-period, we obtain

$$\frac{1}{\ell} \left( \frac{n_1}{\operatorname{sn}(v - \gamma_1|\ell)} + \cdots + \frac{n_p}{\operatorname{sn}(v - \gamma_p|\ell)} \right).$$

As  $v \rightarrow \gamma_i + 0$  (resp.  $v \rightarrow \gamma_j - 0$ ) the above function goes to  $+\infty$  (resp.  $-\infty$ ). We conclude with the intermediate value theorem. We thus obtain  $p - 1$  zeros. The same reasoning on  $-iK'(\ell) + [\gamma_i + 2K(\ell), \gamma_j + 2K(\ell)]$  provides  $p - 1$  zeros. These zeros are mutually disjoint.  $\square$

**Lemma 16.** *One has the following inequality, implying exponential decay of the Green function,*

$$\chi(u_0) = \min\{\chi(u) : u \in \alpha + (-K + \varepsilon, K - \varepsilon)\} \leq \log\{\sqrt{k'} \operatorname{nd}(\varepsilon/2)\} < 0.$$

*Proof.* First recall from Lemma 15 and its proof that, on the interval  $\alpha + (-K + \varepsilon, K - \varepsilon)$ , in the neighborhood of which  $\chi$  is analytic,  $\chi'$  has a unique zero. It is negative at  $\alpha - K + \varepsilon$  and positive at  $\alpha + K - \varepsilon$ . This implies that  $\chi(u_0)$  is the minimum of  $\chi$  on  $\alpha + (-K + \varepsilon, K - \varepsilon)$ .

We now compute the value of  $\chi(\alpha)$ :

$$\chi(\alpha) = n_1 \log \left\{ \sqrt{k'} \operatorname{nd} \left( \frac{\alpha - \alpha_1}{2} \right) \right\} + \cdots + n_p \log \left\{ \sqrt{k'} \operatorname{nd} \left( \frac{\alpha - \alpha_p}{2} \right) \right\}.$$

For  $u \in (-K/2, K/2)$  one has  $\operatorname{nd}(u) \in [1, 1/\sqrt{k'}]$ , see [AS64, 16.5.2]. Further,  $\operatorname{nd}$  is decreasing (resp. increasing) on  $(-K/2, 0]$  (resp.  $[0, K/2)$ ). This implies that each term above satisfies

$$n_j \log \left\{ \sqrt{k'} \operatorname{nd} \left( \frac{\alpha - \alpha_j}{2} \right) \right\} \leq n_j \log\{\sqrt{k'} \operatorname{nd}(\varepsilon/2)\}. \quad \square$$

*Proof of Theorem 14.* Starting from Equation (18) defining  $G^m(x, y)$ , performing the change of variable  $u + 2iK' \rightarrow u$  and using the definition of  $\chi$ , the Green function between  $x$  and  $y$  is rewritten as

$$G^m(x, y) = \frac{k'}{4i\pi} \int_{\mathbf{C}_{x,y}} e^{|x-y|\chi(u)} du,$$

where  $\mathbf{C}_{x,y}$  is the vertical closed loop defined in Theorem 12, and is thus invariant by vertical translation. Our aim is to compute asymptotics of this integral when  $|x - y|$  is large. We use the saddle-point method (for classical facts our reference is [Cop65, Chapter 8]), with some particularities coming from the fact the  $n_j$ 's involved in the function  $\chi$  depend on  $|x - y|$  and do not necessarily converge as  $|x - y| \rightarrow \infty$ . For this reason, we will typically have to apply the saddle-point method in a uniform way.

When the graph  $\mathbf{G}$  is periodic, however, this is the classical saddle-point method. Indeed, we can write  $\mathbf{e}_{(x,y)}(u) = \mathbf{e}_{(x,y')}(u) \mathbf{e}_{(y',y)}(u)$ , where  $y'$  is the point congruent to  $y$  in the same fundamental domain as  $x$ . Then the periodicity allows to write  $\mathbf{e}_{(y',y)}(u)$  as  $\mathbf{e}_{(y',y'')}(u)^L$ . We

thus have to compute the asymptotics of  $\int_{\mathcal{C}_{x,y}} e_{(x,y)}(u) e_{(y',y'')}(u)^L du$  for large values of  $L$ , all functions in the integral being independent of  $L$ . Although the periodic case could be considered more classically, and thus apart, we choose to treat both the periodic and non-periodic cases at the same time. We move the contour  $\mathcal{C}_{x,y} = \varphi_{x,y} + [-2iK', 2iK']$  into a new one  $\mathcal{C}'_{x,y}$ , directed upwards, going through  $u_0$  and satisfying some further properties, to be specified now. See Figure 8 for a representation of the contours  $\mathcal{C}_{x,y}$  and  $\mathcal{C}'_{x,y}$ .

**Neighborhood of the saddle-point.** Near  $u_0$  we choose  $\mathcal{C}'_{x,y}$  to be  $[u_0 - i\eta, u_0 + i\eta]$ , where  $\eta = |x - y|^{-\alpha}$ ,  $\alpha > 0$  being fixed later on. Hereafter we write  $\chi(u) = \chi(u_0) + \sum_{j=2}^{\infty} a_j(u - u_0)^j$ , and define  $F(u) = \chi(u) - \chi(u_0) - a_2(u - u_0)^2 = \sum_{j=3}^{\infty} a_j(u - u_0)^j$ . This function is analytic on a disc centered at  $u_0$  and with some radius  $r$ ;  $M$  denotes its maximum on the disc. Simple computations lead to the upper bound (see [Cop65, Equation (36.3)] for full details)

$$|F(u)| \leq \frac{M|u - u_0|^3}{r^2(r - |u - u_0|)} \leq \frac{2M}{r^3}|x - y|^{-3\alpha} \leq C \cdot |x - y|^{-3\alpha}. \quad (27)$$

In the last inequality we can choose  $C$  to be independent of  $|x - y|$ , thanks to the fact that  $\chi$  depends continuously on the  $n_j$ 's. With the above estimation one can write

$$\begin{aligned} \int_{[u_0 - i\eta, u_0 + i\eta]} e^{|x-y|\chi(u)} du &= e^{|x-y|\chi(u_0)} \int_{[u_0 - i\eta, u_0 + i\eta]} e^{|x-y|a_2(u-u_0)^2} du \cdot (1 + O(|x-y|^{1-3\alpha})) \\ &= \frac{ie^{|x-y|\chi(u_0)}}{\sqrt{|x-y|a_2}} \int_{[-\sqrt{|x-y|a_2}\eta, \sqrt{|x-y|a_2}\eta]} e^{-t^2} dt \cdot (1 + O(|x-y|^{1-3\alpha})) \\ &= \frac{i\sqrt{\pi}e^{|x-y|\chi(u_0)}}{\sqrt{|x-y|a_2}} \cdot (1 + O(|x-y|^{1-3\alpha})) \cdot (1 + O(e^{-|x-y|a_2\eta^2})). \end{aligned} \quad (28)$$

We now show that  $a_2 = \chi''(u_0)/2$  remains bounded away from 0 independently of  $|x - y|$ . First, it comes from the analytic implicit function theorem that  $u_0$  is an analytic function of the  $n_j$ 's. Accordingly,  $a_2$  is positive and continuous on  $\{(n_1, \dots, n_p) : n_j \geq 0 \text{ and } n_1 + \dots + n_p = 1\}$ . Under the quasicrystalline hypothesis this set is compact, and thus  $a_2$  can be bounded from below by its (positive) minimum. To conclude, we take any  $1/3 < \alpha < 1/2$  to obtain that the contribution of the neighborhood of  $u_0$  to the integral gives the result stated in Theorem 14.

**Outside a neighborhood of the saddle-point.** We prove that the rest of the integral does not contribute in the limit. For this, we show that  $\mathcal{C}'_{x,y}$  can be chosen such that:

$$\forall u \in \mathcal{C}'_{x,y} \setminus [u_0 - i\eta, u_0 + i\eta], \quad |e^{\chi(u)}| \leq |e^{\chi(u_0 \pm i\eta)}|. \quad (29)$$

Recall that the exponential function  $e_{(x,y)}(u + 2iK')$  has its zeros on the interval  $\pm 2iK' + \mathbb{R}/(4K\mathbb{Z})$ , see Figure 8. Consider the steepest descent path starting from  $u_0 \pm i\eta$  until it hits one of the zeros of the exponential function (note that obviously it cannot cross the line  $[-2K, 2K] + 2iK'$  before). The resulting contour  $\mathcal{C}'_{x,y}$  is a deformation of  $\mathcal{C}_{x,y}$  and is symmetric (the level lines and hence the steepest descent paths of  $e^{\chi(u)}$  are symmetric with

respect to the horizontal axis, this comes from properties of the  $\text{nd}(\cdot)$  function, see [AS64, 16.21.4]).

On  $C'_{x,y} \setminus [u_0 - i\eta, u_0 + i\eta]$ , we have  $|e^{x-y|\chi(u)}| \leq e^{x-y|\chi(u_0)} e^{-|x-y|a_2\eta^2} e^{C|x-y|^{1-3\alpha}}$  by (27) and (29), which readily implies that

$$\int_{C'_{x,y} \setminus [u_0 - i\eta, u_0 + i\eta]} e^{x-y|\chi(u)} du = O(e^{x-y|\chi(u_0)} e^{-|x-y|a_2\eta^2} e^{C|x-y|^{1-3\alpha}}), \quad (30)$$

since we can take the supremum of the lengths of  $C'_{x,y}$  bounded, because of the continuity of the level lines with respect to the parameters.

The integral (30) is exponentially negligible with respect to the integral (28) on  $[u_0 - i\eta, u_0 + i\eta]$ . The proof of Theorem 14 is complete.  $\square$

*Remark 17.* If there were an infinite number of directions  $\alpha_j$  (non-quasicrystalline case), the Green function would still exponentially decay to 0, see Proposition 18 and Lemma 16. However, our conjecture is that the asymptotic behavior is exactly the same as in Theorem 14. The technical issue is to prove that  $\chi''(u_0)$  remains bounded away from 0 as  $|x - y|$  becomes large. From our analysis, we only know that the second derivative at  $u_0$  is non-negative.

**Proposition 18.** *Let  $\mathbf{G}$  be any infinite isoradial graph (not necessarily quasicrystalline). When the distance  $|x - y|$  between vertices  $x$  and  $y$  of  $\mathbf{G}$  is large, we have*

$$G^{m(k)}(x, y) = O(e^{x-y|\chi(u_0|k)}),$$

where  $u_0$  is the unique  $u \in \alpha + (-K + \varepsilon, K - \varepsilon)$  such that  $\chi'(u|k) = 0$ , and  $\chi(u_0|k) < 0$ .

*Proof.* The proof is the same as the one of Theorem 14: there exists a contour  $C'_{x,y}$  such that (29) holds with  $\eta = 0$ . In this way, the upper bound of Proposition 18 immediately follows.  $\square$

## 5 The case of periodic isoradial graphs

In this section, we suppose that the isoradial graph  $\mathbf{G}$  is  $\mathbb{Z}^2$ -periodic, meaning that  $\mathbf{G}$  is embedded in the plane so that it is invariant under translations of  $\mathbb{Z}^2$ . The massive Laplacian  $\Delta^{m(k)}$  is a periodic operator. It is described through its Fourier transform  $\Delta^{m(k)}(z, w)$ , which is the massive Laplacian matrix of the toric graph  $\mathbf{G}_1 = \mathbf{G}/\mathbb{Z}^2$ , with modified edge-weights on edges crossing a horizontal and vertical cycle. Objects of interest are: the *characteristic polynomial*,  $P_{\Delta^{m(k)}}(z, w)$ , equal to the determinant of the matrix  $\Delta^{m(k)}(z, w)$ ; the zero locus of this polynomial, known as the spectral curve and denoted  $\mathcal{C}^k$ , and its amoeba  $\mathcal{A}^k$ .

In Section 5.2, we prove confinement results for the Newton polygon of the characteristic polynomial  $P_{\Delta^{m(k)}}(z, w)$ . In Section 5.3, we provide an explicit parametrization of the spectral curve  $\mathcal{C}^k$  by discrete massive exponential functions. This allows us to prove that  $\mathcal{C}^k$  is a

curve of genus 1 (Proposition 21), and to recover the Newton polygon using the homology of the train-tracks only. In Theorem 25, we prove that the curve  $\mathcal{C}^k$  is a Harnack curve. Furthermore, in Theorem 26, we prove that every genus 1, Harnack curve with  $(z, w) \leftrightarrow (z^{-1}, w^{-1})$  symmetry arises from the massive Laplacian  $\Delta^{m(k)}$  on some isoradial graph for some  $k \in (0, 1)$ .

Using Fourier techniques, the massive Green function can be expressed using the characteristic polynomial. In Section 5.5, we explain how to recover the local formula of Theorem 12 for the massive Green function (in the periodic case) from its Fourier expression. A priori, the two approaches are completely different; it is an astonishing change of variable which works with our specific choice of weights. Note that this relation was not understood in [Ken02, BdT11, dT07]. Then, we also explain how to recover asymptotics of the Green function obtained in Theorem 14 from the double integral formula of Equation (36), using analytic combinatorics techniques from [PW13].

## 5.1 Isoradial graphs on the torus and their train-tracks

If  $\mathbf{G}$  is a  $\mathbb{Z}^2$ -periodic isoradial graph, then the graph  $\mathbf{G}_1 = \mathbf{G}/\mathbb{Z}^2$  is an isoradial graph embedded in the torus  $\mathbf{T}$ . Let  $\mathbf{G}_1^\diamond$  be the diamond graph of  $\mathbf{G}_1$ . Properties of train-tracks of planar isoradial graphs discussed in Section 2.1.1 have to be adapted to the toroidal case, see also [KS05].

We need the notion of *intersection form* for closed paths on the torus  $\mathbf{T}$ . Let  $A$  and  $B$  be two oriented closed paths on the torus  $\mathbf{T}$  having a finite number of intersections. Then  $A \wedge B$  denotes the algebraic number of intersections between  $A$  and  $B$ , where an intersection is counted positively (resp. negatively) if when following  $A$ , we see  $B$  crossing from right to left (resp. from left to right). In particular,

$$|A \wedge B| \leq \#\{\text{intersection points of } A \text{ and } B\}.$$

The quantity  $A \wedge B$  only depends on the homology classes  $[A]$  and  $[B]$  in  $H_1(\mathbf{T}, \mathbb{Z}^2)$ . If  $([U], [V])$  is a homology basis, and  $[A] = h_A[U] + v_A[V]$ ,  $[B] = h_B[U] + v_B[V]$ , then

$$A \wedge B = h_A v_B - h_B v_A. \tag{31}$$

Recall from Section 2.1.1 that train-tracks can be seen as unoriented paths on the dual of the diamond graph, and that they are assigned the common edge direction  $\pm e^{i\bar{\alpha}}$  of the rhombi. A train-track  $T$  can also be seen as an oriented path. In this case we associate the angle  $\alpha$  of the unit vector  $e^{i\bar{\alpha}}$ , with the convention that when walking along  $T$ , the unit vector  $e^{i\bar{\alpha}}$  crosses  $T$  from right to left. If  $T$  is oriented in the other direction, it is associated the angle  $\alpha + 2K$  (modulo  $4K$ ) of  $e^{i\bar{\alpha}+2K} = e^{i(\bar{\alpha}+\pi)} = -e^{i\bar{\alpha}}$ . Seeing train-tracks as unoriented paths amounts to considering angles modulo  $2K$ .

**Train-tracks on the torus.** Train-tracks of  $G_1$  form non-trivial self-avoiding cycles on  $G_1^{\diamond*}$ . Contrary to what happens in the planar (either finite or infinite) case, two train-tracks  $T$  and  $T'$  can cross more than once, but the number of intersections is minimal, and thus equal to  $|T \wedge T'|$ .

Any vertex of  $G_1^{\diamond*}$  is at the intersection of two train-tracks, and edges of  $G_1^{\diamond*}$  are in bijection with pieces of train-tracks between two successive intersections. As in the planar case,  $G_1^{\diamond}$  is bipartite, the two classes of vertices corresponding to vertices of  $G_1$  and of  $G_1^*$ , respectively. In particular, any closed path on  $G_1^{\diamond}$  has even length. Conversely, any graph on the torus constructed from a collection of self-avoiding cycles with the minimal number of intersections, and whose dual is bipartite, is the dual of the diamond graph of an isoradial graph on the torus, which can then be lifted to a  $\mathbb{Z}^2$ -periodic isoradial graph. An example is provided in Figure 9 (left and middle).

**Minimal closed paths.** A closed path on  $G_1^{\diamond}$  is said to be *minimal* if it does not cross a train-track in two opposite directions. Paths in  $G_1^{\diamond}$  obtained by following the boundary of a train-track are examples of minimal closed paths.

Let  $2p$  be the number of edges of  $G_1^{\diamond}$  used by a minimal closed path  $\gamma$ . Then  $p$  is the number of vertices of  $G_1$  (and also of  $G_1^*$ ) visited by  $\gamma$ . The length  $2p$  of  $\gamma$  is a function of its homology class and of those of the train-tracks. It is equal to:

$$2p = \sum_{T \in \mathcal{T}} |T \wedge \gamma|,$$

where  $\mathcal{T}$  denotes the set of train-tracks of  $G_1$ , picking for each of them a particular orientation.

**Choice of basis, ordering of train-tracks.** Fix a representative of a basis of the first homology group of the torus  $H_1(\mathbf{T}, \mathbb{Z}^2)$ , by taking  $\gamma_x$  and  $\gamma_y$  to be two minimal oriented closed paths on  $G_1^{\diamond}$ . Define  $2p_x$  (resp.  $2p_y$ ) to be the number of edges of  $G_1^{\diamond}$  used by  $\gamma_x$  (resp.  $\gamma_y$ ). These numbers depend only on the homology classes of  $\gamma_x$  and  $\gamma_y$ .

An (oriented) train-track  $T$  has primitive homology class  $[T] = h_T[\gamma_x] + v_T[\gamma_y]$  in  $H^1(\mathbf{T}, \mathbb{Z}) \simeq \mathbb{Z}^2$ , *i.e.*, the two integers  $h_T$  and  $v_T$  are coprime, since it is a non-trivial, self-avoiding cycle. We can therefore cyclically order all train-tracks (oriented in the two possible directions), following the cyclic order of coprime numbers in  $\mathbb{Z}^2$  around the origin. Angles of the train-tracks are also in the same order in  $\mathbb{R}/4K\mathbb{Z}$ , this being guaranteed by the fact that we can place a rhombus at each intersection of two train-tracks, with the correct orientation, see Figure 9 (right).

## 5.2 Quasiperiodic functions, characteristic polynomial

Define  $\tilde{\gamma}_x$  and  $\tilde{\gamma}_y$  to be closed paths on  $G_1^*$ , obtained from  $\gamma_x$  and  $\gamma_y$  as follows: replace any sequence of steps  $x^* \rightarrow y \rightarrow z^*$  of dual, primal, dual vertices visited by  $\gamma_x$  (resp.  $\gamma_y$ ) by a

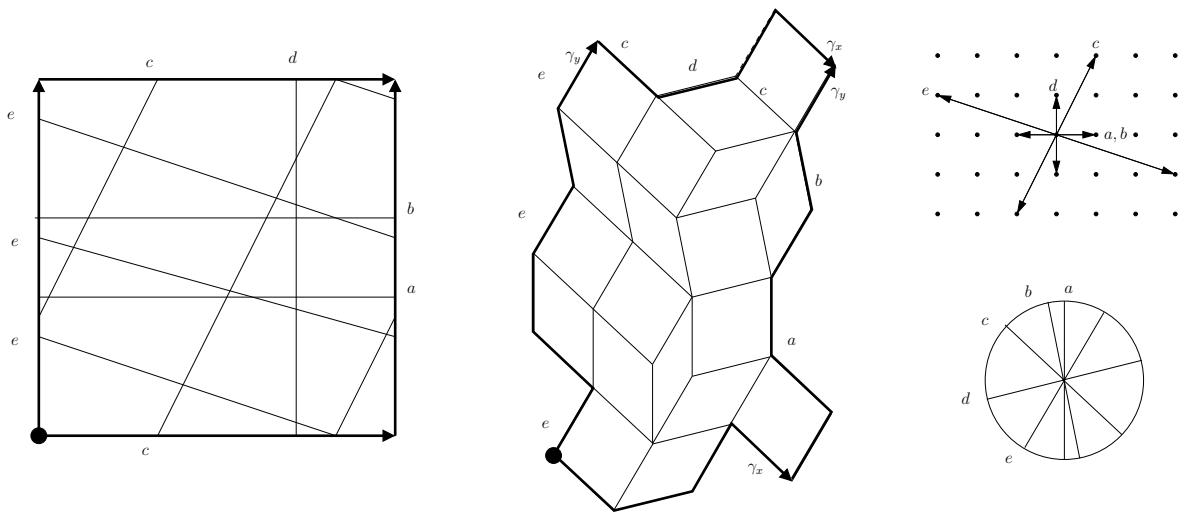

Figure 9: Left: a set of non-trivial cycles on the torus with the minimum number of intersections. Middle: the diamond graph of an isoradial graph on the torus, whose train-tracks have the same combinatorics as cycles on the left. Right: cyclic ordering of the homology class of the train-tracks and of the corresponding angles, represented on the trigonometric circle.

sequence  $x^* = x_0^* \rightarrow x_1^* \rightarrow \dots \rightarrow x_n^* = z^*$  of dual vertices around  $y$ , “bouncing” over  $y$  on top of  $\gamma_x$  (resp. on the right of  $\gamma_y$ ), and remove backtracking steps if necessary. In other words,  $\tilde{\gamma}_x$  goes around every vertex of  $\mathbf{G}_1$  visited by  $\gamma_x$  in the clockwise order, see Figure 10.

The cycles  $\tilde{\gamma}_x$  and  $\tilde{\gamma}_y$  delimit a *fundamental domain* of  $\mathbf{G}$ . To simplify notation, we will write  $\tilde{\gamma}_x$  and  $\tilde{\gamma}_y$  for the cycles and their lifts in  $\mathbf{G}$ , and write  $\mathbf{G}_1 = (\mathbf{V}_1, \mathbf{E}_1)$  for the toroidal graph and the fundamental domain.

For  $(m, n)$  in  $\mathbb{Z}^2$ , and  $x$  a vertex of  $\mathbf{G}$  (resp.  $\mathbf{G}^\diamond$ , resp.  $\mathbf{G}^*$ ), denote by  $x + (m, n)$  the vertex  $x + m\tilde{\gamma}_x + n\tilde{\gamma}_y$ . For  $(z, w) \in \mathbb{C}^2$ , define  $\mathbb{C}_{(z,w)}^{\mathbf{V}}$  to be the space of functions  $f$  on vertices of  $\mathbf{G}$  which are  $(z, w)$ -quasiperiodic:

$$\forall x \in \mathbf{V}, \forall (m, n) \in \mathbb{Z}^2, \quad f(x + (m, n)) = z^{-m} w^{-n} f(x).$$

The vector space  $\mathbb{C}_{(z,w)}^{\mathbf{V}}$  is finite dimensional, isomorphic to  $\mathbb{C}^{\mathbf{V}_1}$ , since quasiperiodic functions are completely determined by their values in the fundamental domain  $\mathbf{V}_1$ . For every vertex  $x$  of  $\mathbf{G}_1$ , define  $\delta_x(z, w)$  to be the  $(z, w)$ -quasiperiodic function equal to zero on vertices which are not translates of  $x$ , and equal to 1 at  $x$ . Then the collection  $\{\delta_x(z, w)\}_{x \in \mathbf{V}_1}$  is a natural basis for  $\mathbb{C}_{(z,w)}^{\mathbf{V}}$ .

Since  $\Delta^m$  is periodic, the vector space  $\mathbb{C}_{(z,w)}^{\mathbf{V}}$  is invariant under the action of this operator. We denote by  $\Delta^m(z, w)$  the matrix of the restriction of  $\Delta^m$  to the space  $\mathbb{C}_{(z,w)}^{\mathbf{V}}$  in the basis  $(\delta_x(z, w))_x$ . The matrix  $\Delta^m(z, w)$  can be seen as the matrix of the massive Laplacian on  $\mathbf{G}_1$  with extra weight  $z^{\pm 1}$  (resp.  $w^{\pm 1}$ ) for edges crossing<sup>1</sup>  $\tilde{\gamma}_x$  (resp.  $\tilde{\gamma}_y$ ), the sign of the exponent

<sup>1</sup>An oriented edge crossing  $\tilde{\gamma}_y$  gets the extra weight  $z$  if it goes from a vertex in one fundamental domain

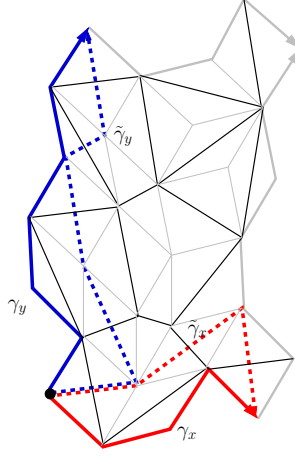

Figure 10: The paths  $\tilde{\gamma}_x$  and  $\tilde{\gamma}_y$  (in dashed lines) constructed from  $\gamma_x$  and  $\gamma_y$  (in plain lines) delimiting the fundamental domain  $G_1$ . Edges crossing the dashed path  $\tilde{\gamma}_x$  (resp.  $\tilde{\gamma}_y$ ) get an extra weight  $z, z^{-1}$  (resp.  $w, w^{-1}$ ) in  $\Delta^m(z, w)$ .

depending on the orientation of the edge with respect to  $\tilde{\gamma}_x$  or  $\tilde{\gamma}_y$ . By construction, these edges with extra weight  $z$  (resp.  $w$ ) are connected to vertices of  $G_1$  visited by  $\gamma_y$  (resp.  $\gamma_x$ ).

The *characteristic polynomial* of the massive Laplacian on  $G$  is the bivariate Laurent polynomial  $P_{\Delta^m}(z, w)$  equal to the determinant of the matrix  $\Delta^m(z, w)$ . The *Newton polygon* of  $P_{\Delta^m}$  is the convex hull of the exponents  $(i, j) \in \mathbb{Z}^2$  of the monomials  $z^i w^j$  of  $P_{\Delta^m}(z, w)$ .

The characteristic polynomial plays an important role in understanding the massive Laplacian on periodic isoradial graphs. We now study some of its properties.

**Lemma 19.**

- The polynomial  $P_{\Delta^m}$  is reciprocal:  $\forall (z, w) \in \mathbb{C}^2, P_{\Delta^m}(z, w) = P_{\Delta^m}(z^{-1}, w^{-1})$ .
- The Newton polygon of  $P_{\Delta^m}$  is contained in a rectangle  $[-p_y, p_y] \times [-p_x, p_x]$ , where  $p_x$  (resp.  $p_y$ ) is the number of vertices of  $G^*$  on  $\gamma_x$  (resp.  $\gamma_y$ ).

*Proof.* The operator  $\Delta^m$  is symmetric, thus  $\Delta^m(z, w)^T = \Delta^m(z^{-1}, w^{-1})$ , which implies the first part. For the second part, let us first prove that the Newton polygon is contained in a vertical strip  $[-p_y, p_y] \times \mathbb{R}$ . Since  $P_{\Delta^m}$  is reciprocal, it is enough to show that the degree of  $z$  in any monomial of  $P_{\Delta^m}$  cannot exceed  $p_y$ .

The determinant of  $\Delta^m(z, w)$  can be expanded as a sum over permutations  $\sigma$  of the vertices of  $G_1$ . In this sum, the monomials with highest degree in  $z$  come from bijections  $\sigma$  where as many vertices  $v$  as possible are connected to  $\sigma(v)$  with an edge crossing the path  $\tilde{\gamma}_y$ , hence

---

to a vertex in the fundamental domain on the right of  $\tilde{\gamma}_y$ , and  $z^{-1}$  otherwise. An oriented edge crossing  $\tilde{\gamma}_x$  gets the extra weight  $w$  if it goes from a vertex in one fundamental domain to a vertex in the fundamental domain above, *i.e.*, on the left of  $\tilde{\gamma}_x$ .



having an extra weight  $z$  in  $\Delta^m(z, w)$ . However, there are at most  $p_y$  vertices with this property, since they must be chosen among the  $p_y$  vertices visited by  $\gamma_y$ .

The fact that the Newton polygon is also contained in a horizontal strip  $\mathbb{R} \times [-p_x, p_x]$  follows from the same argument, by exchanging the role of  $z$  and  $w$ .  $\square$

The confinement result for the Newton polygon in the previous lemma is highly dependent on the homology class of the cycles  $\gamma_x$  and  $\gamma_y$ . If instead we use paths  $\underline{\gamma}_x, \underline{\gamma}_y$  representing another basis of the first homology group  $H_1(\mathbf{T}, \mathbb{Z}^2)$ , then we obtain that the Newton polygon is included in another parallelogram. More precisely, suppose that the paths  $\underline{\gamma}_x, \underline{\gamma}_y$  are oriented so that  $[\underline{\gamma}_x] = a[\gamma_x] + b[\gamma_y]$ , and  $[\underline{\gamma}_y] = c[\gamma_x] + d[\gamma_y]$ , where  $M = \begin{pmatrix} a & b \\ c & d \end{pmatrix} \in SL_2(\mathbb{Z})$ . Define also  $\underline{z} = z^a w^b$ , and  $\underline{w} = z^c w^d$ . Then we can do the same construction as above with the variables  $\underline{z}$  and  $\underline{w}$  across the paths  $\underline{\gamma}_y$  and  $\underline{\gamma}_x$ , to get a new polynomial  $\underline{P}_{\Delta^m}(z, w)$ . The polynomials  $\underline{P}_{\Delta^m}$  and  $P_{\Delta^m}$  are related by the formula:

$$P_{\Delta^m}(z, w) = \underline{P}_{\Delta^m}(z^a w^b, z^c w^d) = \underline{P}_{\Delta^m}(\underline{z}, \underline{w}).$$

The Newton polygon of  $P_{\Delta^m}$  (in the  $(z, w)$  variables) is obtained as the image of that of  $\underline{P}_{\Delta^m}$  (in the  $(\underline{z}, \underline{w})$  variables) by the linear map  $M$ .

We can apply the previous lemma to  $\underline{P}_{\Delta^m}$ , and get that its Newton polygon is included in a rectangle. The Newton polygon of  $P_{\Delta^m}$  is therefore included in the parallelogram, obtained as the image by  $M$  of that rectangle. In particular, it bounds the width of the Newton polygon of  $P_{\Delta^m}$  between two parallel lines with any rational slope, this width being related to the number of edges of the minimal paths with a certain homology.

Of particular interest is the case where  $(\underline{z}, \underline{w}) = (z, w/z)$ , *i.e.*, where  $M = \begin{pmatrix} 1 & -1 \\ 0 & 1 \end{pmatrix}$ . Indeed, the horizontal width of the Newton polygon of the polynomial  $\underline{P}_{\Delta^m}$  is directly related to the degree of  $P_{\Delta^m}$ , computed as the sum of the degrees in  $z$  and  $w$ .

**Corollary 20.** *Let  $\gamma$  be a minimal closed path on  $\mathbf{G}_1$  such that  $[\gamma] = -[\gamma_x] + [\gamma_y]$ , visiting  $p$  vertices of  $\mathbf{G}_1$  (and having  $2p$  edges). Then, the Newton polygon of  $P_{\Delta^m}$  is contained in a band delimited by the straight lines:  $y + x \pm p = 0$ . In particular, the highest (resp. lowest) degree of a monomial of  $P_{\Delta^m}$  is not greater than  $p$  (resp. not less than  $-p$ ).*

### 5.3 The spectral curve and the amoeba of the massive Laplacian

The zero set of the characteristic polynomial  $P_{\Delta^m(k)}$  of the massive Laplacian defines a curve, known as the *spectral curve*, denoted  $\mathcal{C}^k$ :

$$\mathcal{C}^k = \{(z, w) \in \mathbb{C}^2 : P_{\Delta^m(k)}(z, w) = 0\}.$$

In Proposition 21, we show that the spectral curve has geometric genus 1 and in Theorem 25, we prove that it is *Harnack*. In Theorem 26, we prove that every genus 1 Harnack curve with  $(z, w) \leftrightarrow (z^{-1}, w^{-1})$  symmetry is the spectral curve of the massive Laplacian of a periodic

isoradial graph, for a certain value of  $k \in (0, 1)$ . These two points are reminiscent of what has been done in [KO06] for the correspondence between genus 0 Harnack curves and critical dimer spectral curves on isoradial graphs.

The *real locus* of the spectral curve consists of the set of points of  $\mathcal{C}^k$  that are invariant under complex conjugation:

$$\{(z, w) \in \mathcal{C}^k \mid (\bar{z}, \bar{w}) = (z, w)\} = \{(x, y) \in \mathbb{R}^2 \mid P_{\Delta^{m(k)}}(x, y) = 0\},$$

apart from isolated points. The latter are referred to as *solitary nodes* of the curve.

The *amoeba*  $\mathcal{A}^k$  of the curve  $\mathcal{C}^k$  is the image of  $\mathcal{C}^k$  under  $\text{Log} : (z, w) \rightarrow (\log |z|, \log |w|)$ .

General geometric features of the amoeba can be described from the Newton polygon of the characteristic polynomial, see [Vir02, GKZ94] for an overview. It reaches infinity by several *tentacles*, which are images by  $\text{Log}$  of neighborhoods of the curve  $\mathcal{C}^k$  where  $z$  and/or  $w$  is 0 or infinite. Each tentacle (counted with multiplicity) corresponds to a segment between two successive integer points on the boundary of the Newton polygon, and the direction of the asymptote is the outward normal to the segment. The amoeba's complement consists of components between the tentacles, and bounded components. Components of the amoeba's complement are convex. Bounded (resp. unbounded) components correspond to integer points inside (resp. on the boundary of) the Newton polygon. The maximal number of bounded components is thus the number of inner integer points of the Newton polygon. Amoebas are unbounded, but their area is bounded by  $\pi^2$  the area of the Newton polygon.

Using our explicit parametrization of the spectral curve  $\mathcal{C}^k$  allows us to prove properties of the amoeba  $\mathcal{A}^k$ , see Lemmas 23 and 27. We show that its complement has a single bounded component and prove in Proposition 28 that its area is increasing as a function of the elliptic modulus  $k$ .

Figure 11 shows the Newton polygon and the amoeba of the spectral curve of the massive Laplacian of the graph depicted in Figure 9, for  $k^2 = 0.8$ .

### 5.3.1 Explicit parametrization of the spectral curve

For  $u$  in the torus  $\mathbb{T}(k)$ , define

$$\begin{aligned} z(u|k) &= \prod_{e^{i\bar{\alpha}} \in \gamma_x} \left( i\sqrt{k'} \text{sc}(u_{\alpha}) \right) = \prod_{T \text{ train-track in } \mathcal{T}} \left( i\sqrt{k'} \text{sc}(u_{\alpha_T}) \right)^{v_T}, \\ w(u|k) &= \prod_{e^{i\bar{\alpha}} \in \gamma_y} \left( i\sqrt{k'} \text{sc}(u_{\alpha}) \right) = \prod_{T \text{ train-track in } \mathcal{T}} \left( i\sqrt{k'} \text{sc}(u_{\alpha_T}) \right)^{-h_T}, \end{aligned} \quad (32)$$

where  $\alpha_T$  is the angle associated to the oriented train-track  $T$ , and  $[T] = h_T[\gamma_x] + v_T[\gamma_y]$  is its homology class in  $H_1(\mathbf{T}, \mathbb{Z}^2)$ . There are  $2p_x$  (resp.  $2p_y$ ) terms in the product defining  $z(u|k)$  (resp.  $w(u|k)$ ). Note that for every vertex  $x$  of  $\mathbf{G}_1$ , we have  $z(u|k) = \mathbf{e}_{(x, x+(1,0))}(u|k)$

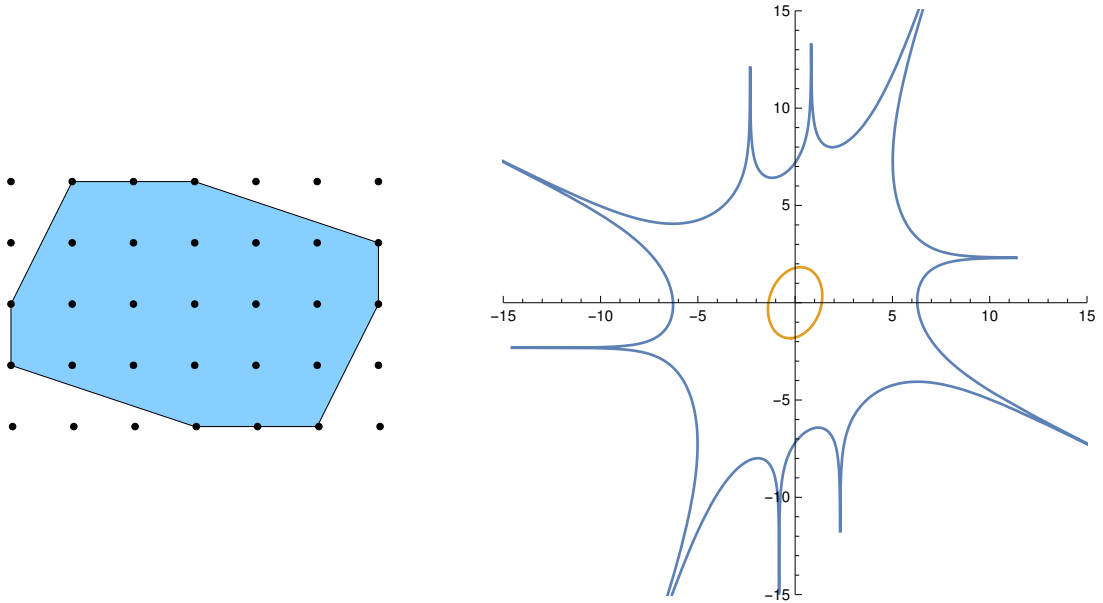

Figure 11: Left: the Newton polygon of the massive Laplacian of the graph pictured in Figure 9. Right: the amoeba  $\mathcal{A}^k$  of its spectral curve  $\mathcal{C}^k$ , when  $k^2 = 0.8$ .

and  $w(u|k) = \mathbf{e}_{(x, x+(0,1))}(u|k)$ . Define  $\psi(\cdot|k)$  to be the map:

$$\begin{aligned} \psi(\cdot|k) : \mathbb{T}(k) &\rightarrow \mathbb{C}^2 \\ u &\mapsto \psi(u|k) = (z(u|k), w(u|k)). \end{aligned}$$

**Proposition 21.** *The map  $\psi$  provides a complete parametrization of the spectral curve  $\mathcal{C}^k$  of the massive Laplacian. In particular,  $\mathcal{C}^k$  is an irreducible curve with geometric genus 1.*

*Proof.* For every  $u \in \mathbb{T}(k)$ , the function  $\mathbf{e}_{(\cdot,y)}(u)$  is massive harmonic by Proposition 11; it is  $(z(u), w(u))$ -quasiperiodic, since for every  $(m, n) \in \mathbb{Z}^2$  and every vertex  $x$  of  $\mathbb{G}_1$ ,

$$\mathbf{e}_{(x+(m,n),y)}(u) = \mathbf{e}_{(x+(m,n),x)}(u) \mathbf{e}_{(x,y)}(u) = z(u)^{-m} w(u)^{-n} \mathbf{e}_{(x,y)}(u). \quad (33)$$

As a consequence, for every  $u$ , the function  $\mathbf{e}_{(\cdot,y)}(u)$  belongs to the kernel of  $\Delta(z(u), w(u))$ , and  $P_{\Delta^m}(z(u), w(u)) = 0$ .

The image of the application  $\psi$  is necessarily an irreducible component of the curve  $\mathcal{C}^k$ , corresponding to the zeros of an irreducible factor  $R$  of  $P_{\Delta^m}$ . But from the definition (32) of  $z(u)$ , we see that it has order  $2p_x$ : it takes the value 0 (and thus any value)  $2p_x$  times. This means for example that the degree of the polynomial  $R(1, w)$  is  $2p_x$ : indeed, if  $u_1, \dots, u_{2p_x}$  are the distinct values of  $u$  for which  $z(u) = 1$ , then  $w(u_1), \dots, w(u_{2p_x})$  are the roots of  $R(1, w)$ . But this degree is not greater than the height of the Newton polygon of  $R$ . Applying the same argument to  $w(u)$ , which has order  $2p_y$ , we get that the smallest rectangle containing the Newton polygon of  $R$  has height (resp. width)  $2p_x$  (resp.  $2p_y$ ). But if  $R$  is not reduced

to a monomial, then the Newton polygon of  $P_{\Delta^m}$  has width strictly larger than the one of  $R$  and doesn't fit in a  $2p_y \times 2p_x$  rectangle, which is in contradiction with Lemma 19. Therefore  $R$  and  $P_{\Delta^m}$  define the same curve in  $\mathbb{C}^2$  and  $\psi$  parametrizes the whole spectral curve.

The application  $\psi$  is a birational map between  $\mathbb{T}(k)$  and the spectral curve  $\mathcal{C}^k$ . The torus  $\mathbb{T}(k)$  is thus the normalization of  $\mathcal{C}^k$ , and these curves have the same geometric genus, equal to 1.  $\square$

The proof of Proposition 21 shows that the bound on the width and height of the Newton polygon obtained in Lemma 19 is tight, and that the extension to other families of closed paths allows one to completely reconstruct the Newton polygon of  $P_{\Delta^{m(k)}}$ , as the intersection of bands contained between lines  $ay - bx \pm p = 0$ .

The explicit parametrization  $\psi$  of the spectral curve  $\mathcal{C}^k$  allows to show that it is *maximal*, meaning that its real locus has the largest possible number of components, given by the geometric genus of the curve plus 1. In our case, it is  $1 + 1 = 2$ .

**Lemma 22.** *The real locus of the spectral curve  $\mathcal{C}^k$  is the image by  $\psi$  of  $\mathbb{R}/4K\mathbb{Z} + \{0, 2iK'\}$ ; it thus has two components, and the spectral curve is maximal. The connected component with ordinate 0 is unbounded; the other one is bounded away from 0 and infinity.*

*Proof.* Since the number of factors in the products defining  $z(u)$  and  $w(u)$  is even, and since  $\text{sc}(\bar{u}) = \overline{\text{sc}(u)}$ , the map  $\psi$  commutes with complex conjugation. As a consequence, the real locus of  $\mathcal{C}^k$  is the image by  $\psi$  of the points of the torus  $\mathbb{T}(k)$  invariant by complex conjugation: this is exactly  $\mathbb{R}/4K\mathbb{Z} + \{0, 2iK'\}$ . The connected component with ordinate 0 is unbounded, since it contains the zeros and poles of  $z(u)$  and  $w(u)$ . On the other one,  $z(u)$  and  $w(u)$  are bounded away from 0 and  $\infty$ .  $\square$

The parametrization  $\psi$  also has consequences on the geometry of the amoeba  $\mathcal{A}^k$ .

**Lemma 23.** *For every train-track  $T$  of  $G_1$ , the amoeba  $\mathcal{A}^k$  has two tentacles, which are symmetric with respect to the origin; their asymptote is orthogonal to the vector of coordinates  $(h_T, v_T)$  of the homology class  $[T]$ . Moreover, every tentacle (counted with multiplicity) arises from a train-track  $T$  of  $G_1$ .*

*Proof.* From the definition of the parametrization  $\psi$ , all the zeroes/poles of  $z(u)$  and  $w(u)$  correspond to parameters of the train-tracks. Let  $T$  be a train-track. Choose an orientation, fixing the parameter  $\alpha_T \in \mathbb{R}/4K\mathbb{Z}$  and the sign of the homology  $(h_T, v_T)$ . When  $u$  is close to  $\alpha_T$ , there are some non-zero constants  $c_1$  and  $c_2$  such that

$$z(u) = c_1(u - \alpha_T)^{-v_T}(1 + o(1)), \quad w(u) = c_2(u - \alpha_T)^{h_T}(1 + o(1)),$$

so that  $\log |z(u)|$  and  $\log |w(u)|$  go to  $\pm\infty$  and

$$h_T \log |z(u)| + v_T \log |w(u)| = h_T \log |c_1| + v_T \log |c_2| + o(1),$$

which means exactly that for  $u$  close to  $\alpha_T$ , the unbounded component of the boundary has an asymptote with a normal  $(h_T, v_T)$ .  $\square$

*Remark 24.* Using Lemma 23 and the duality between the amoeba and the Newton polygon mentioned in the beginning of Section 5.3, we know that the Newton polygon of  $P_{\Delta^{m(k)}}$  is the only convex polygon centered at the origin whose boundary consists of the lattice vectors representing the homology classes of all the oriented train-tracks of the graph  $G_1$ , in cyclic order. In particular, every vector comes with its opposite, corresponding to the same train-track with reverse orientation. For example, the Newton polygon of Figure 11 (right) is obtained from the homology classes of the train-tracks pictured in Figure 9 (top right).

### 5.3.2 Spectral curve of the massive Laplacian and genus 1 Harnack curves

A curve defined as the zero set of a 2-variables complex polynomial with real coefficients, is said to be *Harnack* if it is maximal, and if only one of its real connected components meets the coordinate axes (including the line at infinity), and the intersections with different axes lie on disjoint arcs of that component [Vir02]. We now prove that the spectral curve  $\mathcal{C}^k$  of the massive Laplacian is Harnack and that every symmetric, genus 1 Harnack curve arises in this way.

**Theorem 25.** *The spectral curve  $\mathcal{C}^k$  of the massive Laplacian  $\Delta^{m(k)}$  is a Harnack curve.*

*Proof.* The curve  $\mathcal{C}^k$  is maximal, by Lemma 22. To prove that it is Harnack it suffices to check, by Theorem 10 of [Bru14], that when  $u$  runs through  $\mathbb{R}/4K\mathbb{Z}$ ,  $(z(u), w(u))$  visits the axes in the right order, namely that when  $u$  increases, the slopes of the asymptotes of the tentacles of the amoeba  $\mathcal{A}^k$  are also increasing in the counterclockwise order. But, by Lemma 23, the slope of an asymptote at  $u = \alpha$  is orthogonal to the homology class of a train-track with angle  $\alpha$ . Since the homology classes of the train-tracks and the angles associated to them are in the same cyclic order, the property is thus satisfied.  $\square$

**Theorem 26.** *Every genus 1 Harnack curve with  $(z, w) \leftrightarrow (z^{-1}, w^{-1})$  symmetry arises as the spectral curve of the characteristic polynomial of the massive Laplacian  $\Delta^{m(k)}$  on some periodic isoradial graph for some  $k \in (0, 1)$ .*

*Proof.* Let  $\mathcal{C}$  be a Harnack curve with geometric genus 1 and  $(z, w) \leftrightarrow (z^{-1}, w^{-1})$  symmetry. Since  $\mathcal{C}$  is a genus 1 maximal real curve, it can be parametrized by a torus of pure imaginary modulus [Nat90, p. 59]. This torus, after maybe a dilation, is a  $\mathbb{T}(k)$ , for some  $k \in (0, 1)$ . Let  $\psi$  be the birational map from  $\mathbb{T}(k)$  to  $\mathcal{C}$ . The symmetry  $(z, w) \leftrightarrow (z^{-1}, w^{-1})$  preserves each of the two components of the real locus of  $\mathcal{C}$ , with their orientation. It is thus conjugated by  $\psi$  to a real translation  $u \mapsto u + u_0$  on  $\mathbb{T}(k)$ . But since it is a non-trivial involution, then  $u_0$  is equal to  $2K$ , the horizontal half-period of the torus  $\mathbb{T}(k)$ .

Let us denote by  $\alpha_1, \dots, \alpha_{2\ell}$  the values of  $u \in \mathbb{R}/4K\mathbb{Z}$  corresponding to a pole or a zero of  $z(u)$  or  $w(u)$ , ordered cyclically. For  $j \in \{1, \dots, \ell\}$ , denote by  $a_j$  (resp.  $b_j$ ) the order of  $\alpha_j$  in  $z(u)$  (resp.  $w(u)$ ). Because of the symmetry of the curve, we have  $\alpha_{j+\ell} = \alpha_j$ ,  $a_{j+\ell} = -a_j$ ,  $b_{j+\ell} = -b_j$ . Moreover,  $\sum_{j=1}^{\ell} a_j$  and  $\sum_{j=1}^{\ell} b_j$  are even.

Knowing the zeros and poles of  $z(u)$  is enough to reconstruct the whole function:  $z(u)$  and  $\prod_{j=1}^{\ell} \text{sc}(u - \alpha_j)^{a_j}$  are meromorphic functions on  $\mathbb{T}(k)$  and have the same zeros and poles, with the same multiplicities. Therefore they are equal up to a multiplicative constant. The constant is determined by the symmetry  $z(u + 2K) = z(u)^{-1}$  and the identity (51) for  $\text{sc}$ ; we obtain

$$z(u) = \prod_{i=1}^{\ell} \left( i\sqrt{k'} \text{sc}(u - \alpha_j) \right)^{a_j}.$$

The same argument for  $w(u)$  yields:

$$w(u) = \prod_{i=1}^{\ell} \left( i\sqrt{k'} \text{sc}(u - \alpha_j) \right)^{b_j}.$$

We now want to construct a periodic isoradial graph  $G$  (or equivalently an isoradial graph  $G_1$  on the torus), on which the spectral curve of the massive Laplacian is  $\mathcal{C}$ . First we construct the graph of train-tracks  $G_1^{\diamond*}$ , as explained in Section 5.1, by drawing on the torus for every  $j \in \{1, \dots, \ell\}$  a self-avoiding cycle with homology class  $(b_j, -a_j)$ , such that the total number of intersections is minimal. The arrangement of the train-tracks is not unique, but because of 3-dimensional consistency (Section 3.2), all of them should yield the same result. The graph  $G_1^{\diamond*}$  determines the graph structure of  $G_1$  once we decide which is the primal and the dual graph. Now remains to determine the embedding, *i.e.*, to attribute to every train-track a direction for the common sides of the rhombi on the train-track.

Every value of  $\alpha_j$  corresponds to a tentacle of the amoeba of  $\mathcal{C}$ , with an asymptotic slope given by  $(a_j, b_j)$ . Since the curve  $\mathcal{C}$  is Harnack, the slopes of the tentacles are in the same cyclic order as the  $\alpha_j$ . This implies that if we associate to every oriented train-track  $T_j$  with homology  $(b_j, -a_j)$ , the unit vector  $e^{i\overline{\alpha_j}}$ , we can place a rhombus with the correct orientation at each intersection of two train-tracks, so that we get a proper isoradial embedding of the graph  $G$ . According to Proposition 21, the spectral curve of the massive Laplacian on  $G$  for the value of  $k$  chosen above, is also parametrized by  $u \mapsto (z(u), w(u))$ , and is therefore equal to  $\mathcal{C}$ .  $\square$

### 5.3.3 Consequence of the Harnack property on the amoeba

The spectral curve  $\mathcal{C}^k$  has genus 1 and is Harnack, so the complement of the amoeba in  $\mathbb{R}^2$  has a unique bounded component, denoted by  $D_{\mathcal{A}^k}$ . Since the characteristic polynomial is reciprocal, the amoeba  $\mathcal{A}^k$  is invariant under central symmetry about the origin. Therefore, the component  $D_{\mathcal{A}^k}$  contains the origin, and corresponds to the integer point  $(0, 0)$  of the Newton polygon of the characteristic polynomial  $P_{\Delta^{m(k)}}$ , see Figure 11.

The Harnack property also implies that the boundary of the amoeba coincides with its real locus [MR01]. Combining this with the explicit parametrization of the real locus of the spectral curve proved in Lemma 22 yields the following.

**Lemma 27.** *The outer boundary of the amoeba is the image by  $\text{Log} \circ \psi$  of  $\mathbb{R}/4K\mathbb{Z}$ . The boundary of  $D_{\mathcal{A}^k}$  is the image by  $\text{Log} \circ \psi$  of  $\mathbb{R}/4K\mathbb{Z} + \{0, 2iK'\}$ .*

Since the spectral curve is Harnack, we know by [MR01] that the area of the amoeba  $\mathcal{A}^k$  is  $\pi^2$  times the area of the Newton polygon of  $P_{\Delta^{m(k)}}(z, w)$ . It is thus independent of  $k$  and only depends on the geometry of the isoradial graph. A quantity which does depend on the elliptic modulus  $k$  is the area of the hole  $D_{\mathcal{A}^k}$ . We now prove the following.

**Proposition 28.** *As  $k$  varies from 0 to 1, the area of  $D_{\mathcal{A}^k}$  grows continuously from 0 to  $\infty$ .*

*Proof.* According to Lemma 27, the boundary of  $D_{\mathcal{A}^k}$  is parametrized by  $(\log |z(u)|, \log |w(u)|)$ , for  $u \in [0, 4K] + 2iK'$ .

The area of  $D_{\mathcal{A}^k}$  is computed by integrating the form  $x dy$  along the boundary of  $D_{\mathcal{A}^k}$ :

$$\text{Area}(D_{\mathcal{A}^k}) = \int_0^{4K} \log |z(u + 2iK')| \frac{w'(u + 2iK')}{w(u + 2iK')} du. \quad (34)$$

Using the definition (32) of  $z(u)$  and  $w(u)$ , and the fact that  $\text{sc}(u + iK') = i \text{nd}(u)$  (54), we have

$$\log |z(u + 2iK')| = \sum_{S \text{ train-track} \in \mathcal{T}} v_S \log \{ \sqrt{k'} \text{nd}(u_{\alpha_S}) \}$$

and

$$\frac{w'(u + 2iK')}{w(u + 2iK')} = - \sum_{T \text{ train-track} \in \mathcal{T}} h_T \frac{\text{nd}'(u_{\alpha_T})}{\text{nd}(u_{\alpha_T})} = - \sum_{T \text{ train-track} \in \mathcal{T}} h_T k^2 \frac{\text{sn} \cdot \text{cn}}{\text{dn}}(u_{\alpha_T}).$$

Thus, Equation (34) can be rewritten as

$$\sum_{S, T \in \mathcal{T}} (-k^2 v_S h_T) \int_0^{4K} \log \{ \sqrt{k'} \text{nd}(u_{\alpha_S}) \} \frac{\text{sn} \cdot \text{cn}}{\text{dn}}(u_{\alpha_T}) du.$$

First notice that terms in the sum for which  $S = T$  do not contribute to the sum, by antisymmetry under the change of variable  $v = 2\alpha_T - u$ .

The contribution of the two terms corresponding to the same (unordered) pair of train-tracks  $\{S, T\}$  in the sum is:

$$k^2 (S \wedge T) \int_0^{4K} \log \{ \sqrt{k'} \text{nd}(u_{\alpha_T}) \} \frac{\text{sn} \cdot \text{cn}}{\text{dn}}(u_{\alpha_S}) du,$$

where, by (31),  $S \wedge T = h_S v_T - v_S h_T$ , equals the number of intersections between  $S$  and  $T$ , with a sign  $+$  (resp.  $-$ ) if  $\alpha_T - \alpha_S \in (0, 2K)$  (resp. in  $(-2K, 0)$ ).

Fix  $\alpha$ ,  $\beta$  and  $\theta = \frac{\beta - \alpha}{2}$ , and define

$$I(k) = \int_0^{4K} \log \{ \sqrt{k'} \text{nd}(u_{\alpha}) \} \frac{\text{sn} \cdot \text{cn}}{\text{dn}}(u_{\beta}) du = \frac{2K}{\pi} \int_0^{\pi} \log \left\{ \frac{\text{dn}(\frac{K}{\pi}(-v + 2\bar{\theta}))}{\text{dn}(\frac{K}{\pi}(v + 2\bar{\theta}))} \right\} \frac{\text{sn} \cdot \text{cn}}{\text{dn}}\left(\frac{K}{\pi}v\right) dv.$$

To prove that the area (34) is an increasing function of  $k \in (0, 1)$ , it is sufficient to prove that if  $\bar{\theta} \in (0, \frac{\pi}{2})$ , the integral  $I(k)$  is an increasing function of  $k \in (0, 1)$ .

Using the addition formula for the dn function [AS64, 16.17.3] one can write

$$\frac{\operatorname{dn}\left(\frac{K}{\pi}(-u + 2\bar{\theta})\right)}{\operatorname{dn}\left(\frac{K}{\pi}(u + 2\bar{\theta})\right)} = \frac{1 + k^2 \frac{\operatorname{sn} \cdot \operatorname{cn}}{\operatorname{dn}}\left(\frac{2K\bar{\theta}}{\pi}\right) \frac{\operatorname{sn} \cdot \operatorname{cn}}{\operatorname{dn}}\left(\frac{Ku}{\pi}\right)}{1 - k^2 \frac{\operatorname{sn} \cdot \operatorname{cn}}{\operatorname{dn}}\left(\frac{2K\bar{\theta}}{\pi}\right) \frac{\operatorname{sn} \cdot \operatorname{cn}}{\operatorname{dn}}\left(\frac{Ku}{\pi}\right)}.$$

The function  $X \mapsto \log\left\{\frac{1+X}{1-X}\right\}$  is increasing. Moreover, for a fixed  $v \in [0, \pi]$ , the quantity  $\frac{\operatorname{sn} \cdot \operatorname{cn}}{\operatorname{dn}}\left(\frac{K}{\pi}u|k\right)$  is non-negative and increasing in  $k \in (0, 1)$ , as can be checked by Landen transformation (see (58) in Appendix A) and [Law89, Figure 2.1]. Thus the non-negative functions  $k \mapsto K(k)$ ,  $k \mapsto \frac{\operatorname{sn} \cdot \operatorname{cn}}{\operatorname{dn}}\left(\frac{Ku}{\pi}\right)$  and  $k \mapsto k^2 \frac{\operatorname{sn} \cdot \operatorname{cn}}{\operatorname{dn}}\left(\frac{Ku}{\pi}\right) \frac{\operatorname{sn} \cdot \operatorname{cn}}{\operatorname{dn}}\left(\frac{2K\bar{\theta}}{\pi}\right)$ , are also increasing functions of  $k$ . Thus, so is  $I$ .

The limits of the area when  $k \rightarrow 0$  and  $k \rightarrow 1$  are obtained by noticing that  $I(0) = 0$  since the integrand is zero (we recall that  $\operatorname{dn}(\cdot|0) = 1$ ). Moreover, we have just proved that  $I(k)/K(k)$  is positive and increasing on  $(0, 1)$ . Since  $K(k)$  goes to infinity, when  $k \rightarrow 1$ , so does  $I(k)$ .  $\square$

## 5.4 Further properties

Since the spectral curve  $\mathcal{C}^k$  has geometric genus 1, the space of holomorphic differential 1-forms on  $\mathcal{C}^k$  has dimension 1. It turns out that we can explicitly compute one of these forms from the matrix  $\Delta^{m(k)}(z, w)$ . Before doing this, we need two lemmas about the dimension of the kernel of the matrix  $\Delta^{m(k)}(z, w)$  and the structure of the adjugate matrix, denoted  $Q^k(z, w)$ .

**Lemma 29.** *For every  $(z, w) \in \mathcal{C}^k$ , the dimension of the kernel of the matrix  $\Delta^{m(k)}(z, w)$  is:*

$$\dim[\ker \Delta^{m(k)}(z(u), w(u))] \begin{cases} = 1 & \text{if } (z, w) \text{ is a simple point of } \mathcal{C}^k, \\ \geq 2 & \text{if } (z, w) \text{ is a solitary node of } \mathcal{C}^k. \end{cases}$$

Moreover, when  $(z, w)$  is a simple point, every  $(z, w)$ -quasiperiodic massive harmonic function is proportional to  $\mathbf{e}_{(\cdot, x_0)}(u)$ , where  $u \in \mathbb{T}(k)$  is such that  $(z(u), w(u)) = (z, w)$ .

*Proof.* Let  $u \in \mathbb{T}(k)$ . We have seen in the proof of Proposition 21 that the function  $\mathbf{e}_{(\cdot, x_0)}(u)$  is a non-zero  $(z(u), w(u))$ -quasiperiodic and massive harmonic function. Therefore, it is in the kernel of  $\Delta^m(z(u), w(u))$ .

Suppose that  $(z, w)$  is a simple point of  $\mathcal{C}$ . The fact that the kernel of  $P_{\Delta^m}(z, w)$  has dimension 1 for a simple point  $(z, w)$  follows from [CT79]. Let us quickly recall the argument here. The following identity holds for every  $z'$  and  $w'$ :

$$Q(z', w')\Delta^m(z', w') = P_{\Delta^m}(z', w') \cdot \operatorname{Id}. \quad (35)$$



Since the point  $(z, w)$  is simple,  $(\frac{\partial P}{\partial z}(z, w), \frac{\partial P}{\partial w}(z, w)) \neq (0, 0)$ . Suppose we have  $\frac{\partial P}{\partial z}(z, w) \neq 0$ . Differentiating (35) with respect to  $z'$ , and evaluating at  $(z', w') = (z, w)$ , we get:

$$\frac{\partial Q(z, w)}{\partial z} \Delta^m(z, w) + Q(z, w) \frac{\partial \Delta^m(z, w)}{\partial z} = \frac{\partial P_{\Delta^m}(z, w)}{\partial z} \text{Id.}$$

If  $\ker \Delta^m(z, w)$  had dimension strictly greater than 1, the matrix  $Q(z, w)$  would be identically zero. But  $\frac{\partial Q(z, w)}{\partial z} \Delta^m(z, w)$  cannot be equal to a non-zero multiple of the identity, because  $(z, w)$  is on the curve  $\mathcal{C}^k$  and thus  $\Delta^m(z, w)$  is non-invertible. Therefore  $\dim \ker \Delta^m(z, w) = 1$ , and if  $u \in \mathbb{T}(k)$  is such that  $(z(u), w(u)) = (z, w)$ , then by the remark above, the function  $e_{(\cdot, x_0)}(u)$  spans the kernel of  $\Delta^m(z, w)$ .

Suppose now that  $(z, w)$  is a solitary node of the curve. This point has two<sup>2</sup> distinct conjugated preimages  $u \neq \bar{u}$  by  $\psi$  on  $\mathbb{T}(k)$ . The two functions  $\exp_{(\cdot, x_0)}(u)$  and  $\exp_{(\cdot, x_0)}(\bar{u})$  are in the kernel of  $\Delta^m(z, w)$ , but are not proportional. The kernel of  $\Delta^m(z, w)$  is thus at least two-dimensional.  $\square$

**Lemma 30.** *There exists a meromorphic function  $g^k$  on  $\mathbb{T}(k)$  such that:*

$$\forall u \in \mathbb{T}(k), \forall x, y \text{ vertices of } \mathbf{G}_1, \quad Q_{x,y}^k(z(u), w(u)) = g^k(u) e_{(x,y)}(u).$$

*In particular,  $g^k(u)$  is the diagonal coefficient  $Q_{x,x}^k(u)$  for every vertex  $x$  of  $\mathbf{G}_1$ . When  $u$  is such that  $(z(u), w(u))$  is a solitary node, we have  $g^k(u) = 0$ .*

*Proof.* Let  $u \in \mathbb{T}(k)$ . Suppose that  $(z(u), w(u))$  is not a solitary node of  $\mathcal{C}^k$ . Then, by Lemma 29,  $\dim \ker \Delta^m(z(u), w(u)) = 1$ , implying that  $Q(z(u), w(u))$  has rank 1, and can be written

$$Q(z(u), w(u)) = V \cdot W^T,$$

with  $V \in \ker \Delta^m(z(u), w(u))$  and  $W \in \text{coker } \Delta^m(z(u), w(u)) = \ker \Delta(z(u)^{-1}, w(u)^{-1}) = \ker \Delta^m(z(u+2K), w(u+2K))$ . So  $V$  and  $W$  are (non-zero) multiples of  $e_{(\cdot, x_0)}(u)$  and  $e_{(\cdot, x_0)}(u+2K) = e_{(x_0, \cdot)}(u)$  respectively. Therefore there exists a non-zero coefficient  $g(u)$  such that for any vertices  $x$  and  $y$  of  $\mathbf{G}_1$ ,

$$Q_{x,y}(z(u), w(u)) = V_x W_y = g(u) e_{(x, x_0)}(u) e_{(x_0, y)}(u) = g(u) e_{(x, y)}(u).$$

For  $x = y$ , we get  $g(u) = Q_{x,x}(z(u), w(u))$ , which is meromorphic as the composition of a polynomial with meromorphic functions. In particular,  $Q_{x,x}(z(u), w(u))$  does not depend on  $x$ . If  $u$  corresponds to a solitary node,  $Q(z(u), w(u))$  vanishes because the kernel of  $\dim \ker \Delta^m(z, w) \geq 2$ . Therefore,  $g$  extends analytically to  $u$ , and  $g(u) = 0$ .  $\square$

Since the spectral curve has geometric genus 1, the space of holomorphic differential 1-forms on  $\mathcal{C}^k$  has dimension 1. The next proposition states that we can explicitly compute one of these forms using the matrices  $\Delta^{m(k)}(z, w)$  and  $Q^k(z, w)$ . Any other holomorphic 1-form is a multiple of this one.

---

<sup>2</sup>Since the spectral curve is Harnack,  $u$  and  $\bar{u}$  are the only two points of  $\mathbb{T}(k)$  giving the value  $(z, w)$ .

**Proposition 31.** *The differential form  $\frac{Q_{x,x}^k(z,w)}{\frac{\partial P_{\Delta^m(k)}}{\partial w}(z,w)zw} dz$  is a holomorphic 1-form on  $\mathcal{C}^k$ .*

*Proof.* According to classical theory of algebraic curves [ACGH85], all holomorphic differential forms on  $\mathcal{C}^k$  are of the form

$$\frac{R(z,w)}{\frac{\partial P_{\Delta^m(k)}}{\partial w}(z,w)} dz,$$

with  $R$  a polynomial of degree not greater than  $\deg P_{\Delta^m} - 3$  and vanishing on solitary nodes of the curve  $\mathcal{C}^k$ .

Let us prove that the polynomial  $R(z,w) = Q_{x,x}(z,w)/zw$  satisfies these two properties. The fact that  $R$  vanishes on nodes is a consequence of Lemma 30.

To control the degree of  $Q_{x,x}$ , we apply the argument of the proof of Lemma 19 to  $Q_{x,x}$ , for paths  $(\gamma_x, \gamma)$  as in Corollary 20. Recall that  $Q_{x,x}(z,w)$  is computed as the determinant of the matrix  $\Delta^m(z,w)$  from which the row and the column indexed by  $x$  are removed, and recall that any choice for the vertex  $x$  yields the same result. If  $x$  is a vertex of  $\mathbf{G}_1$  visited by  $\gamma$ , then the degree counting argument in the variable  $z$  (along  $\gamma$ ) in the expansion of the determinant of the minor of  $\Delta^m(z,w)$  shows that the maximal degree of  $Q_{x,x}(z,w)$  is strictly less than that of  $P_{\Delta^m}(z,w)$ . When dividing by  $zw$ , we get a polynomial of degree not higher than  $\deg P_{\Delta^m} - 3$ .  $\square$

## 5.5 Green function on periodic isoradial graphs

When the graph  $\mathbf{G}$  is periodic, the massive Green function  $G^m$  can be expressed as a double integral involving the Fourier transform. Indeed, the matrix  $\Delta^m(z,w)$  is invertible for generic values of  $z$  and  $w$ , and the Green function is obtained as Fourier coefficients of  $\Delta^m(z,w)^{-1}$ : if  $x$  and  $y$  are two vertices of  $\mathbf{G}_1$  and  $(m,n) \in \mathbb{Z}^2$ ,

$$\begin{aligned} G^m(x + (m,n), y) &= \iint_{|z|=|w|=1} z^{-m} w^{-n} (\Delta^m(z,w)^{-1})_{x,y} \frac{dz}{2i\pi z} \frac{dw}{2i\pi w} \\ &= \iint_{|z|=|w|=1} z^{-m} w^{-n} \frac{Q_{x,y}(z,w)}{P_{\Delta^m}(z,w)} \frac{dz}{2i\pi z} \frac{dw}{2i\pi w}. \end{aligned} \quad (36)$$

In Section 5.5.1, we give an alternative proof of the local formula (18) of Theorem 12 for the massive Green function  $G^m(x,y)$ , starting from the double integral formula of Equation (36).

In Section 5.5.2, we explain how to recover asymptotics of the Green function of Theorem 14 from the double integral formula of Equation (36), using the approach of [PW13]. This yields a geometric interpretation of the exponential rate of decay in terms of the amoeba  $\mathcal{A}^k$ .

### 5.5.1 Recovering the local formula for the massive Green function

We now give an alternative proof of the local formula (18) for the massive Green function, starting from the double integral formula (36). We can assume that  $x + (m, n)$  is “below” the vertex  $y$ , *i.e.*, that  $n \leq -1$ , after maybe having to change the boundary of the fundamental domain, and exchanging the axes and their directions.

We first transform the integral (36) defining  $G^m(x + (m, n), y)$ , by computing at fixed  $z$  the integral over  $w$  by residues. For a generic value of  $z$  on the unit circle  $\mathbb{S}^1$ , the function  $P_{\Delta^m}(z, \cdot)$  has  $2d_x$  distinct non-zero roots, which all have modulus different from 1, because  $(0, 0)$  is not in the amoeba of  $\mathcal{C}^k$ . Since  $P_{\Delta^m}$  is reciprocal, if  $w(z)$  is a root, then  $\overline{w(z)}^{-1}$  is also a root, meaning that  $d_x$  of them are inside the unit disk:  $w_1(z), \dots, w_{d_x}(z)$ , and  $d_x$  of them outside:  $w_{d_x+1}(z), \dots, w_{2d_x}(z)$ . Since  $n \leq -1$ , there is no pole at 0, and by application of the residue theorem,

$$\int_{|w|=1} \frac{Q_{x,y}(z, w)}{P_{\Delta^m}(z, w)} w^{-n-1} \frac{dw}{2i\pi} = \sum_{i=1}^{d_x} \frac{Q_{x,y}(z, w_i(z))}{\frac{\partial P_{\Delta^m}(z, w)}{\partial w}(z, w_i(z))} w_i(z)^{-n-1}.$$

In the remaining integral over  $z$  of Equation (36), we perform the change of variable from  $z$  to  $u \in \mathbb{T}(k)$ . There are on the spectral curve  $\mathcal{C}^k$  two disjoint simple paths on which the first coordinate  $z$  is in the unit circle. They project onto the amoeba to two vertical segments obtained as the intersection of the amoeba and the vertical axis  $x = 0$ , one of the two segments is below the horizontal axis, the other one is above. The preimage by  $\psi : u \mapsto (z(u), w(u))$  of those two segments are two “vertical” loops on  $\mathbb{T}(k)$ , denoted by  $\Gamma$  and  $\Gamma'$ , respectively. The loops  $\Gamma$  and  $\Gamma'$  are assumed to be oriented in such a way that when  $u$  moves in the positive direction,  $z(u)$  winds counterclockwise around the unit circle. The map  $u \in \Gamma \mapsto z(u) \in \mathbb{S}^1$  has degree  $d_x$ : along  $\Gamma$ , there are exactly  $d_x$  values of  $u$  such that  $z(u) = z$ , the corresponding value of  $w(u)$  being equal to one of the  $w_i(z)$ ,  $i \in \{1, \dots, d_x\}$ . We can therefore rewrite

$$\int_{|z|=1} \sum_{i=1}^{d_x} f(z, w_i(z)) dz = \oint_{u \in \Gamma} f(z(u), w(u)) z'(u) du,$$

for any measurable function  $f$ . In particular, for  $f(z, w) = z^{-m-1} w^{-n-1} \frac{Q_{x,y}(z, w)}{\frac{\partial P_{\Delta^m}(z, w)}{\partial w}}$ , one gets the following expression for the massive Green function:

$$G^m(x + (m, n), y) = \oint_{u \in \Gamma} z(u)^{-m} w(u)^{-n} \frac{Q_{x,y}(z(u), w(u))}{z(u) w(u) \frac{\partial P_{\Delta^m}(z(u), w(u))}{\partial w}} z'(u) \frac{du}{2i\pi}.$$

But according to Lemma 30 and Equation (33),

$$z(u)^{-m} w(u)^{-n} Q_{x,y}(z(u), w(u)) = \mathbf{e}_{(x+(m,n),y)}(u) g(u),$$

and the differential form

$$\frac{g(u)}{z(u) w(u) \frac{\partial P_{\Delta^m}(z(u), w(u))}{\partial w}} z'(u) du$$

is the pullback by the biholomorphic map  $\psi$  of the holomorphic 1-form defined in Lemma 31. Therefore it is a holomorphic form on  $\mathbb{T}(k)$ , and as such, equal to  $du$ , up to a multiplicative constant  $A$  to be determined by other means:

$$G^m(x + (m, n), y) = A \times \oint_{\Gamma} e_{(x+(m,n),y)}(u) du.$$

One then checks that the position of the contour  $\Gamma$  with respect to the poles of the exponential function is indeed the one described in Theorem 12. In order to determine the numerical value of the constant  $A$ , one needs to compute the Laplacian of the Green function  $G^m(\cdot, y)$  at the vertex  $y$ , as in the proof of Theorem 12.

### 5.5.2 Recovering asymptotics of the massive Green function

Let  $x$  and  $y$  be two vertices of the fundamental domain  $G_1$ , and let  $(m, n) \in \mathbb{Z}^2$ . We now explain how to recover the asymptotics formula of Theorem 14. In the periodic case, we can let the vertex  $x+(m, n)$  tend to infinity with an asymptotic direction: for  $\mathbf{r} = (m, n) \in \mathbb{Z}^2 \setminus \{0, 0\}$ , denote by  $\hat{\mathbf{r}}$  the unit vector in the direction of  $\mathbf{r}$ , and  $|\mathbf{r}|$  its norm. The asymptotic regime we consider corresponds to  $|\mathbf{r}| \rightarrow \infty$  and  $\hat{\mathbf{r}} \rightarrow \hat{\mathbf{r}}^*$ , where  $\hat{\mathbf{r}}^*$  is a fixed direction.

The double integral formula (36) is the coefficient  $a_{\mathbf{r}} = a_{m,n}$  of  $z^m w^n$  in the (multivariate) series expansion of the rational fraction  $\frac{Q_{x,y}}{P_{\Delta}^m}$  in a neighborhood of  $|z| = |w| = 1$ , and the domain of convergence of this expansion is exactly the set

$$\text{Log}^{-1}(D_{\mathcal{A}^k}) = \{(z, w) : (\log |z|, \log |w|) \in D_{\mathcal{A}^k}\}.$$

In particular, the general term  $a_{m,n} z^m w^n$  should go to zero for  $\text{Log}(z, w) \in D_{\mathcal{A}^k}$ , and should be unbounded if  $\text{Log}(z, w)$  is in the interior of the amoeba.

Define the exponential rate of the series coefficients  $(a_{\mathbf{r}})$  in the direction  $\hat{\mathbf{r}}_*$  as in [PW13]:

$$\bar{\beta}(\hat{\mathbf{r}}_*) = \inf_{\mathcal{N}} \limsup_{\substack{\mathbf{r} \rightarrow \infty, \\ \hat{\mathbf{r}} \in \mathcal{N}}} |\mathbf{r}|^{-1} \log |a_{\mathbf{r}}|,$$

where  $\mathcal{N}$  varies over a system of open neighborhoods of  $\hat{\mathbf{r}}_*$  whose intersection is the singleton  $\{\hat{\mathbf{r}}_*\}$ . Then, for every  $\hat{\mathbf{r}}$ ,  $\bar{\beta}(\hat{\mathbf{r}}) = \inf\{-\hat{\mathbf{r}} \cdot \mathbf{s} : \mathbf{s} \in D_{\mathcal{A}^k}\}$ , see [PW13, Chapter 8]. The compact oval  $D_{\mathcal{A}^k}$  is strictly convex, because the spectral curve is Harnack. So the infimum is obtained at a single point on the boundary of the amoeba, corresponding to a unique value of the parameter  $u_0 + 2iK' \in 2iK' + \mathbb{R}/4\mathbb{Z}$ . This gives, in the periodic case, a geometric interpretation of the parameter  $u_0$  in Theorem 14 in terms of the spectral curve.

Using a little further the formalism developed by Pemantle and Wilson [PW13, Chapter 9], one can recover in the periodic case the precise asymptotics we obtain in Theorem 14 in the general quasicrystalline setting, with the exact prefactor.

## 6 Random rooted spanning forests on isoradial graphs

In this section we study random rooted spanning forests on isoradial graphs. In Section 6.1 we define the statistical mechanics model of rooted spanning forests. Then, in Section 6.2 we prove an explicit, local expression for an infinite volume Boltzmann measure involving the Green function of Theorem 12. In Section 6.3 we show an explicit, *local* expression for the free energy of the model; we also show a second order phase transition at  $k = 0$  in the rooted spanning forest model. At  $k = 0$ , one recovers the Laplacian considered in [Ken02], and we thus provide a proof that the corresponding spanning tree model is critical. In Section 6.4 we prove that our one-parameter family of massive Laplacian defines a one-parameter family of  $Z$ -invariant spanning forest models.

### 6.1 Rooted spanning forest model and related spanning trees

Let  $G = (V, E)$  be a (not necessarily isoradial) graph. A *tree* of  $G$  is a connected subgraph of  $G$  containing no cycle. A *rooted tree* is a tree with a distinguished vertex, known as the *root*. The root of a generic tree  $T$  is denoted  $x_T$ . A *spanning tree* is a tree spanning all vertices of the graph.

A *rooted spanning forest* of  $G$  is a subgraph of  $G$ , spanning all vertices of the graph, such that every connected component is a rooted tree. Let  $\mathcal{F}(G)$  denote the set of rooted spanning forests of the graph  $G$ .

Assume that edges of the graph  $G$  are assigned positive *conductances*  $(\rho(e))_{e \in E}$  and that vertices are assigned positive *masses*  $(m^2(x))_{x \in V}$ . This is equivalent to defining a massive Laplacian  $\Delta^m$  on  $G$ , through Equation (10).

Suppose now that  $G$  is a finite. Then we can define a model of statistical mechanics, by constructing the *rooted spanning forest Boltzmann probability measure*, denoted  $\mathbb{P}_{\text{forest}}$ , defined by:

$$\forall F \in \mathcal{F}(G), \quad \mathbb{P}_{\text{forest}}(F) = \frac{1}{Z_{\text{forest}}(G, \rho, m)} \prod_{T \in F} \left( m^2(x_T) \prod_{e \in T} \rho(e) \right),$$

where the normalizing constant  $Z_{\text{forest}}(G, \rho, m) = \sum_{F \in \mathcal{F}(G)} \prod_{T \in F} \left( m^2(x_T) \prod_{e \in T} \rho(e) \right)$  is the *rooted spanning forest partition function*.

There is a direct and useful bijection between weighted rooted spanning forests of  $G$  and weighted spanning trees of the graph  $G^r$ , obtained from  $G$  by adding a vertex  $r$ , and by joining every vertex of  $G$  to  $r$ . Given a spanning tree of  $G^r$ , removing every edge connecting a vertex of  $G$  to the vertex  $r$ , and replacing it by a root, yields a rooted spanning forest of  $G$ . This bijection is weight preserving if edges of  $G^r$  have conductances  $\rho^m$  defined by:

$$\rho^m(e) = \begin{cases} \rho(e) & \text{if } e \text{ is an edge of the graph } G, \\ m^2(x) & \text{if } e = xr \text{ is an edge of } G^r \setminus G \text{ connecting the vertex } x \text{ to } r. \end{cases} \quad (37)$$

Let  $\mathcal{T}(\mathbf{G}^r)$  denote the set of spanning trees of the graph  $\mathbf{G}^r$ . The *spanning tree Boltzmann probability measure* on  $\mathbf{G}^r$ , denoted  $\mathbb{P}_{\text{tree}}$ , is defined by:

$$\forall \mathbb{T} \in \mathcal{T}(\mathbf{G}^r), \quad \mathbb{P}_{\text{tree}}(\mathbb{T}) = \frac{1}{Z_{\text{tree}}(\mathbf{G}^r, \rho^m)} \prod_{e \in \mathbb{T}} \rho^m(e),$$

where  $Z_{\text{tree}}(\mathbf{G}^r, \rho^m) = \sum_{\mathbb{T} \in \mathcal{T}(\mathbf{G}^r)} \prod_{e \in \mathbb{T}} \rho^m(e)$  is the *spanning tree partition function*.  $\mathbb{P}_{\text{tree}}$  is the image measure of  $\mathbb{P}_{\text{forest}}$  by the bijection above.

From the above bijection, we know that  $Z_{\text{forest}}(\mathbf{G}, \rho, m) = Z_{\text{tree}}(\mathbf{G}^r, \rho^m)$ , and also that  $\mathbb{P}_{\text{tree}}$  and  $\mathbb{P}_{\text{forest}}$  are transported one into the other by the bijection.

By Kirchhoff's matrix-tree theorem [Kir47], there is an explicit expression of the spanning tree partition function as a determinant, and by the work of Burton and Pemantle [BP93] (see also [BLPS01]), under  $\mathbb{P}_{\text{tree}}$  the edges of the random spanning tree on  $\mathbf{G}^r$  form a determinantal process. Restating these results from the point of view of spanning forests on  $\mathbf{G}$  yields:

**Theorem 32** (Matrix-Forest Theorem [Kir47]). *The rooted spanning forest partition function of the graph  $\mathbf{G}$  is equal to:*

$$Z_{\text{forest}}(\mathbf{G}, \rho, m) = \det(\Delta^m).$$

With the same notation as before, we let  $G^m$  be the massive Green function on  $\mathbf{G}$ , *i.e.*, the inverse of the massive Laplacian  $\Delta^m$ . Fix an arbitrary orientation of the edges of  $\mathbf{G}$ , so that every edge  $e = (e_-, e_+)$  is now oriented from one of its ends  $e_-$  to the other one  $e_+$ .

**Theorem 33** (Transfer Impedance Theorem [BP93]). *For any distinct edges  $e_1, \dots, e_j$  and vertices  $x_1, \dots, x_k$  of  $\mathbf{G}$ , the probability that these edges belong to a random rooted spanning forest and that these vertices are roots, is:*

$$\mathbb{P}_{\text{forest}}(\{e_1, \dots, e_k, x_1, \dots, x_j\}) = \det \left( \begin{array}{c|c} (\mathbf{H}^k(e_i, e_\ell))_{1 \leq i, \ell \leq j} & (\mathbf{H}^k(e_i, x_\ell))_{1 \leq i \leq j, 1 \leq \ell \leq k} \\ \hline (\mathbf{H}^k(x_i, e_\ell))_{1 \leq i \leq k, 1 \leq \ell \leq j} & (\mathbf{H}^k(x_i, x_\ell))_{1 \leq i, \ell \leq k} \end{array} \right),$$

where

$$\begin{aligned} \mathbf{H}(e, e') &= \rho(e')(G^m(e_-, e'_-) - G^m(e_+, e'_-) - G^m(e_-, e'_+) + G^m(e_+, e'_+)), \\ \mathbf{H}(e, x) &= m^2(x)(G^m(e_-, x) - G^m(e_+, x)), \\ \mathbf{H}(x, e) &= \rho(e')(G^m(x, e_-) - G^m(x, e_+)), \\ \mathbf{H}(x, x') &= m^2(x')G^m(x, x'). \end{aligned}$$

The quantity  $\mathbf{H}(e, e')$  is the *transfer impedance* through  $e'$ , with a source at the end points of  $e$ . We extend the name *transfer impedance* to the whole of  $\mathbf{H}$ , even when arguments are possibly not edges, but vertices.

The derivation of Theorems 32 and 33 from their classical versions is detailed in Appendix D.3.

## 6.2 Infinite volume measure

From now on, suppose that  $G$  is an infinite isoradial graph, whose faces are covering the whole plane, with conductances  $\rho$  and masses  $m^2$  of Equations (11) and (12), for some  $k \in (0, 1)$ . In the next theorem, we prove that the natural infinite volume Gibbs measure on the set  $\mathcal{F}(G)$  of all rooted spanning forests of  $G$  is expressed using the impedance transfer matrix  $H^k$  involving the Green function  $G^{m(k)}$  on  $G$  of Theorem 12.

**Theorem 34.** *Let  $k \in (0, 1)$ . There exists a unique measure  $\mathbb{P}_{\text{forest}}^k$  on rooted spanning forests of  $G$  such that for any distinct edges  $e_1, \dots, e_j$ , and any distinct vertices  $x_1, \dots, x_k$  of  $G$ :*

$$\mathbb{P}_{\text{forest}}^k(\{e_1, \dots, e_j, x_1, \dots, x_k\}) = \det \left( \begin{array}{c|c} (H^k(e_i, e_\ell)) & (H^k(e_i, x_\ell)) \\ \hline (H^k(x_i, e_\ell)) & (H^k(x_i, x_\ell)) \end{array} \right)$$

where  $H^k$  is the transfer impedance on  $G$ .

The measure  $\mathbb{P}_{\text{forest}}^k$  is the weak limit of the sequence  $(\mathbb{P}_{\text{forest}}^{k,(n)})$  on rooted spanning forests of any exhaustion  $(G_n)_{n \geq 1}$  of  $G$  by finite graphs. Under  $\mathbb{P}_{\text{forest}}^k$ , the connected components of the random rooted spanning forests are finite almost surely.

*Proof.* Let  $(G_n)_{n \geq 1}$  be an exhaustion of  $G$  by finite graphs. By Theorem 33, the determinantal process on edges of  $G_n$  with kernel given by the transfer impedance matrix on  $G_n$  is a probability measure on rooted spanning forests of  $G_n$ . Moreover, by Lemma 50 of Appendix D.4, the sequence of Green functions on  $G_n$  converges pointwise to the Green function  $G^m$  of  $G$ . Therefore  $H^k$  is the limit of the sequence of transfer impedance matrices on  $G_n$ .

The convergence of the kernel of a determinantal process implies the convergence of the finite dimensional laws, which are consistent, as limits of probability measures. By Kolmogorov's extension theorem, there exists a probability measure  $\mathbb{P}_{\text{forest}}^k$  on the set of edges  $G$ , which has those finite dimensional marginals. Moreover, this measure is unique, since  $G$  has countably many edges.

The random spanning forest on  $G_n$  can be sampled by Wilson's algorithm, by creating the branches from the loop erasure of killed random walks, with transition probabilities naturally defined from the conductances and masses, see Section D.3. Since  $(G_n)$  is an exhaustion of  $G$ , we can take the limit in the loop erasure procedure and also sample the random configuration from the Gibbs measure on  $G$  by Wilson's algorithm on  $G$  with the killed random walk  $(X_j)_{j \geq 0}$  defined in Section D.4, in the same manner as it is done in [BLPS01, Theorem 5.1] to construct the wired uniform spanning forests on infinite graphs.

We now show that the support is the set of rooted spanning forests with finite size components. From the convergence of finite dimensional marginals, it is clear that the limiting objects are rooted spanning forests. But what could happen is that as  $n$  goes to infinity, some tree components on  $G_n$  grow infinite, and the root of these components either stay at finite distance, or are sent to infinity (and thus disappear). To prove the statement about the support of  $\mathbb{P}_{\text{forest}}^k$ , one has to rule out the presence with positive probability of an infinite component in  $G$ , with or without a root.

Fix a vertex  $x_0$ . For every  $\ell \geq 1$ , define  $S_\ell$  to be the set of vertices of  $\mathbf{G}$  at distance  $2\ell$  from  $x_0$ . If there is in the random rooted spanning forest an infinite component  $T$ , then  $T$  has to intersect infinitely many  $S_\ell$  (in fact all except maybe a finite number of them). The root of  $T$  is either at infinity, or at finite distance from  $x_0$ . There is thus an infinite number of  $\ell$  for which there exists a vertex  $x_\ell \in S_\ell \cap T \subset S_\ell$  at distance at least  $\ell$  of the root of  $T$ . However, from Wilson's algorithm, the path from  $x_\ell$  to its root is the loop erasure of the killed random walk  $(X_j)_{j \geq 0}$  starting from  $x_\ell$ . The distance to the root is thus not larger than the length of the trajectory of the random walk starting from  $x_\ell$  before being absorbed. Since the random walk has a probability of being absorbed at each vertex which is uniformly bounded from below by a positive quantity, the length is dominated by a geometric variable. The probability that it is greater than  $\ell$  is thus exponential small in  $\ell$ . Since there are  $O(\ell)$  vertices on  $S_\ell$ , by Borel-Cantelli's lemma, we see that the probability that the infinite sequence  $(x_\ell)$  exists is zero. In other words, with probability 1, there is no infinite component.  $\square$

*Remark 35.* By Remark 13, when  $k$  goes to 0, the impedance transfer matrix  $\mathbf{H}^k$  converges to the impedance transfer matrix defined from Kenyon's critical Green function [Ken02], which is the kernel of the determinantal process on edges corresponding to the spanning tree measure  $\mathbb{P}_{\text{tree}} = \mathbb{P}_{\text{forest}}^0$  with conductances  $(\tan(\theta_e))_{e \in \mathbf{E}}$ . Therefore, as  $k \rightarrow 0$ , the measure  $\mathbb{P}_{\text{forest}}^k$  on spanning forests converges weakly to the measure  $\mathbb{P}_{\text{tree}}$ .

Using the computations for the Green function of Equations (20) and (21), we can write down the probability under  $\mathbb{P}_{\text{forest}}^k$  of a single edge  $e = xy$  to be in the random rooted spanning forest

$$\begin{aligned} \mathbb{P}_{\text{forest}}^k(\{e\}) &= \text{sc}(\theta_e)(G^m(x, x) + G^m(y, y) - 2G^m(x, y)) \\ &= \frac{2 \text{sc}(\theta_e) K'}{\pi} (k' - \text{dn}(\theta_e)) + 2H(2\theta_e), \end{aligned} \quad (38)$$

and that of a vertex  $x$  to be a root:

$$\mathbb{P}_{\text{forest}}^k(\{x\}) = m^2(x)G^m(x, x) = \frac{m^2(x)K'k'}{\pi}. \quad (39)$$

### 6.3 Free energy of rooted spanning forests on periodic isoradial graphs

Suppose that the isoradial graph  $\mathbf{G}$  is  $\mathbb{Z}^2$ -periodic and let  $(\mathbf{G}_n)_{n \geq 1}$  be the natural exhaustion by toroidal graphs:  $\mathbf{G}_n = (\mathbf{V}_n, \mathbf{E}_n) := \mathbf{G}/n\mathbb{Z}^2$ . Since conductances and masses only depend on the elliptic modulus  $k$ , we denote by  $Z_{\text{forest}}^k(\mathbf{G}_n)$  the partition function of rooted spanning forests of  $\mathbf{G}_n$ .

Define the *free energy of rooted spanning forests*, denoted by  $F_{\text{forest}}^k$ , to be minus the exponential growth rate of the rooted spanning forest partition functions of the graphs  $\mathbf{G}_n$ .

$$F_{\text{forest}}^k = - \lim_{n \rightarrow \infty} \frac{1}{n^2} \log Z_{\text{forest}}^k(\mathbf{G}_n).$$

Then, we obtain the following result.



**Theorem 36.** *For every  $k \in (0, 1)$ , the free energy of the rooted spanning forest model on  $\mathbf{G}$  admits the following formula in terms of the angles of the isoradial embedding:*

$$\begin{aligned} F_{\text{forest}}^k &= -|\mathbf{V}_1| \int_0^K 4H'(2\theta) \log \text{sc}(\theta) d\theta - \sum_{e \in \mathbf{E}_1} \int_0^{\theta_e} \frac{2H(2\theta) \text{sc}'(\theta)}{\text{sc}(\theta)} d\theta \\ &= -|\mathbf{V}_1| \int_0^K 4H'(2\theta) \log \text{sc}(\theta) d\theta + \sum_{e \in \mathbf{E}_1} \left( -2H(2\theta_e) \log \text{sc}(\theta_e) + \int_0^{\theta_e} 4H'(2\theta) \log \text{sc}(\theta) d\theta \right), \end{aligned} \quad (40)$$

where  $H$  is the function defined in Equation (9).

*Proof.* For every  $n \geq 1$ , let  $\Delta_n^m$  be the massive Laplacian matrix of the graph  $\mathbf{G}_n$ .

Using symmetries of the graph  $\mathbf{G}_n$  under the group  $(\mathbb{Z}/n\mathbb{Z})^2$ , the matrix  $\Delta_n^m$  can be block diagonalized, and by Theorem 32,

$$\frac{1}{n^2} \log Z_{\text{forest}}(\mathbf{G}_n, \rho, m^2) = -\frac{1}{n^2} \log \det \Delta_n^m = -\frac{1}{n^2} \sum_{j, \ell=0}^{n-1} \log P_{\Delta_n^m}(e^{\frac{2i\pi j}{n}}, e^{\frac{2i\pi \ell}{n}}),$$

where  $P_{\Delta_n^m}(z, w) = \det \Delta_n^m(z, w)$  is the characteristic polynomial, see Section 5.2. Since it does not vanish on the torus  $\mathbb{T}^2$ , this quantity converges to

$$F_{\text{forest}} = - \iint_{|z|=|w|=1} \log \det \Delta^m(z, w) \frac{dz}{2\pi iz} \frac{dw}{2\pi iw}.$$

This formula is true for any biperiodic weighted graphs, as long as the mass is strictly positive at one vertex at least. When all the masses are zero, this expression is the free energy of the spanning tree model of the graph.

When conductances become infinite, the free energy blows up. A relevant, related quantity is the *entropy* of the model:

$$S_{\text{forest}} = -F_{\text{forest}} - \sum_{e \in \mathbf{E}_1} \mathbb{P}_{\text{forest}}(\{e\}) \log \rho(\theta_e) - \sum_{x \in \mathbf{V}_1} \mathbb{P}_{\text{forest}}(\{x\}) \log m^2(x).$$

Note that in a rooted spanning forest, the number of roots plus the number of edges is equal to the number of vertices. Therefore,

$$\sum_{e \in \mathbf{E}_1} \mathbb{P}_{\text{forest}}(\{e\}) + \sum_{x \in \mathbf{V}_1} \mathbb{P}_{\text{forest}}(\{x\}) = |\mathbf{V}_1|.$$

As a consequence, if we multiply all conductances and squared masses by the same factor  $\lambda$ ,  $F_{\text{forest}}$  gets an extra additive constant  $-|\mathbf{V}_1| \log \lambda$ , whereas  $S_{\text{forest}}$  stays unchanged. In particular, it always gives a finite result.

To find the formula for the free energy, following ideas of [Ken02], we study its variation as the embedding of the graph is modified by tilting the train-tracks, see Section 2.1.3.

Let us consider a smooth deformation of the isoradial graph  $\mathbf{G}$ , *i.e.*, a continuous family of isoradial graphs  $(\mathbf{G}(t))_{t \in [0,1]}$  obtained by varying the directions  $\alpha_T(t)$  of the train-tracks smoothly with  $t$ , in such a way that  $\mathbf{G}(1) = \mathbf{G}$  and  $\mathbf{G}(0) = \mathbf{G}^{\text{flat}}$ , where  $\mathbf{G}^{\text{flat}}$  is an isoradial graph whose edges have half-angles equal to<sup>3</sup> 0 or  $\frac{\pi}{2}$ . More precisely, every vertex of  $\mathbf{G}^{\text{flat}}$  has two incident vertices with angle  $\bar{\theta}_e = \frac{\pi}{2}$  and infinite conductance (called the *short edges*), the other incident edges (called the *long edges*) having  $\bar{\theta}_e = 0$ , thus zero conductance. The short edges form nontrivial disjoint cycles on the fundamental domain  $\mathbf{G}_1^{\text{flat}}$ . At a vertex  $x$  of degree  $n$  of  $\mathbf{G}^{\text{flat}}$ , the mass becomes:

$$m^2(x) = \lim_{\substack{\theta_i, \theta_j \rightarrow K \\ \theta_k \rightarrow 0, k \neq i, j}} \sum_{\ell=1}^n (A(\theta_\ell) - \text{sc}(\theta_\ell)) = 0,$$

since the function  $A - \text{sc}$  vanishes at 0 and  $K$ , see the proof of Proposition 6. Let us first compute the entropy  $S_{\text{forest}}^{\text{flat}}$ , when the graph becomes flat, by dividing all the conductances and masses by the largest conductance. After this renormalization, all edge-weights and masses on  $\mathbf{G}^{\text{flat}}$  are zero, except for the short edges: the entropy we want to compute is thus the entropy of the spanning tree model on the degenerate periodic graph only made of copies of the short edges, forming infinite lines. Since the number of spanning trees on a cycle does not grow exponentially with its size, the number of spanning trees on  $\mathbf{G}_N^{\text{flat}}$  does not grow exponentially with  $N^2$ , and thus the entropy of the model on  $\mathbf{G}^{\text{flat}}$  is equal to zero.

One could then follow the variation of the entropy along the deformation. However, it is simpler to use a twisted definition of the entropy, which does not really have a physical interpretation, but whose variation is easier to analyze. Let us define:

$$\begin{aligned} \tilde{S}_{\text{forest}} &= -F_{\text{forest}} - \sum_{e \in \mathbf{E}_1} 2H(2\theta_e) \log \rho(\theta_e) \\ &= S_{\text{forest}} + \sum_{e \in \mathbf{E}_1} [\mathbb{P}_{\text{forest}}(\{e\}) - 2H(2\theta_e)] \log \text{sc}(\theta_e) + \sum_{x \in \mathbf{V}_1} \mathbb{P}_{\text{forest}}(\{x\}) \log m^2(x). \end{aligned} \quad (41)$$

As the graph becomes flat,  $\tilde{S}_{\text{forest}}$  tends to zero, since its difference with  $S_{\text{forest}}$  becomes negligible, as can be checked from Equations (38) and (39).

Denote by  $F_{\text{forest}}(t)$  and  $\tilde{S}_{\text{forest}}(t)$  the free energy and the twisted entropy for the rooted spanning forest model on the graph  $\mathbf{G}(t)$ . As the angles of the train-tracks are supposed to vary smoothly with  $t$ , one can write:

$$\frac{dF_{\text{forest}}(t)}{dt} = - \iint_{|z|=|w|=1} \frac{d}{dt} \log \det \Delta^m(z, w) \frac{dz}{2\pi iz} \frac{dw}{2\pi iw}$$

---

<sup>3</sup>This is in contradiction with our hypothesis that all the angles  $\bar{\theta}_e$  are bounded away from 0 and  $\frac{\pi}{2}$ . We can still make sense of it. In particular, we can suppose that the condition of bounded angles is true for  $\mathbf{G}(\varepsilon)$ , as soon as  $\varepsilon > 0$ .

$$\begin{aligned}\frac{dF_{\text{forest}}(t)}{dt} &= - \iint_{|z|=|w|=1} \sum_{x,y \in \mathcal{V}_1} \frac{\partial \log \det \Delta^m(z,w)}{\partial \Delta^m(z,w)_{x,y}} \frac{d\Delta^m(z,w)_{x,y}}{dt} \frac{dz}{2\pi iz} \frac{dw}{2\pi iw} \\ &= - \sum_{x,y \in \mathcal{V}_1} \iint_{|z|=|w|=1} (\Delta^m(z,w)^{-1})_{y,x} \frac{d\Delta^m(z,w)_{x,y}}{dt} \frac{dz}{2\pi iz} \frac{dw}{2\pi iw},\end{aligned}$$

since for an invertible matrix  $M = (M_{i,j})$ , one has  $\frac{\partial \log \det M}{\partial M_{i,j}} = (M^{-1})_{j,i}$ .

By definition of the massive Laplacian matrix  $\Delta^m$ , the nonzero contributions of the entries of its Fourier transform  $\Delta^m(z,w)_{x,y}$  can be split into two categories:

- If  $(x,y)$  defines a directed edge  $e$  of  $\mathbf{G}_1$ , then  $\Delta^m(z,w)_{x,y}$  has a term equal to  $-\rho(\theta_e)$ , possibly multiplied by a nontrivial power of  $z$  and  $w$  if the lifts of  $x$  and  $y$  in  $\mathbf{G}$  belong to different fundamental domains. In that case, if the contribution is  $-\rho(\theta_e)z^i w^j$ , then its derivative with respect to  $t$  is  $-\frac{d\rho(\theta_e)}{dt}z^i w^j$ .
- If  $x = y$ , there is also in  $\Delta^m(z,w)_{x,x}$  a term  $d(x)$ , coming from the diagonal of  $\Delta^m$ .

Note that in some cases, in particular for graphs  $\mathbf{G}$  with a small fundamental domain, the two types of contributions can appear on the diagonal. However, if that happens, the term  $d(x)$  is the only one with no extra power of  $z$  or  $w$ . The other terms on the diagonal come by pair with opposite exponents for  $z$  and  $w$ , corresponding to the two possible directions of the edge crossing  $\tilde{\gamma}_x$  and/or  $\tilde{\gamma}_y$ .

From Equation (36) and using also the symmetry of the Green function we thus obtain:

$$\frac{dF_{\text{forest}}(t)}{dt} = - \sum_{x \in \mathcal{V}_1} G^m(x,x) \frac{d(d(x))}{dt} + 2 \sum_{e=xy \in \mathbf{E}_1} G^m(x,y) \frac{d\rho(\theta_e)}{dt}.$$

Along the deformation, the graph  $\mathbf{G}(t)$  stays isoradial, so the formulas for the conductances, the diagonal term of the massive Laplacian and the Green function in terms of the elliptic functions hold. Let us handle the first term. The diagonal term  $d(x)$  by Equation (12) is:

$$d(x) = \sum_{e \sim x} A(\theta_e).$$

Moreover, by Equation (70) of Appendix B,  $G^m(x,x) = \frac{k'K'}{\pi}$ , which does not depend on  $x$ . We can therefore rewrite the first term as

$$\sum_{x \in \mathcal{V}_1} G^m(x,x) \frac{d(d(x))}{dt} = \frac{k'K'}{\pi} \sum_{x \in \mathcal{V}_1} \sum_{e \sim x} \frac{dA(\theta_e)}{dt} = 2 \frac{k'K'}{\pi} \sum_{e \in \mathbf{E}_1} \frac{dA(\theta_e)}{dt} \stackrel{(64)}{=} \sum_{e \in \mathbf{E}_1} 2 \frac{K'}{\pi} \frac{dn^2(\theta_e)}{cn^2(\theta_e)} \frac{d\theta_e}{dt}. \quad (42)$$

We now handle the second term. By definition,  $\rho(\theta_e) = \text{sc}(\theta_e)$  and  $\text{sc}' = \text{dn} \cdot \text{cn}^{-2}$ . By Formula (c) of Lemma 46 proved in Appendix B,  $G^m(x,y) = \frac{K' \text{dn}(\theta_e)}{\pi} - \frac{H(2\theta_e)}{\text{sc}(\theta_e)}$ . The second term can therefore be rewritten as

$$2 \sum_{e=xy \in \mathbf{E}_1} G^m(x,y) \frac{d\rho(\theta_e)}{dt} = 2 \sum_{e \in \mathbf{E}_1} \left[ \frac{K' \text{dn}^2(\theta_e)}{\pi \text{cn}^2(\theta_e)} - \frac{H(2\theta_e) \text{dn}(\theta_e)}{\text{cn}(\theta_e) \text{sn}(\theta_e)} \right] \frac{d\theta_e}{dt}. \quad (43)$$

Combining Equations (42) and (43), we deduce

$$\frac{dF_{\text{forest}}(t)}{dt} = \sum_{e \in \mathbf{E}_1} f(\theta_e) \frac{d\theta_e}{dt}, \quad \text{with} \quad f(\theta) = -2 \frac{H(2\theta) \operatorname{dn}(\theta)}{\operatorname{cn}(\theta) \operatorname{sn}(\theta)} = -2 \frac{H(2\theta) \operatorname{sc}'(\theta)}{\operatorname{sc}(\theta)}. \quad (44)$$

Similarly,

$$\frac{d\tilde{S}_{\text{forest}}(t)}{dt} = \sum_{e \in \mathbf{E}_1} \tilde{s}(\theta_e) \frac{d\theta_e}{dt}, \quad \text{with} \quad \tilde{s}(\theta) = -f(\theta) - \frac{d}{d\theta} 2H(2\theta) \log \operatorname{sc}(\theta) = -4H'(2\theta) \log \operatorname{sc}(\theta).$$

Therefore to compute  $\tilde{S}_{\text{forest}}$  for the graph  $\mathbf{G}$ , it suffices to integrate  $\frac{d\tilde{S}_{\text{forest}}}{dt}$  along the deformation:

$$\tilde{S}_{\text{forest}} = \tilde{S}_{\text{forest}}(1) - \tilde{S}_{\text{forest}}(0) = \int_0^1 \sum_{e \in \mathbf{E}_1} \tilde{s}(\theta_e(t)) \frac{d\theta_e}{dt} dt = \sum_{e \in \mathbf{E}_1} \int_{\theta_e^{\text{flat}}}^{\theta_e} \tilde{s}(\theta) d\theta.$$

Among the parameters  $(\theta_e^{\text{flat}})_{e \in \mathbf{E}_1}$ , exactly  $|\mathbf{V}_1|$  are equal to  $K$ , the others being 0. Using moreover that  $\tilde{S}_{\text{forest}}(0) = \tilde{S}_{\text{forest}}^{\text{flat}} = 0$ , we then have:

$$\tilde{S}_{\text{forest}} = \sum_{e \in \mathbf{E}_1} \int_0^{\theta_e} \tilde{s}(\theta) d\theta - |\mathbf{V}_1| \int_0^K \tilde{s}(\theta) d\theta.$$

Finally, one can compute the free energy from (41):

$$F_{\text{forest}} = -\tilde{S}_{\text{forest}} - \sum_{e \in \mathbf{E}_1} 2H(2\theta_e) \log \operatorname{sc}(\theta_e) = |\mathbf{V}_1| \int_0^K \tilde{s}(\theta) d\theta + \sum_{e \in \mathbf{E}_1} \int_0^{\theta_e} f(\theta) d\theta, \quad (45)$$

which is exactly the expression given in Theorem 36. The equality between the two expressions follows from an integration by parts.  $\square$

*Remark 37.* Formulas (40) of Theorem 36 are a continuous expression of  $k$ . When  $k$  goes to zero,  $H'$  becomes constant,  $\operatorname{sc}$  becomes  $\tan$ , and the first integral becomes up to some multiplicative constant

$$\int_0^{\frac{\pi}{2}} \log \tan(\theta) d\theta,$$

which is zero by antisymmetry. Splitting  $\log \tan \theta = \log \sin \theta - \log \cos \theta$  in the remaining integral of the second formula yields the following value: when  $k \rightarrow 0$ :

$$F_{\text{forest}}^0 = - \sum_{e \in \mathbf{E}_1} \frac{2}{\pi} (L(\theta_e) + L(\pi/2 - \theta_e)) + \frac{2\theta_e}{\pi} \log \tan \theta_e, \quad (46)$$

where  $L$  is the Lobachevsky function, *i.e.*,  $L(x) = - \int_0^x \log(2 \sin t) dt$ . This is up to a negative sign, the logarithm of the normalized determinant of the Laplacian operator of [Ken02]. By slightly adapting the proof above, one sees that (46) actually is the free energy of the spanning tree model on  $\mathbf{G}$  with conductances  $(\tan(\theta_e))_{e \in \mathbf{E}}$ .

The next result proves a second order phase transition at  $k = 0$  in the rooted spanning forest model. This shows that the spanning tree model with conductances  $(\tan(\theta_e))_{e \in E}$ , corresponding to the Laplacian introduced in [Ken02], is a *critical model*; thus giving full meaning to the terminology *critical* used in the paper [Ken02]. Note that the conductances and masses behave smoothly in the neighborhood of  $k = 0$ , see Lemma 7.

**Theorem 38.** *Let  $F_{\text{forest}}^0$  be the free energy of spanning trees with critical conductances  $(\tan(\theta_e))_{e \in E}$ . The free energy  $F_{\text{forest}}^k$  admits the following expansion around  $k = 0$ :*

$$F_{\text{forest}}^k = F_{\text{forest}}^0 - k^2 \log k^{-1} |\mathbf{V}_1| + O(k^2).$$

As a consequence the model of rooted spanning forests on  $\mathbf{G}$  exhibits a phase transition of order two at  $k = 0$ .

*Proof.* We start from the terms involving  $f$  in the second equality of Equation (45), in which we perform the change of variable from  $\theta$  to  $\bar{\theta} = \frac{\pi\theta}{2K}$ :

$$F_e := \int_0^{\theta_e} f(\theta) d\theta = -\frac{4K}{\pi} \int_0^{\bar{\theta}_e} H\left(\frac{4K\bar{\theta}}{\pi}\right) \frac{dn}{\text{sn} \cdot \text{cn}}\left(\frac{2K\bar{\theta}}{\pi}\right) d\bar{\theta}.$$

We use the expansion of  $H$  in terms of the nome  $q = e^{-\pi K'/K}$ :

$$H\left(\frac{4K\bar{\theta}}{\pi}\right) = \frac{\bar{\theta}}{\pi} + \frac{2K'}{K} \sum_{s=1}^{\infty} \frac{q^s}{1-q^{2s}} \sin(2s\bar{\theta}) = \frac{\bar{\theta}}{\pi} - \frac{2}{\pi} \log q \sum_{s=1}^{\infty} \frac{q^s}{1-q^{2s}} \sin(2s\bar{\theta}). \quad (47)$$

In order to prove (47), we use the expression of  $H$  in terms of  $E$ , see (66), as well as the expansion of  $E$  in terms of the nome, which can be obtained from [AS64, 17.4.28 and 17.4.38]. The following expansion near  $k = 0$  holds (see [AS64, 17.3.14 and 17.3.21])

$$q = \frac{k^2}{16} + \frac{k^4}{32} + O(k^6).$$

We obtain that

$$H\left(\frac{4K\bar{\theta}}{\pi}\right) = \frac{\bar{\theta}}{\pi} - k^2 \log k \frac{\sin(2\bar{\theta})}{4\pi} + O(k^2).$$

We now multiply by  $\frac{dn}{\text{sn} \cdot \text{cn}}\left(\frac{2K\bar{\theta}}{\pi}\right)$ , which is analytic in  $k^2$  and admits the expansion  $\frac{1}{\sin \bar{\theta} \cos \bar{\theta}} + O(k^2)$ , see [AS64, 16.13.1–16.13.3], and we integrate. In this way, we obtain

$$F_e = -\frac{2}{\pi} \int_0^{\bar{\theta}_e} \frac{\bar{\theta}}{\sin \bar{\theta} \cos \bar{\theta}} d\bar{\theta} + k^2 \log k \frac{\bar{\theta}_e}{\pi} + O(k^2),$$

where we have made use of the standard identity  $\sin 2\bar{\theta} = 2 \sin \bar{\theta} \cos \bar{\theta}$ . The constant coefficient of  $F_e$  is integrated by parts to get:

$$\frac{2}{\pi} \int_0^{\bar{\theta}_e} \frac{\bar{\theta}}{\sin \bar{\theta} \cos \bar{\theta}} d\bar{\theta} = \frac{2}{\pi} \left( L(\bar{\theta}_e) + L\left(\frac{\pi}{2} - \bar{\theta}_e\right) \right) - \frac{2\bar{\theta}_e}{\pi} \log \tan(\bar{\theta}_e),$$

with  $L$  equal to the Lobachevsky function. Similar computations as above give that  $\int_0^K \tilde{s}(\theta) d\theta$  admits the following expansion when the parameter  $k$  goes to 0:

$$\int_0^K \tilde{s}(\theta) d\theta = \frac{k^2 \log k}{2} + O(k^2).$$

When summing all the contributions to the free energy, the constant coefficient is exactly  $F_{\text{forest}}^0$  from Equation (46), and the coefficient in front of  $k^2 \log k$  is:

$$\frac{|V_1|}{2} + \frac{1}{\pi} \sum_{e \in E_1} \bar{\theta}_e.$$

But since around every vertex of  $G_1$ , the half-angles of the rhombi sum to  $\pi$ , we have:

$$\frac{1}{\pi} \sum_{e \in E_1} \bar{\theta}_e = \frac{1}{2\pi} \sum_{x \in V_1} \sum_{e \sim x} \bar{\theta}_e = \frac{|V_1|}{2}. \quad \square$$

## 6.4 $Z$ -invariance of the spanning forest model

Theorem 12 proves an explicit, local expression for the massive Green function of an isoradial graph with the choice of weights (2). From the point of view of statistical mechanics, this feature is expected from models defined on isoradial graphs that are  $Z$ -invariant. Although already present in the papers [Ken99, Ons44], the notion of  $Z$ -invariance has been fully developed by Baxter in the context of the integrable 8-vertex model [Bax78], in connection with the Ising model and the  $q$ -Potts model [Bax86], and is directly related to the Yang-Baxter equations satisfied by the weights of integrable models [PAY06, Bax89, Ken04].

In this section, we define  $Z$ -invariance for rooted spanning forests, explain why one expects local expressions for probabilities, and make explicit the Yang-Baxter equations. Then in Theorem 41, using 3-dimensional consistency of the massive Laplacian (Proposition 8), we prove that with the choice of conductances and mass of Definition 3.2, the model of rooted spanning forests is indeed  $Z$ -invariant.

### 6.4.1 Definition

Let  $G_Y$  and  $G_\Delta$  be finite isoradial graphs differing by a star-triangle transformation, as defined in Section 2.1.3. For convenience of the reader, we repeat Figure 6, fixing notation for vertices and weights around the star/triangle.

$Z$ -invariance imposes strong relations on the partition functions of  $G_Y$  and  $G_\Delta$ . They are more easily expressed using the bijection of Section 6.1: instead of considering the rooted spanning forest partition functions of  $G_Y$  and  $G_\Delta$ , we take the spanning tree partition functions of  $G_Y^r$  and  $G_\Delta^r$ .

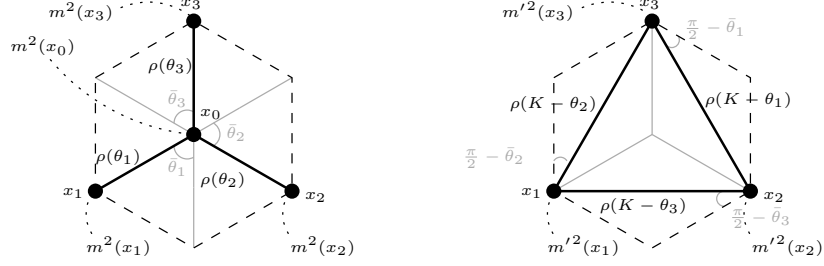

Figure 12: *Star-triangle transformation* and notation. If an isoradial graph  $G_Y$  (left) has a *star*, *i.e.*, a vertex  $x_0$  of degree 3, it can be transformed into a new isoradial graph  $G_\Delta$  (right) having a *triangle* connecting the three neighbors  $x_1, x_2, x_3$  of  $x_0$ , by shifting around the three rhombi of the underlying rhombus graph  $G^\diamond$ , and vice-versa.

Let  $G'$  be the graph obtained from  $G_Y^r$  by removing the vertex  $x_0$ , the edges  $x_i x_0$ ,  $x_i r$ ,  $i \in \{1, 2, 3\}$  and  $x_0 r$ . Note that  $G'$  is also obtained from  $G_\Delta^r$  by removing the edges  $x_i r$  and  $x_i x_{i+1}$  (in cyclic notations),  $i \in \{1, 2, 3\}$ .

Denote by  $\tilde{\mathcal{T}}(G')$  the set of edge-configurations of  $G'$ , which can be extended to spanning trees on  $G_\Delta^r$  and  $G_Y^r$ . For  $\tilde{T} \in \tilde{\mathcal{T}}(G')$ , let  $Z(G_Y|\tilde{T})$  (resp.  $Z(G_\Delta|\tilde{T})$ ) be the restricted spanning tree partition function of  $G_Y^r$  (resp.  $G_\Delta^r$ ) coinciding with  $\tilde{T}$  outside the location of the star-triangle transformation, *i.e.* the sum of the weights of the local configurations used to extend  $\tilde{T}$  to a full spanning tree of the whole graph  $G_Y^r$  (resp.  $G_\Delta^r$ ).

**Definition 6.1.** The rooted spanning forest model is *Z-invariant*, if the conductances assigned to edges and masses assigned to vertices are such that there exists a constant  $\mathcal{C}$ , such that for every  $\tilde{T} \in \tilde{\mathcal{T}}(G')$ , we have:

$$Z(G_Y|\tilde{T}) = \mathcal{C}Z(G_\Delta|\tilde{T}).$$

*Remark 39.* Since the probability of an event can be written as the ratio of the partition function restricted to the event and the full partition function, the condition of *Z-invariance* is equivalent to asking that this probability is not affected by star-triangle transformations performed away from the event. In particular, this suggests that formulas for probabilities should have the locality property.

#### 6.4.2 Yang-Baxter equations of rooted spanning forests

Actually,  $Z(G_Y|\tilde{T})$  and  $Z(G_\Delta|\tilde{T})$  only depend on the connection properties of  $\tilde{T}$  outside of the star-triangle, so that we can partition  $\tilde{\mathcal{T}}(G')$  according to whether the configuration  $\tilde{T}$  satisfies:

- $R^{\{x_1, x_2, x_3\}}$ : vertices  $x_1, x_2, x_3$  are connected to  $r$ ,

- $R^{\{x_i, x_j\}}$ : vertices  $x_i, x_j$  are connected to  $r$ ,  $x_k$  is not;  $i \neq j \neq k$ ,  $\{i, j\} \subset \{1, 2, 3\}$ ,
- $R^{\{x_i\}}$ : the vertex  $x_i$  is connected to  $r$ ,  $x_j, x_k$  are not;  $i \in \{1, 2, 3\}$ ,
- $R^\emptyset$ : none of the vertices  $x_1, x_2, x_3$  is connected to  $r$ .

Denote by  $R$  any condition above. With a slight abuse of notation, if  $\tilde{T}$  satisfies the condition  $R$ , we will write  $Z(G_Y|R)$  for  $Z(G_Y|\tilde{T})$  and the same for  $G_\Delta$ . The model is thus  $Z$ -invariant if and only if, there exists a constant  $\mathcal{C}$ , such that:

$$\forall \text{ condition } R, Z(G_Y|R) = \mathcal{C} Z(G_\Delta|R) \quad (\text{Yang-Baxter equations}). \quad (48)$$

Classically  $Z$ -invariance is proved by showing that the weights satisfy the Yang-Baxter equations. In this paper we provide an alternative, shorter proof, see Theorem 41<sup>4</sup>, which does not require making the equations explicit. We nevertheless write them down for three reasons: first, the first equation allows to explicitly compute the constant  $\mathcal{C}$ ; second, they are not present in the physics literature and might be of interest to this community; third, it is quite remarkable that such rather complicated looking equations have a one-parameter family of solutions.

Writing the Yang-Baxter equations amounts to making explicit the contributions  $Z(G_Y|R)$  and  $Z(G_\Delta|R)$  in the four cases above.

- Case  $R^{\{x_1, x_2, x_3\}}$  illustrated in Figure 13. If all the  $x_\ell$ 's are connected to  $r$ , then in  $G_\Delta^r$ , one can add (exactly) one edge to connect  $x_0$  to  $r$  through one of the three vertices  $x_\ell$ , (and have a weight  $\rho(\theta_\ell)$ ), or directly connect  $x_0$  to  $r$  through an edge with weight  $m^2(x_0)$ . On  $G_\Delta^r$ , there is nothing to do, so the total weight is 1. This yields the following identities

$$Z(G_Y|R^{\{x_1, x_2, x_3\}}) = \sum_{\ell=1}^3 \rho(\theta_\ell) + m^2(x_0), \quad (49)$$

$$Z(G_\Delta|R^{\{x_1, x_2, x_3\}}) = 1. \quad (50)$$

Similar considerations for the other three cases lead to the following expressions of  $Z(G_Y|R)$  and  $Z(G_\Delta|R)$ . The expressions are longer because the number of possible situations increases.

- Case  $R^{\{x_i, x_j\}}$ :

$$Z(G_Y|R^{\{x_i, x_j\}}) = \rho(\theta_k) \left[ \sum_{\ell \neq k} \rho(\theta_\ell) \right] + m^2(x_0) \rho(\theta_k) + m^2(x_k) \left[ \sum_{\ell=1}^3 \rho(\theta_\ell) + m^2(x_0) \right],$$

$$Z(G_\Delta|R^{\{x_i, x_j\}}) = \sum_{\ell \neq k} \rho(K - \theta_\ell) + m'^2(x_k).$$

---

<sup>4</sup>A direct proof showing that our choice of weights satisfy the Yang-Baxter equations can be found on the first arXiv version of this paper.



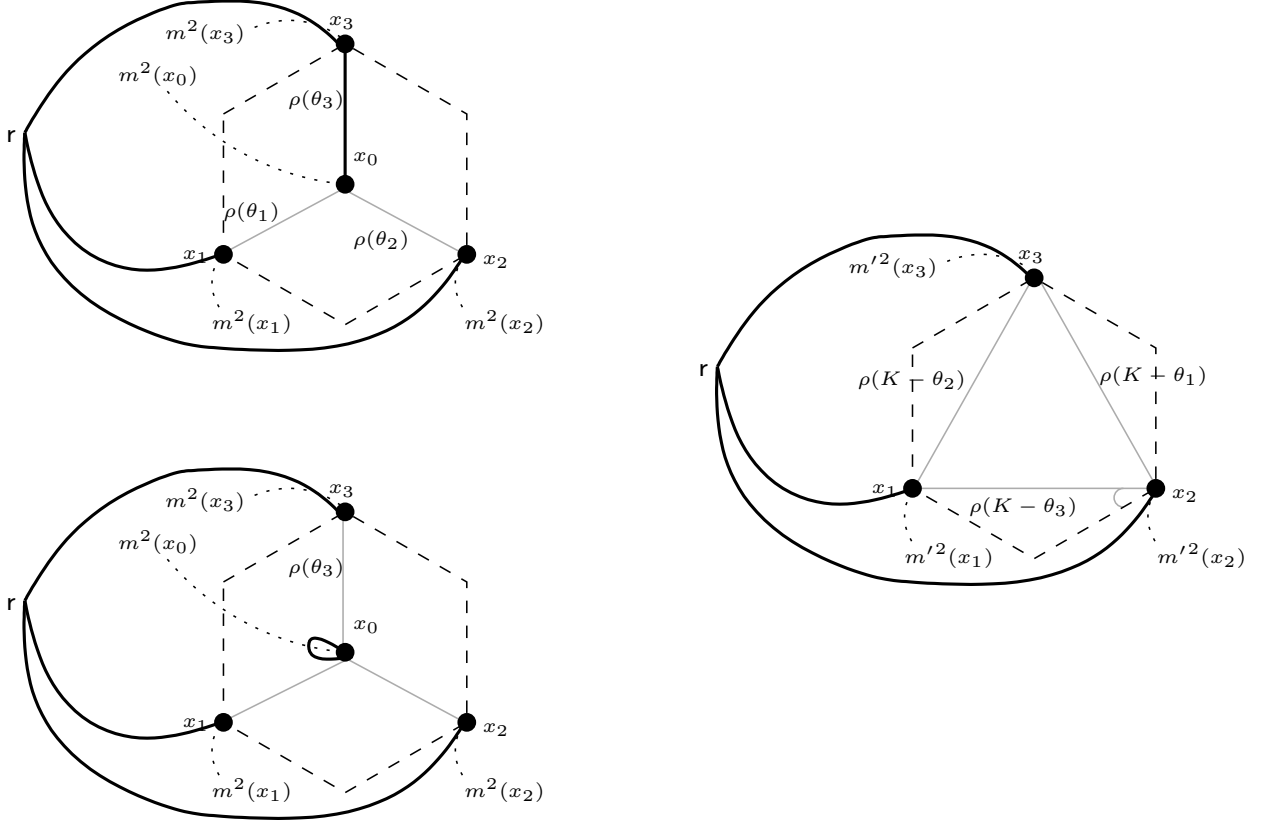

Figure 13: Left (with the analog containing either  $\rho(\theta_1)$  or  $\rho(\theta_2)$ ) and center: possible configurations for  $Z(G_Y|R^{\{x_1, x_2, x_3\}})$ . Right: possible configuration for  $Z(G_\Delta|R^{\{x_1, x_2, x_3\}})$ .

- Case  $R^{\{x_i\}}$ :

$$\begin{aligned}
Z(G_Y|R^{\{x_i\}}) &= \prod_{\ell=1}^3 \rho(\theta_\ell) + m^2(x_0) \prod_{\ell \neq i} \rho(\theta_\ell) + \sum_{\ell \neq i} m^2(x_\ell) \rho(\theta_{\{i, \ell\}^c}) \left[ \sum_{\ell' \in \{i, \ell\}} \rho(\theta_{\ell'}) \right] \\
&\quad + m^2(x_0) [m^2(x_k) \rho(\theta_j) + m^2(x_j) \rho(\theta_k)] + \left[ \prod_{\ell \neq i} m^2(x_\ell) \right] \left[ \sum_{\ell=1}^3 \rho(\theta_\ell) + m^2(x_0) \right], \\
Z(G_\Delta|R^{\{x_i\}}) &= \sum_{\ell=1}^3 \prod_{\ell' \neq \ell} \rho(K - \theta_{\ell'}) + \sum_{\ell \neq i} m'^2(x_\ell) \left[ \sum_{\ell' \in \{i, \ell\}} \rho(K - \theta_{\ell'}) \right] + \prod_{\ell \neq i} m'^2(x_\ell).
\end{aligned}$$

Above,  $\{i, \ell\}^c$  denotes the complementary set of  $\{i, \ell\}$ , i.e., the unique index  $k$  which is not  $i$  and  $\ell$ .

- Case  $R^0$ :

$$\begin{aligned}
Z(\mathbf{G}_Y | R^0) &= \left[ \sum_{i=0}^3 m^2(x_i) \right] \left[ \prod_{i=1}^3 \rho(\theta_i) \right] + m^2(x_0) \sum_{i=1}^3 m^2(x_i) \prod_{\ell \neq i} \rho(\theta_\ell) \\
&\quad + \sum_{i=1}^3 \left[ \prod_{\ell \neq i} m^2(x_\ell) \right] \rho(\theta_i) \left[ \sum_{\ell \neq i} \rho(\theta_\ell) \right] + m^2(x_0) \sum_{i=1}^3 \left[ \prod_{\ell \neq i} m^2(x_\ell) \right] \rho(\theta_i) \\
&\quad + \left[ \prod_{i=1}^3 m^2(x_i) \right] \left[ \sum_{i=1}^3 \rho(\theta_i) + m^2(x_0) \right], \\
Z(\mathbf{G}_\Delta | R^0) &= \left[ \sum_{i=1}^3 m'^2(x_i) \right] \left[ \sum_{i=1}^3 \prod_{\ell \neq i} \rho(K - \theta_\ell) \right] + \sum_{i=1}^3 \left[ \prod_{\ell \neq i} m'^2(x_\ell) \right] \left[ \sum_{\ell \neq i} \rho(K - \theta_\ell) \right] \\
&\quad + \prod_{i=1}^3 m'^2(x_i).
\end{aligned}$$

*Remark 40.* When  $k = 0$ , the equations drastically simplify since all the masses are 0. They are the Yang-Baxter equations of the spanning tree model, and reduce to the so-called Kennelly's theorem [Ken99], linking the conductances so that the electric networks  $\mathbf{G}_Y$  and  $\mathbf{G}_\Delta$  are equivalent. When eliminating  $\rho(K - \theta_i)$  from the equations, one is left with a single equation:

$$\rho(\theta_1) + \rho(\theta_2) + \rho(\theta_3) = \rho(\theta_1)\rho(\theta_2)\rho(\theta_3), \quad \theta_1 + \theta_2 + \theta_3 = \pi,$$

which, when parametrized by taking  $\rho(\theta) = \tan(\theta)$  is the triple tangent identity. This expression for  $\rho(\theta)$  coincides with the critical conductances for trees on isoradial graphs introduced in [Ken02].

### 6.4.3 $Z$ -invariance of the rooted spanning forests model

The next theorem proves that, with the choice of conductances and masses of Equations (11) and (12), the rooted spanning forest model is  $Z$ -invariant.

**Theorem 41.** *Let  $k \in [0, 1)$ . Suppose that conductances assigned to edges, and masses assigned to vertices are given by Equations (11) and (12). Then, the model of rooted spanning forests is  $Z$ -invariant with constant  $\mathcal{C}(k) = k' \operatorname{sc}(\theta_1) \operatorname{sc}(\theta_2) \operatorname{sc}(\theta_3)$ .*

*Remark 42.* We conjecture that the conductances and masses from Equations (11) and (12) provide a complete parametrization of the Yang-Baxter equations of rooted spanning forests.

*Remark 43.* In the actual state of knowledge,  $Z$ -invariance does not provide a way of finding local expressions, but it gives a framework for choosing the parameters of the model. In some cases (not including ours), there are some elements in that direction though in the work by [ABS03] through the link between 3-dimensional consistency of some classes of equations on isoradial graphs, and existence of solutions of these equations with a product structure.

*Proof.* Let us first suppose that  $Z$ -invariance is proved and compute the constant  $\mathcal{C}(k)$ . From Equations (49) and (50), we know that  $\mathcal{C}(k) = \sum_{\ell=1}^3 \rho(\theta_\ell) + m^2(x_0)$ . Using Equation (71), we deduce that  $\mathcal{C}(k) = k' \prod_{\ell=1}^3 \text{sc}(\theta_\ell)$ .

Using Remark 39, proving  $Z$ -invariance is equivalent to proving invariance of the probability measure under star-triangle transformations. Using the transfer-impedance theorem 33 [BP93] it suffices to show that the Green functions  $G_{\mathbb{G}_\Delta}^m(x, y)$  and  $G_{\mathbb{G}_\Upsilon}^m(x, y)$  are equal on all common vertices (that is different than  $x_0$ ). Let us fix  $x$ , then  $G_{\mathbb{G}_\Delta}^m(x, \cdot)$  is harmonic everywhere except at  $x$ . By Proposition 8, there is a unique way of extending  $G_{\mathbb{G}_\Delta}^m(x, \cdot)$  to  $\mathbb{G}_\Upsilon$  in such a way that its massive Laplacian takes the same value at every vertices other than  $x_0$ , and is equal to 0 at  $x_0$ . This new function is massive harmonic everywhere except at  $x$ , it is thus equal to  $G_{\mathbb{G}_\Upsilon}^m(x, \cdot)$ . By construction it is equal to  $G_{\mathbb{G}_\Delta}^m(x, \cdot)$  on all common vertices thus concluding the proof.  $\square$

## A Useful identities involving elliptic functions

In this section we list required identities satisfied by elliptic functions. We also derive properties and identities satisfied by the functions  $A$  and  $H$  defined in Section 2.2.

### A.1 Identities for Jacobi elliptic functions

**Change of argument.** Jacobi elliptic functions satisfy various addition formulas by quarter-periods and half-periods, among which:

$$\text{sc}(u - K|k) = -\frac{1}{k'} \text{sc}(u|k)^{-1}, \quad ([\text{Law89}, 2.2.17-2.2.18]) \quad (51)$$

$$\text{dn}(u + K|k) = k' \text{dn}(u|k)^{-1}, \quad ([\text{Law89}, 2.2.19]) \quad (52)$$

$$\text{sc}(u + 2iK'|k) = -\text{sc}(u + 2K|k) = -\text{sc}(u|k), \quad ([\text{Law89}, 2.2.11-2.2.12]) \quad (53)$$

$$\text{sc}(u + iK'|k) = i \text{dn}(u|k)^{-1}, \quad ([\text{Law89}, 2.2.17-2.2.18]) \quad (54)$$

$$\text{sn}(u - iK'|k) = \frac{1}{k} \text{sn}(u|k)^{-1}, \quad ([\text{Law89}, 2.2.11-2.2.17]). \quad (55)$$

**Jacobi imaginary transformation.** These transformations, which are proved in [Law89, 2.6.12], refer to the substitution of  $u$  by  $iu$  in the argument of Jacobi elliptic functions:

$$\text{sn}(iu|k) = i \text{sc}(u|k'), \quad \text{cs}(iu|k) = -i \text{ns}(u|k'), \quad \text{dn}(iu|k) = \text{dc}(u|k'). \quad (56)$$

**Derivatives of Jacobi functions.** These derivatives are computed in [AS64, 16.16]:

$$\text{sn}' = \text{cn dn}, \quad \text{cn}' = -\text{sn dn}, \quad \text{dn}' = -k^2 \text{sn cn}. \quad (57)$$

**Ascending Landen transformation.** This allows to express the ratio  $\frac{\text{sn} \cdot \text{cn}}{\text{dn}}$  as an sn function, with a different elliptic modulus:

$$\frac{\text{sn} \cdot \text{cn}}{\text{dn}}(u|k) = \frac{\text{sn}((1 + \mu)u|\ell)}{1 + \mu}, \quad \text{with } \ell = \frac{2 - k^2 - 2\sqrt{1 - k^2}}{k^2} \text{ and } \mu = \frac{1 - \ell}{1 + \ell}. \quad (58)$$

It is stated in [Law89, 3.9.19]. Furthermore, the values of  $K(k), K'(k)$  are related to those of  $K(\ell), K'(\ell)$  as follows (this can be noticed indirectly, by comparing the periods of the above functions):

$$K(k) = (1 + \ell)K(\ell), \quad K'(k) = \frac{K'(\ell)}{1 + \mu}. \quad (59)$$

## A.2 Identities for the functions A and H

Recall the definition of the function  $A(\cdot|k)$ , see Equation (8) of Section 2.2,

$$A(u|k) = \frac{1}{k'} \left( \text{Dc}(u|k) + \frac{E - K}{K} u \right), \quad \text{where } \text{Dc}(u|k) = \int_0^u \text{dc}^2(v|k) dv.$$

**Lemma 44.** *The function  $A(\cdot|k)$  is odd and satisfies the following identities:*

$$\bullet A(K - u|k) = -A(u|k) + \frac{1}{k'} \text{ns}(u|k) \text{dc}(u|k), \quad (60)$$

$$\bullet A(v - u|k) = A(v|k) - A(u|k) - k' \text{sc}(u|k) \text{sc}(v|k) \text{sc}(v - u|k), \quad (61)$$

$$\bullet A(u + 2K|k) = A(u|k), \quad (62)$$

$$\bullet A(u + 2iK'|k) = A(u|k) + \frac{i\pi}{k'K}, \quad (63)$$

$$\bullet \frac{dA}{du}(u|k) = \frac{\text{dc}^2(u|k)}{k'} - \frac{K - E}{k'K}. \quad (64)$$

*Proof.* Consider *Jacobi epsilon function*  $E(\cdot|k)$ , see also [Law89, 3.4.25],

$$\forall u \in \mathbb{C}, \quad E(u|k) = \int_0^u \text{dn}^2(v|k) dv. \quad (65)$$

Performing the change of variable  $u \rightarrow iu$  in  $E(iu|k')$  and using Jacobi imaginary transformation (56), the function A can be expressed as

$$A(u|k) = -\frac{i}{k'} E(iu|k') + \frac{E - K}{k'K} u. \quad (66)$$

The function A is odd because E is. Moreover, Jacobi epsilon function satisfies the following:

$$\bullet E(-u + iK'|k) = -E(u|k) + i(K' - E') - \text{cs}(u|k) \text{dn}(u|k), \quad ([\text{Law89}, 3.6.17]) \quad (67)$$

$$\bullet E(v - u|k) = E(v|k) - E(u|k) + k^2 \text{sn}(u|k) \text{sn}(v|k) \text{sn}(v - u|k), \quad ([\text{Law89}, 3.5.14]) \quad (68)$$

$$\bullet E(2K|k) = 2E, \quad E(2iK'|k) = 2i(K' - E'), \quad ([\text{Law89}, 3.6.22]). \quad (69)$$

We first prove (60). From Identities (66) and (67), we have

$$\begin{aligned} A(-u + K|k) + A(u|k) &= -\frac{i}{k'}(E(-iu + iK|k') + E(iu|k')) + \frac{E - K}{k'} \\ &= -\frac{i}{k'}(i(K - E) - \operatorname{cs}(iu|k') \operatorname{dn}(iu|k')) + \frac{E - K}{k'} \\ &= \frac{i}{k'} \operatorname{cs}(iu|k') \operatorname{dn}(iu|k'). \end{aligned}$$

The proof is concluded using Jacobi imaginary transformation (56). We turn to the proof of (61). Using the definition of  $A(v - u|k)$  and Identity (68) evaluated at  $k'$ , we have:

$$A(v - u|k) = A(v|k) - A(u|k) - ik' \operatorname{sn}(iu|k') \operatorname{sn}(iv|k') \operatorname{sn}(i(v - u)|k').$$

The proof is again concluded using Jacobi imaginary transformation (56). We now move to the proof of (62) and (63). From (69) used with  $k'$  instead of  $k$ , we have

$$\begin{aligned} A(2K|k) &= -\frac{i}{k'}E(2iK|k') + 2\frac{E - K}{k'} = -\frac{i}{k'}2i(K - E) + 2\frac{E - K}{k'} = 0, \\ A(2iK'|k) &= -\frac{i}{k'}(E(-2K'|k')) + \frac{2iK'(E - K)}{k'K} = -\frac{i}{k'}(-2E') + \frac{2iK'(E - K)}{k'K} = \frac{i\pi}{k'K}, \end{aligned}$$

where the last equality is a consequence of Legendre's identity (6). The proof of (62) (resp. (63)) is concluded using (61) evaluated at  $-u$  and  $2K$  (resp.  $-u$  and  $2iK'$ ).

Finally, Equation (64) readily follows from (66).  $\square$

Recall the definition of the function  $H(u|k) = \frac{-ik'K'}{\pi}A\left(\frac{iu}{2}|k'\right)$ , see (9).

**Lemma 45.** *The function  $H(\cdot|k)$  satisfies the following properties:*

- $H(u + 4K|k) = H(u|k) + 1$ ,
- $H(u + 4iK'|k) = H(u|k)$ ,
- $\lim_{k \rightarrow 0} H(u|k) = \frac{u}{2\pi}$ ,
- $H$  has a simple pole in the rectangle  $[0, 4K] + [0, 4iK']$ , at  $2iK'$ , with residue  $\frac{2K'}{\pi}$ .

*Proof.* The first two properties of Lemma 45 immediately follow from using (62) and (63) in (9). The limit of  $H$  as  $k \rightarrow 0$  is computed using the alternative expression (66):

$$H(u|k) = \frac{-ik'K'}{\pi}A\left(\frac{iu}{2}|k'\right) = \frac{K'}{\pi} \left( E\left(\frac{u}{2}|k\right) + \frac{E' - K'}{K'} \frac{u}{2} \right).$$

We conclude using the fact that  $\lim_{k \rightarrow 0} E(u|k) = u$ , see (65) and Section 2.2, together with  $\lim_{k \rightarrow 0} E'(k) = 1$ .

Finally,  $\operatorname{dc}$  has a simple pole at  $K$  with residue 1, hence by (7) the same holds true for  $\operatorname{Dc}$ . Accordingly  $\operatorname{Dc}\left(\frac{iu}{2}|k'\right)$  has a pole of order 1 at  $-2iK'$  with residue  $-2i$ . Using the expression (8) as well as the fact that  $H$  is odd completes the proof.  $\square$

## B Explicit computations of the Green function

In this section, we explicitly compute values of the Green function along the diagonal and for incident vertices. We use the explicit formula (19) of Theorem 12 and the residue theorem. The second formula for incident vertices uses the symmetry of the Green function. Note that it is not immediate that the two formulas (b) and (c) are indeed equal. The first is more useful in the proof of Theorem 12, the third is more attractive since it only involves the half-angle  $\theta$ .

**Lemma 46.**

1. Let  $x$  be a vertex of  $G$ . Then, the Green function on the diagonal at  $x$  is equal to:

$$G^m(x, x) = \frac{k'K'}{\pi}. \quad (70)$$

2. Let  $x$  and  $y$  be neighboring vertices in  $G$ , endpoints of an edge  $e$  in a rhombus spanned by  $e^{i\bar{\alpha}}$ , and  $e^{i\bar{\beta}}$ , of half-angle  $\theta = \frac{\beta - \alpha}{2} \in (0, K)$  with  $y = x + e^{i\bar{\alpha}} + e^{i\bar{\beta}}$ , then we have the following expressions for the Green function evaluated at  $(x, y)$ :

$$(a) \quad G^m(x, y) = \frac{H(\alpha + 2K) - H(\beta + 2K)}{\text{sc}(\theta)} + \frac{k'K'}{\pi} \mathbf{e}_{(x,y)}(2iK'),$$

$$(b) \quad G^m(x, y) = \frac{H(\alpha) - H(\beta)}{\text{sc}(\theta)} + \frac{K'}{\pi} \text{dn}\left(\frac{\alpha}{2}\right) \text{dn}\left(\frac{\beta}{2}\right),$$

$$(c) \quad G^m(x, y) = -\frac{H(2\theta)}{\text{sc}(\theta)} + \frac{K'}{\pi} \text{dn}(\theta).$$

*Proof of Point 1.* Using expression (18), we have

$$G^m(x, x) = \frac{k'}{4i\pi} \oint_{\mathbf{C}} 1 du,$$

where  $\mathbf{C}$  is any contour winding once vertically on  $\mathbb{T}(k)$  (the contour can be anywhere, since the integrand has no pole). Take for  $\mathbf{C}$  a vertical segment and parametrize it by the ordinate  $w = \text{Im}(u)$ . Using that the length of  $\mathbf{C}$  is  $4K'$  and that  $du = idw$ , one readily gets

$$G^m(x, x) = \frac{k'}{4i\pi} (i4K') = \frac{k'K'}{\pi}. \quad \square$$

*Proof of Point 2.* We first prove (a). Using expression (19) and replacing the exponential function by its definition, we need to compute

$$G^m(x, y) = -\frac{k'^2}{4i\pi} \oint_{\gamma_{x,y}} H(u) \text{sc}\left(\frac{u - \alpha}{2}\right) \text{sc}\left(\frac{u - \beta}{2}\right) du.$$

where  $\gamma_{x,y}$  is a trivial contour containing the pole  $2iK'$  of  $H$  and the poles  $\alpha + 2K$ ,  $\beta + 2K$  of the exponential function. The residue of  $\text{sc}$  at  $K$  is  $-1/k'$ , see (51) or [AS64, Table 16.7], from which we deduce that:

$$\text{Res}_{u=\alpha+K} \left[ \text{sc} \left( \frac{u-\alpha}{2} \right) \right] = -\frac{2}{k'}.$$

By the residue theorem, we thus have:

$$\begin{aligned} G^m(x, y) &= -\frac{k'^2}{2} \left( \underbrace{-\frac{2}{k'} [H(\alpha + 2K) \text{sc}(K - \theta) + H(\beta + 2K) \text{sc}(K + \theta)]}_{\text{residues at } \alpha + 2K \text{ and } \beta + 2K} + \underbrace{-\frac{2K'}{k'\pi} e_{x,y}(2iK')}_{\text{residue at } 2iK'} \right) \\ &\stackrel{(51)}{=} \frac{H(\beta + 2K) - H(\alpha + 2K)}{\text{sc}(\theta)} + \frac{k'K'}{\pi} e_{x,y}(2iK'), \end{aligned}$$

which concludes the proof of (a). Note that by Identity (54),  $e_{(x,y)}(2iK') = \frac{k'}{\text{dn}(\frac{\alpha}{2}) \text{dn}(\frac{\beta}{2})}$ .

Expression (b) is obtained by symmetry of  $G^m$ , by exchanging the role of  $x$  and  $y$ , transforming  $\alpha$  and  $\beta$  into  $\alpha + 2K$  and  $\beta + 2K$ , respectively. Using Identity (52), one gets

$$e_{(y,x)}(2iK') = \frac{k'}{\text{dn}(\frac{\alpha+2K}{2}) \text{dn}(\frac{\beta+2K}{2})} = \frac{\text{dn}(\frac{\alpha}{2}) \text{dn}(\frac{\beta}{2})}{k'}.$$

To obtain (c) we again use Equation (19) but instead of the function  $H$ , we use the function  $\tilde{H}$ :

$$\tilde{H}(u) = H(u - \alpha).$$

Indeed, since  $\tilde{H} - H$  is an elliptic function, it satisfies the conditions required for Equation (19) to hold, see Remark 13. After a change of variable  $v = u - \alpha$  in the integral, we get

$$G^m(x, y) = -\frac{k'^2}{4i\pi} \oint_{\gamma} H(v) \text{sc} \left( \frac{v}{2} \right) \text{sc} \left( \frac{v - 2\theta}{2} \right) dv,$$

which would be the integral expression giving (b) when  $\alpha = 0$ , and  $\beta = 2\theta$ . Expression (c) is then obtained using the fact that  $H(0) = 0$  and  $\text{dn}(0) = 1$ .  $\square$

## C Identities for weights of the star-triangle transformation

In this section we prove identities for weights involved in the star-triangle transformation, used in Sections 3.2 and 6.4. We refer to Figure 6 for notation.

**Lemma 47.** *We have the following identities for weights involved in the star-triangle transformation:*

$$k' \prod_{\ell=1}^3 \rho(\theta_{\ell}) = m^2(x_0) + \sum_{\ell=1}^3 \rho(\theta_{\ell}), \quad (71)$$

$$m^2(x_k) - m^2(x_k) = \rho(\theta_k) - \sum_{\ell \neq k} \rho(K - \theta_{\ell}) - k' \rho(K - \theta_i) \rho(K - \theta_j) \rho(\theta_k). \quad (72)$$

*Proof.* Equation (71) is a consequence of (61) and (62) using that  $\theta_1 + \theta_2 + \theta_3 = 2K$ . We now prove Equation (72). Note that the star-triangle transformation implies that  $m'^2(x_k) - m^2(x_k)$  only depends on three angles, that we call  $\theta_i, \theta_j, \theta_k$ . We have:

$$\begin{aligned}
m'^2(x_k) - m^2(x_k) &= \\
&= A(K - \theta_i) + A(K - \theta_j) - \text{sc}(K - \theta_i) - \text{sc}(K - \theta_j) - A(\theta_k) + \text{sc}(\theta_k) \\
&= A(K - \theta_i) + A(K - \theta_j) - A(2K - (\theta_i + \theta_j)) - \text{sc}(K - \theta_i) - \text{sc}(K - \theta_j) + \text{sc}(\theta_k) \\
&= -k' \text{sc}(K - \theta_i) \text{sc}(K - \theta_j) \text{sc}(2K - (\theta_i + \theta_j)) - \text{sc}(K - \theta_i) - \text{sc}(K - \theta_j) + \text{sc}(\theta_k), \\
&\quad \text{by Point (61) of Lemma 44} \\
&= -k' \text{sc}(K - \theta_i) \text{sc}(K - \theta_j) \text{sc}(\theta_k) - \text{sc}(K - \theta_i) - \text{sc}(K - \theta_j) + \text{sc}(\theta_k),
\end{aligned}$$

thus ending the proof.  $\square$

## D Random walks and rooted spanning forests

In this Appendix, we collect some facts about rooted spanning forests, killed random walks and their link to network random walks and spanning trees, that are useful for Section 6.

Suppose for the moment that  $G$  is a finite connected (not necessarily isoradial) graph, with a massive Laplacian  $\Delta^m$ . Equivalently, by Equation (10),  $G$  is endowed with positive conductances  $(\rho(e))_{e \in E}$  and positive masses  $(m^2(x))_{x \in V}$ . Consider the graph  $G^r = (V^r, E^r)$  obtained from  $G$  by adding a root vertex  $r$  and joining every vertex of  $G$  to  $r$ , as in Section 6.1. The graph  $G^r$  is weighted by the function  $\rho^m$ , see (37).

### D.1 Massive harmonicity on $G$ and harmonicity on $G^r$

There is a natural (non-massive) Laplacian  $\Delta_r$  on  $G^r$ , acting on functions  $f$  defined on vertices of  $G^r$ :

$$\forall x \in V^r, \quad \Delta_r f(x) = \sum_{xy \in E^r} \rho^m(xy) [f(x) - f(y)].$$

Then the restriction  $\Delta_r^{(r)}$  of the matrix of  $\Delta_r$  to vertices of  $G$ , obtained by removing the row and column corresponding to  $r$ , is exactly the matrix  $\Delta^m$ .

Functions on vertices of  $G$  are in bijection with functions on vertices of  $G^r$  taking value 0 on  $r$  (by extension/restriction). This bijection is compatible with the Laplacians on  $G$  and  $G^r$ : if  $f$  is a function on  $G$  and  $\tilde{f}$  is its extension to  $G^r$  such that  $\tilde{f}(r) = 0$ , then  $\Delta^m f = \Delta_r \tilde{f}$  on  $G$ .

The operator  $\Delta^m$  is invertible, and its inverse is  $G^m$ , the massive Green function of  $G$ . The matrix  $\Delta_r$  is not invertible: its kernel is exactly the space of constant functions on  $G^r$ , but its restriction to functions on  $G^r$  vanishing at  $r$  is invertible, and its negated inverse is exactly  $\tilde{G}^m$ , the extension of  $G^m$  to  $G^r$ , taking the value 0 at  $r$ :

$$\forall x, y \in V^r, \quad \tilde{G}^m(x, y) = \tilde{G}^m(y, x) = \begin{cases} G^m(x, y) & \text{if } x \text{ and } y \text{ are vertices of } G, \\ 0 & \text{if } x \text{ or } y \text{ is equal to } r. \end{cases}$$



## D.2 Random walks

The *network random walk*  $(Y_j)_{j \geq 0}$  on  $\mathbf{G}$  with initial state  $x_0$  is defined by  $Y_0 = x_0$  and jumps

$$\forall x, y \in \mathbf{V}^r, \quad P_{x,y} = \mathbb{P}_{x_0}[Y_{j+1} = y | Y_j = x] = \begin{cases} \frac{\rho^m(xy)}{\rho^m(x)} & \text{if } y \sim x, \\ 0 & \text{otherwise,} \end{cases}$$

where

$$\rho^m(x) = \sum_{y \in \mathbf{V}^r: y \sim x} \rho^m(xy) = \begin{cases} \sum_{y \in \mathbf{V}: y \sim x} \rho(xy) + m^2(x) & \text{if } x \neq r, \\ \sum_{y \in \mathbf{V}} m^2(y) & \text{if } x = r. \end{cases} \quad (73)$$

The Markov matrix  $P = (P_{x,y})$  is related to the Laplacian  $\Delta_r$  as follows: if  $A_r$  denotes the diagonal matrix whose entries are the diagonal entries of the Laplacian  $\Delta_r$ , then

$$P = I + (A_r)^{-1} \Delta_r. \quad (74)$$

This random walk is positive recurrent. The *potential*  $V_r(x, y)$  of this random walk is defined as the difference in expectation of the number of visits at  $y$  starting from  $x$  and from  $y$ :

$$V_r(x, y) = \mathbb{E}_x \left[ \sum_{j=0}^{\infty} \mathbb{I}_{\{Y_j=y\}} \right] - \mathbb{E}_y \left[ \sum_{j=0}^{\infty} \mathbb{I}_{\{Y_j=y\}} \right].$$

Although both sums separately are infinite, the difference makes sense and is finite, as can be seen by computing  $V_r(x, y)$  with a coupling of the random walks starting from  $x$  and  $y$ , where they evolve independently until they meet (in finite time a.s.), and stay together afterward.

Because  $(Y_j)$  is (positive) recurrent, the time  $\tau_r$  for  $(Y_j)$  to hit  $r$  is finite a.s. We can define the killed random walk  $(X_j) = (Y_{j \wedge (\tau_r - 1)})$ , absorbed at the root  $r$ . The process  $(X_j)$  visits only a finite number of vertices of  $\mathbf{G}$  before being absorbed: every vertex is thus transient. If  $x$  and  $y$  are two vertices of  $\mathbf{G}$ , then we can define the potential of  $(X_j)$ ,  $V^m(x, y)$ , as the expected number of visits at  $y$  of  $(X_j)$  starting from  $x$ , before it gets absorbed.  $V^m$  and  $V_r$  are linked by the formula below, which directly follows from the strong Markov property:

$$\forall x, y \in \mathbf{G}, \quad V^m(x, y) = V_r(x, y) - V_r(r, y). \quad (75)$$

As a matrix,  $V^m$  is equal to  $(I - Q^m)^{-1}$  where  $Q^m$  is the substochastic transition matrix for the killed process  $(X_j)$ . Given that  $Q^m = I - (A^m)^{-1} \cdot \Delta^m$ , where  $A^m$  is the diagonal matrix extracted from  $\Delta^m$ ,  $V^m$  is related to the Green function by the following formula:

$$V^m(x, y) = \frac{1}{A_{x,x}^m} (\Delta^m)^{-1}_{x,y} = \frac{G^m(x, y)}{\rho^m(x)}. \quad (76)$$

Another quantity related to the potential is the *transfer impedance matrix*  $\mathbf{H}$ , whose rows and columns are indexed by oriented edges of the graph. If  $e = (x, y)$  and  $e' = (x', y')$  are

two directed edges of  $G^r$ , the coefficient  $H(e, e')$  is the expected number of times that this random walk  $(Y_j)$ , started at  $x$  and stopped the first time it hits  $x$ , crosses the edge  $(x', y')$  minus the expected number of times that it crosses the edge  $(y', x')$ :

$$H(e, e') = [V_r(x, x') - V_r(y, x')]P_{x', y'} - [V_r(x, y') - V_r(y, y')]P_{y', x'}.$$

The quantity  $H(e, e')/\rho(e')$  is symmetric in  $e$  and  $e'$ , and is changed to its opposite if the orientation of one edge is reversed.

When  $e$  and  $e'$  are in fact edges of  $G$ , by (75) and the definition of the transition probabilities for the processes  $(Y_j)$  and  $(X_j)$ ,  $V_r(x, x') - V_r(y, x') = V^m(x, x') - V^m(y, x')$  and  $P_{x', y'} = Q_{x', y'} = \rho(x'y')/\rho^m(x)$  (and similarly when exchanging the roles of  $x'$  and  $y'$ ). Therefore,

$$\begin{aligned} H(e, e') &= [V^m(x, x') - V^m(y, x')]Q_{x', y'} - [V^m(x, y') - V^m(y, y')]Q_{y', x'} \\ &= \rho(x'y')[G^m(x, x') - G^m(y, x') - G^m(x, y') - G^m(y, y')]. \end{aligned} \quad (77)$$

If one of the vertices of  $e$  or  $e'$  is  $r$ , then the same formula holds if we replace  $G^m$  by  $\tilde{G}^m$ , *i.e.*, if we put to 0 all the terms involving the root  $r$ .

### D.3 Spanning forests on $G$ and spanning trees on $G^r$

Recall the definition of rooted spanning forests on  $G$  and spanning trees of  $G^r$  from Section 6.1. Kirchhoff's matrix-tree theorem [Kir47] states that spanning trees of  $G^r$  are counted by the determinant of  $\Delta_r^{(r)}$ , obtained from  $\Delta_r$  by deleting the row and column corresponding to  $r$ :

**Theorem 48** ([Kir47]). *The spanning forest partition function of the graph  $G$  is equal to:*

$$Z_{\text{forest}}(G, \rho, m) = \det \Delta_r^{(r)}.$$

Using the fact stated in Section D.1 that  $\Delta_r^{(r)} = \Delta^m$ , we exactly obtain Theorem 32.

The explicit expression for the Boltzmann measure of spanning trees is due to Burton and Pemantle [BP93]. Fix an arbitrary orientation of the edges of  $G^r$ .

**Theorem 49** ([BP93]). *For any distinct edges  $e_1, \dots, e_k$  of  $G^r$ , the probability that these edges belong to a spanning tree of  $G^r$  is:*

$$\mathbb{P}_{\text{tree}}(e_1, \dots, e_k) = \det(H(e_i, e_j))_{1 \leq i, j \leq k}.$$

Using the correspondence between edges (connected to  $r$ , or not) in the spanning tree of  $G^r$  and edges and roots for the corresponding rooted spanning forest of  $G$ , together with the expression of the transfer impedance matrix  $H$  in terms of the massive Green function on  $G$  from Equation (77), one exactly gets the statement of Theorem 33.

Due to the bijection between spanning trees on  $G^r$  and rooted spanning forests on  $G$ , the latter can be generated by Wilson's algorithm [Wil96] from the killed random walk  $(X_j)$ . Indeed, if we take  $r$  as starting point of the spanning tree, and construct its branches by loop erasing the random walk  $(Y_j)$ , the obtained trajectories are exactly loop erasures of  $(X_j)$ .

## D.4 Killed random walk on infinite graphs and convergence of the Green functions along exhaustions

In this section we define the killed random walk on an infinite graph  $\mathbf{G}$ , as well as its associated potential and Green function. We then prove (Lemma 50) that the Green functions associated to an exhaustion  $(\mathbf{G}_n)_{n \geq 1}$  of  $\mathbf{G}$  converge pointwise to the Green function of  $\mathbf{G}$ . Lemma 50 is an important preliminary result to Theorem 34.

In the case where  $\mathbf{G}$  is infinite, it is not possible to consider the network random walk  $(Y_j)$  on  $\mathbf{G}$ , the graph obtained from  $\mathbf{G}$  by adding the root  $r$  connected to the other vertices, because the degree of  $r$  is infinite and the conductances associated to edges connected to  $r$  are bounded from below by a positive quantity, and are thus not summable. However, it is possible to directly define the walk  $(X_j)$ , killed when it reaches  $r$ . Its transition probabilities are:

$$Q_{x,y}^m = \mathbb{P}(X_{j+1} = y | X_j = x) = \begin{cases} \frac{\rho(xy)}{\sum_{z \sim x} \rho(xz) + m^2(x)} & \text{if } y \text{ and } x \text{ are neighbors,} \\ 0 & \text{otherwise,} \end{cases} \quad (78)$$

and the probability of being absorbed at  $x$  is  $\overline{Q}_x^m = \mathbb{P}(X_{j+1} = r | X_j = x) = 1 - \sum_{xy \in E} Q_{x,y}^m$ .

Under the condition that the conductances and masses are uniformly bounded away from 0 and infinity (which is the case on isoradial graphs, as soon as  $k > 0$  and the angles of the rhombi are bounded away from 0 and  $\frac{\pi}{2}$ ), the probability of being absorbed at any given site is bounded from below by some uniform positive quantity. The process  $(X_j)$  is thus absorbed in finite time, and vertices of  $\mathbf{G}$  are transient. We will assume that this condition is fulfilled.

There is the same link (74) as in Section D.2 between the substochastic matrix  $Q^m = (Q_{x,y}^m)$  and the Laplacian  $\Delta^m$ .

The potential  $V^m$  of the discrete random walk  $(X_j)$  is a function on  $\mathbf{G} \times \mathbf{G}$  defined at  $(x, y)$  as the expected time spent at vertex  $y$  by the discrete random walk  $(X_j)$  started at  $x$  before being absorbed (below,  $\tau_r$  is defined as the first hitting time of  $r$ , as in Section D.2):

$$V^m(x, y) = \mathbb{E}_x \left[ \sum_{j=0}^{\tau_r-1} \mathbb{I}_{\{y\}}(X_j) \right]. \quad (79)$$

In Section D.5 we give the standard interpretation of the Green function in terms of continuous time random processes.

We now come to the convergence of the Green functions along an exhaustion of the graph. Let  $(\mathbf{G}_n)_{n \geq 1}$  be an exhaustion of the infinite graph  $\mathbf{G}$ . Let  $(Y_j^n)$  be the network random walk of  $\mathbf{G}_n$  and  $(X_j)$  be the killed random walk of  $\mathbf{G}$ . We introduce  $\tau_r^n = \inf\{j > 0 : Y_j^n = r\}$  and  $(X_j^n) = (Y_{j \wedge (\tau_r^n - 1)}^n)$ , the random walk on  $\mathbf{G}_n$ , killed at the vertex  $r$ . It is absorbed in finite time by  $r$ . Finally,  $\tau_{\partial \mathbf{G}_n} = \inf\{j > 0 : X_j^n \notin \mathbf{G}_n\} = \inf\{j > 0 : X_j \notin \mathbf{G}_n\}$  (if the starting point belongs to  $\mathbf{G}_n$ ) is the first exit time from the domain  $\mathbf{G}_n$ .

**Lemma 50.** *For any  $x, y \in \mathbf{V}$ , one has  $\lim_{n \rightarrow \infty} G_n^m(x, y) = G^m(x, y)$ .*

*Proof.* To use an interpretation with random walks, we prove Lemma 50 for the potential instead of the Green function; this is equivalent by (76). The potential function for the killed walk  $(X_j^n)$  is

$$V_n^m(x, y) = \mathbb{E}_x \left[ \sum_{j=0}^{\infty} \mathbb{I}_{\{y\}}(X_j^n) \right] = \mathbb{E}_x \left[ \sum_{j=0}^{\tau_r^n - 1} \mathbb{I}_{\{y\}}(Y_j^n) \right].$$

The potential  $V^m(x, y)$  for  $(X_j)$  is the same as above without the subscript  $n$ , see (79). One has

$$V_n^m(x, y) = \mathbb{E}_x \left[ \sum_{j=0}^{\tau_r^n - 1} \mathbb{I}_{\{y\}}(X_j^n); \tau_r^n < \tau_{\partial G_n} \right] + \mathbb{E}_x \left[ \sum_{j=0}^{\tau_r^n - 1} \mathbb{I}_{\{y\}}(X_j^n); \tau_r^n > \tau_{\partial G_n} \right].$$

In the first term we replace  $X_j^n$  by  $X_j$  (as  $x \in G_n$ ),  $\tau_r^n$  by  $\tau_r$ , and we use the monotone convergence theorem (as  $n \rightarrow \infty$ ,  $\tau_{\partial G_n} \rightarrow \infty$  monotonously). The first term goes to  $V^m(x, y)$ . We now prove that the second term goes to 0 as  $n \rightarrow \infty$ . It is less than  $\mathbb{E}_x[\tau_r^n; \tau_r^n > \tau_{\partial G_n}]$ . Conductances and masses are bounded away from 0 and  $\infty$ , so  $\tau_r^n$  is integrable and dominated by a geometric random variable not depending on  $n$ . We conclude since  $\tau_{\partial G_n} \rightarrow \infty$ .  $\square$

## D.5 Laplacian operators and continuous time random processes

In this section we briefly recall the probabilistic interpretation of the Laplacian  $\Delta^m$  on the infinite graph  $G$  (introduced in (10) of Section 3.1). A similar interpretation holds for Laplacian operators on other graphs (like on the finite graphs of Section D.2).

The Laplacian  $\Delta^m$  is the generator of a continuous time Markov process  $(X_t)$  on  $G$ , augmented with an absorbing state (the *root*  $r$ ): when at  $x$  at time  $t$ , the process waits an exponential time (with parameter equal to the diagonal coefficient  $d_x$ ), and then jumps to a neighbor of  $x$  with probability (78). For the same reasons as for  $(X_j)$  and under the same hypotheses, the random process  $(X_t)$  will be absorbed by the vertex  $r$  in finite time.

The matrix  $Q^m$  in (78) is a substochastic matrix, corresponding to the discrete time counterpart  $(X_j)$  of  $(X_t)$ , just tracking the jumps. The Green function  $G^m(x, y)$  represents the total time spent at  $y$  by the process  $(X_t)$  started at  $x$  at time  $t = 0$  before being absorbed.

## References

- [ABS03] V. E. Adler, A. I. Bobenko, and Yu. B. Suris. Classification of integrable equations on quad-graphs. The consistency approach. *Comm. Math. Phys.*, 233(3):513–543, 2003.
- [ACGH85] Enrica Arbarello, Maurizio Cornalba, Philipp A. Griffiths, and Joseph Harris. *Geometry of algebraic curves. Vol. I*, volume 267 of *Grundlehren der Mathematischen Wissenschaften [Fundamental Principles of Mathematical Sciences]*. Springer-Verlag, New York, 1985.
- [AS64] Milton Abramowitz and Irene A. Stegun. *Handbook of mathematical functions with formulas, graphs, and mathematical tables*, volume 55 of *National Bureau of Standards Applied Mathematics Series*. For sale by the Superintendent of Documents, U.S. Government Printing Office, Washington, D.C., 1964.

- [AYP02] Helen Au-Yang and Jacques H.H. Perk. Correlation functions and susceptibility in the  $Z$ -invariant Ising model. In Masaki Kashiwara and Tetsuji Miwa, editors, *MathPhys Odyssey 2001*, volume 23 of *Progress in Mathematical Physics*, pages 23–48. Birkhäuser Boston, 2002.
- [Bax78] Rodney J. Baxter. Solvable eight-vertex model on an arbitrary planar lattice. *Philosophical Transactions of the Royal Society of London A: Mathematical, Physical and Engineering Sciences*, 289(1359):315–346, 1978.
- [Bax86] Rodney J. Baxter. Free-fermion, checkerboard and  $Z$ -invariant lattice models in statistical mechanics. *Proc. Roy. Soc. London Ser. A*, 404(1826):1–33, 1986.
- [Bax89] Rodney J. Baxter. *Exactly solved models in statistical mechanics*. Academic Press Inc. [Harcourt Brace Jovanovich Publishers], London, 1989. Reprint of the 1982 original.
- [BdT10] Cédric Boutillier and Béatrice de Tilière. The critical  $Z$ -invariant Ising model via dimers: the periodic case. *Probab. Theory Related Fields*, 147:379–413, 2010.
- [BdT11] Cédric Boutillier and Béatrice de Tilière. The critical  $Z$ -invariant Ising model via dimers: locality property. *Comm. Math. Phys.*, 301(2):473–516, 2011.
- [BFR08] Olivier Bodini, Thomas Fernique, and Éric Rémila. A characterization of flip-accessibility for rhombus tilings of the whole plane. *Inform. and Comput.*, 206(9-10):1065–1073, 2008.
- [BLPS01] Itai Benjamini, Russell Lyons, Yuval Peres, and Oded Schramm. Uniform spanning forests. *Ann. Probab.*, 29(1):1–65, 2001.
- [BMS05] Alexander I. Bobenko, Christian Mercat, and Yuri B. Suris. Linear and nonlinear theories of discrete analytic functions. Integrable structure and isomonodromic Green’s function. *J. Reine Angew. Math.*, 583:117–161, 2005.
- [BP93] Robert Burton and Robin Pemantle. Local characteristics, entropy and limit theorems for spanning trees and domino tilings via transfer-impedances. *Ann. Probab.*, 21(3):1329–1371, 1993.
- [Bru14] Erwan Brugallé. Pseudoholomorphic simple Harnack curves. *Enseign. Math.*, 2014. to appear.
- [BS08] Alexander I. Bobenko and Yuri B. Suris. *Discrete differential geometry*, volume 98 of *Graduate Studies in Mathematics*. American Mathematical Society, Providence, RI, 2008. Integrable structure.
- [CD13] David Cimasoni and Hugo Duminil-Copin. The critical temperature for the Ising model on planar doubly periodic graphs. *Electron. J. Probab.*, 18:no. 44, 1–18, 2013.
- [Cop65] Edward T. Copson. *Asymptotic expansions*. Cambridge Tracts in Mathematics and Mathematical Physics, No. 55. Cambridge University Press, New York, 1965.
- [CT79] Roger J. Cook and Alan D. Thomas. Line bundles and homogeneous matrices. *The Quarterly Journal of Mathematics*, 30(4):423–429, 1979.
- [dB81a] Nicolaas G. de Bruijn. Algebraic theory of Penrose’s non-periodic tilings of the plane. I. *Indagationes Mathematicae (Proceedings)*, 84(1):39–52, 1981.
- [dB81b] Nicolaas G. de Bruijn. Algebraic theory of Penrose’s non-periodic tilings of the plane. II. *Indagationes Mathematicae (Proceedings)*, 84(1):53–66, 1981.

- [dT07] Béatrice de Tilière. Quadri-tilings of the plane. *Probab. Theory Related Fields*, 137(3-4):487–518, 2007.
- [Duf68] Richard J. Duffin. Potential theory on a rhombic lattice. *J. Combinatorial Theory*, 5:258–272, 1968.
- [GKZ94] Izrail’ M. Gel’fand, Mikhail M. Kapranov, and Andrei V. Zelevinsky. *Discriminants, resultants, and multidimensional determinants*. Mathematics: Theory & Applications. Birkhäuser Boston, Inc., Boston, MA, 1994.
- [Ken99] Arthur E. Kennelly. The equivalence of triangles and three-pointed stars in conducting networks. *Electrical World and Engineer*, 34:413–414, 1899.
- [Ken93] Richard Kenyon. Tiling a polygon with parallelograms. *Algorithmica*, 9(4):382–397, 1993.
- [Ken02] Richard Kenyon. The Laplacian and Dirac operators on critical planar graphs. *Invent. Math.*, 150(2):409–439, 2002.
- [Ken04] Richard Kenyon. An introduction to the dimer model. In *School and Conference on Probability Theory*, ICTP Lect. Notes, XVII, pages 267–304 (electronic). Abdus Salam Int. Cent. Theoret. Phys., Trieste, 2004.
- [Kir47] Gustav Kirchhoff. Ueber die auflösung der gleichungen, auf welche man bei der untersuchung der linearen vertheilung galvanischer ströme geführt wird. *Annalen der Physik*, 148:497–508, 1847.
- [KO06] Richard Kenyon and Andrei Okounkov. Planar dimers and Harnack curves. *Duke Math. J.*, 131(3):499–524, 2006.
- [KS05] Richard Kenyon and Jean-Marc Schlenker. Rhombic embeddings of planar quad-graphs. *Trans. Amer. Math. Soc.*, 357(9):3443–3458 (electronic), 2005.
- [Law89] Derek F. Lawden. *Elliptic functions and applications*, volume 80 of *Applied Mathematical Sciences*. Springer-Verlag, New York, 1989.
- [Li12] Zhongyang Li. Critical temperature of periodic Ising models. *Comm. Math. Phys.*, 315:337–381, 2012.
- [Lis14] Marcin Lis. Phase transition free regions in the Ising model via the Kac–Ward operator. *Comm. Math. Phys.*, 331(3):1071–1086, 2014.
- [Mer01] Christian Mercat. Discrete Riemann surfaces and the Ising model. *Comm. Math. Phys.*, 218(1):177–216, 2001.
- [Mer04] Christian Mercat. Exponentials form a basis of discrete holomorphic functions on a compact. *Bull. Soc. Math. France*, 132(2):305–326, 2004.
- [MR01] G. Mikhalkin and H. Rullgård. Amoebas of maximal area. *International Mathematics Research Notices*, 2001(9):441, 2001.
- [Nat90] Sergey M. Natanzon. Klein surfaces. *Russian Mathematical Surveys*, 45(6):53–108, 1990.
- [Ons44] Lars Onsager. Crystal statistics. I. A two-dimensional model with an order-disorder transition. *Phys. Rev.*, 65(3-4):117–149, Feb 1944.
- [PAY06] Jacques H. H. Perk and Helen Au-Yang. Yang–Baxter equations. In Jean-Pierre Francoise, Gregory L. Naber, and Tsou Sheung Tsun, editors, *Encyclopedia of Mathematical Physics*, pages 465 – 473. Academic Press, Oxford, 2006.

- [PW13] Robin Pemantle and Mark C. Wilson. *Analytic combinatorics in several variables*, volume 140 of *Cambridge Studies in Advanced Mathematics*. Cambridge University Press, Cambridge, 2013.
- [Thu90] William P. Thurston. Conway’s tiling groups. *Amer. Math. Monthly*, 97(8):757–773, 1990.
- [Vir02] Oleg Viro. What is an amoeba? *Notices of the AMS*, 49(8):916–917, 2002.
- [Wil96] David Bruce Wilson. Generating random spanning trees more quickly than the cover time. In *Proceedings of the Twenty-eighth Annual ACM Symposium on the Theory of Computing (Philadelphia, PA, 1996)*, pages 296–303. ACM, New York, 1996.