

Dark matter search in a Beam-Dump eXperiment (BDX) at Jefferson Lab

The BDX Collaboration

M. Battaglieri*[†], A. Bersani, A. Celentano[†], R. De Vita[†], E. Fanchini, S. Fegan, P. Musico,
M. Osipenko, M. Ripani, E. Santopinto, M. Taiuti
*Istituto Nazionale di Fisica Nucleare, Sezione di Genova
e Dipartimento di Fisica dell'Università, 16146 Genova, Italy*

E. Izaguirre[†], G. Krnjaic[†], P. Schuster, N. Toro
Perimeter Institute for Theoretical Physics, Waterloo, Ontario, Canada, N2L 2Y5

M. Dalton, A. Freyberger, F.-X. Girod, V. Kubarovsky, E. Smith[†], S. Stepanyan[†], M. Ungaro
Jefferson Lab, Newport News, VA 23606, USA

G. De Cataldo, R. De Leo, D. Di Bari, L. Lagamba, E. Nappi, R. Perrino
Istituto Nazionale di Fisica Nucleare, Sezione di Bari e Dipartimento di Fisica dell'Università, Bari, Italy

M. Carpinelli, V. Sipala
Università di Sassari e Istituto Nazionale di Fisica Nucleare, 07100 Sassari, Italy

S. Aiello, V. Bellini, M. De Napoli, A. Giusa, F. Mammoliti, E. Leonora, F. Noto, N. Randazzo,
G. Russo, M. Sperduto, C. Sutera, C. Ventura
Istituto Nazionale di Fisica Nucleare, Sezione di Catania, Catania, Italy

L. Barion, G. Ciullo, M. Contalbrigo, P. Lenisa, A. Movsisyan, F. Spizzo, M. Turisini
*Istituto Nazionale di Fisica Nucleare, Sezione di Ferrara e Dipartimento di Fisica dell'Università, Ferrara,
Italy*

F. De Persio, E. Cisbani, C. Fanelli, F. Garibaldi, F. Meddi, G. M. Urciuoli
*Istituto Nazionale di Fisica Nucleare, Sezione di Roma e Gruppo Collegato Sanità, e Università La
Sapienza, Italy*

S. Anefalos Pereira, E. De Sanctis, D. Hasch, V. Lucherini, M. Mirazita, R. Montgomery,
S. Pisano
Istituto Nazionale di Fisica Nucleare, Laboratori Nazionali di Frascati, P.O. 13, 00044 Frascati, Italy

G. Simi
Istituto Nazionale di Fisica Nucleare, Sezione di Padova, Padova, Italy

*Contact Person, email: Marco.Battaglieri@ge.infn.it

[†]Spokesperson

A. D'Angelo, L. Colaneri, L. Lanza, A. Rizzo, C. Schaerf, I. Zonta
*Istituto Nazionale di Fisica Nucleare, Sezione di Roma-Tor Vergata e Dipartimento di Fisica
dell'Università, Roma, Italy*

D. Calvo, A. Filippi
Istituto Nazionale di Fisica Nucleare, Sezione di Torino, Torino, Italy

M. Holtrop, R. Peremuzyan
University of New Hampshire, Durham NH 03824, USA

D. Glazier, D. Ireland, B. McKinnon, D. Sokhan
University of Glasgow, Glasgow G12 8QQ, United Kingdom

A. Afanasev, B. Briscoe
The George Washington University, Washington, D.C., 20052

N. Kalantarians
Department of Physics, Hampton University, Hampton VA 23668, USA

L. El Fassi, L. Weinstein
Old Dominion University, Department of Physics, Norfolk VA 23529, USA

P. Beltrame, A. Murphy, D. Watts, L. Zana
Edinburgh University, Edinburgh EH9 3JZ, United Kingdom

K. Hicks
Ohio University, Department of Physics, Athens, OH 45701, USA

Abstract

MeV-GeV dark matter (DM) is theoretically well motivated but remarkably unexplored. This Letter of Intent presents the MeV-GeV DM discovery potential for a 1 m^3 segmented plastic scintillator detector placed downstream of the beam-dump at one of the high intensity JLab experimental Halls, receiving up to 10^{22} electrons-on-target (EOT) in a one-year period. This experiment (Beam-Dump eXperiment or BDX) is sensitive to DM-nucleon elastic scattering at the level of a thousand counts per year, with very low threshold recoil energies ($\sim 1 \text{ MeV}$), and limited only by reducible cosmogenic backgrounds. Sensitivity to DM-electron elastic scattering and/or inelastic DM would be below 10 counts per year after requiring all electromagnetic showers in the detector to exceed a few-hundred MeV, which dramatically reduces or altogether eliminates all backgrounds. Detailed Monte Carlo simulations are in progress to finalize the detector design and experimental set up. An existing 0.036 m^3 prototype based on the same technology will be used to validate simulations with background rate estimates, driving the necessary R&D towards an optimized detector. The final detector design and experimental set up will be presented in a full proposal to be submitted to the next JLab PAC. A fully realized experiment would be sensitive to large regions of DM parameter space, exceeding the discovery potential of existing and planned experiments by two orders of magnitude in the MeV-GeV DM mass range.

Contents

1	Overview	4
2	Direct dark matter search in beam-dump experiments	5
2.1	Physics motivations	5
2.2	Light dark matter models and theory of production and detection	7
2.3	Future beam-dump experiments	9
2.4	A beam-dump experiment at JLab	11
3	A study case: CORMORINO and JLab Hall-D beam-dump	11
3.1	The CORMORINO detector	12
3.2	The Hall-D beam-dump	14
3.3	Simulations of the experimental set-up	14
3.3.1	χ production and χ -p elastic scattering in CORMORINO	14
3.3.2	Beam-related background	16
3.3.3	Beam-unrelated backgrounds	17
3.3.4	Summary	22
4	Towards a full scale experiment: BDX	23
4.1	The full experiment	23
4.1.1	BDX expected reach	23
4.1.2	Systematic checks	24
4.2	Planned R&D	25
5	Summary and Conclusion	27

1 Overview

In this letter we present the potential of a beam-dump experiment to search for light (MeV-GeV) Dark Matter (DM). DM in this mass range is motivated by both experimental and theoretical considerations. Simple extensions to the Standard Model (SM) can accommodate DM-SM interactions that yield the observed DM cosmological abundance. Such models also generically feature particles that explain the currently discrepant value of the muon’s anomalous magnetic moment and resolve anomalies in astrophysical observations, while simultaneously evading cosmological and direct-production constraints. The physics motivations for light DM are presented in detail in Sec. 2.1.

This experiment could be performed by placing a detector downstream of one of the JLab experimental Halls to measure DM particles that could be produced by the electron beam in the dump, pass through surrounding shielding material, and deposit visible energy inside the detector by scattering off various target particles or (if unstable) by decaying inside the detector volume. The run would be completely parasitic without affecting the normal operations and the physics program of the Hall. To detect the small signal produced by a light DM particle (mass of tens of MeV) scattering off a nucleon, the detection thresholds need to be fixed at values as low as possible (\sim MeV). On the other hand, low thresholds can introduce spurious signals from beam-related (neutrinos) and cosmogenic background (muons, neutrons and neutrinos), limiting the measurement sensitivity. Other processes such as elastic scattering off atomic electrons and inelastic DM interaction lead to scattered electrons with energy of few GeV that could be easily detected over a null background. Due to the sensitivity to these different DM signals, BDX exceeds the sensitivity of other experiments proposed at FNAL, CERN, and LNF.

The goal of the BDX Collaboration is to propose a search for light DM particles produced with electron beams. This experimental approach is capable of covering new theoretically motivated ground in the parameter space of light DM. The design and simulation of such a facility at Jefferson Lab is not yet complete and this LOI presents the studies to date that will serve as a basis for a complete proposal. To achieve the desired sensitivity, the ultimate experiment must be mounted behind a high-intensity hall, likely Hall A. However, the sensitivity of the experiment to signal and capability to reject backgrounds in this LOI is obtained by scaling up the results of a detailed case study based on an existing detector, CORMORINO.

The CORMORINO case study was performed under the assumption that the detector would be located downstream of the Hall-D beam-dump. The initial intent was to use that configuration as a practical intermediate stepping stone by exploiting the inexpensive opportunity offered to us by the above-ground Hall D beam-dump. This case study is described in detail here, as it represents a fairly complete simulation of backgrounds and challenges faced by the final experiment. Results of GEANT4 Monte Carlo simulations to describe the effect of the beam-dump and the detector response are reported in Sec. 3.3. Based on the same simulations, results of a detailed study of processes contributing to the backgrounds with threshold down to 1 MeV are reported in the succeeding subsections. Projections, counting rates for signal and background scaled to the full experiment, and the expected reach of BDX compared to similar experiments are reported in the last Sec. 4.

The outcome of the case study is that the dominant backgrounds to a beam dump experiment at a high-duty-cycle machine are not beam related. Therefore, tests to determine the capabilities of a detector to reject backgrounds need not be performed in the vicinity of an electron beam dump, and can be optimized at a more convenient location. We plan to fully characterize and measure the cosmogenic background with CORMORINO to validate simulations and optimize the location and the detector design for the full-scale experiment. The planned R&D, as well as a list of possible

topics we want to investigate, is reviewed in the last Section.

The goal of this LOI is to request guidance from the PAC on our continued effort to develop a full proposal at a later date. First, we seek endorsement of the physics goals of this research project. Second, we welcome input on interfaces with facility infrastructure that are required near existing experimental areas and comments on our program to determine the best detector for the DM search.

2 Direct dark matter search in beam-dump experiments

2.1 Physics motivations

Although overwhelming astrophysical and cosmological evidence supports the existence of DM, its elementary properties remain largely elusive. The expectation that dark matter has some kind of interaction with Standard Model matter is strongly motivated by two possible mechanisms to explain its origin – either as an annihilation product of thermal Standard Model matter in the early Universe, or as a product of the same unknown processes that generate the baryon asymmetry. There is currently an active program to probe particle DM scattering with direct detection experiments, annihilation with indirect detection telescopes, and production with particle accelerators. However, most of these efforts are designed to find heavy (10–1000 GeV) DM candidates and sharply lose sensitivity to lighter (sub-GeV) states whose signals are either too feeble to detect or lie in high-background regions.

In fact, dark matter candidates are readily motivated in the entire MeV-to-TeV range. Much heavier dark matter is disfavoured because its naive thermal abundance exceeds the observed cosmological matter density. Much beneath an MeV, astrophysical and cosmological constraints allow only dark matter with ultra-weak couplings to quarks and leptons [1]. Between these boundaries (MeV - TeV), simple models of dark matter can account for its observed abundance through either thermal freeze-out or non-thermal mechanisms. The importance of broadening the experimental search program to include the MeV-GeV mass range is underscored by the lack of evidence for weak-scale ($\gtrsim 100$ GeV) dark matter scattering through Z bosons, ever stronger constraints on Higgs mediated scattering, and by the absence to date of evidence for new SM-charged matter at the LHC.

The status of experimental searches for MeV–TeV dark matter can be summarized as follows. The best constraints on multi-GeV dark matter interactions are from underground searches for nuclei recoiling off non-relativistic dark matter particles in the Galactic halo. However these searches are insensitive to few-GeV or lighter dark matter, whose nuclear scattering transfers invisibly small kinetic energy to a recoiling nucleus. Direct detection using electron-scattering offers an alternative strategy to search for sub-GeV dark matter, but with dramatically higher backgrounds [2, 3, 4]. Among the best-motivated models of MeV-to-GeV-mass dark matter are those whose interactions with ordinary matter are mediated by new GeV-scale ‘*dark*’ force carriers (for example, a gauge boson that kinetically mixes with the photon) [5, 6, 7, 8]. Such models readily account for the stability of dark matter and its observed relic density are compatible with all observations, and have important implications beyond the dark matter itself. In these scenarios, dark matter production at high-energy accelerators is generically buried under QCD background, making collider searches for light dark matter insensitive.

Dark matter in the MeV – GeV range is therefore still relatively unexplored, and has been a topic of considerable recent interest (see e.g. [1] and references therein, and [9, 10, 11, 12]). The sensitivity of past, ongoing, and proposed experiments to dark sector scenarios where dark matter interacts with the Standard Model through a kinetically mixed vector boson, A' , is illustrated in Figure 1,

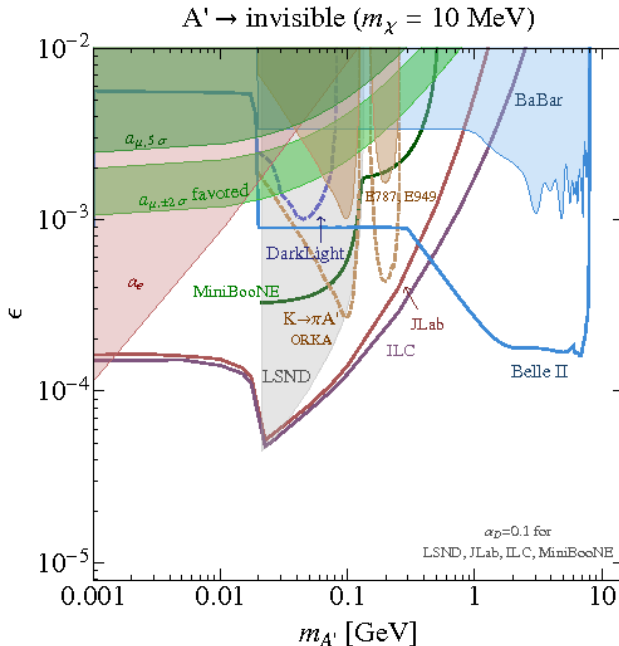

Figure 1: The international effort to search for GeV-scale dark matter and invisibly decaying vector mediators is partially summarized in the Report of the Community Summer Study 2013 (Snowmass) "New, Light, Weakly-Coupled Particles" subgroup [1], with additional references therein. In the above plot, representative sensitivity of several approaches is illustrated in the parameter space of mediator coupling ϵ vs. mediator mass $m_{A'}$ for invisible decays of the mediator into dark matter candidates. The approaches include rare meson decay studies, proton and electron beam fixed target and B-factory collider searches. Shaded regions denote constraints from past experiments (LSND, muon and electron $g - 2$, and BaBar) and the region favoured by the muon $g - 2$ anomaly (lower green band); dashed lines correspond to potential sensitivities for proposed/future experiments. Importantly, the approaches shown *cannot* be compared model-independently, and this plot is only representative of a particular parameter point in the kinetic mixing model of [1].

originally from [1] (we note that the sensitivity for a “generic” JLAB experiment anticipated in [1] is somewhat weaker, depending on A' mass, than the sensitivity of the experiment proposed in this Letter of Intent and presented in the last section). While this figure illustrates the power and complementarity of the various experiments, it is of limited use for comparing experiments that use different search techniques, whose sensitivities change considerably for different parameter choices or model assumptions.

The considerable sensitivity of beam-dump experiments to light dark matter is underscored by the reach of existing neutrino experiments [13, 14, 15, 9, 1]. For example, the LSND measurement of electron-neutrino scattering [16] can be used to derive the most stringent constraints to date on the parameter space for invisibly-decaying dark mediators that couple to both baryons and leptons [14]. That experiment delivered $\sim 10^{23}$ 800 MeV protons to the LANSCE beam-dump. For very low mass A' s and dark matter sufficiently light ($100\text{MeV} \lesssim m_{A'} \lesssim 2m_\chi$), the produced neutral pions have a small exotic decay into A' s which then decay to χ . The χ can then scatter off electrons in the LSND detector via A' -exchange. However, the sensitivity of LSND vanishes if the mediator couples only to leptons or baryons and is weakened if its coupling to either is suppressed. Relatedly, MiniBooNE is currently being used to search for light dark matter in a dedicated run of the BooNE

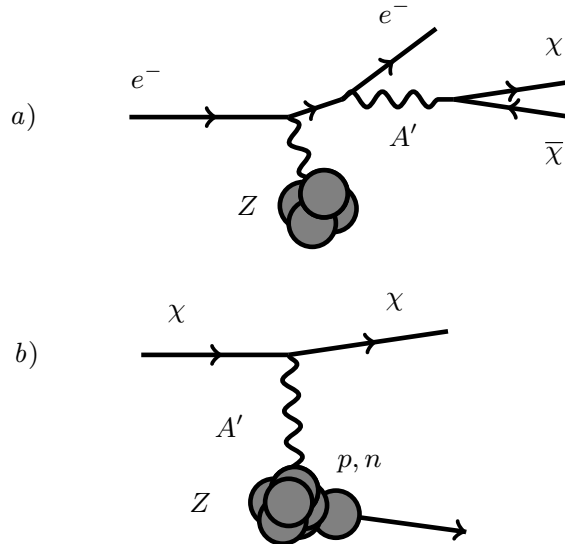

Figure 2: a) $\chi\bar{\chi}$ pair production in electron-nucleus collisions via the Cabibbo-Parisi radiative process (with A' on- or off-shell) and b) χ scattering off a detector nucleus and liberating a constituent nucleon. For the momentum transfers of interest, the incoming χ resolves the nuclear substructure, so the typical reaction is quasi-elastic and nucleons will be ejected.

proton beam at FNAL [17].

Recently it was shown that electron-beam fixed target experiments offer powerful sensitivity to a broad class of dark sector scenarios with particle dark matter in the MeV – GeV mass range [18, 10, 11]. Electron beam-dump experiments are complementary to dedicated efforts at proton beam facilities, have comparable DM scattering yield, can run parasitically and on a smaller scale than proton-beam counterparts, and benefit from negligible beam-related backgrounds. Such searches can dramatically improve sensitivity to MeV-to-GeV mass dark matter and other long-lived weakly coupled particles, extending well beyond the reach of proposed neutrino-factory experiments and Belle-II projections. The power of electron beam dump experiments in this context is illustrated by the existing sensitivity of the SLAC E137 experiment [19]. That experiment was sensitive to invisibly decaying dark mediators produced in fixed target collisions involving 20 GeV electrons and the E137 beam-dump [20]. Despite the rather high energy threshold (~ 3 GeV) required to see secondary scattering of dark matter particles off electrons, and the small geometric acceptance, E137 has already probed mediator mixings beyond that probed by proton beam-dumps at intermediate masses. In a year of parasitic running, BDX will receive roughly 100 times the charge deposited on E137, with a comparable solid angle, higher-density detector, and lower energy threshold.

2.2 Light dark datter models and theory of production and detection

Whether the dark sector is quite simple or has a rich sector of light particles, the fixed-target phenomenology of stable χ s (or unstable χ s with lab-frame lifetimes $\gtrsim \mu$ s) is usually well-described by the simplest case — a renormalizable $U(1)_D$ dark sector with a single stable matter particle χ .

For fermionic χ and $U(1)_D$ coupling to Standard Model matter via kinetic mixing [‡],

$$\mathcal{L}_{dark} = -\frac{1}{4}F'_{\mu\nu}F'^{\mu\nu} + \frac{\epsilon_Y}{2}F'_{\mu\nu}B_{\mu\nu} + \frac{m_{A'}^2}{2}A'_\mu A'^\mu + \bar{\chi}(i\not{D} - m_\chi)\chi, \quad (1)$$

where $B_{\mu\nu} = B_{[\mu,\nu]}$ and $F'_{\mu\nu} = A'_{[\mu,\nu]}$ are respectively the hypercharge and dark-photon field strengths and $D_\mu = \partial_\mu + ig_D A'_\mu$ (and similarly for scalar χ).

The kinetic mixing parameter ϵ_Y can arise generically from loops of heavy particles charged under both hypercharge and $U(1)_D$ and is naturally small, on the scale of $\frac{\epsilon g_D}{16\pi^2} \log(M/\Lambda) \sim 10^{-5} - 10^{-2}$, where M is the mass of the particle in the loop and Λ the theory cutoff scale. It will be convenient to take as a free parameter $\epsilon \equiv \epsilon_Y \cos\theta_W$ (where θ_W is the weak mixing angle), rather than ϵ_Y itself.

Upon diagonalizing the kinetic mixing terms in (1), ordinary electrically charged matter acquires a “dark millicharge” coupling to the A' of strength ϵe , while the χ remains electrically neutral. As a consequence, long-lived dark sector particles χ couple to ordinary matter primarily through A' exchange.

In this theory, χ s can therefore be pair-produced radiatively in electron-nucleus collisions in the dump (see Fig. 2a). A fraction of these relativistic particles then scatter off nucleons, nuclei, or electrons in the detector volume (see Fig. 2b).

If $m_{A'} < 2m_\chi$, the dominant χ production mechanism in an electron fixed-target experiment is the radiative process illustrated in Fig. 2a) with off-shell A' . In this regime, the χ production yield scales as $\sim \alpha_D \epsilon^2 / m_\chi^2$ ($\alpha_D \equiv g_D^2 / 4\pi$), while χ -nucleon scattering in the detector via A' exchange (see Fig. 2b)) occurs with a rate proportional to $\alpha_D \epsilon^2 / m_{A'}^2$, over most of the mass range. Thus, the total signal yield scales as

$$N_\chi \sim \frac{\alpha_D^2 \epsilon^4}{m_\chi^2 m_{A'}^2}. \quad (2)$$

If $m_{A'} > 2m_\chi$, the secondary χ -beam arises from radiative A' production followed by $A' \rightarrow \bar{\chi}\chi$ decay. In this regime, the χ production and the detector scattering rates are respectively proportional to $\epsilon^2 / m_{A'}^2$ and $\alpha_D \epsilon^2 / m_{A'}^2$, and the signal yield scales as

$$N_\chi \sim \frac{\alpha_D \epsilon^4}{m_{A'}^4}. \quad (3)$$

Thus, for each α_D and $m_{A'}$, we can extract an ϵ -sensitivity corresponding to a given scattering yield. The characteristic momentum transfer in χ -matter interactions is of order the A' mass. For A' masses from tens to hundreds of MeV, χ can scatter coherently off a nucleus (with a Z^2 -enhanced cross-section, but the lowest energy transfers and therefore highest radiological backgrounds) or eject a nucleon through a quasi-elastic scattering reaction $\chi p, n \rightarrow \chi p, n$, with characteristic recoil energy $E_R \sim m_{A'}^2 / 2m_N \sim 1 - 50$ MeV. Resonant single-pion and non-resonant double-pion production processes may also have appreciable yields, particularly for higher A' masses.

A second signal which is slightly sub-dominant but of considerable experimental importance is χ -electron scattering. Because the electron is light and the χ are energetic, scattered electrons typically carry GeV-scale energy and are therefore subject to much lower backgrounds than nucleon scattering. Figure 3 shows the lepton recoil energy for different choices of m_χ and $M_{A'}$. Indeed, for models with kinetically mixed mediators which produce both electron- and nucleon-scattering signals, it is likely that electron-recoil searches at BDX will have the greatest sensitivity. At the

[‡]We focus in this letter on fermionic χ , but the same approach is sensitive to scalar χ as well. Generalizations to $U(1)_D$ coupling to baryonic or leptonic currents have more dramatic effects on the phenomenology.

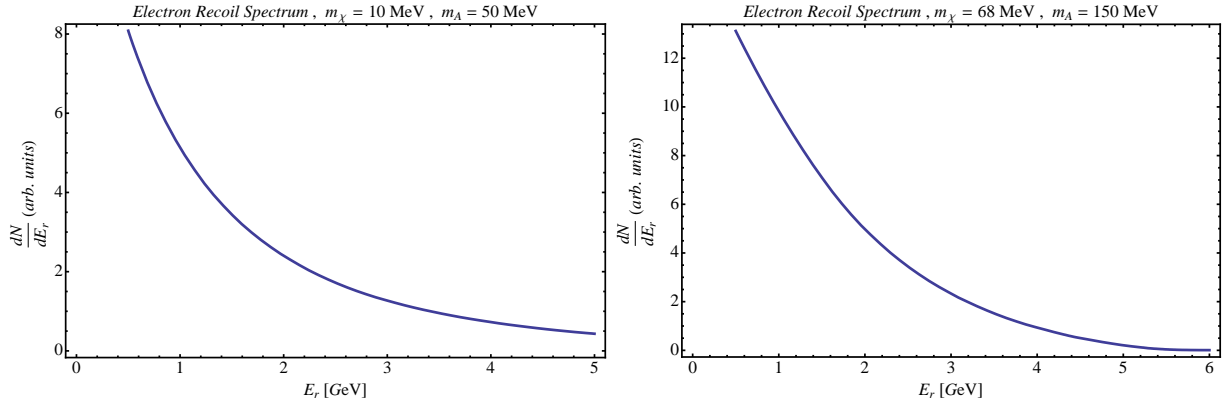

Figure 3: Energy distributions of scattered electrons for two choices of m_χ and $m_{A'}$.

same time, other models appear to have distinctive signals primarily in nucleon-scattering, for which BDX’s unique sensitivity to nuclear recoils is ideal.

To close this discussion of dark matter models and their signals, we comment on a simple and well-motivated generalization of the model introduced in (1). The dark matter particle χ , which in (1) was given a Dirac mass, can further acquire a Majorana mass — for example, from a coupling to the $U(1)_D$ Higgs field — as in [21]. The Majorana mass term splits χ into two mass eigenstates (χ and ψ) with a mass splitting Δ ; this theory has an $A' - \chi - \psi$ interaction, but no mass-diagonal A' couplings. As a result, (a) the electron beam produces $\chi\psi$ pairs, (b) for sufficiently large mass splittings Δ , the ψ decays promptly to χe^+e^- , and (c) the χ -scattering processes in the detector are inelastic (e.g. $\chi p \rightarrow \psi p$), with a total deposited energy that is often dominated by the energetic e^+e^- pair from the subsequent ψ decay. Like the electron scattering process, this inelastic scattering signal can be searched for with very low background rates.

2.3 Future beam-dump experiments

Many experiments have been performed searching for an A' boson with mass in the range 1 – 1000 MeV and coupling, ε , in the range $10^{-5} - 10^{-2}$. Several different and complementary approaches were adopted (for a summary, see [22] and references therein), but no positive result was found so far. All exclusion limits are based on the assumption that dark-photons decay to e^+e^- only or, alternatively, that they couple with the same strength to all fermions

If other A' decay modes are accessible, counts associated to visible decay would scale as $\varepsilon^4\alpha/\alpha_D$ rather than ε^2 , and the A' width would increase. Accounting for both effects, none of previous searches implies bounds on the coupling constant stronger than $\varepsilon^2 \simeq 10^{-3}$. For similar reasons, the beam-dump limits on weakly coupled A' , that rely on an ε^2 -suppressed A' width, do not apply. Experiments searching for *invisible* A' decays are therefore of particular interest being complementary to the experimental program searching for dark-photon: a full test of the dark sectors idea requires in fact searches sensitive to **all** possible A' decays, visible and invisible. Moreover, important regions of the parameter space where an A' can explain the $g - 2$ anomaly are still viable for A' invisible decay channels, and these can be explored by BDX. The improved sensitivity of BDX over other experiments will allow BDX to explore $g - 2$ parameter space at smaller values of α_D than are currently probed (by E137 for example). Below, a list of experiments that were recently proposed is reported.

The PADME [23] experiment proposes a search for invisible A' decays in the process $e^+e^- \rightarrow A'\gamma$. The 510 MeV positrons from the DAΦNE LINAC would scatter on atomic electrons of a thick target,

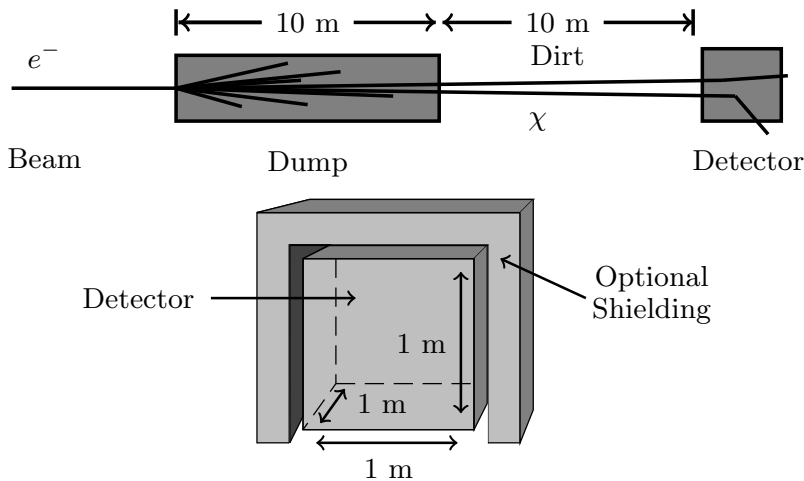

Figure 4: Schematic of the experimental setup. A high-intensity multi-GeV electron beam impinging on a beam-dump produces a secondary beam of dark sector states. In the basic setup, a small detector is placed downstream with respect to the beam-dump so that muons and energetic neutrons are entirely ranged out.

and only the final state photon would be detected. The A' is thus reconstructed via the final state photon missing mass. The A' mass range that can be explored is limited to 22.8 MeV due to the small energy available in the center-of-mass frame. Nevertheless, with $10^{13} - 10^{14}$ positrons on target per year, PADME would set a limit down to $10^{-8} - 10^{-9}$ in ε^2 , without making *any* assumption on the A' decay, and thus exploring a completely unknown region of the parameters space. A similar experiment has been proposed at the VEPP-3 storage ring [25], with 500 MeV positrons impinging on an gas hydrogen internal target, detecting the final state photon only. In 6 months of run at a luminosity of $10^{32} \text{ cm}^{-2} \text{ s}^{-1}$, the experiment can explore the parameter space region below $m_{A'} \simeq 20$ MeV and down to $\varepsilon^2 \simeq 10^{-8}$.

A recently proposed experiment at CERN SPS [26] would also search for invisible A' decays. The experiment employs an innovative technique, by having the primarily e^- beam from the SPS, with energy between 10 and 300 GeV, impinging on an *active* beam-dump, made by a calorimeter based on scintillating fibers and tungsten, ECAL1. A nearly-hermetic detector would be located behind the active beam-dump. The detector is made by a charged particle veto counter, a decay volume, two scintillating fiber counters, a second electromagnetic calorimeter ECAL2, and an hadronic calorimeter. The primary goal of the experiment is to search for A' production in the active dump through a Bremsstrahlung-like process, followed by A' decay to e^+e^- . The signature for these events is a signal in ECAL1 and two clusters in ECAL2, from the A' decay products. The same experiment, could also search for A' invisible decays by exploiting the detector hermeticity, and requiring a single hit in ECAL1 from the e^- radiating the A' . The projected sensitivity for $3 \cdot 10^{12}$ electrons on target covers a very large region in the A' parameter space, with $m_{A'} < 1$ GeV and $\varepsilon > 1 \cdot 10^{-5}$. However, in the event of a positive signal, the experiment would carve out a contour in the parameter space, but would not independently measure the A' properties,

Direct searches for A' decay products are natural extensions of the A' invisible decay search program presented above. Experiments measuring the χ scattering in a detector placed at tens of meters downstream of the dump of a high-intensity, high-energy beam have access to the full $A' - \chi$ parameter space, and have the potential of constraining a vast part of it. The MiniBooNE

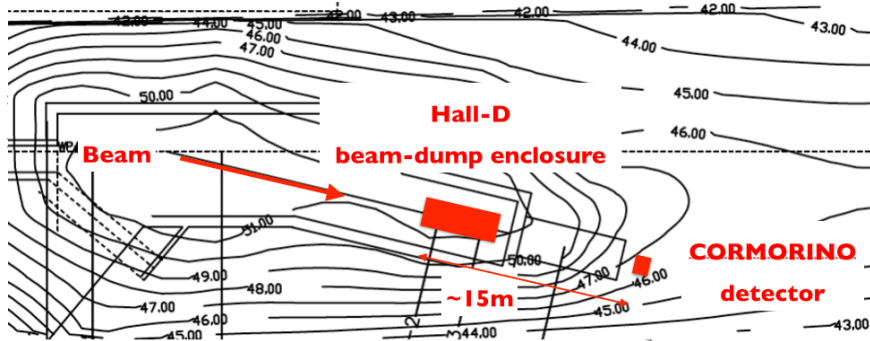

Figure 5: In the study case the CORMORINO detector is deployed $\sim 15\text{m}$ downstream the Hall-D beam-dump enclosure. The detector is placed above the ground within an iron shielding pit.

experiment, originally designed to study neutrino oscillations, recently completed a test run to demonstrate the feasibility of an MeV-scale χ s [17] search. During the test run, the primary 8.9 GeV proton beam from the FNAL accelerator impinged on a 50-m long iron beam-dump. The dark matter particles are produced through neutral meson decays (π^0 , η), in which one of the final state photons converts to an A' , which then decays to a $\chi\bar{\chi}$ pair. These particles can then scatter on the electrons or nuclei in the MiniBooNE detector, placed 490 m downstream of the beam-dump. The otherwise dominant neutrino background, generated by charged meson decays in flight, was reduced by a factor of $\simeq 70$ by diverting the proton beam into the dump, away from the original beryllium target. With the support of the FNAL PAC, MiniBoone has collected $1.1 \cdot 10^{20}$ protons on target in this beam-dump mode between October 2013 and April 2014. They will continue to take data in this configuration until September of 2014, and the team is evaluating analysis methods using the first two months of data.

2.4 A beam-dump experiment at JLab

The experiment proposed in this Letter of Intent would require a 1 m^3 -scale (or smaller) detector volume, located at tens of meters downstream of the dump of a high-intensity multi-GeV electron beam, and could run parasitically (see [10] for a proof-of-concept example). See Fig. 4 for a schematic representation of the experimental setup. The experiment will use *both* electron scattering and low-energy nuclear recoil signatures and exploit excellent forward geometric acceptance to greatly extend dark matter sensitivity beyond the parameter space covered by the high threshold/low acceptance E137 setup or by existing proton beam-dumps. The approach also takes advantage of Jefferson Lab's upgrade to 12 GeV energies with the new CEBAF, which is scheduled to deliver up to $\sim 100\mu\text{A}$ currents.

3 A study case: CORMORINO and JLab Hall-D beam-dump

In this Section we present the results of a study for a possible beam-dump experiment at JLab. This case study places an existing detector, CORMORINO, downstream of the Hall-D beam-dump, as shown in Fig. 5. We study this option in detail because CORMORINO implements a technology that we consider as a viable option for a full scale experiment and that, with minor modifications, can be easily used to measure cosmogenic backgrounds and validate simulations. Beam-related backgrounds were simulated in the Hall-D beam-dump configuration because, being above ground, this represents a set-up where CORMORINO could be easily installed with no need for major civil

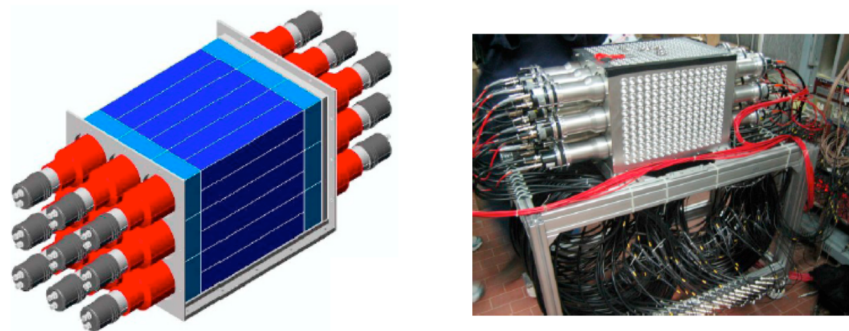

Figure 6: (Left) CAD representation of the CORMORINO detector, made by 9 bars of plastic scintillators read by 3PMTs, each read on both sides by a 3" PMTs . (Right) A picture of the detector mounted on its support and cabled.

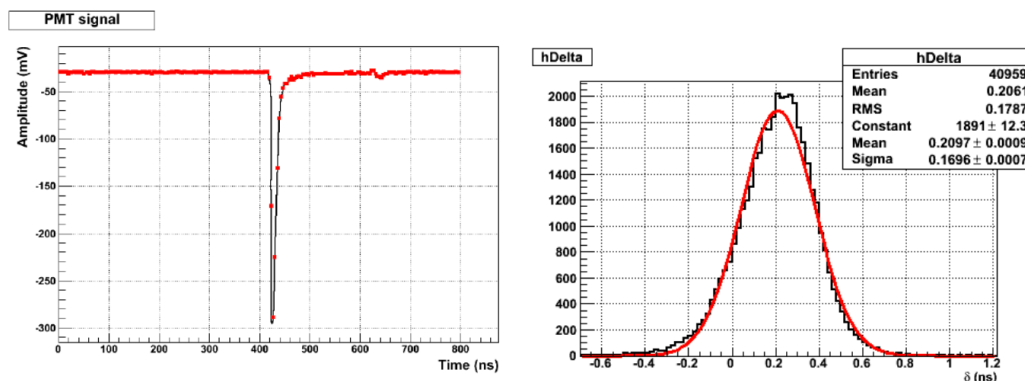

Figure 7: Left: a typical signal from CORMORINO and its digitization. Right: time resolution of CORMORINO measured with cosmic muons.

construction to perform a test run and validate the MC estimates. Based on these considerations, in this Section we report estimates for beam-related and beam-unrelated background rates in this experimental configuration as well as the expected signal rates. These results will be used to estimate the counts expected in a full experiment whose concept, including a $\sim 1 \text{ m}^3$ optimized detector placed behind a high intensity Hall beam-dump (A or C), is discussed in the next section.

3.1 The CORMORINO detector

The CORMORINO detector is a 0.036 m^3 cube made of plastic scintillator bars, whose output is read by PMTs. It is a prototype built for the experiment CORMORAD (CORE Reactor MONitoring by an Antineutrino Detector), which aims to use antineutrino to monitor the power and isotopic composition of the core of a commercial nuclear power plant. The 1.5 - 10 MeV antineutrinos produced by the fragment of the nuclear fission interact with protons of the plastic scintillator by inverse beta decay, thereby producing a positron and a neutron. The plastic scintillator, acting as an active target, provides a high number of protons and good detection capability for both positron ionization and neutron capture. The detector contains nine optical channels, each consisting of four $5 \times 5 \times 30 \text{ cm}^3$ plastic scintillator bars (NE102) individually wrapped in aluminized Mylar. The four bars are coupled on each side to a Photonis XP2312 3" photomultiplier via a $10 \times 10 \times 5 \text{ cm}^3$

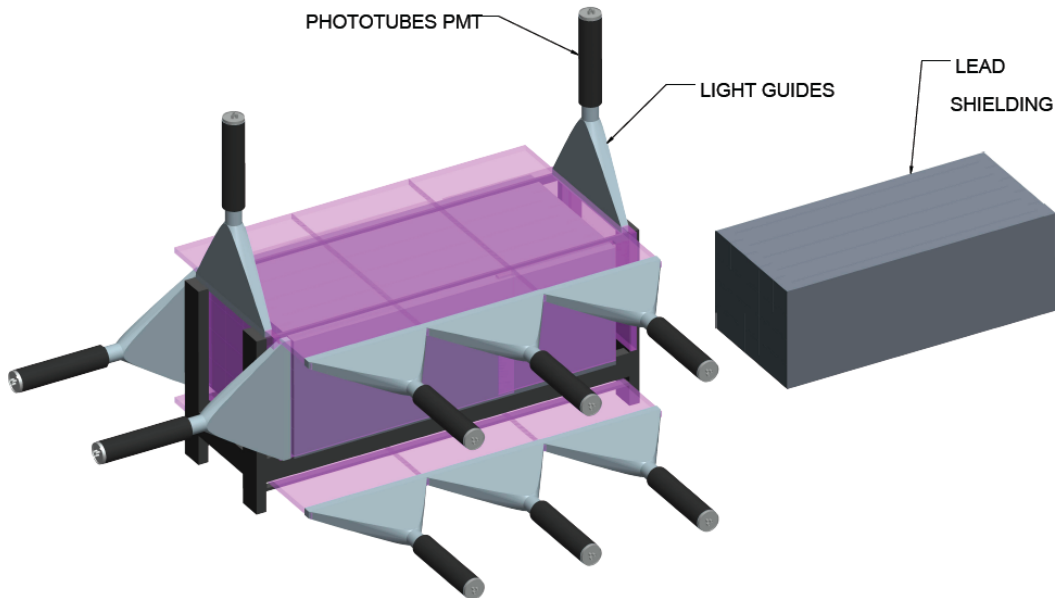

Figure 8: The veto detector surrounding CORMORINO is made by sheets of 2 cm thick plastic scintillators coupled to PMTs by shaped Plexiglas light guides. A thin layer of lead shields gamma's produced by particles decaying between the veto and CORMORINO. This detector is currently being assembled.

scintillator block, acting as light guide. Figure 6 shows a CAD drawing and a picture of the detector. The 9 (Left) + 9 (Right) PMTs are connected to 250 MHz 16ch JLab fADC boards for signal digitization. A typical signal is shown on the left panel of Fig. 7. In the same Figure on the right, the time resolution measured with cosmic muons is shown. With the current PMT gain, an energy deposition in the plastic scintillator of 1 MeV corresponds to a signal of 8 mV in amplitude in each PMT. Despite the aged plastic scintillator used in CORMORINO, the measured time resolution for MIPs is still $\sigma_T \sim 110$ ps. With new plastic, better optical coupling and optimized PMTs a time resolution of ~ 50 ps can be easily obtained as demonstrated by the new CTOF detectors built for CLAS12 [27]. The low rate expected in the experiment does not require a selective trigger and therefore the DAQ scheme that is implemented uses a simple L&R single-bar coincidence to save the full wave shape stored in the fADC. The trigger threshold can be set at 5 mV (corresponding to the energy deposited by a 600 keV electron), which leaves more sophisticated selection criteria for the off-line analysis to reduce backgrounds[§]. We are currently building a hermetic charged-particle veto counter based on 2 cm thick plastic scintillator planes to be placed in front of each of the 6 faces of the CORMORINO to reject cosmic muons and further reduce backgrounds. A layer of 5 cm of lead between the veto and the detector surface will shield from low energy gamma from particles decaying inside the external iron shield. Figure 8 shows the layout of the active and passive veto surrounding CORMORINO.

[§]In fact, having the full shape for each sample it is possible to do some particle identification, time measurement and time correlation between samples to reject neutron capture, rare muon decays, etc.

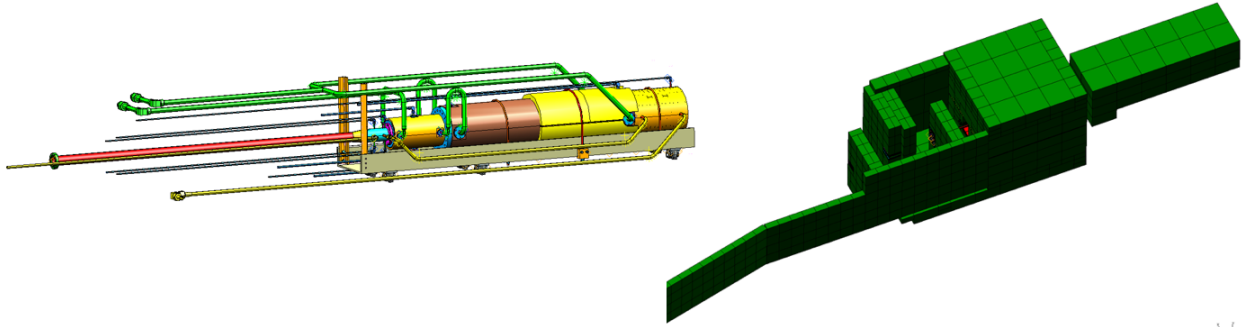

Figure 9: (Left) The Hall-D beam-dump; the aluminum and copper cylinder where the beam stops and the cooling pipes surrounding the dump are clearly visible. (Right) The beam-dump enclosure: only the external concrete wall is visible while the iron shield is hidden inside.

3.2 The Hall-D beam-dump

The Hall-D at JLab is expected to receive from CEBAF a 12 GeV electron beam with an average current of ~ 200 nA. This moderate current is not the optimal choice for a full scale experiment at JLab, but the simplified logistics motivated us to study this configuration in the event that beam-related backgrounds were found to be dominant, calling for a test run. The beam line delivering electrons to Hall-D runs above the ground in the last section of its path, in proximity of the beam-dump, which simplifies any possible detector deployments behind the beam-dump enclosure with access from all sides. To set up the experiment a hut hosting the detector in a water-tight and air-conditioned environment with few services such as power and network connection is required. For this option a shield for cosmogenic neutrons and cosmic rays needs to be artificially implemented, providing a pit of few meters of iron all around the detector.

The Hall-D beam-dump consists of an aluminum cylinder, ~ 25 cm in diameter and ~ 100 cm in length, followed by a ~ 30 cm long copper cylinder of the same diameter. They are both cooled by circulating water. The full drawing of the beam-dump is shown in the left panel of Fig. 9. The beam-dump is housed in a concrete (~ 0.8 m thick) and iron (~ 4 m thick) enclosure shown in the right panel of the same figure. To further reduce possible radiations, another shield made by ~ 8 m of iron has been added downstream.

3.3 Simulations of the experimental set-up

Both the CORMORINO detector and the Hall-D beam-dump geometry have been implemented in GEANT4 within the GEMC simulation package [28]. In the following sections we present some results concerning the beam-related background, the cosmogenic background, and the expected rates from an elastic interaction of a χ particle. The χ signal was simulated assuming the dominance of elastic DM interaction as discussed in Sec. 2.2. Figure 10 shows the detector as implemented in the simulations. As mentioned above, CORMORINO is positioned ~ 15 m downstream the beam-dump, surrounded by a 1 meter of iron acting as a passive shield for cosmogenic neutrons and gammas.

3.3.1 χ production and χ -p elastic scattering in CORMORINO

The detection of a χ particle in CORMORINO involves two steps: the A' electro-production and subsequent decay $A' \rightarrow \chi\bar{\chi}$, occurring in the very first layer of the beam-dump, and the elastic scattering of a χ on a proton of the detector. Both processes depend on four parameters: the mass

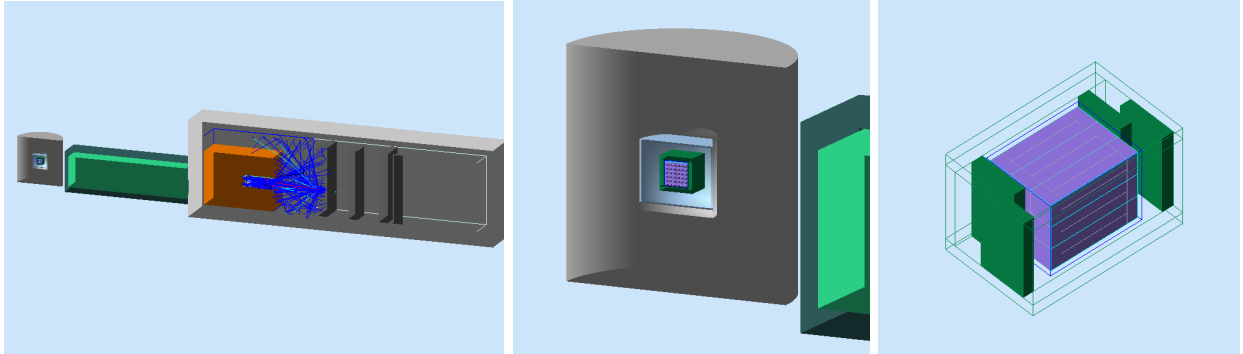

Figure 10: Implementation of the CORMORINO detector in GEMC. The section on the right shows the 9 optical channels (each made by 4 plastic scintillator bars), with a cylinder surrounding the detector acting as an active veto. In the middle plot, the lead shielding (in green) is shown. The section on the left shows the detector and veto inside a 1 m thick iron pit to reduce cosmogenic background.

Table 1: Relevant parameters of the theory for the two scenarios. The resulting number of χ produced per electron on target (EOT) and the elastic interaction cross section $\sigma_{\chi-p}$ are also reported.

	S.I	S.II
m_χ	10 MeV	68 MeV
$m_{A'}$	50 MeV	150 MeV
ϵ	10^{-3}	10^{-3}
α_D	0.1	0.1
N_χ pairs produced per EOT	$3.4 \cdot 10^{-10}$	$3.4 \cdot 10^{-11}$
$\sigma_{\chi-p}$	1.4 nb	0.14 nb

of the χ (m_χ), the mass of the exchanged A' ($m_{A'}$), the coupling constant between the electron and the A' (ϵ) and the coupling constant between the χ and the A' (α_D). We explored two possible scenarios, S.I and S.II, for which the corresponding parameters are reported in Tab. 1. The table also reports the resulting χ production rate (per EOT or *Electron On Target*) and the corresponding elastic cross section on a proton in the detector. Figure 11 shows the kinematics of the χ within the CORMORINO acceptance, assuming a 12 GeV electron beam (left and right plots correspond to S.I and S.II respectively). Figure 12 shows the energy deposited in the detector by the proton recoils induced by the χ -p elastic scattering. The red histogram shows the deposited energy while the black shows the reconstructed energy for the proton detection, including the light quenching effect in the scintillator. It is worth noting that a sizable fraction of events deposit a visible energy greater than 1 MeV. To evaluate the number of detected events in CORMORINO, we required a single hit defined as the coincidence of the PMTs coupled to the same scintillation bar. For both scenarios

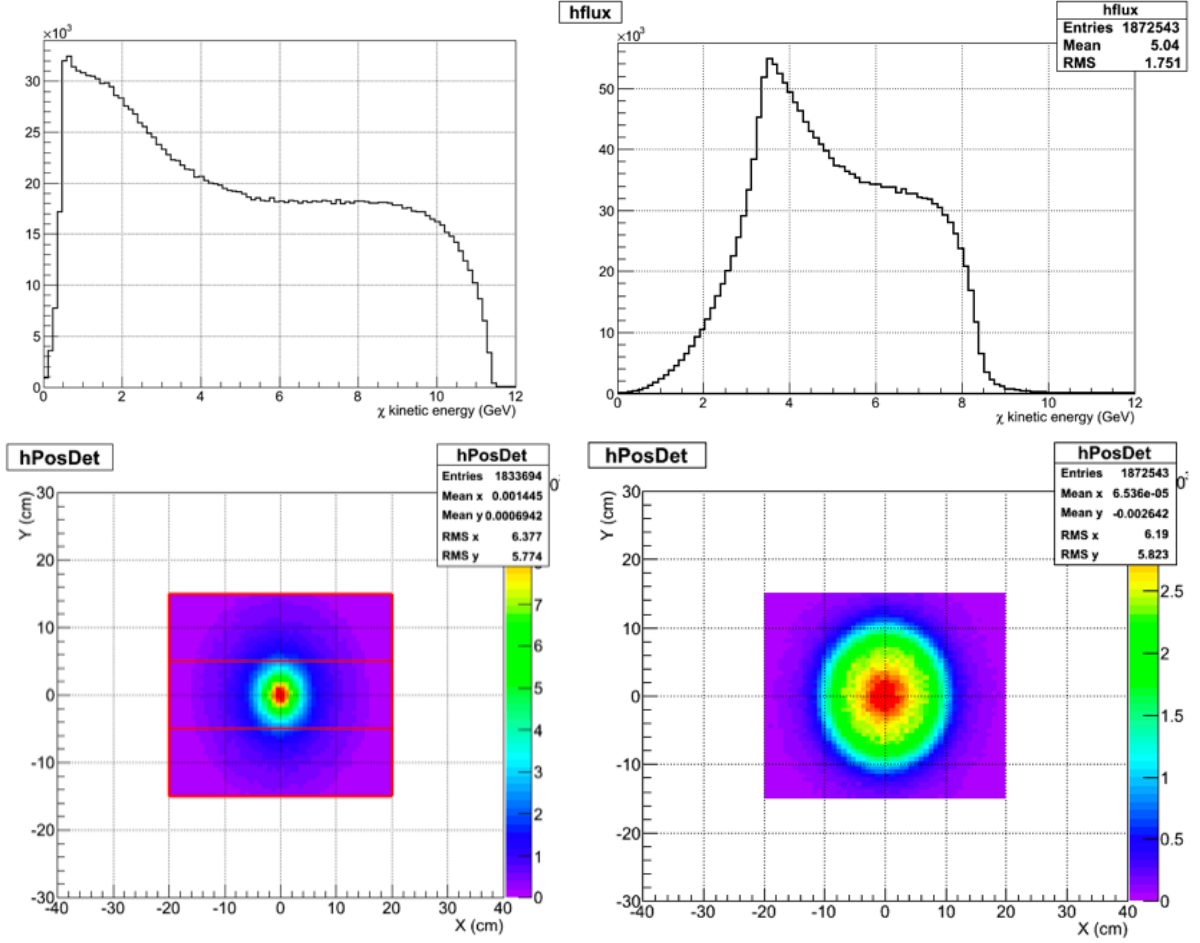

Figure 11: Top: the kinetic energy of the χ particle produced by 12 GeV electron beam in the two scenarios studied (left S.I, right S.II). Bottom: the distribution of χ events hitting the CORMORINO surface (left S.I, right S.II).

we evaluate the rates for two thresholds: 1 MeV and 10 MeV[¶]. The effect of light attenuation in the scintillator was also included in the simulations, even if the effect is known to be small give the size of the detector. The expected χ -p elastic detection rate (per μA) for a threshold of 1 MeV (10 MeV) is therefore:

$$R_{elastic\ \chi}^{S.I} = 1.0 \cdot 10^{-5} \text{Hz}/\mu\text{A} \quad (1.2 \cdot 10^{-6} \text{Hz}/\mu\text{A}) \quad (4)$$

$$R_{elastic\ \chi}^{S.II} = 2.0 \cdot 10^{-7} \text{Hz}/\mu\text{A} \quad (0.7 \cdot 10^{-7} \text{Hz}/\mu\text{A}) \quad (5)$$

3.3.2 Beam-related background

The beam-related background has been simulated generating $1.6 \cdot 10^9$ 12 GeV EOT impinging on the beam-dump, corresponding to 1.2 ms of 200 nA beam. The only particles exiting from the beam-dump and crossing the detector area are ν and $\bar{\nu}$ from π^+ decays ($\pi^+ \rightarrow \mu^+ \nu_\mu$) and μ^+

[¶]To realistically simulate threshold effects, we applied a threshold to each PMT, independently.

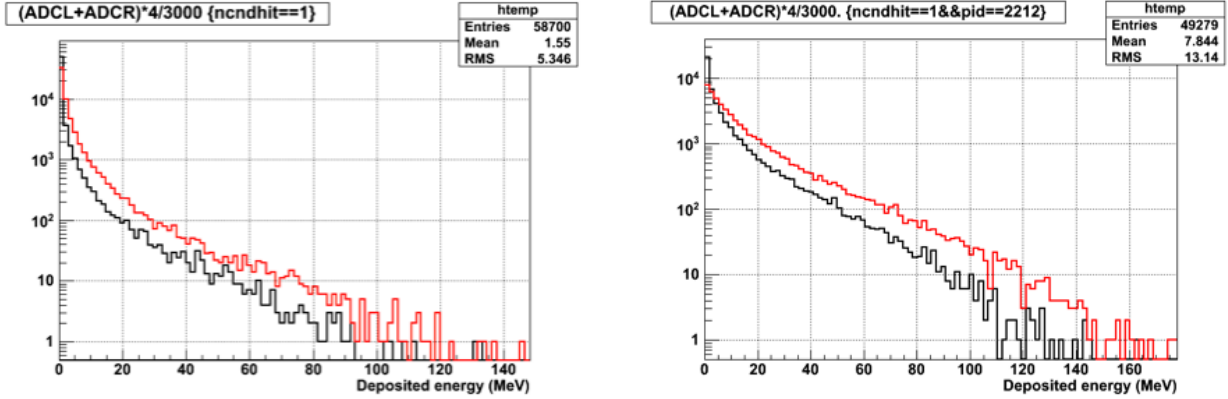

Figure 12: The energy deposited (red) and reconstructed (black) in CORMORINO. The reconstructed energy spectrum includes the effect of light quenching in the two scenarios (left S.I, right S.II).

decays ($\mu^+ \rightarrow e^+ \bar{\nu}_\mu \nu_e$) with a ratio of about $1.1 \nu_\mu : 1 \nu_{\bar{\mu}} : 1.1 \nu_e$. Negative pions are captured by nuclei before they can decay and therefore do not contribute to the neutrino counting. The energy spectrum of the 3 species is reported on the left panel of Fig. 13: the positive pion decays at rest providing a monochromatic set of ν_μ of 33.9 MeV ($M_\pi - M_\mu$). Neutrinos from μ^+ decay share a total energy of 105.1 MeV ($M_\mu - M_e$), which results in an upper limit for the energy of the $\nu_{\bar{\mu}}$ and ν_e . These neutrinos originate inside the beam-dump as shown in the right panel of Fig. 13. The rates of neutrinos crossing the detector area, approximately equal for the three species, are $\sim 7.5 \cdot 10^6$ Hz/ μ A while the integrated rate is $\sim 2.2 \cdot 10^7$ Hz/ μ A. Neutrinos with energy in the range 2-100 MeV mainly interact by CC interaction ($\bar{\nu}_p \rightarrow e^+ n$) with a cross section of about $\sigma_{\bar{\nu}p} \sim 10^{-40}$ cm². Considering the volume of CORMORINO and assuming a detection efficiency of $\epsilon_{e^+ \text{detection}} = 50\%$ with 1 MeV threshold (5% for 10 MeV threshold), the background rate is given by:

$$R_{B-rel}^\nu = R^\nu \sigma_{\bar{\nu}p} N_{Avogadro} 1/A \rho_{plastic} L_{CORMORINO} \epsilon_{e^+ \text{detection}} = 2 \cdot 10^{-9} \text{Hz}/\mu\text{A} \quad (2 \cdot 10^{-10} \text{Hz}/\mu\text{A}) \quad (6)$$

No neutrons or other particles are observed within the generated statistics. This allows us to set only an upper limit on the corresponding rate that we will improve by increasing the Monte Carlo statistics.

Beside the beam-related background estimated by MC simulations, in Sec. 4.1.2 we discuss additional checks that could be performed during the run by changing the experimental set-up (e.g. off-axis and on/off measurement, noise on PMTs, .etc.) to determine systematic effects that we may have under-evaluated or neglected by MC simulations.

3.3.3 Beam-unrelated backgrounds

Beam-unrelated backgrounds are mainly due to cosmic neutrons, cosmic muons and their decay products, including rare decays of muons producing gamma's between the passive shield and the active veto. In this Section we briefly present background reduction strategies that could be applicable to a new, full-scale, optimized detector. We also present some preliminary results of MC simulations specifically for the CORMORINO set-up. To validate MC simulations and optimize the selection algorithms, we are planning to perform an extensive campaign of measurements with the CORMORINO detector in the same experimental conditions of a real experiment (detector placed

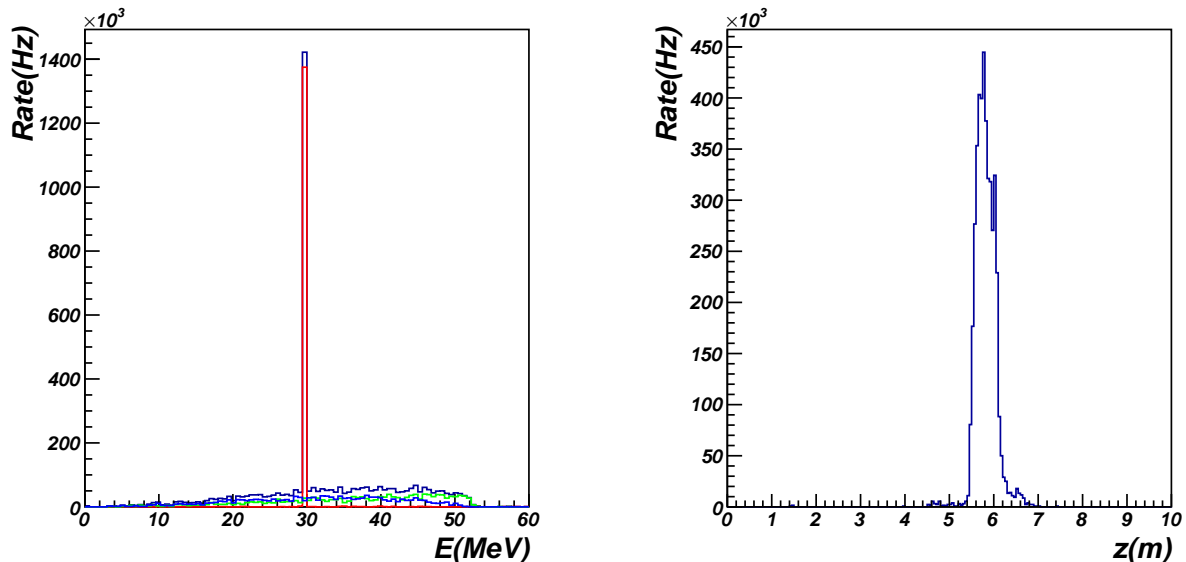

Figure 13: Left: the energy spectrum of beam-related neutrinos crossing CORMORINO surface (black: total spectrum; red: ν_μ , green: $\bar{\nu}_\mu$, blue: ν_e). Right: the vertex of the decaying primary particles (μ and π) starting at the beam-dump location and extending for 1 m downstream.

above the ground, same shielding as reported here, etc).

Time-Correlation Beam-uncorrelated backgrounds can be rejected by requiring a time coincidence between the RF signal and the event recorded by the detector. However, even if the studied case of a plastic scintillator detector provides a sub-ns response to a χ scattering, the nearly-CW structure of the CEBAF beam weakens the effectiveness of this technique. In fact, the bunch separation expected for the 12 GeV implementation is $\Delta T=4.0$ ns to be compared with the measured time resolution of CORMORAD of $\sigma_T \sim 200$ ps for 1 MeV deposited energy. The background reduction factor, R , can be expressed as the ratio between the time coincidence window width ($3\sigma_T$) and ΔT providing for JLab-CORMORINO(-like) conditions:

$$R = \frac{3\sigma_T}{\Delta T} \sim 20\% . \quad (7)$$

It is worth noting that for the conditions discussed in this paper with a detector placed 15 m away from the beam-dump, χ masses between 0 - 500 MeV result in a time-of-flight spread below $\sigma_T=200$ ps (0 - 170 MeV for $\sigma_T=20$ ps). The same argument applies to the χ momentum spread: any p_χ between 6 GeV and 100 MeV correspond to a time-of-flight spread below $\sigma_T=200$ ps (6 GeV - 350 MeV for $\sigma_T=20$ ps). This suggests that, for a fast detector ($\sigma_T \sim 70$ -100ps) the rejection factor for uncorrelated background can be reduced by up to a factor of ten. This will be further discussed in in Sec. 4.2. In what follows, we conservatively omit the rejection power of timing cuts, so this background rejection factor needs to be added to the results for a full sensitivity projection.

Directionality Beside time-correlation, directionality could help reduce the cosmogenic background. In fact the angular distributions of cosmic muons (and their decay products) and cosmic neutrons are peaked in the vertical direction transverse to the beam (the angular distributions are

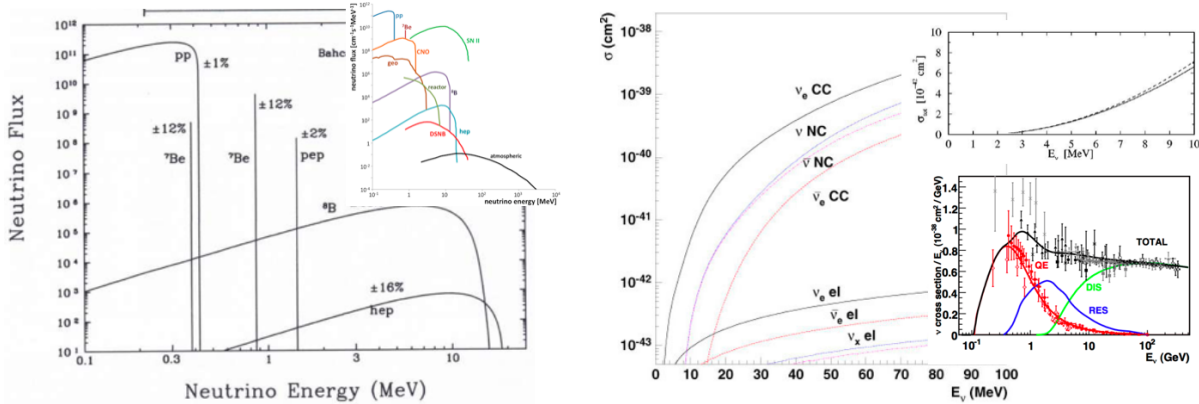

Figure 14: Cosmic neutrino flux and interaction cross section.

proportional to $\cos^2 \theta$ and $\cos^3 \theta$ respectively) whereas the χ s enter the detector preferentially in the beam direction. The simple detector described here (a plastic scintillator cube) does not provide directionality capability for single-hit interactions, but this capability should be considered in a full-scale optimized detector as reported in Sec 4.2.

In the following we report rate estimates for all species of cosmogenic background as obtained by GEANT4 simulations.

Cosmic neutrinos Cosmic neutrinos interactions represent a negligible contribution to the uncorrelated background. The only sizeable flux we need to consider is for solar neutrinos [30] with energy below 10 MeV (see Fig. 14-Left) a rate on CORMORINO of $R_{E_\nu < 10 \text{ MeV}}^{\text{Cosmic}\nu} \sim 3 \cdot 10^{11}$ Hz. Low energy neutrinos ($E_\nu < 10$ MeV) interact with protons in the detector mainly by inducing inverse beta decay ($\bar{\nu}p \rightarrow e^+ n$), producing a positron that carries almost all the full neutrino energy, which could mimic a χ interaction. The corresponding cross section [31], reported in Fig. 14-Right) is in the range of $\sigma_{\bar{\nu}p} \sim 3 \cdot 10^{-42}$ cm². The background rate, considering the volume of CORMORINO and assuming a detection efficiency of $\epsilon_{e^+ \text{ detection}} = 50\%$ with 1 MeV thresholds (and 5% for 10 MeV threshold), is given by:

$$R_{Bg}^\nu = R_{E_\nu < 10 \text{ MeV}}^{\text{Cosmic}\nu} \sigma_{\bar{\nu}p} 1/AN_{\text{Avogadro}} \rho_{\text{plastic}} L_{\text{CORMORINO}} \epsilon_{e^+ \text{ detection}} = 10^{-6} \text{ Hz} \quad (10^{-7} \text{ Hz}) \quad (8)$$

The flux of high energy cosmic neutrinos is several orders of magnitude smaller, which does not compensate for their larger interaction cross sections. Moreover, the elastic scattering on a proton transfers only a small amount of energy, which reduces the probability of detecting the recoiling proton. For all these reasons the cosmic neutrino background is negligible compared to other sources.

Cosmic neutrons A cosmic neutron interacting with CORMORINO can produce a recoil above the trigger threshold, which looks identical to a recoil induced by an incident χ particle. Considering the typical interaction length of neutrons in plastic, the 2 cm thick active veto has a small chance of detecting the incoming neutrons. On the other hand, the veto is sometimes useful to reject neutron events, which produce hadronic showers in the heavy passive shielding when some charged fragments reach the detector. To estimate the rate of single hits in CORMORINO (mimicking a χ interaction), we generated a realistic cosmic neutron flux as reported in Fig. 15-Left with the parametrization

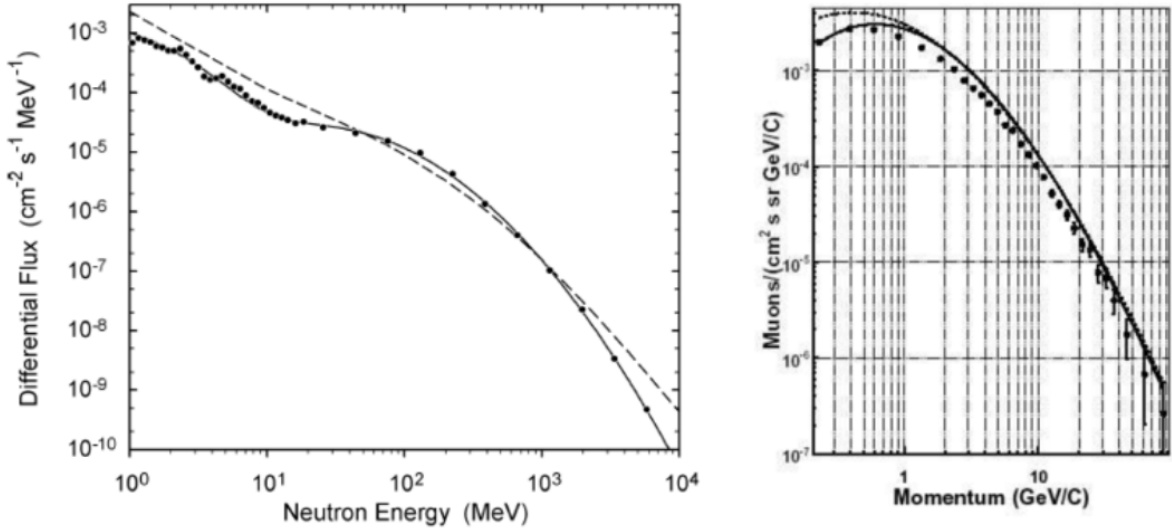

Figure 15: Flux of cosmic neutron (left) and muons (right).

from Ref. [32]. The overall neutron rate in open-air at sea level (integrating over all energies and angles) is ~ 64 Hz/m², (corresponding to a differential flux of ~ 50 Hz/m²sr). The CORMORINO neutron detection efficiency ϵ_n^{cosmic} depends on the surrounding shielding, the incoming neutron energy (E_n) and the detection threshold (E_{Thr}). Considering the 1 m iron shield, and a detection threshold of 1 MeV (10 MeV) we found that the detector is blind ($\epsilon_n^{cosmic} \sim 0$) to neutrons with energy lower than 50 MeV (100 MeV).

Thus, the overall visible rate for a detection threshold of 1 MeV (10 MeV) is:

$$R_{Bg}^n = 2.7 \cdot 10^{-3} \text{Hz} \quad (0.6 \cdot 10^{-3} \text{Hz}) \quad (9)$$

Cosmic muons Cosmic muons are by far the main source of beam-uncorrelated background in a plastic scintillator detector. Fortunately, the most part of muons interact with both the veto counter and with CORMORINO, releasing the typical energy of a MIP, that can be tracked and rejected by exploiting the detector segmentation. Another source of background is due to muons decaying within the detector, between the shielding and the veto counter. In the following we report rate estimates based on MC simulations for the measured muon flux shown in Fig. 15-Right from Ref. [29].

Crossing muons The combination of the active veto, also sensitive to cosmic muons crossing at large angles, together with the CORMORINO identification capability (segmentation) sizably reduces the number of crossing muons. The cosmic muon flux rate on the CORMORINO surfaces, is 30.3 Hz (40% hits the top face and the remaining 60% hits the lateral sides) neglecting the shielding. The effect of 1 m iron shielding and 5 cm thick lead is to suppress muons with momentum < 1.45 GeV/c, reducing the flux on the detector to $R^{All \mu} \sim 4.5$ Hz, and 4 Hz (3.9 Hz) for hits over a 1 MeV (10 MeV) threshold in CORMORINO. Crossing muons usually induce 2 hits on the veto detector and ≥ 1 hits in CORMORINO. To misidentify a crossing μ as a χ it is necessary that both hits in the veto counter are missed and only one CORMORINO bar records the hit. Assuming the veto counter inefficiency to be $(1 - \epsilon_{veto}) = 5\%$ and considering that $\alpha_{Single \ hit}^{Crossing \mu} = 32\%$ for a 1 MeV threshold (36% for a 10 MeV threshold) of crossing muons release a visible energy in a single CORMORINO bar (the

rejection condition is $N_{Hits}^{Veto} + N_{Hits}^{CORMORINO} \geq 2$), we end up with charged muon misidentification rate of:

$$R_{Bg}^{Crossing \mu} = R^{All \mu} \alpha_{Single \ hit}^{Crossing \mu} (1 - \epsilon_{veto})^2 = 3.3 \cdot 10^{-3} \text{Hz} \quad (3.5 \cdot 10^{-3} \text{Hz}) \quad (10)$$

Muons decaying inside CORMORINO Muons stopping inside the detector cross one side of the veto. Positive muons stopping and decaying (at rest) are all detected for both thresholds with rate $R^{\mu^+ \text{ inside dec}} \sim 0.12 \text{ Hz}$ for μ^+ . Negative muons, mainly captured by nuclei, produce a visible signal in the detector with rate $R^{\mu^- \text{ inside capture}} \sim 0.12 \text{ Hz}$ for μ^- for both thresholds (1 MeV and 10 MeV).

Negative muons, if detected by the veto can be rejected. If not detected, and providing a single hit in CORMORINO, they contribute to the background. From MC simulations we derived $\alpha_{Single \ hit}^{\mu \text{ inside capture}} = 24\%$ for 1 MeV threshold and 39% for 10 MeV.

$$R_{Bg}^{\mu^+ \text{ inside capture}} = R^{\mu^- \text{ inside capture}} \alpha_{Single \ hit}^{\mu \text{ inside capture}} (1 - \epsilon_{veto}) = 1.4 \cdot 10^{-3} \text{Hz} \quad (2.4 \cdot 10^{-3} \text{Hz}) \quad (11)$$

Positive muons that release energy above the trigger threshold (a fraction of $R^{\mu^+ \text{ inside dec}}$) will provide a prompt signal (in coincidence with the veto) and a delayed hit due to the positron from $\mu^+ \rightarrow e^+ \bar{\nu}_\mu \nu_e$. These events can be identified and rejected disregarding hits in the detector during a time window of $10 \tau_{Decay} = 22 \mu\text{s}$ after the prompt signal. This selection would add a negligible dead-time to the DAQ. A source of background still arises from the veto inefficiency and the fraction of these events that provides a single hit (over threshold) in CORMORINO. The resulting rate is:

$$R_{Bg}^{\mu^- \text{ inside decay}} = 2 R^{\mu^- \text{ inside dec}} \alpha_{Single \ hit}^{\mu \text{ inside dec}} (1 - \epsilon_{veto}) = 2.9 \cdot 10^{-3} \text{Hz} \quad (4.8 \cdot 10^{-3} \text{Hz}) \quad (12)$$

where the factor of 2 takes into account that the stopping muon and/or the positron can both trigger the detector (being $\alpha_{Single \ hit}^{\mu \text{ inside dec}} = \alpha_{Single \ hit}^{\mu \text{ inside capture}}$).

Muons decaying inside lead shielding Here we consider muons that decay or get captured in the lead shielding between the veto and CORMORINO. We obtained a rate of $R^{\mu \text{ lead}} \sim 0.9 \text{ Hz}$ reduced to 0.3 Hz and 0.2 Hz for a detection threshold of 1 MeV and 10 MeV respectively. The fraction of events that deposited energy in a single CORMORINO bar is $\alpha_{Single \ hit}^{\mu \text{ lead}} \sim 0.46$ and 0.43 for a threshold of 1 MeV and 10 MeV respectively. These values lead to a background rate of:

$$R_{Bg}^{\mu^- \text{ lead}} = R^{\mu \text{ lead}} \alpha_{Single \ hit}^{\mu \text{ lead}} (1 - \epsilon_{veto}) = 7.0 \cdot 10^{-3} \text{Hz} \quad (4.3 \cdot 10^{-3} \text{Hz}) \quad (13)$$

Muons decaying between the iron shielding and veto The last possibility is that the muon decays in the region between the shielding and the veto, mainly in the very last layer of iron. The rate $R^{\mu \text{ between dec}} \sim 0.7 \text{ Hz}$ ^{||}. For a typical decay, the few e^+ that escape the iron have a good chance of being detected by the veto and fully absorbed by the lead shielding between the veto and CORMORINO; therefore their contribution to the background is negligible. The rare $\mu \rightarrow e^- \bar{\nu}_\mu \nu_e \gamma$ decay (BR $\sim 1.5\%$) produces a 20-50 MeV gamma that can enter in CORMORINO bypassing the veto. The absorption length for 10 MeV - 100 MeV gammas in lead is a.l. $\sim 0.9\text{cm}$. The leads shielding between the detector and the veto is 5 cm thick, corresponding to 5.5 a.l. for an overall attenuation of $\sim 4 \cdot 10^{-3}$. The fraction of 10-100 MeV photons interacting with CORMORINO and

^{||}This rate has been estimated considering the fraction of μ decaying in the last 10cm of iron all around the detector corresponding to few absorption lengths of 20-50 MeV gammas.

releasing an energy over threshold is estimated to be: $\alpha_{Single\ hit}^{\mu\ between\ dec} \sim 0.5$ for a 1 MeV threshold and 0.2 at 10 MeV. Considering all these factors, the background rate is

$$R_{Bg}^{\mu; rare\ dec} = R^{\mu\ between\ dec} BR\ Att\ \alpha_{Single\ hit}^{\mu\ between\ dec} = 2\ 10^{-5}\text{Hz}\ (0.8\ 10^{-5}\text{Hz})\ , \quad (14)$$

and is therefore negligible. =

Table 2: Expected rates for signal, beam-related and beam-related background in CORMORINO detector for two detection thresholds: 1 MeV and 10 MeV.

	Rate $_{Thr=1\text{MeV}}$ (Hz/ μA)	Rate $_{Thr=10\text{MeV}}$ (Hz/ μA)
χ detection - S.I	$1.0\ 10^{-5}$	$1.2\ 10^{-6}$
χ detection - S.II	$2.0\ 10^{-7}$	$0.7\ 10^{-7}$
B-rel ν	$2.0\ 10^{-9}$	$2.0\ 10^{-10}$
B-rel neutron	0	0

	Rate $_{Thr=1\text{MeV}}$ (Hz)	Rate $_{Thr=10\text{MeV}}$ (Hz)
B-unrel ν	$2.0\ 10^{-6}$	$2.0\ 10^{-7}$
B-unrel neutron	$2.7\ 10^{-3}$	$0.6\ 10^{-3}$
Crossing muons	$3.3\ 10^{-3}$	$3.5\ 10^{-3}$
Captured μ^+	$1.4\ 10^{-3}$	$2.4\ 10^{-3}$
Decaying μ^- (CORM)	$2.9\ 10^{-3}$	$4.8\ 10^{-3}$
Stopped μ in lead	$7.0\ 10^{-3}$	$4.3\ 10^{-3}$
μ^- rare decay	$2.0\ 10^{-5}$	$8.0\ 10^{-6}$
Total Beam-unrelated bg	$1.7\ 10^{-2}$	$1.5\ 10^{-2}$

3.3.4 Summary

Rates for signal, beam-related and beam-unrelated background sources are reported in Tab. 2 for the two detection thresholds of 1 MeV and 10 MeV. Based on these estimates we can conclude that beam-related backgrounds are negligible compared to cosmogenic sources, which represent the dominant source. This leads us to conclude that a test-run for this experimental set up would not give us relevant information because of the limited luminosity. However, these results call for a thorough investigation of beam-unrelated backgrounds using CORMORINO. The rates in the table will be used in the next section to provide an estimate of the sensitivity for a full scale experiment, with $1\ \text{m}^3$ detector for a 6 months run at $100\ \mu\text{A}$.

4 Towards a full scale experiment: BDX

In this Section we present count estimates obtained by scaling-up the rates reported above to the full scale experimental setup. Detailed MC simulations, fully implementing the geometry of an optimized detector and considering the alternative options for beam current, beam-dump geometry, location, etc. are in progress. Final results will be presented in a full proposal to the next JLab PAC.

4.1 The full experiment

Here we consider an experimental set-up that takes advantage of the maximum beam current available at JLab ($\sim 100\mu\text{A}$ in Hall-A or Hall-C) assuming that the beam-dump shielding effect will be comparable to what is estimated for Hall-D and that the beam-related backgrounds scale correspondingly. We assume to use 1 m^3 detector sharing the same technology of CORMORINO (segmented plastic scintillator bars and PMTs read-out).

Rates for χ -p elastic scattering signal and backgrounds used for this estimate are taken from Tab. 2. As reported in Sec. 2.2, a χ can also scatter off an atomic electron of the detector. Even if sub-dominant respect the genuine χ -p elastic scattering, this process can be easily accessed experimentally since it results in a $\sim\text{GeV}$ scattered electron as shown in Fig. 3. In the full scale detector, it will be possible to space out foils of $\sim\text{mm}$ -thick lead between few cm -thick plastic scintillator bars to build a sampling calorimeter with good energy resolution and high efficiency. All the considerations and estimates of χ -p elastic detection and the background rates remain valid also with this design. Assuming a 15 radiation length calorimeter, it is possible to obtain a sampling fraction of 30% [33] and increase the threshold to 150 MeV (600 MeV) for a 500 MeV (2 GeV) scattered electron. With such high thresholds we do not expect to have any counts neither from cosmogenic nor from beam-related background. High energy electron and positron pairs can also be produced by inelastic DM production (see Sec. 2.2 for details) which yield a similar signal.

We derived the number of EOT to be $N_{EOT} \sim 10^{22}$, corresponding to 1 year of parasitic running with 50% efficiency and a current of $100\mu\text{A}$. We scaled the signal and background yield by assuming a 1 m^3 detector with 30 times larger length and the same transverse size of CORMORINO. The full detector would consist of 270 of the CORMORINO modules (instead of 9) with the surface perpendicular to the beam kept constant to take advantage of the χ forward kinematics. With this geometry, the isotropic cosmogenic background also scales by a factor of 30. The same is true for the PMTs and electronic channels, driving the costs to a still reasonable value ($\sim \$\text{M}$). We also assumed a beam-unrelated background reduction factor of 5, considering a conservative time coincidence window between hits in the detector and RF signal from the beam. The expected counts are reported in Tab. 3. The counts in the detector are dominated by beam-unrelated background that, as discussed in Sec. 4.2 can be further reduced with an optimized detector and shield.

4.1.1 BDX expected reach

Table 3 reports fluctuation of backgrounds in the range of 1000 counts for 1 year measurement (50% efficiency). Based on these estimates, a χ -p elastic scattering signal compatible with the least favorable scenario (S.II) would be identified with a significance of 3σ and 10σ over the background for the 1 MeV and 10 MeV threshold, respectively. In the event of a null observation, the accumulated data would provide very stringent limits in the DM parameters space. Figures 16 and 17 show the BDX sensitivity to the kinetic mixing models of §2.2 in the nucleon-recoil and

Table 3: Expected counts for 6 months of run time at $100 \mu\text{A}$ (corresponding to 10^{22} EOT) for signal, beam-related and beam-unrelated background in a $30\times$ longer detector for 1 MeV and 10 MeV detection threshold assuming a background reduction factor $5\times$ for time coincidence.

	Counts $Thr=1\text{MeV}$	Counts $Thr=10\text{MeV}$
χ detection - S.I	$0.5 \cdot 10^6 \pm 700$	$5.7 \cdot 10^4 \pm 240$
χ detection - S.II	$1.0 \cdot 10^4 \pm 100$	$3.3 \cdot 10^3 \pm 60$
Beam-rel bg	100 ± 10	10 ± 3
Beam-unrel bg	$1.6 \cdot 10^6 \pm 1300$	$1.4 \cdot 10^6 \pm 1200$

electron channels, respectively. The exclusion regions shown in the plots were derived by constraints from cosmological observations, meson factories results and previous electron/hadron beam-dump experiments. As explained in Sec. 2.1, limits imposed by E137 experiment on χ -p elastic scattering were derived within a certain model from χ -e elastic exclusion plot, being the experiment only able to detect multi-GeV electrons. BDX has the unique capability of being simultaneously sensitive to different DM interaction mechanisms. The region potentially covered by JLab would, therefore, significantly extend the parameter space covered by previous experiments.

4.1.2 Systematic checks

In the event of a positive signal, there is a list of possible checks that can be performed to confirm that any observed excess of counts is attributable to a genuine signal.

- **Beam on/off:** the most straightforward check will be to accumulate data with beam off to determine the cosmogenic background on site; assuming the aforementioned 50% efficiency of running, this corresponds to 6 months of beam-off time.
- **Beam-related neutrons:** for half of the run time a lead+water shield will be placed in the direction of the beam to guarantee that the count excess is not related to neutrons (scattering and/or captured).
- **Beam-related neutrinos:** according to MC simulations, the rate is so low that even if we scale the results by a factor 100 the neutrino background is still negligible. Furthermore, we can check the systematic effect by an off-axis measurement since neutrinos are mainly produced isotropically from decays at rest.
- **Other beam-related noise:** due to the expected forward-peaked kinematics of the χ an off-axis ($\sim 1\text{m}$) measurement will verify that the detected signal is due electron beam interactions.
- **Cosmic background:** a precise measurement of the cosmic background in the detector will be possible and can accumulate data either before or after the 1 year experiment time. Cosmic background can be measured elsewhere as long as the shielding is identical. In this way a more precise subtraction of the cosmic background will be possible.

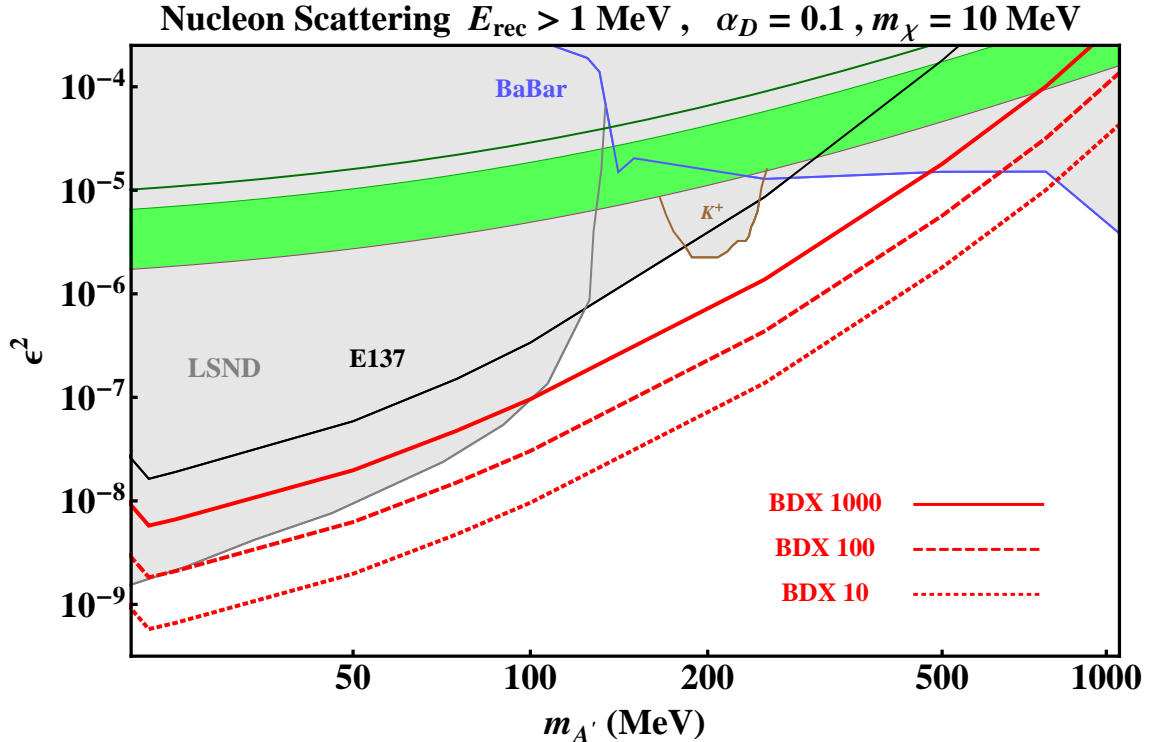

Figure 16: Red curves show 10, 100, and 1000 event BDX yield projections for a kinetically-mixed dark-photon (A') coupled to a nearly-invisible fermion χ in the quasi-elastic nucleon recoil channel with 10^{22} EOT. The A' is radiatively produced in electron-nucleus collisions in the beam-dump and decays promptly to yield $\bar{\chi}\chi$ pairs, which scatter off detector nucleons and deposit at least 1 MeV of visible energy into the nuclear recoil signal.

4.2 Planned R&D

Results show that, running at one of JLab's high intensity Hall (A or C) beam-dumps with an upgraded version of an existing CORMORINO-like detector, it is possible to explore a wide range of model parameters in a time scale of 1 year. We believe that there is still room for improvement in the detector concept, active veto, and shielding design. Moreover, the expected low counting rate coupled with the signal digitization of fADCs will allow us to optimize the off-line reconstruction algorithms, further enhancing the rejection capability.

As short-term R&D activity, we are planning to validate the simulation results by setting up the veto counter, iron and lead shielding around the CORMORINO detector and measure the cosmogenic background identifying the different sources. We are also discussing the option of proposing a short test run with CORMORINO behind the Hall-D beam-dump before the full detector will be built. This measurement can help to further test and validate our detector concept and simulations (e.g. using the time coincidence for cosmogenic background rejection, as well to confirm estimates for the beam-related background).

On a mid-term scale, we will investigate other detector options (or upgrades) to reduce costs and increase sensitivity. Indeed, a plastic scintillator detector, such as CORMORINO, offers a good initial concept for an optimized detector for a full beam-dump experiment. It presents many key-features that we want to preserve in the final detector design:

- a high number of recoiling protons in $\chi - p$ interactions release visible energy in the active

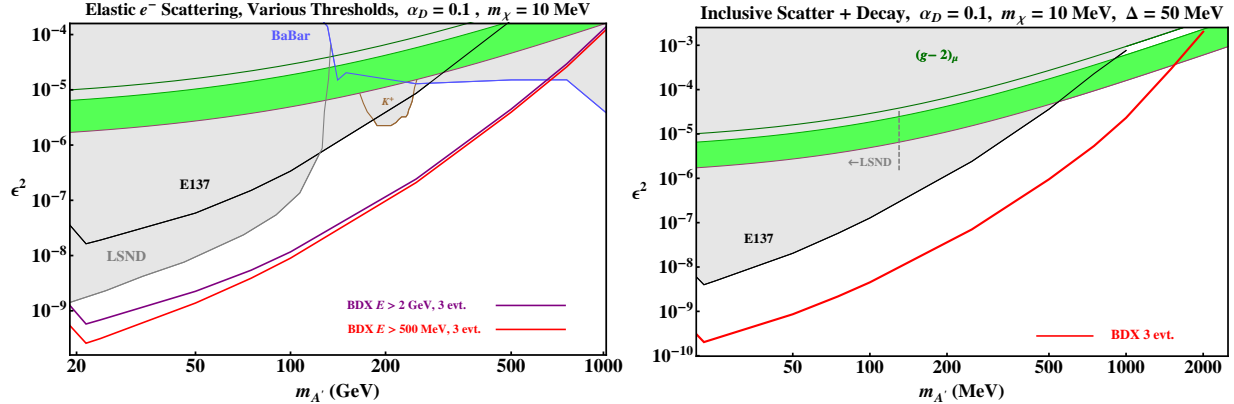

Figure 17: Left: BDX yield projections for a kinetically-mixed dark-photon (A') coupled to a nearly-invisible Dirac fermion χ in the electron recoil channel. The experimental setup is identical to that of the previous figure. The red and purple curves show 3 event yields with 500 MeV and 2 GeV cuts on electron recoils respectively. Right: BDX yield projections for a kinetically mixed dark-photon that decays to two distinct fermions (one lighter, one heavier) whose masses are split by $\Delta = 50$ MeV. This interaction arises generically whenever both Dirac and Majorana masses are present in the dark sector. The lighter state can scatter off detector electrons, nucleons, and nuclei to induce an inelastic transition into the excited (heavier) state, which can promptly decay down to the lighter state while simultaneously emitting a *visible* electron-positron pair with \sim few GeV of energy. The observable in this scenario is the combined electromagnetic energy from this de-excitation including both the target-particle's recoil and energy of the electron positron pair.

target;

- fast timing ($\sigma_T < 70 - 100$ ps) to impose a tight time-coincidence window with a reference signal from the beam (RF) for cosmogenic background rejection;
- simplicity and reliability of operations – plastic is an inert material, which remains reasonably stable over time;
- scalability to larger instrumented volume (at least from CORMORINO to ~ 1 m³ size);
- segmentation for interaction-vertex reconstruction and background rejection enhancement;
- easy sensitivity extension to GeV-energy electrons by sampling the electromagnetic shower produced in thin foils of lead placed between the scintillator bars.

On the other hand, plastic scintillator presents limitations that may be necessary to overcome in a full scale detector:

- limited electron/proton discrimination that, if improved could be useful to reduce backgrounds;
- lack of directionality information to correlate hits with a beam-related event;
- cost of PMTs and number of instrumented channels.

We are considering other options such as: replacing the plastic scintillator with liquid, that, while having similar features, could provide additional advantages; replacing photo-detectors using SiPM

in place of PMTs; reducing segmentation to decrease costs. We are also considering extruded plastic with fiber/sipm readout to scale to a multi m^3 detector. We are investigating the pros and cons of each experimental Hall at JLab, evaluating expected reach, logistic, costs of civil engineering, and other services.

Both the final detector design and experimental set up will be discussed in a full proposal to be submitted to the the next JLab PAC.

5 Summary and Conclusion

We propose to mount an experiment behind one of the high-intensity experimental halls at JLab to search for weakly interacting particles produced in the beam dump. This experiment will have strong, unprecedented sensitivity to dark matter in the MeV – GeV mass range, probing a parameter space two orders of magnitude beyond the reach of past, existing, and proposed experiments. Searches for particles in this mass range are motivated by models that feature a dark matter particle χ whose interactions with the Standard Model (SM) through a new massive dark photon generically appear with strength ϵ near $10^{-4} - 10^{-2}$. Such models can also explain the persistent $3 - 4\sigma$ discrepancy between theoretical predictions and experimental observations of the muon’s anomalous magnetic moment.

The experiment would detect the interaction of elastically scattered χ s off nucleons and electrons in a detector situated about 15 m from the beam dump by measuring the proton and electron recoil energies. The sensitivity of the beam dump experiment and its ability to reject backgrounds was studied based on a case study for an existing detector, CORMORINO, using detailed modeling of both beam related and cosmogenic backgrounds with a GEANT4 simulation. The results of this study were scaled to a 1 m^3 detector to estimate the sensitivity of a full-scale experiment after collecting 10^{22} electrons on target. In the absence of a signal and with energy thresholds as low as 1 MeV for detecting $\chi - p$ interactions, the experiment would be able to set limits on the production of dark matter with masses in the range between 100 and 500 MeV and coupling constants ϵ^2 between 10^{-7} and 10^{-5} , dominated by statistical uncertainty of cosmogenic backgrounds. Elastic $\chi - e$ interactions with thresholds between 0.5 and 2 GeV and essentially no background can be used to set limits on the production of dark matter with masses in the range between 20 and 700 MeV and coupling constants ϵ^2 between 10^{-9} and 10^{-5} . These regions of masses and coupling strengths exceed the expected sensitivity of previous, existing, and proposed experiments by over two orders of magnitude.

References

- [1] R. Essig *et al.*, arXiv:1311.0029 [hep-ph].
- [2] R. Essig *et al.*, Phys. Rev. Lett. **109**, 021301 (2012) [arXiv:1206.2644 [astro-ph.CO]].
- [3] R. Essig, J. Mardon and T. Volansky, Phys. Rev. D **85**, 076007 (2012) [arXiv:1108.5383 [hep-ph]].
- [4] P. W. Graham *et al.*, Phys. Dark Univ. **1**, 32 (2012) [arXiv:1203.2531 [hep-ph]].
- [5] C. Boehm, T. A. Ensslin and J. Silk, J. Phys. G **30**, 279 (2004) [astro-ph/0208458].
- [6] C. Boehm and P. Fayet, Nucl. Phys. B **683**, 219 (2004) [hep-ph/0305261].

- [7] M. Pospelov, A. Ritz and M. B. Voloshin, Phys. Lett. B **662**, 53 (2008) [arXiv:0711.4866 [hep-ph]].
- [8] N. Arkani-Hamed *et al.*, Phys. Rev. D **79**, 015014 (2009) [arXiv:0810.0713 [hep-ph]].
- [9] R. Dharmapalan *et al.* [MiniBooNE Collaboration], arXiv:1211.2258 [hep-ex].
- [10] M. D. Diamond and P. Schuster, Phys. Rev. Lett. **111**, 221803 (2013) [arXiv:1307.6861 [hep-ph]].
- [11] E. Izaguirre *et al.*, arXiv:1403.6826 [hep-ph].
- [12] D. E. Morrissey and A. P. Spray, arXiv:1402.4817 [hep-ph].
- [13] B. Batell, M. Pospelov and A. Ritz, Phys. Rev. D **80**, 095024 (2009) [arXiv:0906.5614 [hep-ph]].
- [14] P. deNiverville, M. Pospelov and A. Ritz, Phys. Rev. D **84**, 075020 (2011) [arXiv:1107.4580 [hep-ph]].
- [15] P. deNiverville, D. McKeen and A. Ritz, Phys. Rev. D **86**, 035022 (2012) [arXiv:1205.3499 [hep-ph]].
- [16] L. B. Auerbach *et al.* [LSND Collaboration], Phys. Rev. D **63**, 112001 (2001) [hep-ex/0101039].
- [17] R. Dharmapalan *et al.* [MiniBooNE Collaboration], “A proposal to Search for Dark Matter with MiniBooNE,” Proposal to the FNAL PAC, P - 1032, Dec 2013
- [18] E. Izaguirre *et al.*, Phys. Rev. D **88**, 114015 (2013) [arXiv:1307.6554 [hep-ph]].
- [19] J. D. Bjorken *et al.*, Phys. Rev. D **38**, 3375 (1988).
- [20] R. Essig and Z. Surujon, to appear.
- [21] D. Tucker-Smith and N. Weiner, Phys. Rev. D **64**, 043502 (2001) [hep-ph/0101138].
- [22] J. D. Bjorken *et al.*, Phys. Rev. D **80**, 075018 (2009) [arXiv:0906.0580 [hep-ph]].
- [23] M. Raggi and V. Kozhuharov, arXiv:1403.3041 [physics.ins-det].
- [24] B. Aubert *et al.* [BaBar Collaboration], arXiv:0808.0017 [hep-ex].
- [25] B. Wojtsekhowski, D. Nikolenko and I. Rachek, arXiv:1207.5089 [hep-ex].
- [26] S. Andreas *et al.*, arXiv:1312.3309 [hep-ex].
- [27] V. Baturin *et al.*, Nucl. Instrum. and Meth. **A 562** 327 (2006) .
- [28] M. Ungaro, CLAS12 GEANT4 Simulation Package GEMC, <http://gemc.jlab.org>.
- [29] I. C. Appleton, Nucl. Phys. **B26**, 365 (1971).
- [30] J. N. Bahcall and M. H. Pinsonneault, Phys. Rev Lett. **92**, 121301 (2004).
- [31] I. Gil-Botella and A. Rubbia, Jour. Cosm. Astr. Phys. 0408 001 (2004).
- [32] M. S. Gordon *et al.*, IEEE Transactions on Nuclear Science, **51**, 3427 (2004).
- [33] M. Anghinolfi *et al.*, Nucl. Instr. and Meth. A **537**, 562 (2005).