

Graphs of Edge-Intersecting Non-Splitting Paths in a Tree: Representations of Holes-Part II^{*†}

Arman Boyacı¹ Tınaz Ekim¹ Mordechai Shalom^{1,2 ‡} Shmuel Zaks³

¹ Department of Industrial Engineering, Bogazici University, Istanbul, Turkey

² TelHai College, Upper Galilee, 12210, Israel

³ Department of Computer Science, Technion, Haifa, Israel

received 14th Aug. 2016, revised 3rd Oct. 2017, accepted 19th Dec. 2017.

Given a tree and a set \mathcal{P} of non-trivial simple paths on it, $\text{VPT}(\mathcal{P})$ is the VPT graph (i.e. the vertex intersection graph) of the paths \mathcal{P} , and $\text{EPT}(\mathcal{P})$ is the EPT graph (i.e. the edge intersection graph) of \mathcal{P} . These graphs have been extensively studied in the literature. Given two (edge) intersecting paths in a graph, their *split vertices* is the set of vertices having degree at least 3 in their union. A pair of (edge) intersecting paths is termed *non-splitting* if they do not have split vertices (namely if their union is a path). We define the graph $\text{ENPT}(\mathcal{P})$ of edge intersecting non-splitting paths of a tree, termed the ENPT graph, as the graph having a vertex for each path in \mathcal{P} , and an edge between every pair of vertices representing two paths that are both edge-intersecting and non-splitting. A graph G is an ENPT graph if there is a tree T and a set of paths \mathcal{P} of T such that $G = \text{ENPT}(\mathcal{P})$, and we say that $\langle T, \mathcal{P} \rangle$ is a *representation* of G .

Our work follows Golubic and Jamison's research, in which they defined the EPT graph class, and characterized the representations of chordless cycles (holes). Our main goal is the characterization of the representations of chordless ENPT cycles. To achieve this goal, we assume that the EPT graph induced by the vertices of an ENPT hole is given. We use the results of that research as building blocks in order to discover this characterisation, which turn out to have a more complex structure than in the case of EPT holes. In the first part of this work we have shown that cycles, trees and complete graphs are ENPT graphs. We also introduced three assumptions $(P1)$, $(P2)$, $(P3)$ defined on EPT, ENPT pairs of graphs, and characterized the representations of ENPT holes that satisfy $(P1)$, $(P2)$, $(P3)$. In this work we relax two of these three assumptions and characterize the representations of ENPT holes satisfying $(P3)$. These two results are achieved by providing polynomial-time algorithms. Last we show that the problem of finding such a representation is NP-Hard in general, i.e. without assumption $(P3)$. This result extends in some sense the NP-Hardness of EPT graph recognition shown in Golubic and Jamison's work.

Keywords: Intersection Graphs, Path Graphs, EPT Graphs

1 Introduction

1.1 Background

Given a tree T and a set \mathcal{P} of non-trivial simple paths in T , the Vertex Intersection Graph of Paths in a Tree (VPT) and the Edge Intersection Graph of Paths in a Tree (EPT) of \mathcal{P} are denoted by $\text{VPT}(\mathcal{P})$ and $\text{EPT}(\mathcal{P})$, respectively. Both graphs have \mathcal{P} as vertex set. $\text{VPT}(\mathcal{P})$ (resp. $\text{EPT}(\mathcal{P})$) contains an edge between two vertices if the corresponding two paths intersect in at least one vertex (resp. edge). A graph G is VPT (resp. EPT) if there exist a tree T and a set \mathcal{P} of non-trivial simple path in T such that G is isomorphic to $\text{VPT}(\mathcal{P})$ (resp. $\text{EPT}(\mathcal{P})$). In this case we say that $\langle T, \mathcal{P} \rangle$ is a VPT (resp. an EPT) representation of G .

In this work we focus on edge intersections of paths, therefore whenever we are concerned with intersection of paths we omit the word "edge" and simply write that two paths *intersect*. The graph of edge intersecting and non-splitting paths of a tree (ENPT) of a given representation $\langle T, \mathcal{P} \rangle$ as described above, denoted by $\text{ENPT}(\mathcal{P})$, has a vertex v for each path P_v of \mathcal{P} and two vertices u, v of $\text{ENPT}(\mathcal{P})$ are adjacent if the paths P_u and P_v intersect

^{*}This work was supported in part by the Israel Science Foundation grant No. 1249/08, by TUBITAK PIA BOSPHORUS Grant No. 111M303 and by the TUBITAK 2221 Programme.

[†]A preliminary version of this paper was presented in WG 2013 (Boyacı et al. (2013)).

[‡]Part of this work is accomplished while this author was visiting Bogazici University, Department of Industrial Engineering, under the TUBITAK 2221 Program whose support is greatly acknowledged.

and do not split (that is, their union is a path). A graph G is an ENPT graph if there is a tree T and a set of paths \mathcal{P} of T such that G is isomorphic to $\text{ENPT}(\mathcal{P})$. We note that $\text{EPT}(\mathcal{P}) = \text{ENPT}(\mathcal{P})$ is an interval graph whenever T is a path. Therefore, the class ENPT includes all interval graphs.

EPT and VPT graphs have applications in communication networks. Consider a communication network of a tree topology T . The message routes to be delivered in this communication network are paths on T . Two paths conflict if they both require to use the same link (node). This conflict model is equivalent to an EPT (a VPT) graph. Suppose we try to find a schedule for the messages such that no two messages sharing a link (node) are scheduled in the same time interval. Then a vertex coloring of the EPT (VPT) graph corresponds a feasible schedule on this network.

EPT graphs also appear in all-optical telecommunication networks. The so-called Wavelength Division Multiplexing (WDM) technology can multiplex different signals onto a single optical fiber by using different wavelength ranges of the laser beam (Chlamtac et al. (1992); Ramaswami (1993)). WDM is a promising technology enabling us to deal with the massive growth of traffic in telecommunication networks, due to applications such as video-conferencing, cloud computing and distributed computing (Du and Vetter (1993)). A stream of signals traveling from its source to its destination in optical form is termed a *lightpath*. A lightpath is realized by signals traveling through a series of fibers, on a certain wavelength. Specifically, Wavelength Assignment problems (WLA) are a family of path coloring problems that aim to assign wavelengths (i.e. colors) to lightpaths, so that no two lightpaths with a common edge receive the same wavelength and a certain objective function (depending on the problem) is minimized. *Traffic Grooming* is the term used for combination of several low-capacity requests into one lightpath using Time Division Multiplexing (TDM) technology (Gerstel et al. (1998)). In this context a set of paths can be combined into one lightpath, thus receiving the same color, as long as they satisfy the following two conditions:

- The load condition: at most g lightpaths using the same fiber may receive the same color, where g is an integer termed *the grooming factor*.
- The union of the paths receiving the same color should constitute a path or a set of disjoint paths.

It follows that a feasible solution of the traffic grooming problem is a vertex coloring of the graph $\text{EPT}(\mathcal{P}) \setminus \text{ENPT}(\mathcal{P})$ where each color class induces a sub-graph of $\text{EPT}(\mathcal{P})$ with clique number at most g . Therefore, it makes sense to analyze the structure of these graph pairs, i.e. the two graphs $\text{EPT}(\mathcal{P})$ and $\text{ENPT}(\mathcal{P})$ defined on the same set of vertices.

1.2 Related Work

EPT and VPT graphs have been extensively studied in the literature. Although VPT graphs can be characterized by a fixed number of forbidden subgraphs (Lévêque et al. (2009)), Golubic and Jamison (1985b) showed that EPT graph recognition is NP-Complete. Edge intersection and vertex intersection give rise to identical graph classes in the case of paths in a line and in the case of subtrees of a tree. However, VPT graphs and EPT graphs are incomparable in general; neither VPT nor EPT contains the other. Main optimization and decision problems such as recognition, maximum clique, minimum vertex coloring and the maximum stable set are shown to be polynomial-time solvable for VPT graphs by Gavril (1978), Gavril (2000), Golubic (2004) and Spinrad and Sritharan (1995), respectively. The recognition and minimum vertex coloring problems are shown to remain NP-Complete for EPT graphs by Golubic and Jamison (1985b,a). In contrast, one can solve in polynomial time the maximum clique and the maximum stable set problems in EPT graphs (Golubic and Jamison (1985a) and Tarjan (1985), respectively).

After these works on EPT and VPT graphs in the early 80's, this topic did not attract much further study until very recently. Current research on intersection graphs is concentrated on the comparison of various intersection graphs of paths in a tree and their relation to chordal and weakly chordal graphs (Golubic et al. (2008a,c)). Also, a tolerance model is studied in Golubic et al. (2008b) via k -edge intersection graphs where two vertices are adjacent if their corresponding paths intersect on at least k edges. Besides, several recent papers consider the edge intersection graphs of paths on a grid (e.g. Biedl and Stern (2010)).

Another related line of research is subsets of EPG (i.e., edge-intersection of paths in a grid) graphs. Since every graph is an EPG graph, research in this field focuses on subsets of this class of graphs that are obtained by imposing some restrictions on the paths in their representation. The most researched such restriction is an upper bound on the number of bends on every single path (e.g. Golubic et al. (2009), Heldt et al. (2014), Epstein et al. (2013)). The recent work of Cameron et al. (2016) considers the subsets of one bend path obtained by restricting their orientation in the plane. Pergel and Rzażewski (2016) focus on graphs admitting EPG representations by paths with at most 2 bends and show that their recognition along with some subclasses of them is NP-Complete.

1.3 Our Contribution

In the first part of this work (Boyacı et al. (2016)), we define the family of ENPT graphs, and investigate its basic properties. We show that trees, cliques and cycles are ENPT graphs. In the same work we started the study of the characterization of ENPT representations of holes. To achieve this goal we assume that the input is augmented by the underlying EPT graph. More particularly, we study pairs (G, C) of graphs where $G = \text{EPT}(\mathcal{P})$ and $C = \text{ENPT}(\mathcal{P})$ for some representation $\langle T, \mathcal{P} \rangle$. For any given such pair of graphs (G, C) that satisfy three assumptions $(P1)$, $(P2)$, $(P3)$ and C is a Hamiltonian cycle of G , we characterize the minimal representation of (G, C) as a planar tour of the weak dual of G . In this work we extend these results. Namely a) we provide an algorithm that returns the minimal representation of a given pair of graphs (G, C) that satisfy $(P3)$ and C is a Hamiltonian cycle of G , b) using this algorithm we characterize the representations of such pairs, and c) we show that for a given pair (G, C) in general, i.e. when (G, C) does not necessarily satisfy $(P3)$, it is NP-Hard to decide whether (G, C) has a representation.

Our approach can be summarized as follows. Given a pair (G, C) , we first remove (K_4, P_4) pairs and contract all contactable ENPT edges. A contraction operation corresponds to a union of two paths in the representation. Then we study the reverse operations of contractions (union in the representation) and characterization of representations of (K_4, P_4) s. In Section 2 we give definitions and preliminaries. In Section 3 we present basic results related to contraction, describe an algorithm returning minimal representations of pairs satisfying assumptions $(P2)$ and $(P3)$. Using this algorithm we characterize these representations. In Section 4 we characterize the representations of (K_4, P_4) pairs, we define an aggressive contraction operation and we present an algorithm that returns the minimal representation of a given pair (G, C) satisfying $(P3)$, through which we characterize the representations. In Section 5 we show that when $(P3)$ does not hold, there does not exist a polynomial-time algorithm to find a representation of a given pair (G, C) , unless $P = NP$.

2 Preliminaries

In this section we provide definitions used in the paper, present known results related to our work, and develop basic results. The section is organized as follows: Section 2.1 is devoted to basic definitions. In Section 2.2 we present known results on EPT graphs that are closely related to our work. Section 2.3 summarizes known results related to ENPT graphs and pairs.

2.1 Definitions

Notation:

Given a graph G and a vertex v of G , we denote by $\delta_G(v)$ the set of edges of G incident to v , by $N_G(v)$ the set consisting of v and its neighbors in G , and by $d_G(v) = |\delta_G(v)|$ the degree of v in G . A vertex is called a *leaf* (resp. *intermediate vertex*, *junction*) if $d_G(v) = 1$ (resp. $= 2, \geq 3$). Whenever there is no ambiguity we omit the subscript G and write $\delta(v)$, $d(v)$, and $N(v)$.

Given a graph G , $\bar{V} \subseteq V(G)$ and $\bar{E} \subseteq E(G)$ we denote by $G[\bar{V}]$ and $G[\bar{E}]$ the subgraphs of G induced by \bar{V} and by \bar{E} , respectively.

The *union* of two graphs G, G' is the graph $G \cup G' \stackrel{\text{def}}{=} (V(G) \cup V(G'), E(G) \cup E(G'))$. The *join* $G + G'$ of two disjoint graphs G, G' is the graph $G \cup G'$ together with all the edges joining $V(G)$ and $V(G')$, i.e. $G + G' \stackrel{\text{def}}{=} (V(G) \cup V(G'), E(G) \cup E(G') \cup (V(G) \times V(G')))$.

Given a (simple) graph G and $e \in E(G)$, we denote by G/e the (simple) graph obtained by contracting the edge e of G , i.e. by coinciding the two endpoints of $e = \{p, q\}$ to a single vertex p, q , and then removing self loops and parallel edges. Let $\bar{E} = \{e_1, e_2, \dots, e_k\} \subseteq E(G)$. We denote by $G/e_1, \dots, e_k$ the graph obtained from $G/e_1, \dots, e_{k-1}$ by contracting the (image of the) edge e_k . The effect of such a sequence of contractions is equivalent to contracting every connected component of $G[\{e_1, \dots, e_k\}]$ to a vertex. Therefore, the order of contractions is not important, i.e. for any permutation π of $\{1, \dots, k\}$ we have $G/e_1, \dots, e_{k-1} = G/e_{\pi(1)}, \dots, e_{\pi(k-1)}$. Based on this fact, we denote by G/\bar{E} the graph obtained by contracting the edges of \bar{E} (in any order).

For two vertices u, v of a tree T we denote by $p_T(u, v)$ the unique path between u and v in T . A vertex w of a path P that is not an endpoint of P is termed an *internal vertex* of P . We also say that P *crosses* w . A *cherry* of a tree T is a connected subgraph of T consisting of two leaves of T adjacent to an internal vertex of T .

Intersections and union of paths:

Given two paths P, P' in a graph, we write $P \parallel P'$ to denote that P and P' are non-intersecting, i.e. *edge-disjoint*. The *split vertices* of P and P' is the set of junctions in their union $P \cup P'$ and is denoted by $\text{split}(P, P')$. Whenever

P and P' intersect and $split(P, P') = \emptyset$ we say that P and P' are *non-splitting* and denote this by $P \sim P'$. In this case $P \cup P'$ is a path or a cycle. When P and P' intersect and $split(P, P') \neq \emptyset$ we say that they are *splitting* and denote this by $P \approx P'$. Clearly, for any two paths P and P' exactly one of the following holds: $P \parallel P'$, $P \sim P'$, $P \approx P'$.

When the graph G is a tree, the union $P \cup P'$ of two intersecting paths P, P' on G is a tree with at most two junctions, i.e. $|split(P, P')| \leq 2$ and $P \cup P'$ is a path whenever $P \sim P'$.

The VPT, EPT and ENPT graphs:

Let \mathcal{P} be a set of paths in a tree T . The graphs $VPT(\mathcal{P})$, $EPT(\mathcal{P})$ and $ENPT(\mathcal{P})$ are graphs such that $V(ENPT(\mathcal{P})) = V(EPT(\mathcal{P})) = V(VPT(\mathcal{P})) = \{p | P_p \in \mathcal{P}\}$. Given two distinct paths $P_p, P_q \in \mathcal{P}$, $\{p, q\}$ is an edge of $ENPT(\mathcal{P})$ if $P_p \sim P_q$, and $\{p, q\}$ is an edge of $EPT(\mathcal{P})$ (resp. $VPT(\mathcal{P})$) if P_p and P_q have a common edge (resp. vertex) in T . See Figure 1 for an example. From these definitions it follows that

Observation 2.1 $E(ENPT(\mathcal{P})) \subseteq E(EPT(\mathcal{P})) \subseteq E(VPT(\mathcal{P}))$.

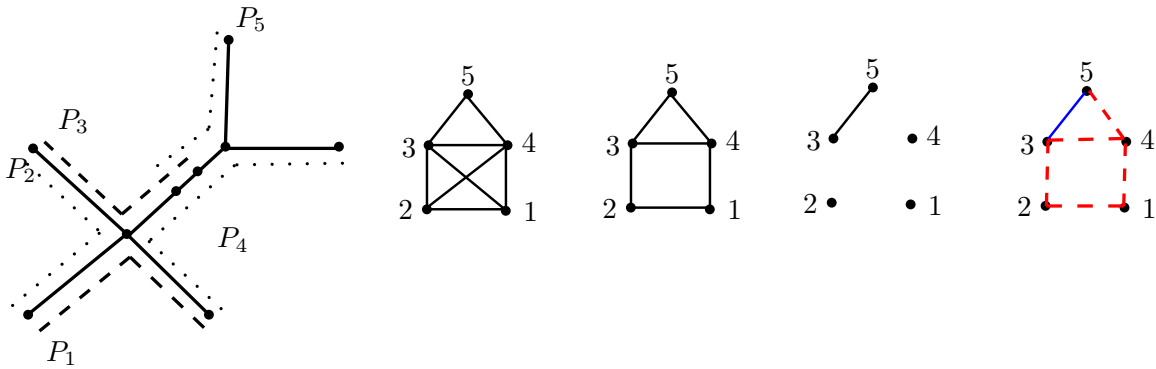

Fig. 1: A host tree T , a collection of paths $\mathcal{P} = \{P_1, P_2, P_3, P_4, P_5\}$ defined on T and the corresponding graphs $VPT(\mathcal{P})$, $EPT(\mathcal{P})$ and $ENPT(\mathcal{P})$. The last sub-figure shows the graphs $EPT(\mathcal{P})$ and $ENPT(\mathcal{P})$ where their common edge is depicted as a solid line.

Two graphs G and G' such that $V(G) = V(G')$ and $E(G') \subseteq E(G)$ are termed a *pair (of graphs)* denoted as (G, G') . If $EPT(\mathcal{P}) = G$ (resp. $ENPT(\mathcal{P}) = G$) we say that $\langle T, \mathcal{P} \rangle$ is an EPT (resp. ENPT) representation for G . If $EPT(\mathcal{P}) = G$ and $ENPT(\mathcal{P}) = G'$ we say that $\langle T, \mathcal{P} \rangle$ is a representation for the pair (G, G') . Given a pair (G, G') the sub-pair induced by $\bar{V} \subseteq V(G)$ is the pair $(G[\bar{V}], G'[\bar{V}])$. Clearly, any representation of a pair induces representations for its induced sub-pairs, i.e. the pairs have the hereditary property.

A *cherry* of a representation $\langle T, \mathcal{P} \rangle$ is a cherry of T with leaves v, v' such that v (resp. v') is an endpoint of exactly one path P (resp. P') of \mathcal{P} , and $P \neq P'$.

Throughout this work, in all figures, the edges of the tree T of a representation $\langle T, \mathcal{P} \rangle$ are drawn as solid edges whereas the paths on the tree are shown by dashed, dotted, etc. edges. Similarly, edges of $ENPT(\mathcal{P})$ are drawn with solid or blue lines whereas edges in $E(EPT(\mathcal{P})) \setminus E(ENPT(\mathcal{P}))$ are dashed or red. We sometimes refer to them as blue and red edges respectively. For an edge $e = \{p, q\}$ we use $split(e)$ as a shorthand for $split(P_p, P_q)$. We note that e is a red edge if and only if $split(e) \neq \emptyset$.

Cycles, Chords, Holes, Outerplanar graphs, Weak dual trees:

Given a graph G and a cycle C of it, a *chord* of C in G is an edge of $E(G) \setminus E(C)$ connecting two vertices of $V(C)$. The *length* of a chord connecting the vertices i, j is the length of a shortest path between i and j on C . C is a *hole* (chordless cycle) of G if G does not contain any chord of C . This is equivalent to saying that the subgraph $G[V(C)]$ of G induced by the vertices of C is a cycle. For this reason a chordless cycle is also called an *induced cycle*.

An *outerplanar* graph is a planar graph that can be embedded in the plane such that all its vertices are on the unbounded face of the embedding. An outerplanar graph is Hamiltonian if and only if it is biconnected; in this case the unbounded face forms the unique Hamiltonian cycle. The *weak dual* graph of a planar graph G is the graph obtained from its dual graph, by removing the vertex corresponding to the unbounded face of G . The weak dual graph of an outerplanar graph is a forest, and in particular the weak dual graph of a Hamiltonian outerplanar graph

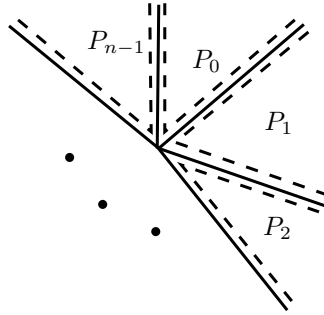

Fig. 2: The EPT representation of cycle graph on n vertices: a pie.

is a tree (Chartrand and Harary (1967)). When working with outerplanar graphs we use the term *face* to mean a bounded face.

2.2 EPT Graphs

We now present definitions and results from the work of Golombic and Jamison (1985a) that we use throughout this work.

A *pie* of a representation $\langle T, \mathcal{P} \rangle$ of an EPT graph is an induced star $K_{1,k}$ of T with k leaves $v_0, v_1, \dots, v_{k-1} \in V(T)$, and k paths $P_0, P_1, \dots, P_{k-1} \in \mathcal{P}$, such that for every $0 \leq i \leq k-1$ both v_i and $v_{(i+1) \bmod k}$ are vertices of P_i . We term the central vertex of the star as the *center* of the pie (See Figure 2). It is easy to see that the EPT graph of a pie with k leaves is the hole C_k on k vertices. Moreover, this is the only possible EPT representation of C_k when $k \geq 4$.

Theorem 2.1 *Golombic and Jamison (1985a)* If an EPT graph contains a hole with $k \geq 4$ vertices, then every representation of it contains a pie with k paths.

Let $\mathcal{P}_e \stackrel{\text{def}}{=} \{p \in \mathcal{P} \mid e \in p\}$ be the set of paths in \mathcal{P} containing the edge e . A star $K_{1,3}$ is termed a *claw*. For a claw K of a tree T , $\mathcal{P}[K] \stackrel{\text{def}}{=} \{p \in \mathcal{P} \mid p \text{ uses two edges of } K\}$. It is easy to see that both $\text{EPT}(\mathcal{P}_e)$ and $\text{EPT}(\mathcal{P}[K])$ are cliques. These cliques are termed *edge-clique* and *claw-clique*, respectively. Moreover, these are the only possible representations of cliques.

Theorem 2.2 *Golombic and Jamison (1985a)* Any maximal clique of an EPT graph with representation $\langle T, \mathcal{P} \rangle$ corresponds to a subcollection \mathcal{P}_e of paths for some edge e of T , or to a subcollection $\mathcal{P}[K]$ of paths for some claw K of T .

Note that a claw-clique is a pie with 3 leaves.

2.3 ENPT Graphs and EPT, ENPT Graph Pairs

In this section we present definitions and results from Boyacı et al. (2016) that we use throughout this work, introduce new terms, and prove basic results.

Equivalent and minimal representations:

We say that the representations $\langle T_1, \mathcal{P}_1 \rangle$ and $\langle T_2, \mathcal{P}_2 \rangle$ are *equivalent*, and denote by $\langle T_1, \mathcal{P}_1 \rangle \cong \langle T_2, \mathcal{P}_2 \rangle$, if their corresponding EPT and ENPT graphs are isomorphic under the same isomorphism (in other words, if they constitute representations of the same pair of graphs (G, G')).

We write $\langle T_1, \mathcal{P}_1 \rangle \succeq \langle T_2, \mathcal{P}_2 \rangle$ or equivalently $\langle T_2, \mathcal{P}_2 \rangle \preceq \langle T_1, \mathcal{P}_1 \rangle$ if $\langle T_2, \mathcal{P}_2 \rangle$ can be obtained from $\langle T_1, \mathcal{P}_1 \rangle$ by zero or more of the following two operations that we term as *minifying* operations.

- Contraction of an edge e of T_1 (and of all the paths in \mathcal{P}_1 using e). We denote this operation as $\text{contract}(e)$.
- Removal of an initial edge (*tail*) e of a path P of \mathcal{P}_1 . We denote this operation as $\text{tr}(P, e)$.

We say that $\langle T, \mathcal{P} \rangle$ is a *minimal* representation, if it is minimal in the partial order \preceq defined over all the representations representing the same pair as $\langle T, \mathcal{P} \rangle$. Throughout the work we aim at characterizing minimal representations. Whenever a sequence of minifying operations contains two operations $\text{tr}(P, e)$ and $\text{contract}(e)$ in this order, the first operation can be deleted from the sequence, to obtain a shorter and equivalent sequence.

A sequence that can not be shortened in this way and contains the biggest number of $contract(e)$ operations is termed a *minimal* sequence. Whenever $\langle T_1, \mathcal{P}_1 \rangle \succeq \langle T_2, \mathcal{P}_2 \rangle$ we consider only minimal sequences of minifying operations that transform $\langle T_1, \mathcal{P}_1 \rangle$ to $\langle T_2, \mathcal{P}_2 \rangle$. We observe two properties of such sequences.

Lemma 2.1 *Let $\langle T_1, \mathcal{P}_1 \rangle \succeq \langle T_2, \mathcal{P}_2 \rangle$, and s be a minimal sequence of minifying operations transforming $\langle T_1, \mathcal{P}_1 \rangle$ to $\langle T_2, \mathcal{P}_2 \rangle$. Then every permutation of s also transforms $\langle T_1, \mathcal{P}_1 \rangle$ to $\langle T_2, \mathcal{P}_2 \rangle$.*

Proof: If $contract(e)$ is an operation of s then there is no other operation in s involving e . This is because such an operation is impossible after $contract(e)$, and if it appears before $contract(e)$ it contradicts the minimality of s . To conclude the result, we observe that any two successive operations in s are interchangeable. Indeed, for two distinct edges e, e' the operations $contract(e), contract(e')$ (resp. $contract(e), tr(P, e')$) are interchangeable, and for two not necessarily distinct edges e, e' the operations $tr(P, e), tr(P', e')$ are interchangeable. \square

Lemma 2.2 *If $\langle T_1, \mathcal{P}_1 \rangle \succeq \dots \succeq \langle T_n, \mathcal{P}_n \rangle$ and $\langle T_1, \mathcal{P}_1 \rangle \cong \langle T_n, \mathcal{P}_n \rangle$, then $\langle T_1, \mathcal{P}_1 \rangle \cong \dots \cong \langle T_n, \mathcal{P}_n \rangle$.*

Proof: Let $G_i = EPT(\mathcal{P}_i)$ and $G'_i = ENPT(\mathcal{P}_i)$. We observe that both minifying operations are monotonic in the sense that they neither introduce neither new intersections, nor new splits. Namely, for $1 \leq i < n$, $E(G_{i+1}) \subseteq E(G_i)$ and $E(G_{i+1}) \setminus E(G'_{i+1}) \subseteq E(G_i) \setminus E(G'_i)$. As $\langle T_1, \mathcal{P}_1 \rangle \cong \langle T_n, \mathcal{P}_n \rangle$ we have $(G_1, G'_1) = (G_n, G'_n)$, i.e. $E(G_n) = E(G_1)$ and $E(G_n) \setminus E(G'_n) = E(G_1) \setminus E(G'_1)$. Therefore, $E(G_1) = \dots = E(G_n)$ and $E(G_1) \setminus E(G'_1) = \dots = E(G_n) \setminus E(G'_n)$, concluding $(G_1, G'_1) = \dots = (G_n, G'_n)$. \square

EPT holes:

Lemma 2.3 *A hole of size at least 4 of an EPT graph does not contain blue (i.e. ENPT) edges.*

Proof: Consider the pie representation of some hole of an EPT graph. For any two paths P_p, P_q of this pie, we have either $P_p \approx P_q$ or $P_p \parallel P_q$, therefore $\{p, q\}$ is not an ENPT edge. \square

Combining Lemma 2.3 with Theorem 2.1, we obtain the following characterization of pairs (C_k, G') . For a pair (C_k, G') , exactly one of the following holds:

- $k > 3$. In this case C_k is represented by a pie. Therefore, G' is an independent set. In other words, C_k consists of red edges. We term such a cycle, a red hole.
- $k = 3$ and C_k consists of red edges. G' is an independent set. We term such a cycle a red triangle.
- $k = 3$ and C_k contains exactly one ENPT (blue) edge. We term such a cycle a *BRR* triangle, and its representation is an edge-clique.
- $k = 3$ and C_k contains two ENPT (blue) edges. We term such a cycle a *BBR* triangle, and its representation is an edge-clique.
- $k = 3$ and C_k consists of blue edges ($G' = C_3$). We term such a cycle a blue triangle, and its representation is an edge-clique.

EPT contraction:

Let $\langle T, \mathcal{P} \rangle$ be a representation and $P_p, P_q \in \mathcal{P}$ such that $P_p \sim P_q$. We denote by $\langle T, \mathcal{P} \rangle_{/P_p, P_q}$ the representation that is obtained from $\langle T, \mathcal{P} \rangle$ by replacing the two paths P_p, P_q by the path $P_p \cup P_q$, i.e. $\langle T, \mathcal{P} \rangle_{/P_p, P_q} \stackrel{def}{=} \langle T, \mathcal{P} \setminus \{P_p, P_q\} \cup \{P_p \cup P_q\} \rangle$. We term this operation a *union*. Lemma 2.4 follows from the below observation.

Observation 2.2 *For every $P_p, P_q, P_r \in \mathcal{P}$ such that $P_p \sim P_q$, $split(P_p \cup P_q, P_r) = split(P_p, P_r) \cup split(P_q, P_r)$.*

Lemma 2.4 *Boyacı et al. (2016) Let $\langle T, \mathcal{P} \rangle$ be a representation for the pair (G, G') , and let $e = \{p, q\} \in E(G')$. Then $G_{/e}$ is an EPT graph. Moreover, $G_{/e} = EPT(\langle T, \mathcal{P} \rangle_{/P_p, P_q})$.*

Contraction of pairs:

The definition of the contraction operation extends to pairs: The contraction of an ENPT edge does not necessarily correspond to the union operation in the ENPT representation. For example, let P_p, P_q and $P_{q'}$ be such that $P_p \sim P_q$, $P_p \sim P_{q'}$ and $P_q \approx P_{q'}$. Then $G'_{/\{p, q\}}$ is not isomorphic to $ENPT(\langle T, \mathcal{P} \rangle_{/P_p, P_q})$ as $\{q', p, q\} \notin E(ENPT(\langle T, \mathcal{P} \rangle_{/P_p, P_q}))$. Let (G, G') be a pair and $e \in E(G')$. If for every edge $e' \in E(G')$ incident to e , the

edge $e'' = e\Delta e'$ (forming a triangle together with e and e') is not an edge of G then $(G, G')_{/e} \stackrel{\text{def}}{=} (G_{/e}, G'_{/e})$, otherwise $(G, G')_{/e}$ is undefined. Whenever $(G, G')_{/e}$ is defined we say that (G, G') is *contractable* on e , or when there is no ambiguity about the pair under consideration we say that e is *contractable*. We say that a pair is contractable if it is contractable on some ENPT edge. Clearly, (G, G') is not contractable if and only if every edge of G' is contained in at least one *BBR* triangle.

Weak Dual Trees:

The definition of weak dual tree is extended from Hamiltonian outerplanar graphs to any Hamiltonian graph as follows. Given a pair (G, C) where C is a Hamiltonian cycle of G , a weak dual tree of (G, C) is the weak dual tree $\mathcal{W}(G, C)$ of an arbitrary Hamiltonian maximal outerplanar subgraph $\mathcal{O}(G, C)$ of G . $\mathcal{O}(G, C)$ can be built by starting from C and adding to it arbitrarily chosen chords from G as long as such chords exist and the resulting graph is planar.

By definition of a dual graph, vertices of $\mathcal{W}(G, C)$ correspond to faces of $\mathcal{O}(G, C)$. By maximality, the faces of $\mathcal{O}(G, C)$ correspond to holes of G . The degree of a vertex of $\mathcal{W}(G, C)$ is the number of red edges in the corresponding face of $\mathcal{O}(G, C)$. To emphasize the difference, for an outerplanar graph G we will say *the* weak dual tree of G , whereas for a (not necessarily outerplanar) graph G we will say *a* weak dual tree of G .

The following lemma describes the effect of contraction on weak dual trees.

Lemma 2.5 *Boyacı et al. (2016)* Let (G, C) be a pair satisfying (P2), (P3) and let $\mathcal{W}(G, C)$ be a weak dual tree of (G, C) . (i) There is a bijection between the contractable edges of (G, C) and the intermediate vertices of $\mathcal{W}(G, C)$. (ii) The tree obtained from $\mathcal{W}(G, C)$ by smoothing out the intermediate vertex corresponding to a contractable edge e is a possible weak dual tree of $(G, C)_{/e}$.

Representations of ENPT holes:

Our goal in this work is to characterize the representations of ENPT holes. More precisely we characterize representations of pairs (G, C_n) where C_n is a Hamiltonian cycle of G . For this purpose we define the following problem.

HAMILTONIANPAIRREC

Input: A pair (G, C_n) where C_n is a Hamiltonian cycle of G

Output: A minimal representation $\langle T, \mathcal{P} \rangle$ of (G, C_n) if such a representation exists, “NO” otherwise.

For $n = 3$ the only possible pair is (C_3, C_3) whose unique minimal representation is by 3 identical paths consisting of one edge each.

Let T be a tree with k leaves and $\pi = (\pi_0, \dots, \pi_{k-1})$ a cyclic permutation of the leaves. The *tour* (T, π) is the following set of $2k$ paths: (T, π) contains k *long* paths, each of which connecting two consecutive leaves $\pi_i, \pi_{i+1 \bmod k}$. (T, π) contains k *short* paths, each of which connecting a leaf π_i and its unique neighbor in T .

A *planar embedding* of a tour is a planar embedding of the underlying tree such that any two paths of the tour do not cross each other. A tour is *planar* if it has a planar embedding. Note that a tour (T, π) is planar if and only if π corresponds to the order in which the leaves are encountered by some DFS traversal of T .

Consider the following three properties

- (P1): (G, C_n) is not contractable.
- (P2): (G, C_n) is (K_4, P_4) -free, i.e., it does not contain an induced sub-pair isomorphic to a (K_4, P_4) .
- (P3): Every red triangle of (G, C_n) is a claw-clique, i.e. corresponds to a pie of $\langle T, \mathcal{P} \rangle$.

Note that (P1) and (P2) are properties of pairs and (P3) is a property of representations. We say that (P3) holds for a pair (G, C) whenever it has a representation $\langle T, \mathcal{P} \rangle$ satisfying (P3). It is convenient to define the following problem.

P3-HAMILTONIANPAIRREC

Input: A pair (G, C_n) where C_n is a Hamiltonian cycle of G and $n \geq 4$.

Output: A minimal representation $\langle T, \mathcal{P} \rangle$ of (G, C_n) that satisfies (P3) if such a representation exists, “NO” otherwise.

In this work we extend the following results of Boyacı et al. (2016).

Theorem 2.3 *Boyacı et al. (2016) Instances of P3-HAMILTONIANPAIRREC satisfying properties (P1), (P2) can be solved in polynomial time. YES instances have a unique solution, and whenever $n \geq 5$ this solution is a planar tour.*

Theorem 2.4 *Boyacı et al. (2016) If $n > 4$ the following statements are equivalent:*

- (i) (G, C_n) satisfies assumptions (P1 – 3).
- (ii) (G, C_n) has a unique minimal representation satisfying (P3) which is a planar tour of a weak dual tree of G .
- (iii) G is Hamiltonian outerplanar and every face adjacent to the unbounded face F is a triangle having two edges in common with F , (i.e. a BBR triangle).

For $n = 4$ there are two possible pairs, namely (K_4, P_4) and $(K_4 - e, C_4)$, each of which satisfies (P1), (P2) and has a unique minimal representation. Therefore, in this work we assume $n \geq 5$.

The opposite of a sequence of union operations that create one path is termed *breaking apart*. Namely, breaking apart a path P is to replace it with paths P_1, \dots, P_k such that $\cup_{i=1}^k P_i = P$, $\forall 1 \leq i < k, P_i \cap P_{i+1} \neq \emptyset$, and $P_i \subseteq P_j$ if and only if $i = j$. A *broken tour* is a representation obtained from a tour by subdividing edges and breaking apart long paths of the tour. Clearly, if the tour is planar the broken tour is also planar, i.e. has a planar embedding.

3 Pairs (G, C) Satisfying (P2) and (P3)

In this section our goal is to get rid of the assumption that (P1) holds, so that to characterize representation of pairs that satisfy only (P2) and (P3). Recall that property (P1) states that the pair is uncontractable. We therefore, consider contractable pairs and examine the effects of the contraction on the representation. In this way we reduce the problem to the base case of uncontractable pairs where all assumptions hold for which the representations are already known. In Section 3.1 we investigate the basic properties of the contraction operation. In Section 3.2 we investigate the case of small cycles (i.e., those of size at most 6) that require special handling due to the nature of the base case (recall that Theorems 2.4 and 2.3 do not hold for a cycle of length 4). Finally, in Section 3.3 we develop an algorithm for the general case, i.e. cycles bigger than 6.

3.1 Contraction of Pairs

In this section we investigate properties of the contraction operation in our goal to extend Theorem 2.4 to contractable pairs. More specifically, we characterize representations of pairs (G, C) satisfying (P2), (P3). We show that (i) the contraction operation preserves ENPT edges, (ii) the order of contractions is irrelevant and (iii) the contraction operation preserves properties (P2) and (P3).

Lemma 3.1 *Let $\langle T, \mathcal{P} \rangle$ be a representation for the pair (G, G') , and let $e = \{p, q\} \in E(G')$. If $(G, G')/_e$ is defined then $\langle T, \mathcal{P} \rangle /_{P_p, P_q}$ is a representation for the pair $(G, G')/_e$.*

Proof: By Lemma 2.4 $\langle T, \mathcal{P} \rangle /_{P_p, P_q}$ is an EPT representation for $G/_e$. It remains to show that it is an ENPT representation for $G/_e$, i.e. that for any two paths $P_{p'}, P_{q'} \in \langle T, \mathcal{P} \rangle /_{P_p, P_q}$, the edge $e' = \{p', q'\}$ is in $E(G/_e) \iff P_{p'} \sim P_{q'}$. Let $P_s = P_p \cup P_q$ and s be the vertex obtained by the contraction. We assume first that $P_s \notin \{P_{p'}, P_{q'}\}$. Then $e' \in E(G/_e) \iff e' \in E(G') \iff P_{p'} \sim P_{q'}$ as required. Now we assume without loss of generality that $P_{p'} = P_s$ and we recall that $e = \{p, q\} \in E(G')$ is the contracted edge. We have to show that $e' = \{s, q'\} \in E(G/_e) \iff P_s \sim P_{q'}$. We observe that

$$\begin{aligned} \{s, q'\} \in E(G/_e) &\iff \{p, q'\} \in E(G') \vee \{q, q'\} \in E(G') \\ &\iff P_p \sim P_{q'} \vee P_q \sim P_{q'} \end{aligned} \quad (1)$$

and

$$\begin{aligned} P_s \sim P_{q'} &\iff (P_p \cup P_q) \cap P_{q'} \neq \emptyset \wedge \text{split}(P_p \cup P_q, P_{q'}) = \emptyset \\ &\iff (P_p \cap P_{q'} \neq \emptyset \vee P_q \cap P_{q'} \neq \emptyset) \wedge \text{split}(P_p, P_{q'}) = \emptyset \wedge \text{split}(P_q, P_{q'}) = \emptyset. \end{aligned} \quad (2)$$

Clearly, (2) implies (1). To conclude the proof, assume that (1) holds. Then $P_p \cap P_{q'} \neq \emptyset \vee P_q \cap P_{q'} \neq \emptyset$. Now assume, by way of contradiction, that (2) does not hold. Then $\text{split}(P_p, P_{q'}) \neq \emptyset \vee \text{split}(P_q, P_{q'}) \neq \emptyset$ implying $P_p \not\sim P_{q'} \vee P_q \not\sim P_{q'}$. Combining with (1) this implies that exactly one of $P_p \sim P_{q'}$ and $P_q \sim P_{q'}$ holds.

Therefore, without loss of generality $P_p \sim P_{q'}, P_q \approx P_{q'}$. Then $e' = \{p, q'\} \in E(G')$ and $e \Delta e' \in E(G)$, therefore $(G, G')/_{e_e}$ is undefined, thus constituting a contradiction to the assumption of the lemma. \square

Let $\bar{E} = \{e_1, e_2, \dots, e_k\} \subseteq E(G')$. For every $k > 1$ we define $(G, G')/_{e_1, \dots, e_k} \stackrel{def}{=} (G, G')/_{e_1, \dots, e_{k-1}/e_k}$ provided that both contractions on the right hand side are defined, otherwise it is undefined. The following Lemma follows from Lemma 3.1 and states that the order of contraction of the edges is irrelevant.

Lemma 3.2 *Let (G, G') be a pair, $\bar{E} = \{e_1, e_2, \dots, e_k\} \subseteq E(G)$, and π a permutation of the integers $\{1, \dots, k\}$. Then $(G, G')/_{e_1, \dots, e_k}$ is defined if and only if $(G, G')/_{e_{\pi(1)}, \dots, e_{\pi(k)}}$ is defined. Moreover, whenever they are defined, we have $(G, G')/_{e_1, \dots, e_k} = (G, G')/_{e_{\pi(1)}, \dots, e_{\pi(k)}}$.*

Proof: Assume that $(G, G')/_{e_1, \dots, e_k}$ is defined. By $k - 1$ successive applications of Lemma 3.1 we conclude that a representation of $(G, G')/_{e_1, \dots, e_k}$ can be obtained from a representation of (G, G') by applying a sequence of $k - 1$ union operations. The result of $k - 1$ union operations is a set of paths. As the union operation is commutative and associative, this set of paths is independent of the order of the union operations. On the other hand as union preserves split vertices, and the result does not contain split vertices, there are no split vertices at any given step of new sequence of union operations. We conclude that $(G, G')/_{e_{\pi(1)}, \dots, e_{\pi(k)}}$ is defined. The other direction holds by symmetry. Whenever both $(G, G')/_{e_1, \dots, e_k}$ and $(G, G')/_{e_{\pi(1)}, \dots, e_{\pi(k)}}$ are defined we have $(G, G')/_{e_1, \dots, e_k} = (G/_{e_1, \dots, e_k}, G'/_{e_1, \dots, e_k}) = (G/_{e_{\pi(1)}, \dots, e_{\pi(k)}}, G'/_{e_{\pi(1)}, \dots, e_{\pi(k)}}) = (G, G')/_{e_{\pi(1)}, \dots, e_{\pi(k)}}$. \square

Based on this result, we denote the contracted pair as $(G, G')/_{\bar{E}}$ and say that \bar{E} is *contractable*.

We write $\langle T_1, \mathcal{P}_1 \rangle \succeq_U \langle T_2, \mathcal{P}_2 \rangle$, or equivalently $\langle T_2, \mathcal{P}_2 \rangle \preceq_U \langle T_1, \mathcal{P}_1 \rangle$ the fact that the representation $\langle T_2, \mathcal{P}_2 \rangle$ can be obtained from $\langle T_1, \mathcal{P}_1 \rangle$ by applying zero or more union operations. Similarly, we write $(G_1, G'_1) \succeq_C (G_2, G'_2)$ if the pair (G_2, G'_2) can be obtained from (G_1, G'_1) by applying zero or more (valid) edge contraction operations. By Lemma 3.1, \preceq_U is homomorphic to \preceq_C . Following the above definitions, a non-contractable pair of graphs is said to be *contraction-minimal*, because it is minimal in the partial order \preceq_C .

We proceed by showing that the contraction operation preserves assumptions (P2), (P3).

Lemma 3.3 *Let $\{p, q, r\}$ be a BBR triangle of $(G, G')/_{e_e}$ where $\{p, r\}$ is the red edge. Then $q \in V(G)$, i.e. q is not the vertex obtained by the contraction.*

Proof: Assume, by contradiction that $e = \{q', q''\}$ and q is the vertex obtained by the contraction of e . Assume without loss of generality that $\{p, q'\}$ and $\{q'', r\}$ are edges of G' . Then both $\{p, q''\}$ and $\{r, q'\}$ are non-edges of G , because otherwise e is not contractable. Then $\{p, q', q'', r\}$ is a hole of size 4 with blues edges, a contradiction. \square

Lemma 3.4 (i) *If (P2) holds for (G, G') then (P2) holds for $(G, G')/_{e_e}$.*
 (ii) *If (P3) holds for (G, G') then (P3) holds for $(G, G')/_{e_e}$.*

Proof: (i) Assume, by contradiction, that (G, G') does not have an induced sub-pair isomorphic to (K_4, P_4) and without loss of generality $(G, G')/_{e_e}$ has a sub-pair isomorphic to (K_4, P_4) induced by the vertices $U = \{p, q, r, s\}$ where p and s are the endpoints of the subgraph isomorphic to P_4 . Let v be the vertex created by the contraction of e . If $v \notin U$ then the sub-pair induced by U is also a sub-pair of (G, G') , contradicting our assumption. Therefore, $v \in U$. By Lemma 3.3 we have that $v \notin \{q, r\}$. Therefore, let without loss of generality $v = p$, $e = \{p', p''\}$ and p'' is adjacent to q in G' . $\{p', q\}$ is a non-edge of G , because e is contractable. As $\{p, s\}$ and $\{p, r\}$ are edges of $G/_{e_e}$, $\{p', s\}$ or $\{p'', s\}$ is an edge of G , and $\{p', r\}$ or $\{p'', r\}$ is an edge of G . If $\{p'', s\}$ is an edge of G then $\{p'', r\}$ is a non-edge of G since otherwise $\{p'', q, r, s\}$ induce a sub-pair isomorphic to (K_4, P_4) in (G, G') . Therefore, $\{p', r\}$ is an edge of G . Then $\{p', p'', q, r\}$ induces a hole of size 4 with blue edges, a contradiction. Thus $\{p', s\}$ is an edge of G , since $\{p', q\}$ and $\{p'', s\}$ are non-edges of G , $\{p', p'', q, s\}$ induce a hole of length 4 with blue edges, a contradiction.

(ii) Assume, by contradiction, that (G, G') has a representation $\langle T, \mathcal{P} \rangle$ satisfying (P3) and that no representation of $(G, G')/_{e_e}$ satisfies (P3). Let v be the vertex created by the contraction of $e = \{v', v''\}$. Then by Lemma 2.4 $\langle T, \mathcal{P} \rangle/_{P_{v'}, P_{v''}}$ is a representation of $(G, G')/_{e_e}$ and it contains a red edge-clique $\{p, q, r\}$. If $v \notin \{p, q, r\}$ then $\{p, q, r\}$ is an edge-clique of $\langle T, \mathcal{P} \rangle$, contradicting our assumption. Assume without loss of generality that $v = p$. Let e_0 be an edge of T defining the edge-clique $\{v, q, r\}$. Since $e_0 \in P_{v'} \cup P_{v''}$, without loss of generality

$e_0 \in P_{v'}$. Then $\{v', q, r\}$ induces an edge-clique on e_0 . This is clearly a red edge-clique since e is contractable, a contradiction. \square

We now describe how minimal representations of $(G, G')/e$ can be obtained from minimal representations of (G, G') .

Lemma 3.5 *Let $\langle T, \mathcal{P} \rangle$ be a minimal representation, $\langle T', \mathcal{P}' \rangle$ a representation such that $\langle T', \mathcal{P}' \rangle \lesssim \langle T, \mathcal{P} \rangle_{/P_p, P_q}$ and $\langle T', \mathcal{P}' \rangle \cong \langle T, \mathcal{P} \rangle_{/P_p, P_q}$. Let e be an edge of T involved in a minimal sequence of minifying operations s that obtains $\langle T', \mathcal{P}' \rangle$ from $\langle T, \mathcal{P} \rangle_{/P_p, P_q}$. There is an operation of s and a path P such that the operation removes e from P (i.e., s is either $tr(P, e)$ or $contract(e)$, and $e \in P$) where at least one of the following holds:*

- (i) e is a tail of $P_p \cap P_q$, $P \cap P_p \cap P_q = \{e\}$ and $P \cap (P_p \cup P_q) \supseteq \{e\}$.
- (ii) e is incident to an internal vertex u of $P_p \cup P_q$, e is a tail of P , P is not in a pie with center u .

Proof: Let $G = EPT(\mathcal{P})$ and $G' = ENPT(\mathcal{P})$ and consider an operation op of s . Without loss of generality we can assume that op is the first operation of s , by Lemma 2.1. Furthermore, by Lemma 2.2, the representation obtained by applying op is also equivalent to $\langle T, \mathcal{P} \rangle_{/P_p, P_q}$. Therefore, without loss of generality op is the only operation of s . Note that op is defined on $\langle T, \mathcal{P} \rangle_{/P_p, P_q}$ except when op is $tr(P_p \cup P_q, e)$. In this case e is a tail of P_p or P_q (or both). In the following discussion, whenever we apply op to $\langle T, \mathcal{P} \rangle$, we mean that we apply $tr(P_p, e)$ or $tr(P_q, e)$ one of which is well defined on $\langle T, \mathcal{P} \rangle$.

By the minimality of $\langle T, \mathcal{P} \rangle$, op cannot be applied to $\langle T, \mathcal{P} \rangle$. More precisely, if op is applied, either an edge of G becomes a non-edge, or a red edge of (G, G') becomes a blue edge. We term such an edge of (G, G') an *affected edge* and the corresponding paths of $\langle T, \mathcal{P} \rangle$ *affected pair of paths*. Let $\{r, s\}$ be an affected edge of (G, G') . If $\{P_r, P_s\} \cap \{P_p, P_q\} = \emptyset$ then P_r, P_s is a pair of affected paths in $\langle T, \mathcal{P} \rangle_{/P_p, P_q}$, contradicting the fact that op can be applied to $\langle T, \mathcal{P} \rangle_{/P_p, P_q}$. We conclude that $\{P_r, P_s\} \cap \{P_p, P_q\} \neq \emptyset$. Assume without loss of generality that $P_s = P_p$, i.e. P_r, P_p is an affected pair of paths. We consider two disjoint cases:

Case 1) $\{r, p\}$ becomes a non-edge after applying op . Then $P_r \cap P_p = \{e\}$ for some edge e of T , and after the removal of e the intersection becomes empty. On the other hand $P_r \cap (P_p \cup P_q) \supseteq \{e\}$, because otherwise P_r and $P_p \cup P_q$ constitute an affected pair of paths in $\langle T, \mathcal{P} \rangle_{/P_p, P_q}$. Then e is a tail of $P_p \cap P_q$ (see Figure 3 a) and P_r is the claimed path P (note that possibly $r = q$ as opposed to the figure). In this case i) holds.

Case 2) $\{r, p\}$ is a red edge, and it becomes a blue edge after applying op . Then $P_r \approx P_p$ (therefore $r \neq q$) and P_r, P_p do not split after applying op . Therefore, $split(P_r, P_p) = \{u\}$ for an endpoint u of e , e is a tail of exactly one of P_r, P_p , and u is an internal vertex of P_p thus of $P_p \cup P_q$. Let $\{P, P'\} = \{P_r, P_p\}$ such that e is a tail of P , and $e \notin P'$. If P is not in a pie with center u then ii) holds. Otherwise P has two neighbors $\{P', P''\}$ in this pie. $e \in P''$ because $e \notin P$ and e is an edge incident to u , the center of the pie. Recalling that e is a tail of P we conclude that after the removal of e from P , its intersection with P'' becomes empty. Therefore, i) holds. \square

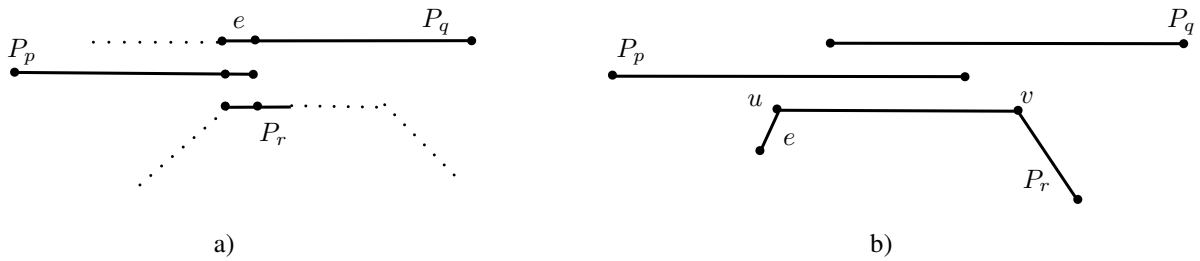

Fig. 3: Possible minifying operations on $\langle T, \mathcal{P} \rangle_{/P_p, P_q}$.

Lemma 3.6 *Every split vertex of a path P of a broken planar tour is a center of a pie containing P .*

Proof: By construction, every split vertex of a path P of a tour is a center of a pie containing P . We will show that the same holds for a broken planar tour. Let P'_1, P'_2 be two paths of a broken planar tour such that $v \in split(P'_1, P'_2)$. These paths are sub-paths of two paths P_1, P_2 of a tour and $v \in split(P_1, P_2)$. Then v is a center of a pie containing P_1, P_2 and also other paths. Each one of the other paths has at least one sub-path in the broken planar tour that

crosses v . These paths, together with P'_1, P'_2 constitute a pie with center v of the broken planar tour. We conclude that every split vertex of P is a center of a pie. \square

We notice that by Lemma 3.6 it follows that the case (ii) of Lemma 3.5 is impossible.

3.2 Small Cycles: the pairs (G, C_5) and (G, C_6)

We now return to the study of the representations of pairs (G', C') satisfying $(P2), (P3)$. Without loss of generality we let $V(G') = V(C') = \{0, 1, \dots, n-1\}$, $n \geq 5$ and note that all arithmetic operations on vertex numbers are done modulo n .

In this Section we analyze the special cases of $n = 5$ and $n = 6$. These cases are special because our technique for the general case is based on contraction of cycles to smaller ones and assumes that the representation of a non-contractable pair is a planar tour (Theorem 2.4). However this theorem does not hold when $n = 4$. The following lemma analyzes the case $n = 5$. We note that in this case $(P3)$ holds vacuously, since it can be easily seen that such a pair does not contain a red triangle. In Lemma 3.8 we analyze the case $n = 6$ for which we show that whenever $(P2)$ and $(P3)$ hold, $(P1)$ holds too, implying that the only representations for this case are those implied by Theorem 2.3.

Lemma 3.7 *If (G', C_5) satisfies $(P2)$ then (i) G' is the graph depicted in Figure 4, and (ii) (G', C_5) has a unique minimal representation also depicted in Figure 4.*

Proof: (i) G' contains at least two non-crossing red edges, because otherwise there is a hole of size 4 with blue edges. Without loss of generality, let these edges be $\{1, 3\}$ and $\{1, 4\}$. If one of $\{2, 4\}$ or $\{0, 3\}$ is a red edge, then we have a (K_4, P_4) , contradicting our assumption. If $\{0, 2\}$ is a red edge, then we have a hole of size 4 containing blue edges, contradicting Lemma 2.3. Therefore, $\{1, 3\}$ and $\{1, 4\}$ are the only red edges in this pair.

(ii) We contract $\{3, 4\}$ of (G', C_5) and obtain the pair (G, C_4) with one red edge $\{1, 3, 4\}$. This pair has a unique minimal representation $\langle T', \mathcal{P}' \rangle$ characterized in Boyacı et al. (2016). Any representation of (G', C_5) is obtained by splitting the path $P'_{3,4}$ of $\langle T', \mathcal{P}' \rangle$ into two overlapping paths and making sure that both of them split from P_1 . This leads to the minimal representation depicted in Figure 4. \square

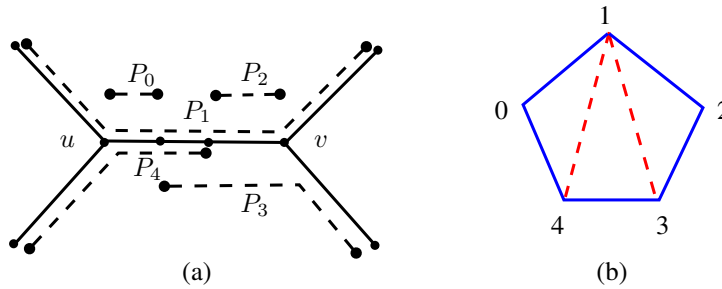

Fig. 4: (a) The unique ENPT representation of C_5 satisfying $(P2)$ and (b) corresponding pair (G, C_5) .

Lemma 3.8 *If (G', C_6) satisfies $(P2)$ and $(P3)$ then it is not contractable, i.e. it satisfies $(P1)$ too.*

Proof: Assume, by way of contradiction, that (G', C_6) satisfies $(P2)$ $(P3)$ and the edge $e = \{0, 1\}$ is contractable. Therefore, $\{0, 2\}$ and $\{5, 1\}$ are non-edges of G' . $\{2, 5\}$ is also a non-edge, because otherwise $\{0, 1, 2, 5\}$ is a hole of size 4 with blue edges. Then $\{0, 1\}$ must be in a BRR triangle. From the two possible options remaining, assume without loss of generality that this triangle is $\{0, 1, 4\}$. At least one of $\{2, 4\}$ and $\{1, 3\}$ is an edge of G' because otherwise $\{1, 2, 3, 4\}$ is a hole of size 4 with blue edges. On the other hand, if both of them are edges then $\{1, 2, 3, 4\}$ is a (K_4, P_4) , a contradiction. Therefore, exactly one of them is an edge of G' . We analyze these cases separately.

- $\{2, 4\}$ is an edge of G' , $\{1, 3\}$ is not an edge of G' : In this case $\{0, 3\}$ is not an edge, because otherwise $\{0, 1, 2, 3\}$ is a hole of size 4 with blue edges. Then $\{3, 5\}$ is not an edge, because otherwise $\{0, 1, 2, 3, 5\}$ is a hole of size 5 with blue edges. Then $\{5, 0, 1, 2, 3\}$ induces a path on 4 vertices in G' . Since none of the paths P_0, P_1, P_2, P_3, P_5 split from another, their union is a graph with maximum degree two, i.e.

every representation of them is an interval representation where no three paths intersect at one edge. Now $P_4 \sim P_5$ and $P_4 \sim P_3$. Therefore, P_4 intersects all of P_0, P_1 and P_2 and does not split from them. Then $\{4, 0\}, \{4, 1\}, \{4, 2\}$ are blue edges, a contradiction.

- $\{1, 3\}$ is an edge of G' , $\{2, 4\}$ is not an edge of G' : Assume by way of contradiction $\{0, 1\}$ is contracted, the contracted pair is the same as the pair in Figure 4 (b) where contracted edge $\{0, 1\}$ corresponds to vertex 1 of (G, C_5) . We will show that 1 can not be a vertex obtained by a contraction. Let $\{1', 1''\}$ be the contracted edge. For the following discussion consult Figure 4 (a). One endpoint of each one of $P_{1'}, P_{1''}$ is the same as the endpoints of P_1 since $P_1 = P_{1'} \cup P_{1''}$. $P_{1'}$ (resp. $P_{1''}$) can not cross v since otherwise $\{1', 2\}$ (resp. $\{0, 1''\}$) is a blue chord. $P_{1'} \sim P_{1''}$, therefore there exist some edge e such that $P_{1'} \cap P_{1''} \ni e$ and $e \in p_T(u, v)$. But $e \in p_T(u, v) \subseteq P_3 \cup P_4$ then either $\{1', 3\}$ or $\{1'', 4\}$ (or both) is a blue chord.

□

3.3 The General Case

Algorithm 1 is a recursive description of FINDMINIMALREPRESENTATION-P2-P3. It follows the paradigm of obtaining a non-contractable pair by successive contractions, and then reversing the corresponding union operations in the representation. The reversal of the union operation, i.e. the breaking apart of a path is done by a) duplicating the path, then b) moving one endpoint of each path to a properly chosen internal vertex of the original path, and possibly c) subdividing an edge. The key to the correctness of the algorithm is the following lemma that among others enables us to consider only one minifying operation.

Lemma 3.9 *Let $\langle T, \mathcal{P} \rangle$ be a minimal representation of (G, C) , $\langle T', \mathcal{P}' \rangle$ a broken planar tour representation such that $\langle T', \mathcal{P}' \rangle \lesssim \langle T, \mathcal{P} \rangle_{/P_p, P_q}$ and $\langle T', \mathcal{P}' \rangle \cong \langle T, \mathcal{P} \rangle_{/P_p, P_q}$. Every operation in a minimal sequence of operations that obtains $\langle T', \mathcal{P}' \rangle$ from $\langle T, \mathcal{P} \rangle_{/P_p, P_q}$ is a $contract(e)$ operation, where e is a tail of $P_p \cap P_q$.*

Proof: Consider an operation in a minimal sequence of minifying operations as in the statement of the lemma. Let e be the edge involved in the operation, and let P_r be a path whose existence is guaranteed by Lemma 3.5. By Lemma 3.6, case (ii) of Lemma 3.5 is impossible. Then case (i) of the lemma holds, i.e. there is a path P_r such that a) the minifying operation removes e from P_r , b) e is a tail of $P_p \cap P_q$, c) $P_r \cap P_p \cap P_q = \{e\}$, and d) $P_r \cap (P_p \cup P_q) \supseteq \{e\}$.

The minifying operation is either $contract(e)$ or $tr(P_r, e)$. We will show that if $tr(P_r, e)$ can be applied, i.e. there is no affected pair after applying $tr(P_r, e)$, then $contract(e)$ can also be applied. For the following discussion consult Figure 3 a) where $split(P_r, P_p) = \emptyset$, i.e. the dotted part of P_r adjacent to e in the figure, is empty.

Without loss of generality we assume that e is a tail of P_p . Since e is not a tail of $P_p \cup P_q$, we have $r \neq p, q$. e divides T into two subtrees T_1, T_2 . As e is a tail of P_p , P_p can not intersect both subtrees. We assume without loss of generality that $T_2 \cap P_p = \emptyset$. Let $\bar{\mathcal{P}}$ denote the set of paths of $\langle T, \mathcal{P} \rangle_{/P_p, P_q}$, i.e. $\bar{\mathcal{P}} = \mathcal{P} \setminus \{P_p, P_q\} \cup \{P_p \cup P_q\}$ and e' be the edge adjacent to e in $P_r \cap (P_p \cup P_q)$. Every path of $P \in \bar{\mathcal{P}}$ that contains e contains also e' , because otherwise $P \cap P_r = \{e\}$ and (P, P_r) would constitute an affected pair of $tr(P_r, e)$. For $k \in \{1, 2\}$, let $\mathcal{P}_k = \{P \in \bar{\mathcal{P}} \mid P \cap T_k \neq \emptyset \wedge e \text{ is a tail of } P\}$. Note that by definition, $\mathcal{P}_1 \cap \mathcal{P}_2 = \emptyset$. As $e' \in T_2 \cap P_r$, we have $P_r \in \mathcal{P}_2$. We note that for every path $P_s \in \mathcal{P}_2$, $P_p \sim P_s$, i.e. $\{p, s\}$ is an edge of C . As the degree of p is 2 in C and both of q and r neighbors of p in C , we conclude that $\mathcal{P}_2 = \{P_r\}$. On the other hand, $\mathcal{P}_1 = \emptyset$ because for every path $P_s \in \mathcal{P}_1$, $\{s, r\}$ is an affected pair of $tr(P_r, e)$ (as $P_s \cap P_r = \{e\}$). Therefore, $\mathcal{P}_1 \cup \mathcal{P}_2 = \{P_r\}$, i.e. the only path with tail e is P_r .

Assume by way of contradiction that there exists an affected pair $\{s, t\}$ of $contract(e)$. As $e' \in P_s \cap P_t$, they intersect after the contraction. Therefore, $\{s, t\}$ is a red-edge that becomes blue after the contraction. This can happen only if e is a tail of exactly one of P_s, P_t . Therefore, $r \in \{s, t\}$ from the above discussion. But then $\{s, t\}$ constitute an affected pair of $tr(P_r, e)$, contradicting to our initial assumption. We conclude that $contract(e)$ has no affected pairs. □

Theorem 3.1 *Instances of P3-HAMILTONIANPAIRREC satisfying property (P2) can be solved in polynomial time. YES instances have a unique solution, and whenever $n \geq 6$ this solution is a broken planar tour.*

Proof: If $n = 5$ the result follows from Lemma 3.7. If (G', C') is a "NO" instance, then FINDMINIMALREPRESENTATION-P2-P3 returns "NO" in the validation phase. Therefore, we assume that $n \geq 6$, and that (G', C') is a "YES" instance, i.e. it has at least one representation satisfying (P3). We will show that for any pair (G', C') satisfying (P2),

Algorithm 1 FINDMINIMALREPRESENTATION-P2-P3(G', C')

Require: $C' = \{0, 1, \dots, |V(G')| - 1\}$ is an Hamiltonian cycle of G' and $|V(G')| > 5$

Ensure: A minimal representation $\langle \bar{T}', \bar{P}' \rangle$ of (G', C') satisfying (P3) if any

```

1: if  $(G', C')$  is contraction-minimal then
2:   if  $G'$  is outerplanar then
3:     return BUILDPLANARTOUR( $G', C'$ )
4:   else
5:     return "NO"
6:
7:   Contract:
8:   Pick an arbitrary contractable edge  $e = \{i, i + 1\}$  of  $C'$ 
9:    $(G, C) \leftarrow (G', C')/_e$ 
10:  Let  $j$  be the vertex of  $(G, C)$  created by the contraction of the edge  $e$ 
11:
12:   Recurse:
13:    $\langle \bar{T}, \bar{P} \rangle \leftarrow \text{FINDMINIMALREPRESENTATION-P2-P3}(G, C)$ .
14:
15:   Uncontract:
16:   Let  $u$  and  $v$  be the endpoints of  $P_j$  such that
17:    $u$  (resp.  $v$ ) is contained in  $P_{i-1}$  (resp.  $P_{i+2}$ )
18:   Replace  $P_j \in \bar{P}'$  by two copies  $P_i$  and  $P_{i+1}$  of itself
19:   ADJUSTENDPOINT( $\langle \bar{T}', \bar{P}' \rangle, G, i, u$ )
20:   ADJUSTENDPOINT( $\langle \bar{T}', \bar{P}' \rangle, G, i + 1, v$ )
21:
22:   Validate:
23:   if  $\text{EPT}(\bar{P}') = G'$  and  $\langle \bar{T}', \bar{P}' \rangle$  satisfies (P3) then
24:     return  $\langle \bar{T}', \bar{P}' \rangle$ 
25:   else
26:     return "NO"
27:
28:   function ADJUSTENDPOINT( $\langle \bar{T}, \bar{P} \rangle, G, p, w$ )
29:      $e_w$  denotes the tail of  $P_p$  incident to  $w$  ▷  $w$  is the endpoint of  $P_p$  to be adjusted
30:      $\mathcal{X}_w$  denotes  $\{P_x : e_w \in P_x \text{ and } \{p, x\} \notin E(G)\}$ 
31:      $\mathcal{Y}_w$  denotes  $\{P_y : P_p \cap P_y = \{e_w\} \text{ and } \{p, y\} \in E(G)\}$ 
32:     while  $\mathcal{Y}_w = \emptyset$  and  $\mathcal{X}_w \neq \emptyset$  do
33:        $tr(P_p, e_w)$ 
34:     if  $\mathcal{X}_w \neq \emptyset$  then ▷ Also  $\mathcal{Y}_w \neq \emptyset$  as the while loop terminated
35:       Subdivide  $e_w$  into two edges  $e_w, e'_w$  ▷ Revert the minifying operation
36:       for  $P_x \in \mathcal{X}_w$  do
37:          $tr(P_x, e'_w)$ 
38:        $tr(P_p, e_w)$ 
    
```

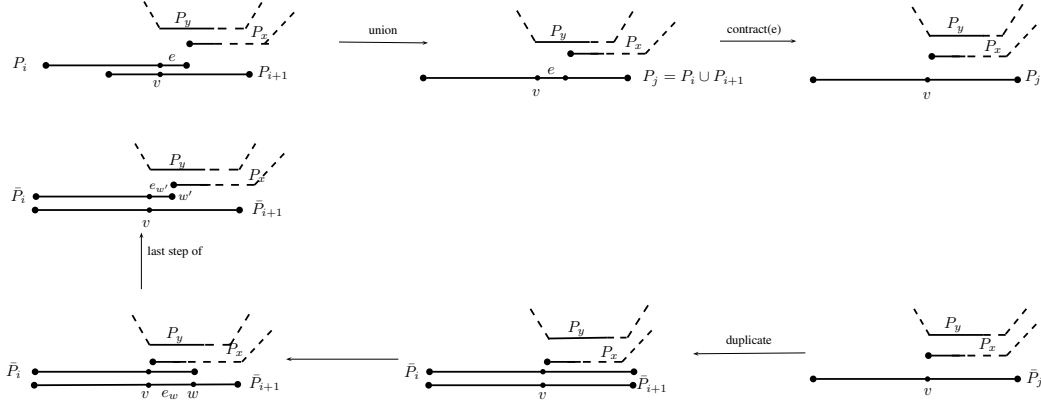

Fig. 5: The effect of union and minifying operations, and the reversal of this effect by Procedure ADJUSTENDPOINT (invoked with $p = i$).

and a minimal representation $\langle T', \mathcal{P}' \rangle$ of (G', C') that satisfies (P3), the representation $\langle \bar{T}', \bar{\mathcal{P}}' \rangle$ returned by FINDMINIMALREPRESENTATION-P2-P3 is a broken planar tour and

$$\langle \bar{T}', \bar{\mathcal{P}}' \rangle \cong \langle T', \mathcal{P}' \rangle \text{ and } \langle \bar{T}', \bar{\mathcal{P}}' \rangle \lesssim \langle T', \mathcal{P}' \rangle.$$

We will prove by induction on the number k of contractable edges of (G', C') . If $k = 0$ then (G', C') is not contractable, therefore satisfies (P1). In this case the algorithm invokes BUILDPLANARTOUR and the claim follows from Theorem 2.3.

Otherwise $k > 0$. We assume that the claim holds for $k - 1$ and prove that it holds for k . As (G', C') contains at least one contractable edge, one such edge $\{i, i + 1\}$ is chosen arbitrarily by the algorithm and contracted. The resulting pair $(G, C) = (G', C')_{/\{i, i+1\}}$ has the following properties:

- Satisfies (P2), (P3). (By Lemma 3.4)
- The number of contractable edges is $k - 1$.
- $|V(G)| \geq 6$. This is because $|V(G)| = |V(G')| - 1$ and $|V(G')| > 6$. Indeed, if $|V(G')| = 6$, we have $k = 0$ by Lemma 3.8.

Therefore, (G, C) satisfies the assumptions of the inductive hypothesis. Let $\langle T', \mathcal{P}' \rangle$ be a minimal representation of (G', C') satisfying (P3). Then $\langle T', \mathcal{P}' \rangle_{/P_i, P_{i+1}}$ is a representation of $(G, C) = (G', C')_{/\{i, i+1\}}$. By the inductive hypothesis, $\langle \bar{T}', \bar{\mathcal{P}}' \rangle$ is a broken planar tour that satisfies

$$\langle \bar{T}', \bar{\mathcal{P}}' \rangle \cong \langle T', \mathcal{P}' \rangle_{/P_i, P_{i+1}} \text{ and } \langle \bar{T}', \bar{\mathcal{P}}' \rangle \lesssim \langle T', \mathcal{P}' \rangle_{/P_i, P_{i+1}}.$$

In other words $\langle \bar{T}', \bar{\mathcal{P}}' \rangle$ is obtained from $\langle T', \mathcal{P}' \rangle$ by replacing the two paths P_i, P_{i+1} with the path $P_i \cup P_{i+1}$, then applying a (possibly empty) sequence of minifying operations. By Lemma 3.9, these minifying operations are $contract(e)$ for a tail e of $P_i \cap P_{i+1}$. In the Uncontract phase, FINDMINIMALREPRESENTATION-P2-P3 performs a reversal of these transformations. See Figure 5 for the following discussion. One endpoint of each one of P_i and P_{i+1} is an endpoint of $P_i \cup P_{i+1}$. Therefore, one needs to determine only one endpoint of each one of P_i and P_{i+1} . First $P_i \cap P_{i+1}$ is duplicated and the so obtained paths are called \bar{P}_i, \bar{P}_{i+1} .

For $p \in \{i, i + 1\}$, let w be the endpoint of P_p to be adjusted. e_w denotes the tail of P_p incident to w . We denote by \mathcal{X}_w the set of paths containing e_w such that vertices of G' corresponding to these paths are not adjacent to p . We denote by \mathcal{Y}_w the set of paths intersecting P_p only on e_w and whose corresponding vertices in G' are adjacent to p . If \mathcal{Y}_w is empty (that is, every path that intersects P_p also intersects $P_p \setminus \{e_w\}$), e_w can be safely removed from P_p without losing intersections. If \mathcal{X}_w is non-empty this removal is a necessary operation. The algorithm performs these tail removals as long as they are necessary and safe. If at the end of this loop, \mathcal{X}_w is empty then we are done. Otherwise \mathcal{X}_w and \mathcal{Y}_w are non-empty, then e_w can not be safely removed from P_p . In this case ADJUSTENDPOINT subdivides e_w (thus reversing the minifying operation $contract(e)$) and removes one tail from P_p and one tail from every path $X \in \mathcal{X}_w$, so that P_p does not intersect X but still intersects every path $Y \in \mathcal{Y}_w$. \square

4 Pairs (G, C) Satisfying $(P3)$

In the previous section we relaxed assumption $(P1)$. In this section we relax assumption $(P2)$, i.e. we allow sub-pairs isomorphic to (K_4, P_4) . In Section 4.1 we investigate the basic properties of the representations of such sub-pairs, and characterize the representations of pairs (G, C) with at most 6 vertices. In Section 4.2 we show that in bigger cycles such pairs can intersect only in a particular way, and we define the aggressive contraction operation that transforms a pair (G'', C'') with a (K_4, P_4) to a pair (G', C') with one less vertex and at least one (K_4, P_4) less. Using these results, in Section 4.3 we present an algorithm that finds the unique minimal representation of a given pair (G, C) satisfying $(P3)$ with more than 6 vertices.

We denote a set of 4 vertices inducing a sub-pair isomorphic to (K_4, P_4) as an ordered quadruple where the first vertex is one of the endpoints of the induced P_4 , the second vertex is its neighbor and so on. The quadruple (p, q, r, s) is a (K_4, P_4) of (G, G') whenever $\{p, q, r, s\}$ induces a sub-pair (K_4, P_4) of (G, G') and $\{p, q\}, \{q, r\}, \{r, s\}$ are the edges of G' . Clearly, $(p, q, r, s) = (s, r, q, p)$.

4.1 Representations of (K_4, P_4) and Small Cycles

In this section we investigate representations of induced (K_4, P_4) pairs and characterize the unique minimal representations of (G, C_n) pairs containing an induced (K_4, P_4) . We start with Lemma 4.1 that characterizes representations of (K_4, P_4) pairs. Using this lemma we prove Theorem 4.1 that presents the unique minimal representation of (G, C_5) pairs containing a (K_4, P_4) . Together with Lemma 3.7 this completes the characterization of all the (G, C_5) pairs because a (G, C_5) satisfies $(P3)$ vacuously. We continue by proving Lemma 4.3 more properties of minimal representations of induced (K_4, P_4) sub-pairs of pairs (G, C) with at least 6 vertices. Using these results we show that a (G, C_6) satisfying $(P3)$ does not contain sub-pairs isomorphic to (K_4, P_4) .

Lemma 4.1 *Let $K = (i, i+1, i+2, i+3)$ be a (K_4, P_4) , $\langle T, \mathcal{P} \rangle$ be a representation of K , and $\bigcap \mathcal{P}_K \stackrel{def}{=} P_i \cap P_{i+1} \cap P_{i+2} \cap P_{i+3}$. There is a path $core(K)$ of T with endpoints u, v such that:*

- (i) $split(P_i, P_{i+2}) = \{u\}$, $split(P_{i+1}, P_{i+3}) = \{v\}$, P_{i+1} (resp. P_{i+2}) does not cross u (resp. v).
- (ii) $\emptyset \neq \bigcap \mathcal{P}_K \subseteq (P_{i+1} \cap P_{i+2}) \subseteq core(K)$. In particular $u \neq v$.
- (iii) At least one of P_i, P_{i+3} crosses both endpoints of $core(K)$ and $\emptyset \neq split(P_i, P_{i+3}) \subseteq \{u, v\}$.
- (iv) $P_{i+1} \cup P_{i+2}$ crosses both endpoints of $core(K)$.
- (v) The removal of the edges of $P_{i+1} \cup P_{i+2}$ from T disconnects P_i from P_{i+3} .

Proof: (i) Assume, by way of contradiction, that $|split(P_i, P_{i+2})| = \{w, w'\}$ where w and w' are distinct vertices of T . As $P_{i+1} \sim P_i$ and $P_{i+1} \sim P_{i+2}$ we conclude that $P_{i+1} \subseteq p_T(w, w')$. Since $P_{i+3} \sim P_{i+1}$, P_{i+3} splits from P_{i+1} in at least one vertex w'' that is an intermediate vertex of $p_T(w, w')$. Then P_{i+3} splits from P_{i+2} at w'' contradicting the fact that $\{i+2, i+3\}$ is an ENPT edge. Therefore, $|split(P_i, P_{i+2})| = 1$ and by symmetry, $|split(P_{i+1}, P_{i+3})| = 1$. Let $split(P_i, P_{i+2}) = \{u\}$ and $split(P_{i+1}, P_{i+3}) = \{v\}$. We define $core(K) = p_T(u, v)$. For the rest of the claim, assume by contradiction that P_{i+1} crosses u . Then either $P_{i+1} \sim P_i$ or $P_{i+1} \sim P_{i+2}$, contradicting the fact that $\{i, i+1\}$ and $\{i+1, i+2\}$ are ENPT edges.

At this point we can uniquely define the following edges that will be used in the rest of the proof: e_i (resp. e_{i+2}) is the edge of $P_i \setminus P_{i+2}$ (resp. $P_{i+2} \setminus P_i$) incident to $split(P_i, P_{i+2}) (= \{u\})$. We define e_{i+1} and e_{i+3} similarly. Note that $e_i \neq e_{i+2}$ and $e_{i+1} \neq e_{i+3}$.

(ii) A claw-clique of size 4 contains exactly one ENPT edge, however a path isomorphic to P_4 contains three edges. Therefore, the representation of K_4 is an edge-clique. Let e be an edge defining this edge-clique, i.e. $e \in \bigcap \mathcal{P}_K$. The removal of e from T disconnects it into two subtrees. In order to prove that $\bigcap \mathcal{P}_K \subseteq core(K)$ it suffices to show that u and v are in different subtrees. Assume, by way of contradiction that u, v are in the same subtree T_r with root r where r is an endpoint of e . Let r' be the least common ancestor of u, v in T_r (possibly $u = v$ in which case $r' = u = v$). All the 4 paths contain e and cross r' (so that each one crosses at least one of u, v), i.e. they “enter” r' from the same edge e' (where possibly $r' = r$ and $e' = e$). If $r' \notin \{u, v\}$ then as P_{i+1} crosses v and P_{i+2} crosses u , $r' \in split(P_{i+1}, P_{i+2})$, contradicting $P_{i+1} \sim P_{i+2}$. Therefore, we can assume without loss of generality that $r' = u$. Then the edges e_i and e_{i+2} are incident to r' . Then P_{i+1} (resp. P_{i+3}) contains e_i (resp. e_{i+2}) because $P_{i+1} \sim P_i$ (resp. $P_{i+3} \sim P_{i+2}$). Therefore, $r' \in split(P_{i+1}, P_{i+2})$, contradicting $P_{i+1} \sim P_{i+2}$. Therefore, u and v are in different subtrees, i.e. $e \in p_T(u, v) = core(K)$. Since e is chosen as an arbitrary edge defining the edge-clique this implies that $\bigcap \mathcal{P}_K \subseteq core(K)$. It remains to prove that $P_{i+1} \cap P_{i+2} \subseteq core(K)$. For this purpose, it is sufficient to show that both of P_{i+1} and P_{i+2} have one endpoint in $core(K)$. Indeed, assume without loss of generality that P_{i+1} does not have an endpoint in $core(K)$. Then P_{i+1} crosses u , a contradiction.

Consult Figure 6 for the rest of the proof.

(iii) By the above discussion, u (resp. v) is an intermediate vertex of P_i and P_{i+2} (resp. P_{i+1} and P_{i+3}), and they all intersect in at least one edge $e \in \text{core}(K)$. In order to see the first part of the claim assume, by way of contradiction, that both of P_i and P_{i+3} have an endpoint in $\text{core}(K)$, in this case $\bigcap \mathcal{P}_K$ is between these two endpoints. Therefore, $P_i \sim P_{i+3}$, a contradiction.

We now proceed to show the rest of the claim: Let $w \in \text{split}(P_i, P_{i+3})$. $e_i \notin P_{i+3}$ because otherwise $P_{i+3} \approx P_{i+2}$, and by symmetry $e_{i+3} \notin P_i$. Therefore, w is on $\text{core}(K)$. On the other hand w is not an intermediate vertex of $\text{core}(K)$. Indeed, consider the two sub-paths obtained by removing e from $\text{core}(K)$. If w is an intermediate vertex of $\text{core}(K)$, then at least one of $P_{i+3} \approx P_{i+2}$, $P_i \approx P_{i+1}$ holds, depending on the sub-path w belongs. We conclude $w \in \{u, v\}$. Together with $P_i \approx P_{i+3}$, this implies the claim. Note that $\text{split}(P_i, P_{i+3}) = \{u, v\}$ if and only if both of P_i and P_{i+3} cross both endpoints u, v of $\text{core}(K)$.

(iv) As $\{i+1, i+2\}$ is an ENPT edge, $Q \stackrel{\text{def}}{=} P_{i+1} \cup P_{i+2}$ is a path. Moreover, $e_{i+1} \in P_{i+1}$ and $e_{i+2} \in P_{i+2}$, therefore $\{e_{i+1}, e_{i+2}\} \subseteq Q$, implying the claim.

(v) It suffices to show that $\text{core}(K)$ separates P_i and P_{i+3} . Suppose that after the removal of $\text{core}(K)$ the two paths still intersect. This is possible only if $e_{i+3} \in P_i$ or $e_i \in P_{i+3}$. Assume without loss of generality that $e_{i+3} \in P_i$. Then $P_i \approx P_{i+1}$, a contradiction. \square

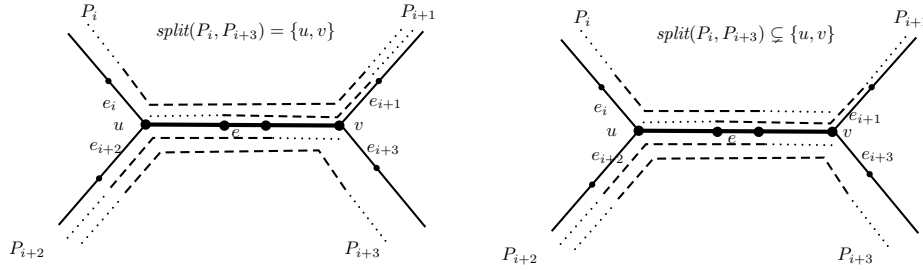

Fig. 6: Representations of (K_4, P_4) pairs where $\text{split}(P_i, P_{i+3}) = \{u, v\}$ and $\text{split}(P_i, P_{i+3}) \subsetneq \{u, v\}$, respectively.

Pairs (G, C_5) with induced (K_4, P_4) pairs turn out to be different than bigger cycles. One difference is that a C_5 contains a vertex incident to two distinct vertices of a P_4 whereas this clearly does not hold for a bigger cycle. Therefore, we analyse this case separately. We recall that a pair (G, C_5) satisfies (P3) vacuously, and that in Section 3.2 we found the unique minimal representation of a pair (G, C_5) that satisfies (P2). We now investigate the representation of a pair (G, C_5) that does not satisfy (P2).

Theorem 4.1 *If (G, C_5) does not satisfy (P2) then (i) G is isomorphic to the graph depicted in Figure 7, and (ii) (G, C_5) has a unique minimal representation also depicted in Figure 7.*

Proof: Assume without loss of generality $K = (0, 1, 2, 3)$ is a (K_4, P_4) of (G, C_5) , and let $\text{core}(K) = p_T(u, v)$. If $\text{split}(P_0, P_3) = \{u, v\}$ then $P_4 \subseteq \text{core}(K)$, implying that $P_4 \sim P_1$ or $P_4 \sim P_2$, i.e. at least one of $\{1, 4\}$ or $\{2, 4\}$ is an ENPT edge, a contradiction.

Assume without loss of generality $\text{split}(P_0, P_3) = \{u\}$, and that P_3 crosses both u and v . Then P_0 has one endpoint u' in $\text{core}(K)$, and $P_0 \cap P_3 = p_T(u, u')$.

As $P_4 \sim P_0$ and $P_4 \sim P_3$, we have $P_4 \sim p_T(u, u')$ and P_4 does cross u . Therefore, P_4 intersects $\text{core}(K)$. By Lemma 4.1 (iv) $\text{core}(K) \subseteq P_1 \cup P_2$. We conclude that $P_4 \cap (P_1 \cup P_2) \neq \emptyset$, i.e. $P_4 \cap P_1 \neq \emptyset$ or $P_4 \cap P_2 \neq \emptyset$. As $\{4, 1\}$ and $\{4, 2\}$ are not ENPT edges, we have that $P_4 \approx P_1$ or $P_4 \approx P_2$. On the other hand P_4 does not cross u and by Lemma 4.1 (i), P_2 does not cross v , thus $\text{split}(P_2, P_4) = \emptyset$. Therefore, $P_4 \approx P_1$ and $P_4 \parallel P_2$. Moreover, $\text{split}(P_4, P_1) = \{v\}$, i.e. P_4 crosses v . Therefore, one endpoint u'' of P_4 is in $p_T(u, u')$, and must be between u' and the endpoint of P_1 in $\text{core}(K)$.

It is easy to see that the path $\bigcap \mathcal{P}_K$ can be contracted to one edge e without affecting the relationships between the paths. Similarly, any edge between u and e , and any edge between e and u'' can be contracted. The path $p_T(u', u'')$ can be contracted to one edge, and the path $p_T(u', v)$ can be contracted to a single vertex v . This leads to the representation depicted in Figure 7. \square

We now observe a property of the representations of (G, C_5) in order to demonstrate the first family of non-ENPT graphs.

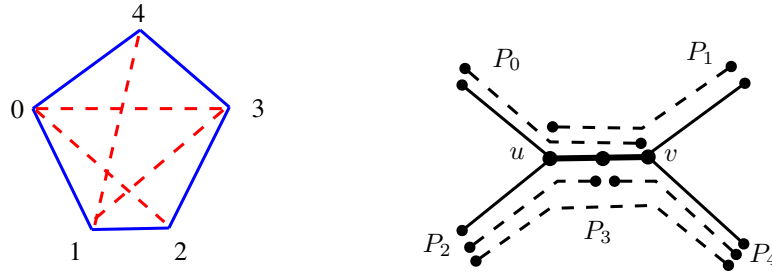

Fig. 7: The unique (G, C_5) pair that does not satisfy $(P2)$ and its unique minimal representation.

Lemma 4.2 $G + C_5$ is not an ENPT graph whenever G is not a complete graph.

Proof: A pair (G', C_5) satisfies $(P3)$ vacuously. If (G', C_5) satisfies $(P2)$ then by Lemma 3.7, its unique minimal representation is the one depicted in Figure 4. Otherwise, by Theorem 4.1, its unique minimal representation is the one depicted in Figure 7. Let $i \in V(G)$. i is adjacent to every vertex of C_5 . We observe that in both cases above a) P_i is a sub-path of $p_T(u, v)$, and b) there is a specific edge e of $p_T(u, v)$ that is also in P_i . Therefore, for any two vertices $i, j \in V(G)$ P_i and P_j are intersecting sub-paths of $p_T(u, v)$, thus $P_i \sim P_j$. We conclude that G is a complete graph. \square

We now extend Lemma 4.1. As opposed to Lemma 4.1 that investigates the structure of a (K_4, P_4) regardless of any specific context, the following lemma provides us with more properties of minimal representations satisfying $(P3)$ of pairs (G, C) .

Lemma 4.3 Let $K = (i, i + 1, i + 2, i + 3)$ be a (K_4, P_4) of a pair (G, C) satisfying $(P3)$ on at least 6 vertices. Let $\langle T, \mathcal{P} \rangle$ be a minimal representation of (G, C) and let $\mathcal{P}_K = \{P_i : i \in K\}$.

- (i) $\bigcap \mathcal{P}_K = \{e\}$ for some edge e which is used exclusively by the paths of \mathcal{P}_K , i.e. $e \in P_j \Rightarrow j \in K$.
- (ii) e divides T into two subtrees T_1, T_2 such that T_1 is a cherry of $\langle T, \mathcal{P}_K \rangle$ with center w_1 . We denote this subtree as $\text{cherry}(K)$.
- (iii) $\text{split}(P_i, P_{i+3}) = \{w_2\} \subseteq V(T_2)$.
- (iv) $N_G(j) = K$ if and only if $\text{split}(P_j, P_i) \cup \text{split}(P_j, P_{i+3}) = \{w_1\}$. The unique vertex j satisfying this condition is one of $i + 1, i + 2$.

Proof: Consult Figure 8 for this proof.

(i) Let without loss of generality $i = 0$. By Lemma 4.1, $\bigcap \mathcal{P}_K$ is not empty. By contradiction assume that a path $P_j \notin \mathcal{P}_K$ intersects $\bigcap \mathcal{P}_K$. Then $K \cup \{j\}$ is an edge-clique of G . We claim that this K_5 contains at least one red triangle, contradicting $(P3)$. Indeed, as C has at least 6 vertices, j is adjacent in C to at most one vertex $k \in \{0, 3\}$. $K \setminus \{k\}$ contains one red edge. The endpoints of this edge together with j constitute a red edge-clique. Therefore, no path of $\mathcal{P} \setminus \mathcal{P}_K$ intersects $\bigcap \mathcal{P}_K$. Then no intermediate vertex of $\bigcap \mathcal{P}_K$ is a split vertex. By the minimality of $\langle T, \mathcal{P} \rangle$, $\bigcap \mathcal{P}_K$ consists of one edge, say e .

(ii) Let T_1, T_2 be the subtrees obtained by the removal of e from T . As $V(G) \setminus K$ is a connected component of G , the union of the paths $\mathcal{P} \setminus \mathcal{P}_K$ is a subtree T' of T . T' is a subtree of T_1 or a subtree of T_2 , because otherwise there is at least one path of $\mathcal{P} \setminus \mathcal{P}_K$ using e , contradicting (i). Without loss of generality let T_2 be the subtree containing T' , and T_1 be the subtree that intersects only paths of \mathcal{P}_K . By Lemma 4.1 (ii), T_1 contains exactly one endpoint of $\text{core}(K)$. For $i \in \{1, 2\}$, let w_i be the endpoint of $\text{core}(K)$ that is in T_i . w_1 is the only split vertex in T_1 because it contains only paths of \mathcal{P}_K . As the representation is minimal, there are no edges between e and w_1 , as otherwise they could be contracted. Any subtree of T_1 starting with an edge incident to w_1 can be contracted to one path because the subtree does not contain split vertices. Moreover, this path can be contracted to one edge, because all the paths entering the subtree intersect in its first edge. Since there are only two such subtrees, T_1 is isomorphic to a P_3 and w_1 is its center.

(iii) Assume that $|\text{split}(P_0, P_3)| = 2$. Then by Lemma 4.1, $\text{split}(P_0, P_3) = \{w_1, w_2\}$, i.e. w_1 is an internal vertex of both P_0 and P_3 . In this case, one can remove from P_0 its unique edge in T_1 without affecting the relationships between the paths. This contradicts the minimality of $\langle T, \mathcal{P} \rangle$. Indeed, a) any change in T_1 affects relationships between paths of \mathcal{P}_K only, b) $\bigcap \mathcal{P}_K$ is not affected, therefore all the paths of \mathcal{P}_K still intersect, c) $\{w_1\} = \text{split}(P_0, P_3) = \text{split}(P_0, P_2)$ and $\{w_2\} = \text{split}(P_1, P_3)$ hold after the tail removal.

Now assume that $\text{split}(P_0, P_3) = \{w_1\}$. P_0 crosses w_2 because $\text{split}(P_0, P_2) = \{w_2\}$. Then P_3 does not cross w_2 . As $P_4 \sim P_3$, P_4, P_2, P_0 intersect in the last edge of P_3 , and thus constitute a red edge-clique, contradicting (P3). We conclude that $\text{split}(P_0, P_3) = \{w_2\}$.

(iv) First assume $j \notin \{i+1, i+2\}$. Clearly, $N_G(j) \neq K$. Moreover, we have $\text{split}(P_j, P_i) \cup \text{split}(P_j, P_{i+3}) \neq \{w_1\}$. Indeed, if $j \notin K$ then w_1 is not a vertex of P_j and if $j \in \{i, i+3\}$ the condition holds because (iii).

We now assume $j \in \{i+1, i+2\}$. By Lemma 4.1 (v), the removal of $P_1 \cup P_2$ disconnects P_0 from P_3 . Then the tree T' intersects $P_1 \cup P_2$. Therefore, at least one of P_1, P_2 intersects T' . By Lemma 4.1 i) one of P_1, P_2 does not cross w_2 , i.e. does not intersect T_2 which in turn includes T' , a contradiction. We conclude that exactly one of P_1, P_2 intersects T' . In other words exactly one of 1, 2 is adjacent to $V(G) \setminus K$. Assume $N_G(i+1) = K$. Then $P_{i+1} \cap T_1 \neq \emptyset$, therefore $\text{split}(P_{i+1}, P_i) = \emptyset$, i.e. $\text{split}(P_{i+1}, P_{i+3}) = \{w_1\}$, concluding the claim. The case $N_G(i+2) = K$ is symmetric. \square

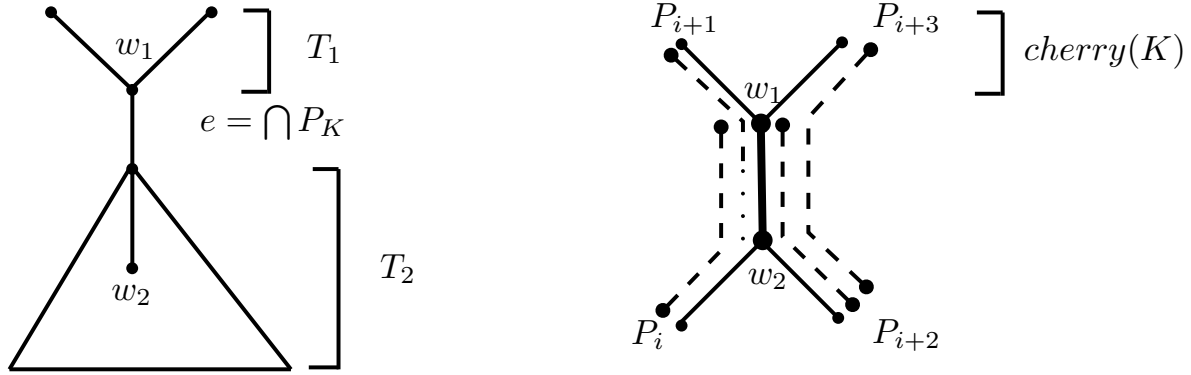

Fig. 8: A minimal representation of a pair (G, C) with an induced (K_4, P_4) with $N_G(i+1) = K$.

We term, as *isolated*, the vertex $j \in \{i+1, i+2\}$ of $K = (i, i+1, i+2, i+3)$ satisfying $N_G(j) = K$ whose existence and uniqueness are guaranteed by Lemma 4.3 (iv). We recall that $(i, i+1, i+2, i+3) = (i+3, i+2, i+1, i)$, and in view of this result, we introduce an alternative notation: We denote K as $[i, i+1, i+2, i+3]$ if $i+1$ is its isolated vertex, and as $[i+3, i+2, i+1, i]$ otherwise.

Lemma 4.4 *Let $K = [i, i+1, i+2, i+3]$ a (K_4, P_4) of a pair (G, C) with at least 6 vertices, $\langle T, \mathcal{P} \rangle$ a minimal representation of (G, C) satisfying (P3). If there is a path $P_j \notin \mathcal{P}_K$ intersecting $\text{core}(K)$, then $j = i-1$ and $|\text{core}(K)| = 2$, otherwise $|\text{core}(K)| = 1$.*

Proof: Let $\bigcap \mathcal{P}_K = \{e\}$, and assume that $j \notin K$ and $P_j \cap \text{core}(K) \neq \emptyset$. Recall that $e \notin P_j$. If P_j splits from $\text{core}(K)$ then it splits from each one of P_i, P_{i+2}, P_{i+3} . In particular $\{j, i, i+2\}$ constitutes a red edge-clique, thus violating (P3). If $P_j \subseteq \text{core}(K)$ then $P_j \sim P_{i+2}$ implying $j \in \{i+1, i+3\} \subset K$, contradicting our assumption. Therefore, P_j crosses the endpoint w_2 of $\text{core}(K)$. Then P_j intersects with each one of P_i, P_{i+2}, P_{i+3} in the last edge of $\text{core}(K)$. Therefore, a) $P_j \sim P_{i+2}$ because $j \notin \{i+1, i+3\}$, and b) $P_i \sim P_{i+2}$. If $P_j \sim P_i$ then $\{j, i, i+2\}$ constitutes a red edge-clique, violating (P3). Therefore, $P_j \sim P_i$, implying $j = i-1$. Note that $P_{i+1} \cap P_{i-1} = \emptyset$ because $i+1$ is isolated. $P_{i-1} \cap \text{core}(K)$ consists of a single edge $e' (\neq e)$, because otherwise they can be contracted to a single edge without affecting the relationships between the paths $P_{i-1}, P_i, P_{i+2}, P_{i+3}$ that are the only paths that intersect the contracted edges. Then $\text{core}(K)$ consists of the two edges e, e' . If P_{i-1} does not intersect $\text{core}(K)$ then \mathcal{P}_K are the only paths that intersect $\text{core}(K)$. Therefore, all the edges of $\text{core}(K)$ can be contracted to one edge. \square

Lemma 4.5 *A pair (G, C) with 6 vertices satisfying (P3) does not contain an induced (K_4, P_4) .*

Proof: Assume without loss of generality that $[0, 1, 2, 3]$ is a (K_4, P_4) of (G, C) . Let $\langle T, \mathcal{P} \rangle$ be a representation of (G, C) satisfying (P3). For $i \in \{0, 3\}$ let T_i be the unique connected component of $T \setminus \text{core}(K)$ intersecting P_i . By Lemma 4.4, P_4 does not cross w_2 . Therefore, P_4 is completely in T_3 . As $P_4 \cap P_5 \neq \emptyset$, P_5 intersects T_3 . If P_5 is completely in T_3 then $P_5 \parallel P_0$, otherwise $P_5 \sim P_0$. Both cases contradict the fact that $\{5, 0\}$ is an edge of C . \square

4.2 Intersection of (K_4, P_4) pairs and Aggressive Contraction

We now focus on pairs with at least 7 vertices. We start by analyzing the intersection of their (K_4, P_4) sub-pairs.

Lemma 4.6 *Let (G, C) be a pair with at least 7 vertices satisfying (P3), and $K = [i, i+1, i+2, i+3]$ a (K_4, P_4) of (G, C) . Then*

- (i) *there is at most one (K_4, P_4) , $K' \neq K$ such that $E(C[K]) \cap E(C[K']) \neq \emptyset$ and if such a (K_4, P_4) exists then $K' = [i+5, i+4, i+3, i+2]$ (and therefore $\{i+2, i+4\}$ is an edge of G),*
- (ii) *if $\{i+2, i+4\}$ is an edge of G then $K' = [i+5, i+4, i+3, i+2]$ induces a (K_4, P_4) of (G, C) .*

Proof: Let without loss of generality $i = 0$.

(i) Since 1 is isolated, we have $1 \notin K'$. Therefore, if $E(C[K]) \cap E(C[K']) \neq \emptyset$ for some (K_4, P_4) K' then $E(C[K]) \cap E(C[K']) = \{\{2, i\}\}$, i.e. $K' = (2, 3, 4, 5)$. Since 3 is adjacent to 1, 3 is not isolated in K' . Therefore, $K' = [5, 4, 3, 2]$.

(ii) Assume $\{2, 4\}$ is an edge of G and that, by way of contradiction, $K' = \{2, 3, 4, 5\}$ is not a (K_4, P_4) . Consult Figure 9 for the following discussion. For $j \in \{0, 3\}$ let T_j be the connected component of $T \setminus \text{core}(K)$ intersecting P_j . As $P_4 \sim P_3$, Lemma 4.4 implies that P_4 is completely in T_3 . $P_4 \approx P_2$, by our assumption. Let w_3 be the endpoint of P_3 in T_3 and w_4 be the split vertex of P_2 and P_4 . Then $w_3 \in p_T(w_2, w_4)$ (possibly $w_3 = w_4$). P_5 does not intersect at least one of P_2 and P_3 , because otherwise K' is a (K_4, P_4) . Then it does not intersect P_3 . The union of the paths P_6, \dots, P_{n-1} constitutes a subtree T' of T that intersects both P_0 and P_5 . Therefore, there is at least one path $P_j \in \{P_6, \dots, P_{n-1}\}$ crossing the last edge of P_3 (incident to w_3). Then $\{2, 4, j\}$ is an edge-clique defined by this edge. Moreover, a) $P_2 \approx P_4$, b) $P_j \approx P_2$ because $j \notin \{1, 3\}$, $P_j \approx P_4$ because $j \notin \{3, 5\}$. Therefore, $\{2, 4, j\}$ is a red edge-clique, contradicting the assumption that (P3) is satisfied. \square

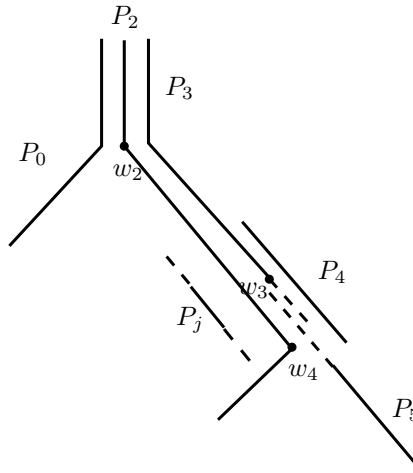

Fig. 9: Proof of Lemma 4.6.

By the above lemma (K_4, P_4) sub-pairs may intersect only in pairs. We term two intersecting (K_4, P_4) pairs as *twins*, and a (K_4, P_4) not intersecting with another as a *single* (K_4, P_4) .

Given a (K_4, P_4) $K = [i, i+1, i+2, i+3]$ of a pair (G'', C'') satisfying (P3), the *aggressive contraction* operation is the replacement of the vertices $i+2, i+3$ by a single vertex $(i+2).(i+3)$. We denote by $(G''_{/e}, C''_{/e})$ the resulting pair (where $e = \{i+2, i+3\}$) as $(G'', C'')_{/K}$. The following lemma characterizes the aggressive contraction operation in the representation domain.

Lemma 4.7 *Let (G'', C'') be a pair with at least 7 vertices, $\langle T'', \mathcal{P}'' \rangle$ be a representation of it satisfying (P3), and $K = [i, i+1, i+2, i+3]$ be a (K_4, P_4) of (G'', C'') . Then:*

$(G'', C'')_{/K}$ is a pair satisfying (P3) and a representation $\langle T', \mathcal{P}' \rangle$ of $(G', C') = (G'', C'')_{/K}$ satisfying (P3) is obtained from $\langle T'', \mathcal{P}'' \rangle$ by first removing $\text{cherry}(K)$ and also $\text{cherry}(K')$ if K and K' are twins, and then applying the union operation to P_{i+2} and P_{i+3} .

Proof: Let without loss of generality $i = 0$. Recall that by Lemma 4.6, $\{2, 4\}$ is an edge of G'' , if and only if K is a twin. Figure 10 illustrates the following two steps in the case that K is a single.

(Step 1) We remove $cherry(K)$ (and also $cherry(K')$ when K and K' are twins) from T'' . By Lemma 4.3 we know that by removing cherries we don't lose any edge intersection, and we lose exactly one split vertex per cherry, namely the center of the cherry. This vertex (or vertices) is $split(P_1, P_3)$ (and also $split(P_2, P_4)$ when K is a twin). Thus the edge $\{1, 3\}$ (and also $\{2, 4\}$ when K is a twin) becomes blue. As no new red edges are introduced, the resulting representation does not contain red edge-cliques, i.e. satisfies (P3).

(Step 2) We contract the resulting graph on the edge $\{2, 3\}$. We claim that this contraction is defined. Indeed assume by contradiction that $\{2, 3\}$ participates in a BBR triangle. This BBR triangle is one of $\{1, 2, 3\}$ and $\{2, 3, 4\}$. Then one of $\{1, 3\}$ and $\{2, 4\}$ is a red edge, contradicting the fact that these edges (if exist) becomes blue after step 1. This contraction corresponds to the union operation on the paths P_2, P_3 , and by Lemma 3.4 the resulting graph satisfies (P3). \square

4.3 Algorithm

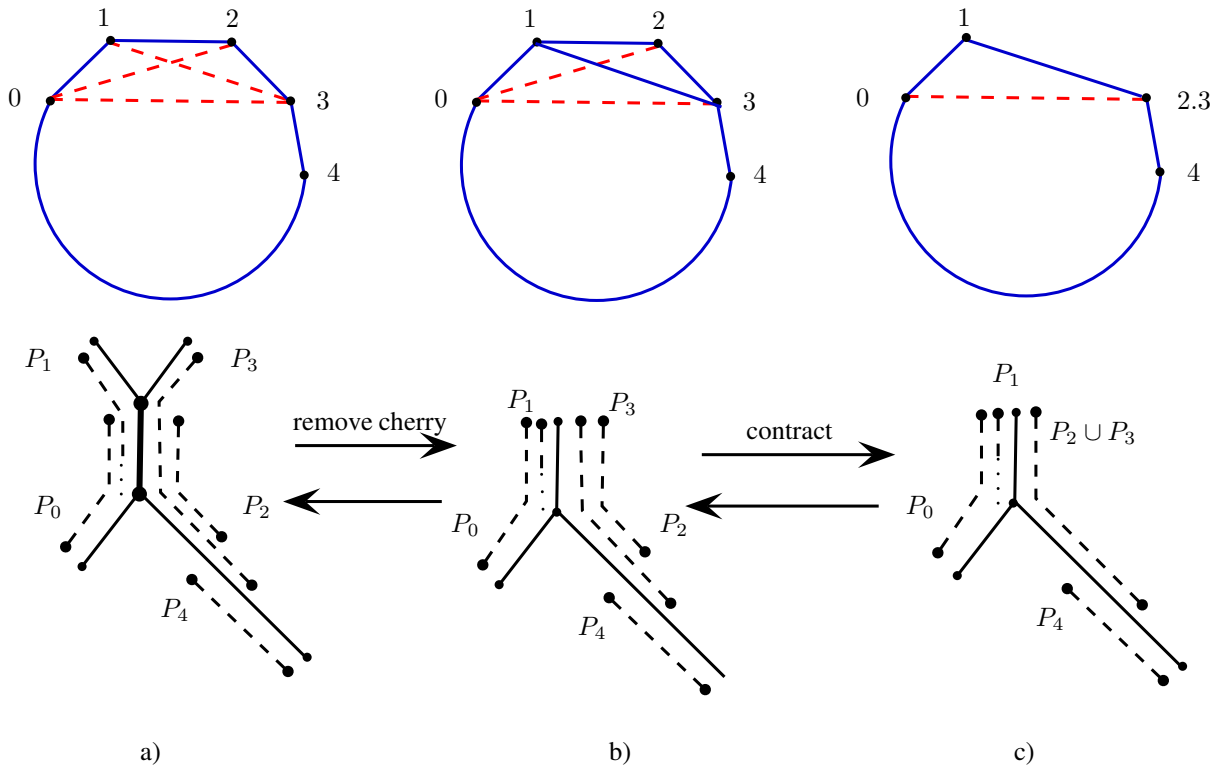

Fig. 10: Aggressive contraction of a single (K_4, P_4) .

Lemma 4.7 implies an algorithm for finding the unique minimal representation of pairs satisfying (P3). Algorithm `FINDMINIMALREPRESENTATION-P3` is a recursive algorithm that processes a single (K_4, P_4) or a twin of (K_4, P_4) s at every invocation. The processing is done by applying aggressive contraction to convert the involved (K_4, P_4) (s) to (K_3, P_3) (s), solving the problem recursively, and finally transforming the representation of the (K_3, P_3) to a representation of a (K_4, P_4) . In the Build Representation phase, Algorithm `FINDMINIMALREPRESENTATION-P3` performs the reversal of steps 1 and 2 described in Lemma 4.7, (see Figures 10, 11).

A *broken tour with cherries* is a representation obtained by adding cherries to a broken tour. See Figure 12 for an example of a broken planar tour with cherries and the graph pair induced by it.

Theorem 4.2 *P3-HAMILTONIANPAIRREC can be solved in polynomial time. YES instances have a unique solution, and whenever $n \geq 6$ this solution is a broken planar tour with cherries.*

Proof: As the case $|V(G'')| < 6$ is already solved, we will show that for any given pair (G'', C'') with $|V(G'')| \geq 6$, `FINDMINIMALREPRESENTATION-P3` solves `P3-HAMILTONIANPAIRREC`. If (G'', C'') is a "NO" instance,

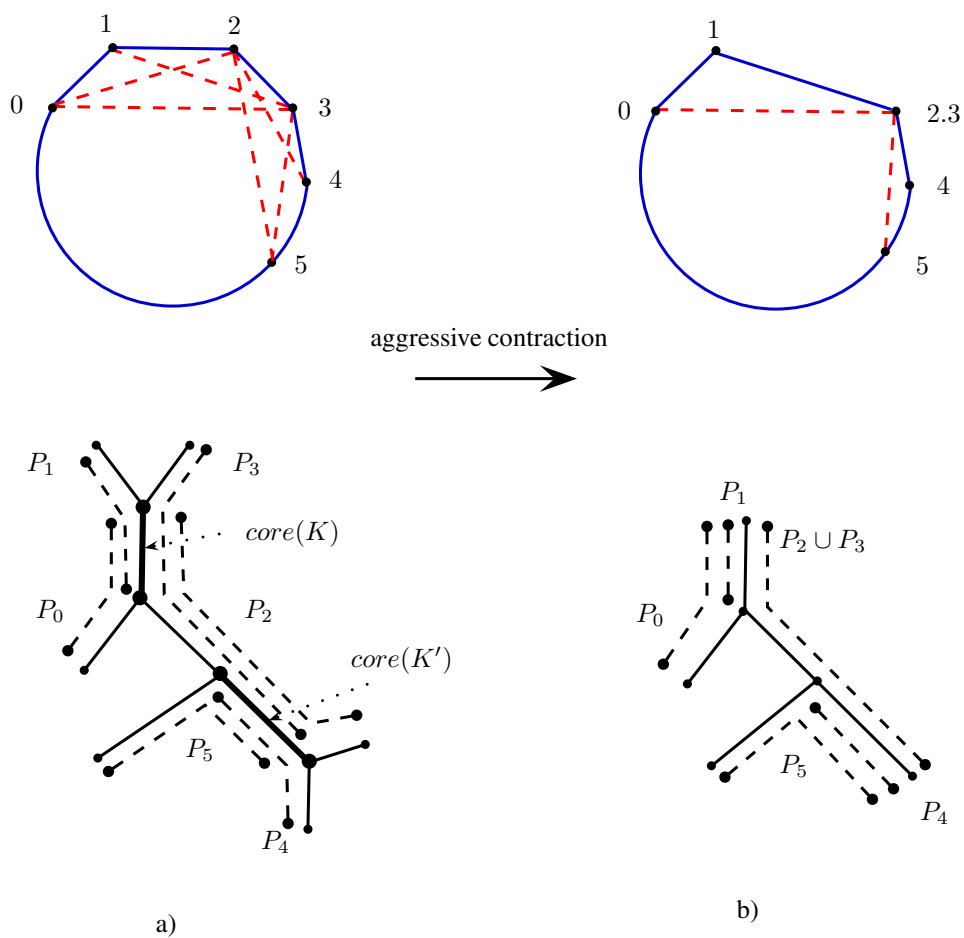

Fig. 11: Aggressive contraction of twins.

Algorithm 2 FINDMINIMALREPRESENTATION-P3(G'', C'')**Require:** $C'' = \{0, 1, \dots, |V(G'')| - 1\}$ is an Hamiltonian cycle of G'' and $|V(G'')| \geq 6$ **Ensure:** A minimal representation $\langle \bar{T}, \bar{\mathcal{P}} \rangle$ of (G'', C'') satisfying (P3) if any1: **if** (G'', C'') is (K_4, P_4) -free **then**2: **return** FINDMINIMALREPRESENTATION-P2-P3($G'', C'', \mathcal{W}(G'', C'')$)

3:

Aggressive Contraction:4: Pick a (K_4, P_4) , $K = [i, i + 1, i + 2, i + 3]$ of (G'', C'') .

▷ Renumber vertices if necessary.

5: $(G', C') \leftarrow (G'', C'')_{/K}$.

6:

Recurse:7: $\langle \bar{T}', \bar{\mathcal{P}}' \rangle \leftarrow$ FINDMINIMALREPRESENTATION-P3(G', C').

8:

Build Representation:9: $\langle \bar{T}, \bar{\mathcal{P}} \rangle \leftarrow \langle \bar{T}', \bar{\mathcal{P}}' \rangle$.10: Replace $P_{(i+2), (i+3)}$ by two copies P_{i+2} and P_{i+3} of itself.11: **if** $i + 2$ is adjacent to $i + 4$ in G'' **then**12: ▷ $K' = [i + 5, i + 4, i + 3, i + 2]$ is the twin of K in (G'', C'') 13: MAKECHERRY($\langle \bar{T}, \bar{\mathcal{P}} \rangle, i + 4, i + 2$).14: **else**▷ K is a single15: $w \leftarrow$ the endpoint of P_{i+2} which is not in $core(K)$.16: ADJUSTENDPOINT($\langle \bar{T}, \bar{\mathcal{P}} \rangle, G'', P_{i+2}, w$).17: MAKECHERRY($\langle \bar{T}, \bar{\mathcal{P}} \rangle, i + 1, i + 3$).

18:

Validate:19: **if** $EPT(\bar{\mathcal{P}}) = G''$ and $\bar{\mathcal{P}}$ satisfies (P3) **then**20: **return** $\langle \bar{T}, \bar{\mathcal{P}} \rangle$ 21: **else**22: **return** “NO”23: **function** MAKECHERRY($\langle \bar{T}, \bar{\mathcal{P}} \rangle, p, q$)24: Let $v \in V(\bar{T})$ be the common endpoint of P_p, P_q .25: Add two new vertices v', v'' and two edges $\{v, v'\}, \{v, v''\}$ to \bar{T} .26: Extend P_p so that the endpoint v is moved to v' .27: Extend P_q so that the endpoint v is moved to v'' .

then the instance has no representation satisfying (P3). In this case then the algorithm returns “NO” at the validation phase. Therefore, we assume that (G'', C'') is a “YES” instance, and prove the claim by induction on the number k of induced (K_4, P_4) pairs of (G'', C'') .

If $k = 0$ then (G'', C'') does not contain any (K_4, P_4) pairs, therefore satisfies (P2). In this case the algorithm invokes FINDMINIMALREPRESENTATION-P2-P3 and the claim follows from Theorem 3.1.

Otherwise $k > 0$. We assume that the claim holds for any $k' < k$ and prove that it holds for k . In this case, as the pair contains at least one (K_4, P_4) , one such pair K is chosen arbitrarily by the algorithm and aggressively contracted. The resulting pair $(G', C') = (G'', C'')_{/K}$ has the following properties:

- Satisfies (P3). (By Lemma 4.7)
- The number of (K_4, P_4) pairs is strictly less than k .
- $|V(G')| \geq 6$. This is because $|V(G')| = |V(G'')| - 1$ and $|V(G'')| > 6$. Indeed, if $|V(G'')| = 6$, we have $k = 0$ by Lemma 4.5.

Therefore, (G', C') satisfies the assumptions of the inductive hypothesis. Then, $\langle \bar{T}', \bar{P}' \rangle$ is the unique minimal representation of $(G'', C'')_{/K}$ satisfying (P3). It remains to show that the representation $\langle \bar{T}, \bar{P} \rangle$ is obtained from the representation $\langle \bar{T}', \bar{P}' \rangle$ returned by the algorithm, by applying the steps described in Lemma 4.7.

Let without loss of generality $K = [i, i+1, i+2, i+3]$. By Lemma 4.6, K has a twin $K' = [i+5, i+4, i+3, i+3]$ if and only if $\{i+2, i+4\}$ is an edge of G'' . The algorithm checks the existence of this edge and takes two different actions, accordingly.

If K is not a twin then step 2, i.e. the union operation is reversed by breaking apart the path $P_{(i+2).(i+3)}$ into two paths P_{i+2} and P_{i+3} . Then step 1 is reversed by invoking procedure MAKECHERRY (see Figure 10).

If K is a twin, then $cherry(K)$ and $cherry(K')$ are uniquely determined by Lemma 4.3 (ii) and procedure MAKECHERRY acts accordingly. This determines all the endpoints of $P_i, P_{i+1}, P_{i+2}, P_{i+3}, P_{i+4}, P_{i+5}$ that are different from the representation $\langle \bar{T}', \bar{P}' \rangle$ (see Figure 11). \square

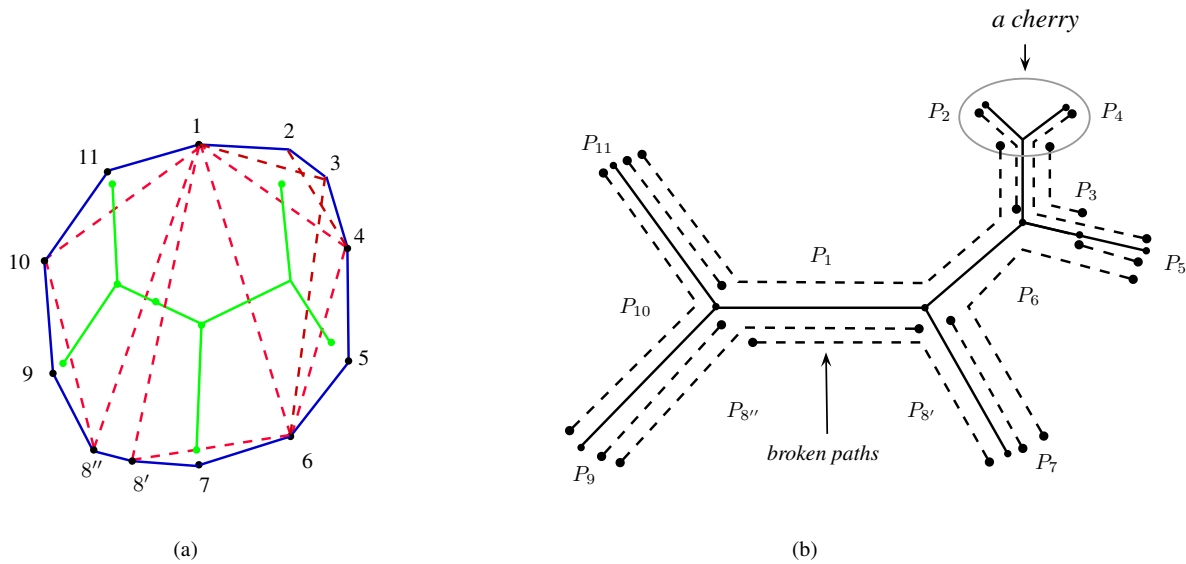

Fig. 12: (a) A pair (G, C) with a contractible edge $\{8', 8''\}$ and a subgraph (K_4, P_4) induced by $\{1, 2, 3, 4\}$ (b) A representation of (G, C) : a broken planar tour with a cherry.

5 General Pairs (G, C)

In this section we show that it is impossible to generalize the algorithms presented in the previous sections to the case where (P3) does not hold, unless $P = NP$.

We start with a definition and a related lemma that are central to this section. Given a pair (G, G') and a subset S of $V(G)$, the *component graph* $\text{comp}(G, G', S)$ is a graph whose vertices correspond to the connected components G_1, G_2, \dots of $G \setminus S$ and two vertices corresponding to components G_i, G_j are connected by an edge if and only if there is a vertex $v \in S$ adjacent to both of G_i and G_j in G' (see Figure 14 for an example). Whenever G' is a cycle, we term a connected component of $G' \setminus S$ an *arc* of G' separated by S . Clearly, whenever $|S| \geq 2$ every arc is adjacent to exactly 2 vertices of S .

Lemma 5.1 *Let (G, C) be a pair where C is a Hamiltonian cycle of G , and K be a maximal clique of $G \setminus C$. If there is a representation $\langle T, \mathcal{P} \rangle$ of G where $\Delta(T) \leq 3$, then $\text{comp}(G, C, K)$ is 3-colorable.*

Proof: If $|K| \leq 3$, $G \setminus K$ has at most 3 connected components, thus $\text{comp}(G, C, K)$ is 3-colorable. Therefore, we assume $|K| > 3$. If K is an edge-clique defined by an edge e then the paths $\mathcal{P}_K = \{P_v : v \in K\}$ are exactly the paths in \mathcal{P} that contain e . The edge e divides T into two subtrees T_1, T_2 rooted at the endpoints r_1, r_2 of e . Similarly, if K is a claw-clique defined by a claw $\{e_1, e_2, e_3\}$, as T has maximum degree 3, the claw divides the tree into three subtrees T_1, T_2, T_3 , rooted at the center $r_1 = r_2 = r_3 = r$ of the claw. In both cases the following two statements hold: a) every path of $\mathcal{P} \setminus \mathcal{P}_K$ is contained in one of these subtrees, b) every path of \mathcal{P}_K that intersects a subtree T_i crosses its root r_i .

All the vertices of a connected component G_i are represented by paths that are in the same subtree T_j ($j \in \{1, 2, 3\}$). This is because otherwise there are at least two adjacent vertices in G_i that are in two different subtrees, a contradiction. We color every vertex G_i of $\text{comp}(G, C, K)$ with color $j \in \{1, 2, 3\}$ depending on the subtree on which the paths representing its vertices reside. It remains to show that if two connected components are adjacent in $\text{comp}(G, C, K)$ they are colored with different colors.

Assume by contradiction that two components G_1, G_2 of $G \setminus K$ which are adjacent in $\text{comp}(G, C, K)$ are colored with the same color i . Then, there is a vertex $v \in K$ and two vertices $v_1 \in G_1, v_2 \in G_2$ adjacent to v in C . Moreover, v_1 and v_2 are not adjacent in G , because they are in different connected components. Therefore, (i) $P_v \sim P_{v_1}, P_v \sim P_{v_2}$, (ii) $P_{v_1} \parallel P_{v_2}$, (iii) P_{v_1} and P_{v_2} are in T_i , (iv) P_v intersects T_i and crosses its root r_i . Furthermore, we assume without loss of generality that P_{v_1} is closer to r_i than P_{v_2} (see Figure 13). Consider the subtree $T' = \cup_{u \in G_2} P_u$ of T_i . $P_{v_1} \cap T' = \emptyset$, because otherwise there is a path P_u representing a vertex $u \in G_2$ that intersects P_{v_1} , in other words $u \in G_2$ is adjacent to $v_1 \in G_1$, a contradiction. Let $\{v, v'\}$ be the vertices of K adjacent to the arc v_2 belongs to. $P_{v'}$ intersects T_i and crosses its root r_i . Moreover, $P_{v'}$ intersects T' , as it is adjacent to at least one vertex of G_2 . We conclude that $P_{v'}$ contains P_{v_1} . Then $v_1 \sim v'$, i.e. v' and v_1 are adjacent in C . Therefore, $K = \{v, v'\}$, contradicting $|K| > 3$. \square

Lemma 5.2 *It is NP-Hard to determine whether a given pair (G, C) where C is a Hamiltonian cycle of G has representation $\langle T, \mathcal{P} \rangle$ with $\Delta(T) \leq 3$.*

Proof: The proof is by reduction from the 3-colorability problem. Given a graph H , we transform it to a pair (G, C) such that (G, C) has a representation on a tree with maximum degree 3 if and only if H is 3-colorable.

Consult Figure 14 for the following construction. Let $V(H) = \{v_0, \dots, v_{n-1}\}$, $E(H) = \{e_0, \dots, e_{m-1}\}$, and let $d_i = d_H(v_i)$. The pair (G, C) consists of $6m$ vertices. For every edge $e_k = \{v_i, v_j\}$ we construct a path $S_k = (u_{i,k} - u'_{i,k} - u_{j,k} - u'_{j,k} - u_k - u'_k)$ with 6 vertices. The graph C is a cycle obtained by concatenating these m paths, in the order $S_0, S_1, \dots, S_{m-1}, S_0$, i.e. u'_k is connected to $u_{i',k+1}$ where $e_{k+1} = \{v_{i'}, v_{j'}\}$. K is a clique of all the vertices in the even positions of the paths, i.e. $K = \{u'_{i,k}, u'_k : 0 < k < m, i \in e_k\}$ (most of the edges induced by K are not shown in the figure). For every $i < n$, Q_i is a path $(u_{i,k_1} - \dots - u_{i,k_{d_i}})$ where $e_{k_1}, \dots, e_{k_{d_i}}$ are the edges incident to v_i in H . The set E_i^{KQ} of edges connects vertices of Q_i with vertices of K . Specifically, $E_i^{KQ} = \left\{ \left\{ u_{i,k_j}, u'_{i,k_{j'}} \right\} \mid 1 \leq j' < j \leq d_i \right\}$. Finally, $G = C \cup K \cup (\cup_{i < n} Q_i) \cup (\cup_{i < n} E_i^{KQ})$.

We claim that the vertices of the graph $H' = \text{comp}(G, C, K)$ can be partitioned into two sets A, B such that a) $H'[A]$ is isomorphic to H , b) $H'[B]$ is an independent set, c) $d_{H'}(v) \leq 2$ for every vertex $v \in B$. Indeed, $G \setminus K$ contains the vertices $\{u_{i,k}, u_k : k < m, i \in e_k\}$ where each u_k is an isolated vertex and the rest is the disjoint union of the paths Q_i . Therefore, the component graph H' consists of the vertices $A = \{Q_i : i < n\}$ and $B = \{u_k : k < m\}$. For two vertices v_i, v_j of H , Q_i and Q_j are connected by the vertex $u'_{i,k} \in V(K)$ if and only if $e_k = \{v_i, v_j\}$ is an edge of H . Therefore, $H'[A]$ is isomorphic to H . Moreover, a vertex u_k of G is connected to at most two paths Q_i via its two neighbors in C . Therefore, $H'[B]$ is an independent set and every vertex of B has degree at most 2 in H' . We conclude that H is 3-colorable if and only if H' is 3-colorable. If (G, C) has a representation $\langle T, \mathcal{P} \rangle$ with $\Delta(T) \leq 3$ then, by Lemma 5.1, H' is 3-colorable. It remains to show that if H'

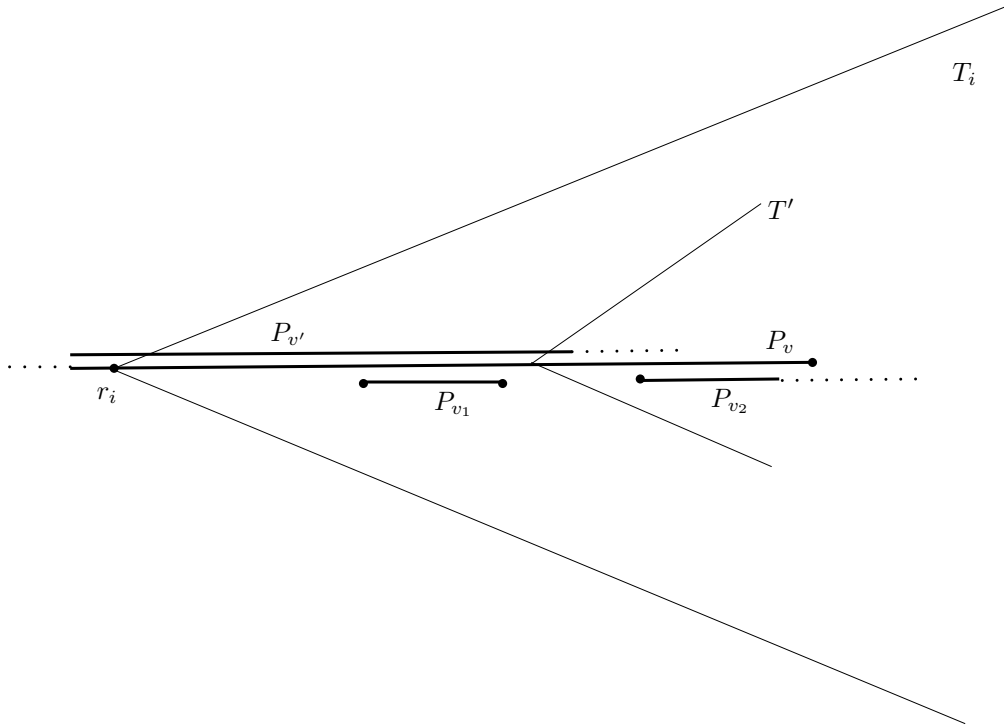

Fig. 13: Proof of Lemma 5.1.

is 3-colorable then (G, C) has such a representation. Given a 3-coloring of H' , in the sequel we present such a representation $\langle T, \mathcal{P} \rangle$ (see Figure 15).

We start with the construction of the tree T . T has a vertex r of degree at most 3 that divides it into at most 3 subtrees T_1, T_2, T_3 , each of which with maximum degree 3. Each T_i corresponds to one color of the given 3-coloring of H' . We describe in detail the subtree T_1 , assuming without loss of generality that the vertices of H' colored with color 1 are $Q_1, Q_2, \dots, Q_{n'}$ and $u_1, u_2, \dots, u_{m'}$. T_1 contains a path $(r - e_1 - \dots - e_{m'} - v_1 - \dots - v_{n'})$. Each vertex e_k starts a path $(e_k - \ell_k)$ of length 1. Each vertex v_i starts a path $(v_i - w_i - w_{i,k_1} - \dots - w_{i,k_{d_i}})$ where $e_{k_1}, \dots, e_{k_{d_i}}$ are the edges incident to v_i in G . Each vertex $w_{i,k}$ starts a path $(w_{i,k} - \ell_{i,k})$ of length 1.

We proceed with the construction of the paths \mathcal{P} . Every vertex u_k of G is represented by a path P_k of length 1 starting at vertex ℓ_k . Each vertex $u_{i,k}$ of G is represented by a path $P_{i,k}$ of length 3 starting at $\ell_{i,k}$ and towards r . It remains to describe the representation of the vertices of K . Every vertex u' of K is adjacent to two vertices of $V(C) \setminus K$ in C . We represent u' by a path between two leaves of T (not all of them shown in the figure). These leaves are exactly the leaves that constitute endpoints of the paths corresponding to the two neighbors of u' . Specifically:

- A vertex $u'_{i,k}$ of S_k that is between two vertices $u_{i,k}$ and $u_{j,k}$ of S_k is represented by a path $P'_{i,k}$ between the two leaves $\ell_{i,k}$ and $\ell_{j,k}$.
- A vertex $u'_{j,k}$ of S_k that is between two vertices $u_{j,k}$ and u_k of S_k is represented by a path $P'_{j,k}$ between the two leaves $\ell_{j,k}$ and ℓ_k .
- A vertex u'_k of S_k that is between two vertices u_k of S_k and $u_{i,k+1}$ of S_{k+1} is represented by a path P'_k between the two leaves ℓ_k and $\ell_{i,k+1}$.

The vertices $u_{i,k}$ and $u_{j,k}$ are in the connected components Q_i and Q_j respectively, which in turn are adjacent in H' (by the existence of $u'_{i,k} \in K$ between them). They are therefore assigned different colors, i.e. the leaves $\ell_{i,k}$ and $\ell_{j,k}$ are in different subtrees of T . Therefore, $P'_{i,k}$ crosses r . It can be verified that this holds for the other two cases too. We conclude that the vertices of K are represented by paths that cross r . If H' is 2-colorable then they constitute an edge-clique, otherwise they constitute a claw-clique. We leave to the reader to verify that $\langle T, \mathcal{P} \rangle$ is a representation of (G, C) . \square

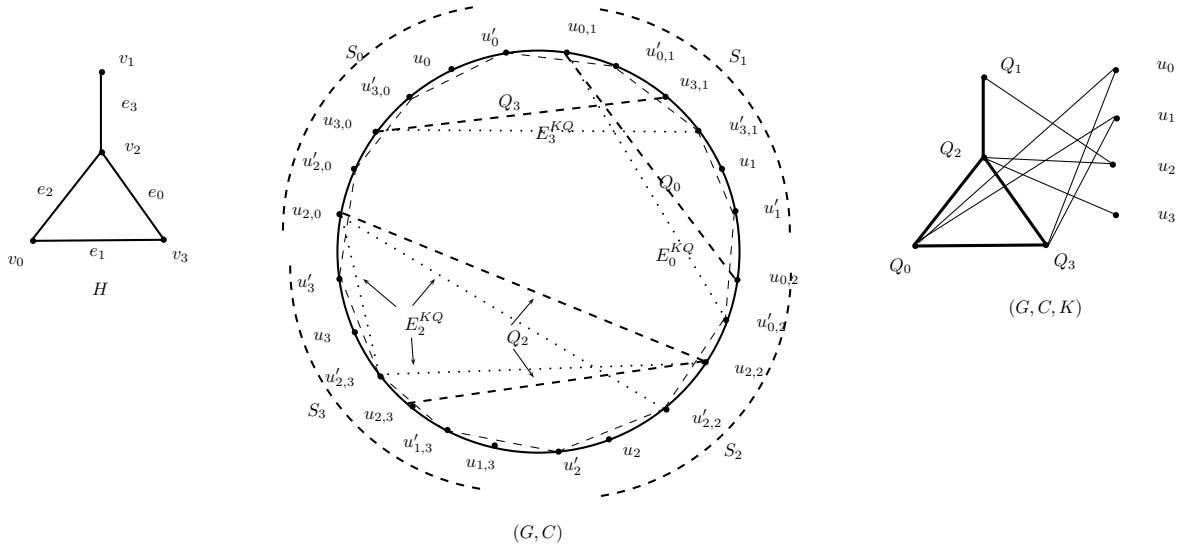

Fig. 14: A graph H , the corresponding pair (G, C) and the component graph $comp(G, C, K)$ where $K = \{u'_{i,k}, u'_k : 0 < k < m, i \in e_k\}$.

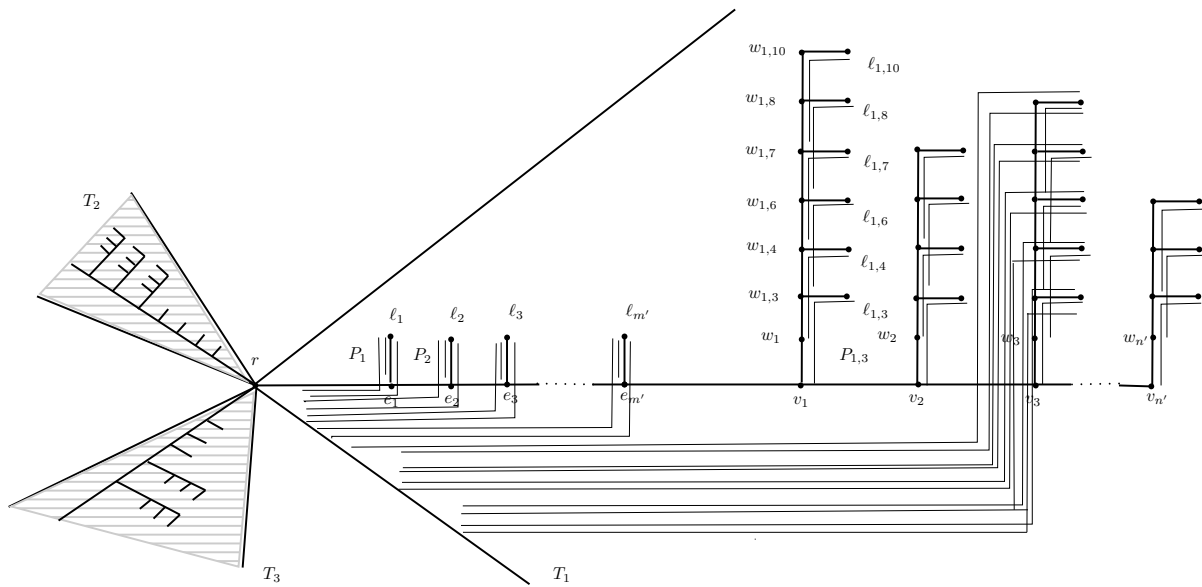

Fig. 15: A representation $\langle T, \mathcal{P} \rangle$ of a pair (G, C) corresponding to some 3-colorable graph H .

Theorem 5.1 HAMILTONIANPAIRREC is NP-Hard.

Proof: We claim that the decision version of the problem is NP-Hard even when G is restricted to the family of VPT graphs. If the instance is a “YES” instance, then G is both a VPT and an EPT graph. In this case, by Theorem 2 of Golubic and Jamison (1985b), (G, C) has a representation on a tree with maximum degree 3. If the instance is a “NO” instance then, clearly, (G, C) does not have a representation on a tree with maximum degree 3. By Lemma 5.2 it is NP-Hard to decide whether (G, C) has a representation on a tree with maximum degree 3. \square

6 Conclusions and Future Work

In this study, we considered the characterization of minimal representations of ENPT cycles. We described an algorithm finding the unique minimal representation of a pair of ENPT and EPT graphs that satisfy assumption $(P3)$, i.e. every red clique is represented by a claw-clique. Through this algorithm we characterized the representations of ENPT cycles as broken planar tours with cherries. We have shown that there is no efficient algorithm to achieve this goal in general (i.e. without this assumption) unless $P = NP$.

Note that if we allow red edge-cliques, the representation is not necessarily a planar tour. The first such representation is a non-planar tour whose ENPT graph is a cycle. Another example is depicted in Figure 16. This representation is not a tour since the set of its “long” paths does not define a cyclic permutation of the leaves of the tree.

Another direction of research would be to investigate the relation of ENPT graphs with other graph classes. It is easy to see that $ENPT \setminus EPT \neq \emptyset$; for example consider the wheel $W_{5,1} = C_5 + K_1$: it is not EPT graph but is an ENPT graph. Golubic and Jamison (1985b) characterized the graphs in $VPT \cap EPT$. Another interesting research topic could be the characterization of the graphs in $EPT \cap ENPT$.

Last but not least, restriction to EPT graphs of decision/optimization problems known to be NP-Hard in general graphs, such as minimum vertex coloring, maximum stable set, and hardness of recognition of ENPT graphs seem to be major problems to investigate on these graphs.

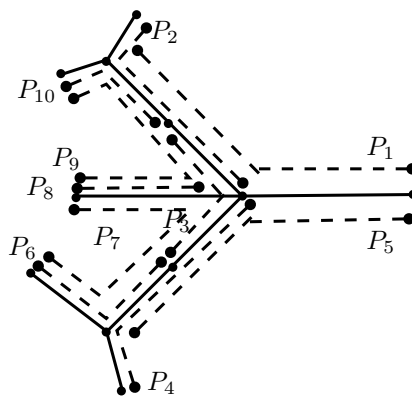

Fig. 16: A representation of C_{10} which is not a tour.

References

- T. C. Biedl and M. Stern. On edge-intersection graphs of k -bend paths in grids. *Discrete Mathematics & Theoretical Computer Science*, 12(1):1–12, 2010.
- A. Boyacı, T. Ekim, M. Shalom, and S. Zaks. Graphs of edge-intersecting non-splitting paths in a tree: Towards hole representations. In *WG 2013, 39th International Workshop on Graph-Theoretic Concepts in Computer Science*, volume 8165 of *Lecture Notes in Computer Science*, pages 115–126, June 2013.
- A. Boyacı, T. Ekim, M. Shalom, and S. Zaks. Graphs of edge-intersecting non-splitting paths in a tree: Towards hole representations-Part I. *Discrete Applied Mathematics*, 215:47–60, December 2016.

- K. Cameron, S. Chaplick, and C. T. Hoàng. Edge intersection graphs of L-shaped paths in grids. *Discrete Applied Mathematics*, 210:185 – 194, 2016.
- G. Chartrand and F. Harary. Planar permutation graphs. *Annales de l'institut Henri Poincaré (B) Probabilités et Statistiques*, 3 (4):433–438, 1967.
- I. Chlamtac, A. Ganz, and G. Karmi. Lightpath communications: An approach to high bandwidth optical wan's. *IEEE Transactions on Communications*, 40(7):1171–1182, Jul 1992.
- D. H. C. Du and R. J. Vetter. Distributed computing with high-speed optical networks. In *Proceeding of IEEE Computer*, volume 26, pages 8–18, 1993.
- D. Epstein, M. Golumbic, and G. Morgenstern. Approximation algorithms for B1-EPG graphs. *Lecture Notes in Computer Science (including subseries Lecture Notes in Artificial Intelligence and Lecture Notes in Bioinformatics)*, 8037 LNCS: 328–340, 2013.
- F. Gavril. A recognition algorithm for the intersection graphs of paths in trees. *Discrete Mathematics*, 23(3):211 – 227, 1978.
- F. Gavril. Maximum weight independent sets and cliques in intersection graphs of filaments. *Information Processing Letters*, 73(5-6):181 – 188, 2000.
- O. Gerstel, R. Ramaswami, and G. Sasaki. Cost effective traffic grooming in wdm rings. In *INFOCOM'98, Seventeenth Annual Joint Conference of the IEEE Computer and Communications Societies*, 1998.
- M. C. Golumbic. *Algorithmic Graph Theory and Perfect Graphs (Annals of Discrete Mathematics, Vol 57)*. North-Holland Publishing Co., Amsterdam, The Netherlands, 2004. ISBN 0444515305.
- M. C. Golumbic and R. E. Jamison. The edge intersection graphs of paths in a tree. *Journal of Combinatorial Theory, Series B*, 38(1):8 – 22, 1985a.
- M. C. Golumbic and R. E. Jamison. Edge and vertex intersection of paths in a tree. *Discrete Mathematics*, 55(2):151 – 159, 1985b.
- M. C. Golumbic, M. Lipshteyn, and M. Stern. Equivalences and the complete hierarchy of intersection graphs of paths in a tree. *Discrete Appl. Math.*, 156:3203–3215, Oct. 2008a.
- M. C. Golumbic, M. Lipshteyn, and M. Stern. The k-edge intersection graphs of paths in a tree. *Discrete Appl. Math.*, 156: 451–461, Feb. 2008b.
- M. C. Golumbic, M. Lipshteyn, and M. Stern. Representing edge intersection graphs of paths on degree 4 trees. *Discrete Mathematics*, 308(8):1381–1387, 2008c.
- M. C. Golumbic, M. Lipshteyn, and M. Stern. Edge intersection graphs of single bend paths on a grid. *Networks*, 54(3): 130–138, 2009.
- D. Heldt, K. Knauer, and T. Ueckerdt. Edge-intersection graphs of grid paths: the bend-number. *Discrete Applied Mathematics*, 167:144–162, 2014.
- B. Lévêque, F. Maffray, and M. Preissmann. Characterizing path graphs by forbidden induced subgraphs. *J. Graph Theory*, 62: 369–384, Dec. 2009.
- M. Pergel and P. Rzażewski. On edge intersection graphs of paths with 2 bends. In *Graph-Theoretic Concepts in Computer Science - 42nd International Workshop, WG 2016, Istanbul, Turkey, June 22-24, 2016, Revised Selected Papers*, Lecture Notes in Computer Science, pages 207–219, 2016.
- R. Ramaswami. Multi-wavelength lightwave networks for computer communication. *IEEE Communications Magazine*, 31: 78–88, 1993.
- J. Spinrad and R. Sritharan. Algorithms for weakly triangulated graphs. *Discrete Applied Mathematics*, 59(2):181 – 191, 1995.
- R. E. Tarjan. Decomposition by clique separators. *Discrete Mathematics*, 55(2):221 – 232, 1985.