

# Angles in Fuzzy Disc and Angular Noncommutative Solitons

SHINPEI KOBAYASHI <sup>1</sup> and TSUGUHIKO ASAKAWA <sup>2</sup>

<sup>1</sup> *Department of Physics, Gunma National College of Technology,  
580 Toribamachi, Maebashi, 371-8530, JAPAN*

<sup>2</sup> *Department of Physics, Graduate School of Science,  
Tohoku University, Sendai 980-8578, JAPAN*

## abstract

The fuzzy disc, introduced by the authors of [1], is a disc-shaped region in a noncommutative plane, and is a fuzzy approximation of a commutative disc. In this paper we show that one can introduce a concept of angles to the fuzzy disc, by using the phase operator and phase states known in quantum optics. We gave a description of the fuzzy disc in terms of operators and their commutation relations, and studied properties of angular projection operators. A similar construction for the fuzzy annulus is also given. As an application, we constructed fan-shaped soliton solutions of a scalar field theory on the fuzzy disc. We also applied this concept to the theory of noncommutative gravity we proposed in [2]. In addition, possible connections to some systems in physics are suggested.

---

<sup>1</sup>E-mail: [shimpei@nat.gunma-ct.ac.jp](mailto:shimpei@nat.gunma-ct.ac.jp)

<sup>2</sup>E-mail: [asakawa@tuhep.phys.tohoku.ac.jp](mailto:asakawa@tuhep.phys.tohoku.ac.jp)

# Contents

<b>1</b>	<b>Introduction</b>	<b>2</b>
<b>2</b>	<b>Review of the Fuzzy Disc</b>	<b>4</b>
2.1	Moyal plane . . . . .	4
2.2	Fuzzy disc . . . . .	6
<b>3</b>	<b>Angles in the Fuzzy Disc and Angular Projection Operators</b>	<b>8</b>
3.1	Pegg-Barnett’s Phase Operator . . . . .	8
3.2	Angles in the fuzzy disc . . . . .	11
3.3	Angular projection operators . . . . .	14
3.4	Fuzzy annulus . . . . .	18
<b>4</b>	<b>Applications</b>	<b>18</b>
4.1	Angular Noncommutative Solitons in Scalar Field Theory . . . . .	18
4.2	Angular Noncommutative Solitons in Gravity . . . . .	20
<b>5</b>	<b>Conclusion and Discussion</b>	<b>22</b>

## 1 Introduction

Noncommutative geometry and its applications to field theories have been extensively investigated for a long time. Naive motivation for them would come from how we should quantize spacetime. Although there is no reliable answer for this question, the concept of quantum geometry and the physics related to it seem very fascinating.

It is known that there are nontrivial solutions for a theory on such a noncommutative space in spite that it does not have any nontrivial solution in its commutative limit. The GMS soliton, which is the solution of a scalar field theory on a three-dimensional spacetime with noncommutativity between spatial coordinates, is a well-known example for that [3]. There the noncommutativity is introduced by the “canonical” commutation relation  $[\hat{x}, \hat{y}] = i\theta$ , where  $\hat{x}$  and  $\hat{y}$  are spatial coordinates and  $\theta$  is a parameter that governs the noncommutativity of the space which is known as the Moyal plane. In finding nontrivial solutions, projection operators

are essential. The operators of the form  $|n\rangle\langle n|$  are frequently used, where  $|n\rangle$  is an eigenstate of the number operator  $\hat{N} = \hat{a}^\dagger \hat{a}$ . When considering a scalar field as a tachyon on a non-BPS D2-brane, it is known that such a noncommutative soliton corresponds to a D0-brane [4, 5, 6].

In [2], we applied the GMS solitons to a  $(2+1)$ -dimensional gravity on a Moyal plane that has a cosmological constant term only, which means that it does not have the Ricci scalar term. Nevertheless, there do exist nontrivial solutions in the theory when the noncommutativity between the space coordinates is imposed. In particular, we found a solution whose geometry is a disc in a noncommutative Minkowski spacetime with the metric [2]

$$G_{\mu\nu} = \eta_{\mu\nu}(|0\rangle\langle 0| + |1\rangle\langle 1| + \cdots + |N-1\rangle\langle N-1|). \quad (1.1)$$

Apart from the metric, this spacetime is equivalent to the fuzzy disc, which was first referred in [1, 7, 8]. The fuzzy disc is a disc-shaped region in a Moyal plane and is a fuzzy approximation of a commutative disc by matrices with finite degrees of freedom. The algebra is a subalgebra of the one characterizing the Moyal plane with a  $\star$  product and depends on the size of the matrices  $N$  and the noncommutative parameter  $\theta$ . It was introduced for describing the quantum Hall effect as a Chern-Simon theory on that space. The behavior of the fuzzy disc in various limits are investigated in [1, 7, 8]. For example, they took the limit of  $N \rightarrow \infty$  and  $\theta \rightarrow 0$  with  $N\theta$  fixed, which corresponds to recovering a commutative disc with a radius fixed.

In this respect, the fuzzy disc is a fascinating arena where gravity, condensed matter and D-branes meet together. However, most of the consideration so far were based on the number operator and projection operators  $|n\rangle\langle n|$ , which correspond to looking the fuzzy disc by cutting it concentrically. On the other hand, as far as finding nontrivial solutions we mentioned above, we can use any kind of projection operators, as is already referred in [3].

Now we explain what we would like to do in this paper. The main issue of this paper is to address how a concept of angles can be introduced to the fuzzy disc. We will show that there is a well-defined notion of the “angle” operator  $\hat{\varphi}$  on the fuzzy disc, which is known as the phase operator suggested by Pegg and Barnett in quantum optics [9]. Together with the number operator  $\hat{N}$ , we can characterize the fuzzy disc by certain commutation relations. The corresponding angle states which are the eigen states of  $\hat{\varphi}$  make possible to define another class of projection operators, angular projection operators  $|\varphi_m\rangle\langle\varphi_m|$ . We will use them to construct noncommutative solitons without circular symmetry. These angular projection operators are NOT linear combinations of  $N$  projection operators  $|0\rangle\langle 0|, |1\rangle\langle 1|, \dots, |N-1\rangle\langle N-1|$ , but consist of  $|n\rangle\langle m|$  with  $n \neq m$ . Due to this, they pick up fan-shaped regions along a particular discretized direction in the fuzzy disc, as opposed to  $|n\rangle\langle n|$ .

As far as we know, this is the first usage of “angles” in the fuzzy disc. Although we mainly focus on finding new noncommutative soliton solutions of field theories, it gives a new viewpoint to understand the geometry on the fuzzy disc. In fact, this point of view connects the degrees of freedom of the boundary of a disc to those of its bulk as opposed to dividing the disc concentrically by the operators with circular symmetry. This is why the concept of angles is thought to suggest the idea that the fuzzy disc would be a good tool in various fields in physics such as the quantum hall effect or black hole microstates, where the “bulk-boundary correspondence” plays an important role. We will briefly mention these issues and in addition a possibility of an experiment concerning the fuzzy disc by means of laser physics.

The organization of this paper is as follows. In the next section, we review the fuzzy disc introduced by the authors of [1, 7, 8]. In Sec.3, we introduce a concept of angles to the fuzzy disc, by reinterpreting the phase operator of Pegg and Barnett [9, 10, 11, 12]. Then we define the angular projection operators and study their properties. We also refer a fuzzy annulus, which is the fuzzy disc with a hole in its center and is one of the variations of the fuzzy disc. In Sec.4, we consider several applications. First, a scalar field theory on a  $(2 + 1)$ -dimensional spacetime with noncommutative space coordinates is considered. The large-noncommutativity limit of the equation of motion for that theory is derived and new fan-shaped soliton solutions are shown. Second, we consider a gravitational theory on the noncommutative spacetime that we gave in [2]. The last section is for discussions and some implications on possible applications of the fuzzy disc to black hole micro states and a realization of the analogues of fuzzy objects using the Gaussian beam in laser physics.

## 2 Review of the Fuzzy Disc

The fuzzy disc was first introduced in [1, 7, 8], which is a disc-shaped region in a two-dimensional Moyal plane. This is also a fuzzy approximation of the ordinary (i.e., commutative) two-dimensional disc by replacing functions on it with finite  $N \times N$  matrices.

### 2.1 Moyal plane

Let us start with a Moyal plane, which is a flat space with noncommutative coordinates satisfying the Heisenberg commutation relation<sup>1</sup>,

$$[\hat{x}, \hat{y}] = i\theta. \tag{2.1}$$

---

<sup>1</sup> The parameter of noncommutativity  $\theta$  we use through this paper is twice as large as the one used in [1].

The algebra of functions on this noncommutative plane is an operator algebra  $\hat{\mathcal{A}}$  generated by  $\hat{x}$  and  $\hat{y}$ , acting on a Hilbert space  $\mathcal{H} = l^2 = \text{span}\{|0\rangle, |1\rangle, \dots\}$ . Here as in standard quantum mechanics,  $|n\rangle$  is an eigenstate of the number operator

$$\hat{N}|n\rangle = n|n\rangle, \quad \hat{N} \equiv \hat{a}^\dagger \hat{a}, \quad (2.2)$$

where the creation and annihilation operators are defined as

$$\hat{a} = \frac{\hat{x} + i\hat{y}}{\sqrt{2\theta}}, \quad \hat{a}^\dagger = \frac{\hat{x} - i\hat{y}}{\sqrt{2\theta}}. \quad (2.3)$$

Then, any operator is expressed by the matrix elements in this basis as

$$\hat{O} = \sum_{m,n=0}^{\infty} O_{mn} |m\rangle \langle n|, \quad (2.4)$$

where  $O_{mn}$  is a  $c$ -number.

Instead of working with operators, one can also consider functions on the commutative plane with a deformed noncommutative product  $\star$  by means of the Weyl-Wigner correspondence. It associates an operator  $\mathcal{O}_f(\hat{x}, \hat{y})$  with a function (symbol)  $f(x, y)$  such that the product of operators is equivalent to the deformed product as  $\mathcal{O}_f \mathcal{O}_g = \mathcal{O}_{f \star g}$ . Note that there is an ambiguity in this correspondence due to operator ordering. This implies an ambiguity in defining a deformed product. For instance, operators with the Weyl ordering used in [3] are mapped to functions with the Moyal product, while operators with the normal ordering are mapped to functions with the Wick-Voros product. Both of the orderings are equivalent [13]. We adopt the normal ordering through this paper following [1, 7, 8]<sup>2</sup>.

To be more precise, let us consider a normal-ordered operator  $\hat{f}$  that is expanded in terms of the creation and annihilation operators as

$$\hat{f} \equiv \sum_{m,n=0}^{\infty} f_{mn}^{\text{Tay}} \hat{a}^\dagger{}^m \hat{a}^n. \quad (2.5)$$

The symbol map based on the Weyl-Wigner correspondence associates  $\hat{f}$  with a function  $f$  as

$$f(z, \bar{z}) = \langle z | \hat{f} | z \rangle, \quad (2.6)$$

where  $|z\rangle$  is a coherent state satisfying  $\hat{a}|z\rangle = (z/\sqrt{2\theta})|z\rangle$ . Then, a product of two operators  $\hat{f}\hat{g}$  is expressed by the Wick-Voros product

$$(f \star g)(z, \bar{z}) = e^{2\theta \partial_{z'} \partial_{z''}} f(z', \bar{z}') g(z'', \bar{z}'')|_{z=z'=z''}. \quad (2.7)$$

---

<sup>2</sup> The symbol used in [3] is known as the Laguerre-Gaussian function in laser physics. We will comment on this issue in the discussion.

As an example, let us consider a set of orthogonal projection operators

$$\hat{p}_n = |n\rangle\langle n| \quad (n = 0, 1, \dots), \quad (2.8)$$

which satisfy  $\hat{p}_m^\dagger = \hat{p}_m$  and

$$\hat{p}_m \hat{p}_n = \delta_{mn} \hat{p}_n. \quad (2.9)$$

The corresponding function to the projection operator  $\hat{p}_n$  is given by

$$p_n(r) = \langle z | n \rangle \langle n | z \rangle = e^{-\frac{r^2}{2\theta}} \frac{r^{2n}}{n!(2\theta)^n}, \quad (2.10)$$

where we used the following equations;

$$\langle z | n \rangle = e^{-\frac{r^2}{4\theta}} \frac{\bar{z}^n}{\sqrt{n!(2\theta)^n}}, \quad (2.11)$$

$$\langle n | z \rangle = e^{-\frac{r^2}{4\theta}} \frac{z^n}{\sqrt{n!(2\theta)^n}}. \quad (2.12)$$

We note that the function  $p_n(r)$  depends on the radial coordinate  $r$  only, where

$$z = x + iy = re^{i\varphi}. \quad (2.13)$$

Conversely, any circular-symmetric operator  $\hat{f}$  can be expanded by  $\{\hat{p}_0, \hat{p}_1, \dots\}$  as

$$\hat{f} = \sum_{n=0}^{\infty} f_n \hat{p}_n, \quad (2.14)$$

where  $f_n$  is a  $c$ -number. Note that the decomposition of the operators on a Moyal plane by  $\{\hat{p}_0, \hat{p}_1, \dots\}$  is the concentric description of the functions. Also, since the projection operators satisfies the completeness condition

$$\sum_{n=0}^{\infty} \hat{p}_n = 1, \quad (2.15)$$

we can recover the whole Moyal plane by summing all of the projection operators.

## 2.2 Fuzzy disc

The fuzzy disc is defined as a subalgebra of an operator algebra  $\hat{\mathcal{A}}$  on a Moyal plane by restricting to  $N \times N$  matrices in the number basis. It is obtained by the projection  $\hat{\mathcal{A}}_N = \hat{P}_N \hat{\mathcal{A}} \hat{P}_N$  through the rank  $N$  projection operator,

$$\hat{P}_N = \sum_{n=0}^{N-1} \hat{p}_n = \hat{p}_0 + \dots + \hat{p}_{N-1}. \quad (2.16)$$

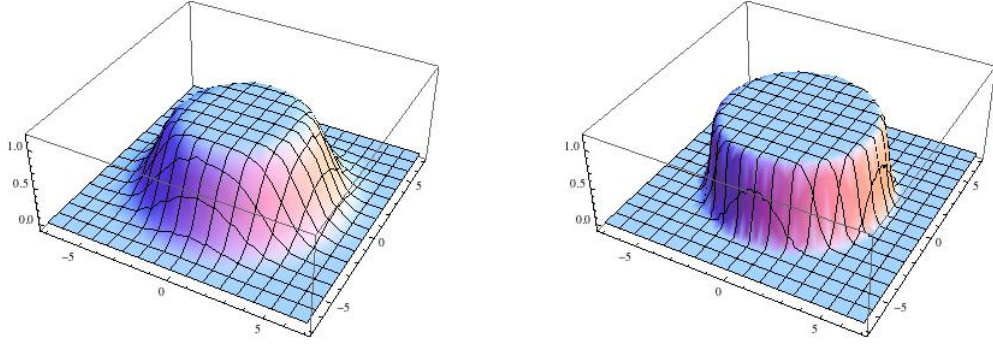

Figure 1: The fuzzy disc for  $N = 10, \theta = 1$  (left) and  $N = 100, \theta = 0.1$  (right).

Any operator in  $\hat{\mathcal{A}}$  has the form  $\hat{P}_N \hat{f} \hat{P}_N$  for  $\hat{f} \in \hat{\mathcal{A}}$ . Note that this operator  $\hat{P}_N$  plays the role of the identity operator  $1_N$  in  $\hat{\mathcal{A}}_N$ . The projection operator also has its corresponding function;

$$P_N(r) = \sum_{n=0}^{N-1} e^{-\frac{r^2}{2\theta}} \frac{r^{2n}}{n!(2\theta)^n} = \frac{\Gamma(N, r^2/(2\theta))}{\Gamma(N)}, \quad (2.17)$$

where  $\Gamma(n, x)$  is the incomplete gamma function. This function is roughly a radial step function that picks up a disc-shaped region around the origin  $z = 0$  with radius  $R = \sqrt{2N\theta}$ . This is why the authors of [1] called  $\hat{\mathcal{A}}_N$  as the fuzzy disc. As examples of the fuzzy discs, those with  $N = 10, \theta = 1$  and with  $N = 100, \theta = 0.1$  are shown in Figure 1.

However, as emphasized in [1],  $\hat{\mathcal{A}}_N$  is isomorphic to the matrix algebra and any fuzzy space is isomorphic to it so that it is not apparent that the space is actually disc-shaped when one works with the matrix algebra. To overcome this difficulty, the authors of [1] investigated the behavior of the fuzzy disc by taking various limits, and claimed that the disc should be recognized in the correlated limit of  $\theta$  and  $N$  keeping the radius  $R$  fixed.

First, they considered the commutative limit;  $\theta \rightarrow 0$  with finite  $N$  fixed. As the radius of the fuzzy disc is given by  $R = \sqrt{2N\theta}$ , this limit makes the fuzzy disc to a one point in the two-dimensional space, which is shown in Figure 2.

Second, they took  $N \rightarrow \infty$  with finite  $\theta$  fixed. As  $\theta$  is not zero, the space remains non-commutative. Then we see the whole Moyal plane is reproduced, which is shown in Figure 3.

One more limit they investigated is that  $N \rightarrow \infty$  and  $\theta \rightarrow 0$  with  $N\theta$  fixed. This corresponds to the situation where the radius of the disc does not change and the noncommutativity disappears. So we obtain the disc with the finite radius and commutative space coordinates. This feature appears in the slope of the fuzzy disc. As shown in Figure 4, the slope of the boundary of the fuzzy disc becomes steeper and steeper as  $N \rightarrow \infty$  and  $\theta \rightarrow 0$  as explained in [1]. The disc becomes the flat and finite region with radius  $R = \sqrt{2N\theta}$ .

They also referred to the edge state in the same paper. The edge state is a localized state of a quantum system with boundary. The most famous example of that would be the edge state in the quantum Hall effect. As is well known, the Hall conductivity is quantized so exactly that it is thought to have the topological origin of the boundary of the system. In particular cases, the behaviors of the boundary determine the whole systems and this is known as the bulk-boundary correspondence [14, 15]. The fuzzy disc has this edge state as one of its states and the relation between the edge states and the noncommutativity is discussed.

### 3 Angles in the Fuzzy Disc and Angular Projection Operators

In this section, we introduce a concept of angles to the fuzzy disc. After briefly reviewing the phase operator developed in quantum optics, we show that this operator can be regarded as the appropriate angle operator. Then, we focus on new angular projection operators that corresponds to fan-shaped regions.

#### 3.1 Pegg-Barnett's Phase Operator

Here we would like to give a short review of the phase operator suggested by Pegg and Barnett, following [16].

In the quantum theory of electromagnetic fields, it is known and widely used that there is an uncertainty relation  $\Delta N \Delta \varphi \geq 1/2$  for the photon number and the phase. Historically, Dirac first referred such a relation, by assuming that there is a Hermitian operator  $\hat{\varphi}$  which satisfies a canonical commutation relation [17],

$$[\hat{N}, \hat{\varphi}] = i, \quad (3.1)$$

where  $\hat{N}$  is the photon-number operator and  $\hat{\varphi}$  is the phase operator that corresponds to a



Figure 2: The section of the fuzzy disc for  $N = 4, \theta = 1$  (left) and for  $N = 4, \theta = 0.01$  (right).





Figure 3: The section of the fuzzy disc for  $N = 4, \theta = 1$  (left) and  $N = 10, \theta = 1$  (right).

$c$ -number  $\varphi$  which appears in the classical radiation field  $a = \sqrt{N}e^{i\varphi}$  [18, 19]. If there would be such a Hermitian operator  $\hat{\varphi}$ , a unitary operator  $\exp(i\hat{\varphi})$  also would exist, and vice versa. However, Susskind and Glogower showed that there is not such a unitary operator, therefore the Hermitian operator corresponding to  $\varphi$  can not exist, either [18].

To see the essence of this argument, let us consider the polar decomposition of the photon annihilation operator

$$\hat{a} = (\hat{N} + 1)^{1/2} \hat{S}^\dagger, \quad (3.2)$$

where  $\hat{S}$  is the shift operator defined by  $\hat{S}|n\rangle = |n+1\rangle$  for all  $n$ . On the other hand, its Hermitian conjugate satisfies

$$\hat{S}^\dagger |n\rangle = \begin{cases} |n-1\rangle & (n \geq 1), \\ 0 & (n = 0). \end{cases} \quad (3.3)$$

Clearly it leads  $\hat{S}^\dagger \hat{S} = 1$  but  $\hat{S} \hat{S}^\dagger = 1 - |0\rangle\langle 0| \neq 1$ . Thus,  $\hat{S}$  can not be unitary (such an operator is called an isometry in operator algebraic language). This means that there is neither

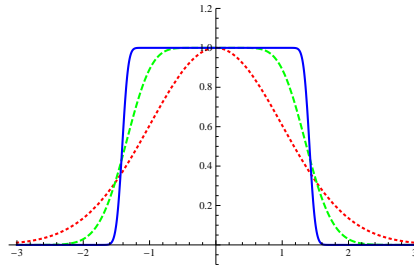

Figure 4: The section of the fuzzy disc for  $N = 1, \theta = 1$  (red, dotted),  $N = 10, \theta = 0.1$  (green, dashed) and  $N = 100, \theta = 0.01$  (blue, solid).

the Hermitian operator  $\hat{\varphi}$  nor the unitary operator of the form  $\hat{S} = \exp(-i\hat{\varphi})$ . Along this line, the construction of a phase operator had been thought to be impossible, but Pegg and Barnett changed this situation [9, 10, 11]. Their idea is based on a phase state  $|\varphi\rangle$  that Loudon suggested in [19],

$$|\varphi\rangle = \lim_{N \rightarrow \infty} \frac{1}{\sqrt{N}} \sum_{n=0}^{N-1} e^{in\varphi} |n\rangle. \quad (3.4)$$

The fact they found is that there is a well-defined phase operator if the Hilbert space is restricted to its finite dimensional subspace. Let  $\mathcal{H}_N = \text{span}\{|0\rangle, \dots, |N-1\rangle\}$  be such a subspace. The construction of them is as follows. They first defined a phase state whose eigenvalue is  $\varphi_0$  as

$$|\varphi_0\rangle = \frac{1}{\sqrt{N}} \sum_{n=0}^{N-1} e^{in\varphi_0} |n\rangle. \quad (3.5)$$

Then it is easy to find the other  $(N-1)$  states  $|\varphi_m\rangle$  that satisfy  $\langle \varphi_m | \varphi_n \rangle = \delta_{mn}$  as

$$|\varphi_m\rangle = \frac{1}{\sqrt{N}} \sum_{n=0}^{N-1} e^{in\varphi_m} |n\rangle, \quad (3.6)$$

where

$$\varphi_m = \varphi_0 + \frac{2\pi}{N}m \quad (m = 0, 1, \dots, N-1). \quad (3.7)$$

Inversely, the expansion of  $|n\rangle$  by  $|\varphi_m\rangle$  is given by

$$|n\rangle = \frac{1}{\sqrt{N}} \sum_{m=0}^{N-1} e^{-in\varphi_m} |\varphi_m\rangle. \quad (3.8)$$

Thereby a set of  $N$  states  $\{|\varphi_0\rangle, |\varphi_1\rangle, \dots, |\varphi_{N-1}\rangle\}$  forms an orthonormal basis for the  $N$ -dimensional subspace  $\mathcal{H}_N$ . By using them, one can define an operator of the following form

$$\hat{\varphi} = \sum_{m=0}^{N-1} \varphi_m |\varphi_m\rangle \langle \varphi_m|. \quad (3.9)$$

We can call this operator  $\hat{\varphi}$  the phase operator that has  $|\varphi_m\rangle$  as its eigen state and  $\varphi_m$  as the corresponding eigen value. Also, it is a Hermitian operator acting on  $\mathcal{H}_N$ . It can be expanded by the number states as

$$\hat{\varphi} = \left( \varphi_0 + \frac{(N-1)\pi}{N} \right) 1_N + \frac{2\pi}{N} \sum_{n \neq n'} \frac{e^{i(n'-n)\varphi_0}}{e^{2\pi i(n'-n)/N} - 1} |n'\rangle \langle n|. \quad (3.10)$$

Now we obtain the unitary operator based on  $\hat{\varphi}$  as

$$\hat{U} = \exp(i\hat{\varphi}), \quad (3.11)$$

where its eigenstates are  $|\varphi_m\rangle$  and the corresponding eigenvalues are  $e^{i\varphi_m}$  for  $m = 0, 1, \dots, N-1$ . When acting on the number basis  $|n\rangle$  ( $n = 1, 2, \dots, N-1$ ), this operator behaves as the (inverse) shift operator, while we have  $\hat{U}|0\rangle = e^{iN\varphi_0}|N-1\rangle$ . That is,  $\hat{U}$  is a cyclic operator,

$$\hat{U} = |0\rangle\langle 1| + |1\rangle\langle 2| + \dots + |N-2\rangle\langle N-1| + e^{iN\varphi_0}|N-1\rangle\langle 0|. \quad (3.12)$$

In this sense, the singularity for the shift operator  $\hat{S}$  at  $n = 0$  which prevents from the construction of the Hermitian operator is resolved.

In the Pegg-Barnett formalism, all quantities are initially defined and calculated on the finite dimensional Hilbert space  $\mathcal{H}_N$ , and then the  $N \rightarrow \infty$  limit has to be taken. The justification of this formalism has been argued and tested experimentally, which leads to physically admissible results for various quantum states of the radiation field so far [20, 21, 22, 23].

### 3.2 Angles in the fuzzy disc

The construction of the phase states and the phase operator in the previous section can be straightforwardly applicable to our setting on the fuzzy disc. Unlike quantum optics, we regard the phase  $\varphi_m$  as an angle in a Moyal plane. From now on, we also call the state  $|\varphi_m\rangle$  the angle state rather than the phase state. Thus we define the angle states in the Hilbert space  $\mathcal{H}_N = \hat{P}_N\mathcal{H} = \text{span}\{|0\rangle, \dots, |N-1\rangle\}$  of the fuzzy disc as

$$|\varphi_m\rangle = \frac{1}{\sqrt{N}} \sum_{n=0}^{N-1} e^{in\varphi_m} |n\rangle, \quad (3.13)$$

and the angle operator as

$$\hat{\varphi} = \sum_{m=0}^{N-1} \varphi_m |\varphi_m\rangle\langle \varphi_m|. \quad (3.14)$$

Here the eigenvalues

$$\varphi_m = \frac{2\pi}{N}m \quad (m = 0, 1, \dots, N-1), \quad (3.15)$$

are  $N$  discrete angles that are uniformly distributed in the interval  $[0, 2\pi]$ , and evidently periodic  $\varphi_{m+N} = \varphi_m$ . They are thus a fuzzy approximation of the continuous angles in a commutative disc. We have set  $\varphi_0 = 0$  as compared to the previous subsection for simplicity. Note also that there is no problem concerning the  $N \rightarrow \infty$  limit at this stage, because the fuzzy disc is defined for a finite  $N$ , as opposed to quantum optics.

Next let us define the number operator restricted to  $\mathcal{H}_N = \text{span}\{|0\rangle, \dots, |N-1\rangle\}$  as

$$\hat{N} = \sum_{n=0}^{N-1} n |n\rangle\langle n|, \quad (3.16)$$

where we have used the same symbol as in the whole Hilbert space  $\mathcal{H} = l^2$ . The eigen value  $n$  works as the radial coordinate on the fuzzy disc (more precisely, the radial coordinate operator should be defined by  $\hat{r} = \sqrt{2\theta\hat{N}}$ ).

Since the original Moyal plane is noncommutative, these two coordinate operators  $\hat{N}$  and  $\hat{\varphi}$  are noncommuting with each other, but the form of their commutation relation is rather complicated. In order to express the noncommutativity, it is more instructive to introduce two more operators defined by

$$\hat{V} := e^{i\frac{2\pi}{N}\hat{N}} = \sum_{n=0}^{N-1} e^{i\frac{2\pi}{N}n} |n\rangle \langle n| = \sum_{m=0}^{N-1} |\varphi_{m+1}\rangle \langle \varphi_m|, \quad (3.17)$$

$$\hat{U} := e^{i\hat{\varphi}} = \sum_{m=0}^{N-1} e^{i\varphi_m} |\varphi_m\rangle \langle \varphi_m| = \sum_{n=0}^{N-1} |n-1\rangle \langle n|, \quad (3.18)$$

where the latter  $\hat{U}$  has already been given in the previous subsection. To prove each equality in these equations, the relation between two orthonormal bases

$$\langle n | \varphi_m \rangle = \frac{1}{\sqrt{N}} e^{in\varphi_m} \quad (3.19)$$

in  $\mathcal{H}_N$ , and an identity

$$\sum_{n=0}^{N-1} e^{i\frac{2\pi}{N}kn} = N\delta_{k,0}. \quad (3.20)$$

for all  $k \in \{0, \dots, N-1\}$  are frequently used<sup>3</sup>.

These operators  $\hat{V}$  and  $\hat{U}$  are unitary and satisfy  $\hat{V}^N = \hat{U}^N = 1_N$ . As seen from the last expression in (3.17),  $\hat{V}$  acts on the angle states as a unit shift, i.e., the rotation of the disc, while  $\hat{U}$  behave as a radial shift operator. It is easy to show the following commutation relations of the operators we encountered:

$$[\hat{N}, \hat{U}] = -\hat{U} + N\hat{U}\hat{\rho}_0, \quad [\hat{\varphi}, \hat{V}] = \frac{2\pi}{N}\hat{V}, \quad \hat{U}\hat{V} = e^{\frac{2\pi i}{N}}\hat{V}\hat{U}. \quad (3.21)$$

We would like to characterize the fuzzy disc in terms of these operators. Before this, recall that the third equation in (3.21) is nothing but the defining commutation relation of the fuzzy torus. Any operator of the form  $\hat{f} = \sum_{m,n=0}^{N-1} f_{mn}\hat{U}^m\hat{V}^n$ , generated by two unitaries  $\hat{U}$  and  $\hat{V}$ , can be regarded as a function on that torus, while  $\hat{N}$  and  $\hat{\varphi}$  play the role of derivatives, as seen from first two commutation relations. What makes this algebra to be that of a torus should again be considered together with the limiting procedure  $N \rightarrow \infty$ .

<sup>3</sup> In the last expression in (3.18), the  $n=0$  term should be understood as  $|-1\rangle := |N-1\rangle$ . But it is just for notational simplicity, and this does not mean any periodicity in the number basis as opposed to the angle basis.

On the contrary, we will now argue that the algebra for the fuzzy disc is generated by a operator

$$\hat{z} = \hat{U} \sqrt{2\theta \hat{N}} = e^{i\hat{\varphi}} \hat{r}, \quad (3.22)$$

and its hermitian conjugate  $\hat{z}^\dagger$ , subject to the commutation relation

$$[\hat{z}, \hat{z}^\dagger] = 2\theta(1 - N\hat{p}_{N-1}), \quad (3.23)$$

and any operator corresponding to a function on a fuzzy disc has the form

$$\hat{f} = \sum_{k,l=0}^{N-1} f_{kl} \hat{z}^{\dagger k} \hat{z}^l. \quad (3.24)$$

Before showing this, we would like to give a few remarks are in order. First, (3.22) is also seen as the polar decomposition of the generator  $\hat{z}$ , written by the Hermitian  $\hat{N}$  and the unitary  $\hat{U}$  operator, as opposed to the creation operator  $\hat{a}$ . Note that  $\hat{z}^\dagger \hat{z} = 2\theta \hat{N}$ . Next, the  $\hat{p}_{N-1}$  term in (3.23) guarantees that the commutator is traceless  $\text{Tr}[\hat{z}, \hat{z}^\dagger] = 0$ . Note also  $\hat{U} \hat{p}_0 = \hat{p}_{N-1} \hat{U}$ .

To show the statement above, recall that the definition of the fuzzy disc algebra is  $\hat{\mathcal{A}}_N = \hat{P}_N \hat{\mathcal{A}} \hat{P}_N$ . Thus, by the Weyl-Wigner correspondence, any function  $f(z, \bar{z})$  on a plane gives an operator in  $\hat{\mathcal{A}}_N$  of the form

$$\hat{f} = \hat{P}_N \left( \sum_{k,l=0}^{\infty} f_{k,l} \hat{a}^{\dagger k} \hat{a}^l \right) \hat{P}_N. \quad (3.25)$$

We show that it reduces to (3.24). First, a function  $f = z$  corresponds to

$$\sqrt{2\theta} \hat{P}_N \hat{a} \hat{P}_N = \sum_{n=1}^{N-1} \sqrt{2\theta n} |n-1\rangle \langle n| = \hat{U} \sqrt{2\theta \hat{N}} = \hat{z}. \quad (3.26)$$

Similarly, for  $f = z^l$  ( $0 \leq l \leq N-1$ ), we obtain an operator

$$(2\theta)^{\frac{l}{2}} \hat{P}_N \hat{a}^l \hat{P}_N = \left( \sqrt{2\theta} \hat{P}_N \hat{a} \hat{P}_N \right)^l = \hat{z}^l, \quad (3.27)$$

where in the first equality,  $1_N = \hat{P}_N + (1 - \hat{P}_N)$  are inserted, and the identity  $(1 - \hat{P}_N) \hat{a} \hat{P}_N = 0$  was used. It is also shown that  $\hat{P}_N \hat{a}^l \hat{P}_N = 0$  for  $N \leq l$ . In the same way, we obtain  $\hat{z}^{\dagger k}$  for  $f = \bar{z}^k$ , and  $\hat{z}^{\dagger k} \hat{z}^l$  for  $f = \bar{z}^k z^l$  ( $0 \leq k, l \leq N-1$ ), where another identity  $\hat{P}_N \hat{a}^\dagger (1 - \hat{P}_N) = 0$  is also used in these cases. This shows the validity of (3.24). It is regarded as a variant of the Weyl map from functions on the plane to the fuzzy disc algebra, but it is of course not one to one because higher frequency modes than  $N-1$  such as  $z^N$  are projected out.

Next, let us consider the symbol map of operators (3.24), which are functions written by  $(z, \bar{z})$  or  $(r, \varphi)$  on the whole plane, where  $z = r e^{i\varphi}$ . As is easily shown, the symbol of the

generator  $\hat{z}$  is

$$\begin{aligned}
z(r, \varphi) &= \langle z | \hat{z} | z \rangle \\
&= \sum_{n=1}^{N-1} \sqrt{2\theta n} \langle z | n-1 \rangle \langle n | z \rangle \\
&= \sum_{n=1}^{N-1} e^{-\frac{r^2}{2\theta}} \frac{r^{2(n-1)}}{(n-1)!(2\theta)^{n-1}} z \\
&= P_{N-1}(r)z.
\end{aligned} \tag{3.28}$$

This shows that the symbol behave as the original function  $z$ , but weighted by the damping factor  $P_{N-1}(r)$ . A similar analysis shows that the symbol of  $\hat{z}^l$  is  $z^l(r, \varphi) = P_{N-l}(r)z^l$ , weighted by a sharper damping factor than  $z$ . In general, the symbol of (3.24) is given by

$$\begin{aligned}
f(r, \varphi) &= \sum_{k,l=0, k \geq l}^{N-1} f_{kl} P_{N-k}(r) \bar{z}^k z^l + \sum_{k,l=0, k < l}^{N-1} f_{kl} P_{N-l}(r) \bar{z}^k z^l \\
&= \sum_{k,l=0}^{N-1} f_{kl} P_{N-\max\{k,l\}}(r) \bar{z}^k z^l.
\end{aligned} \tag{3.29}$$

It is the polynomial truncation of the original function  $f(z, \bar{z})$  except for the weight factors. All these factors  $P_{N-\max\{k,l\}}(r)$  for finite  $k$  and  $l$  tends to the radial step function in the commutative disc limit  $N \rightarrow \infty$ ,  $\theta \rightarrow 0$  with  $R^2 = 2N\theta$  fixed so that the symbol has actually a value only on the interior of the disc  $|z| < R$ . Moreover, in this limit, higher and higher powers of  $\hat{z}$  and  $\hat{z}^\dagger$  become allowed operators, and finally the space of symbols tends to that of functions on a disc  $\{f(z, \bar{z}) | |z| < R\}$  of radius  $R$ . This shows that the Weyl map above is one to one when restricted to functions on the disc.

In this way, the disc variant of the Weyl-Wigner correspondence is obtained in terms of operators  $\hat{z}$  and  $\hat{z}^\dagger$ , or equivalently  $\hat{r}$  and  $\hat{\varphi}$ . It is now clear that the commutation relation (3.23) corresponding to the relation  $[z, \bar{z}]_\star = 2\theta$  for the Wick-Voros product. The use of these operators would be useful to analyze the structure of the fuzzy discs further, but we do not proceed in this paper and we focus on angular projection operators which will be introduced in the next subsection.

### 3.3 Angular projection operators

In the Hilbert space  $\mathcal{H}_N$ , let us define an angular projection operator

$$\hat{\pi}_k := |\varphi_k \rangle \langle \varphi_k| = \frac{1}{N} \sum_{m,n=0}^{N-1} e^{i(m-n)\varphi_k} |m \rangle \langle n|, \tag{3.30}$$

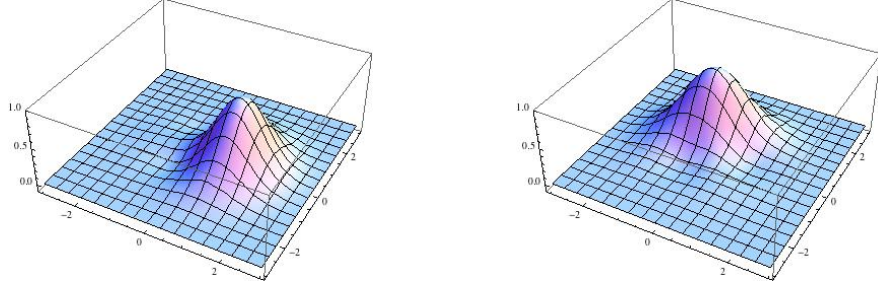

Figure 5: The functions  $\pi_0^{(3)}$  (left) and  $\pi_1^{(3)}$  (right) for  $N = 3$ .

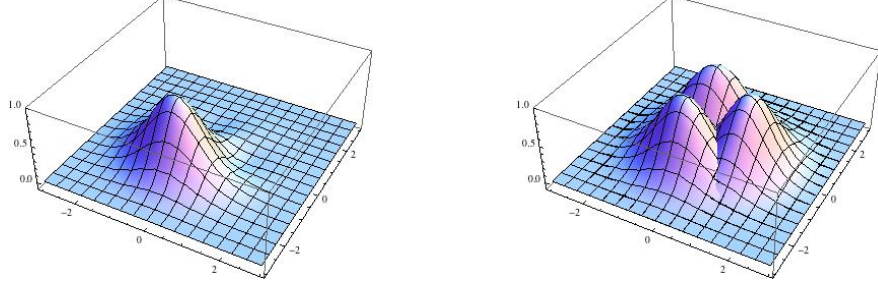

Figure 6: The function  $\pi_2^{(3)}$  (left) and all functions  $\pi_k^{(3)}$ 's (right).

that picks up a particular eigenstate  $|\varphi_k\rangle$  of the angle operator. Because of the orthonormality of the angle states, these projections are orthogonal each other:

$$\hat{\pi}_k \hat{\pi}_l = \delta_{kl} \hat{\pi}_l. \quad (3.31)$$

We also denote it as  $\hat{\pi}_k^{(N)}$  when we would like to emphasize that it is an operator acting on the  $N$ -dimensional Hilbert space  $\mathcal{H}_N$ . By the Weyl-Wigner correspondence, the corresponding function  $\pi_k(r, \varphi)$  on a plane to the angular projection operator  $\hat{\pi}_k$  is obtained as

$$\pi_k(r, \varphi) = \frac{1}{N} \sum_{m,n=0}^{N-1} e^{-\frac{r^2}{2\theta}} \frac{r^{m+n}}{\sqrt{m!n!(2\theta)^{m+n}}} e^{-i(m-n)(\varphi-\varphi_k)}, \quad (3.32)$$

where we used the polar coordinates  $z = r e^{i\varphi}$ . It is a real function in accordance with Hermiticity.

As for the projection operators  $\hat{p}_n$ , the sum of all angular projection operators  $\hat{\pi}_k$  for a given  $N$  satisfies the completeness relation in the Hilbert space  $\mathcal{H}_N$ . That is,

$$\hat{P}_N = 1_N = \hat{\pi}_0 + \cdots + \hat{\pi}_{N-1}. \quad (3.33)$$

By the Weyl-Wigner correspondence, it also maps to a function, which is the radial “step function” with radius  $R = \sqrt{2N\theta}$  on the plane given in (2.17).

The fuzzy disc can be considered as a set of  $N$  “points” with each point having a unit area  $2\pi\theta$ . The two completeness relations in (2.16) and (3.33) correspond to two different

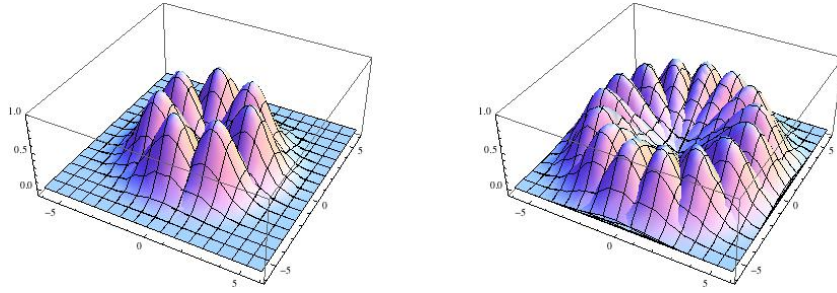

Figure 7: All functions  $\pi_k^{(N)}$ 's for  $N = 7$  (left) and for  $N = 15$  (right). We set  $\theta = 1$  here.

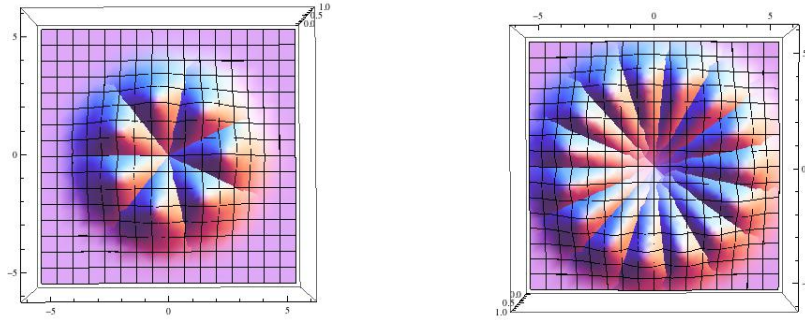

Figure 8: The top views of all  $\hat{\Psi}_k^{(N)}$ 's for  $N = 7$  (left) and for  $N = 15$  (right) . We set  $\theta = 1$  here.

decompositions of the same fuzzy disc. In the former case, a “point” has roughly a shape of annulus distinguished by its radius, while in the latter case, a point is distinguished by its angle. Here we show how “points” are distributed on the plane by the Weyl-Wigner correspondence in Figure 5 - Figure 8.

In Figure 5 and 6 we show the profiles of three functions  $\pi_0^{(3)}$ ,  $\pi_1^{(3)}$  and  $\pi_2^{(3)}$  for  $N = 3$ . In the right figure of Figure 6, we draw these three functions simultaneously (not the sum of them), i.e., the feet of them overlap each other, therefore, at each point  $(r, \varphi)$  only the maximal value among them is visible. This shows that there are three peaks, which are separated by  $2\pi/3$  each other in the angular direction. This behavior is valid for an arbitrary  $N$ , that is, the disc is divided into  $N$  fan-shaped regions according to  $N$  functions, in which each function is peaked at the angle  $\varphi = \varphi_k$ . In Figure 7 and 8, the case of  $N = 7$  and 15 are shown.

One can also repeat the analysis in §2 in considering three limits, but in the way of distinguishing each point.

1.  $\theta \rightarrow 0$  with  $N$  fixed: the point limit

This limit is the small radius limit. As shown in Figure 9, each fan-shaped “point” shrinks



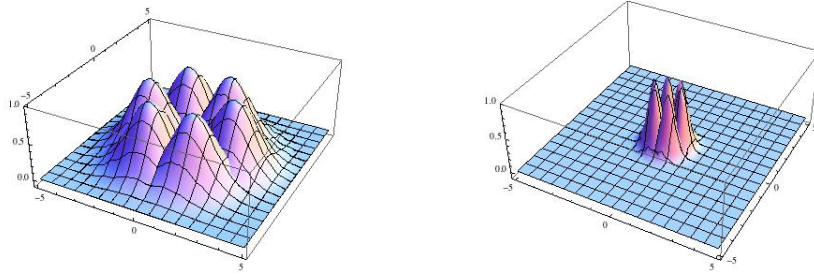

Figure 9: All of the six functions for  $N = 6, \theta = 1$  (left) and for  $N = 6, \theta = 0.1$  (right).

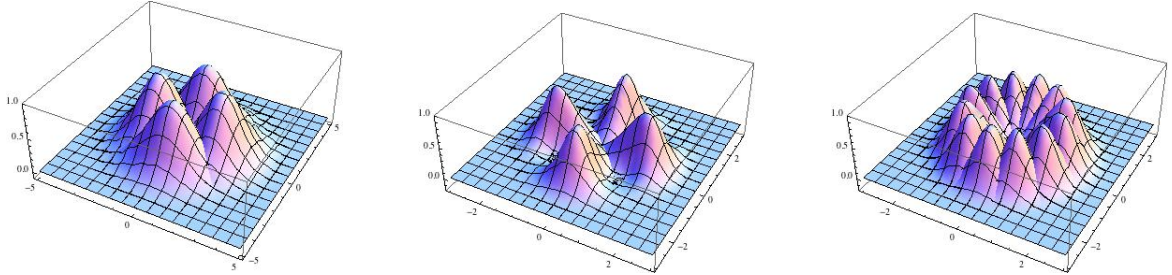

Figure 10: All of the four functions for  $N = 4, \theta = 1$  (left) and four of the twelve functions for  $N = 12, \theta = 1$  (center) whose peaks are in the same positions as in the left figure. The right figure shows all of the twelve functions for  $N = 12, \theta = 1/3$ .

to the origin but there are still distinguished  $N$  points.

2.  $N \rightarrow \infty$  with  $\theta$  fixed: the noncommutative plane limit

This limit corresponds to the large radius limit with increasing the degrees of freedom  $N$  as we have seen in Figure 7 where the  $N = 7$  and  $N = 15$  cases were given. However, because of the problem of the phase operator at  $N \rightarrow \infty$ , whether this limit recovers the full Moyal plane should be justified by more careful analysis.

3.  $N \rightarrow \infty$  and  $\theta \rightarrow 0$  with  $N\theta$  fixed: the commutative disc limit

In this limit, the radius  $R = \sqrt{2N\theta}$  of the disc is fixed but the noncommutativity disappears. Thus we will obtain the commutative disc. As shown in Figure 10, the number of points increases as  $N$  grows, and the area shared by each point decreases.

We conclude this section by a remark. As we have already stated, the fuzzy disc is a collection of  $N$  points, and a point given by an angular projection operator corresponds to a fan-shaped region, just like cutting a cake into  $N$  pieces. This is contrasted to a point given by a radial projection operator, whose form is similar to a baum-kuchen. Our cutting would be useful to applying the fuzzy disc to some physical models, such as the quantization of physical quantities

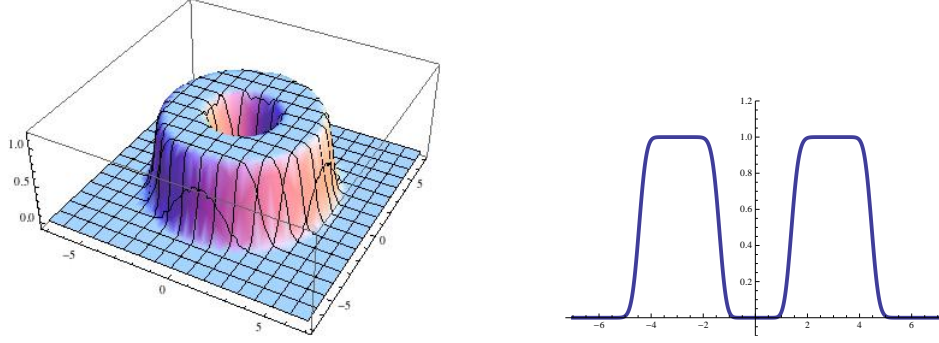

Figure 11: The fuzzy annulus and the cross section of it for  $M = 100$ ,  $N = 10$  and  $\theta = 0.1$ .

on the boundary, e.g., the edge states [14, 15, 24, 25] or black holes [26]. This is because the holography is naturally realized in this picture, i.e., the degrees of freedom on the boundary are equal to that of the entire disc. This issue is left for a future work.

### 3.4 Fuzzy annulus

Here we point out that a fuzzy annulus can be constructed in a similar manner as the fuzzy disc. Let us consider a  $N$ -dimensional subspace  $\mathcal{H}_N^M := \text{span}\{|M\rangle, |M+1\rangle, \dots, |M+N-1\rangle\}$  of the Hilbert space, starting at  $|M\rangle$  for a given  $M > 0$ . On the whole Hilbert space  $\mathcal{H} = l^2$ , it is defined by the projection operator

$$\hat{P}_N^M := \hat{p}_M + \hat{p}_{M+1} + \dots + \hat{p}_{M+N-1}, \quad (3.34)$$

and evidently the subalgebra  $\hat{P}_N^M \hat{A} \hat{P}_N^M$  of  $N \times N$  matrices represents a fuzzy annulus with an inner radius  $R_- = \sqrt{2M\theta}$  and an outer radius  $R_+ = \sqrt{2(N+M)\theta}$ . The corresponding function  $P_N^M(r)$  on the plane is shown in Figure 11. Similar to the fuzzy disc, the  $N$  angle states are defined as

$$|\varphi_m\rangle = \frac{1}{\sqrt{N}} \sum_{n=0}^{N-1} e^{in\varphi_m} |M+n\rangle, \quad (3.35)$$

where  $\varphi_m = \frac{2\pi}{N}m$  ( $m = 0, 1, \dots, N-1$ ) are the same as before.

## 4 Applications

### 4.1 Angular Noncommutative Solitons in Scalar Field Theory

As the first application of the arguments so far, we would like to consider a scalar field theory on the fuzzy disc, which is the fuzzy disc version of [3]. For a scalar field  $\Phi(z, \bar{z})$  defined on the

fuzzy disc with radius  $R = \sqrt{2N\theta}$ , its energy functional is given by<sup>4</sup>

$$E = \int_D d^2z V_\star(\Phi). \quad (4.1)$$

Here the potential  $V_\star(\Phi)$  is a polynomial

$$V_\star(\Phi) = \frac{b_2}{2}\Phi \star \Phi + \frac{b_3}{3}\Phi \star \Phi \star \Phi + \dots, \quad (4.2)$$

of the field  $\Phi$  with respect to the Wick-Voros product, and  $b_r$ 's are constants. Note that the field  $\Phi$  is also considered to be a finite  $N$  Hermitian matrix  $\hat{\Phi}$  in the number basis via the Weyl-Wigner correspondence. Our argument here is valid even for  $N \rightarrow \infty$ , that is, the Moyal plane case.

The energy functional is extremized by solutions of the following equation of motion

$$0 = \frac{\partial V_\star}{\partial \Phi} = b_2\Phi + b_3\Phi \star \Phi + b_4\Phi \star \Phi \star \Phi + \dots \quad (4.3)$$

In the commutative case (that is,  $\theta = 0$ ), it admits only constant solutions because of the absence of the kinetic term:  $\Phi(z, \bar{z}) = \lambda_\star$ , where  $\lambda_\star$  is one of the various extrema of the function  $V(x)$ , i.e., a real root of the algebraic equation,  $b_2x + b_3x^2 + b_4x^3 + \dots = 0$ . On the contrary, for nonzero  $\theta$ , there do exist nontrivial solutions whose energy densities are localized in some regions. In fact, associated with any projection operator  $\hat{e}$  or its symbol  $e(z, \bar{z})$ , which satisfies  $e \star e = e$ ,

$$\Phi = \lambda_\star e(z, \bar{z}), \quad (4.4)$$

is a solution. This is a straightforward application of the argument given in [3] to the fuzzy disc case.

The point here is that we can choose (sum of) the angular projection operators  $\hat{\pi}_k$ 's. Namely,

$$\Phi = \lambda_\star \pi_k(r, \varphi) = \frac{\lambda_\star}{N} \sum_{m,n=0}^{N-1} e^{-\frac{r^2}{2\theta}} \frac{r^{m+n}}{\sqrt{m!n!(2\theta)^{m+n}}} e^{i(m-n)(\varphi_k - \varphi)}, \quad (4.5)$$

solves (4.3) for  $k = 0, 1, \dots, N-1$ . We call it as an angular soliton solution. As we have seen, it shares the unit fun-shaped area in the disc. By using the correspondence

$$\int_D d^2z \quad \leftrightarrow \quad 2\pi\theta \text{Tr}_N, \quad (4.6)$$

and using that  $\hat{\pi}_k$  is rank 1, it is shown that this solution carries the energy

$$E = \int d^2z V_\star(\lambda_\star) \pi_k(r, \varphi) = 2\pi\theta V_\star(\lambda_\star). \quad (4.7)$$

---

<sup>4</sup> In [3], the authors obtained this energy functional by taking a limit of large noncommutativity;  $\theta \rightarrow \infty$  and rewriting it in the rescaled coordinates. The kinetic term, which is usually contained in the action, becomes negligible compared with the potential term by this operation.

On the Moyal plane, the scalar field theory can be regarded as an effective theory for the tachyon field on a non-BPS D2-brane, and the solution  $\Phi = \lambda_*(1 - p_n)$  based on the projection operator  $\hat{p}_n$  can be identified as a single D0-brane [4, 5], because of the rank of  $\hat{p}_n$  is 1. In this respect, our angular soliton  $\Phi = \lambda_*(1 - \pi_k)$  has the same energy as a D0-brane, but its shape is completely different. Concerning this point, the angular noncommutative solitons might be related to the D0-brane with orbital angular momentum like the optical vortex [27, 28, 29]. This issue will be reported in our forthcoming paper [30].

## 4.2 Angular Noncommutative Solitons in Gravity

As the second application, we would like to consider the gravitational system we referred in [2]. We exploit the first order formulation of a three-dimensional theory of gravity on a noncommutative  $\mathbb{R}^3$  which has a cosmological constant term only,

$$S = -\frac{\Lambda}{\kappa^2} \int dt d^2 z E^*, \quad (4.8)$$

where  $\Lambda$  is a cosmological constant. Here  $E^*$  is the  $\star$ -determinant defined by

$$E^* = \det_\star E = \frac{1}{3!} \epsilon^{\mu\nu\rho} \epsilon_{abc} E_\mu^a \star E_\nu^b \star E_\rho^c, \quad (4.9)$$

where  $E_\mu^a(z, \bar{z})$  is a vielbein. We denote spacetime indices by  $\mu, \nu, \rho$  and tangent space indices by  $a, b, c$ . All indices run from 0 to 2. The metric is also defined through the star product in a similar way [31, 32]:

$$G_{\mu\nu} = \frac{1}{2} \left( E_\mu^a \star E_\nu^b + E_\nu^b \star E_\mu^a \right) \eta_{ab}, \quad (4.10)$$

where  $\eta_{ab}$  is an  $SO(1, 2)$  invariant metric of the local Lorentz frame. We do not assume that  $E_\mu^a$  or  $G_{\mu\nu}$  are invertible as  $3 \times 3$  matrices, that is, we allow degenerate metrics. From this action, we obtain nine equations of motion for  $\nabla^\mu$  and  $\nabla^a$  [2],

$$\epsilon^{\mu\nu\rho} \epsilon_{abc} \{E_\nu^b, E_\rho^c\}_\star = 0, \quad (4.11)$$

where we used the star-anticommutator defined by  $\{f, g\}_\star \equiv \frac{1}{2}(f \star g + g \star f)$ .

In [2], we gave various kinds of non-trivial solutions for (4.11), but all of them are based on the radial projection operators  $\hat{p}_n$ . By replacing  $\hat{p}_n$  with the angular projection operators  $\hat{\pi}_k$ , various new kinds of solutions can be obtained. We here give an example of them.

The simplest solution is a diagonal vielbein where three components are proportional to

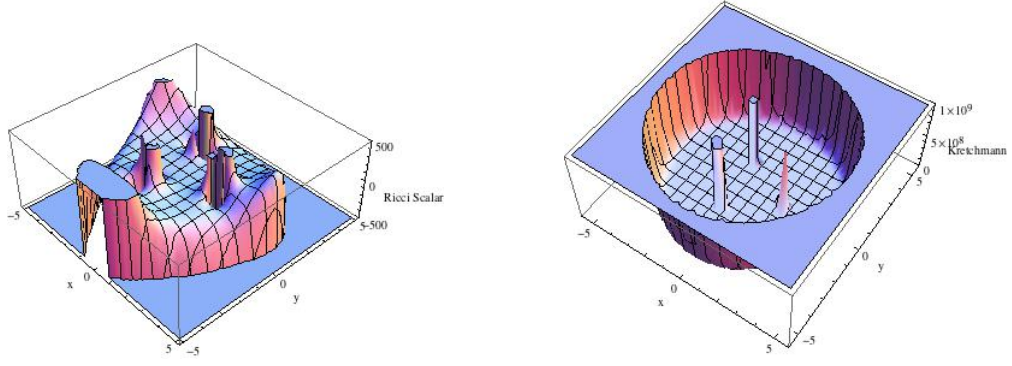

Figure 12: The ordinary (commutative) Ricci scalar and the Kretschmann invariant for the line element (4.13). We set  $\alpha_0 = \alpha_1 = \alpha_2 = 1$  and  $\theta = 1$ .

angular projection operators such as

$$E_\mu^a = \begin{pmatrix} E_0^0 & 0 & 0 \\ 0 & E_1^1 & 0 \\ 0 & 0 & E_2^2 \end{pmatrix} = \begin{pmatrix} \alpha_0 \pi_0^{(N)} & 0 & 0 \\ 0 & \alpha_1 \pi_1^{(N)} & 0 \\ 0 & 0 & \alpha_2 \pi_2^{(N)} \end{pmatrix}, \quad (4.12)$$

where  $\alpha_0, \alpha_1$  and  $\alpha_2$  are arbitrary constants. Any three different choices among  $\pi_0^{(N)}, \pi_1^{(N)}, \dots, \pi_{N-1}^{(N)}$ , or three linear combinations of them can be solutions as long as they are orthogonal among them.

For the example above with  $N = 3$ , the metric (4.10) is given by

$$ds^2 = -\alpha_0^2 \pi_0^{(3)} dt^2 + \alpha_1^2 \pi_1^{(3)} dx^2 + \alpha_2^2 \pi_2^{(3)} dy^2, \quad (4.13)$$

where

$$\begin{aligned} \pi_k^{(3)}(r, \varphi) &= \frac{1}{3} e^{-r^2/\theta} \left[ 1 + \frac{2r}{\theta^{1/2}} \cos(\varphi - \varphi_k^{(3)}) \right. \\ &\quad \left. + \frac{r^2}{\theta} \left\{ 1 + \sqrt{2} \cos[2(\varphi - \varphi_k^{(3)})] \right\} + \frac{\sqrt{2} r^3}{\theta^{3/2}} \cos(\varphi - \varphi_k^{(3)}) + \frac{r^4}{\theta^2} \right]. \end{aligned} \quad (4.14)$$

Note that  $\pi_i^{(N)}$  is idempotent with respect to the Wick-Voros product. Considering this metric as an ordinary (that is, commutative) one, one can formally calculate several quantities such as the Riemann tensor. Figure 12 shows the ordinary Ricci scalar and the Kretschmann invariant for the metric (4.13), respectively. Both quantities are almost flat in the disc region but diverge outside the disc, which suggest that the spacetime corresponding to this solution is the fuzzy disc with radius  $R = \sqrt{6\theta}$ . This matches to the fact that  $R = \sqrt{2N\theta}$  and  $N = 3$  here. The two invariants also diverge around three points, where  $\pi_0^{(3)}, \pi_1^{(3)}$  and  $\pi_2^{(3)}$  have their peaks. These divergences would be artifacts due to the bad choices of the observables, and would be resolved if we define more admissible quantities. We emphasize that the fuzzy disc is an emergent space in this model, that is, its size  $N$  is not a parameter of the theory but a parameter of a solution.

## 5 Conclusion and Discussion

In this paper, we investigated the fuzzy disc by introducing the concept of angles. By defining the angle states  $|\varphi_m\rangle$  and the angle operator  $\hat{\varphi}$ , which are known as the phase states and the phase operator in quantum optics, we reformulate the  $N \times N$  matrix algebra for the fuzzy disc as the commutation relations among the operators  $\hat{\varphi}$ ,  $\hat{N}$ ,  $\hat{U}$  and  $\hat{V}$ . The angle states were also used to divide the fuzzy disc into fan-shaped regions. This type of division of the fuzzy disc has not been considered so far.

As an application, we found noncommutative angular solitons for a scalar field theory on the fuzzy disc, where fan-shaped regions might be related to D0-branes. Though it needs further study to support on this point, it might be possible to identify the angular noncommutative solitons with the vortex motion of D0-branes like the optical vortex in laser physics. The extensions of angular solitons to exact angular solitons and multi-angular solitons would be possible.

As a generalization, we also described briefly the fuzzy annulus and the angle states for it. If there are orthonormal  $N$  states, one can construct the angle states. Because of this, there is a lot of possibility of applications of these kinds of constructions for fuzzy objects. For example, if we choose two sets of states,  $\{|0\rangle, |1\rangle, \dots, |N-1\rangle\}$  and  $|M\rangle, |M+1\rangle, \dots, |M+N-1\rangle$  with  $N < M$ , we obtain a disjoint union of the fuzzy disc and a fuzzy annulus. One can also constitute two sets of the  $N$  angle states. Because two sets are orthogonal with each other, they form  $2N$  orthogonal angle states.

In particular, the application of the fuzzy disc or other fuzzy objects to investigate black hole microstates would be interesting, because the feature of holography is encoded in this setting. To this end, we would have to understand the edge states in this setup further.

As a concluding remark, we refer a possibility to relate noncommutative theories to experiments. The solutions of a scalar field theory in a noncommutative space, e.g., the GMS solitons, are written in terms of the function known as the Laguerre-Gaussian function in quantum optics and laser physics [27, 28, 29]. The Laguerre-Gaussian function is the solution of the Helmholtz equation with cylindrical symmetry in the three-dimensional space. One can actually make the laser beam expressed by this kind of function with the Gaussian profile radially to the direction along a beam goes. The profile along this direction is arbitrary and the point where the spread of the beam is narrowest is called “the waist” from its shape. The size of this waist can be identified to the magnitude of the noncommutativity parameter  $\theta$  when we assign the noncommutative solitons to the cross section of the Laguerre-Gaussian beam. The intensity of the beam seems to

correspond to the height of the noncommutative solitons at the level of equations. Although the Laguarre-Gaussian beam is not a “real” noncommutative soliton but an analogue to it, we might be able to say something about quantum gravity by certain experiments with laser, because a noncommutative theory could be an effective theory of quantum gravity. If this idea is somehow justified, it would be a very exciting issue.

## Acknowledgements

The authors would like to thank Y. Kurita, F. Lizzi and H. Saida for helpful comments and discussions. This work of S. K. is supported by JSPS Grand-in-Aid for Young Scientists (B) 21740198.

## References

- [1] F. Lizzi, P. Vitale and A. Zampini, *The fuzzy disc*, *JHEP* **08** (2003) 057 [[hep-th/0306247](#)].
- [2] T. Asakawa and S. Kobayashi, *Noncommutative Solitons of Gravity*, *Class. Quant. Grav.* **27** (2010) 105014 [[0911.2136](#)].
- [3] R. Gopakumar, S. Minwalla and A. Strominger, *Noncommutative solitons*, *JHEP* **05** (2000) 020 [[hep-th/0003160](#)].
- [4] K. Dasgupta, S. Mukhi and G. Rajesh, *Noncommutative tachyons*, *JHEP* **0006** (2000) 022 [[hep-th/0005006](#)].
- [5] J. A. Harvey, P. Kraus, F. Larsen and E. J. Martinec, *D-branes and strings as noncommutative solitons*, *JHEP* **0007** (2000) 042 [[hep-th/0005031](#)].
- [6] J. A. Harvey, *Komaba lectures on noncommutative solitons and D-branes*, [hep-th/0102076](#).
- [7] F. Lizzi, P. Vitale and A. Zampini, *From the fuzzy disc to edge currents in Chern-Simons theory*, *Mod. Phys. Lett.* **A18** (2003) 2381–2388 [[hep-th/0309128](#)].
- [8] F. Lizzi, P. Vitale and A. Zampini, *The fuzzy disc: A review*, *J. Phys. Conf. Ser.* **53** (2006) 830–842.

- [9] D. T. Pegg and S. M. Barnett, *Unitary Phase Operator in Quantum Mechanics*, *Europhys. Lett.* **6** (1988) 483.
- [10] S. M. Barnett and D. T. Pegg, *On the Hermitian Optical Phase Operator*, *J. Mod. Opt.* **36** (1989) 7.
- [11] D. T. Pegg and S. M. Barnett, *Phase properties of the quantized single-mode electromagnetic field*, *Phys. Rev.* **A39** (1989) 1665–1675.
- [12] J. A. Vaccaro and D. T. Pegg, *Wigner function for number and phase*, *Phys. Rev.* **A41** (1990) 5156–5163.
- [13] S. Galluccio, F. Lizzi and P. Vitale, *Twisted Noncommutative Field Theory with the Wick-Voros and Moyal Products*, *Phys.Rev.* **D78** (2008) 085007 [0810.2095].
- [14] Y. Hatsugai, *Chern Number and Edge States in the Integer Quantum Hall effect*, *Phys. Rev. Lett.* **71** (1993) 3697.
- [15] Y. Hatsugai, *Edge states in the Integer quantum Hall effect and the Riemann surface of the Bloch function*, *Phys. Rev. B* **48** (1993) 11851.
- [16] M. Matsuoka, *Phase Operator in Quantum Mechanics*, *Butsuri (in Japanese)* **49** (1994) 643.
- [17] P. Dirac, *The Quantum Theory of the Emission and Absorption of Radiation*, *Proc. R. Soc. Lond.* **A114** (1927) 243.
- [18] L. Susskind and J. Glogower, *Quantum mechanical phase and time operator*, *Physics* **1** (1964) 49–61.
- [19] R. Loudon, *The Quantum Theory of Light*. Oxford Uni. Press, 1973.
- [20] S. Abe, *The Pegg-Barnett phase-operator formalism as a q-deformed theory: limiting procedure and weak deformation*, *Phys.Lett* **A200** (1995) 239–242.
- [21] N. Atakishiyev, M. Kibler and K. Wolf, *SU(2) and SU(1,1) Approaches to Phase Operators and Temporally Stable Phase States: Applications to Mutually Unbiased Bases and Discrete Fourier Transforms*, *Symmetry* **2** (2010) 1461–1484.
- [22] K. Fujikawa, L. Kwek and C. Oh, *Q deformed oscillator algebra and an index theorem for the photon phase operator*, *Mod.Phys.Lett.* **A10** (1995) 2543–2552 [hep-th/9504136].



- [23] K. Fujikawa, *Phase operator for the photon field and an index theorem*, *Phys.Rev.* **A52** (1995) 3299–3307 [[hep-th/9411066](#)].
- [24] A. Balachandran, K. S. Gupta and S. Kurkcuoglu, *Edge currents in noncommutative Chern-Simons theory from a new matrix model*, *JHEP* **0309** (2003) 007 [[hep-th/0306255](#)].
- [25] A. Pinzul and A. Stern, *Absence of the holographic principle in noncommutative Chern-Simons theory*, *JHEP* **0111** (2001) 023 [[hep-th/0107179](#)].
- [26] S. Digoal, T. Govindarajan, K. S. Gupta and X. Martin, *Phase structure of fuzzy black holes*, *JHEP* **1201** (2012) 027 [[1109.4014](#)].
- [27] L. Allen, M. Beijersbergen, R. Spreeuw and J. Woerdman, *Orbital angular momentum of light and the transformation of Laguerre-Gaussian laser modes*, *Phys.Rev.* **A45** (1992) 8185–8189.
- [28] A. M. Yao and M. J. Padgett, *Orbital Angular Momentum: Origins, behavior and applications*, *Adv. Opt. Photon.* **3** (2011) 161–204.
- [29] M. Uchida and A. Tonomura, *Generation of Electron Beams Carrying Orbital Angular Momentum*, *Nature* **464** (2010) 737–739.
- [30] S. Kobayashi and T. Asakawa , in preparation.
- [31] M. Banados, O. Chandia, N. E. Grandi, F. A. Schaposnik and G. A. Silva, *Three-dimensional noncommutative gravity*, *Phys. Rev.* **D64** (2001) 084012 [[hep-th/0104264](#)].
- [32] P. Aschieri, M. Dimitrijevic, F. Meyer and J. Wess, *Noncommutative geometry and gravity*, *Class. Quant. Grav.* **23** (2006) 1883–1912 [[hep-th/0510059](#)].