

NON-ERGODIC \mathbb{Z} -PERIODIC BILLIARDS AND INFINITE TRANSLATION SURFACES

KRZYSZTOF FRĄCZEK AND CORINNA ULCIGRAI

ABSTRACT. We give a criterion which allows to prove non-ergodicity for certain infinite periodic billiards and directional flows on \mathbb{Z} -periodic translation surfaces. Our criterion applies in particular to a billiard in an infinite band with periodically spaced vertical barriers and to the Ehrenfest wind-tree model, which is a planar billiard with a \mathbb{Z}^2 -periodic array of rectangular obstacles. We prove that, in these two examples, both for a full measure set of parameters of the billiard tables and for tables with rational parameters, for almost every direction the corresponding billiard flow is not ergodic and has uncountably many ergodic components. As another application, we show that for any recurrent \mathbb{Z} -cover of a square tiled surface of genus two the directional flow is not ergodic and has no invariant sets of finite measure for a full measure set of directions. In the language of essential values, we prove that the skew-products which arise as Poincaré maps of the above systems are associated to non-regular \mathbb{Z} -valued cocycles for interval exchange transformations.

1. INTRODUCTION AND MAIN RESULTS

The ergodic theory of directional flows on *compact* translation surfaces (definitions are recalled below) has been a rich and vibrant area of research in the last decades, in connection with the study of rational billiards, interval exchange transformations and Teichmüller geodesic flows (see for example the surveys [31, 41, 42, 46]). On the other hand, very little is known about the ergodic properties of directional flows on *non-compact* translation surfaces, for which the natural invariant measure is *infinite* (see [20]).

A natural motivation to study infinite translation surfaces, as in the case of compact ones, come from billiards. As linear flows on compact translation surfaces arise for example by *unfolding* billiard flows in rational polygons, examples of flows on *infinite* translation surfaces can be obtained by unfolding periodic rational billiards, for example in a band (see the billiard described below, Figure 1 and §1.1) or in the plane (as the Ehrenfest wind-tree model, see Figure 2 and §1.2). The infinite translation surfaces obtained in this way are rich in symmetry, and turns out to be \mathbb{Z}^d -covers (see below for a definition) of compact translation surfaces. Poincaré maps of directional flows on compact surfaces are piecewise isometries known as interval exchange transformations; Poincaré maps of directional flows \mathbb{Z}^d covers are \mathbb{Z}^d -extensions of interval exchange transformations (see §2 for the definitions of interval exchange transformations and extensions).

The ergodic properties of directional flows on \mathbb{Z}^d -covers and more generally of \mathbb{Z}^d -extensions of interval exchange transformations have been recently a very active area of research (see for example [8, 9, 20, 22, 23, 24, 25, 26]). Recall that a measurable flow $(\varphi_t)_{t \in \mathbb{R}}$ on the measurable space (X, \mathcal{B}) preserves the measure μ (where μ is σ -finite) if $\mu(\varphi_t A) = \mu(A)$ for all $t \in \mathbb{R}$, $A \in \mathcal{B}$. The invariant measure μ is *ergodic* and we say that $(\varphi_t)_{t \in \mathbb{R}}$ is ergodic with respect to μ if for any measurable set A which is almost invariant, i.e. such that $\mu(\varphi_t A \Delta A) = 0$

for all $t \in \mathbb{R}$, either $\mu(A) = 0$ or $\mu(A^c) = 0$, where A^c denotes the complement. In the classical set-up, a celebrated result by Kerchhoff-Masur-Smillie [29] states that for *every* compact connected translation surface for a.e. direction $\theta \in S^1$ the directional flow in direction θ is *ergodic* with respect to the Lebesgue measure and moreover is *uniquely ergodic*, i.e. the Lebesgue measure is the unique ergodic invariant measure up to scaling. Some recent results concerning ergodicity are in the direction of proving that also for some \mathbb{Z} -covers ergodicity holds for a full measure set of directions, for example in special cases as \mathbb{Z} -covers of surfaces of genus 1 (see [23]) or of \mathbb{Z} -covers which have the lattice property (see Theorem 1.6 quoted below, from [26]). Examples of ergodic directions in some infinite translation surfaces were also constructed by Hooper [22]).

In contrast, in this paper we give a criterion (Theorem 6.1) which allows to show non-ergodicity for some infinite billiards and \mathbb{Z} -covers of translation surfaces. Our criterion allows us in particular to prove that some well-studied infinite periodic billiards, for example the billiard in a band with barriers and the periodic Erhenfest-wind tree model are not ergodic both for a full measure set of parameters and for certain specific values of parameters (Theorems 1.1 and 1.2). Moreover, we show that such flows admits uncountably many ergodic components (defined in §3.2). The criterion for non-ergodicity (Theorem 6.1) requires several preliminary definitions and it is therefore stated in §6. Here below (§§1.1 and 1.2) we formulate the two results just mentioned about infinite billiards (Theorems 1.1 and 1.2), that are based on this criterion. Another application of the non-ergodicity criterion is given by Theorem 1.4, which gives a class of \mathbb{Z} -covers of translation surfaces for which the set of ergodic directions θ for the directional flow $(\varphi_t^\theta)_{t \in \mathbb{R}}$ has *measure zero* (see §1.4, where we state Theorem 1.4 after the preliminary definitions in §1.3 and comment on the relations with other recent results).

Let us remark that our Theorems can be rephrased in the language of skew-products and essential values (as explained in §2 and §3 below). While skew-products over rotations are well studied, very few results were previously known for skew-products over IETs. The first return (Poincaré) maps of the billiard flows or of the directional flows considered provide examples of skew-products associated to *non-regular* cocycles for interval exchange transformations (see §3 for the definition of non-regularity).

1.1. A billiard in an infinite band. Let us consider the infinite band $\mathbb{R} \times [0, 1]$ with periodically placed linear barriers (also called *slits*) handling from the lower side of the band perpendicularly (see Figure 1). We will denote by $T(l) = (\mathbb{R} \times [0, 1]) \setminus (\mathbb{Z} \times [0, l])$ the billiard table in which the length of the slit is given by the parameter $0 < l < 1$ as shown in Figure 1. Let us recall that a billiard trajectory is the trajectory of a point-mass which moves freely inside $T(l)$ on segments of straight lines and undergoes elastic collisions (angle of incidence equals to the angle of reflection) when it hits the boundary of $T(l)$. An example of a billiard trajectory is drawn in Figure 1. The billiard flow $(b_t)_{t \in \mathbb{R}}$ is defined on a full measure set of points

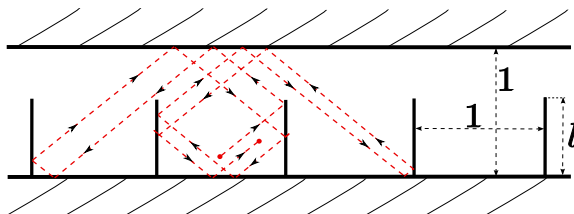

FIGURE 1. Billiard flow on $T(l)$.

in the phase space $T^1(l)$, that consists of the subset of points $(x, \theta) \in T(l) \times S^1$ such that if x belongs to the boundary of $T(l)$ then θ is an inward direction. For $t \in \mathbb{R}$ and (x, θ) in the domain of $(b_t)_{t \in \mathbb{R}}$, b_t maps (x, θ) to $b_t(x, \theta) = (x', \theta')$, where x' is the point reached after time t by flowing at unit speed along the billiard trajectory starting at x in direction θ and θ' is the tangent direction to the trajectory at x' .

The infinite billiard $(b_t)_{t \in \mathbb{R}}$ is an extension of a finite billiard (in a rectangle with a barrier), whose fine dynamical properties were studied in many papers (see [38, 6, 7, 13]). Let us also remark that a similar billiard in a semi-infinite band is known as a *retroreflector* and was studied in [3].

Since the directions of any billiard trajectory in $T(l)$ are at most four, the set $T(l) \times \Gamma\theta$, where $\Gamma\theta := \{\theta, -\theta, \pi - \theta, \pi + \theta\}$, is an invariant subset in the phase space $T^1(l)$ for the billiard flow on $T(l)$. The flow $(b_t^\theta)_{t \in \mathbb{R}}$ will denote the restriction of $(b_t)_{t \in \mathbb{R}}$ to this invariant set. Remark that the directional billiard flow $(b_t^\theta)_{t \in \mathbb{R}}$ preserves the product of the Lebesgue measure on $T(l)$ and the counting measure on the orbit $\Gamma\theta$. We say that $(b_t^\theta)_{t \in \mathbb{R}}$ on $T(l)$ is *ergodic* if it is ergodic with respect to this natural invariant measure.

Theorem 1.1. *Consider the billiard flow $(b_t)_{t \in \mathbb{R}}$ on the infinite strip $T(l)$. There exists a set $\Lambda \subset [0, 1]$ of full Lebesgue measure such that, if either:*

- (1) l is a rational number, or
- (2) $l \in \Lambda$,

then for almost every $\theta \in S^1$ the directional billiard flow $(b_t^\theta)_{t \in \mathbb{R}}$ on $T(l)$ is recurrent and not ergodic. Moreover, $(b_t^\theta)_{t \in \mathbb{R}}$ has uncountably many ergodic components.

Let us remark that, even though we prove that the result holds for a full measure set of parameters Λ , the assumption (1) is more precise since it gives *concrete* values of the parameters for which the conclusion holds. It is natural to ask if there exists exceptional directions $\theta \in S^1$ and $l \in (0, 1)$ for which the flow $(b_t^\theta)_{t \in \mathbb{R}}$ is ergodic. In [18] it is shown that for all $l = p/q \in \mathbb{Q} \cap (0, 1)$ there exists a positive Hausdorff dimension set of exceptional directions $\theta \in S^1$ for which $(b_t^\theta)_{t \in \mathbb{R}}$ on $T(p/q)$ is ergodic.

1.2. The Ehrenfest wind-tree model. The Ehrenfest wind-tree billiard is a model of a gas particle introduced in 1912 by P. and T. Ehrenfest. The periodic version, which was first studied by Hardy and Weber in [21], consist of a \mathbb{Z}^2 -periodic planar array of rectangular scatterers, whose sides are given by two parameters $0 < a, b < 1$ (see Figure 2). The billiard flow in the complement $E_2(a, b)$ of the interior of the rectangles is the Ehrenfest wind-tree billiard, that we will denote by $(e_t)_{t \in \mathbb{R}}$. An example of a billiard trajectory is also shown in Figure 2. Many results on the dynamics of the periodic wind-tree models, in particular on recurrence and diffusion times, were proved recently, see [9, 25, 37, 11, 12]. One can also consider a one-dimensional version of the periodic Ehrenfest wind-tree model, whose configuration space $E_1(a, b)$ is an infinite tube $\mathbb{R} \times (\mathbb{R}/\mathbb{Z})$ with \mathbb{Z} -periodic rectangular scatterers (see Figure 3) of horizontal and vertical sides of lengths a and b respectively. We will also denote by $(e_t)_{t \in \mathbb{R}}$ the billiard flow in $E_1(a, b)$. As for the billiard in a strip in §1.1, any trajectory of (x, θ) for $(e_t)_{t \in \mathbb{R}}$ in $E_1(a, b)$ or in $E_2(a, b)$ travels in at most four directions, belonging to the set $\Gamma\theta := \{\pm\theta, \theta \pm \pi\}$. The restriction of $(e_t)_{t \in \mathbb{R}}$ to the invariant set $E_i(a, b) \times \Gamma\theta$ for $i = 1, 2$ will be denoted by $(e_t^\theta)_{t \in \mathbb{R}}$. The directional billiard flow $(e_t^\theta)_{t \in \mathbb{R}}$ preserves the product measure μ of the Lebesgue measure on $E_1(a, b)$ ($E_2(a, b)$) and the counting measure on $\Gamma\theta$ and the ergodicity of $(e_t^\theta)_{t \in \mathbb{R}}$ refers to ergodicity with respect to this measure μ .

Theorem 1.2. *Consider the billiard flow $(e_t)_{t \in \mathbb{R}}$ in the \mathbb{Z} -periodic Ehrenfest wind-tree model $E_1(a, b)$. There exists a set $\mathcal{P} \subset [0, 1]^2$ of full Lebesgue measure such that, if either:*

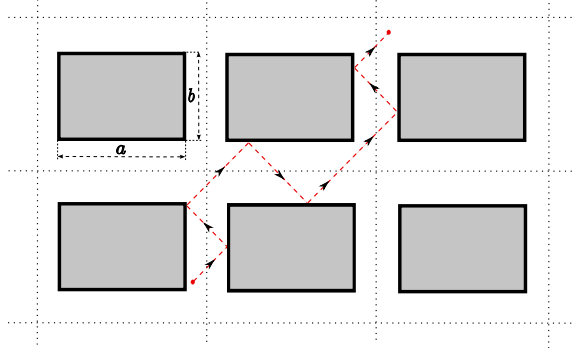
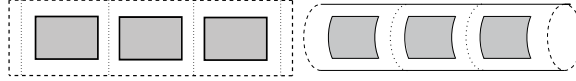
FIGURE 2. Ehrenfest wind-tree billiard on $E_2(a, b)$.FIGURE 3. Ehrenfest wind-tree billiard on $E_1(a, b)$.

- (1) $a, b \in (0, 1)$ are rational numbers, or
- (2) $a, b \in (0, 1)$ can be written as $1/(1-a) = x+y\sqrt{D}$, $1/(1-b) = (1-x)+y\sqrt{D}$ with $x, y \in \mathbb{Q}$ and D a positive square-free integer, or
- (3) $(a, b) \in \mathcal{P}$,

then for almost every $\theta \in S^1$ the directional billiard flow $(e_t^\theta)_{t \in \mathbb{R}}$ on $E_1(a, b)$ is recurrent and not ergodic. Moreover, $(e_t^\theta)_{t \in \mathbb{R}}$ has uncountably many ergodic components.

As in Theorem 1.1, the result holds by (3) for the full measure set of parameters \mathcal{P} , but only the assumptions (1) and (2) give *concrete* values of the parameters (a, b) for which the conclusion holds.

As a corollary, since $(e_t^\theta)_{t \in \mathbb{R}}$ in $E_2(a, b)$ is a cover of $(e_t^\theta)_{t \in \mathbb{R}}$ on $E_1(a, b)$, we have the following conclusion about the original Ehrenfest periodic model.

Corollary 1.3. *If (a, b) satisfy either (1), (2) or (3) in Theorem 1.2, then for almost every $\theta \in S^1$ the planar periodic Ehrenfest wind tree model $(e_t^\theta)_{t \in \mathbb{R}}$ on $E_2(a, b)$ is not ergodic and moreover, there are uncountably many ergodic components.*

1.3. Directional flows on translation surfaces and \mathbb{Z} -covers. We now recall some basic definitions to then state (in §1.4) another application of our non-ergodicity criterion (Theorem 6.1) for a class of \mathbb{Z} -covers of translation surfaces. Let M be an oriented surface (not necessarily compact). A translation surface (M, ω) is a complex structure on M together with a nonzero *Abelian differential* ω , that is a non-zero holomorphic 1-form. Since given an Abelian differential there exists a uniquely complex structure which is compatible with it, the translation structure on M is uniquely defined by ω . Let $\Sigma = \Sigma_\omega \subset M$ be the set of zeros of ω . For every $\theta \in S^1 = \mathbb{R}/2\pi\mathbb{Z}$ denote by $X_\theta = X_\theta^\omega$ the directional vector field in direction θ on $M \setminus \Sigma$, defined by $i_{X_\theta}\omega = e^{i\theta}$. Then the corresponding directional flow $(\varphi_t^\theta)_{t \in \mathbb{R}} = (\varphi_t^{\omega, \theta})_{t \in \mathbb{R}}$ (also known as *translation flow*) on $M \setminus \Sigma$ preserves the volume form $\nu_\omega = \frac{i}{2}\omega \wedge \bar{\omega} = \Re(\omega) \wedge \Im(\omega)$. We will use the notation $(\varphi_t^v)_{t \in \mathbb{R}}$ and X_h for the *vertical flow and vector field* (corresponding to $\theta = \frac{\pi}{2}$) and $(\varphi_t^h)_{t \in \mathbb{R}}$ and X_h for the *horizontal flow and vector field* respectively ($\theta = 0$). We will always consider translation surfaces of *area one*, that is renormalized so that $A(\omega) := \nu_\omega(M)$ is equal to one. We will denote by M_θ the set of regular points for the directional

flow $(\varphi_t^\theta)_{t \in \mathbb{R}}$, i.e. the set of point for which the orbit of the flow may be defined for all times $t \in \mathbb{R}$. Then M_θ is a Borel subset of M with $\nu_\omega(M \setminus M_\theta) = 0$ and $(\varphi_t^\theta)_{t \in \mathbb{R}}$ restricted to M_θ is a well defined Borel flow.

Let (M, ω) be a compact connected translation surface. Recall that a \mathbb{Z} -cover of M is a manifold \widetilde{M} with a free totally discontinuous action of the group \mathbb{Z} such that the quotient manifold \widetilde{M}/\mathbb{Z} is homeomorphic to M . The map $p : \widetilde{M} \rightarrow M$ obtained by composition of the projection $\widetilde{M} \rightarrow \widetilde{M}/\mathbb{Z}$ and the homeomorphism $\widetilde{M}/\mathbb{Z} \rightarrow M$ is called a *covering map*. Denote by $\widetilde{\omega}$ the pullback of the form ω by the map p . Then $(\widetilde{M}, \widetilde{\omega})$ is a translation surface as well. As we recall at the beginning of Section 2, \mathbb{Z} -covers of M up to isomorphism are in one-to-one correspondence with homology classes in $H_1(M, \mathbb{Z})$. For every $\gamma \in H_1(M, \mathbb{Z})$ we will denote by $(\widetilde{M}_\gamma, \widetilde{\omega}_\gamma)$ the translation surface associated to the \mathbb{Z} -cover given by γ .

For any \mathbb{Z} -cover $(\widetilde{M}, \widetilde{\omega})$ of the translation surface (M, ω) and $\theta \in S^1$ denote by $(\varphi_t^\theta)_{t \in \mathbb{R}}$ and $(\widetilde{\varphi}_t^\theta)_{t \in \mathbb{R}}$ the volume-preserving directional flows on (M, ν_ω) and $(\widetilde{M}, \nu_{\widetilde{\omega}})$ respectively. Recall that a measure-preserving flow $(\varphi_t)_{t \in \mathbb{R}}$ on (X, \mathcal{B}, μ) (μ is σ -finite) is *recurrent* if for any $A \in \mathcal{B}$ with $\mu(A) > 0$, for a.e. $x \in A$ there is $t_n \rightarrow \infty$ such that $\varphi_{t_n} x \in A$.

Denote by $\text{hol} : H_1(M, \mathbb{Z}) \rightarrow \mathbb{C}$ the *holonomy map*, i.e. $\text{hol}(\gamma) = \int_\gamma \omega$ for every $\gamma \in H_1(M, \mathbb{Z})$. As recently shown by Hooper and Weiss (see Proposition 15 in [24]) a curve γ on (M, ω) has $\text{hol}(\gamma) = 0$ if and only if for every $\theta \in S^1$ such that $(\varphi_t^\theta)_{t \in \mathbb{R}}$ is ergodic, the flow $(\widetilde{\varphi}_t^\theta)_{t \in \mathbb{R}}$ on the \mathbb{Z} -cover $(\widetilde{M}_\gamma, \widetilde{\omega}_\gamma)$ is *recurrent*. Thus, following Hooper and Weiss, we adopt the following definition:

Definition 1 (see [24]). The \mathbb{Z} -cover $(\widetilde{M}_\gamma, \widetilde{\omega}_\gamma)$ of the translation surface (M, ω) given by $\gamma \in H_1(M, \mathbb{Z})$ is called *recurrent* if $\text{hol}(\gamma) = 0$.

Recall that a translation surface (M, ω) is *square-tiled* if there exists a ramified cover $p : M \rightarrow \mathbb{R}^2/\mathbb{Z}^2$ unramified outside $0 \in \mathbb{R}^2/\mathbb{Z}^2$ such that $\omega = p^*(dz)$. Square tiled surfaces are also known as *origamis*. Examples of square tiled surface (M, ω) can be realized by gluing finitely (or infinitely) many squares of equal sides in \mathbb{R}^2 by identifying each left vertical side of a square with a right vertical side of some square and each top horizontal side with a bottom horizontal side via translations.

1.4. \mathbb{Z} -covers of genus two square tiled surfaces and staircases. Another application of the non-ergodicity criterion (Theorem 6.1) is the following.

Theorem 1.4. *If (M, ω) is square-tiled translation surface of genus 2, for any recurrent \mathbb{Z} -cover $(\widetilde{M}_\gamma, \widetilde{\omega}_\gamma)$ given by a non trivial $\gamma \in H_1(M, \mathbb{Z})$ and for a.e. $\theta \in S^1$ the directional flow $(\widetilde{\varphi}_t^\theta)_{t \in \mathbb{R}}$ is not ergodic. Moreover, it has no invariant sets of positive measure and has uncountably many ergodic components.*

Let us give an example to which Theorem 1.4 applies. Consider the infinite staircase in Figure 4(a) and let us denote by $Z_{(3,0)}^\infty$ the surface obtained by identifying the opposite parallel sides belonging to the boundary by translations (the notation $Z_{(3,0)}^\infty$ refers to [27]). The surface $Z_{(3,0)}^\infty$ inherits from \mathbb{R}^2 a translation surface structure and thus one can consider the directional flows $(\varphi_t^\theta)_{t \in \mathbb{R}}$ in direction θ on $Z_{(3,0)}^\infty$. One can see that this infinite translation surface is a \mathbb{Z} -cover of the genus two square-tiled surface $Z_{(3,0)}$ shown in Figure 4(b). Thus, as a consequence of Theorem 1.4 we get:

Corollary 1.5. *The set of directions $\theta \in S^1$ such that the directional flow $(\varphi_t^\theta)_{t \in \mathbb{R}}$ on the infinite staircase $Z_{(3,0)}^\infty$ is ergodic has Lebesgue measure zero. Moreover, for almost every $\theta \in S^1$, $(\varphi_t^\theta)_{t \in \mathbb{R}}$ has no invariant sets of finite measure.*

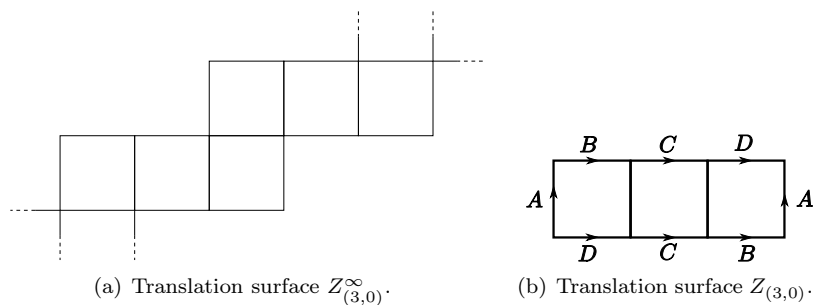

FIGURE 4. The infinite staircase translation surface $Z_{(3,0)}^\infty$.

More generally, a countable family of staircases translation surfaces $Z_{(a,b)}^\infty$ depending on the natural parameters $a \geq 2, b \geq 0$ was defined and studied by Hubert and Schmithüsen in [27]. For $a > 2$, these translation surfaces are \mathbb{Z} -covers of genus 2 square-tiled surfaces. Thus, Corollary 1.5 holds for any $Z_{(a,b)}^\infty$ with $a > 2, b \geq 0$.

On the other hand, we remark that, if one starts from the staircase in Figure 5 and obtains the translation surface known as $Z_{(2,0)}^\infty$ by identifying opposite parallel sides belonging to the boundary, the set of directions θ such that the directional flow $(\varphi_t^\theta)_{t \in \mathbb{R}}$ on the infinite staircase $Z_{(2,0)}^\infty$ is ergodic has *full* Lebesgue measure (see [26]). This difference is related to the fact that $Z_{(2,0)}^\infty$ is *not* a \mathbb{Z} -cover of a genus 2 surface and the study of the directional flows on $Z_{(2,0)}^\infty$ can be reduced to well-know results of ergodicity of skew products over rotations (see [26] for references).

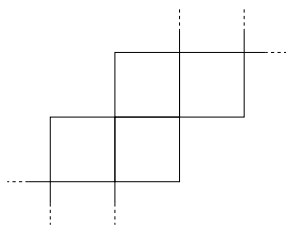

FIGURE 5. The infinite staircases translation surface $Z_{(2,0)}^\infty$.

Let us comment on the relation between Corollary 1.5 of our theorem and another recent result by Hubert and Weiss. In section §5 we recall the definition of the Veech group $SL(M, \omega) < SL(2, \mathbb{R})$ of a translation surface. We say that a translation surface (M, ω) (compact or not) is a *lattice surface* if the Veech group is a lattice in $SL(2, \mathbb{R})$. We say that a (infinite) translation surface $(\widetilde{M}, \widetilde{\omega})$ has an *infinite strip* if there exists a subset of \widetilde{M} isometric to the strip $\mathbb{R} \times (-a, a)$ for some $a > 0$ (with respect to the flat metric induced by $\widetilde{\omega}$ on \widetilde{M}).

Theorem 1.6 (Hubert-Weiss, [26]). *Let $(\widetilde{M}, \widetilde{\omega})$ be a \mathbb{Z} -cover that is a lattice surface and has an infinite strip. Then the directional flow $(\varphi_t^\theta)_{t \in \mathbb{R}}$ on $(\widetilde{M}, \widetilde{\omega})$ is ergodic for a.e. $\theta \in S^1$.*

One can easily check that $Z_{(3,0)}^\infty$ has an *infinite strip* (for example in the direction $\theta = \frac{\pi}{4}$). On the other hand, as it was proved in [27], the Veech group $SL(Z_{(3,0)}^\infty)$ is of the first kind, is infinitely generated and is *not* a lattice. Thus, our result shows that the assumption that $SL(\widetilde{M}, \widetilde{\omega})$ (and not only $SL(M, \omega)$) is a lattice is essential for the conclusion of Theorem 1.6 to hold.

1.5. Outline and structure of the paper. The Sections from 2 to 5 contain background material and preliminary results. In §2 we recall the construction of \mathbb{Z} -covers associated to a homology class and the definitions of interval exchange transformations (IETs) and \mathbb{Z} -extensions. We also explain how the study of directional flows on \mathbb{Z} covers can be reduced to the study of \mathbb{Z} -extensions of IETs. We then present some definitions and results used in the proofs about the theory of essential values (Section 3), the Kontsevich-Zorich cocycle (Section 4) and lattice surfaces (Section 5).

The heart of the paper is contained in Section 6, where the criterion for non-ergodicity (Theorem 6.1) is both stated and proved. In Section 7 we state and prove Theorem 7.1 (on the absence of invariant sets of finite measure), which provides another crucial ingredient to prove the presence of uncountably many ergodic components in the various applications.

The proofs of the results stated in the introduction is finally given in Section 8 and follows from Theorems 6.1 and 7.1 essentially from Fubini-type arguments. The first Fubini argument presented applies to Veech surfaces and appears in §8.1, where we prove Theorem 1.4 and Corollary 1.5. In §8.2 and §8.3 we prove respectively Theorem 1.1 on the billiard in a strip and Theorem 1.2 and Corollary 1.3 on the Ehrenfest wind-tree models.

In the Appendix we include the proof of two technical results used in the proof of the non-ergodicity criterion and stated in Section 4, i.e. Lemma 4.3 and Theorem 4.2, which relates coboundaries with the unstable space of the Kontsevich-Zorich.

2. \mathbb{Z} -COVERS AND EXTENSIONS OF INTERVAL EXCHANGE TRANSFORMATIONS

\mathbb{Z} -covers. Let (M, ω) be a compact connected translation surface and \widetilde{M} a \mathbb{Z} -cover of M (see §1). Let us show that there is a one-to-one correspondence between $H_1(M, \mathbb{Z})$ and the set of \mathbb{Z} -covers, up to isomorphism¹. Let us first recall that we have the following isomorphism (we refer for example to Proposition 14.1 in [19]):

$$\mathrm{Hom}(\pi_1(M, x), \mathbb{Z}) \longleftrightarrow \{\mathbb{Z}\text{-covers of } M\}/\text{isomorphism}.$$

In view of Hurewicz theorem $\pi_1(M, x)/[\pi_1(M, x), \pi_1(M, x)]$ and $H_1(M, \mathbb{Z})$ are isomorphic, so $\mathrm{Hom}(\pi_1(M, x), \mathbb{Z})$ and $\mathrm{Hom}(H_1(M, \mathbb{Z}), \mathbb{Z})$ are isomorphic as well. This yields a one-to-one correspondence

$$\mathrm{Hom}(H_1(M, \mathbb{Z}), \mathbb{Z}) \longleftrightarrow \{\mathbb{Z}\text{-covers of } M\}/\text{isomorphism}.$$

The space $H_1(M, \mathbb{Z})$ is isomorphic to $\mathrm{Hom}(H_1(M, \mathbb{Z}), \mathbb{Z})$ via the map $\gamma \mapsto \phi_\gamma : H_1(M, \mathbb{Z}) \rightarrow \mathbb{Z}$, $\phi_\gamma(\gamma') = \langle \gamma, \gamma' \rangle$, where $\langle \cdot, \cdot \rangle : H_1(M, \mathbb{R}) \times H_1(M, \mathbb{R}) \rightarrow \mathbb{R}$ is the intersection form (see for example Proposition 18.13 in [19]). This gives the next correspondence

$$(2.1) \quad H_1(M, \mathbb{Z}) \longleftrightarrow \{\mathbb{Z}\text{-covers of } M\}/\text{isomorphism}.$$

The \mathbb{Z} -cover \widetilde{M}_γ determined by $\gamma \in H_1(M, \mathbb{Z})$ under the correspondence (2.1) has the following properties. Remark that $\langle \cdot, \cdot \rangle$ restricted to $H_1(M, \mathbb{Z}) \times H_1(M, \mathbb{Z})$ coincides with the algebraic intersection number. If σ is a close curve in M and $n := \langle \gamma, [\sigma] \rangle \in \mathbb{Z}$ ($[\sigma] \in H_1(M, \mathbb{Z})$), then σ lifts to a path $\tilde{\sigma} : [t_0, t_1] \rightarrow \widetilde{M}_\gamma$ such that $\sigma(t_1) = n \cdot \sigma(t_0)$, where \cdot denotes the action of \mathbb{Z} on $(\widetilde{M}_\gamma, \tilde{\omega}_\gamma)$ by deck transformations. Conversely, if $v : [t_0, t_1] \rightarrow \widetilde{M}$ is a curve such

$$(2.2) \quad v(t_1) = n \cdot v(t_0) \text{ for some } n \in \mathbb{Z}, \text{ then } \langle \gamma, [p \circ v] \rangle = n,$$

where $[p \circ v] \in H_1(M, \mathbb{Z})$ is the homology class of the projection of v by $p : \widetilde{M}_\gamma \rightarrow M$.

¹Let us remark that here we consider only unramified \mathbb{Z} -covers. More generally, one can consider ramified covers determined by elements in the relative homology $H_1(M, \Sigma, \mathbb{Z})$, see [24].

Interval exchange transformations. Let us recall the definition of interval exchange transformations (IETs), with the presentation and notation from [40] and [41]. Let \mathcal{A} be a d -element alphabet and let $\pi = (\pi_0, \pi_1)$ be a pair of bijections $\pi_\varepsilon : \mathcal{A} \rightarrow \{1, \dots, d\}$ for $\varepsilon = 0, 1$. Denote by $\mathcal{S}_{\mathcal{A}}$ the set of all such pairs. Let us consider $\lambda = (\lambda_\alpha)_{\alpha \in \mathcal{A}} \in \mathbb{R}_+^{\mathcal{A}}$, where $\mathbb{R}_+ = (0, +\infty)$. Set $|\lambda| = \sum_{\alpha \in \mathcal{A}} \lambda_\alpha$, $I = [0, |\lambda|)$ and, for $\varepsilon = 0, 1$, let

$$I_\alpha^\varepsilon = [l_\alpha^\varepsilon, r_\alpha^\varepsilon), \quad \text{where} \quad l_\alpha^\varepsilon = \sum_{\pi_\varepsilon(\beta) < \pi_\varepsilon(\alpha)} \lambda_\beta, \quad r_\alpha^\varepsilon = \sum_{\pi_\varepsilon(\beta) \leq \pi_\varepsilon(\alpha)} \lambda_\beta.$$

Then $|I_\alpha^\varepsilon| = \lambda_\alpha$ for $\alpha \in \mathcal{A}$. Given $(\pi, \lambda) \in \mathcal{S}_{\mathcal{A}} \times \mathbb{R}_+^{\mathcal{A}}$, let $T_{(\pi, \lambda)} : [0, |\lambda|) \rightarrow [0, |\lambda|)$ stand for the *interval exchange transformation* (IET) on d intervals I_α , $\alpha \in \mathcal{A}$, which isometrically maps each I_α^0 to I_α^1 , i.e. $T_{(\pi, \lambda)}(x) = x + w_\alpha$ with $w_\alpha := l_\alpha^1 - l_\alpha^0$, for $x \in I_\alpha^0$, $\alpha \in \mathcal{A}$.

Cocycles and skew-product extensions. Let T be an ergodic automorphism of standard probability space (X, \mathcal{B}, μ) . Let G be a locally compact abelian second countable group. Each measurable function $\psi : X \rightarrow G$ determines a *cocycle* $\psi^{(\cdot)}$ for T by the formula

$$(2.3) \quad \psi^{(n)}(x) = \begin{cases} \psi(x) + \psi(Tx) + \dots + \psi(T^{n-1}x) & \text{if } n > 0 \\ 0 & \text{if } n = 0 \\ -(\psi(T^n x) + \psi(T^{n+1}x) + \dots + \psi(T^{-1}x)) & \text{if } n < 0, \end{cases}$$

the function ψ is also called a cocycle. The *skew product extension* associated to the cocycle ψ is the map $T_\psi : X \times G \rightarrow X \times G$

$$T_\psi(x, y) = (Tx, y + \psi(x)).$$

Clearly T_ψ preserves the product of μ and the Haar measure m_G on G .

2.1. Reduction to \mathbb{Z} -extensions over IETs. Let us explain how the question of ergodicity for directional flows for \mathbb{Z} -covers of a compact translation surface (M, ω) reduces to the study of \mathbb{Z} -valued cocycles for interval exchange transformations (IETs). Let $(\tilde{\varphi}_t^\theta)_{t \in \mathbb{R}}$ be a directional flows for a \mathbb{Z} -cover $(\tilde{M}, \tilde{\omega})$ of (M, ω) such that the flow $(\varphi_t^\theta)_{t \in \mathbb{R}}$ on M is ergodic. Let $I \subset M \setminus \Sigma$ be an interval transversal to the direction θ with no self-intersections. The Poincaré return map $T : I \rightarrow I$ is a minimal ergodic IET (eif $(\varphi_t^\theta)_{t \in \mathbb{R}}$ is ergodic), whose numerical data will be denoted by $(\pi, \lambda) \in \mathcal{S}_{\mathcal{A}} \times \mathbb{R}_+^{\mathcal{A}}$ (see for example [41, 42]). Let $\tau : I \rightarrow \mathbb{R}_+$ be the function which assigns to $x \in I$ the first return time $\tau(x)$ of x to I under the flow. The function τ is constant and equal to some τ_α on each exchanged interval I_α . The flow $(\varphi_t^\theta)_{t \in \mathbb{R}}$ is hence measure-theoretically isomorphic to the special flow built over the IET $T : I \rightarrow I$ and under the roof function $\tau : I \rightarrow \mathbb{R}_+$. For every $\alpha \in \mathcal{A}$ we will denote by $\gamma_\alpha \in H_1(M, \mathbb{Z})$ the homology class of any loop v_x formed by the segment of orbit for $(\varphi_t^\theta)_{t \in \mathbb{R}}$ starting at any $x \in \text{Int } I_\alpha$ and ending at Tx together with the segment of I that joins Tx and x , that we will denote by $[Tx, x]$.

Let us now define a cross-section for the flow $(\tilde{\varphi}_t^\theta)_{t \in \mathbb{R}}$ and describe the corresponding Poincaré map. Let \tilde{I} be the preimage of the interval I via the covering map $p : \tilde{M} \rightarrow M$. Fix $I_0 \subset \tilde{I}$ a connected component of \tilde{I} . Then $p|_{I_0} : I_0 \rightarrow I$ is a homomorphism and \tilde{I} is homeomorphic to $I \times \mathbb{Z}$ by the map

$$(2.4) \quad I \times \mathbb{Z} \ni (x, n) \mapsto \varrho(x, n) := n \cdot (p|_{I_0})^{-1}(x) \in \tilde{I}.$$

Denote by $\tilde{T} : \tilde{I} \rightarrow \tilde{I}$ the the Poincaré return map to \tilde{I} for the flow $(\tilde{\varphi}_t^\theta)_{t \in \mathbb{R}}$.

Lemma 2.1. *Suppose that $(\tilde{M}, \tilde{\omega}) = (\tilde{M}_\gamma, \tilde{\omega}_\gamma)$ for some $\gamma \in H_1(M, \mathbb{Z})$ is a \mathbb{Z} -cover. Then the Poincaré return map \tilde{T} is isomorphic (via the map ϱ given in (2.4)) to*

a skew product $T_\psi : I \times \mathbb{Z} \rightarrow I \times \mathbb{Z}$ of the form $T_\psi(x, n) = (Tx, n + \psi(x))$, where $\psi = \psi_\gamma : I \rightarrow \mathbb{Z}$ is a piecewise constant function given by

$$\psi_\gamma(x) = \langle \gamma, \gamma_\alpha \rangle \quad \text{if } x \in I_\alpha \quad \text{for each } \alpha \in \mathcal{A}$$

and T and γ_α for $\alpha \in \mathcal{A}$ are as above.

Proof. Let us first remark that

$$(2.5) \quad p(\varrho(x, n)) = x \text{ and } m \cdot \varrho(x, n) = \varrho(x, m + n) \text{ for all } x \in I, m, n \in \mathbb{Z}.$$

Moreover, if $\varrho(x, n), \varrho(x', n') \in \tilde{I}$ are joined by a curve in \tilde{I} then the points belong to the same connected component of \tilde{I} , hence $n = n'$. Fix $(x, n) \in \text{Int } I_\alpha \times \mathbb{Z}$ and denote by $v_{x,n}$ the lift of the loop v_x which starts from the point $\varrho(x, n) \in \tilde{I}$. Setting $\varrho(x, n_e) \in \tilde{I}$ by its endpoint, by (2.2) and (2.5), we have

$$\varrho(x, n_e) = \langle \gamma, [v_x] \rangle \cdot \varrho(x, n) = \langle \gamma, \gamma_\alpha \rangle \cdot \varrho(x, n) = \varrho(x, n + \langle \gamma, \gamma_\alpha \rangle),$$

so $n_e = n + \langle \gamma, \gamma_\alpha \rangle$. Since $v_{x,n}$ is a lift of the curve formed by the segment of orbit for $(\varphi_t^\theta)_{t \in \mathbb{R}}$ starting at $x \in \text{Int } I_\alpha$ and ending at Tx together with the segment of I that joins Tx and x , $v_{x,n}$ is formed by the segment of orbit for $(\tilde{\varphi}_t^\theta)_{t \in \mathbb{R}}$ starting at $\varrho(x, n) \in \tilde{I}$ and ending at $\tilde{T}\varrho(x, n)$ together with a curve in \tilde{I} that joins $\tilde{T}\varrho(x, n)$ and $\varrho(x, n_e)$. As $p(\tilde{T}\varrho(x, n)) = Tx$ and the points $\tilde{T}\varrho(x, n)$ and $\varrho(x, n_e)$ belong to the same connected component of \tilde{I} , it follows that

$$\tilde{T}\varrho(x, n) = \varrho(Tx, n_e) = \varrho(Tx, n + \langle \gamma, \gamma_\alpha \rangle),$$

which completes the proof. \square

Remark 2.2. The ergodicity of the flow $(\tilde{\varphi}_t^\theta)_{t \in \mathbb{R}}$ on $(\tilde{M}_\gamma, \tilde{\omega}_\gamma)$ is equivalent to the ergodicity of its Poincaré map \tilde{T} and thus, by Lemma 2.1, it is equivalent to the ergodicity of the skew product $T_{\psi_\gamma} : I \times \mathbb{Z} \rightarrow I \times \mathbb{Z}$.

We now recall some properties of this reduction for a special choice of the section I , which will be useful in §8. For simplicity let $\theta = \pi/2$ and assume in addition that the vertical flow $(\tilde{\varphi}_t^\nu)_{t \in \mathbb{R}}$ has no vertical saddle connections, i.e. none of its trajectory joins two points of Σ , and that the interval I is horizontal and it is chosen so that one endpoint belongs to the singularity set Σ and the other belongs to an incoming or outgoing separatrix, that is to a trajectory which ends or begins at a point of Σ . In this case the IET T has the minimal possible number of exchanged intervals and the special flow representation is known as *zippered rectangle* (see [41] or [42] for more details). Recall that each discontinuity of T belongs to an incoming separatrix (and, by choice, also the endpoints of I belong to separatrices). For each $\alpha \in \mathcal{A}$, let $\sigma_{l,\alpha} \in \Sigma$ (respectively $\sigma_{r,\alpha} \in \Sigma$) be the singularity of the separatrix through the left (right) endpoint of I_α .

While homology classes $\{\gamma_\alpha : \alpha \in \mathcal{A}\}$ defined at the beginning of this §2.1 generate the homology $H_1(M, \mathbb{Z})$ (Lemma 2.17, §2.9 in [41]), one can construct a base of the relative homology $H_1(M, \Sigma, \mathbb{Z})$ as follows. For each $\alpha \in \mathcal{A}$ denote by $\xi_\alpha \in H_1(M, \Sigma, \mathbb{Z})$ the relative homology class of the path which joins $\sigma_{l,\alpha}$ to $\sigma_{r,\alpha}$, obtained juxtaposing the segment of separatrix starting from $\sigma_{l,\alpha}$ up to the left endpoint of I_α , the interval I_α , and the segment of separatrix starting from the right endpoint of I_α and ending at $\sigma_{r,\alpha}$. Then $\{\xi_\alpha : \alpha \in \mathcal{A}\}$ establishes a basis of the relative homology $H_1(M, \Sigma, \mathbb{Z})$ (see [42]). This basis allows us to explicitly compute the vectors $(\lambda_\alpha)_{\alpha \in \mathcal{A}}$ and $(w_\alpha)_{\alpha \in \mathcal{A}}$ defining T and the return times $(\tau_\alpha)_{\alpha \in \mathcal{A}}$ as follows (see [41] or [42]):

$$(2.6) \quad \lambda_\alpha = \int_{\xi_\alpha} \Re \omega, \quad w_\alpha = \int_{\gamma_\alpha} \Re \omega, \quad \tau_\alpha = \int_{\gamma_\alpha} \Im \omega \quad \text{for all } \alpha \in \mathcal{A}.$$

3. ESSENTIAL VALUES OF COCYCLES

We give here a brief overview of the tools needed to prove the non-ergodicity of the skew product T_ψ (see Section 2.1) and describe its ergodic components. For further background material concerning skew products and infinite measure-preserving dynamical systems we refer the reader to [2] and [36].

3.1. Cocycles for transformations and essential values. Given an ergodic automorphism T of standard probability space (X, \mathcal{B}, μ) , a locally compact abelian second countable group G and a cocycle $\psi : X \rightarrow G$ for T , consider the skew-product extension $T_\psi : (X \times G, \mathcal{B} \times \mathcal{B}_G, \mu \times m_G) \rightarrow (X \times G, \mathcal{B} \times \mathcal{B}_G, \mu \times m_G)$ (\mathcal{B}_G is the Borel σ -algebra on G) given by $T_\psi(x, y) = (Tx, y + \psi(x))$.

Two cocycles $\psi_1, \psi_2 : X \rightarrow G$ for T are called *cohomologous* if there exists a measurable function $g : X \rightarrow G$ (called the *transfer function*) such that $\psi_1 = \psi_2 + g - g \circ T$. Then the corresponding skew products T_{ψ_1} and T_{ψ_2} are measure-theoretically isomorphic via the map $(x, y) \mapsto (x, y + g(x))$. A cocycle $\psi : X \rightarrow \mathbb{R}$ is a *coboundary* if it is cohomologous to the zero cocycle.

Denote by \overline{G} the one point compactification of the group G . An element $g \in \overline{G}$ is said to be an *essential value* of ψ , if for each open neighborhood V_g of g in \overline{G} and an arbitrary set $B \in \mathcal{B}$, $\mu(B) > 0$, there exists $n \in \mathbb{Z}$ such that

$$(3.1) \quad \mu(B \cap T^{-n}B \cap \{x \in X : \psi^{(n)}(x) \in V_g\}) > 0.$$

The set of essential values of ψ will be denoted by $\overline{E}_G(\psi)$ and put $E_G(\psi) = G \cap \overline{E}_G(\psi)$. Then $E_G(\psi)$ is a closed subgroup of G .

A cocycle $\psi : X \rightarrow G$ is recurrent if for each open neighborhood V_0 of 0, (3.1) holds for some $n \neq 0$. This is equivalent to the recurrence of the skew product T_ψ (cf. [36]). In the particular case $G \subset \mathbb{R}$ and $\psi : X \rightarrow G$ integrable we have that the recurrence of ψ is equivalent to $\int_X \psi d\mu = 0$.

We recall below some properties of $\overline{E}_G(\psi)$ (see [36]).

Proposition 3.1. *If H is a closed subgroup of G and $\psi : X \rightarrow H$ then $E_G(\psi) = E_H(\psi) \subset H$. If $\psi_1, \psi_2 : X \rightarrow G$ are cohomologous then $\overline{E}_G(\psi_1) = \overline{E}_G(\psi_2)$.*

Consider the quotient cocycle $\psi^* : X \rightarrow G/E(\psi)$ given by $\psi^*(x) = \psi(x) + E(\psi)$. Then $E_{G/E(\psi)}(\psi^*) = \{0\}$. The cocycle $\psi : X \rightarrow G$ is called *regular* if $\overline{E}_{G/E(\psi)}(\psi^*) = \{0\}$ and *non-regular* if $\overline{E}_{G/E(\psi)}(\psi^*) = \{0, \infty\}$. Recall that if $\psi : X \rightarrow G$ is regular then it is cohomologous to a cocycle $\psi_0 : X \rightarrow E(\psi)$ such that $E(\psi_0) = E(\psi)$.

The following classical Proposition gives a criterion to prove ergodicity and check if a cocycle is a coboundary using essential values.

Proposition 3.2 (see [36]). *Suppose that $T : (X, \mu) \rightarrow (X, \mu)$ is an ergodic automorphism and $\psi : X \rightarrow G$ be a cocycle for T . The skew product $T_\psi : X \times G \rightarrow X \times G$ is ergodic if and only if $E_G(\psi) = G$. The cocycle is a coboundary if and only if $\overline{E}_G(\psi) = \{0\}$.*

We also recall the following characterization of coboundaries.

Proposition 3.3 (see [5]). *If $T : (X, \mu) \rightarrow (X, \mu)$ is an ergodic automorphism then the cocycle $\psi : X \rightarrow G$ for T is a coboundary if and only if the skew product $T_\psi : X \times G \rightarrow X \times G$ has an invariant set of positive finite measure.*

3.2. Ergodic decomposition and Mackey action. If the skew product $T_\psi : X \times G \rightarrow X \times G$ is not ergodic then the structure of its ergodic components (defined below) can be studied by looking at properties of the so called Mackey action.

Let $(\tau_g)_{g \in G}$ denote the G -action on $(X \times G, \mathcal{B} \times \mathcal{B}_G, \mu \times m_G)$ given by $\tau_g(x, h) = (x, h + g)$. Then $(\tau_g)_{g \in G}$ commutes with the skew product T_ψ . Fix a probability Borel measure m on G equivalent to the Haar measure m_G . Then the probability measure $\mu \times m$ is quasi-invariant under T_ψ and $(\tau_g)_{g \in G}$, i.e. $(T_\psi)_*(\mu \times m)$ and $(\tau_g)_*(\mu \times m)$ for any $g \in G$ are equivalent to $\mu \times m$ (or, in other words, T_ψ and $(\tau_g)_{g \in G}$ are non-singular actions on $(X \times G, \mathcal{B} \times \mathcal{B}_G, \mu \times m)$). Denote by $\mathcal{I}_\psi \subset \mathcal{B} \times \mathcal{B}_G$ the σ -algebra of T_ψ -invariant subsets. Since $(X \times G, \mathcal{B} \times \mathcal{B}_G, \mu \times m)$ is a standard probability Borel space, the quotient space $((X \times G)/\mathcal{I}_\psi, \mathcal{I}_\psi, \mu \times m|_{\mathcal{I}_\psi})$ is well-defined (and is also standard). This space is called the *space of ergodic components* and it will be denoted by (Y, \mathcal{C}, ν) . Since $(\tau_g)_{g \in G}$ preserves \mathcal{I}_ψ it also acts on (Y, \mathcal{C}, ν) . This non-singular G -action is called the *Mackey action* (and is denoted by $(\tau_g^\psi)_{g \in G}$) associated to the skew product T_ψ , and it is always ergodic. Moreover, there exists a measurable map $Y \ni y \mapsto \bar{\mu}_y$ taking values in the space of probability measures on $(X \times G, \mathcal{B} \times \mathcal{B}_G)$ such that

- $\mu \times m = \int_Y \bar{\mu}_y d\nu(y)$;
- $\bar{\mu}_y$ is quasi-invariant and ergodic under T_ψ for ν -a.e. $y \in Y$;
- $\bar{\mu}_y$ is equivalent to a σ -finite measure μ_y invariant under T_ψ .

Then T_ψ on $(X \times G, \mathcal{B} \times \mathcal{B}_G, \mu_y)$ for $y \in Y$ are called *ergodic components* of T_ψ .

Theorem 3.4 ([36, 43]). *Suppose that $T : (X, \mu) \rightarrow (X, \mu)$ is ergodic and let $\psi : X \rightarrow G$ be a cocycle. Then*

- (i) ψ is recurrent if and only if the measure μ_y is continuous for ν -a.e. $y \in Y$;
- (ii) ψ is non-recurrent if and only if μ_y is purely atomic for ν -a.e. $y \in Y$;
- (iii) ψ is regular if and only if the Mackey action $(\tau_g^\psi)_{g \in G}$ is strictly transitive, i.e. the measure ν is supported on a single orbit of $(\tau_g^\psi)_{g \in G}$.

If ψ is not recurrent then almost every ergodic component $T_\psi : (X \times G, \mu_y) \rightarrow (X \times G, \mu_y)$ is trivial, i.e. it is strictly transitive.

If ψ is regular then the structure of ergodic components is trivial, i.e. if we fix one ergodic component then every other ergodic component is the image of the fixed component by a transformation τ_g . In particular, all ergodic components are isomorphic.

As a immediate consequence of Theorem 3.4 we obtain that if a cocycle is recurrent and non-regular then the structure of ergodic components of the skew product and the dynamics inside ergodic components are highly non-trivial.

Corollary 3.5. *Let $T : (X, \mu) \rightarrow (X, \mu)$ be an ergodic automorphism and $\psi : X \rightarrow \mathbb{Z}$ is a recurrent non-regular cocycle. Then the measures ν and μ_y for ν -a.e. $y \in Y$ are continuous. In particular, the skew product T_ψ has uncountably many ergodic components and almost every ergodic component is not supported by a countable set.*

Proof. Since the measure ν is ergodic for the the Mackey \mathbb{Z} -action, it is either continuous or purely discrete. If ν is discrete then, by ergodicity, ν is supported by a single orbit, in contradiction with (iii). Consequently, ν is continuous. The continuity of almost every measure μ_y follows directly from (i). The second part of the corollary is a direct consequence of the continuity of these measures. \square

Remark 3.6. Let $(\tilde{\varphi}_t^\theta)_{t \in \mathbb{R}}$ be a directional flows on a \mathbb{Z} -cover $(\tilde{M}, \tilde{\omega})$ of (M, ω) such that the flow $(\varphi_t^\theta)_{t \in \mathbb{R}}$ on (M, ω) is ergodic. Suppose that its Poincaré return map is isomorphic to a skew product $T_\psi : I \times \mathbb{Z} \rightarrow I \times \mathbb{Z}$ (as in Section 2.1) and the cocycle ψ is recurrent and non-regular. Then the flow $(\tilde{\varphi}_t^\theta)_{t \in \mathbb{R}}$ is not ergodic and it has uncountably many ergodic components and almost every such ergodic component is not supported on a single orbit of the flow.

3.3. Cocycles for flows. Let $(\varphi_t)_{t \in \mathbb{R}}$ be a Borel flow on a standard probability Borel space (X, \mathcal{B}, μ) . A *cocycle* for the flow $(\varphi_t)_{t \in \mathbb{R}}$ is a Borel function $F : \mathbb{R} \times X \rightarrow \mathbb{R}$ such that

$$F(t + s, x) = F(t, \varphi_s x) + F(s, x) \text{ for all } s, t \in \mathbb{R} \text{ and } x \in X.$$

Definition 2. Two cocycles $F_1, F_2 : \mathbb{R} \times X \rightarrow \mathbb{R}$ are called *cohomologous* if there exists a Borel function $u : X \rightarrow \mathbb{R}$ and a Borel $(\varphi_t)_{t \in \mathbb{R}}$ -invariant subset $X_0 \subset X$ with $\mu(X_0) = 1$ such that

$$F_2(t, x) = F_1(t, x) + u(x) - u(\varphi_t x) \text{ for all } x \in X_0 \text{ and } t \in \mathbb{R}.$$

A cocycle $F : \mathbb{R} \times X \rightarrow \mathbb{R}$ is said to be a *cocycle* if it is cohomologous to the zero cocycle.

Remark 3.7. Let us recall a simple condition on a cocycle F guaranteeing that it is a coboundary: if there exist a Borel $(\varphi_t)_{t \in \mathbb{R}}$ -invariant subset $X_0 \subset X$ with $\mu(X_0) = 1$ such that the map $\mathbb{R}_+ \ni t \mapsto F(t, x) \in \mathbb{R}$ is continuous and bounded for every $x \in X_0$ then F is a coboundary. Moreover, the transfer function $u : X \rightarrow \mathbb{R}$ is given by

$$u(x) := \limsup_{s \rightarrow +\infty} F(s, x) = \limsup_{s \in \mathbb{Q}, s \rightarrow +\infty} F(s, x) \quad \text{for } x \in X_0.$$

Indeed, for every $t \geq 0$ and $x \in X_0$ we have

$$u(\varphi_t x) = \limsup_{s \rightarrow +\infty} F(s, \varphi_t x) = \limsup_{s \rightarrow +\infty} F(s + t, x) - F(t, x) = u(x) - F(t, x).$$

Cocycles for translation flows. Let (M, ω) be a compact translation surface and let $\theta \in S^1$. For every $x \in M \setminus \Sigma$ denote by $I^\theta(x) \subset \mathbb{R}$ the maximal open interval for which $\varphi_t^\theta x$ is well defined whenever $t \in I^\theta(x) \subset \mathbb{R}$. If $x \in M_\theta$ then $I^\theta(x) = \mathbb{R}$. For any smooth bounded function $f : M \setminus \Sigma \rightarrow \mathbb{R}$ let

$$(3.2) \quad F_f^\theta(t, x) := \int_0^t f(\varphi_s^\theta x) ds \text{ if } t \in I^\theta(x).$$

Thus F_f^θ is well defined on $\mathbb{R} \times M_\theta$ and it is a cocycle for the directional flow $(\varphi_t^\theta)_{t \in \mathbb{R}}$ considered on (M_θ, ν_ω) .

Assume that the directional flow $(\varphi_t^\theta)_{t \in \mathbb{R}}$ is minimal and let $I_\theta \subset M$ be an interval transverse to $(\varphi_t^\theta)_{t \in \mathbb{R}}$. The first return (Poincaré) map of $(\varphi_t^\theta)_{t \in \mathbb{R}}$ to I_θ is an interval exchange transformation T_θ . Let $\psi_f^\theta : I \rightarrow \mathbb{R}$ be the cocycle for T_θ defined as follows. Let $\tau : I_\theta \rightarrow \mathbb{R}^+$ be the piecewise constant function which gives the first return time $\tau(x)$ of x to I_θ under the flow $(\varphi_t^\theta)_{t \in \mathbb{R}}$. Then

$$\psi_f^\theta(x) = F_f^\theta(\tau(x), x) = \int_0^{\tau(x)} f(\varphi_s^\theta x) ds, \quad x \in I_\theta.$$

The following standard equivalence holds (see for example [17]).

Lemma 3.8. *The cocycle F_f^θ is a coboundary for the flow $(\varphi_t^\theta)_{t \in \mathbb{R}}$ if and only if the cocycle ψ_f^θ is a coboundary for the interval exchange transformation T_θ .*

Remark 3.9. For every smooth closed form $\rho \in \Omega^1(M)$ let us consider the smooth bounded function $f : M \setminus \Sigma \rightarrow \mathbb{R}$, $f = i_{X_\theta} \rho$ and let $\psi_\rho : I \rightarrow \mathbb{R}$ be the corresponding cocycle for T defined by $\psi_\rho(x) = \int_0^{\tau(x)} f(\varphi_s^\theta x) ds$. Let $\gamma := \mathcal{P}^{-1}[\rho] \in H_1(M, \mathbb{R})$, where $\mathcal{P} : H_1(M, \mathbb{R}) \rightarrow H^1(M, \mathbb{R})$ the Poincaré duality, see (4.1) for definition. Then, recalling the definitions of γ_α , v_x and $[x, Tx]$ in §2.1 and applying (4.2), for every $x \in I_\alpha$

$$\langle \gamma_\alpha, \gamma \rangle = \int_{\gamma_\alpha} \rho = \int_{v_x} \rho = \int_0^{\tau(x)} i_{X_\theta} \rho(\varphi_s^\theta x) ds + \int_{[Tx, x]} \rho = \psi_\rho(x) + g(x) - g(Tx),$$

where $g : I \rightarrow \mathbb{R}$ is given by $g(x) = \int_{[x_0, x]} \rho$ (x_0 is the left endpoint of the interval I). Consequently, denoting by $\psi_\gamma : I \rightarrow \mathbb{R}$ the cocycle $\psi_\gamma(x) = \langle \gamma, \gamma_\alpha \rangle$ if $x \in I_\alpha$ for $\alpha \in \mathcal{A}$, we conclude that the cocycle $\psi_\rho + \psi_\gamma$ is a coboundary.

4. THE TEICHMÜLLER FLOW AND THE KONTSEVICH-ZORICH COCYCLE

Given a connected oriented surface M and a discrete countable set $\Sigma \subset M$, denote by $\text{Diff}^+(M, \Sigma)$ the group of orientation-preserving homeomorphisms of M preserving Σ . Denote by $\text{Diff}_0^+(M, \Sigma)$ the subgroup of elements $\text{Diff}^+(M, \Sigma)$ which are isotopic to the identity. Let us denote by $\Gamma(M, \Sigma) := \text{Diff}^+(M, \Sigma) / \text{Diff}_0^+(M, \Sigma)$ the *mapping-class group*. We will denote by $\mathcal{Q}(M)$ (respectively $\mathcal{Q}^{(1)}(M)$) the *Teichmüller space of Abelian differentials* (respectively of unit area Abelian differentials), that is the space of orbits of the natural action of $\text{Diff}_0^+(M, \emptyset)$ on the space of all Abelian differentials on M (respectively, the ones with total area $A(\omega) = \int_M \Re(\omega) \wedge \Im(\omega) = 1$). We will denote by $\mathcal{M}(M)$ ($\mathcal{M}^{(1)}(M)$) the *moduli space of (unit area) Abelian differentials*, that is the space of orbits of the natural action of $\text{Diff}^+(M, \emptyset)$ on the space of (unit area) Abelian differentials on M . Thus $\mathcal{M}(M) = \mathcal{Q}(M) / \Gamma(M, \emptyset)$ and $\mathcal{M}^{(1)}(M) = \mathcal{Q}^{(1)}(M) / \Gamma(M, \emptyset)$.

The group $SL(2, \mathbb{R})$ acts naturally on $\mathcal{Q}^{(1)}(M)$ and $\mathcal{M}^{(1)}(M)$ by postcomposition on the charts defined by local primitives of the holomorphic 1-form. We will denote by $g \cdot \omega$ the new Abelian differential obtained acting by $g \in SL(2, \mathbb{R})$ on ω . The *Teichmüller flow* $(G_t)_{t \in \mathbb{R}}$ is the restriction of this action to the diagonal subgroup $(\text{diag}(e^t, e^{-t}))_{t \in \mathbb{R}}$ of $SL(2, \mathbb{R})$ on $\mathcal{Q}^{(1)}(M)$ and $\mathcal{M}^{(1)}(M)$. Remark that the $SL(2, \mathbb{R})$ action preserves the zeros of ω and their degrees.

Let M be compact and of genus g and let κ be the number of zeros of ω . If k_i , $1 \leq i \leq \kappa$ is the degrees of each zero, one has $2g - 2 = \sum_{i=1}^{\kappa} k_i$. Let us denote by $\mathcal{H}(\underline{k}) = \mathcal{H}(k_1, \dots, k_\kappa)$ the *stratum* consisting of all (M, ω) such that ω has κ zeros of degrees k_1, \dots, k_κ . Each stratum is invariant under the $SL(2, \mathbb{R})$ action and the connected components of this action were classified in [30]. Let $\mathcal{H}^{(1)}(\underline{k}) = \mathcal{H}(\underline{k}) \cap \mathcal{M}^{(1)}(M)$. Each stratum $\mathcal{H}^{(1)} = \mathcal{H}^{(1)}(\underline{k})$ carries a canonical $SL(2, \mathbb{R})$ -invariant measure $\mu_{\mathcal{H}}^{(1)}$ that can be defined as follows. Let $\{\gamma_1, \dots, \gamma_n\}$ be a basis of the relative homology $H_1(M, \Sigma, \mathbb{Z})$. Remark that for each γ_i , $\int_{\gamma_i} \omega \in \mathbb{C} \approx \mathbb{R}^2$. The *relative periods* $(\int_{\gamma_1} \omega, \dots, \int_{\gamma_n} \omega) \in \mathbb{R}^{2n}$ are local coordinates on the stratum $\mathcal{H}(\underline{k})$. Consider the pull-back by the relative periods of the Lebesgue measure on \mathbb{R}^{2n} . This measure induces a conditional measure on the hypersurface $\mathcal{H}^{(1)}(\underline{k}) \subset \mathcal{H}(\underline{k})$. Since this measure is finite (see [32, 39]), we can renormalize it to get a probability measure that we will denote by $\mu_{\mathcal{H}}^{(1)}$. The measure $\mu_{\mathcal{H}}^{(1)}$ is $SL(2, \mathbb{R})$ -invariant and ergodic for the Teichmüller flow.

The Kontsevich-Zorich cocycle. Assume that M is compact. The *Kontsevich-Zorich cocycle* $(G_t^{KZ})_{t \in \mathbb{R}}$ is the quotient of the trivial cocycle

$$G_t \times \text{Id} : \mathcal{Q}^{(1)}(M) \times H^1(M, \mathbb{R}) \rightarrow \mathcal{Q}^{(1)}(M) \times H^1(M, \mathbb{R})$$

by the action of the mapping-class group $\Gamma(M) := \Gamma(M, \emptyset)$. The mapping class group acts on the fiber $H^1(M, \mathbb{R})$ by pullback. The cocycle $(G_t^{KZ})_{t \in \mathbb{R}}$ acts on the cohomology vector bundle

$$\mathcal{H}^1(M, \mathbb{R}) = (\mathcal{Q}^{(1)}(M) \times H^1(M, \mathbb{R})) / \Gamma(M)$$

(known as *Hodge bundle*) over the Teichmüller flow $(G_t)_{t \in \mathbb{R}}$ on the moduli space $\mathcal{M}^{(1)}(M) = \mathcal{Q}^{(1)}(M) / \Gamma(M)$. We will denote by $H^1(M_\omega, \mathbb{R})$ the fiber at ω . Clearly

$H^1(M_\omega, \mathbb{R}) = H^1(M, \mathbb{R})$. The space $H^1(M, \mathbb{R})$ is endowed with symplectic (intersection) form given by

$$\langle c_1, c_2 \rangle := \int_M c_1 \wedge c_2 \text{ for } c_1, c_2 \in H^1(M, \mathbb{R}).$$

This symplectic structure is preserved by the action of the mapping-class group and hence is invariant under the action of $SL(2, \mathbb{R})$.

Denote by $\mathcal{P} : H_1(M, \mathbb{R}) \rightarrow H^1(M, \mathbb{R})$ the Poincaré duality, i.e.

$$(4.1) \quad \mathcal{P}\sigma = c \quad \text{iff} \quad \int_\sigma c' = \langle c, c' \rangle \quad \text{for all } c' \in H^1(M, \mathbb{R}).$$

Since the Poincaré duality $\mathcal{P} : H_1(M, \mathbb{R}) \rightarrow H^1(M, \mathbb{R})$ intertwines the intersection forms $\langle \cdot, \cdot \rangle$ on $H_1(M, \mathbb{R})$ and $H^1(M, \mathbb{R})$ respectively, that is $\langle \sigma, \sigma' \rangle = \langle \mathcal{P}\sigma, \mathcal{P}\sigma' \rangle$ for all $\sigma, \sigma' \in H_1(M, \mathbb{R})$, we have

$$(4.2) \quad \langle \sigma, \sigma' \rangle = \langle \mathcal{P}\sigma, \mathcal{P}\sigma' \rangle = \int_\sigma \mathcal{P}\sigma' \quad \text{for all } \sigma, \sigma' \in H_1(M, \mathbb{R}).$$

Each fiber $H^1(M_\omega, \mathbb{R})$ of the vector bundle $\mathcal{H}^1(M, \mathbb{R})$ is endowed with a natural norm, called the *Hodge norm*, defined as follows (see [15]). Given a cohomology class $c \in H^1(M, \mathbb{R})$, there exists a unique holomorphic one-form η , holomorphic with respect to the complex structure induced by ω , such that $c = [\Re\eta]$. The Hodge norm of $\|c\|_\omega$ is then defined as $(\frac{i}{2} \int_M \eta \wedge \bar{\eta})^{1/2}$.

Lyapunov exponents and Oseledets splittings. Let μ be a probability measure on $\mathcal{M}^{(1)}(M)$ which is invariant for the Teichmüller flow and ergodic. Since the Hodge norm of the Kontsevich-Zorich cocycle at time t is constant and equal to e^t (see [15]) and μ is a probability measure, the Kontsevich-Zorich cocycle is log-integrable with respect to μ . Thus, it follows from Oseledets' theorem that there exists Lyapunov exponents with respect to the measure μ . As the action of the Kontsevich-Zorich cocycle is symplectic, its Lyapunov exponents with respect to the measure μ are:

$$1 = \lambda_1^\mu > \lambda_2^\mu \geq \dots \geq \lambda_g^\mu \geq -\lambda_g^\mu \geq \dots \geq -\lambda_2^\mu > -\lambda_1^\mu = -1,$$

the inequality $\lambda_1^\mu > \lambda_2^\mu$ was proven in [15]. The measure μ is called *KZ-hyperbolic* if $\lambda_g^\mu > 0$. When $g = 2$, it follows from a result by Bainbridge² that:

Theorem 4.1 (Bainbridge). *If M is surface with genus $g = 2$ then for any probability measure μ on $\mathcal{M}^{(1)}(M)$ which is invariant for the Teichmüller flow and ergodic its second Lyapunov exponent λ_2 is strictly positive. Thus, μ is KZ-hyperbolic.*

If a measure μ is KZ-hyperbolic, by Oseledets' theorem, for μ -almost every $\omega \in \mathcal{M}^{(1)}(M)$ (such points will be called Oseledets regular points), the fiber $H^1(M_\omega, \mathbb{R})$ of the bundle $\mathcal{H}^1(M, \mathbb{R})$ at ω has a direct splitting

$$H^1(M_\omega, \mathbb{R}) = E_\omega^+(M, \mathbb{R}) \oplus E_\omega^-(M, \mathbb{R}),$$

where the *unstable space* $E_\omega^+(M, \mathbb{R})$ (the *stable space* $E_\omega^-(M, \mathbb{R})$ resp.) is the subspace of cohomology classes with positive (negative resp.) Lyapunov exponents, i.e.

$$(4.3) \quad \begin{aligned} E_\omega^+(M, \mathbb{R}) &= \left\{ c \in H^1(M_\omega, \mathbb{R}) : \lim_{t \rightarrow +\infty} \frac{1}{t} \log \|c\|_{G_{-t}\omega} < 0 \right\}, \\ E_\omega^-(M, \mathbb{R}) &= \left\{ c \in H^1(M_\omega, \mathbb{R}) : \lim_{t \rightarrow +\infty} \frac{1}{t} \log \|c\|_{G_t\omega} < 0 \right\}. \end{aligned}$$

²In [4] Bainbridge actually computes the explicit value of λ_2 for any μ probability measure invariant for the Teichmüller flow in the genus two strata $\mathcal{H}(2)$ and $\mathcal{H}(1, 1)$. The positivity of the second exponent for $g = 2$ also follows by the thesis of Aulicino [1], in which it is shown that no $SL(2, \mathbb{R})$ -orbit in $\mathcal{H}(1, 1)$ or $\mathcal{H}(2)$ has completely degenerate spectrum.

Let μ be an $SL(2, \mathbb{R})$ -invariant probability measure which is ergodic for the Teichmüller flow and let \mathcal{L}_μ be the support of μ , which is an $SL(2, \mathbb{R})$ -invariant closed subset of $\mathcal{M}^{(1)}(M)$. Let \mathbb{F} be a field (we will deal only with fields \mathbb{R} and \mathbb{Q}). Let us consider vector subbundles \mathcal{K}^1 of the cohomology bundle (respectively, vector subbundles of the homology bundle \mathcal{K}_1) defined over \mathcal{L}_μ . Each such a subbundle is determined by a collection of subfibers of the cohomology (or homology) fibers over \mathcal{L}_μ , that is $\mathcal{K}^1 = \bigcup_{\omega \in \mathcal{L}_\mu} \{\omega\} \times K^1(\omega)$, where $K^1(\omega) \subset H^1(M_\omega, \mathbb{F})$ is a linear subspace (respectively $\mathcal{K}_1 = \bigcup_{\omega \in \mathcal{L}_\mu} \{\omega\} \times K_1(\omega)$, where $K_1(\omega) \subset H_1(M_\omega, \mathbb{F})$). We will call a subbundle \mathcal{K}^1 (\mathcal{K}_1) of this form an *invariant subbundle* over \mathcal{L}_μ if:

- (i) $K^1(g \cdot \omega) = K^1(\omega)$ ($K_1(g \cdot \omega) = K_1(\omega)$) for every $g \in SL(2, \mathbb{R})$ and $\omega \in \mathcal{L}_\mu$;
- (ii) if $\omega_1, \omega_2 \in \mathcal{Q}^{(1)}(M)$ are two representatives of the same point $\omega_1 \Gamma = \omega_2 \Gamma \in \mathcal{L}_\mu$ and $\phi \in \Gamma(M)$ is an element of the mapping-class group such that $\phi^*(\omega_1) = \omega_2$ then $\phi^* K^1(\omega) = K^1(\omega)$ ($\phi_* K_1(\omega) = K_1(\omega)$).

Moreover, we say that an invariant subbundle \mathcal{K}^1 (\mathcal{K}_1) is (locally) constant if the map $\omega \mapsto K^1(\omega)$ ($\omega \mapsto K_1(\omega)$) is (locally) constant.

For any cohomological invariant subbundle \mathcal{K}^1 with $K^1(\omega) \subset H^1(M, \mathbb{R})$ for $\omega \in \mathcal{L}_\mu$ one can consider the Kontsevich-Zorich cocycle $(G_t^{KZ})_{t \in \mathbb{R}}$ restricted to the subbundle \mathcal{K}^1 over the Teichmüller flow on \mathcal{L}_μ . The Lyapunov exponents of the reduced cocycle $(G_t^{KZ, \mathcal{K}^1})_{t \in \mathbb{R}}$ with respect to the measure μ will be called *the Lyapunov exponents of the subbundle \mathcal{K}^1* .

A splitting $\{H^1(M_\omega, \mathbb{F}) = K^1(\omega) \oplus K_\perp^1(\omega), \omega \in \mathcal{L}_\mu\}$ (respectively $\{H_1(M_\omega, \mathbb{F}) = K_1(\omega) \oplus K_\perp^1(\omega), \omega \in \mathcal{L}_\mu\}$) is called an *orthogonal invariant splitting* if both corresponding subbundles $\mathcal{K}^1 = \bigcup_{\omega \in \mathcal{L}_\mu} \{\omega\} \times K^1(\omega)$ and $\mathcal{K}_\perp^1 = \bigcup_{\omega \in \mathcal{L}_\mu} \{\omega\} \times K_\perp^1(\omega)$ (respectively \mathcal{K}_1 and \mathcal{K}_\perp^1) are invariant and $K^1(\omega), K_\perp^1(\omega)$ (respectively $K_1(\omega), K_\perp^1(\omega)$) are orthogonal with respect to the symplectic form $\langle \cdot, \cdot \rangle$ for every $\omega \in \mathcal{L}_\mu$.

Let $\{H^1(M_\omega, \mathbb{R}) = K^1(\omega) \oplus K_\perp^1(\omega), \omega \in \mathcal{L}_\mu\}$ be an orthogonal invariant splitting. Since the Poincaré duality $\mathcal{P} : H_1(M, \mathbb{R}) \rightarrow H^1(M, \mathbb{R})$ intertwines the intersection forms $\langle \cdot, \cdot \rangle$ on $H_1(M, \mathbb{R})$ and $H^1(M, \mathbb{R})$ respectively, one also has a dual invariant orthogonal splitting given fiberwise by

$$H_1(M_\omega, \mathbb{R}) = K_1(\omega) \oplus K_\perp^1(\omega) \text{ with } K_1(\omega) := \mathcal{P}^{-1} K^1(\omega), K_\perp^1(\omega) := \mathcal{P}^{-1} K_\perp^1(\omega).$$

The Lyapunov exponents of the reduced cocycle $(G_t^{KZ, \mathcal{K}^1})_{t \in \mathbb{R}}$ with respect to the measure μ will be also called the Lyapunov exponents of \mathcal{K}_1 .

For any $\omega \in \mathcal{M}^{(1)}(M)$ denote by $H_{st}^1(M_\omega, \mathbb{R})$ the subspace of $H^1(M, \mathbb{R})$ generated by $[\Re(\omega)]$ and $[\Im(\omega)]$. Set

$$H_{(0)}^1(M_\omega, \mathbb{R}) := H_{st}^1(M_\omega, \mathbb{R})^\perp = \{c \in H^1(M_\omega, \mathbb{R}) : \forall c' \in H_{st}^1(M_\omega, \mathbb{R}) \langle c, c' \rangle = 0\}.$$

Then one has the following orthogonal invariant splitting

$$\{H^1(M_\omega, \mathbb{R}) = H_{st}^1(M_\omega, \mathbb{R}) \oplus H_{(0)}^1(M_\omega, \mathbb{R}), \omega \in \mathcal{M}^{(1)}(M)\},$$

Let \mathcal{H}_1^{st} (where *st* stays for *standard*) and $\mathcal{H}_1^{(0)}$ (also known as *reduced Hodge bundle*) be the corresponding subbundles. The Lyapunov exponents of the subbundle $\mathcal{H}_1^{(0)}$ are exactly $\{\pm \lambda_2^\mu, \dots, \pm \lambda_g^\mu\}$ (see the proof of Corollary 2.2 in [15]). Correspondingly, one also has also the dual orthogonal invariant splitting

$$\begin{aligned} \{H_1(M, \mathbb{R}) &= H_1^{st}(M_\omega, \mathbb{R}) \oplus H_1^{(0)}(M_\omega, \mathbb{R}), \omega \in \mathcal{M}^{(1)}(M)\}, \text{ where} \\ H_1^{(0)}(M_\omega, \mathbb{R}) &= \{\sigma \in H_1(M, \mathbb{R}) : \int_\sigma c = 0 \text{ for all } c \in H_{st}^1(M_\omega, \mathbb{R})\}; \\ H_1^{st}(M_\omega, \mathbb{R}) &= \{\sigma \in H_1(M, \mathbb{R}) : \langle \sigma, \sigma' \rangle = 0 \text{ for all } \sigma' \in H_1^{(0)}(M_\omega, \mathbb{R})\}. \end{aligned}$$

Coboundaries and unstable space. If μ is a KZ-hyperbolic probability measure on $\mathcal{M}^{(1)}(M)$, on a full measure set of Oseledets regular $\omega \in \mathcal{M}(M)$ one can relate coboundaries for the vertical flow with the stable space $E_{\omega}^{-}(M, \mathbb{R})$ of the Kontsevich-Zorich cocycle as stated in Theorem 4.2 below.

Recall that given a smooth bounded function $f : M \setminus \Sigma \rightarrow \mathbb{R}$ we denote by F_f^{θ} the cocycle over the directional flow $(\varphi_t^{\theta})_{t \in \mathbb{R}}$ given by

$$F_f^{\theta}(t, x) := \int_0^t f(\varphi_s^{\theta} x) ds, \quad x \in M_{\theta}, \quad t \in \mathbb{R}.$$

Theorem 4.2. *Let μ be any $SL(2, \mathbb{R})$ -invariant probability measure on $\mathcal{M}^{(1)}(M)$ ergodic for the Teichmüller flow. There exists a set $\mathcal{M}' \subset \mathcal{M}^{(1)}(M)$ with $\mu(\mathcal{M}') = 1$, such that any $\omega \in \mathcal{M}'$ is Oseledets regular and for any smooth closed form $\rho \in \Omega^1(M)$, if $[\rho] \in E_{\omega}^{-}(M, \mathbb{R})$, then the cocycle F_f^v with $f := i_{X_v} \rho$ for the vertical flow $(\varphi_t^v)_{t \in \mathbb{R}}$ is a coboundary.*

Moreover, if we assume in addition that μ is KZ-hyperbolic, we also have, conversely, that if $[\rho] \notin E_{\omega}^{-}(M, \mathbb{R})$, then F_f^v is not a coboundary for the vertical flow $(\varphi_t^v)_{t \in \mathbb{R}}$.

The main technical tools to prove Theorem 4.2 are essentially present in the literature³. For completeness, in the Appendix A we include a self-contained proof of Theorem 4.2. In the same Appendix we also prove the following Lemma, which is used in the proof of Theorem 4.2 and that will also be used in the proof of non-regularity in Section 7.

Lemma 4.3. *Let μ be any $SL(2, \mathbb{R})$ -invariant probability measure on $\mathcal{M}^{(1)}(M)$ ergodic for the Teichmüller flow. Then for μ -almost every $\omega \in \mathcal{M}^{(1)}(M)$, there exists a sequence of times $(t_k)_{k \in \mathbb{N}}$ with $t_k \rightarrow +\infty$, $m \in \mathbb{N}$, a constant $c > 1$ and a sequence $\{\gamma_1^{(k)}, \dots, \gamma_m^{(k)}\}_{k \in \mathbb{N}}$ of elements of $H_1(M, \mathbb{Z})$ such that, for any $\rho \in H^1(M, \mathbb{R})$ one has*

$$(4.4) \quad \frac{1}{c} \|\rho\|_{G_{t_k} \omega} \leq \max_{1 \leq j \leq m} \left| \int_{\gamma_j^{(k)}} \rho \right| \leq c \|\rho\|_{G_{t_k} \omega}.$$

5. VEECH SURFACES AND SQUARE-TILED SURFACES

The *affine group* $\text{Aff}(M, \omega)$ of (M, ω) is the group of orientation preserving homeomorphisms of M and preserving Σ which are given by affine maps in regular adopted coordinates. The set of differentials of these maps is denoted by $SL(M, \omega)$ and it is a subgroup of $SL(2, \mathbb{R})$. A translation surface (M, ω) is called a *lattice surface* (or a *Veech surface*) if $SL(M, \omega) \subset SL(2, \mathbb{R})$ is a lattice.

If (M, ω_0) is a lattice surface, the $SL(2, \mathbb{R})$ -orbit of (M, ω_0) in $\mathcal{M}^{(1)}(M)$, which will be denoted by \mathcal{L}_{ω_0} , is closed and can be identified with the homogeneous space $SL(2, \mathbb{R})/SL(M, \omega_0)$. The identification is given by the map $\Phi : SL(2, \mathbb{R}) \rightarrow \mathcal{L}_{\omega_0} \subset \mathcal{M}^{(1)}(M)$ that sends $g \in SL(2, \mathbb{R})$ to $g \cdot \omega_0 \in \mathcal{L}_{\omega_0}$, whose kernel is exactly the Veech group $SL(M, \omega_0)$. Thus Φ can be treated a map from $SL(2, \mathbb{R})/SL(M, \omega_0)$ to \mathcal{L}_{ω_0} . Therefore, \mathcal{L}_{ω_0} carry a canonical $SL(2, \mathbb{R})$ -invariant measure μ_0 , which is the image of the Haar measure on $SL(2, \mathbb{R})/SL(M, \omega_0)$ by the map $\Phi : SL(2, \mathbb{R})/SL(M, \omega_0) \rightarrow$

³Theorem 4.2 could be deduced from the recent work of Forni in [16], in which much deeper and more technical results on the cohomological equation are proved. The crucial point in the proof of Theorem 4.2 is the control on deviations of ergodic averages from the stable space, which first appears in the work by Zorich [45] in the special case in which μ is the canonical Masur-Veech measure on a stratum. Very recently, an adaptation of the proof of Zorich's deviation result for any $SL(2, \mathbb{R})$ -invariant measure has appeared in the preprint [12].

$\mathcal{M}^{(1)}(M)$. We will refer to μ_0 as the *canonical measure* on \mathcal{L}_{ω_0} . Since the homogeneous space $SL(2, \mathbb{R})/SL(M, \omega_0)$ is the unit tangent bundle of a surface of constant negative curvature, the (Teichmüller) geodesic flow on $SL(2, \mathbb{R})/SL(M, \omega_0)$ is ergodic. Thus, μ_0 is ergodic.

All *square-tiled* translation surfaces are examples of lattice surfaces. If (M, ω_0) is square-tiled, the Veech group $SL(M, \omega_0)$ is indeed a finite index subgroup of $SL(2, \mathbb{Z})$. Let (M, ω_0) be square-tiled and let $p : M \rightarrow \mathbb{R}^2/\mathbb{Z}^2$ be a ramified cover unramified outside $0 \in \mathbb{R}^2/\mathbb{Z}^2$ such that $\omega_0 = p^*(dz)$. Set $\Sigma' = p^{-1}(\{0\})$. For i -th square of (M, ω_0) , let $\sigma_i, \zeta_i \in H_1(M, \Sigma', \mathbb{Z})$ be the relative homology class of the path in the i -th square from the bottom left corner to the bottom right corner and to the upper left corner, respectively. Let $\sigma = \sum \sigma_i \in H_1(M, \mathbb{Z})$ and $\zeta = \sum \zeta_i \in H_1(M, \mathbb{Z})$.

Proposition 5.1 (see [34]). *The space $H_1^{(0)}(M_\omega, \mathbb{R})$ is the kernel of the homomorphism $p_* : H_1(M, \mathbb{R}) \rightarrow H_1(\mathbb{R}^2/\mathbb{Z}^2, \mathbb{R})$. Moreover, $H_1^{st}(M_\omega, \mathbb{R}) = \mathbb{R}\sigma \oplus \mathbb{R}\zeta$.*

Remark 5.2. Let $H_1^{(0)}(M, \mathbb{Q})$ stand for the kernel of $p_* : H_1(M, \mathbb{Q}) \rightarrow H_1(\mathbb{R}^2/\mathbb{Z}^2, \mathbb{Q})$ and let $H_1^{st}(M, \mathbb{Q}) := \mathbb{Q}\sigma \oplus \mathbb{Q}\zeta$. In view of Proposition 5.1,

$$H_1(M, \mathbb{Q}) = H_1^{(0)}(M, \mathbb{Q}) \oplus H_1^{st}(M, \mathbb{Q})$$

is an orthogonal decomposition. Since $H_1^{(0)}(M, \mathbb{Q})$ is invariant under the action on mapping-class group on $\mathcal{L}_{\omega_0} = SL(2, \mathbb{R}) \cdot \omega_0 \subset \mathcal{Q}^{(1)}(M)$, this yields the following orthogonal invariant splitting, which is constant on \mathcal{L}_{ω_0} :

$$\{H_1(M_\omega, \mathbb{Q}) = H_1^{(0)}(M, \mathbb{Q}) \oplus H_1^{st}(M, \mathbb{Q}), \omega \in \mathcal{L}_{\omega_0}\}.$$

Note that for every $\gamma \in H_1(M, \mathbb{R})$ the holonomy $\text{hol}(\gamma) = \int_\gamma \omega$ satisfies

$$\text{hol}(\gamma) = \int_\gamma p^* dz = \int_{p_* \gamma} dz.$$

Since $\Re dz$ and $\Im dz$ generate $H^1(\mathbb{R}^2/\mathbb{Z}^2, \mathbb{R})$, $\text{hol}(\gamma) = 0$ implies $p_* \gamma = 0$. Thus $\ker \text{hol} \subset H_1^{(0)}(M, \mathbb{R})$. Moreover, since both spaces have codimension two, the previous inclusion is an equality:

$$(5.1) \quad \ker(\text{hol}) = H_1^{(0)}(M, \mathbb{R}).$$

6. NON-ERGODICITY

In this section we state and prove our main criterion for non-ergodicity.

Theorem 6.1. *Let μ be an $SL(2, \mathbb{R})$ -invariant probability measure on $\mathcal{M}^1(M)$ ergodic for the Teichmüller flow. Let $\mathcal{L} \subset \mathcal{M}^{(1)}(M)$ stand for the support of μ . Assume that*

$$\{H_1(M_\omega, \mathbb{Q}) = K_1 \oplus K_1^\perp, \omega \in \mathcal{L}\}$$

is an invariant orthogonal splitting which is constant on \mathcal{L} . Let $\mathcal{K}_1 = \bigcup_{\omega \in \mathcal{L}} \{\omega\} \times K_1$ denote the corresponding invariant subbundle. Suppose that $\dim_{\mathbb{Q}} \mathcal{K}_1 = 2$ and the Lyapunov exponents of the Kontsevich-Zorich cocycle on $\mathbb{R} \otimes_{\mathbb{Q}} \mathcal{K}_1$ are non-zero.

Then, for μ almost every $\omega \in \mathcal{L}$, for any \mathbb{Z} -cover $(\widetilde{M}_\gamma, \widetilde{\omega}_\gamma)$ of (M, ω) given by a homology class $\gamma \in K_1 \cap H_1(M, \mathbb{Z})$, the vertical flow $(\widetilde{\varphi}_t^v)_{t \in \mathbb{R}}$ on $(\widetilde{M}_\gamma, \widetilde{\omega}_\gamma)$ is not ergodic.

As a Corollary of the previous theorem, in this section we also prove the following.

Corollary 6.2. *Let (M, ω_0) be a square-tiled compact translation surface of genus 2 and let μ_0 be the canonical measure on the $SL(2, \mathbb{R})$ -orbit of (M, ω_0) (see §5). For μ_0 -almost every (M, ω) the vertical flow of each recurrent \mathbb{Z} -cover $(\widetilde{M}, \widetilde{\omega})$ is not ergodic.*

Before giving the proof of Theorem 6.1 and Corollary 6.2, we state and prove an auxiliary Lemma. Let \mathcal{L}, μ and K_1, K_1^\perp be as in the assumptions of Theorem 6.1. Remark that since $\{H_1(M_\omega, \mathbb{R}) = (\mathbb{R} \otimes_{\mathbb{Q}} K_1) \oplus (\mathbb{R} \otimes_{\mathbb{Q}} K_1^\perp), \omega \in \mathcal{L}\}$ is an orthogonal splitting, by Poincaré duality, we also have a dual constant orthogonal invariant splitting

$$(6.1) \quad \{H^1(M_\omega, \mathbb{R}) = K^1 \oplus K_1^\perp, \omega \in \mathcal{L}\}, \quad K^1 := \mathcal{P}(\mathbb{R} \otimes_{\mathbb{Q}} K_1), \quad K_1^\perp := \mathcal{P}(\mathbb{R} \otimes_{\mathbb{Q}} K_1^\perp).$$

Lemma 6.3. *Let $\omega \in \mathcal{L}$ be Oseledets regular for μ for which the conclusion of Lemma 4.3 holds. Let $\rho \in K^1 \subset H^1(M, \mathbb{R})$ be such that $\rho \in E_\omega^-(M, \mathbb{R}) \setminus \{0\}$. For any \mathbb{Q} -basis $\{\sigma_1, \sigma_2\} \subset H_1(M, \mathbb{Z})$ of K_1 the periods $(\int_{\sigma_1} \rho, \int_{\sigma_2} \rho) \in \mathbb{R}^2$ do not belong to $\mathbb{R} \cdot (\mathbb{Q} \times \mathbb{Q})$.*

Proof. First note that $(\int_{\sigma_1} \rho, \int_{\sigma_2} \rho) \neq (0, 0)$. Indeed, if $\int_{\sigma_1} \rho = \int_{\sigma_2} \rho = 0$ then $\langle \mathcal{P}\sigma, \rho \rangle = \int_\sigma \rho = 0$ for every $\sigma \in \mathbb{R} \otimes_{\mathbb{Q}} K_1$. By the definition of K^1 , it follows that the symplectic form is degenerated on K^1 , which is a contradiction.

Denote by $p_{K_1} : H_1(M, \mathbb{Q}) \rightarrow K_1$ the orthogonal projection. Since the splitting is over \mathbb{Q} , by writing the image by p_{K_1} of each element of a basis of $H_1(M, \mathbb{Z})$ as a linear combination over \mathbb{Q} of σ_1, σ_2 , one can show that there exists $q \in \mathbb{N}$ (the least common multiple of the denominators) such that

$$(6.2) \quad p_{K_1}(H_1(M, \mathbb{Z})) \subset (\mathbb{Z}\sigma_1 \oplus \mathbb{Z}\sigma_2)/q.$$

Suppose that, contrary to the claim in the Lemma, $(\int_{\sigma_1} \rho, \int_{\sigma_2} \rho) \in \mathbb{R} \cdot (\mathbb{Q} \times \mathbb{Q})$. Then there exists $a \in \mathbb{R} \setminus \{0\}$ such that $\int_{\sigma_1} \rho, \int_{\sigma_2} \rho \in a\mathbb{Z}$. Thus, since $\rho \in K_1$, by the definition of K^1 and (6.2), for every $\sigma \in H_1(M, \mathbb{Z})$ we have

$$(6.3) \quad \int_\sigma \rho = \int_{p_{K_1}\sigma} \rho \in \frac{1}{q} \left(\mathbb{Z} \int_{\sigma_1} \rho + \mathbb{Z} \int_{\sigma_2} \rho \right) \in \frac{a}{q} \mathbb{Z}.$$

By Lemma 4.3 (which we can apply by assumption), there exists a constant $c > 0$, a sequence of times $(t_k)_{k \in \mathbb{N}}, t_k \rightarrow +\infty$ and a sequence $\{\gamma_1^{(k)}, \dots, \gamma_m^{(k)}\}_{k \in \mathbb{N}} \subset H_1(M, \mathbb{Z})$, such that

$$(6.4) \quad 0 < \frac{1}{c} \|\rho\|_{G_{t_k}\omega} \leq \widehat{\rho}_k := \max_{1 \leq j \leq m} \left| \int_{\gamma_j^{(k)}} \rho \right| \leq c \|\rho\|_{G_{t_k}\omega} \text{ for any } k \in \mathbb{N},$$

Thus, by (6.3), $\widehat{\rho}_k \in \frac{a}{q} \mathbb{Z} \setminus \{0\}$ for every natural k . On the other hand, since $\rho \in E_\omega^-(M, \mathbb{R})$, $\|\rho\|_{G_{t_k}\omega} \rightarrow 0$ as $k \rightarrow \infty$. In view of (6.4), $\widehat{\rho}_k \rightarrow 0$ as $k \rightarrow \infty$, which gives a contradiction. \square

Proof of Theorem 6.1. Let \mathcal{L}' be the set of Oseledets regular $\omega \in \mathcal{L}$ for which the conclusion of Theorem 4.2 and Lemma 4.3 hold and, in addition, for which the vertical and the horizontal flows on (M, ω) are ergodic. In view of Theorem 4.2, Lemma 4.3 and [32], $\mu(\mathcal{L}') = 1$. For any $\omega \in \mathcal{L}'$ let us consider a \mathbb{Z} -cover $(\widetilde{M}, \widetilde{\omega})$ of (M, ω) associated to a non-trivial homology class $\gamma \in H_1(M, \mathbb{Z}) \cap K_1$.

Consider the invariant orthogonal splitting of cohomology in (6.1). By assumption, the Lyapunov exponents of the reduced Kontsevich-Zorich cocycle $(G_t^{KZ, \mathcal{K}^1})_{t \in \mathbb{R}}$ are non-zero. Since the cocycle $(G_t^{KZ, \mathcal{K}^1})_{t \in \mathbb{R}}$ preserves the symplectic structure on \mathcal{K}^1 given by the intersection form, it follows that the exponents of the subbundle \mathcal{K}^1 are one positive and one negative. Thus, the stable space $E_\omega^-(M, \mathbb{R})$ intersects K^1 exactly in a one dimensional space. Let $\rho \in \Omega^1(M)$ be a smooth closed form such that $[\rho] \in E_\omega^-(M, \mathbb{R}) \cap K^1$.

Let $\{\sigma_1, \sigma_2\} \subset H_1(M, \mathbb{Z})$ be a \mathbb{Q} -basis of K_1 such that $\sigma_1 = \gamma$ and choose any \mathbb{Q} -basis $\{\sigma_3, \dots, \sigma_{2g}\} \subset H_1(M, \mathbb{Z})$ of K_1^\perp . Clearly, $\{\sigma_1, \dots, \sigma_{2g}\} \subset H_1(M, \mathbb{Z})$ is a \mathbb{Q} -basis of $H_1(M, \mathbb{Q})$. By Lemma 6.3, the periods $\Upsilon([\rho]) = (\int_{\sigma_1} \rho, \int_{\sigma_2} \rho)$ do not

belong to $\mathbb{R} \cdot (\mathbb{Q} \times \mathbb{Q})$. Therefore, $\int_{\sigma_1} \rho \neq 0 \neq \int_{\sigma_2} \rho$ and $\int_{\sigma_1} \rho / \int_{\sigma_2} \rho \in \mathbb{R} \setminus \mathbb{Q}$. Thus, since $\langle \gamma, \sigma_2 \rangle = \langle \sigma_1, \sigma_2 \rangle \in \mathbb{Z} \setminus \{0\}$, up to multiplying ρ by a non-zero real constant (more precisely, by $\langle \gamma, \sigma_2 \rangle / \int_{\sigma_2} \rho$), we can assume that

$$(6.5) \quad \Upsilon([\rho]) = (\alpha, \langle \gamma, \sigma_2 \rangle), \quad \text{where } \alpha \in \mathbb{R} \setminus \mathbb{Q}.$$

Choose a transverse horizontal interval $I \subset M$ and let $T : I \rightarrow I$ be the IET obtained as Poincaré return map and let $I_j, j \in \mathcal{A} = \{1, \dots, m\}$, be the exchanged subintervals. Then the homology classes $\gamma_j, j \in \mathcal{A}$ generates $H_1(M, \mathbb{Z})$ (as in §2.1, $\gamma_j = [v_x]$ where v_x is obtained by closing up the first return trajectory of the vertical flow $(\varphi_t^v)_{t \in \mathbb{R}}$ of any $x \in I_j$ by a horizontal interval). Since the vertical flow $(\varphi_t^v)_{t \in \mathbb{R}}$ on (M, ω) is ergodic, T is ergodic as well. By Lemma 2.1, the vertical flow $(\tilde{\varphi}_t^v)$ on $(\tilde{M}, \tilde{\omega})$ is isomorphic to a special flow built over the skew product $T_\psi : I \times \mathbb{Z} \rightarrow I \times \mathbb{Z}$, where $\psi = \psi_\gamma$ is given by

$$(6.6) \quad \psi_\gamma(x) = \langle \gamma, \gamma_j \rangle \quad \text{if } x \in I_j.$$

Let us consider the smooth bounded function $f : M \setminus \Sigma \rightarrow \mathbb{R}, f = i_{X_v} \rho$ and let $\psi_\rho : I \rightarrow \mathbb{R}$ be the corresponding cocycle for T defined by $\psi_\rho(x) = \int_0^{\tau(x)} f(\varphi_s^v x) ds$. By Theorem 4.2, since $[\rho] \in E_\omega^-(M, \mathbb{R})$, the cocycle F_f^v for the vertical flow $(\varphi_t^v)_{t \in \mathbb{R}}$ is a coboundary and thus, equivalently, by Lemma 3.8, the cocycle ψ_ρ is a coboundary for T as well. Let $\gamma' := \mathcal{P}^{-1}[\rho] \in \mathbb{R} \otimes_{\mathbb{Q}} K_1$ be the Poincaré dual of $[\rho] \in K^1$. In view of Remark 3.9, the cocycle $\psi_{\gamma'} : I \rightarrow \mathbb{R}$ given by

$$(6.7) \quad \psi_{\gamma'}(x) = \langle \gamma', \gamma_j, \rangle \quad \text{whenever } x \in I_j$$

is cohomologous to $-\psi_\rho$ and thus it is also a coboundary.

Clearly $\psi : I \rightarrow \mathbb{Z}$ can be considered as cocycle taking values in \mathbb{R} for the automorphism T . Then the group of essential values $E_{\mathbb{R}}(\psi) = E_{\mathbb{Z}}(\psi)$ of this cocycle is a subgroup of \mathbb{Z} . Let us consider the cocycle $\phi : I \rightarrow \mathbb{R}$ given by $\phi := \psi + \psi_{\gamma'}$. In view of (6.6) and (6.7),

$$(6.8) \quad \phi(x) = \langle \gamma, \gamma_j \rangle + \langle \gamma', \gamma_j \rangle = \langle \gamma + \gamma', \gamma_j \rangle \quad \text{if } x \in I_j.$$

Since $\sigma_1, \dots, \sigma_{2g} \in H_1(M, \mathbb{Z})$ form a basis of $H_1(M, \mathbb{Q})$, there exists a natural number M and an $m \times 2g$ -matrix $A = [a_{ji}]$ (of rank $2g$) with integer entries such that

$$\gamma_j = \frac{1}{M} \sum_{i=1}^{2g} a_{ji} \sigma_i \quad \text{for } j = 1, \dots, m.$$

Since $\gamma + \gamma' \in \mathbb{R} \otimes_{\mathbb{Q}} K_1$ and $\sigma_3, \dots, \sigma_{2g} \in K_1^\perp$ are symplectic orthogonal to the subspace $\mathbb{R} \otimes_{\mathbb{Q}} K_1$, we have

$$\langle \gamma + \gamma', \gamma_j \rangle = \frac{1}{M} (a_{j1} \langle \gamma + \gamma', \sigma_1 \rangle + a_{j2} \langle \gamma + \gamma', \sigma_2 \rangle) \quad \text{for } j = 1, \dots, m.$$

Thus, from (6.8), it follows that, for any $1 \leq j \leq m$ and any $x \in I_j$, we have

$$\phi(x) = \langle \gamma + \gamma', \gamma_j \rangle = \frac{1}{M} (a_{j1} \langle \gamma + \gamma', \sigma_1 \rangle + a_{j2} \langle \gamma + \gamma', \sigma_2 \rangle).$$

Since $[\rho] = \mathcal{P}\gamma'$, in view of (4.2) and (6.5),

$$\langle \langle \gamma', \sigma_1 \rangle, \langle \gamma', \sigma_2 \rangle \rangle = - \left(\int_{\sigma_1} \rho, \int_{\sigma_2} \rho \right) = -\Upsilon([\rho]) = -(\alpha, \langle \gamma, \sigma_2 \rangle)$$

with $\alpha \in \mathbb{R} \setminus \mathbb{Q}$. Hence, since $\sigma_1 = \gamma$, $\langle \gamma + \gamma', \sigma_1 \rangle = -\alpha$ and $\langle \gamma + \gamma', \sigma_2 \rangle = 0$. Therefore,

$$\phi(x) = -\frac{a_{j1}}{M} \alpha \quad \text{if } x \in I_j.$$

Thus, since $\phi(x)$ is an integer multiple of $\bar{\alpha} := \alpha/M \notin \mathbb{Q}$ for any $x \in I$, the cocycle $\phi : I \rightarrow \mathbb{R}$ takes values in $\bar{\alpha}\mathbb{Z}$, hence $E_{\mathbb{R}}(\phi) \subset \bar{\alpha}\mathbb{Z}$ (see Proposition 3.1). Since ψ

is cohomologous to ϕ , it follows from Proposition 3.1 that $E_{\mathbb{R}}(\psi) = E_{\mathbb{R}}(\phi) \subset \overline{\alpha\mathbb{Z}}$. As $E_{\mathbb{R}}(\psi) = E_{\mathbb{Z}}(\psi) \subset \mathbb{Z}$ and $\overline{\alpha\mathbb{Z}} \cap \mathbb{Z} = \{0\}$, we get $E_{\mathbb{Z}}(\psi) = E_{\mathbb{R}}(\psi) = \{0\}$. By Proposition 3.2, $T_{\psi} : I \times \mathbb{Z} \rightarrow I \times \mathbb{Z}$ is not ergodic. In view of Remark 2.2, it follows that the vertical flow $(\tilde{\varphi}_t^v)_{t \in \mathbb{R}}$ is not ergodic. \square

Proof of Corollary 6.2. Let (M, ω_0) be a square-tiled translation surface of genus two. Let μ_0 be the canonical probability measure on \mathcal{L}_{ω_0} (the $SL(2, \mathbb{R})$ -orbit of (M, ω_0) in $\mathcal{M}^1(M)$), which is ergodic (see §5) and KZ hyperbolic by Theorem 4.1 (since M has genus two). Let $K_1 = H_1^{(0)}(M, \mathbb{Q})$ and $K_1^{\perp} = H_1^{st}(M, \mathbb{Q})$ (see §5). The subspace K_1 is the kernel of the homomorphism $p_* : H_1(M, \mathbb{Q}) \rightarrow H_1(\mathbb{R}^2/\mathbb{Z}^2, \mathbb{Q})$ and, in view of (5.1), it is the kernel of $\text{hol} : H_1(M, \mathbb{Q}) \rightarrow \mathbb{C}$. Remark that since M has genus two, $\dim_{\mathbb{Q}} H_1(M, \mathbb{R}) = 4$ and $\dim_{\mathbb{Q}} K_1 = 2$.

By Remark 5.2, $\{H_1(M_{\omega}, \mathbb{Q}) = K_1 \oplus K_1^{\perp}, \omega \in \mathcal{L}_{\omega_0}\}$ is an invariant splitting which is constant over \mathcal{L}_{ω_0} . Hence, we can apply Theorem 6.1. The conclusion follows by remarking that, in view of (5.1), the recurrent \mathbb{Z} -covers are exactly the \mathbb{Z} -covers $(\tilde{M}_{\gamma}, \tilde{\omega}_{\gamma})$ given by $\gamma \in H_1^{(0)}(M, \mathbb{Q}) \cap H_1(M, \mathbb{Z}) = K_1 \cap H_1(M, \mathbb{Z})$. \square

7. NON-REGULARITY

In this section, we prove the following Theorem:

Theorem 7.1. *Let μ be any $SL(2, \mathbb{R})$ -invariant, KZ-hyperbolic probability ergodic measure on $\mathcal{M}^{(1)}(M)$. For μ -almost every (M, ω) the vertical flow of each \mathbb{Z} -cover $(\tilde{M}_{\gamma}, \tilde{\omega}_{\gamma})$ given by a non-zero $\gamma \in H_1(M, \mathbb{Z})$ has no invariant subset of positive finite measure.*

Theorem 7.1 is derived from Theorem 4.2 and Lemma 7.2 stated below, via the representation of directional flows on \mathbb{Z} -cover as special flows over skew-products.

Lemma 7.2. *Let μ be an $SL(2, \mathbb{R})$ -invariant probability measure on $\mathcal{M}^{(1)}(M)$ ergodic for the Teichmüller flow. For each non-zero $\gamma \in H_1(M, \mathbb{Z})$ and for μ -a.e $\omega \in \mathcal{M}^{(1)}(M)$ the Poincaré dual class $\mathcal{P}\gamma$ does not belong to the stable space $E_{\omega}^{-}(M, \mathbb{R})$.*

Proof. Consider any Oseledets regular $\omega \in \mathcal{M}^{(1)}(M)$ in the set of μ full measure given by Lemma 4.3 and let $(t_k)_{k \in \mathbb{N}}, \{\gamma_1^{(k)}, \dots, \gamma_m^{(k)}\} \subset H_1(M, \mathbb{Z})$ and $c > 0$ be given by Lemma 4.3. Then, by Poincaré duality, Lemma 4.3 applied to $\mathcal{P}\gamma \neq 0$ gives that

$$(7.1) \quad 0 < \hat{\gamma}_k := \max_{1 \leq j \leq m} |\langle \gamma_j^{(k)}, \gamma \rangle| = \max_{1 \leq j \leq m} \left| \int_{\gamma_j^{(k)}} \mathcal{P}\gamma \right| \leq c \|\mathcal{P}\gamma\|_{\mathcal{G}_{t_k \omega}}$$

for every $k \in \mathbb{N}$. Therefore, $\hat{\gamma}_k$ is a natural number for any $k \in \mathbb{N}$. If $\mathcal{P}\gamma \in E_{\omega}^{-}(M, \mathbb{R})$, by definition of the stable space (see (4.3)), the RHS of (7.1) tends to zero as $k \rightarrow \infty$, hence $\hat{\gamma}_k \rightarrow 0$ as $k \rightarrow \infty$, which gives a contradiction. We conclude that $\mathcal{P}\gamma$ does not belong to $E_{\omega}^{-}(M, \mathbb{R})$. \square

Proof of Theorem 7.1. Let $\mu \in \mathcal{M}^{(1)}$ belong to the set of full μ measure given by Lemma 7.2 and let $(\tilde{M}, \tilde{\omega}) = (\tilde{M}_{\gamma}, \tilde{\omega}_{\gamma})$ for some non-zero $\gamma \in H_1(M, \mathbb{Z})$. By Lemma 2.1, the vertical flow $(\tilde{\varphi}_t^v)_{t \in \mathbb{R}}$ has a representation as a special flow build over the skew product $T_{\psi} : I \times \mathbb{Z} \rightarrow I \times \mathbb{Z}$, where $\psi(x) = \langle \gamma, \gamma_{\alpha} \rangle$ if $x \in I_{\alpha}$, $\alpha \in \mathcal{A}$ and under a roof function which takes finitely many positive values. Thus, the flow $(\tilde{\varphi}_t^v)_{t \in \mathbb{R}}$ has invariant subsets of finite positive measure if and only if the skew product T_{ψ} has. In view of Proposition 3.3, this happens if and only if the cocycle $\psi : I \rightarrow \mathbb{Z}$ for the IET T is a coboundary. Thus, it is enough to show that $\psi : I \rightarrow \mathbb{Z}$ is not a coboundary.

Suppose that, contrary to our claim, $\psi : I \rightarrow \mathbb{Z}$ is a coboundary. Choose a smooth closed form $\rho \in \Omega^1(M)$ such that $[\rho] = \mathcal{P}\gamma$. Let us consider the cocycle $F_{i_{X_v}\rho}^v$ for the flow $(\varphi_t^v)_{t \in \mathbb{R}}$ and the corresponding cocycle $\psi_\rho : I \rightarrow \mathbb{R}$ for T (see the definition in Remark 3.9). By Remark 3.9, the cocycle ψ_ρ is cohomologous to the cocycle $-\psi$, so also ψ_ρ is a coboundary. In view of Lemma 3.8, it follows that also $F_{i_{X_v}\rho}^v$ is a coboundary. Since μ is KZ-hyperbolic, by the second part of Theorem 4.2, $\mathcal{P}\gamma = [\rho] \in E_\omega^-(M, \mathbb{R})$. On the other hand, by Lemma 7.2, $\mathcal{P}\gamma \notin E_\omega^-(M, \mathbb{R})$, which is a contradiction. \square

Corollary 7.3. *Let μ be any $SL(2, \mathbb{R})$ -invariant, ergodic, KZ-hyperbolic finite measure on $\mathcal{M}^{(1)}(M)$ and let $H_1(M, \mathbb{Q}) = K_1 \oplus K_1^\perp$ be a decompositions satisfying the assumption of Theorem 6.1. Then for μ -almost every (M, ω) and every non-zero $\gamma \in K_1 \cap H_1(M, \mathbb{Z})$ the vertical flow of the \mathbb{Z} -cover $(\widetilde{M}_\gamma, \widetilde{\omega}_\gamma)$ is not ergodic and it has uncountably many ergodic components and it has no invariant subset of positive finite measure.*

Proof. The absence of invariant subsets of positive finite measure follow directly from Theorem 7.1. By the proof of Theorems 6.1 and 7.1, for μ -almost every $\omega \in \mathcal{M}^{(1)}(M)$ and every non-zero $\gamma \in K_1 \cap H_1(M, \mathbb{Z})$ the vertical flow on $(\widetilde{M}_\gamma, \widetilde{\omega}_\gamma)$ has a special representation over a skew product $T_\psi : I \times \mathbb{Z} \rightarrow I \times \mathbb{Z}$ such that $E_{\mathbb{Z}}(\psi) = \{0\}$ and ψ is not a coboundary. In view of Proposition 3.2, $\overline{E}_{\mathbb{Z}}(\psi) = \{0, \infty\}$, so the cocycle ψ is non-regular. By Corollary 3.5, the skew product and hence (by the reduction in §2.1) also the vertical flow on $(\widetilde{M}_\gamma, \widetilde{\omega}_\gamma)$ have uncountably many ergodic components. \square

8. FINAL ARGUMENTS

In this section we conclude the proofs of the main results stated in the Introduction, that is Theorem 1.1 (see §8.2), Theorem 1.2 and Corollary 1.3 (see §8.3) and Theorem 1.4 and Corollary 1.5 (see §8.1). The arguments are essentially based on a Fubini-type arguments. In §8.1 we first present a simple Fubini argument which holds in the case of lattice surfaces (Proposition 8.1) and can be used to prove Theorem 1.4 and parts (1) of Theorem 1.1 and (1), (2) of Theorem 1.2. The other parts of Theorem 1.1 and 1.5 require a different type of Fubini argument, presented in §8.2 and §8.3 respectively.

8.1. A Fubini argument for lattice surfaces. In this section we prove the following Proposition and then use it to prove Theorem 1.4 and Corollary 1.5.

Proposition 8.1. *Let (M, ω_0) be a lattice surface and μ_0 be the canonical measure on its $SL(2, \mathbb{R})$ -orbit \mathcal{L}_{ω_0} . Fix a non-zero $\gamma \in H_1(M, \mathbb{Z})$. Assume that for μ_0 -almost every $\omega \in \mathcal{L}_{\omega_0}$ the vertical flow $(\widetilde{\varphi}_t^v)_{t \in \mathbb{R}}$ on $(\widetilde{M}_\gamma, \widetilde{\omega}_\gamma)$ satisfy one (or more) of the following properties:*

- (P-1) *is not ergodic;*
- (P-2) *has uncountably many ergodic components;*
- (P-3) *has no invariant sets of finite measure.*

Then for almost every $\theta \in S^1$, the directional flow $(\widetilde{\varphi}_t^\theta)_{t \in \mathbb{R}}$ on $(\widetilde{M}_\gamma, (\widetilde{\omega}_0)_\gamma)$ also satisfy the same property (P-1), (P-2), or (P-3).

Let us first state to elementary Lemmas useful in the proofs. For every $g \in SL(2, \mathbb{R})$ and $\theta \in S^1$ let us denote by $g \cdot \theta \in S^1$ the action of $SL(2, \mathbb{R})$ on S^1 determined by $e^{ig \cdot \theta} = g(e^{i\theta})/|g(e^{i\theta})|$.

Lemma 8.2. *Let (M, ω) be a translation surface (not necessary compact). Then for every $g \in SL(2, \mathbb{R})$ and $\theta \in S^1$ there exists $s > 0$ such that the directional flows $(\varphi_{st}^{g \cdot \theta})_{t \in \mathbb{R}}$ on $(M, g \cdot \omega)$ and $(\varphi_t^\theta)_{t \in \mathbb{R}}$ on (M, ω) are measure-theoretically isomorphic.*

Proof. Let $s = s(g, \theta) := |g(e^{i\theta})|$. We claim that $sX_{g \cdot \omega}^{g \cdot \theta} = X_\omega^\theta$. Indeed

$$i_{sX_{g \cdot \omega}^{g \cdot \theta}} \omega = sg^{-1}(i_{X_{g \cdot \omega}^{g \cdot \theta}} g \cdot \omega) = sg^{-1}(e^{ig \cdot \theta}) = g^{-1}(|g(e^{i\theta})|e^{ig \cdot \theta}) = g^{-1} \circ g(e^{i\theta}) = e^{i\theta}$$

and since X_ω^θ is defined by $i_{X_\omega^\theta} \omega = e^{i\theta}$, this proves the claim. From the claim, we also have $\varphi_{st}^{g \cdot \omega, g \cdot \theta} = \varphi_t^{\omega, \theta}$ for every $t \in \mathbb{R}$. Since moreover, $\nu_{g \cdot \omega} = \nu_\omega$, the Lemma follows. \square

Lemma 8.3. *For every $\gamma \in H_1(M, \mathbb{Z})$ and $g \in SL(2, \mathbb{R})$ we have $(\widetilde{M}_\gamma, \widetilde{g \cdot \omega}_\gamma) = (\widetilde{M}_\gamma, g \cdot \widetilde{\omega}_\gamma)$.*

Proof. Denote by $p : \widetilde{M}_\gamma \rightarrow M$ the covering map. It is enough to remark that for every $g \in SL(2, \mathbb{R})$ we get $\widetilde{g \cdot \omega}_\gamma = p^*(g \cdot \omega) = g \cdot \omega \circ p_* = g \cdot p^*(\omega) = g \cdot \widetilde{\omega}_\gamma$. \square

Proof of Proposition 8.1. To avoid undue repetition, we will write that a directional flow satisfies (P-i) for $i \in \{1, 2, 3\}$, where (P-i) could be any of the three properties (P-1), (P-2) or (P-3) in the statement of the Lemma. The same proof indeed applies for all three properties. Since (M, ω_0) a lattice surface, we recall (see §5) that the $SL(2, \mathbb{R})$ -orbit of (M, ω_0) (denoted by \mathcal{L}_{ω_0}) is closed in $\mathcal{M}^{(1)}(M)$ and can be identified to $SL(2, \mathbb{R})/SL(M, \omega_0)$ by the map $\Phi : SL(2, \mathbb{R})/SL(M, \omega_0) \rightarrow \mathcal{L}_{\omega_0}$ that sends $gSL(M, \omega_0) \in SL(2, \mathbb{R})/SL(M, \omega_0)$ to $g \cdot \omega_0 \in \mathcal{L}_{\omega_0}$. Denote by μ_0 the canonical measure on \mathcal{L}_{ω_0} .

Using the Iwasawa NAK decomposition, if we denote as usual by

$$g_t = \begin{pmatrix} e^t & 0 \\ 0 & e^{-t} \end{pmatrix}, \quad h_s = \begin{pmatrix} 1 & 0 \\ s & 1 \end{pmatrix}, \quad \rho_\theta = \begin{pmatrix} \cos \theta & -\sin \theta \\ \sin \theta & \cos \theta \end{pmatrix}$$

we can choose an open neighbourhood $\mathcal{U} \subset \mathcal{L}_0$ of ω_0 of the form

$$\mathcal{U} = \{\omega \in \mathcal{L}_0 : \omega = h_s g_t \rho_\theta \cdot \omega_0 \text{ where } (t, s, \theta) \in (-\epsilon, \epsilon)^2 \times S^1\}$$

for some $\epsilon > 0$. By assumption, for μ_0 -a.e. $\omega \in \mathcal{U}$, the vertical flow $(\widetilde{\varphi}_t^v)_{t \in \mathbb{R}}$ on $(\widetilde{M}_\gamma, \widetilde{\omega}_\gamma)$ satisfies (P-i). Moreover, since μ_0 is the pull-back by Φ of the Haar measure on $SL(2, \mathbb{R})/SL(M, \omega_0)$ which is locally equivalent to the product Lebesgue measure in the coordinates (t, s, θ) , it follows that for Lebesgue almost every $(t, s, \theta) \in (-\epsilon, \epsilon)^2 \times S^1$, the vertical flow $(\widetilde{\varphi}_t^v)_{t \in \mathbb{R}}$ on $(\widetilde{M}_\gamma, (h_s g_t \rho_\theta \cdot \omega_0)_\gamma)$, which by Lemma 8.3 is metrically isomorphic to $(\widetilde{M}_\gamma, h_s g_t \rho_\theta \cdot (\omega_0)_\gamma)$, also satisfies (P-i).

Denote by $S_0 \subset S^1$ the subset of all $\theta \in S^1$ for which the directional flow $\widetilde{\varphi}_t^\theta$ on $(\widetilde{M}_\gamma, (\omega_0)_\gamma)$ does not satisfy (P-i). By Lemma 8.2, if $\theta \in S_0$ then also the vertical flow $\widetilde{\varphi}_t^v$ on $(\widetilde{M}_\gamma, \rho_{\pi/2-\theta} \cdot (\omega_0)_\gamma)$ does not satisfy (P-i). Moreover, since the vertical direction $\pi/2 \in S^1$ is fixed both by h_s and g_t , i.e. $h_s \cdot \frac{\pi}{2} = \frac{\pi}{2}$ and $g_t \cdot \frac{\pi}{2} = \frac{\pi}{2}$ for any $s, t \in \mathbb{R}$, Lemma 8.2 also implies that the flow $\widetilde{\varphi}_t^v$ on $(\widetilde{M}_\gamma, h_s g_t \rho_{\pi/2-\theta} \cdot (\omega_0)_\gamma)$ does not satisfy (P-i) for all $(t, s) \in (-\epsilon, \epsilon)^2$. It follows that for every $(t, s, \theta) \in (-\epsilon, \epsilon)^2 \times (\pi/2 - S_0)$ the vertical flow $\widetilde{\varphi}_t^v$ on $(\widetilde{M}_\gamma, h_s g_t \rho_\theta \cdot (\omega_0)_\gamma)$ does not satisfy (P-i). Therefore the set $(-\epsilon, \epsilon)^2 \times (\pi/2 - S_0)$ has zero Lebesgue measure and hence S_0 has zero Lebesgue measure. Thus, we conclude that for any \mathbb{Z} -cover $(\widetilde{M}_\gamma, (\omega_0)_\gamma)$ of (M, ω_0) given by a non-zero $\gamma \in K_1 \cap H_1(M, \mathbb{Z})$, for almost every $\theta \in S^1$, the directional flow $(\widetilde{\varphi}_t^\theta)_{t \in \mathbb{R}}$ on $(\widetilde{M}_\gamma, (\omega_0)_\gamma)$ satisfies (P-i). \square

Proof of Theorem 1.4. Let (M, ω_0) is a square-tiled surface of genus 2. The canonical probability measure μ_0 on \mathcal{L}_{ω_0} is ergodic (see §5) and, by Theorem 4.1, is KZ-hyperbolic. Moreover, setting $K_1 = H_1^{(0)}(M, \mathbb{Q})$ and $K_1^\perp = H_1^{st}(M, \mathbb{Q})$ (see §5), one can check, as in the proof of Corollary 6.2, that the assumptions of Theorem 6.1 hold and that, in view of (5.1), the recurrent \mathbb{Z} -covers are exactly the \mathbb{Z} -covers $(\widetilde{M}_\gamma, \widetilde{\omega}_\gamma)$ given by $\gamma \in K_1 \cap H_1(M, \mathbb{Z})$. Thus, by Corollary 7.3, for μ_0 -almost every $\omega \in \mathcal{L}_{\omega_0}$, for any recurrent \mathbb{Z} -cover $(\widetilde{M}_\gamma, \widetilde{\omega}_\gamma)$ of (M, ω) given by a non-zero γ the vertical flow $(\widetilde{\varphi}_t^v)_{t \in \mathbb{R}}$ on $(\widetilde{M}_\gamma, \widetilde{\omega}_\gamma)$ is not ergodic and has no invariant set of finite measure and has uncountably many ergodic components. Thus, the claim follows from Proposition 8.1. \square

Proof of Corollary 1.5. Denote by $Z_{(3,0)}$ the square-tiled translation surface corresponding to the polygon drawn in Figure 4(b) with edges labeled by the same letter identified by translations. One can verify that $Z_{(3,0)} \in \mathcal{H}(2)$. Consider the homology class $\gamma = [B] - [D]$ which is non trivial but has trivial holonomy. One can check that the \mathbb{Z} -cover of $Z_{(3,0)}$ associated to γ gives exactly the infinite staircase translation surface $Z_{(3,0)}^\infty$. Thus, Theorem 1.4 applied to this surface shows that the directional flow on $Z_{(3,0)}^\infty$ is not ergodic and has no invariant set of finite measure for almost every direction. \square

Remark 8.4. A similar proof shows that any surface in the family $Z_{(a,b)}^\infty$ with $(a, b) \in \mathbb{N}^2$, $b > 2$, described by Hubert-Schmithüsen in [27] satisfy the same conclusion of Corollary 1.5.

8.2. Non-ergodicity for billiards in the infinite strip.

Proof of Theorem 1.1. Let us consider the billiard flow on the table $T(l)$ in Figure 1. Denote by Γ the 4-elements group of isometries of S^1 generated by the reflections $\theta \mapsto -\theta$, $\theta \mapsto \pi - \theta$. Using the unfolding process described in [28] (see for example [33]), one can verify that, for every direction $\theta \in S^1$ the flow $(b_t^\theta)_{t \in \mathbb{R}}$ is isomorphic to the directional flow $(\widetilde{\varphi}_t^\theta)_{t \in \mathbb{R}}$ on a non-compact translation surface $(\widetilde{M}, \widetilde{\omega}_l)$, where $(\widetilde{M}, \widetilde{\omega}_l)$ is the translation surface resulting from gluing, along segments with the same name, four copies of $T(l)$, one for each element of Γ , according to the action of Γ , as shown in the Figure 6. The surface $(\widetilde{M}, \widetilde{\omega}_l)$ can be represented as gluing

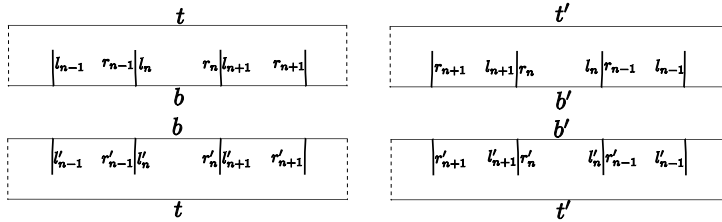

FIGURE 6

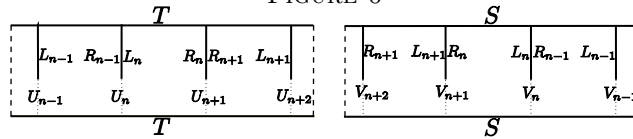

FIGURE 7

two \mathbb{Z} -periodic polygons, as shown in the Figure 7, where $R_n = r_n \cup r'_n$ and $L_n = l_n \cup l'_n$. Let us cut these polygons along the segments marked as U_n, V_n , $n \in \mathbb{Z}$, to

obtain rectangles P_n, P'_n and let us glue P_n and P'_n along the segment R_n (see the Figure 8). It follows that $(\widetilde{M}, \widetilde{\omega}_l)$ is a \mathbb{Z} -cover of the compact translation surface

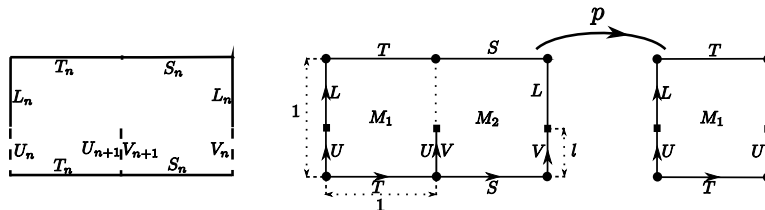

FIGURE 8

(M, ω_l) presented in the Figure 8. More precisely, $(\widetilde{M}, \widetilde{\omega}_l) = (\widetilde{M}_\gamma, (\widetilde{\omega}_l)_\gamma)$, where $\gamma = [V - U]$ has trivial holonomy.

(1) *Case l rational.* One can verify that for any $l \in (0, 1)$, $(M, \omega_l) \in \mathcal{H}(1, 1)$, thus, in particular, M has genus 2. The assumption that $l \in \mathbb{Q}$ guarantees that (M, ω_l) is square-tiled. Thus, in this case we can apply Theorem 1.4 that implies that for almost every $\theta \in S^1$ the directional flow $(\widetilde{\varphi}_t^\theta)_{t \in \mathbb{R}}$ on $(\widetilde{M}, \widetilde{\omega}_l)$ and hence the billiard flow $(b_t^\theta)_{t \in \mathbb{R}}$ on $T(l)$ is not ergodic, has no invariant sets of finite measure and has uncountably many ergodic components.

(2) *Full measure set of values of the parameter l .* Let us remark that (M, ω_l) can be obtained from two identical copies $(M_1, \omega_l^1), (M_2, \omega_l^2)$ (corresponding to the two rectangles in Figure 8) of a genus 1 translation surface with a slit (i.e. a straight segment connecting two marked points), by identifying each side of the slit in (M_1, ω_l^1) with the opposite side of the slit in (M_2, ω_l^2) . In particular, this shows that (M, ω_l) is a *branched 2-cover of the torus* (M_1, ω_l^1) with covering map given by the projection $p : M \rightarrow M_1$. Denote by $\tau : M \rightarrow M$ the only non-trivial element of the deck group of the covering $p : M \rightarrow M_1 \approx \mathbb{T}^2$. Denote by \mathcal{L} the locus

$$\{\omega \in \mathcal{H}^{(2)}(1, 1) : \tau^* \omega = \omega\}.$$

Equivalently, $\omega \in \mathcal{L}$ if and only if $\omega = p^* \omega_0$ for some $\omega_0 \in \mathcal{H}^{(1)}(0, 0)$, where $\mathcal{H}^{(1)}(0, 0)$ is the stratum of a genus one translation surface with two marked points. Therefore, \mathcal{L} is the 2-cover of the moduli space stratum $\mathcal{H}^{(1)}(0, 0)$ and therefore \mathcal{L} has dimension five, which is the dimension of $\mathcal{H}^{(1)}(0, 0)$. Moreover, \mathcal{L} carries a natural $SL(2, \mathbb{R})$ -invariant measure $\mu_{\mathcal{L}}$, which is simply the pull-back of the canonical measure on the stratum $\mathcal{H}^{(1)}(0, 0)$ via the covering map p . Let us consider the decomposition $H_1(M, \mathbb{Q}) = K_1 \oplus K_1^\perp$, where

$$K_1 := \{\gamma \in H_1(M, \mathbb{Q}) : \tau_* \gamma = -\gamma\} \text{ and } K_1^\perp := \{\gamma \in H_1(M, \mathbb{Q}) : \tau_* \gamma = \gamma\}.$$

This is an orthogonal decomposition. Indeed, if $\gamma_1 \in K_1$ and $\gamma_2 \in K_1^\perp$ then

$$\langle \gamma_1, \gamma_2 \rangle = \langle \tau_* \gamma_1, \tau_* \gamma_2 \rangle = -\langle \gamma_1, \gamma_2 \rangle \implies \langle \gamma_1, \gamma_2 \rangle = 0.$$

Moreover, $\dim_{\mathbb{Q}} K_1 = \dim_{\mathbb{Q}} K_1^\perp = 2$. Remark that the homology class $\gamma = [V - U]$ which determines the \mathbb{Z} -cover $(\widetilde{M}, \widetilde{\omega}_l)$ belongs to K_1 .

Let $p_* : H_1(M, \mathbb{Q}) \rightarrow H_1(\mathbb{T}^2, \mathbb{Q})$ be the action induced on \mathbb{Q} -homology by the covering map $p : M \rightarrow M_1$. If $\tau_* \gamma = -\gamma$ then $-p_* \gamma = p_* \tau_* \gamma = (p \circ \tau)_* \gamma = p_* \gamma$, hence K_1 is a subspace of the kernel $\ker_{\mathbb{Q}} p_*$. Since $\dim_{\mathbb{Q}} K_1 = 2 = \dim_{\mathbb{Q}} \ker_{\mathbb{Q}} p_*$, we have $K_1 = \ker_{\mathbb{Q}} p_*$. Let $\phi \in \Gamma(M)$ an element of the mapping-class group such that $\omega_2 = \phi^* \omega_1$ for $\omega_1 \Gamma(M) = \omega_2 \Gamma(M) \in \mathcal{L}$. Then there exists $\phi_0 \in \Gamma(M_1)$ such that $p \circ \phi = \phi_0 \circ p$. It follows that $p_* \gamma = 0$ implies $p_*(\phi_* \gamma) = (\phi_0)_*(p_* \gamma) = 0$, so

$\phi_* K_1 = K_1$. Since K_1^\perp is the symplectic orthocomplement of K_1 in $H_1(M, \mathbb{Q})$, we obtain $\phi_* K_1^\perp = K_1^\perp$. Consequently,

$$\{H_1(M_\omega, \mathbb{Q}) = K_1 \oplus K_1^\perp, \omega \in \mathcal{L}\}$$

is an orthogonal invariant splitting which is constant on \mathcal{L} . Let \mathcal{K}_1 and \mathcal{K}_1^\perp be the associated invariant subbundles over \mathcal{L} .

Since the canonical measure on $\mathcal{H}^{(1)}(0, 0)$ is ergodic for the Teichmüller flow (see [31]) and \mathcal{L} is a connected cover of $\mathcal{H}^{(1)}(0, 0)$ whose covering map is equivariant with respect to the $SL(2, \mathbb{R})$ -action, it follows (for example by the Hopf argument) that also the measure $\mu_{\mathcal{L}}$ on \mathcal{L} is ergodic for the Teichmüller flow. Thus, since $\mu_{\mathcal{L}}$ is an $SL(2, \mathbb{R})$ -invariant measure and ergodic for the Teichmüller flow on $\mathcal{H}(1, 1)$, which is a genus two stratum, $\mu_{\mathcal{L}}$ is KZ-hyperbolic (see Theorem 4.1). In particular, since there are no zero exponents, the Lyapunov exponents of the invariant subbundle $\mathbb{R} \otimes_{\mathbb{Q}} \mathcal{K}_1$ (see §5) are both non zero. Thus, \mathcal{L} , $\mu_{\mathcal{L}}$ and \mathcal{K}_1 satisfy all the assumptions of Theorem 6.1. It follows that for there exists a set $\mathcal{L}' \subset \mathcal{L}$ such that $\mu_{\mathcal{L}}(\mathcal{L}') = 1$ and for all $\omega \in \mathcal{L}'$ and all non-zero $\gamma \in K_1 \cap H_1(M, \mathbb{Q})$, the vertical flow $(\tilde{\varphi}_t^v)_{t \in \mathbb{R}}$ on $(\tilde{M}_\gamma, \tilde{\omega}_\gamma)$ is not ergodic, and by Corollary 7.3 that it has uncountably many ergodic components. Let us now show that this allows to deduce the desired conclusion by a Fubini argument.

Since \mathcal{L} is a 2-cover of $\mathcal{H}^{(1)}(0, 0)$, local coordinates on \mathcal{L} are given by the relative periods for the marked torus (M_1, ω_1^1) (see §5). We will deal with an open subset \mathcal{V} in \mathcal{L} constructed as follows. Denote by $\{\gamma_1, \gamma_2, \gamma_3\}$ the basis of $H_1(M_1, \Sigma_1, \mathbb{Z})$ given by $\gamma_1 = [U]$, $\gamma_2 = [U \cup L]$, $\gamma_3 = [T]$, see Figure 8. Then $\{\gamma_1, \gamma_2, \gamma_3, \tau_* \gamma_1, \tau_* \gamma_2, \tau_* \gamma_3\}$ is a family of generators of $H_1(M, \Sigma, \mathbb{Z})$. Let us consider

$$(8.1) \quad \begin{aligned} (x_1, x_2, x_3) &:= \left(\int_{\gamma_1} \Re \omega, \int_{\gamma_2} \Re \omega, \int_{\gamma_3} \Re \omega \right) = \left(\int_{\tau_* \gamma_1} \Re \omega, \int_{\tau_* \gamma_2} \Re \omega, \int_{\tau_* \gamma_3} \Re \omega \right), \\ (y_1, y_2, y_3) &:= \left(\int_{\gamma_1} \Im \omega, \int_{\gamma_2} \Im \omega, \int_{\gamma_3} \Im \omega \right) = \left(\int_{\tau_* \gamma_1} \Im \omega, \int_{\tau_* \gamma_2} \Im \omega, \int_{\tau_* \gamma_3} \Im \omega \right). \end{aligned}$$

Since we are considering abelian differentials of area 2, the coordinates (8.1) are not all independent ($x_2 y_3 - x_3 y_2 = 1$), but one of them, say y_3 , is determined by the area one requirement. Thus, $(\underline{x}, \underline{y}) := (x_1, x_2, x_3, y_1, y_2)$ are independent coordinates on a subset of \mathcal{L} and denote by $\omega(\underline{x}, \underline{y}) \in \mathcal{L}$ the corresponding differential. Then $\omega(0, 0, 1, l, 1) = \omega_l$ for every $l \in (0, 1)$. Denote by $\mathcal{V} \subset \mathcal{L}$ the open sets of all $\omega(\underline{x}, \underline{y}) \in \mathcal{L}$ with $x_1, x_2 \neq 0$.

Fix a non-zero $\gamma \in K_1 \cap H_1(M, \mathbb{Z})$. Recall that, in view of §2.1 (see Lemma 2.1 and choose I as at the end of §2.1 so that (2.6) holds), for every $\omega \in \mathcal{L}$ there exists a horizontal interval $I \subset M$ and $\gamma_\alpha \in H_1(M, \mathbb{Z})$, $\xi_\alpha \in H_1(M, \Sigma, \mathbb{Z})$ for $\alpha \in \mathcal{A}$ such that the vertical flow $(\tilde{\varphi}_t^v)_{t \in \mathbb{R}}$ on $(\tilde{M}_\gamma, \tilde{\omega}_\gamma)$ has a special representation built over the skew product $T_\psi : I \times \mathbb{R} \rightarrow I \times \mathbb{R}$ such that for every $\alpha \in \mathcal{A}$

$$\lambda_\alpha = \int_{\xi_\alpha} \Re \omega \text{ and } \psi(x) = \langle \gamma, \gamma_\alpha \rangle, \quad Tx = x + \int_{\gamma_\alpha} \Re \omega \text{ for } x \in I_\alpha.$$

For every $(M, \omega_0) \in \mathcal{V}$ we can choose a neighbourhood $\mathcal{U} \subset \mathcal{V}$ of ω_0 such that γ_α and ξ_α , for $\alpha \in \mathcal{A}$, do not depend on $\omega \in \mathcal{U}$.

Let us adopt the following convention: let us say that a flow has property (P-1) if it is not ergodic and property (P-2) if it has uncountably many ergodic components. We claim that, if $\omega_1 = \omega(\underline{x}_1, \underline{y}_1), \omega_2 = \omega(\underline{x}_2, \underline{y}_2) \in \mathcal{U}$ with $\underline{x}_1 = \underline{x}_2$, then the vertical flow $(\tilde{\varphi}_t^v)_{t \in \mathbb{R}}$ on $(\tilde{M}_\gamma(\omega_1)_\gamma)$ has property (P-i) for $i \in \{1, 2\}$ if and only if the vertical flow $(\tilde{\varphi}_t^v)_{t \in \mathbb{R}}$ on $(\tilde{M}_\gamma(\omega_2)_\gamma)$ has property (P-i). Indeed, if $\underline{x}_1 = \underline{x}_2$ then $\int_{\gamma_i} \Re \omega_1 = \int_{\gamma_i} \Re \omega_2$ and $\int_{\tau_* \gamma_i} \Re \omega_1 = \int_{\tau_* \gamma_i} \Re \omega_2$ for $i = 1, 2, 3$. Thus $\int_{\gamma_\alpha} \Re \omega_1 =$

$\int_{\gamma_\alpha} \mathfrak{R}\omega_2, \int_{\xi_\alpha} \mathfrak{R}\omega_1 = \int_{\xi_\alpha} \mathfrak{R}\omega_2$ for all $\alpha \in \mathcal{A}$. It follows that both vertical flows have special representations built over the same skew product, which proves our claim.

Let us consider the diffeomorphism $\Upsilon : (0, 1) \times ((0, 2\pi) \setminus \{\pi/2, \pi, 3\pi/2\}) \times \mathbb{R}^3 \rightarrow \mathbb{R}^5$

$$\Upsilon(l, \theta, t, y_1, y_2) = (-e^t l \cos \theta, -e^t \cos \theta, e^t \sin \theta, e^{-t}(y_1 + l \sin \theta), e^{-t}(y_2 + \sin \theta)).$$

The diffeomorphism Υ is defined so that we have

$$g_t \rho_{\pi/2-\theta} \omega_l = \omega(\Upsilon(l, \theta, t, 0, 0)), \quad \forall l \in [0, 1], \theta \in S^1, t \in \mathbb{R}.$$

Denote by $\mathcal{V}_0 \subset (0, 1) \times ((0, 2\pi) \setminus \{\pi/2, \pi, 3\pi/2\}) \times \mathbb{R} \times \mathbb{R}^2$ (respectively \mathcal{L}'_0) the preimage of \mathcal{V} (respectively \mathcal{L}') by the map $(l, \theta, t, \underline{y}) \mapsto \omega(\Upsilon(l, \theta, t, \underline{y}))$ and by μ_0 the pullback of $\mu_{\mathcal{L}'}$ by this map. Since Υ is a diffeomorphism, the measure μ_0 is equivalent to the Lebesgue measure on \mathcal{V}_0 , hence $\mathcal{V}_0 \setminus \mathcal{L}'_0$ has zero Lebesgue measure.

For $i = 1, 2$, denote by $\neg\mathcal{P}_i \subset (0, 1) \times ((0, 2\pi) \setminus \{\pi/2, \pi, 3\pi/2\})$ the set of all (l, θ) such that the directional flow $(\tilde{\varphi}_t^\theta)_{t \in \mathbb{R}}$ on $(\widetilde{M}_\gamma, (\omega_l)_\gamma)$ does not have property (P-i). We claim that $\neg\mathcal{P}_i$ has zero Lebesgue measure. In fact, we need to show that for every $(l, \theta) \in \neg\mathcal{P}_i$ there exists a neighbourhood $(l, \theta) \in \mathcal{U}$ such that $\neg\mathcal{P}_i \cap \mathcal{U}$ has zero Lebesgue measure.

Fix $(l_0, \theta_0) \in \neg\mathcal{P}_i$. By Lemmas 8.3 and 8.2, $(\tilde{\varphi}_t^v)_{t \in \mathbb{R}}$ on $(\widetilde{M}_\gamma, (\rho_{\pi/2-\theta_0} \cdot \omega_{l_0})_\gamma)$ is metrically isomorphic to $(\tilde{\varphi}_{st}^{\theta_0})_{t \in \mathbb{R}}$ on $(\widetilde{M}_\gamma, (\omega_{l_0})_\gamma)$ for some $s > 0$, and hence also does *not* have property (P-i). Since $\rho_{\pi/2-\theta_0} \cdot \omega_{l_0} \in \mathcal{V}$, there exists a neighbourhood of $\rho_{\pi/2-\theta_0} \cdot \omega_{l_0} \in \mathcal{U}$ such that for all $\omega(\underline{x}_1, \underline{y}_1), \omega(\underline{x}_2, \underline{y}_2) \in \mathcal{U}$ with $\underline{x}_1 = \underline{x}_2$ the vertical flows on $(\widetilde{M}_\gamma, (\omega_1)_\gamma)$ and $(\widetilde{M}_\gamma, (\omega_2)_\gamma)$ have special representations over the same skew product. Let $\mathcal{U}_1 \ni (l, \theta), (-\varepsilon, \varepsilon)$ and $\mathcal{U}_2 \ni (0, 0)$ be neighbourhoods such that $\Upsilon(\mathcal{U}_1 \times (-\varepsilon, \varepsilon) \times \mathcal{U}_2) \subset \mathcal{U}$. We claim that

$$(8.2) \quad (\neg\mathcal{P}_i \cap \mathcal{U}_1) \times (-\varepsilon, \varepsilon) \times \mathcal{U}_2 \cap \mathcal{L}'_0 = \emptyset.$$

Indeed, if $(l, \theta) \in \neg\mathcal{P}_i \cap \mathcal{U}_1$ then $(\tilde{\varphi}_t^v)_{t \in \mathbb{R}}$ on $(\widetilde{M}_\gamma, (\rho_{\pi/2-\theta} \cdot \omega_l)_\gamma)$ does not have property (P-i). Moreover, $\rho_{\pi/2-\theta} \cdot \omega_l = \omega(\Upsilon(l, \theta, 0, 0, 0))$ and $\Upsilon(l, \theta, 0, 0, 0) \in \mathcal{U}$. Therefore, for every $\underline{y} \in \mathcal{U}_2$ the vertical flow on $(\widetilde{M}_\gamma, \omega(\Upsilon(l, \theta, 0, \underline{y})))_\gamma$ does not have property (P-i). Since every g_t fixes the vertical direction, by Lemmas 8.3 and 8.2, the vertical flow on $(\widetilde{M}_\gamma, (g_t \cdot \omega(\Upsilon(l, \theta, 0, \underline{y}))))_\gamma$ does not have property (P-i) for every $t \in (-\varepsilon, \varepsilon)$. Since $g_t \cdot \omega(\Upsilon(l, \theta, 0, \underline{y})) = \omega(\Upsilon(l, \theta, t, \underline{y}))$, it follows that the vertical flow on $(\widetilde{M}_\gamma, (\omega(\Upsilon(l, \theta, t, \underline{y}))))_\gamma$ does not have property (P-i) for every $(l, \theta, t, \underline{y}) \in (\neg\mathcal{P}_i \cap \mathcal{U}_1) \times (-\varepsilon, \varepsilon) \times \mathcal{U}_2 \subset \mathcal{V}_0$, which proves (8.2). In view of the fact that $\mathcal{V}_0 \setminus \mathcal{L}'_0$ has zero Lebesgue measure, the product set $(\neg\mathcal{P}_i \cap \mathcal{U}_1) \times (-\varepsilon, \varepsilon) \times \mathcal{U}_2$ and hence $\neg\mathcal{P}_i \cap \mathcal{U}_1$ has zero Lebesgue measure.

Thus, we conclude that for every non-zero $\gamma \in K_1 \cap H_1(M, \mathbb{Z})$ there exists a set $\Lambda \subset (0, 1)$ of full Lebesgue measure such that for every $l \in \Lambda$ for almost $\theta \in S^1$ the directional flow $(\tilde{\varphi}_t^\theta)_{t \in \mathbb{R}}$ on the \mathbb{Z} -cover $(\widetilde{M}_\gamma, (\omega_l)_\gamma)$ have both properties (P-1) and (P-2). This in particular applies to the \mathbb{Z} -cover that is given by $\gamma = [V - U] \in K_1$. Consequently, for any $l \in \Lambda$ the billiard flow $(b_t^\theta)_{t \in \mathbb{R}}$ on $T(l)$ is not ergodic and it has uncountably many ergodic components for almost every direction $\theta \in S^1$. \square

8.3. Non-ergodicity of the Erhenfest windtree model. Let us now prove Theorem 1.2 and Corollary 1.3.

Proof of Theorem 1.2. Let us consider the \mathbb{Z} -periodic Ehrenfest billiard flow $(e_t^\theta)_{t \in \mathbb{R}}$ on the tube $E_1(a, b)$ in Figure 3. Let us denote by Γ the 4-elements group of isometries of the plane generated by $\langle \tau^h, \tau^v \rangle$, where τ^h denotes the horizontal reflection

$(x, y) \mapsto (x, -y)$ and τ^v denotes the vertical reflection $(x, y) \mapsto (-x, y)$ (Γ is the Klein four-group $\mathbb{Z}_2 \times \mathbb{Z}_2$). By the unfolding process (see [28]), for every direction $\theta \in S^1$ the flow $(e_t^\theta)_{t \in \mathbb{R}}$ on $E_1(a, b)$ is isomorphic to the directional flow $(\tilde{\varphi}_t^\theta)_{t \in \mathbb{R}}$ on a non-compact translation surface $(\tilde{M}, \tilde{\omega}_{a,b})$ which is obtained by gluing four copies of $E_1(a, b)$, one for each element of the group Γ , according to action of Γ . This translation surface is a \mathbb{Z} -cover of a compact translation surface $(M, \omega_{a,b})$ shown in Figure 9 and the cover is given by $\sigma = v_{00} - v_{10} + v_{01} - v_{11} \in H_1(M, \mathbb{Z})$ (referring to the labelling of Figure 9). The surface M is glued from four copies of a fundamental domain $F(a, b) := E_1(a, b) \cap ([0, 1) \times (\mathbb{R}/\mathbb{Z}))$ for the natural \mathbb{Z} -action (generated by the translation by the vector $(1, 0)$) on the tube $E_1(a, b)$. Thus, if we denote by $(N, \nu_{a,b})$

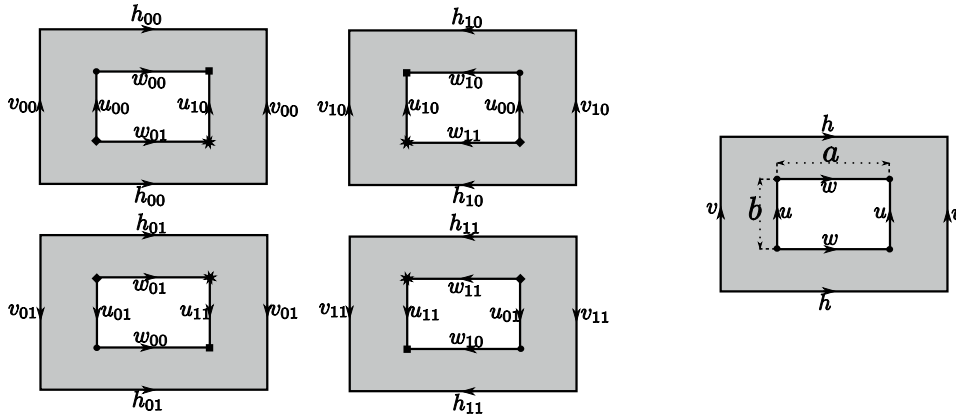

FIGURE 9. Translation surfaces $(M, \omega_{a,b})$ and $(N, \nu_{a,b})$

the translation surface obtained from the fundamental domain $F(a, b)$ gluing the sides according to the identifications in Figure 9, the translation surface $(M, \omega_{a,b})$ is a cover of $(N, \nu_{a,b})$ with the deck group Γ . Let us denote by $p : M \rightarrow N$ the covering map⁴. One can check that $(N, \nu_{a,b})$ has genus two and belongs to the stratum $\mathcal{H}(2)$, while $(M, \omega_{a,b})$ has genus 5 and belongs to $\mathcal{H}(2, 2, 2, 2)$. By abuse of notation, we continue to write $\omega_{a,b}$ for $\omega_{a,b}/A(\omega_{a,b}) = \omega_{a,b}/(4(1 - ab)) \in \mathcal{H}^{(1)}(2, 2, 2, 2)$. Let

$$\mathcal{L} = \left\{ \omega \in \mathcal{H}^{(1)}(2, 2, 2, 2) : \omega = \frac{1}{4} p^* \nu, \nu \in \mathcal{H}^{(1)}(2) \right\}.$$

Then \mathcal{L} is a closed $SL(2, \mathbb{R})$ -invariant subset of $\mathcal{H}^{(1)}(2, 2, 2, 2)$ which is a finite connected cover of $\mathcal{H}^{(1)}(2)$ and $\omega_{a,b} \in \mathcal{L}$. The orbit closures and the $SL(2, \mathbb{R})$ -invariant measures on $\mathcal{H}^{(1)}(2)$ were classified by McMullen in [35] and give a classification of orbit closures and the $SL(2, \mathbb{R})$ -invariant measures on \mathcal{L} . From [35] (see also [12]), it follows that if (a, b) satisfy assumption (1) or (2) in Theorem 1.2, $(M, \omega_{a,b})$ is a Veech surface and its $SL(2, \mathbb{R})$ -orbit is closed and carries the canonical $SL(2, \mathbb{R})$ -invariant measure. Let us consider the $SL(2, \mathbb{R})$ -invariant measure $\mu_{\mathcal{L}}$ on \mathcal{L} obtained by pull back by the finite covering map of the canonical measure on $\mathcal{H}^{(1)}(2)$. Since the canonical measure is ergodic and the cover \mathcal{L} is connected, each of these measures on \mathcal{L} is ergodic.

⁴We remark that this surface is the same that the surface is obtained by considering a fundamental domain for the \mathbb{Z}^2 -action on the planar billiard table $E_2(a, b)$, which is described in detail in [12] (see §3).

Let τ_*^h, τ_*^v be the maps induced on the homology $H_1(M, \mathbb{Z})$ by the actions of the reflections τ^h, τ^v on $(M, \omega_{a,b})$. Consider the following orthogonal decomposition

$$(8.3) \quad \begin{aligned} H_1(M, \mathbb{Q}) &= E^{++} \oplus E^{+-} \oplus E^{-+} \oplus E^{--}, \quad \text{where, for } s_0, s_1 \in \{+, -\}, \\ E^{s_0 s_1} &= \{\gamma \in H_1(M, \mathbb{Q}) : \tau_*^v(\gamma) = s_0 \gamma \text{ and } \tau_*^h(\gamma) = s_1 \gamma\}. \end{aligned}$$

Remark that (8.3) defines an invariant orthogonal splitting constant on \mathcal{L} .

One can check that the homology class σ which determines the \mathbb{Z} -cover $(\widetilde{M}, \widetilde{\omega}_{a,b})$ of $(M, \omega_{a,b})$ belongs to the subspace E^{-+} and that the space E^{-+} has dimension two (we refer for details to [12], see Lemma 3 and Lemma 4). Moreover, the Lyapunov exponents of the KZ cocycles for all the $SL(2, \mathbb{R})$ -invariant ergodic measures on \mathcal{L} were computed in [12] (in particular the exponents corresponding to E^{-+}) and turn out to be all non-zero.

Given any parameter $(a, b) \in (0, 1)^2$ let $\mu_{a,b}$ be the canonical measure for a Veech surface (see §5) if (a, b) satisfy the assumptions (1) or (2) or $\mu_{\mathcal{L}}$ otherwise. Then, all the assumptions of Theorem 6.1 are satisfied by taking $\mu := \mu_{a,b}$ and $K_1 := E^{-+}$. It follows from Corollary 7.3 that there exists a set \mathcal{L}' contained in the $SL(2, \mathbb{R})$ -orbit closure of $(M, \omega_{a,b})$ such that $\mu(\mathcal{L}') = 1$ and for all $\omega \in \mathcal{L}'$, for any \mathbb{Z} -cover $(\widetilde{M}_\gamma, \widetilde{\omega}_\gamma)$ with $\gamma \in E^{-+}$ the vertical flow $(\widetilde{\varphi}_t^v)_{t \in \mathbb{R}}$ is *not*-ergodic and it has uncountably many ergodic components.

If $(M, \omega_{a,b})$ is a Veech surface, that is for (a, b) as in (1) or (2), Proposition 8.1 allows to conclude the proof. Therefore, from now on we consider the case $\mu = \mu_{\mathcal{L}}$ and use a different Fubini argument to prove the conclusion of the Theorem for a full measure set of parameters (a, b) . The arguments are similar to the proof of Theorem 1.1 and also to the Fubini argument used by [12] in §6.

Let us consider local coordinates $(\underline{x}, \underline{y}) = (x_1, x_2, x_3, x_4, y_1, y_2, y_3, y_4)$ on \mathcal{L} given by period coordinates as follows

$$x_i = \int_{\gamma_{jk}^i} \Re \omega \quad \text{and} \quad y_i = \int_{\gamma_{jk}^i} \Im \omega \quad \text{for } i = 1, 2, 3, 4 \text{ and } j, k \in \{0, 1\},$$

where $\gamma_{jk}^1 = w_{jk}$, $\gamma_{jk}^2 = u_{jk}$, $\gamma_{jk}^3 = h_{jk}$, $\gamma_{jk}^4 = v_{jk}$ for $j, k \in \{0, 1\}$ is a family of generators in $H_1(M, \Sigma, \mathbb{Z})$. Since we are considering abelian differentials of *unit area*, the coordinates (8.1) are not all independent, but one of them, say y_4 , is determined by the area one requirement. Thus, $(\underline{x}, \underline{y}) := (x_1, x_2, x_3, x_4, y_1, y_2, y_3)$ are independent coordinates on a subset of \mathcal{L} . Let $\omega(\underline{x}, \underline{y})$ be the corresponding differential. Then $\omega(\frac{1}{4(1-ab)}(a, 0, 1, 0, 0, b, 0)) = \omega_{a,b}$ for every $(a, b) \in (0, 1)^2$. Let us consider the local diffeomorphism $\Upsilon : (0, 1)^2 \times ((0, 2\pi) \setminus \{\pi/2, \pi, 3\pi/2\}) \times \mathbb{R}^4 \rightarrow \mathbb{R}^7$,

$$\Upsilon(a, b, \theta, t, y_1, y_2, y_3) = \frac{1}{4(1-ab)}.$$

$$(e^t(a \sin \theta, -b \cos \theta, \sin \theta, -\cos \theta), e^{-t}(y_1 + a \cos \theta, y_2 + b \sin \theta, y_3 + \cos \theta)).$$

Then $g_t \rho_{\pi/2 - \theta} \omega_{a,b} = \omega(\Upsilon(a, b, \theta, t, 0, 0, 0))$ and the pullback of the measure $\mu_{\mathcal{L}}$ by the map $(a, b, \theta, t, \underline{y}) \mapsto \omega(\Upsilon(a, b, \theta, t, \underline{y}))$ is equivalent to the Lebesgue measure restricted to the domain of the map.

As in the proof of Theorem 1.1, let us say that a flow has property (P-1) if it is not ergodic and (P-2) if it has uncountably many ergodic components and let us denote by $\neg \mathcal{P}_i \subset (0, 1)^2 \times (0, 2\pi)$ the set of all (a, b, θ) such that the directional flow $(\widetilde{\varphi}_t^\theta)_{t \in \mathbb{R}}$ on $(\widetilde{M}_\sigma, (\omega_{a,b})_\sigma)$ does not have property (P-i) for $i = 1, 2$. The same argument as in the proof of Theorem 1.1 shows that for every $(a, b, \theta) \in \neg \mathcal{P}_i$ there exists neighbourhoods $\mathcal{U}_1 \ni (a, b, \theta)$, $\mathcal{U}_2 \subset \mathbb{R}^4$ such that for every $\omega \in \omega(\Upsilon((\neg \mathcal{P}_i \cap \mathcal{U}_1) \times \mathcal{U}_2))$ the vertical flow on $(\widetilde{M}_\sigma, \widetilde{\omega}_\sigma)$ does not have (P-i). Therefore the set $\omega(\Upsilon((\neg \mathcal{P}_i \cap \mathcal{U}_1) \times \mathcal{U}_2)) \subset \mathcal{L}$ has zero $\mu_{\mathcal{L}}$ measure. It follows that $(\neg \mathcal{P}_i \cap \mathcal{U}_1) \times \mathcal{U}_2$ and hence

$\neg\mathcal{P}_i \cap \mathcal{U}_1$ has zero Lebesgue measure. Thus, for $i \in \{1, 2\}$, $\neg\mathcal{P}_i \subset (0, 1)^2 \times (0, 2\pi)$ has zero Lebesgue measure. Consequently, for almost every $(a, b) \in (0, 1)^2$ for almost every θ the directional flow $(\tilde{\varphi}_t^\theta)_{t \in \mathbb{R}}$ on $(\widetilde{M}_\sigma, \widetilde{(\omega_{a,b})_\sigma})$ is not ergodic and has uncountably many ergodic components. \square

Proof of Corollary 1.3. Let us remark that the billiard flow $(e_t^\theta)_{t \in \mathbb{R}}$ on the planar Ehrenfest model $E_2(a, b)$ projects on the the billiard flow $(e_t^\theta)_{t \in \mathbb{R}}$ on the one-dimensional Ehrenfest table $E_1(a, b)$, via the map $\pi : \mathbb{R}^2 \rightarrow \mathbb{R} \times \mathbb{R}/\mathbb{Z}$ given by $\pi(x, y) = (x, y + \mathbb{Z})$. In other words, $(e_t^\theta)_{t \in \mathbb{R}}$ on $E_1(a, b)$ is a factor of $(e_t^\theta)_{t \in \mathbb{R}}$ on $E_2(a, b)$. It follows that if $(e_t^\theta)_{t \in \mathbb{R}}$ on $E_1(a, b)$ is not ergodic and has uncountably many ergodic components, also the flow $(e_t^\theta)_{t \in \mathbb{R}}$ on $E_{a,b}^2$ is not ergodic and has uncountably many ergodic components. Thus, Corollary 1.3 follows immediately from Theorem 1.2. \square

APPENDIX A. STABLE SPACE AND COBOUNDARIES.

In this Appendix we include for completeness the proof of Lemma 4.3 and Theorem 4.2 (see §4.3) along the lines of [45, 15] (see also [12]). Let us first introduce some notation and describe how to construct a section \mathcal{K} for the Teichmüller flow which will be useful in both proofs. Some of the properties of \mathcal{K} will not be used in the proof of Lemma 4.3, but only in the proof of Theorem 4.2.

A section for the Teichmüller geodesic flow. Let μ be any $SL(2, \mathbb{R})$ -invariant probability measure on the moduli space $\mathcal{M}^{(1)}(M)$ ergodic for the Teichmüller flow. Since μ is $SL(2, \mathbb{R})$ -invariant, we can assume that it is supported on a stratum $\mathcal{H}^{(1)} = \mathcal{H}^{(1)}(k_1, \dots, k_\kappa)$ for some k_1, \dots, k_κ . Let us remark that since μ is finite and ergodic for the Teichmüller flow, by Oseledets' theorem, μ -almost every $\omega \in \mathcal{H}^{(1)}$ is Oseledets regular for the Kontsevich-Zorich cocycle $(G_t^{KZ})_{t \in \mathbb{R}}$. Moreover, there exists a $(G_t)_{t \in \mathbb{R}}$ -invariant set $\mathcal{H}_0 \subset \mathcal{H}^{(1)}$ of μ -measure one such that each $\omega \in \mathcal{H}_0$ has no vertical and horizontal saddle connections and both the vertical and horizontal flow on (M, ω) are ergodic (see [32]).

Choose a point $\omega_0 \in \mathcal{H}_0$ which is Oseledets regular and in the support of the measure μ . Consider the vertical flow $(\varphi_t)_{t \in \mathbb{R}}$ on (M, ω_0) , where for brevity $\varphi_t := \varphi_t^{\omega_0, v}$. Let $M_{reg} = M_{reg, \omega_0}$ be the set of points which are regular both for the vertical and horizontal flow on (M, ω_0) (that, we recall, means that both flows are defined for all times). Remark that M_{reg} has full measure on M and is invariant under $(G_t)_{t \in \mathbb{R}}$, that is, $M_{reg, G_t \omega} = M_{reg}$ for all $t \in \mathbb{R}$. Choose also a regular point $p_0 \in M_{reg}$. The definition of the section \mathcal{K} depends on the choice of ω_0 and p_0 , but ω_0 and p_0 will play no role.

Let us denote by $I_{\omega_0}(p_0)$ the arc of the horizontal flow on (M, ω_0) of total length 1 centered at p_0 . For any $q \in I_{\omega_0}(p_0)$ let us denote by $\tau(\omega_0, q)$ the *first return time* of q to $I_{\omega_0}(p_0)$ under the vertical flow φ_t . The Poincaré map of the flow $(\varphi_t)_{t \in \mathbb{R}}$ to $I_{\omega_0} = I_{\omega_0}(p_0)$ is an IET that we will denote by $T = T_{\omega_0, p_0} : I_{\omega_0} \rightarrow I_{\omega_0}$. Let us denote by $I_j = I_j(\omega_0)$, $j = 1, \dots, m$, the subintervals exchanged by T , by $\lambda_j = \lambda_j(\omega_0)$ their lengths and by $\tau_j = \tau_j(\omega_0)$ the first return time of any $q \in I_i$ to I_{ω_0} . Remark that since $I_{\omega_0}(p_0)$ does not contain any singularity and the set of singularities is discrete, there exists a maximal $\bar{\delta} = \bar{\delta}(\omega_0, p_0)$ such that the strip

$$\bigcup_{0 \leq t < \bar{\delta}(\omega_0, p_0)} \varphi_t I_{\omega_0}(p_0)$$

does not contain any singularities, and thus is isometric to an Euclidean rectangle of height $\bar{\delta}$ and width 1 in the flat coordinates given by ω_0 .

For any $p \in M_{reg}$, denote by $\gamma_s = \gamma_s(p, \omega_0)$ the *unparametrized* curve given by the trajectory of $(\varphi_t)_{t \in \mathbb{R}}$ of length s starting at p . For each $j = 1, \dots, m$, let

$\tilde{\gamma}_j = \tilde{\gamma}_j(\omega_0) \in H_1(M, \mathbb{Z})$ be the homology class obtained by considering the vertical trajectory $\gamma_{\tau_j}(q, \omega_0)$ of a point $q \in I_j$ up to the first return time to I_{ω_0} and closing it up with a horizontal geodesic segment contained in I_{ω_0} . One can show that $\{\tilde{\gamma}_j = \tilde{\gamma}_j(\omega_0), 1 \leq j \leq m\}$ generate the homology $H_1(M, \mathbb{R})$ (the proof is analogous to the proof of Lemma 2.17, §2.9 in [41]). In particular, their Poincaré duals classes $\{\mathcal{P}\tilde{\gamma}_j, 1 \leq j \leq m\}$ generate $H^1(M, \mathbb{R})$. Thus, it follows⁵ that there exists a constant $c > 0$ such that

$$(A.1) \quad \frac{1}{c} \|\rho\|_{\omega_0} \leq \max_{1 \leq j \leq m} \left| \int_{\tilde{\gamma}_j} \rho \right| = \max_{1 \leq j \leq m} |\langle \mathcal{P}\tilde{\gamma}_j, \rho \rangle| \leq c \|\rho\|_{\omega_0}, \text{ for all } \rho \in H^1(M, \mathbb{R}).$$

Since ω_0 does not have neither vertical nor horizontal saddle connections, for any $\omega \in \mathcal{H}^{(1)}(k_1, \dots, k_\kappa)$ in a sufficiently small neighbourhood of ω_0 in the stratum the induced IET T_ω on $I_\omega(p_0)$ has the same number m of exchanged intervals and the same combinatorial datum and furthermore the lengths $\lambda_j(\omega)$, $j = 1, \dots, m$ and the quantity $\bar{\delta}(\omega, p_0)$ change continuously with ω and the homology classes $\tilde{\gamma}_j(\omega)$, $1 \leq j \leq m$ are locally constant. Therefore, by choosing \mathcal{U} to be a small compact neighbourhood of ω_0 in $\mathcal{H}^{(1)}(k_1, \dots, k_\kappa)$, $\tilde{\gamma}_j(\omega) = \tilde{\gamma}_j(\omega_0)$ for any $\omega \in \mathcal{U}$ and $1 \leq j \leq m$ and there exists constants $A_{\mathcal{U}} > 0$ and $C_{\mathcal{U}} > 1$ such that for any $\omega \in \mathcal{U}$ and $1 \leq j \leq m$ one has

$$(A.2) \quad \lambda_j(\omega) \bar{\delta}(\omega, p_0) \geq A_{\mathcal{U}}, \quad \text{and} \quad \frac{1}{C_{\mathcal{U}}} \leq \tau_j(\omega) \leq C_{\mathcal{U}}.$$

Furthermore, since \mathcal{U} is compact, there exists a constant K such that for any $\omega_1, \omega_2 \in \mathcal{U}$, and any $\rho \in H^1(M, \mathbb{R})$ the Hodge norms satisfy $\|\rho\|_{\omega_1} \leq K \|\rho\|_{\omega_2}$ (it follows for example from [15], §2). Thus, (A.1) holds uniformly for $\omega \in \mathcal{U}$, that is, there exists $c_{\mathcal{U}} > 1$ such that

$$(A.3) \quad \frac{1}{c_{\mathcal{U}}} \|\rho\|_{\omega} \leq \max_{1 \leq j \leq m} \left| \int_{\tilde{\gamma}_j(\omega)} \rho \right| \leq c_{\mathcal{U}} \|\rho\|_{\omega} \quad \text{for all } \omega \in \mathcal{U}, \rho \in H^1(M, \mathbb{R}).$$

Since ω_0 belongs to the support of μ , $\mu(\mathcal{U}) > 0$. Let $\mathcal{S} \subset \mathcal{H}^{(1)}$ be a hypersurface containing ω_0 transverse to $(G_t)_{t \in \mathbb{R}}$ and let $\mathcal{K} \subset \mathcal{S} \cap \mathcal{U}$ be a compact subset with positive transverse measure such that every $\omega \in \mathcal{K}$ is Birkhoff generic and Oseledets regular.

Proof of Lemma 4.3. Let \mathcal{K} be the section constructed above starting from the measure μ . Since $(G_t)_{t \in \mathbb{R}}$ is ergodic and \mathcal{K} has positive transverse measure, there exists a full μ -measure set $\mathcal{M}' \subset \mathcal{H}^{(1)}$ such that for any $\omega \in \mathcal{M}'$ the forward geodesics $\{G_t \omega, t > 0\}$ visits \mathcal{K} infinitely often. For $\omega \in \mathcal{M}'$, let t_0 be the minimum $t \geq 0$ such that $G_t \omega \in \mathcal{K}$ and let $\{t_k\}_{k \in \mathbb{N}}$ be the sequence of successive returns to \mathcal{K} . For each $k \in \mathbb{N}$, referring to the notation introduced above, let us denote by $I^k := I_{G_{t_k} \omega}(p_0)$ and by $\tilde{\gamma}_j^{(k)} \in H_1(M, \mathbb{R})$ the homology class $\tilde{\gamma}_j(G_{t_k} \omega)$. As we already remarked, the set $\{\tilde{\gamma}_j^{(k)}, j = 1, \dots, m\}$ generates $H_1(M, \mathbb{R})$ and by construction each $\tilde{\gamma}_j^{(k)}$ belongs to $H_1(M, \mathbb{Z})$. Let us show that they $\{\tilde{\gamma}_j^{(k)}, j = 1, \dots, m\}$ satisfies the conclusion of Lemma 4.3. Since $\tilde{\gamma}_j^{(k)} = \tilde{\gamma}_j(G_{t_k} \omega)$ and $G_{t_k} \omega \in \mathcal{K} \subset \mathcal{U}$, it follows from (A.3) that

$$(A.4) \quad \frac{1}{c_{\mathcal{U}}} \|\rho\|_{G_{t_k} \omega} \leq \max_{1 \leq j \leq m} \left| \int_{\tilde{\gamma}_j^{(k)}} \rho \right| \leq c_{\mathcal{U}} \|\rho\|_{G_{t_k} \omega} \quad \text{for every } \rho \in H^1(M, \mathbb{R}),$$

which gives (4.4) with $c := c_{\mathcal{U}}$. \square

⁵This same remark is used in [44], see Lemma 6.2.

Proof of Theorem 4.2. Let \mathcal{K} be the section constructed at the beginning of the Appendix. Let $\mathcal{M}' \subset \mathcal{H}^{(1)}$ be the set of ω such that the forward geodesic $\{G_t\omega, t > 0\}$ visits \mathcal{K} infinitely often and the vertical and the horizontal flow on (M, ω) are ergodic. The set \mathcal{M}' has full μ measure since μ is ergodic and \mathcal{K} has positive transverse measure. Let us show that \mathcal{M}' satisfy the conclusion of the theorem. Let us remark first that, since Oseledets regular points are flow invariant, any $\omega \in \mathcal{M}'$ is Oseledets regular by the definition of \mathcal{K} .

Fix $\omega \in \mathcal{M}'$ and let t_0 be the minimum $t \geq 0$ such that $G_t(\omega) \in \mathcal{K}$ and let $\{t_k\}_{k \in \mathbb{N}}$ be the sequence of successive returns to \mathcal{K} . Let ρ be a closed smooth form such that $[\rho] \in E_\omega^-(M, \mathbb{R})$. Let $(\varphi_t)_{t \in \mathbb{R}}$ be the vertical flow on (M, ω) and consider the function $f = i_{X_v}\rho$. We want to show that the associated cocycle F_f^v is a coboundary for $(\varphi_t)_{t \in \mathbb{R}}$.

For any $p \in M_{reg}$ let $\gamma_t(p, \omega)$ be the unparametrized curve underlying a trajectory of length t for the vertical flow on (M, ω) , so that

$$(A.5) \quad \int_0^t f(\varphi_s p) ds = \int_{\gamma_t(p, \omega)} \rho.$$

We will show that for every $p \in M_{reg}$ the ergodic integrals (A.5) are bounded uniformly in $t \geq 0$ (and hence deduce that F_f^v is a coboundary). We will do so (as in [15]) by decomposing the integral (A.5) along a special sequence of times, given in our proof by returns to \mathcal{K} .

Referring to the notation introduced in the construction of the section \mathcal{K} , let $p_0 \in M_{reg}$ be the point chosen in the definition of \mathcal{K} and for each visit time t_k , let us denote by

$$(A.6) \quad I^k := I_{G_{t_k}\omega}(p_0), I_j^k = I_j(G_{t_k}\omega), \tilde{\gamma}_j^k := \tilde{\gamma}_j(G_{t_k}\omega), \tau_j^k := \tau_j(G_{t_k}\omega).$$

Since $(G_t)_{t \in \mathbb{R}}$ preserves horizontal leaves and for each $k \geq 0$ we have $I^{k+1} = I_{G_{t_{k+1}}\omega}(p_0) \subset I_{G_{t_k}\omega}(p_0) = I^k$. Let us remark that we can replace ρ by any form cohomologous to ρ . This follows since if $\rho \in \Omega^1(M)$ is exact then $\rho = dh$ for some smooth function $h : M \rightarrow \mathbb{R}$ and $f = i_{X_v}\rho = i_{X_v}dh = \mathcal{L}_{X_v}h = X_v h$, so F_f^v is a coboundary. Let us then replace the form ρ by any form cohomologous to ρ vanishing on a neighborhood of I^0 . With the customary abuse of notation, the same symbol ρ will be used for the new form.

For each $k \in \mathbb{N}$ and each $q \in I_j^k$, let

$$\tau^k(\omega, q) := \tau_j(G_{t_k}\omega)e^{t_k} = \tau_j^k e^{t_k}, \quad \gamma_\omega^k(q) := \gamma_{\tau^k(\omega, q)}(q, \omega).$$

The unparametrized curve $\gamma_\omega^k(q)$ will be called a k^{th} -principal return trajectory. Remark that $\gamma_\omega^k(q)$, which is the support of a trajectory of length $\tau^k(\omega, q) = \tau_j^k e^{t_k}$ for the vertical flow given by ω , is the same unparametrized curve than the support of a trajectory of length τ_j^k for the vertical flow given by $G_{t_k}(\omega)$.

Fix a regular point $p \in M_{reg}$. For any $t \in \mathbb{R}$, trajectory $\gamma_t := \gamma_t(p, \omega)$ can be inductively decomposed into principal return trajectories as follows (analogously to Lemma 9.4 in [15]). Let $K \in \mathbb{N}$ be the maximum $k \in \mathbb{N}$ such that $\text{int}(\gamma_t) \cap I^k$ has at least two elements (where $\text{int}(\gamma)$ denotes the curve γ without its endpoints). Let $p_0^K, p_1^K, \dots, p_{m_K}^K$ be all the points in the interior of γ_t belonging to I^K , indexed in increasing order of t . Then if α_K is the initial part of the trajectory γ_t from p to p_0^K and β_K is the final part of γ_t from $p_{m_K}^K$ to the final point of γ_t , one can decompose γ_t as

$$\gamma_t = \alpha_K \cup \bigcup_{i=0}^{m_K-1} \gamma_\omega^K(p_i^K) \cup \beta_K,$$

where all $\gamma_\omega^K(p_i^K)$ are K^{th} principal return trajectories. Moreover, denoting by $l_\nu(\cdot)$ the length of an arc with respect to $\nu \in \mathcal{M}(M)$, the remainder curves, by construction, satisfy $l_{G_{t_K}\omega}(\alpha_K), l_{G_{t_K}\omega}(\beta_K) \leq \max_j \tau_j^K$ or, equivalently, $l_\omega(\alpha_K), l_\omega(\beta_K) \leq e^{t_K} \max_j \tau_j^K$. Let us estimate the number m_K of K^{th} -principal returns. By definition of K , $\text{int}(\gamma_t) \cap I_{K+1}$ has at most one element hence $l_\omega(\gamma_t) \leq 2e^{t_{K+1}} \max_j \tau_j^{K+1}$. Since any K^{th} -principal return $\gamma_\omega^K(q)$ satisfy $l_\omega(\gamma_\omega^K(q)) \geq e^{t_K} \min_j \tau_j^K$, using (A.2) we get $m_K \leq 2C_{\mathcal{U}}^2 e^{t_{K+1}-t_K}$.

Let $k := K-1$. To decompose α_{k+1} and β_{k+1} in k^{th} principal return trajectories, let by convention p_0^k be the initial point of β_{k+1} and let $p_1^k, p_2^k, \dots, p_{m_k}^k$ denote all points of $\text{int}(\alpha_{k+1}) \cup \text{int}(\beta_{k+1}) \cap I^k$, indexed in increasing order of t . Then, we have

$$\alpha_{k+1} \cup \beta_{k+1} = \alpha_k \cup \bigcup_{i=0}^{m_k-1} \gamma_\omega^k(p_i^k) \cup \beta_k,$$

where α_k is the initial part of α_{k+1} from p to p_1^k and β_k is the final part of β_{k+1} from $p_{m_k}^k$ to the endpoint of β_{k+1} . To estimate m_k , reasoning similarly to the estimate of m_K and using the upper bound on the length of α_{k+1} and β_{k+1} and the lower bound given by (A.2) on the length of k^{th} principal return trajectories together with (A.2), we get

$$m_k \leq 2 \frac{e^{t_{k+1}} \max_{1 \leq j \leq m} \tau_j^{k+1}}{e^{t_k} \min_{1 \leq j \leq m} \tau_j^k} \leq 2C_{\mathcal{U}}^2 e^{t_{k+1}-t_k}.$$

Moreover, $l_\omega(\alpha_k), l_\omega(\beta_k) \leq e^{t_k} \max_j \tau_j^k$. Repeating for the same construction described for $k = K-1$ for $k = K-2, \dots, 1, 0$, we get the decomposition

$$(A.7) \quad \gamma_t = \alpha_0 \cup \bigcup_{k=0}^K \bigcup_{j=0}^{m_k-1} \gamma_\omega^k(p_j^k) \cup \beta_0,$$

where for each $0 \leq k \leq K$ and $0 \leq j \leq m_k$ the trajectory $\gamma_\omega^k(p_j^k)$ is a k^{th} principal return,

$$(A.8) \quad m_k \leq 2C_{\mathcal{U}}^2 e^{(t_{k+1}-t_k)} \quad \text{and} \quad l_\omega(\alpha_0), l_\omega(\beta_0) \leq e^{t_0} \max_j \tau_j^0.$$

Thus, recalling (A.5),

$$(A.9) \quad \int_0^t f(\varphi_s p) ds = \sum_{k=0}^K \sum_{j=0}^{m_k-1} \int_{\gamma_\omega^k(p_j^k)} \rho + \int_{\beta_0} \rho + \int_{\alpha_0} \rho.$$

By construction, all points $(p_j^k)_{j,k}$ belong to $I_\omega(p_0)$. For each $0 \leq k \leq K$ and $1 \leq j \leq m_k$, let $\tilde{\gamma}_\omega^k(p_j^k)$ stand for the homology class of the closed curve obtained by closing up the trajectory $\gamma_\omega^k(p_j^k)$ by the shortest geodesic connecting its final point with its initial point. Remark that since both initial and final points of $\gamma_\omega^k(p_j^k)$ are contained in $I_{G_{t_k}\omega} = I^k$, $\tilde{\gamma}_\omega^k(p_j^k)$ consists of $\gamma_\omega^k(p_j^k)$ together with a horizontal segment contained in I^k .

Remark now that if $p_j^k \in I^k$, the closed curve $\tilde{\gamma}_\omega^k(p_j^k)$ is a representative of the homology class $\tilde{\gamma}_l(G_{t_k}\omega) \in H_1(M, \mathbb{Z})$ defined in the construction of \mathcal{K} at the beginning of the Appendix. Since ρ vanishes on $I^k \subset I^0$ and $\tilde{\gamma}_\omega^k(p_j^k)$ and $\gamma_\omega^k(p_j^k)$ differ by a horizontal segment contained in $I^k \subset I^0$, in view of (A.3), we get that

$$\left| \int_{\gamma_\omega^k(p_j^k)} \rho \right| = \left| \int_{\tilde{\gamma}_\omega^k(p_j^k)} \rho \right| = \left| \int_{\tilde{\gamma}_l(G_{t_k}\omega)} \rho \right| \leq c_{\mathcal{U}} \|\rho\|_{G_{t_k}\omega}.$$

Since, by assumption, $[\rho] \in E_\omega^-(M, \mathbb{R})$ (recall (4.3)), it follows that there exists constants $C_1, \theta > 0$ such that

$$\left| \int_{\gamma_\omega^k(p_j^k)} \rho \right| \leq C_1 e^{-\theta t_k} \text{ for all } k \geq 0.$$

Using this inequality together with (A.8) to estimate (A.9), we get that there exists $C_2 > 0$ such that for any $t \geq 0$, one has

$$(A.10) \quad \left| \int_0^t f(\varphi_s p) ds \right| \leq C_2 \sum_{k=0}^{\infty} e^{(t_{k+1}-t_k)} e^{-\theta t_k} + C_2 = C_2 \sum_{k=0}^{\infty} e^{\left(\frac{t_{k+1}-t_k}{t_k} - \theta\right)t_k} + C_2.$$

Since \mathcal{K} has positive transverse measure and ω is Birkhoff generic (since Birkhoff generic points are $(G_t)_{t \in \mathbb{R}}$ -invariant and $G_{t_1} \omega \in \mathcal{K}$ which by construction consists only of Birkhoff generic points), by Birkhoff ergodic theorem we have $\lim_{k \rightarrow \infty} t_k/k = 1/\mu_{tr}(\mathcal{K})$, where $\mu_{tr}(\mathcal{K}) > 0$ is the transverse measure of \mathcal{K} . Thus, if k is sufficiently large, $(t_{k+1} - t_k)/t_k - \theta \leq -\theta/2$, which shows that the above series is convergent and the ergodic integrals in (A.10) are uniformly bounded for all $t \geq 0$. By Remark 3.7 this implies that F_f^v is a coboundary.

Let us now prove the second part of Theorem 4.2. Let us assume in addition from now on that μ is KZ-hyperbolic. Let $\omega \in \mathcal{M}'$, $p \in M_{reg}$ and let $\rho \in \Omega^1(M)$ be a smooth closed one form such that $[\rho] \notin E_\omega^-(M, \mathbb{R})$. For each $k \in \mathbb{N}$ and $j = 1, \dots, m$, using the notation introduced in (A.6) and setting $\bar{\delta}^k := \bar{\delta}(G_{t_k} \omega, p_0)$ (where $\bar{\delta}$ was also defined during the construction of \mathcal{K}), define the set R_j^k by

$$R_j^k := \bigcup_{0 \leq s < \bar{\delta}^k} \varphi_s^{G_{t_k} \omega, v} (I_j^k) = \bigcup_{0 \leq s < e^{t_k} \bar{\delta}^k} \varphi_s^{\omega, v} (I_j^k).$$

Thus each R_j^k is a rectangle in translation surface coordinates given by $G_{t_k} \omega$ (and by ω) with base $I_j^k \subset I^k \subset I_\omega(p_0)$ and height $\bar{\delta}^k$ with respect to $G_{t_k} \omega$ (or $e^{t_k} \bar{\delta}^k$ with respect to ω). Since $G_{t_k} \omega \in \mathcal{U}$, by (A.2) the area of each rectangle (which is invariant under $(G_t)_{t \in \mathbb{R}}$) is uniformly bounded from below, that is

$$(A.11) \quad \nu_\omega(R_j^k) = \nu_{G_{t_k} \omega}(R_j^k) = \lambda_j(G_{t_k} \omega) \bar{\delta}(G_{t_k} \omega, p_0) \geq A_u > 0$$

for all $j = 1, \dots, m$ and $k \in \mathbb{N}$.

Assume that $q \in I_j^k$ for some $j = 1, \dots, m$ and $k \in \mathbb{N}$. By definition, $e^{t_k} \tau_j^k$ is the (vertical) length of $\gamma_\omega^k(q)$ with respect to ω and $\tilde{\gamma}_j^k \in H_1(M, \mathbb{Z})$ is the homology class of the curve consisting of $\gamma_\omega^k(q)$ closed by a horizontal segment $J^k(q)$ contained in $I^k = I_{G_{t_k} \omega}(p_0)$, which has horizontal length one in the flat metric given by $G_{t_k} \omega$. Thus, for $f = i_{X_v} \rho$ we have

$$(A.12) \quad \begin{aligned} \left| \int_0^{e^{t_k} \tau_j^k} f(\varphi_s q) ds - \int_{\tilde{\gamma}_j^k} \rho \right| &= \left| \int_{\gamma_\omega^k(q)} \rho - \int_{\tilde{\gamma}_j^k} \rho \right| = \left| \int_{J^k(q)} \rho \right| \\ &\leq \int_0^{l_\omega(I^k)} |i_{X_h} \rho(\varphi_s^h q)| ds \leq l_\omega(I^k) \|i_{X_h} \rho\|_\infty = e^{-t_k} \|i_{X_h} \rho\|_\infty. \end{aligned}$$

Let us now show that for any $p \in R_j^k$, setting $c_\rho := 3\|i_{X_h} \rho\|_\infty$, we have

$$(A.13) \quad \left| \int_{\tilde{\gamma}_j^k} \rho - \int_0^{e^{t_k} \tau_j^k} f(\varphi_s p) ds \right| \leq c_\rho.$$

Given $p \in R_j^k$, since the height of R_j^k in the translation structure given by ω is $e^{t_k} \bar{\delta}^k$, we can write $p = \varphi_u q$ for some $0 \leq u \leq e^{t_k} \bar{\delta}^k$ and $q \in I_j^k$. Thus, since

$\varphi_{e^{tk}\tau_j^k - u}(p) = \varphi_{e^{tk}\tau_j^k}(q) = T_k(q)$, where $T_k := T_{G_{t_k}\omega, p_0}$ is the first return map of $(\varphi_t)_{t \in \mathbb{R}}$ to $I^k = I_{G_{t_k}\omega}(p_0)$, we can write

$$(A.14) \quad \int_0^{e^{tk}\tau_j^k} f(\varphi_s q) ds - \int_0^{e^{tk}\tau_j^k} f(\varphi_s p) ds = \int_0^u f(\varphi_s q) ds - \int_0^u f(\varphi_s T_k(q)) ds.$$

Remark now that $q, T_k(q), \varphi_u q, \varphi_u T_k(q)$ are corners of a rectangle R (since they are contained in the rectangle of base I^k and height $e^{tk}\bar{\delta}^k$ in the translation structure given by ω). Denote by $\partial_v R$ and $\partial_h R$ the vertical and the horizontal part of the boundary of R respectively. Then $\int_{\partial_v R} \rho$ is equal to the RHS of (A.14) and $\int_{\partial_h R} \rho$ is bounded by $2\|i_{X_h} \rho\|_\infty$. Thus, since $\int_R d\rho = 0$ (ρ is closed and R is simply connected), by Stoke's theorem, $0 = \int_{\partial R} \rho = \int_{\partial_v R} \rho + \int_{\partial_h R} \rho$. It follows that

$$\left| \int_0^u f(\varphi_s q) ds - \int_0^u f(\varphi_s T_k(q)) ds \right| = \left| \int_{\partial_v R} \rho \right| = \left| \int_{\partial_h R} \rho \right| \leq 2\|i_{X_v} \rho\|_\infty.$$

This, combined with (A.14) and (A.12), yields (A.13).

Let us now prove that the cocycle F_f^v is not a coboundary. Assume by contradiction that F_f^v is a coboundary with a measurable transfer function $u : M \rightarrow \mathbb{R}$. Then there exists a constant $M_{\mathcal{U}}$, depending on $A_{\mathcal{U}}$, such that the set

$$\Lambda(M_{\mathcal{U}}) := \{p \in M : |u(p)| \geq M_{\mathcal{U}}\} \quad \text{satisfies} \quad \nu_\omega(\Lambda(M_{\mathcal{U}})) \leq A_{\mathcal{U}}/2.$$

Thus, for any fixed $1 \leq j \leq m$, for all p in a set of ν_ω -measure greater than $1 - A_{\mathcal{U}}$ (more precisely, for all $p \notin \Lambda(M_{\mathcal{U}}) \cup \varphi_{-e^{tk}\tau_j^k}(\Lambda(M_{\mathcal{U}}))$), we have

$$(A.15) \quad |F_f^v(e^{tk}\tau_j^k, p)| = \left| \int_0^{e^{tk}\tau_j^k} f(\varphi_s^v p) ds \right| = |u(\varphi_{e^{tk}\tau_j^k} p) - u(p)| \leq 2M_{\mathcal{U}}.$$

Since $\nu_\omega(R_j^k) \geq A_{\mathcal{U}}$ (see (A.11)), there exists $p_j \in R_j^k$ satisfying (A.15). Repeating the same argument for each $1 \leq j \leq m$ and recalling (A.4), which holds since $G_{t_k}\omega \in \mathcal{U}$, and (A.13) we get

$$\frac{1}{c_{\mathcal{U}}} \|\rho\|_{G_{t_k}\omega} \leq \max_{1 \leq j \leq m} \left| \int_{\tilde{\gamma}_j^k} \rho \right| \leq \max_{1 \leq j \leq m} \left| \int_0^{e^{tk}\tau_j^k} f(\varphi_s p_j) ds \right| + c_\rho \leq 2M_{\mathcal{U}} + c_\rho.$$

Thus, $\liminf_{t \rightarrow +\infty} \|\rho\|_{G_t\omega} < \infty$. Since μ is KZ-hyperbolic, recalling the definition of the stable space (4.3), this implies that $[\rho] \in E_\omega^-(M, \mathbb{R})$, contrary to the assumptions. Thus, we conclude that F_f^v cannot be a coboundary. \square

ACKNOWLEDGMENTS

We would like to thank Vincent Delacroix, Giovanni Forni and Pascal Hubert for useful discussions and suggestions that helped us improve the paper and J.-P. Conze, P. Hooper, M. Lemańczyk, C. Matheus and B. Weiss for useful discussions. The second author is currently supported by an RCUK Academic Fellowship and an EPSRC First Grant, whose support is fully acknowledged.

REFERENCES

- [1] D. Aulicino, Phd Thesis, University of Maryland.
- [2] J. Aaronson, *An introduction to infinite ergodic theory*, Mathematical Surveys and Monographs, 50, AMS, Providence, RI, 1997.
- [3] P. Bachurin, K. Khanin, J. Marklof and A. Plakhov, *Perfect retroreflectors and billiard dynamics*, Journal of Modern Dynamics 5 (2011), 33-48.
- [4] M. Bainbridge, *Euler characteristics of Teichmüller curves in genus two*, Geometry & Topology 11 (2007), 1887-2073.
- [5] V. Bergelson, A. del Junco, M. Lemańczyk, J. Rosenblatt, *Rigidity and non-recurrence along sequences*, arXiv:1103.0905.

- [6] Y. Cheung, *Hausdorff dimension of the set of nonergodic directions*. With an appendix by M. Boshernitzan, *Ann. Math. (2)* 158 (2003), 661-678.
- [7] Y. Cheung, P. Hubert, H. Masur, *Dichotomy for the Hausdorff dimension of the set of nonergodic directions*, *Invent. Math.* 183 (2011), 337-383.
- [8] J.-P. Conze, K. Frączek, *Cocycles over interval exchange transformations and multivalued Hamiltonian flows*, *Adv. Math.* 226 (2011), 4373-4428.
- [9] J.-P. Conze, E. Gutkin, *On recurrence and ergodicity for geodesic flows on noncompact periodic polygonal surfaces*, [arXiv:1008.0136](https://arxiv.org/abs/1008.0136).
- [10] I.P. Cornfeld, S.V. Fomin, Ya.G. Sinai, *Ergodic Theory*. Springer-Verlag, New York, 1982.
- [11] V. Delecroix, *Divergent directions in some periodic wind-tree models*, [arXiv:1107.2418](https://arxiv.org/abs/1107.2418).
- [12] V. Delecroix, P. Hubert and S. Lelièvre, *Diffusion for the periodic wind-tree model*, [arXiv:1107.1810](https://arxiv.org/abs/1107.1810).
- [13] A. Eskin, H. Masur, M. Schmoll, *Billiards in rectangles with barriers*, *Duke Math. J.* 118 (2003), 427-463.
- [14] G. Forni, *Solutions of the cohomological equation for area-preserving flows on compact surfaces of higher genus*, *Ann. of Math. (2)* 146 (1997), 295-344.
- [15] G. Forni, *Deviation of ergodic averages for area-preserving flows on surfaces of higher genus*, *Ann. of Math. (2)* 155 (2002), 1-103.
- [16] G. Forni, *Sobolev regularity of solutions of the cohomological equation*, [arXiv:0707.0940](https://arxiv.org/abs/0707.0940).
- [17] K. Frączek, C. Ulcigrai, *Ergodic properties of extensions of locally Hamiltonian flows*, [arXiv:1102.5358](https://arxiv.org/abs/1102.5358).
- [18] ———, *Ergodic directions for \mathbb{Z} -periodic billiards*, preprint.
- [19] W. Fulton, *Algebraic topology. A first course*. Graduate Texts in Mathematics, 153. Springer-Verlag, New York, 1995.
- [20] E. Gutkin, *Geometry, topology and dynamics of geodesic flows on noncompact polygonal surfaces*, *Regul. Chaotic Dyn.* 15 (2010), 482-503.
- [21] J. Hardy, J. Weber, *Diffusion in a periodic wind-tree model*, *J. Math. Phys. (7)* 21 (1980), 1802-1808.
- [22] P. Hooper, *The invariant measures of some infinite interval exchange maps*, [arXiv:1005.1902](https://arxiv.org/abs/1005.1902).
- [23] P. Hubert, P. Hooper and B. Weiss, *Dynamics on the infinite staircase surface*, to appear in *Discrete and Continuous Dynamical Systems - Series A*.
- [24] P. Hooper, B. Weiss, *Generalized staircases: recurrence and symmetry*, [arXiv:0905.3736](https://arxiv.org/abs/0905.3736), to appear in *Annales de L'Institut Fourier*.
- [25] P. Hubert, S. Lelièvre, S. Troubetzkoy, *The Ehrenfest wind-tree model: periodic directions, recurrence, diffusion*, *Journal für die reine und angewandte Mathematik*, 656 (2011), 223-244.
- [26] P. Hubert and B. Weiss, *Ergodicity for infinite periodic translation surfaces*, preprint available from <http://www.cmi.univ-mrs.fr/~hubert/recherche.html>.
- [27] P. Hubert, G. Schmihüsen, *Infinite translation surfaces with infinitely generated Veech groups*, *Journal of Modern Dynamics*, 4 (2010), 715-732.
- [28] A. Katok, A. Zemljakov, *Topological transitivity of billiards in polygons*, (Russian) *Mat. Zametki* 18 (1975), 291-300.
- [29] S. Kerckhoff, H. Masur, J. Smillie, *Ergodicity of billiard flows and quadratic differentials*, *Ann. of Math. (2)* 124 (1986), 293-311.
- [30] M. Kontsevich, A. Zorich, *Connected components of the moduli spaces of Abelian differentials with prescribed singularities*, *Invent. Math.* 153 (2003), 631-678.
- [31] H. Masur, *Ergodic Theory of Translation Surfaces*, *Handbook of dynamical systems*. Vol. 1B, Elsevier B. V., Amsterdam (2006), 527-547.
- [32] H. Masur, *Interval exchange transformations and measured foliations*, *Ann. of Math. (2)* 115 (1982), 169-200.
- [33] H. Masur, S. Tabachnikov, *Rational billiards and flat structures*, *Handbook of dynamical systems*, Vol. 1A, North-Holland, Amsterdam (2002), 1015-1089.
- [34] C. Matheus, J.-Ch. Yoccoz, *The action of the affine diffeomorphisms on the relative homology group of certain exceptionally symmetric origamis*, *Journal of Modern Dynamics* 4 (2010), 453-486.
- [35] C.T. McMullen, *Dynamics of $SL_2(\mathbb{R})$ over moduli space in genus two*, *Ann. of Math. (2)* 165 (2007), 397-456.
- [36] K. Schmidt, *Cocycle of Ergodic Transformation Groups*, *Lect. Notes in Math.* Vol. 1 Mac Milan Co. of India, 1977.
- [37] S. Troubetzkoy, *Typical recurrence for the Ehrenfest wind-tree model*, *J. Stat. Phys.* 141 (2010), 60-67.
- [38] W.A. Veech, *Strict ergodicity in zero dimensional dynamical systems and the Kronecker-Weyl theorem mod 2*, *Trans. Amer. Math. Soc.* 140 (1969), 1-34.

- [39] ———, *Gauss measures for transformations on the space of interval exchange maps*, Ann. of Math. (2) 115 (1982), 201-242.
- [40] M. Viana, *Ergodic theory of interval exchange maps*, Rev. Mat. Complut. 19 (2006), 7-100.
- [41] ———, *Dynamics of Interval Exchange Transformations and Teichmüller Flows*, lecture notes available from <http://w3.impa.br/~viana/out/ietf.pdf>
- [42] J.-C. Yoccoz, *Interval exchange maps and translation surfaces*, lecture notes available from http://www.college-de-france.fr/media/equ_dif/UPL15305_PisaLecturesJCY2007.pdf
- [43] R.J. Zimmer, *Ergodic theory and semisimple groups*. Monographs in Mathematics, 81. Birkhäuser Verlag, Basel, 1984.
- [44] A. Zorich, *Deviation for interval exchange transformations*, Ergodic Theory Dynam. Systems 17 (1997), 1477-1499.
- [45] ———, *How do the leaves of a closed 1-form wind around a surface?*, Amer. Math. Soc. Transl. Ser. 2, 197 197 (1999), 135-178.
- [46] ———, *Flat surfaces*, Frontiers in number theory, physics, and geometry. I, Springer, Berlin (2006), 437-583.

FACULTY OF MATHEMATICS AND COMPUTER SCIENCE, NICOLAUS COPERNICUS UNIVERSITY,
UL. CHOPINA 12/18, 87-100 TORUŃ, POLAND
E-mail address: fraczek@mat.umk.pl

DEPARTMENT OF MATHEMATICS, UNIVERSITY WALK, CLIFTON, BRISTOL BS8 1TW, UNITED
KINGDOM
E-mail address: corinna.ulcigrai@bristol.ac.uk