

The Kakimizu complex of a connected sum of links

Jessica E. Banks

Abstract

We show that $|\text{MS}(L_1\#L_2)| = |\text{MS}(L_1)| \times |\text{MS}(L_2)| \times \mathbb{R}$ when L_1 and L_2 are any non-split and non-fibred links. Here $\text{MS}(L)$ denotes the Kakimizu complex of a link L , which records the taut Seifert surfaces for L . We also show that the analogous result holds if we study incompressible Seifert surfaces instead of taut ones.

1 Introduction

The Kakimizu complex of a link L , denoted $\text{MS}(L)$, is a simplicial complex that records the taut Seifert surfaces for L . It is analogous to the curve complex of a compact, orientable surface. We will give the definition in Section 2.

Kakimizu proved the following, building on work of Eisner in [2].

Theorem 1.1 ([3] Theorem B). *Let L_1, L_2 be knots, each not fibred but with a unique incompressible Seifert surface. Then $|\text{MS}(L_1\#L_2)|$ is homeomorphic to \mathbb{R} .*

In this paper we prove the following more general result, as well as the analogous result for incompressible Seifert surfaces.

Theorem 1.2. *Let L_1, L_2 be non-split, non-fibred, links in \mathbb{S}^3 , and let $L = L_1\#L_2$. Then $|\text{MS}(L)|$ is homeomorphic to $|\text{MS}(L_1)| \times |\text{MS}(L_2)| \times \mathbb{R}$.*

For a distant union of two links L_1 and L_2 , the taut Seifert surfaces for the two links do not interact. We may therefore consider the two links separately. For this reason, the ‘non-split’ hypothesis in Theorem 1.2 is not a significant restriction. For the remainder of this paper we will only consider non-split links.

The case that one of the L_i is fibred was dealt with by Kakimizu.

Proposition 1.3 ([4] Proposition 2.4). *If L_1 is fibred then $\text{MS}(L) \cong \text{MS}(L_2)$.*

The idea of the proof of Theorem 1.2 is to first define a triangulation of $|\text{MS}(L_1)| \times |\text{MS}(L_2)| \times \mathbb{R}$, then choose a representative of each element of $V(\text{MS}(L_i))$, which we use to define a map between the vertices of the two simplicial complexes, and finally show that this map is an isomorphism.

Sections 2–5 cover definitions and results we will need. Sections 6–8 each constitute a step in the proof of Theorem 1.2. In Section 9 these ideas are drawn together to complete the proof. Finally, in Section 10 we discuss incompressible Seifert surfaces.

I am grateful to Marc Lackenby for suggesting that this proof might be possible. This result has been proved independently by Bassem Saad.

2 The definition of the Kakimizu complex

Definition 2.1. A *Seifert surface* for a link L is a compact, orientable surface R with no closed components such that $\partial R = L$ as an oriented link. The surface R can also be seen as properly embedded in the link complement $\mathbb{S}^3 \setminus \mathcal{N}(L)$. Say R is *taut* if it has maximal Euler characteristic among all Seifert surfaces for L .

The Kakimizu complex was first defined as follows.

Definition 2.2 ([3] p225). For a link L , the *Kakimizu complex* $\text{MS}(L)$ of L is a simplicial complex, the vertices of which are the ambient isotopy classes of taut Seifert surfaces for L . Vertices R_0, \dots, R_n span an n -simplex exactly when they can be realised disjointly.

Definition 2.3. A metric is defined on the vertices of $\text{MS}(L)$. The distance between two vertices is the distance in the 1-skeleton of $\text{MS}(L)$ when every edge has length 1.

In [3], Kakimizu showed that the distance between two vertices of $\text{MS}(L)$ can be calculated by considering lifts of the two Seifert surfaces to the infinite cyclic cover of the link complement.

Proposition 2.4 ([3] Proposition 3.1). *Let L be a link, and let $M = \mathbb{S}^3 \setminus \mathcal{N}(L)$. Consider the infinite cyclic cover \tilde{M} of M (that is, the cover corresponding to the linking number $\text{lk}: \pi_1(M) \rightarrow \mathbb{Z}$), and let τ be a generator for the group of covering transformations.*

Let R, R' be taut Seifert surfaces for L that represent distinct vertices of $\text{MS}(L)$. Choose a lift V_0 of $M \setminus R$ to \tilde{M} . For $n \in \mathbb{Z}$ let $V_n = \tau^n(V_0)$.

Take a lift $V_{R'}$ of $M \setminus R'$. Isotope the Seifert surface R' in M so as to minimise the value of $\max\{n : V_{R'} \cap V_n \neq \emptyset\} - \min\{n : V_{R'} \cap V_n \neq \emptyset\}$. Then $d_{\text{MS}(L)}(R, R') = \max\{n : V_{R'} \cap V_n \neq \emptyset\} - \min\{n : V_{R'} \cap V_n \neq \emptyset\}$.

Przytycki and Schultens pointed out in [5] that this result is not in fact true. It may fail in the case of a link that bounds a disconnected taut Seifert surface. Such links are called *boundary links*. Note that this is a fairly unusual property for a link to have. In particular, all boundary links have Alexander polynomial 0. However, we will need to allow for this case in the proof of Theorem 1.2, which makes the proof more complicated than it

would be otherwise. In particular, it is difficult to control the situation where pairs of Seifert surfaces have components that can be made to coincide.

A reader who wishes to avoid this difficulty should take Definition 2.2 as their working definition of $MS(L)$, and may ignore the remainder of this section, Section 4 from Lemma 4.11 onwards and Lemma 8.1, as well as some of the detail in the proofs of Corollary 8.2 and Proposition 8.3.

Figure 1 gives an instructive example of how Proposition 2.4 can fail. The link L_α shown consists of two linked copies of the knot 7_4 . This knot, which is the $(1, 3, 3)$ pretzel knot, has two taut Seifert surfaces. One is given by applying Seifert's algorithm to an alternating diagram. The other is given by performing a flype on the diagram that moves the single crossing across one of the lines of three crossings, and then applying Seifert's algorithm. Combining two copies of each of these surfaces gives the two disjoint taut Seifert surfaces R_a, R_b for L_α shown in Figure 1. The arc ρ shown in Figure 2 runs from the top side of R_a to the bottom side, and in doing so passes through R_b in the positive direction twice. This means that if we first take lifts V_n of $M \setminus R_b$ and then a lift V of $M \setminus R_a$ as in Proposition 2.4 we find that, for example, V intersects V_0, V_1, V_2 . The surfaces R_a, R_b should therefore be distance 2 apart, instead of adjacent.

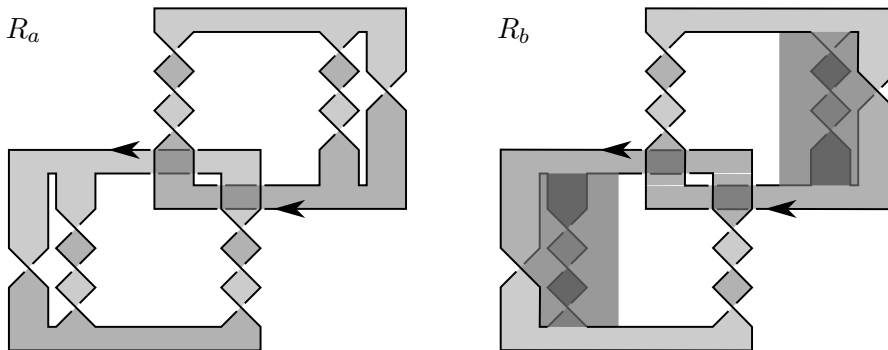

Figure 1

With Proposition 2.4 and their own work in mind, Przytycki and Schultens redefine the Kakimizu complex as follows.

Definition 2.5 (see [5]). Let L be a link, and let $M = S^3 \setminus \mathcal{N}(L)$. Define the *Kakimizu complex* $MS(L)$ of L to be the following flag simplicial complex. Its vertices are ambient isotopy classes of taut Seifert surfaces for L . Two vertices span an edge if they have representatives R, R' such that a lift of $M \setminus R'$ to the infinite cyclic cover of M intersects exactly two lifts of $M \setminus R$.

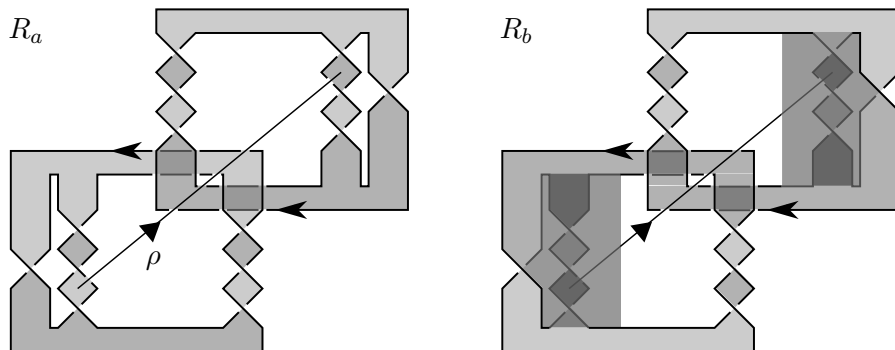

Figure 2

3 Products of simplicial complexes

Definition 3.1 ([1] Chapter II Definition 8.7). A simplicial complex \mathcal{X} is *ordered* if there is a binary relation \leq on the vertices of \mathcal{X} with the following properties.

(P1) $(u \leq v \text{ and } v \leq u) \Rightarrow u = v$.

(P2) If u, v are distinct, $(u \leq v \text{ or } v \leq u) \Leftrightarrow u$ and v are adjacent.

(P3) If u, v, w are vertices of a 2-simplex then $(u \leq v \text{ and } v \leq w) \Rightarrow u \leq w$.

Remark 3.2. It is clear that in searching for such a relation we may use the following weaker version of (P2).

(P2)' If u, v are adjacent then $(u \leq v \text{ or } v \leq u)$.

To see this, note that we can remove all relationships between non-adjacent vertices.

Definition 3.3 ([1] Chapter II Definition 8.8). Let $\mathcal{X}_1, \mathcal{X}_2$ be ordered simplicial complexes. We define the simplicial complex $\mathcal{X}_1 \times \mathcal{X}_2$. Its vertices are given by the set $V(\mathcal{X}_1) \times V(\mathcal{X}_2)$. Vertices $(u_0, v_0), \dots, (u_n, v_n)$ span an n -simplex if the following hold.

- $\{u_0, \dots, u_n\}$ is an m -simplex of \mathcal{X}_1 for some $m \leq n$.
- $\{v_0, \dots, v_n\}$ is an m -simplex of \mathcal{X}_2 for some $m \leq n$.
- The relation defined by $(u, v) \leq (u', v') \Leftrightarrow (u \leq u' \text{ and } v \leq v')$ gives a total linear order on $(u_0, v_0), \dots, (u_n, v_n)$.

Remark 3.4. The projection maps on the vertices extend to simplicial maps of the complexes.

Theorem 3.5 ([1] Chapter II Lemma 8.9). *The map $|\mathcal{X}_1 \times \mathcal{X}_2| \rightarrow |\mathcal{X}_1| \times |\mathcal{X}_2|$ induced by projection is a homeomorphism.*

Definition 3.6. Denote by \mathcal{Z} the simplicial complex with a vertex at each integer and an edge joining $n - 1$ to n for each $n \in \mathbb{Z}$, so that $|\mathcal{Z}| \cong \mathbb{R}$. Order the vertices of \mathcal{Z} using the usual order \leq on \mathbb{Z} .

4 Product regions and detecting adjacency

In this section we recall some results from 3-manifold theory that we will need. These include a number of related results; we include full proofs as later proofs are sensitive to the details. The concepts covered in this section are generally well-known, although some of the details are specific to the case at hand.

Definition 4.1 ([5] Section 3). Let M be a connected 3-manifold, and let S, S' be (possibly disconnected) surfaces properly embedded in M .

Call S and S' *almost transverse* if, given a component S_0 of S and a component S'_0 of S' , they either coincide or intersect transversely. Call the surfaces *almost disjoint* if, given a component S_0 of S and a component S'_0 of S' , they either coincide or are disjoint. Say they are *∂ -almost disjoint* if $\partial S = \partial S'$ and, given a component S_0 of S and a component S'_0 of S' , they either coincide or have disjoint interiors.

Say S and S' *bound a product region* if the following holds. There is a compact surface T , a finite collection $\rho_T \subseteq \partial T$ of arcs and simple closed curves and a map of $N = (T \times \mathbb{I})/\sim$ into M that is an embedding on the interior of N and has the following properties.

- $T \times \{0\} = S \cap N$ and $T \times \{1\} = S' \cap N$.
- $\partial N \setminus (T \times \partial \mathbb{I}) \subseteq \partial M$.

Here \sim collapses $\{x\} \times \mathbb{I}$ to a point for each $x \in \rho_T$. The *horizontal boundary* of N is $(T \times \partial \mathbb{I})/\sim$. Say S and S' have *simplified intersection* if they do not bound a product region.

Proposition 4.2 ([6] Proposition 4.8; see also [7] Proposition 5.4 and Corollary 3.2). *Let M be a ∂ -irreducible Haken manifold. Let S, S' be incompressible, ∂ -incompressible surfaces properly embedded in M in general position.*

1. *If S and S' are isotopic then there is a product region between them.*
2. *Suppose $S \cap S' \neq \emptyset$, but S can be isotoped to be disjoint from S' . Then there is a product region between S and S' .*

Remark 4.3. We will usually apply this proposition with $M = \mathbb{S}^3 \setminus \mathcal{N}(L)$ for a link L . If L is neither a split link nor the unknot then M is Haken and ∂ -irreducible. Furthermore, if S, S' are taut Seifert surfaces for L then they are properly embedded, incompressible and ∂ -incompressible. This remains true if we only consider some components of such surfaces.

Remark 4.4. If ∂S and $\partial S'$ are transverse, the product region N given by Proposition 4.2 is always embedded in M . However, we will want to apply the proposition when Seifert surfaces S and S' may have components that either coincide or have boundaries that coincide. It continues to hold in this situation, but may result in a product region that is not embedded. There are two ways that this can occur.

One option is that the components S_0 of S and S'_0 of S' that bound N coincide. Then N is the whole of M , the surfaces S and S' are connected, and the link L is fibred with fibre S . As we are only interested in non-fibred links, this case will not arise.

The second possibility is that S_0 and S'_0 do not coincide but their boundaries do. Then ∂N covers an entire component of $\partial \mathcal{N}(L)$, and $T \times \{0\}$ meets $T \times \{1\}$ along at least one component of ∂T . See Figure 6.

Corollary 4.5. *Suppose L is not fibred. If S, S' are isotopic by an isotopy fixing their boundaries then there is a product region $N = (T \times I) / \sim$ between them with $\rho_T = \partial T$.*

Proof. Suppose no such product region exists. By Proposition 4.2 there is a product region N between S and S' . This product region N meets one component of each of S and S' , and the boundaries of these components coincide. By deleting other components if necessary, we may assume S, S' are connected.

Let \tilde{S} be a lift of S to the infinite cyclic cover. The isotopy from S to S' lifts to an isotopy from \tilde{S} to a lift \tilde{S}' of S' . Note that $\partial \tilde{S} = \partial \tilde{S}'$. By hypothesis, the isotopy from S' to S defined by the product region N moves the boundary of S' . As the boundaries of S and S' coincide, this isotopy therefore takes each component of $\partial S'$ once around the torus component of ∂M on which it lies. Hence the isotopy defined by N lifts to an isotopy from \tilde{S}' to either $\tau(\tilde{S})$ or $\tau^{-1}(\tilde{S})$. Thus \tilde{S} is isotopic to $\tau(\tilde{S})$. Again by Proposition 4.2 there is a product region between \tilde{S} and $\tau(\tilde{S})$. This contradicts that L is not fibred. \square

Remark 4.6. The condition that L is not fibred is not actually necessary for this result, only for our proof.

Proposition 4.7 ([7] Corollary 3.2). *Suppose surfaces S_0, S_1 bound a product region N . Let S' be an incompressible surface that is transverse to S_0, S_1 . Suppose $S' \cap \text{int}(N) \neq \emptyset$ but $S' \cap (S_1 \cap N) = \emptyset$. Then each component of $S' \cap \text{int}(N)$ bounds a product region with a subsurface of S_0 . In particular, if*

additionally $S' \cap (S_0 \cap N) = \emptyset$ then this component of S' is parallel to those of S_0, S_1 that bound N .

Proposition 4.8 ([5] Corollary 3.4). *Let M_a, M_b be proper 3-submanifolds of \tilde{M} such that ∂M_a and ∂M_b are unions of lifts of minimal genus Seifert surfaces that are almost transverse with simplified intersection. If M_a can be isotoped to have interior disjoint from M_b then the interior of M_a is disjoint from M_b .*

Lemma 4.9 ([5] Lemma 3.5). *Let R_1, R_2, R_3 be minimal genus Seifert surfaces. Then they can be isotoped to be pairwise almost transverse and have pairwise simplified intersection.*

Proposition 4.10 ([5] Proposition 3.2). *In the notation of Proposition 2.4, if R' is almost transverse to and has simplified intersection with R then it minimises $\max\{n : V_{R'} \cap V_n \neq \emptyset\} - \min\{n : V_{R'} \cap V_n \neq \emptyset\}$.*

The following criterion allows us to test for adjacency under Definition 2.5.

Lemma 4.11. *Let R_1, R_2 be fixed, almost disjoint, taut Seifert surfaces for a link L . Then R_1, R_2 demonstrate that their isotopy classes are at most distance 1 apart in $\text{MS}(L)$ if and only if the following holds for all pairs (x, y) of points of $R_1 \setminus R_2$.*

Choose a product neighbourhood $\mathcal{N}(R_1) = R_1 \times [-1, 1]$ in M for R_1 with $R_1 = R_1 \times \{0\}$, such that $R_1 \times \{1\}$ lies on the positive side of R_1 . Let $\rho: I \rightarrow M$ be any path with $\rho(0) = (x, 1)$ and $\rho(1) = (y, -1)$ that is disjoint from R_1 and transverse to R_2 . Then the algebraic intersection number of ρ and R_2 is 1.

Proof. Suppose the condition holds for all pairs (x, y) . If R_1, R_2 coincide everywhere then they are distance 0 apart. Assume otherwise, and let x_0 be a point of $R_1 \setminus R_2$. Choose a lift V_{R_2} of $M \setminus R_2$, and let \tilde{x}_0 be the lift of x_0 that lies in V_{R_2} . Let V_{R_1} be the lift of $M \setminus R_1$ that lies above \tilde{x}_0 , and let \tilde{R}_1 be the lift of R_1 that lies between V_{R_1} and $\tau^{-1}(V_{R_1})$. Then \tilde{x}_0 lies on \tilde{R}_1 , and V_{R_1} meets V_{R_2} and $\tau(V_{R_2})$. We wish to show that these are the only lifts of $M \setminus R_2$ that V_{R_1} meets. Suppose otherwise.

First suppose that V_{R_1} meets $\tau^{-1}(V_{R_2})$. Then there is a path ρ in M that runs from just above x_0 to the projection of a point in $V_{R_1} \cap \tau^{-1}(V_{R_2})$, that is disjoint from R_1 and that has algebraic intersection -1 with R_2 . There is also a path ρ' from this point back to above x_0 that is disjoint from R_2 . We may assume both paths are transverse to R_2 . This forms a closed curve that has algebraic intersection -1 with R_2 . It therefore has algebraic intersection -1 with R_1 .

Consider the first point x_1 at which ρ' crosses R_1 . Then $x_1 \in R_1 \setminus R_2$. If ρ' passes through R_1 in the positive direction at x_1 then the section of

the path $\rho \cup \rho'$ from $(x_0, 1)$ to $(x_1, -1)$ contradicts the hypothesis as it has algebraic intersection -1 with R_2 instead of 1 . Thus ρ' passes through R_1 in the negative direction at x_1 . Stop the path just above x_1 , at $(x_1, 1)$, and add in a path that runs to $(x_1, -1)$ in $M \setminus R_1$. This final section of path has algebraic intersection 1 with R_2 by the hypothesis. Then the complete path gives a contradiction with the hypothesis, as it has algebraic intersection 0 with R_2 . Hence V_{R_1} lies entirely above $\tau^{-1}(V_{R_2})$.

Now suppose V_{R_1} meets $\tau^2(V_{R_2})$. Then there is a path ρ , disjoint from R_1 , from $(x_0, 1)$ to the projection of a point in $V_{R_1} \cap \tau^2(V_{R_2})$ that has algebraic intersection 2 with R_2 . Again, there is a second path ρ' from there to $(x_0, 1)$ that is disjoint from R_2 . The closed curve has algebraic intersection 2 with R_2 and R_1 . Consider the first point x_1 at which ρ' crosses R_1 . Then $x_1 \in R_1 \setminus R_2$. If ρ' passes through R_1 in the positive direction at x_1 then the path up to this point contradicts the hypothesis, as it has intersection 2 with R_2 instead of 1 . Thus it passes through R_1 in the negative direction. Stop the path just above x_1 , at $(x_1, 1)$, and add in a path that runs to $(x_1, -1)$ in $M \setminus R_1$. This final section of path has algebraic intersection 1 with R_2 by the hypothesis. Thus the complete path gives a contradiction with the hypothesis, as it has intersection 3 with R_2 . Hence we have the required result.

Conversely, suppose any lift of $M \setminus R_1$ meets at most two lifts of $M \setminus R_2$. Choose x, y, ρ as in the condition to be checked. Take the lift $\tilde{\rho}$ of ρ with $\tilde{\rho}(0)$ in a fixed lift V_{R_2} of $M \setminus R_2$. We may use $\tilde{\rho}$ in defining the lift V_{R_1} of $M \setminus R_1$. Therefore $\tilde{\rho}$ is contained in two lifts of $M \setminus R_2$ and the lift of R_2 between them. One of these two lifts is V_{R_2} , since this contains the lift $\tilde{\rho}(0)$ of $(x, 1)$. In addition, the lift of $(x, -1)$ lies in $\tau(V_{R_2})$. Thus the lift $\tilde{\rho}(1)$ of $(y, -1)$ is in V_{R_2} or in $\tau(V_{R_2})$. We must show that it is in $\tau(V_{R_2})$. If not then it lies in V_{R_2} . Then the lift of $(y, 1)$ lies in $\tau^{-1}(V_{R_2})$, which is a contradiction. \square

Lemma 4.12. *Let R_a be a taut Seifert surface for L . Suppose $R_{b,0}, R'_{b,0}$ are two copies of a component of a taut Seifert surface for L that are disjoint from R_a and are not isotopic to any component of it. Then $R_{b,0}, R'_{b,0}$ are isotopic by an isotopy that does not meet R_a .*

Proof. By a small isotopy disjoint from R_a , we may ensure that $R_{b,0}, R'_{b,0}$ are transverse. Since they are isotopic, there is a product region N between them. If N meets R_a , it contains a whole component of R_a , which is then isotopic to each of the horizontal boundary components of N . This contradicts that $R_{b,0}$ and $R'_{b,0}$ are not isotopic to any component of R_a . Thus N is disjoint from R_a . If $R_{b,0} \cap R'_{b,0} \neq \emptyset$ then the isotopy defined by N reduces $|R_{b,0} \cap R'_{b,0}|$. If $R_{b,0} \cap R'_{b,0} = \emptyset$ then the isotopy makes $R_{b,0}$ and $R'_{b,0}$ coincide. \square

Lemma 4.13. *Let R_a, R_b be adjacent vertices of $\text{MS}(L)$. Then R_a, R_b can be isotoped so they are disjoint and realise their adjacency.*

Suppose there are components $R_{a,0}$ of R_a and $R_{b,0}$ of R_b that can be made to coincide, so there is a product region between these components. The side of R_a on which this product region lies is determined by the choice of R_a, R_b .

Proof. We regard R_b as fixed, and isotope R_a . Isotope R_a to realise the adjacency. Suppose they are not disjoint, and pick a component $R_{a,0}$ of R_a that is not disjoint from R_b . Because the surfaces realise their adjacency, $R_{a,0}$ cannot cross R_b . Therefore $R_{a,0}$ can be pushed off R_b by a small isotopy. If the two components do not coincide, there is no choice as to which direction to push $R_{a,0}$, and it is clear that the condition in Lemma 4.11 continues to hold.

If $R_{a,0}$ coincides with a component of R_b , it is possible to push it off in either direction, creating a product region. We will see that the choice of direction is forced upon us by wanting the condition in Lemma 4.11 to continue to hold.

As $R_a \neq R_b$, at least one component $R_{a,1}$ of R_a does not coincide with any component of R_b . Fix a point x_0 of $R_{a,1}$, and choose a product neighbourhood $\mathcal{N}(R_a) = R_a \times [-1, 1]$ such that $R_a = R_a \times \{0\}$. For each point y of $R_{a,0}$, choose a path ρ from $(x_0, 1)$ to $(y, -1)$ that is disjoint from R_a and transverse to R_b . Since ρ is contained in $M \setminus R_a$, it has algebraic intersection 0 or 1 with R_b . Suppose that this number is not both well-defined and constant on $R_{a,0}$. That is, suppose there are such points y_0, y_1 and paths ρ_0, ρ_1 such that one gives the value 0 while the other gives the value 1. Let ρ be a path from y_0 to y_1 in $R_{a,0} \times \{-1\}$. Then $\rho \cup \rho_0 \cup \rho_1$ forms a closed curve that has intersection 0 with R_a but intersection 1 with R_b . This is not possible. We therefore have a well-defined value for the algebraic intersection of R_b and a path as described. If this value is 1, push $R_{a,0}$ downwards, and otherwise push it upwards. Then, for $y \in R_{a,0}$, any path from $(x, 1)$ to $(y, -1)$ that is disjoint from R_a has intersection 1 with R_b .

Now pick points x, y and path ρ as in the condition in Lemma 4.11. Isotope ρ so that it decomposes into three paths disjoint from R_a , one from $(x, 1)$ to $(x_0, -1)$, one from $(x_0, -1)$ to $(x_0, 1)$ and one from $(x_0, 1)$ to $(y, -1)$. The outer two paths have intersection 1 with R_b while the middle one has intersection -1 with R_b . Thus ρ has intersection 1 with R_b . \square

5 An ordering on the vertices of $\text{MS}(L_i)$

In [5], a partial ordering $<_S$ is defined on the vertices of $\text{MS}(L)$ for a link L , relative to a fixed vertex S . This ordering only compares adjacent vertices.

Definition 5.1 ([5] Section 5). Let R, R', S be vertices of $\text{MS}(L)$ with R, R' adjacent. Isotope the surfaces so that R, R' are almost transverse to and

have simplified intersection with S , and so that R, R' are almost disjoint with simplified intersection. Set $M = \mathbb{S}^3 \setminus \mathcal{N}(L)$. Let \tilde{M} denote the infinite cyclic cover of M , and let τ be the generating covering transformation (in the positive direction). Let V_S be a lift of $M \setminus S$.

Let V_R be the lift of $M \setminus R$ such that $V_R \cap V_S \neq \emptyset$ but $V_R \cap \tau(V_S) = \emptyset$. Finally, let $V_{R'}$ be the lift of $M \setminus R'$ such that $V_{R'} \cap V_R \neq \emptyset$ but $V_{R'} \cap \tau(V_R) = \emptyset$. See Figure 3.

Then $R' <_S R$ if $V_{R'} \cap V_S \neq \emptyset$.

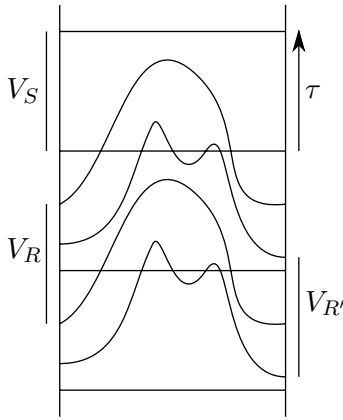

Figure 3

Lemma 5.2 ([5] Lemma 5.3). *Let R, R' be adjacent vertices, and S any vertex. Then $R' <_S R$ or $R <_S R'$.*

Lemma 5.3 ([5] Lemma 5.4). *If $d_{\text{MS}(L)}(R', S) < d_{\text{MS}(L)}(R, S)$ then $R <_S R'$.*

Lemma 5.4 ([5] Lemma 5.5). *There are no R_1, \dots, R_k , for $k \geq 2$, with $R_1 <_S R_2 <_S \dots <_S R_k <_S R_1$.*

Now choose L, L_1, L_2 as in the statement of Theorem 1.2. These will remain fixed for the remainder of this paper.

Definition 5.5. For $i = 1, 2$, let K_i be the link component of L_i along which the connected sum is performed. Let T_0 be a fixed copy of \mathbb{S}^2 that divides L into L_1 and L_2 , and choose a product neighbourhood $T_0 \times [1, 2]$ such that $T_0 = T_0 \times \{\frac{3}{2}\}$ and $T_0 \times \{i\}$ lies on the same side of T_0 as L_i for $i = 1, 2$. We further require that both arcs of $L \cap (T_0 \times [1, 2])$ are of the form $\{x\} \times [1, 2]$ for some $x \in T_0$.

Next, choose a regular neighbourhood $\mathcal{N}(L)$ of L , and let $M = \mathbb{S}^3 \setminus \mathcal{N}(L)$. In addition, let M_0 denote $M \cap (T_0 \times [1, 2])$ and for $i = 1, 2$ denote by M_i the component of $M \setminus (T_0 \times (1, 2))$ that meets L_i . See Figure 4a.

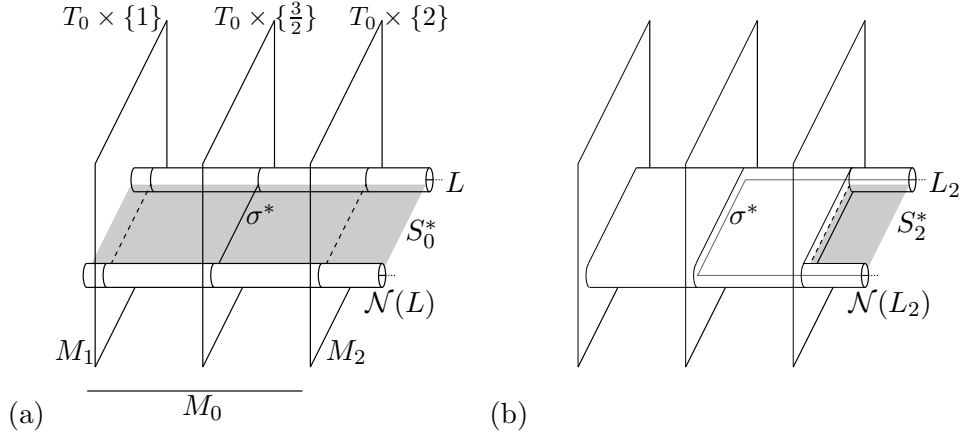

Figure 4

Definition 5.6. Choose a taut Seifert surface S_0 for L . We will use S_0 as a basepoint for $\text{MS}(L)$. Isotope S_0 to have minimal intersection with T_0 . Then $S_0 \cap T_0$ is a single arc σ^* . Further ensure that $S_0 \cap M_0 = \sigma^* \times [1, 2]$. Let S_0^* denote this copy of S_0 , considered as a fixed surface rather than up to isotopy. Again, see Figure 4a.

The link made up of the part of L on the M_1 side of T_0 together with the arc σ^* is L_1 , and M_1 is homeomorphic to $\mathbb{S}^3 \setminus \mathcal{N}(L_1)$. The same is true for L_2 .

The sphere T_0 divides S_0^* into Seifert surfaces S_1, S_2 for L_1, L_2 respectively. Since S_0 is taut, so are S_1, S_2 . Let S_1^*, S_2^* be these surfaces, again considered as fixed. Define curves $\lambda^*, \lambda_1^*, \lambda_2^*$ on $\partial M, \partial M_1, \partial M_2$ respectively, also seen as fixed, by $\lambda^* = \partial S_0^*$ and $\lambda_i^* = \partial S_i^*$ for $i = 1, 2$. By an appropriate choice of $\mathcal{N}(L_i)$ for $i = 1, 2$ we may ensure that $(\sigma^* \times \{i\}) \cap M \subset \lambda_i^*$. See Figure 4b.

Definition 5.7. Define \leq on $V(\text{MS}(L_1))$ by $R \leq R' \Leftrightarrow (R <_{S_1} R' \text{ or } R = R')$. Similarly, define \leq on $V(\text{MS}(L_2))$ by $R \leq R' \Leftrightarrow (R <_{S_2} R' \text{ or } R = R')$.

Corollary 5.8. *The pairs $(\text{MS}(L_1), \leq), (\text{MS}(L_2), \leq)$ are ordered simplicial complexes.*

Proof. Lemma 5.2 gives (P2)', and Lemma 5.4 gives (P1). Together they give (P3). \square

These two orderings, together with that on $V(\mathcal{Z})$, allow us to apply Theorem 3.5. We will use this to give a triangulation of $|\text{MS}(L_1)| \times |\text{MS}(L_2)| \times \mathbb{R}$ that agrees with the triangulation of $\text{MS}(L)$ in a natural way.

6 Choosing representatives of isotopy classes

Given taut Seifert surfaces R_i of L_i for $i = 1, 2$, we can isotope the surfaces so that $\partial R_i = \lambda_i^*$. Having done so, we can glue each of the two surfaces to the rectangle $\sigma^* \times [1, 2]$ to form a taut Seifert surface R of L with $\partial R = \lambda^*$.

An isotopy of any Seifert surface R for L can be split into an isotopy that fixes ∂R and an isotopy supported in a neighbourhood of ∂M . Thus an isotopy class relative to the boundary corresponds to a fixed element of the isotopy class together with a winding number for each boundary component. To measure the winding numbers, we need to decide what it means to have winding number 0. We use S_i^* as a basepoint for $\text{MS}(L_i)$, setting this to have winding number 0 at each boundary component. We want to define what it means for another surface to have winding number 0. In practice we will only be concerned with the winding number at K_i , but it is convenient to choose surfaces fixed at every boundary component.

Thus our present aim is to find a fixed representative R^* for each vertex R of $\text{MS}(L_i)$. We choose these such that $\partial R^* = \lambda_i^*$. We also want these representatives to interact well with regard to the ordering \leq .

Definition 6.1. Let R, R' be ∂ -almost disjoint taut Seifert surfaces for L_i . Pick a component K' of L_i , and consider R, R' near K' . It may be that the components that meet K' coincide. If not, one of the two surfaces lies ‘above’ the other, where this is measured in the positive direction around K' . Write $R \leq_{K'} R'$ if either R' lies above R or the two coincide.

Definition 6.2. Define a relation \leq_∂ on isotopy classes of taut Seifert surfaces relative to the boundary by $R \leq_\partial R'$ if there are representatives R_b of R and R'_a of R' such that R_b, R'_a are ∂ -almost disjoint and $R_b \leq_{K'} R'_a$ for each component K' of L_i .

Lemma 6.3. *The relation \leq_∂ is antisymmetric.*

Proof. Suppose otherwise. Choose R, R' with $R \leq_\partial R' \leq_\partial R$ and $R \neq R'$. Consider R' as fixed, and choose representatives R_a, R_b of R such that R_a shows that $R' \leq_\partial R$ and R_b shows that $R \leq_\partial R'$. Note that $\partial R' = \partial R_a = \partial R_b = \lambda_i^*$.

The surface R_a might be disconnected. However, at least one component of R_a is not isotopic to any component of R' . Remove all other components of R_a , and the corresponding ones of R_b . Also remove all components of R' that are disjoint from the new R_a .

As R_a, R_b only meet a neighbourhood of R' along their boundaries, where we know how they are positioned, we see that R_a, R_b can be put into general position by an isotopy away from a neighbourhood of R' . Choose this isotopy to minimise $|R_a \cap R_b|$.

Consider the product region N between R_a and R_b given by Corollary 4.5. The isotopy of R_a defined by N does not move ∂R_a , so our positioning

of R_a, R_b means that N must meet R' . Let R'_0 be a component of R' that meets N . Then $R'_0 \subset N$. Since R'_0 is ∂ -almost disjoint from R_a and from R_b , Proposition 4.7 gives that R'_0 is isotopic to R_a , which is a contradiction. \square

Proposition 6.4. *It is possible to choose a representative R^* for each vertex R of $\text{MS}(L_i)$ such that the following conditions hold for any pair (R_a, R_b) of adjacent vertices of $\text{MS}(L_i)$.*

- $\partial R_a^* = \partial R_b^* = \lambda_i^*$.
- *There are ∂ -almost disjoint copies R'_j of R_j , for $j = a, b$, that are isotopic to R_j^* via isotopies fixing $\partial R'_j$ and that demonstrate their adjacency.*
- $R_b^* \leq_{\partial} R_a^*$ (equivalently, $R'_b \leq_{\partial} R'_a$) if and only if $R_b \leq R_a$.

Proof. Without loss of generality, $i = 1$. Let \tilde{M}_1 be the infinite cyclic cover of M_1 , with covering transformation τ_1 . As in Proposition 2.4, construct a lift V_n of $M_1 \setminus S_1^*$ for $n \in \mathbb{Z}$. Let \tilde{S}_1 be the lift of S_1^* that lies between V_0 and V_1 .

We have already chosen the representative S_1^* for S_1 . Let R be a vertex of $\text{MS}(L_1)$ other than S_1 . Isotope R to be almost transverse to and have simplified intersection with S_1^* . Let V_R be the lift of $M_1 \setminus R$ such that $V_R \cap V_0 \neq \emptyset$ but $V_R \cap V_1 = \emptyset$, and let \tilde{R} be the lift of R that lies between V_R and $\tau_1(V_R)$. From Proposition 4.10 we see that R minimises $\max\{n : V_R \cap V_n \neq \emptyset\} - \min\{n : V_R \cap V_n \neq \emptyset\}$. By Proposition 2.4 this means that $\{n : V_R \cap V_n \neq \emptyset\} = \{0, -1, \dots, -d_{\text{MS}(L_1)}(S_1, R)\}$.

By an isotopy close to the boundary, move ∂R around $\partial \mathcal{N}(L_1)$ until $\partial \tilde{R}$ coincides with $\partial \tilde{S}_1$. Note that this does not change $\{n : V_R \cap V_n \neq \emptyset\}$. Take the resulting surface to be R^* .

Our first aim is to show that the choice of R^* is well-defined up to isotopy relative to the boundary. That is, we wish to check that the choice of winding number is independent of the choice of isotopy made when constructing R^* . Let R' be any other copy of R . Construct $(R')^*$ as described. Then $\partial \tilde{R} = \partial \tilde{R}' = \partial \tilde{S}_1$. Note that we do not know how R and R' intersect. However, R is isotopic to R' in M_1 . This isotopy lifts to an isotopy in \tilde{M}_1 from \tilde{R} to a lift of R' . This lift is $\tau_1^m(\tilde{R}')$ for some $m \in \mathbb{Z}$. The isotopy also takes V_R to $\tau_1^m(V_{R'})$.

Suppose $m \neq 0$. Without loss of generality, $m > 0$. Then the submanifold $\tau_1^m(V_{R'} \cup \tilde{R}' \cup \tau_1^{-1}(\tilde{R}'))$ of \tilde{M}_1 has interior disjoint from the submanifold $\tau_1^{-k}(V_0 \cup \tilde{S}_1 \cup \tau_1^{-1}(\tilde{S}_1))$, where $k = d_{\text{MS}(L_1)}(S_1, R)$. Thus by Proposition 4.8 we see that V_R is disjoint from V_{-k} . This contradicts that $\{n : V_R \cap V_n \neq \emptyset\} = \{0, -1, \dots, -k\}$. Hence $m = 0$. We can therefore modify the isotopy from R to R' near the boundary to keep ∂R fixed throughout. Thus R^* and $(R')^*$ are isotopic relative to the boundary, as required.

It remains to show that our chosen representatives have the required properties. Let R_a, R_b be adjacent vertices of $\text{MS}(L_1)$ with $R_b \leq R_a$. Position them relative to S_1^* and each other as in Lemma 4.9. Then by Proposition 4.10 we know that R_a, R_b realise their adjacency, and so are almost disjoint.

Now consider the lifts used to demonstrate that $R_b <_{S_1} R_a$, as in Definition 5.1. Taking V_0 as the lift of $M_1 \setminus S_1^*$ we see that V_{R_a} is the required lift of $M_1 \setminus R_a$. Let V'_{R_b} be the required lift of $M_1 \setminus R_b$. Then V'_{R_b} meets V_0 but does not meet V_1 . Thus $V'_{R_b} = V_{R_b}$. This means that \tilde{R}_b lies below \tilde{R}_a in \tilde{M}_1 . Now isotope R_a and R_b near the boundary to form R_a^* and R_b^* . Then it is clear that $\partial R_a^* = \partial R_b^* = \lambda_1^*$ and $R_b^* <_{\partial} R_a^*$. In addition, they continue to realise their adjacency and are ∂ -almost disjoint. \square

Remark 6.5. Suppose R_a and R_b are positioned as required, and that $R_b \leq R_a$. Suppose a component of R_b coincides with a component of R_a . By Lemma 4.13 there is a unique direction we can push the component of R_b off that of R_a so that they continue to realise their adjacency. By examining the construction above we see that this direction is downwards. To see this, note that the components must coincide when we lift them to the infinite cyclic cover, as the boundaries of the lifts coincide.

7 Mapping the vertices

Definition 7.1. Define a map $\Psi: \text{V}(\text{MS}(L_1)) \times \text{V}(\text{MS}(L_2)) \times \mathbb{Z} \rightarrow \text{V}(\text{MS}(L))$ as follows. Let $(R_1, R_2, n) \in \text{V}(\text{MS}(L_1)) \times \text{V}(\text{MS}(L_2)) \times \mathbb{Z}$. Take the copy of R_1^* in M_1 , and the copy of R_2^* in M_2 . Join these together by a rectangle in M_0 that winds n times around L . Here we measure the winding number of the rectangle around the arc of L that runs through M_0 and is oriented from L_1 to L_2 , with respect to where λ^* lies on the boundary of the neighbourhood of this arc. Let R be the resulting surface. Note that R is a taut Seifert surface for L . If $n \neq 0$ then $\partial R \neq \lambda^*$, but $[\partial R] = [\lambda^*]$. We set $\Psi(R_1, R_2, n)$ to be the isotopy class of R .

Lemma 7.2. Ψ is surjective.

Proof. Let R be a taut Seifert surface for L . Isotope R to have minimal intersection with T_0 , and so that $R \cap M_0 = \rho \times [1, 2]$ for some arc $\rho \subset T_0$. Then T_0 cuts R into taut Seifert surfaces R_i of L_i for $i = 1, 2$. Isotope R_i to R_i^* . This isotopy may move ∂R_i in M_i . However, the isotopy of M_i can be extended to an isotopy of M by also isotoping the rectangle $R \cap M_0$ in M_0 near $T_0 \times \{i\}$. After these isotopies, we can read off the winding number n of the rectangle. Then $\Psi(R_1, R_2, n) = R$. \square

Lemma 7.3. Ψ is injective.

Proof. Suppose $\Psi(R_{a,1}, R_{a,2}, n_a) = \Psi(R_{b,1}, R_{b,2}, n_b)$. We first aim to show that $R_{a,1} = R_{b,1}$ and $R_{a,2} = R_{b,2}$. Let R_a, R_b be the fixed surfaces constructed by Ψ . Note that, by construction, R_a and R_b each meet T_0 in a single arc, and these arcs either coincide or are disjoint. We can ensure that the arcs are disjoint using an isotopy of R_a that breaks into an isotopy of $R_{a,1}$ and an isotopy of $R_{a,2}$. By an isotopy of R_a keeping T_0 fixed pointwise, R_a and R_b can be made transverse.

As the surfaces are isotopic, there is a product region N between them. If $\text{int}(N)$ meets T_0 then $T_0 \cap N$ is a product disc in the sutured manifold N , and divides N into product regions N_1, N_2 . The isotopy of R_a defined by N therefore breaks into an isotopy of $R_{a,1}$ and an isotopy of $R_{a,2}$. It either reduces $|R_a \cap R_b|$ or makes components of R_a and R_b coincide. Inductively we find that $R_{a,1} = R_{b,1}$ and $R_{a,2} = R_{b,2}$.

It remains to show that $\Psi(R_{a,1}, R_{a,2}, n_a) \neq \Psi(R_{a,1}, R_{a,2}, n_b)$ for $n_a > n_b$. Suppose otherwise. Without loss of generality, $n_b = 0$. Consider the fixed surfaces $R_a = \Psi(R_{a,1}, R_{a,2}, n_a), R_0 = \Psi(R_{a,1}, R_{a,2}, 0)$. Push the component of the copy of $R_{a,1}$ in R_a that meets K_1 upwards off R_0 , and the copy of $R_{a,2}$ downwards. Delete all other components of each surface. By the assumption that $\Psi(R_{a,1}, R_{a,2}, n_a) = \Psi(R_{a,1}, R_{a,2}, 0)$, the two remaining surfaces are isotopic, so there is a product region N between them. Note that N meets $\partial\mathcal{N}(K_1 \# K_2)$. By considering the boundary curves of the surfaces on $\partial\mathcal{N}(K_1 \# K_2)$, we can restrict the possibilities for the location of N relative to R_a, R_0 . To see this, note that N only meets one side of each of the orientable surfaces R_a, R_0 . Figure 5 shows the boundary patterns in the cases $n_a \in \{1, 2, 3, 4\}$. In general we see that N must meet the complement of one of the L_i in the complement of the surface $R_{a,i}$. Suppose this is L_1 . Then $T_0 \times \{1\}$ is a product disc in N . This means $\mathbb{S}^3 \setminus \mathcal{N}(R_{a,1})$ is a product region, showing that L_1 is fibred, which is a contradiction. \square

8 Mapping the edges

Lemma 8.1. Let $R_{a,i}, R_{b,i}$ be fixed almost disjoint taut Seifert surfaces that demonstrate that their isotopy classes are adjacent in $\text{MS}(L_i)$ for $i = 1, 2$. Suppose that there are arcs $\rho_j \subset T_0$ for $j = a, b$ such that $R_{j,i} \cap (T_0 \times \{i\}) = \rho_j \times \{i\}$ for $i = 1, 2$. Suppose further that ρ_a and ρ_b are disjoint. Let $R_j = R_{j,1} \cup R_{j,2} \cup (\rho_j \times [1, 2])$ for $j = a, b$. Then R_a, R_b demonstrate that their isotopy classes are adjacent in $\text{MS}(L)$.

Proof. The pairs $R_{a,i}, R_{b,i}$ satisfy the condition given in Lemma 4.11. We wish to show that R_a, R_b also satisfy this condition. First note that R_a and R_b are almost disjoint.

Choose points $x, y \in R_a \setminus R_b$, an appropriate product neighbourhood of R_a and a path ρ from $(x, 1)$ to $(y, -1)$ that is disjoint from R_a and transverse

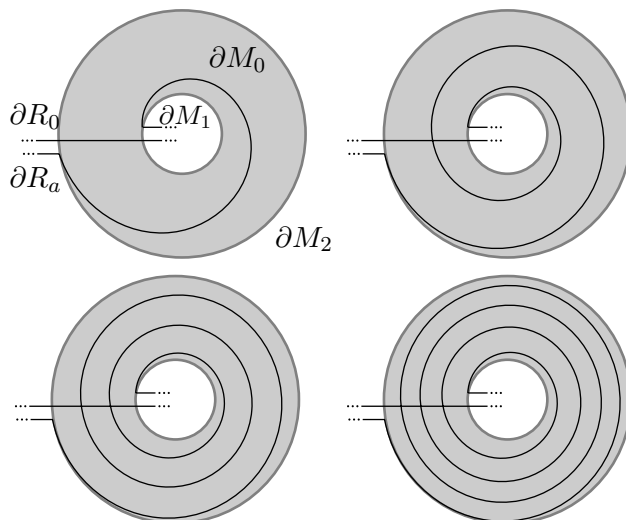

Figure 5

to R_b . By a small isotopy, ρ also can be made transverse to T_0 . If ρ is disjoint from T_0 , it has algebraic intersection 1 with R_b , as required.

Suppose otherwise. Let x_0 be the first point at which ρ meets T_0 . Find an arc ρ_0 from $R_a \times \{1\}$ to $R_a \times \{-1\}$ such that ρ_0 lies entirely in T_0 and passes through x_0 . We can then use ρ_0 to split ρ into three paths as in the condition in Lemma 4.11, each of which (up to isotopy) has strictly fewer points of intersection with T_0 . The first path runs along ρ as far as x_0 , and then follows ρ_0 up to $R_a \times \{-1\}$. The second is ρ_0 traversed backwards. The third runs along ρ_0 to x_0 , and then runs along the rest of ρ . The first two paths can be made disjoint from T_0 , and run in opposite directions. Hence removing them does not change the algebraic intersection number with R_b . In this way we can remove all points of $\rho \cap T_0$. \square

Corollary 8.2. *Let $(R_{a,1}, R_{a,2}, n_a)$ and $(R_{b,1}, R_{b,2}, n_b)$ be in $V(\text{MS}(L_1)) \times V(\text{MS}(L_2)) \times \mathbb{Z}$ with $R_{b,2} \leq R_{a,2}$. Suppose these triples are distinct and one of the following conditions holds.*

- $R_{a,1} \geq R_{b,1}$ and $n_a = n_b$.
- $R_{a,1} \leq R_{b,1}$ and $n_a = n_b - 1$.

Then $\Psi(R_{a,1}, R_{a,2}, n_a)$ and $\Psi(R_{b,1}, R_{b,2}, n_b)$ are adjacent in $\text{MS}(L)$.

Proof. Viewing $\Psi(R_{a,1}, R_{a,2}, n_a)^*$ as fixed, we build a copy of $\Psi(R_{b,1}, R_{b,2}, n_b)$ satisfying the hypotheses of Lemma 8.1. Without loss of generality, $n_a = 0$.

Isotope $R_{b,2}^*$ as in Proposition 6.4 to realise its adjacency with $R_{a,2}^*$. For any components of $R_{b,2}$ that do not coincide with those of $R_{a,2}^*$, perform a small isotopy near the boundary to move the boundary of $R_{b,2}$ to below that

of $R_{a,2}^*$, making the components disjoint. Consider the pairs of components that meet K_2 . If these components of $R_{a,2}^*, R_{b,2}$ coincide then push that in $R_{b,2}$ downwards off $R_{a,2}^*$. By Remark 6.5, $R_{a,2}$ and $R_{b,2}$ still realise their adjacency.

Case 1: $R_{a,1} \geq R_{b,1}$ and $n_b = n_a = 0$. Then $R_{b,1} \leq_{\partial} R_{a,1}$. Perform isotopies on $R_{b,1}^*$ analogous to those performed on $R_{b,2}^*$. A flat rectangle can then be inserted connecting the boundaries of the surfaces $R_{b,1}, R_{b,2}$.

Case 2: $R_{a,1} \leq R_{b,1}$ and $n_b = n_a + 1 = 1$. Then $R_{a,1} \leq_{\partial} R_{b,1}$. This time isotope $R_{b,1}^*$ upwards instead of downwards, so the boundary of $R_{b,1}$ lies above that of $R_{a,1}^*$ wherever they do not coincide. Add in a rectangle that wraps nearly once around $K_1 \# K_2$, to again join up the boundaries of $R_{b,1}, R_{b,2}$.

It is clear that, in either case, $\Psi(R_{b,1}, R_{b,2}, n_b)^*$ is isotopic to the surface R_b we have constructed. We may now apply Lemma 8.1 to complete the proof. \square

Proposition 8.3. *Let $(R_{a,1}, R_{a,2}, n_a)$ and $(R_{b,1}, R_{b,2}, n_b)$ be in $V(\text{MS}(L_1)) \times V(\text{MS}(L_2)) \times \mathbb{Z}$. Suppose $\Psi(R_{a,1}, R_{a,2}, n_a)$ and $\Psi(R_{b,1}, R_{b,2}, n_b)$ are adjacent in $\text{MS}(L)$. Then one of the conditions in Corollary 8.2 holds.*

Proof. Without loss of generality, $n_a = 0$. Fix $\Psi(R_{a,1}, R_{a,2}, n_a)^*$ and isotope $\Psi(R_{b,1}, R_{b,2}, n_b)$ to be disjoint from it, realising the adjacency in $\text{MS}(L)$. Since $T_0 \cap (M_0 \setminus \Psi(R_{a,1}, R_{a,2}, n_a)^*)$ is a disc, by standard methods we can also ensure that this copy of $\Psi(R_{b,1}, R_{b,2}, n_b)$ meets T_0 in a single arc. As in the proof of Lemma 7.2, dividing the surface along T_0 gives (fixed) Seifert surfaces $R'_{b,i}$ in $\text{MS}(L_i)$ for $i = 1, 2$ and there is an integer n'_b such that $\Psi(R'_{b,1}, R'_{b,2}, n'_b)$ is isotopic to $\Psi(R_{b,1}, R_{b,2}, n_b)$. See Figure 7. By Lemma 7.3 we have in particular that $R'_{b,i}$ is isotopic to $R_{b,i}$ in M_i for $i = 1, 2$. From this we see that $R_{a,i}^*, R'_{b,i}$ demonstrate that $R_{a,i}, R_{b,i}$ are at most distance 1 apart in $\text{MS}(L_i)$. We may now assume that $R_{b,2} \leq R_{a,2}$.

It now remains to verify that n_b takes the required value. Our approach is to position $\Psi(R_{b,1}, R_{b,2}, n_b)$ ‘close to’ $R_{b,i}^*$ for $i = 1, 2$ without affecting the relative positions of $\Psi(R_{b,1}, R_{b,2}, n_b)$ and $\Psi(R_{a,1}, R_{a,2}, n_a)^*$. Having done so, we will be able to read off the value of n_b from $\Psi(R_{b,1}, R_{b,2}, n_b)$.

For $i = 1, 2$, consider $R_{a,i}^*$ and $R_{b,i}^*$, which satisfy the conclusions of Proposition 6.4. As an isotopy of $R_{b,i}^*$ that fixes its boundary will not affect the winding number n_b , we may assume that no such isotopy is needed in this case. That is, we assume that $R_{a,i}^*$ and $R_{b,i}^*$ are ∂ -almost disjoint and realise their adjacency. We further assume that components of $R_{a,i}^*$ and $R_{b,i}^*$ coincide whenever this is possible without moving the boundary of either surface.

Suppose that a component of $R_{b,i}^*$ and a component of $R_{a,i}^*$ bound a product region N in M_i , but that any isotopy from one to the other moves the boundary of the surface. Since the boundaries of $R_{a,i}^*$ and $R_{b,i}^*$ coincide,

the component of $R_{b,i}^*$ is given by taking a parallel copy of that of $R_{a,i}^*$ and moving its boundary once around L_i , as shown in Figure 6. Note that N lies

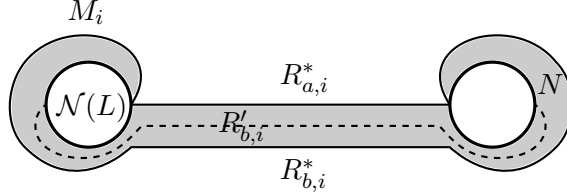

Figure 6

below $R_{a,i}^*$ if $R_{a,i}^* \leq \partial R_{b,i}^*$ and N lies above $R_{a,i}^*$ if $R_{b,i}^* \leq \partial R_{a,i}^*$. In addition, a component of $R_{b,i}^*$ must be contained in the product region N and be isotopic to the component of $R_{a,i}^*$. In particular, from Proposition 6.4 we see that if $R_{a,i}^* \leq R_{b,i}^*$ then the component of $R_{b,i}^*$ lies above that of $R_{a,i}^*$ and its boundary can be seen as lying above that of $R_{a,i}^*$, whereas if $R_{b,i}^* \leq R_{a,i}^*$ then the component of $R_{b,i}^*$ lies below that of $R_{a,i}^*$ and its boundary can be seen as lying below that of $R_{a,i}^*$.

For $i = 1, 2$, temporarily ignore the components of each surface that meet K_i . If a component of $R_{b,i}^*$ coincides with a component of $R_{a,i}^*$, then there is a product region between it and the corresponding component of $R_{b,i}^*$. Such components will play no part in the rest of the proof, so we may assume that there are none.

For each other component of $R_{b,i}^*$, there are two possibilities. If it is isotopic to a component of $R_{a,i}^*$, we have already seen how it relates to $R_{b,i}^*$. Otherwise, take a copy of this component of $R_{b,i}^*$ that lies parallel to $R_{b,i}^*$ and is disjoint from $R_{a,i}^*$. That is, there is a product region between $R_{b,i}^*$ and this copy of $R_{b,i}^*$ that is contained within a product neighbourhood of $R_{b,i}^*$. Furthermore, this product region lies above $R_{b,i}^*$ if $R_{a,i}^* \leq \partial R_{b,i}^*$ and lies below $R_{b,i}^*$ if $R_{b,i}^* \leq \partial R_{a,i}^*$. By Lemma 4.12, the corresponding component of $R_{b,i}^*$ is now isotopic to that of $R_{b,i}^*$ by an isotopy disjoint from $R_{a,i}^*$. We may therefore assume that these components of $R_{b,i}^*$, $R_{b,i}^*$ now coincide. Hence for each component of $R_{b,i}^*$ away from K_i we have the following. If $R_{a,i}^* \leq R_{b,i}^*$ then the boundary of $R_{b,i}^*$ lies above that of $R_{a,i}^*$. If $R_{b,i}^* \leq R_{a,i}^*$ then the boundary of $R_{b,i}^*$ lies below that of $R_{a,i}^*$. Recall that we have assumed that no such components exist if $R_{a,i}^* = R_{b,i}^*$, and that $R_{b,2} \leq R_{a,2}$.

We now turn our attention to the components that meet K_i .

Case 1: This component of $R_{b,i}^*$ does not coincide with $R_{a,i}^*$ for $i = 1, 2$. Note that this means $R_{a,i}^* \neq R_{b,i}^*$, because $R_{a,i}^*$ and $R_{b,i}^*$ are not isotopic by an isotopy fixing their boundaries. In this case, the corresponding component of $R_{b,i}^*$ can also be isotoped as just described. There is now an essentially unique way to join the two surfaces by a rectangle in M_0 that is disjoint

from $\Psi(R_{a,1}, R_{a,2}, n_a)^*$. If $R_{b,1} \leq R_{a,1}$ then the rectangle must be flat, so $n_b = 0 = n_a$. If $R_{a,1} \leq R_{b,1}$ then the rectangle must twist nearly once around $\partial\mathcal{N}(K_1\#K_2)$ from above $R_{a,1}^*$ to below $R_{a,2}^*$ (that is, twisting in the positive direction around $K_1\#K_2$), so $n_b = 1 = n_a + 1$. See Figure 7.

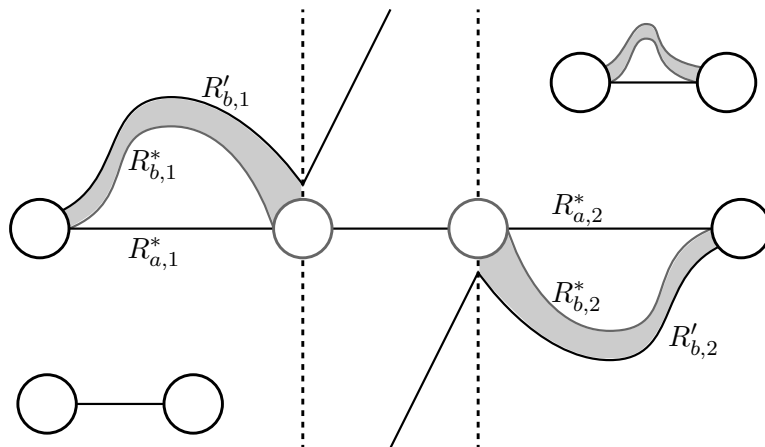

Figure 7

Case 2: The component of $R_{b,2}^*$ coincides with that of $R_{a,2}^*$, but those of $R_{a,1}^*, R_{b,1}^*$ do not coincide. Then $R_{a,1} \neq R_{b,1}$. Again isotope $R'_{b,1}$ as above. The component of $R'_{b,2}$ that meets K_2 is isotopic in M_2 to that of $R_{a,2}^*$, meaning there is a product region N between them in M_2 . Note that the interior of N is disjoint from the three surfaces $R_{a,2}^*, R_{b,2}^*, R'_{b,2}$. Once we know which side of $R_{a,2}^*$ the product region N lies (this is well-defined, by Lemma 4.13), there is only one possibility for the rectangle joining the surfaces $R'_{b,1}, R'_{b,2}$, as in Case 1.

If $R_{a,2} = R_{b,2}$ then we may further assume that $R_{b,1} \leq R_{a,1}$, and in particular that the boundary of $R'_{b,1}$ lies below that of $R_{a,1}^*$. If N lies below $R_{a,2}^*$ then the rectangle is flat, so $n_b = 0 = n_a$. If N lies above $R_{a,2}^*$ then the rectangle runs in the negative direction around $K_1\#K_2$, from below $R_{a,1}^*$ to above $R_{a,2}^*$. Hence $n_b = -1 = n_a - 1$. Note that this satisfies the condition in Corollary 8.2 with the two surfaces switched.

Suppose instead that $R_{a,2} \neq R_{b,2}$. If N lies below $R_{a,2}^*$ then there are two possible situations. One is that $R_{b,1} \leq R_{a,1}$ and $n_b = n_a$. The other is that $R_{a,1} \leq R_{b,1}$ and $n_b = n_a + 1$. It therefore remains to rule out the possibility that N lies above $R_{a,2}^*$. For this we must return to the definitions of $R_{a,2}^*, R_{b,2}^*$. Originally we chose these to be ∂ -almost disjoint, with $R_{b,2}^* \leq_{\partial} R_{a,2}^*$. As they now coincide, the components that meet K_2 were isotopic by an isotopy keeping their boundaries fixed. Corollary 4.5 therefore shows there was a product region N' between these components that lay below $R_{a,2}^*$ and above $R_{b,2}^*$. However, Lemma 4.13 says that the side of $R_{a,2}^*$ on

which N lies is determined by the choice of surfaces $R_{a,2}, R_{b,2}$. Therefore N cannot lie above $R_{a,2}^*$.

Case 3: The component of $R_{b,1}$ coincides with that of $R_{a,1}^*$, but those of $R_{a,2}^*, R_{b,2}$ do not coincide. This is similar to case 2.

Case 4: Both pairs of components coincide. This case again uses the same ideas as cases 1 and 2. The only situation that is very different is when $R_{a,1} = R_{b,1}$ and $R_{a,2} = R_{b,2}$, when we must show that $n_a \neq n_b$. However this is true since $\Psi(R_{a,1}, R_{a,2}, n_a) \neq \Psi(R_{b,1}, R_{b,2}, n_b)$. \square

Figure 8 is a schematic picture of the local structure of $\text{MS}(L)$. Figure 8a focuses on the edges radiating from a single vertex. Figure 8b shows one of the smaller cubes in Figure 8a, with all edges included.

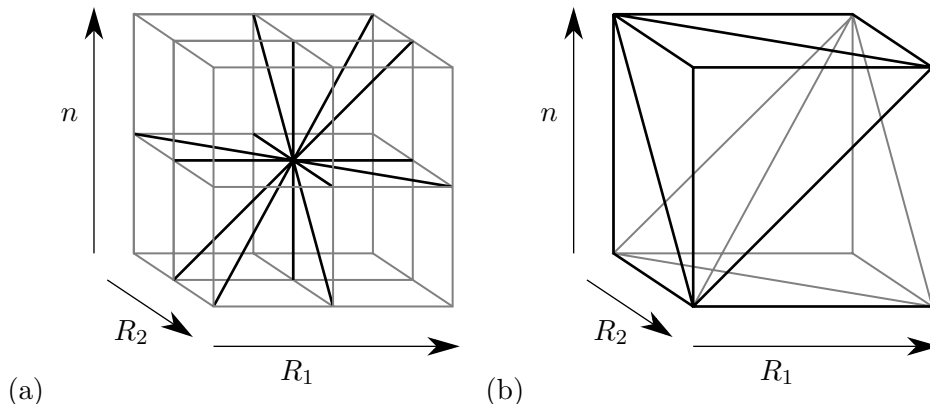

Figure 8

9 Completing and interpreting the proof

Theorem 1.2. *Let L_1, L_2 be non-split, non-fibred, links in \mathbb{S}^3 , and let $L = L_1 \# L_2$. Then $|\text{MS}(L)|$ is homeomorphic to $|\text{MS}(L_1)| \times |\text{MS}(L_2)| \times \mathbb{R}$.*

Proof. Define an ordering \leq_1 on $V(\text{MS}(L_1)) \times V(\mathcal{Z})$ by

$$(R_b, n_b) \leq_1 (R_a, n_a) \iff (R_b \leq R_a \text{ and } n_b \leq n_a).$$

By Theorem 3.5,

$$|(\text{MS}(L_1) \times \mathcal{Z}, \leq_1)| \cong |(\text{MS}(L_1), \leq)| \times |(\mathcal{Z}, \leq)|.$$

Now define a second ordering \leq_2 on $V(\text{MS}(L_1)) \times V(\mathcal{Z})$ by

$$(R_b, n_b) \leq_2 (R_a, n_a) \iff ((R_b \leq R_a \text{ and } n_b = n_a) \text{ or } (R_a \leq R_b \text{ and } n_a = n_b - 1)).$$

Note that this corresponds to the conditions in Corollary 8.2. It can be checked that \leq_2 has properties (P1), (P2)', (P3).

Define \leq_3 on $V(\text{MS}(L_1) \times \mathcal{Z}) \times V(\text{MS}(L_2))$ by

$$\begin{aligned} ((R_{a,1}, n_a), R_{a,2}) \leq_3 ((R_{b,1}, n_b), R_{b,2}) &\iff \\ &((R_{a,1}, n_a) \leq_2 (R_{b,1}, n_b) \text{ and } R_{a,2} \leq R_{b,2}). \end{aligned}$$

Applying Theorem 3.5 again gives that

$$|((\text{MS}(L_1) \times \mathcal{Z}) \times \text{MS}(L_2), \leq_3)| \cong |(\text{MS}(L_1) \times \mathcal{Z}, \leq_2)| \times |(\text{MS}(L_2), \leq)|.$$

Thus

$$|(\text{MS}(L_1) \times \mathcal{Z}) \times \text{MS}(L_2)| \cong |\text{MS}(L_1)| \times |\text{MS}(L_2)| \times \mathbb{R}.$$

By Lemmas 7.2 and 7.3, the map $\psi: V(\text{MS}(L_1)) \times V(\text{MS}(L_2)) \times V(\mathcal{Z}) \rightarrow V(\text{MS}(L))$ defined in Definition 7.1 is a bijection. Recall that

$$V((\text{MS}(L_1) \times \mathcal{Z}) \times \text{MS}(L_2)) = V(\text{MS}(L_1)) \times V(\text{MS}(L_2)) \times V(\mathcal{Z}).$$

From Corollary 8.2 and Proposition 8.3 we see that ψ extends to an isomorphism between the 1-skeleta of the complexes $(\text{MS}(L_1) \times \mathcal{Z}) \times \text{MS}(L_2)$ and $\text{MS}(L)$. It remains only to note that both of these complexes are flag. For $\text{MS}(L)$ this is the case by definition. For $(\text{MS}(L_1) \times \mathcal{Z}) \times \text{MS}(L_2)$ it follows from the fact that the three complexes $\text{MS}(L_1)$, $\text{MS}(L_2)$ and \mathcal{Z} are flag. \square

By examining the proof of Theorem 3.5 in [1] we can give the following geometric description of the extension of Ψ to $(\text{MS}(L_1) \times \mathcal{Z}) \times \text{MS}(L_2)$.

Remark 9.1. Let $x \in |\text{MS}(L_1)| \times |\text{MS}(L_2)| \times \mathbb{R}$. Without loss of generality, $\pi_{\mathcal{Z}}(x) \in [0, 1]$. Let $\pi_{\text{MS}(L_1)}(x) = a_0 A_0 + \dots + a_m A_m$ where $A_i \in V(\text{MS}(L_1))$ and $a_i > 0$ for $0 \leq i \leq m$, with $\sum_{i=0}^m a_i = 1$ and $A_0 \leq A_1 \leq \dots \leq A_m$. Similarly let $\pi_{\text{MS}(L_2)}(x) = b_0 B_0 + \dots + b_n B_n$.

Consider the surfaces A_0, \dots, A_m . As in Lemma 4.9, they can be positioned in M_1 so they are pairwise almost disjoint with simplified intersection. By Proposition 4.10, they then realise their adjacencies. As in the proof of Lemma 4.13, the surfaces can be made disjoint while still realising their adjacencies, and it can be shown that the boundaries of the surfaces occur in order around ∂M_1 . For $i = 0, \dots, m$, thicken the Seifert surface A_i to a product region $A_i \times [0, a_i]$, and view this as a ‘continuum of surfaces’.

Do the same for the Seifert surfaces B_0, \dots, B_n in M_2 . Glue the thickened surfaces to give thickened Seifert surfaces for L in M . In doing so, instead of aligning $A_0 \times \{0\}$ with $B_0 \times \{0\}$, introduce a shift of length $\pi_{\mathcal{Z}}(x)$. This creates a finite set of vertices of $\text{MS}(L)$, each with a weight given by its thickness. Applying Lemma 8.1 shows that these vertices span a simplex.

10 Incompressible surfaces

In addition to $\text{MS}(L)$, Kakimizu defined a larger complex $\text{IS}(L)$, which records all incompressible Seifert surfaces for L rather than just taut ones.

Definition 10.1 (see [3], [5]). Let L be a link, and let $M = \mathbb{S}^3 \setminus \mathcal{N}(L)$. Define $\text{IS}(L)$ of L to be the following flag simplicial complex. Its vertices are ambient isotopy classes of incompressible Seifert surfaces for L . Two vertices span an edge if they have representatives R, R' such that a lift of $M \setminus R'$ to the infinite cyclic cover of M intersects exactly two lifts of $M \setminus R$.

Note that $\text{MS}(L)$ is a subcomplex of $\text{IS}(L)$. Proposition 2.4 holds for $\text{IS}(L)$ as well as for $\text{MS}(L)$, and so do Propositions 4.8 and 4.10, and Lemma 4.9. The same is true of Lemmas 5.2, 5.3 and 5.4.

Let R be an incompressible Seifert surface for L . Isotope R to have minimal intersection with T_0 . Then $R \cap T_0$ is a single arc. Splitting R along T_0 gives incompressible Seifert surfaces R_1, R_2 for L_1, L_2 respectively.

Now consider the converse situation. That is, take incompressible Seifert surfaces R_1, R_2 for L_1, L_2 respectively, and join them along an arc in T_0 to form a Seifert surface R for L .

Lemma 10.2. *R is incompressible.*

Proof. Suppose otherwise. Choose a compressing disc S for R that minimises its intersection with T_0 over all compressing discs for R . Then $S \cap T_0$ does not include any simple closed curves. In addition, S is not disjoint from T_0 , as otherwise it would be a compressing disc for either R_1 or R_2 . Let ρ be an arc of $S \cap T_0$ that is outermost in the disc $T_0 \cap (M_0 \setminus R)$. Then ρ cuts off a subdisc S_T of $T_0 \cap (M_0 \setminus R)$ that is disjoint on its interior from S . It also divides S into two discs S_1 and S_2 . Since $|S \cap T_0|$ cannot be reduced, each of the discs $S_1 \cup S_T$ and $S_2 \cup S_T$ is a compressing disc for R . Furthermore, each can be isotoped to have a smaller intersection with T_0 than S does, which is a contradiction. \square

Now replacing taut Seifert surfaces with incompressible Seifert surfaces in the proof of Theorem 1.2 gives the following.

Theorem 10.3. *Let L_1, L_2 be non-split, non-fibred, links in \mathbb{S}^3 , and let $L = L_1 \# L_2$. Then $|\text{IS}(L)|$ is homeomorphic to $|\text{IS}(L_1)| \times |\text{IS}(L_2)| \times \mathbb{R}$.*

References

- [1] Samuel Eilenberg and Norman Steenrod. *Foundations of algebraic topology*. Princeton University Press, Princeton, New Jersey, 1952.

- [2] Julian R. Eisner. Knots with infinitely many minimal spanning surfaces. *Trans. Amer. Math. Soc.*, 229:329–349, 1977. Also has an addendum that contains the figures.
- [3] Osamu Kakimizu. Finding disjoint incompressible spanning surfaces for a link. *Hiroshima Math. J.*, 22(2):225–236, 1992.
- [4] Osamu Kakimizu. Classification of the incompressible spanning surfaces for prime knots of 10 or less crossings. *Hiroshima Math. J.*, 35(1):47–92, 2005.
- [5] Piotr Przytycki and Jennifer Schultens. Contractibility of the Kakimizu complex and symmetric Seifert surfaces, 2010, arXiv:1004.4168v2 [math.GT].
- [6] Makoto Sakuma. Minimal genus Seifert surfaces for special arborescent links. *Osaka J. Math.*, 31(4):861–905, 1994.
- [7] Friedhelm Waldhausen. On irreducible 3-manifolds which are sufficiently large. *Ann. of Math. (2)*, 87:56–88, 1968.

Mathematical Institute
University of Oxford
24–29 St Giles’
Oxford OX1 3LB
England
jessica.banks[at]lmh.oxon.org