

ZENO'S PARADOXES. A CARDINAL PROBLEM

I. ON ZENONIAN PLURALITY

Karin Verelst

FUND-CLEA
Vrije Universiteit Brussel
kverelst@vub.ac.be

Du présent, rien d'autre que du présent
Sartre, La nausée

INTRODUCTION.— It will be shown in this contribution that the Received View on Zeno's paradoxical arguments is untenable. Upon a close analysis of the Greek sources¹, it is possible to do justice to Simplicius's widely neglected testimony, where he states: *In his book, in which many arguments are put forward, he shows in each that a man who says that there is a plurality is stating something contradictory* [DK 29B 2]. Thus we will demonstrate that an underlying structure common to both the Paradoxes of Plurality (PP) and the Paradoxes of Motion (PM) shores up *all* his arguments.² This structure bears on a correct — Zenonian — interpretation of the concept of “division through and through”, which takes into account the often misunderstood Parmenidean legacy, summed up concisely in the deictical dictum τὸ ἐὸν ἐστὶ : “the Being-Now is”.³ The feature, generally overlooked but a key to a correct understanding of all the arguments based on Zeno's divisional procedure, is that *they do not presuppose space, nor time*. Division merely requires extension of an object present to the senses and takes place simultaneously. This holds true for both PP and PM! Another feature in need of rehabilitation is Zeno's plainly averred but by others blatantly denied phenomenological — better: *deictical* — realism. Zeno nowhere denies the reality of plurality and change. Zeno's arguments are not a *reductio*, if only because the logical prejudice that

¹The reference textcritical edition for the fragments [B] and related testimonia [A] is: H. Diels and W. Kranz [DK in what follows. See the list of sigla at the end of this paper], *Fragmente der Vorsokratiker*, to the numbering of which I will comply in accordance with scholarly tradition.

²In this we reckon in Owen a precursor, although our analysis of Zeno's arguments will be very different from his. See G.E.L. Owen, “Zeno and the mathematicians”, *Proceedings of the Aristotelian Society*, **8**, 1957.

³K. Riezler, *Parmenides. Text, Übersetzung, Einführung und Interpretation*, Vittorio Klostermann, Frankfurt, 1970, p. 45-50. Parmenides's τὸ ἐὸν ἐστὶ [to eon esti] should indeed be translated as *The Now-Being is*. In the present everything *is*. That the in origin dialectal difference between τὸ ὄν and τὸ ἐὸν had acquired philosophical significance becomes explicit in Diogenes of Apollonia, a contemporary to Zeno, where τὰ ὄντα [ta onta; the beings] are stable essences, while τὰ ἐόντα νῦν [ta eonta nun; the beings-now] are instable phenomenological things. See L. Couloubaritsis, *La Physique d'Aristote*, Ousia, Bruxelles, 1997, p. 308.

something which implies paradoxes cannot “really be there” is itself still unthinkable, since hypothetical thinking does not yet exist. When one speaks, one does so not about a possible world, but about *this* world: *κόσμος τóδε* as Heraclitus calls her [DK 22B 30].⁴ Zeno merely shows that, when someone states plurality, he inevitably states a contradiction, exactly as Simplicius claims. In what are traditionally considered the plurality arguments, this contradiction appears in the stature of *μέγαρα καὶ μικρά*, the large[s]-and-small[s] [DK 29B 1]. After subsuming PM under the simultaneous divisional procedure proper to PP, it will be indicated how the received view on the former can easily be derived by the introduction of time as a (non-Zenonian) praemiss, thus causing their collapse into arguments which can be approached and refuted by Aristotle's limit-like concept of the “potentially infinite”, which remained — in different disguises — at the core of the refutational strategies that have been in use up to the present. A mathematical representation will be given for Zeno's simultaneous divisional procedure which fully reckons Aristotle's dictum, revealingly enough never discussed in relation to Zeno, where he says: *For in two ways it can be said that a distance or a period or any other continuum is infinite, viz., with respect to the partitions or with respect to the parts* [Phys. Z, 2, 263a (24-26)].

ZENO'S INFINITE DIVISION AND THE PARADOXES OF PLURALITY.— I said that the sources testify for the unity of Zeno's arguments, in that they ALL are arguments on plurality. In this paragraph we are going to read in some detail the fragments which are seen traditionally as the paradoxes of plurality, in order to understand how Zeno gets to his plurality and what he has in mind when he uses that term. A comment by Simplicius will serve as our guideline: *κατὰ τὸ πλῆθος ἀπειρον ἐκ τῆς διχοτομίας ἔδειξε* [Thus] he demonstrated numerical infinity by means of dichotomy. [Phys., 140 (27)]. Three observations are in order here. First, the verbal form of the main clause is not neutral with regard to Zeno's achievement: the conjugation used is *ἔδειξε*, the (3rd sing.) aorist of *δεικνύναι* [deiknunai] (‘to point at, to indicate’; here in the sense of ‘to show’, ‘to demonstrate’), so as to mark out unambiguously that Zeno demonstrated this once and for all, exactly as when we speak of “Gödel's proof” as an acquired, definite result. Second, the word *apeiron*, customary translated as ‘infinity’, occurs in Zeno's own text and means literally ‘unbounded’. It derives from the archaic *a-peirar*; with *πεῖραρ* : rope, knot or bond⁵, i.e., something that has to be put around or upon something else from the outside, not just an end or a limit which is intrinsic to it. It is rather like a fence enclosing a meadow. *Okeanos*, the primal sea, is said to be *apeiron*; the image here being that of a lonely ship (the Earth) in the middle of a sea with no land in sight. So when used to qualify an abstract entity or process, the connotation will be ‘not stopped by somebody or something, uninterrupted’. One will be reminded of the ‘bonds of Necessity’ invoked by Parmenides in his Poem [DK 28B 8 (30)]. Third and last, the word *διχοτομία* [dichotomy] does *not* occur in Zeno's own text, and we know that this is not for want of relevant text pieces. How then do we know that Zeno has in view such a division? We will see in a minute why the *procedure* Zeno describes

⁴Conche translates “ce monde-ci”. M. Conche, *Héraclite. Fragments*, Presses Universitaires de France, 1986/1998, pp. 279-280.

⁵R.B. Onians, *The Origins of European Thought*, Cambridge University Press, Cambridge, 1951[1994], p. 314-317; 332 sq.

in his text cannot be anything else than a 'division through and through'. But there are other, related testimonies. A fragment ascribed by Porphyry to Parmenides does mention *διαιρετον* [division] explicitly. Simplicius [*Phys.*, 140 (21)] points out that this attribution must be fallacious: *For no such arguments figure among the Parmenidean [texts] and the majority of our information refers the difficulty from dichotomy to Zeno.* This is confirmed by Philoponus [*In Physica* 80(26-27)].⁶ In the Porphyry text it is stipulated: *since it is alike throughout παντα [pantēi], if it is divisible, it will be divisible throughout alike, not just here but not there.*⁷ The relevance of the words 'here' and 'there' cannot be overestimated, for in Zenonian terms they serve to deictically define extension. Simplicius moreover adds: *There is no need to labour the point; for such an argument is to be found in Zeno's own book. (...) Zeno writes the following words (...)*⁸; after which follows a literal quotation:

The second Paradox of Plurality (infinite divisibility) [DK 29B 3]⁹

[Simplicius, *In Aristotelis physicorum*, 140 (27)] *For in his proof that, if there is plurality, the same things are both finite and infinite, Zeno writes the following words: "if they are many [things], they by necessity are as many as they are, not more nor less. But if they are as many as they are, they will be finite [bounded, peperasmena]. But if they are many, they will be infinite [unbounded, apeiron]. For there will always [aei] be others [hetera] in between [metaxu] of the beings, and there again others in between." Thus he demonstrated infinity by means of dichotomy.*

It is remarkable that Simplicius is so firm in his statement, while we would be tempted to find the argument at first glance rather weak. Remember Simplicius's introduction: *he shows in each [argument] that a man who says there is a plurality is stating something contradictory.* The contradiction apparently is that if "they are many, they will be both bounded and unbounded". Whence does this contradiction arise? The point is clearly somewhere in the sentence: *For there will always be others in between of the beings, and there again others in between.* Even if not mentioned explicitly, this cannot be other than some kind of divisional procedure, exactly as we conceive of fractions to mentally break a line. Zeno's plurality-argument constitutes **the first Gedankenexperiment** in scientific history! It furthermore states in an accurate way that the

⁶LEE, p. 22. S. Makin, "Zeno on Plurality" *Phronesis*, 27, 1982, pp. 223-238, gives Themistius's commentary on the *Physics* as further evidence. I follow Vlastos for the emendation of the word "texts" in the fragment quoted; VLAS, p. 231. But even if the fragment were Parmenidean, it would not lose its relevance, given the close doctrinal relationship between the two men; so W.E. Abraham, "The nature of Zeno's Argument Against Plurality in [DK 29B 1]", *Phronesis*, 17, 1972, pp. 40-52.

⁷VLAS, p. 229; LEE, pp. 12, 20-23. A close parallel to this argument can be found in Aristotle's book on becoming, [*De gen. et cor.*, I. 2, 316a16 sq. and 325 a8].

⁸See LEE, p. 21 (the source of the translation). Compare DK p. 257, fn. 5 with [DK 28B 8 (22)].

⁹Concerning the translation of Zeno's arguments: I made use of LEE, KRS and other sources to be mentioned in case, but nowhere I follow them completely, sometimes — I admit — to the detriment of the English used. This is because I chose to contract O'Flaherty's methodological advice (in her book on sexual metaphor in Ancient Indian mythology) as completely as possible: *In the first analysis, it pays to be literal-minded.* W.D. O'Flaherty, *Women, Androgynes and other mythical Beasts*, University of Chicago Press, Chicago, 1980, p. 5. I can only hope the reader will be indulgent with respect to this choice.

number of parts obtained should at least be *dense*, in the mathematical sense of that word.¹⁰ To be sure, this also means that atoms as straightforward “least parts” are non-Zenonian. It makes moreover plain that ‘being (un)bounded’ really means ‘being (un)limited in number’. I am running a bit ahead of my argument when I say that this implies as well that they are at least countably infinite. We already know that limitation comes about by something external, by an obstacle or by interruption of an ongoing process. It inevitably follows that Zeno had in mind a division which is both symmetrical and nondirected, i.e. one in which *all* parts undergo the *same* divisional process.¹¹ Zeno’s terminology speaks for itself, as both *μεταξύ* [*metaxu*] ‘amidst’, ‘in between equal parts or things’ and *ἕτερον* [*hetera*] ‘others’, where the singular *heteron* indicates ‘the other of two’, testify. With regard to the latter Diels-Kranz put it plain and simple in their apparatus: *ἕτερον* : *Dichotomie!*¹²

Thus for anyone sharing the terminological sensitivity that goes along with having ancient Greek as a mothertongue, Zeno’s intentions were immediately clear. But we do still not know why applying this procedure would amount into paradoxical results. To answer this question, we have to extract more information from another variant of the argument, known as the ‘first’ paradox of plurality, because in it the intended situation is even more explicitly exposed:

The first Paradox of Plurality (finite extension) [DK 29B 1 & B 2]

[Simpl., *Phys*, 140 (34)] *The infinity of magnitude he showed previously by the same reasoning; for, having first shown that “if a being had no magnitude, it would not be at all”, he proceeds “but if it is, then each one must necessarily have some magnitude [megethos] and thickness and keep one away [apechein heteron] from the other [apo heteron]. And the same reasoning holds for any [part] jutting out [peri to prouchontos]; for this too will have extended magnitude and jut out. But to say this once is as good as saying it forever [aei]; for none will be the last [eschaton] nor the one [heteron] will be unrelated to another one [pros heteron]. So if it is a plurality, it by necessity will be many small [ones] and many large [ones] [mikra kai megala] — μικρὰ τε εἶναι καὶ μέγαρα — ; so many small[s] as to have no magnitude [mē megethos], so many large[s] as to be unbounded [apeiron]”.*

[Simpl., *Phys*, 139 (5)] *In one of these arguments he shows that if there is plurality [polla], then it is both many large [ones] and many small*

¹⁰I am not “reading this into” Zeno; his formulation is by far the closest you can get to it in words. Let’s make the point by comparing him to a standard textbook definition: *Let a and b be two real numbers with $a < b$. We can always find a real number x between a and b.* See K.G. Binmore, *The Foundations of Analysis: A straightforward Introduction*, Cambridge University Press, Cambridge, 1980, p. 74. The point is so obvious that one wonders why it is not made more often.

¹¹However, there IS an unexpressed hypothesis crucial to Zeno’s procedure, namely that division be one-dimensional, and in imagination presented as horizontal. This allows him to go over smoothly from PP to PM, but it has non-innocent mathematical consequences, on which we will come back. The relevance of this for the mathematics involved was pointed out to me by Bob Coecke (Oxford).

¹²DK, vol. I, p. 255.

[ones]¹³, so many large[s] [megala] as be infinite [apeiron] in magnitude, so many small[s] [mikra] as to have no magnitude at all. In this same argument he shows that what is without magnitude, thickness and bulk would not be at all. "For", he says, "if it were added to some other being, it would not make it bigger; because being of no magnitude, when added, it cannot possibly make it grow in magnitude. And thus the added would in fact be nothing. So if, when taken away, the other [being] will not be any less, and again will not, when added, increase, then it is clear that the added and then again taken away was nothing."¹⁴

Our aim is to try to understand Zeno in the way he understood himself, so we will follow Zeno's own argumentation as closely as possible and try to avoid any assumption imposed on him by later times. This explains my a bit awkward translation: the precise use of singular verb forms and plural substantives in the description is essential to a correct understanding, and should as much as possible be preserved. We already found that Zeno must have had in mind some kind of division. From the first lines of [DK 29B 1] it is clear that we are dealing with an object that has material extension; the verb 'prochein' is normally said of contiguous parts, one of which is thought of as sticking out from or extending beyond the other.¹⁵ Plurality is coined here in terms of the relation between parts and whole in an extended object with a 'here' and a 'there': *The discrimination of any two such parts in any existent I shall refer to as a "division"*.¹⁶ The deictic "first person"¹⁷ standpoint manifest in the lacking of temporality in Zeno's present-ation apparently has a spatial counterpart. "Space" nor "time" exist as independent backgrounds against which a mentally representable event takes place¹⁸; it is by indication that the validity of the argument is shown. Let us now see, on the basis of these two fragments, what characterises this division, and join our conclusions with those attained on the first fragment. There has been considerable controversy in the literature on this subject. It is appropriate to follow here Abraham's terminological distinctions between bipartite and tripartite division, and between simple 'division at infinity' and 'division throughout', i.e., stepwise applied to the last product of division or applied to all obtained parts equally. The bipartite/tripartite controversy was settled (methinks convincingly) by Vlastos. He argues for the symmetrical variant, offering, apart from considerations on the impact of symmetrical proportion on the archaic mind, a number of linguistic arguments, which strengthen the few we offered with regard to [DK 29B 1]. The image he presents of Zeno's procedure is the one now generally ac-

¹³I know of no translations which renders this sentence correctly. The verb used is ἐστί, "it is", while *megala* and *mikra* obviously are plurals. This moreover rules out the translation "they must be both small and large" for the last sentence in [DK 29B 1], as for instance in LEE.

¹⁴The hesitation in the standard translations with respect to the last line seems unnecessary when one takes one of the very few Aristotelian texts into account that deal explicitly with plurality — interestingly enough in [Met. 1001b7-19], i.e., not in the *Physics* — and where an almost literal quotation of Zeno's words is present: *For, he says, that which makes [something else] no larger, when added, and no smaller, when subtracted, is not an existent*. Translation with []: VLAS, p. 238.

¹⁵VLAS, "Plurality", p. 226.

¹⁶VLAS, "Plurality", p. 226.

¹⁷E. Benvéniste, "Le langage et l'expérience humaine", in: *Problèmes de linguistique générale II*, Gallimard, Paris, 1966, p. 69.

¹⁸J. Bollack, H. Wismann, *Héraclite ou la séparation*, Editions de Minuit, Paris, 1972, p. 49.

cepted: imagine a rod, divide it in two equal parts, take the right hand part, divide it the same way, and repeat this procedure *ad infinitum*. One then obtains the physical equivalent of a mathematical sequence of geometrically decreasing parts. This is exemplified in Vlastos's translation of the clause $\pi\epsilon\rho\acute{\iota}\ \tau\omicron\upsilon\ \pi\rho\omicron\upsilon\chi\omicron\upsilon\tau\omicron\varsigma$ is “[And the same reasoning applies] to *the projecting [part]*”, the part which remains to be further divided, that is.

Zeno's conclusion inevitably is that “a finite thing is infinite”, not a paradoxical, but a ridiculous statement. The assertion then mostly follows that Zeno's reasoning is based on a lack of mathematical knowledge for it is evident, isn't it, that the sum of an infinite series can very well have a finite total. Vlastos, who is familiar with the subtlety and profundity of Ancient Greek thought has the elegance at least to look for other explanations of Zeno's supposed blatant error.¹⁹ It is nevertheless true that on this interpretation the unity of Zeno's arguments is respected at least to the extent that two of the four Zenonian paradoxes of motion can be subsumed under the same model, in the received view on PM. Its major flaw with respect to at least PP is, however, that it cannot be upheld, because, 1) the density-property explicitly mentioned in [DK 29B 3] remains unexplained; 2) the Porphyry text gives terminological evidence in favour of a ‘division throughout’: *since it is everywhere [pantēi] homogeneous, if it is divisible, it will be divisible everywhere [pantēi] alike*²⁰; and 3) an essential part of the claim stated in [DK 29B 1] is not taken into account. Therein it is said that *if it is a plurality, it by necessity will be many small [ones] and large [ones]; so many small[s] as to have no magnitude, so many large[s] as to be infinite*. On the interpretation discussed up to now the first part of the assertion is plainly neglected. The idea of many commentators is in all likelihood that from the quote cited by Simplicius at the beginning of the same fragment [*if what is had no magnitude, it would not exist at all*], it can be inferred that one can simply dismiss this possibility. A more subtle view of the matter credits Zeno with the contemplation of things being but without magnitude, like unextended mathematical points.²¹ The reasoning supposedly goes as follows: Zeno says that a) infinite division leads to an infinite number of final, indivisible parts which still do have a magnitude, because, b) if they would not have magnitude, they would not be at all, and so the object of which they are part would not be at all. And an infinite number of parts possessing, however small, finite magnitude, would give us an object infinitely big. But c) given that the division is complete (‘throughout’), no parts with finite magnitude can remain²², therefore d) the object constituted by them will be infinitely small. Thus, upon Zeno's argument, a finite thing consisting of a plurality would be either infinitely large or infinitely small. The subtle variant of the standard interpretation thus offers us Zeno's argument as a dilemma. Owen develops the dilemma explicitly in terms of divisibility.²³ This is also what Huggett does, by deriving as horns from the proposition

¹⁹VLAS, p. 234.

²⁰The Greek is $\pi\acute{\alpha}\nu\tau\eta$ [pantēi]: overall, everywhere, carries the idea of an indiscriminated application.

²¹The French author P. Tannery introduced in the modern literature the idea that set theory and the paradoxes appearing in it should be related to the work of Zeno. P. Tannery, “Le concept scientifique du continu. Zénon d'Elée et Georg Cantor”, *Revue philosophique de la France et de l'étranger*, **20**, 1885, p. 397 sq.

²²An assumption which is made explicit is the “Porphyry text”: *if any part of it is left over, it has not yet been divided throughout [pantēi]*. VLAS, p. 229.

²³G.E.L. Owen, *op. cit.*.

The points have either zero length or finite length the conclusions C1. *The total length of the segment is zero* versus C2. *The total length of the segment is infinite.*²⁴ This viewpoint necessitates anyhow another interpretation of his infinite division, namely that every resulting part will be subject to the infinite series of stepwise divisions. One then obtains a countably infinite number of decreasing sequences, resulting in a countably infinite number of dimensionless endpoints. This reading of the argument has a venerable tradition and it respects the historical order of things, since this is the way the atomists interpreted it.²⁵ Alas, Zeno nowhere presupposes material atoms. This process is taken to be carried through somehow up to the moment the *unextended* points composing the (rational part of) real line are reached, the “infinite” element of every sequence. It is eventually concluded that Zeno commits a fatal, yet this time logical, fallacy. Indeed, on the assumption — necessary if the enquiry into the consequences of the concept ‘plurality’ is to be exhaustive — that such an ordinal [i.e., stepwise] infinite process could be *completed*, an absurdity results. It is called by Grünbaum (following Weyl) “Bernoulli’s fallacy”: *He [Bernoulli] treated the actually infinite set of natural numbers as having a last or “∞th” term which can be “reached” in the manner in which an inductive cardinal can be reached by starting from zero.*²⁶ The error imposed on Zeno has therefore two wings that match the horns of the presumed dilemma; one concerning ‘infinitely small’ and one concerning ‘infinitely large’.²⁷ The logical explicitation of the first wing has been summarised nicely by Vlastos: *Since “infinitely” = “endlessly” and “completion” = “ending”, it follows that “the completion of the infinite division of x is logically possible” = “the ending of the endless division of x is logically possible.”* Its mathematical variant is the Bernoullian fallacy inhaerent, according to Grünbaum, in e.g. Lee’s and Tannery’s construal of Zeno’s plurality-argument: *it is always committed when the attempt is made to use infinite divisibility of positive [i.e., finite] intervals as a basis for deducing Zeno’s metrical paradox and for then denying that a positive interval can be an infinitely divisible extension.*²⁸ Of course it is true that an infinite number of physically extended things lumped together would be infinitely big! It is not even necessary to suppose that they be equal, as Huggett²⁹ does. For evidently I can build unequal parts out of equal ones, as long as they stand in rational proportions to each other, which is exactly what the decreasing sequence of cuts of the received view brings about. So whether one construes Zeno’s procedure as a directed division or as one potentially throughout (as described above) will not even make a difference. Once the sequence of partitions is interrupted somewhere — remember the meaning of *a-peiron* — and thus remains incompleated even after an infinite number of steps, it will generate an infinity of parts with finite magnitude (unequal in the case of directed division, equal in case the division was ‘throughout’). But Zeno denies exactly this possibility of getting a countably infinite number of extended parts from a finitely

²⁴N. Huggett, *o.c.*, pp. 44-45.

²⁵Epicurus in his Letter to Herodotus, 56-57. M. Conche, *Epicure, Lettres et Maximes*, PUF, Paris, 1987/1999, pp. 108-111. See also the commentary on pp. 147-151.

²⁶A. Grünbaum, *o.c.*, pp. 130-131.

²⁷Compare the sections “The Deduction of Nullity of Size” and “The Deduction of Infinity of Size” in Vlastos’s discussion of the problem, VLAS, “Plurality”, p. 227 sq. and p. 233 sq.

²⁸A. Grünbaum, *o.c.*, pp. 131-132.

²⁹N. Huggett, *o.c.*, section 2.2.

extended thing: *if they are many [things], they by necessity are as many as they are, not more nor less. But if they are as many as they are, they will be bounded* [DK 29B 3]. In the interrupted case, the number will be 'bounded', i.e., finite, and the magnitude will be so too! Abraham calls this Zeno's principle of **the equivalence of the parts and the whole**, and as far as I can see it is the only way to understand it commensurable with the content of the other fragments.³⁰ A valid interpretation of 'directed division' with respect to this is hardly conceivable. Finally, following Abraham's linguistic argumentation³¹, this construal of Zeno's procedure can definitively be ruled out, because it is perfectly possible to translate the substantiated participle in the mentioned clause in [DK 29B 1] as "any projecting [part]", since ancient Greek does not discriminate between a definite and an indefinite particle.³² When one has no content-loaden a priori in mind, 'any' evidently fits in: it would simply mean any of the symmetric parts obtained by a dichotomic division, irrespective of the level the procedure attained. This is confirmed by the use of the verb $\alpha\pi\acute{\epsilon}\chi\epsilon\iota\nu$ in the previous line, which conveys the idea 'to be kept away from each other, to be separated actively' — and therefore to remain in contact, to be contiguous, like when one pushes his way through a crowd — rather than merely 'to be at a distance'. This is why Vlastos in his paraphrase of Zeno's arguments speaks of "nonoverlapping parts".³³ The nice and certainly not arbitrary antisymmetrical description of the totality of the procedure when one takes [DK 29B 1]: *for none will be the last [eschaton] nor the one [heteron] will be unrelated to another one [pros heteron]*, and contrasts it with [DK 29B 3]: *For there will always [aei] be others [hetera] in between [metaxu] of the beings, and there again others in between*, is a case in point. The second wing also comes in two variants, though the difference is between mathematics and physics, rather than between logic and mathematics. The mathematical one is the familiar objection that the sum of an infinite series can be finite, in case the series converges. The other variant goes back to Aristotle [e.g. *Phys.* 263a(4-6)] and points in one way or another out that the execution of an infinity of discrete physical acts within a finite stretch of time must be impossible. This objection is at the origin of the recent discussion on "supertasks".³⁴ These discussions can be relevant with regard to Zeno, but only when one gives heed to certain precautions. I however want to contest the standard interpretation, and therewith reject the claim that Zeno committed any such fallacy. It is important to stress here once again the *physical nature* of Zeno's thought-experiment and the deictic realism inhaerent in it. It is as well important not to introduce any presuppositions on behalf of Zeno, especially not those that only came into existence in an attempt to deal with problems raised by him. To this latter kind belong all mathematical and physical assumptions concerning the 'continuous' vs. the 'discrete' nature of matter, space and time. *Zeno nowhere mentions space nor time*

³⁰W.E. Abraham, "Plurality", pp. 40-52. Contrary to KRS, who construe the second part of [DK 29B 3] as an objection to the first.

³¹Not to mention the fact that the direction imposed upon the procedure in all likelihood is merely an artefact of our direction of reading! W.E. Abraham, "Plurality", p. 42.

³²I agree with Abraham that the parallel with $\pi\acute{\alpha}\varsigma\ \acute{\omicron}\ \beta\omicron\upsilon\lambda\acute{\omicron}\mu\epsilon\nu\omicron\varsigma$ is relevant. Of the individualising vs. the generalising — "to make a certain person or thing into the representative of the whole species" — function of the article, very explicit examples can be given. The translated quote stems from P.V. Sormani and H.M. Braaksma, *Kaegi's Griekse Grammatica*, Noordhoff, Groningen, 1949, pp. 112-113.

³³VLAS, p. 225.

³⁴For an overview: J. P. Laraudogoitia, "Supertasks", *STF*, <http://plato.stanford.edu/archives/win2001/>

simply because these notions do not yet exist! Therefore he cannot set up a dilemma on these praemisses. But then couldn't one construct the dilemma on the basis of an utterance present in the Zenonian text? There is no philological source-material upon which it can be based. Worse, of the necessarily disjunctive structure underlying such an argument there is no trace. The contradiction that should arise out of it is laid out already in the supposed praemisses, for Zeno uses towards the end of [DK 29B 1] twice the word *καὶ* [and] instead of the required *ἢ*; *ἢ*τοι [or], thus complying once again to Simplicius's dictum that he intended nothing else but to show that a man who says that there is a plurality is stating something contradictory.

Now, in order to throw more light on the nature of the problem at hand, it is crucial to realise that there is a difference between the joining of two physical parts and the addition of two mathematical line segments. The difference touches upon the far from trivial problem of the relation between the mathematical and the natural sciences. In Plato's *Phaedo* there is an extremely illuminating discussion of this relationship, with reference to the "contradictory" results generated by the natural philosophy gone before. Socrates complains that, since it allows for akin things to have contradictory causes, while phenomena clearly distinct become causally undistinguishable, its results cannot be considered valid [*Phaedo*, 100(e)-101(a,b)].³⁵ He gives the example of the difference between "being two things" and "being a pair of things"; the latter a formal, the former a physical fact. He also focuses on the relation between parts and wholes in number theory, by comparing the generation of 'two' out of 'two ones' by adding them, bringing them together, and the separation of 'two' into 'two ones' by dividing it [*Phaedo*, 97(a,e)]. The Zenonian influence is plain, although scarcely discussed in the literature. There is an even more striking parallel with Plato's *diairesis* – the dissection of a concept into its constituting contraries, the technique shoring up properly practiced dialectics, as applied in the *Sophist*, the *Statesman*, and the *Philebus*.³⁶ We will return in more detail to the *Philebus*, where the link between conceptual and mathematical *diairesis* is established, when discussing our proposal for a faithful mathematical representation of Zeno's divisional procedure. As is well known, Plato in the *Sophist* defines 'dialectics' as the art of making the proper distinctions between the forms that instantiate themselves in and through particular things [*Sophist*, 253d(1-3)]. In that dialogue, moreover, the difference established between contraries and contradictions — between praedicative and existential paradoxes — lays out its ontological preconditions.³⁷ Now, harking back to something used already in the *Parmenides*, viz. the dichotomic way of reasoning, the method by which *diairesis* should be applied is demonstrated in the *Philebus* and the *Statesman* by means of examples. In the latter dialogue, while trying to define the good statesman, Socrates and his friends find out that the most long and cumbersome, but nevertheless the best way [*Statesman*, 265(a)] to discover the specific forms instantiated in a thing is by systematically dividing its concept in opposing halves, like 'living/non-living' [*id.*, 261(b)], 'feathered/unfeathered'

³⁵All references to this dialogue are to the text in the LOEB₃-edition.

³⁶The texts I consulted are those in LOEB₄.

³⁷Platonists who doubt that they are spectators of Being must settle for the knowledge that they are investigators of the verb 'to be'. G.E.L. Owen, "Plato on Non-being", *Plato: a Collection of Critical Essays*, vol. i, G. Vlastos ed., Anchor/Doubleday, N.Y., 1971, p. 223.

[*id.*, 266(e)] or 'odd/even', instead of arbitrarily separating off a part — 'Greeks' vs. 'barbarians'; 'ten' vs. 'all other numbers' [*id.*, 262(d-e)], say. This process ends when one bumps on undetermined parts, the *stoicheia* or elements, that are not themselves capable of being specified further into underlying parts [*id.*, 263(b)]. There are — in the vocabulary of later times — no *differentia specifica* involved anymore, their plurality, if any, is merely numerical. The number of steps needed to reach from the original unity to this fully determined level — the proportion between part and whole — then defines somehow the original concept [*Philebus*, 16(d)]. This, however, is often not possible, especially not when the praedicates are relative properties like 'warm/cold'; 'short/tall' &c. Their opposites will run apart into their proper infinities and thus into conceptual absurdity unless a limit, a boundary [*peras*] is imposed on them, in order to find the good *measure* that guarantees their non-destructive, bounded aequilibrium from the reality of the thing they describe sprang [*Statesman*, 283(d,e)]. Aristotle states it in words that could not be more clear: *Plato, for his part, recognises two infinities, the Large and the Small* τὸ μέγα καὶ τὸ μικρόν [*to mega kai to mikron*] [*Phys.* 203a 15]. They can be discriminated indubitably, for with each goes a different mode of realisation: *everything is infinite, either through addition [i.e. stepwise], either through division [i.e. simultaneously] (...)* [*Phys.* 204a 6].³⁸

Aristotle himself discusses the problem directly in relation to Zeno, and puts it in a way that clears the road for his notorious solution: the introduction of the difference between *potential* and *actual* infinity: *For in two ways it can be said that a distance or a period or any other continuum is infinite [apeiron], viz., with respect to the partitions [diairesin] or with respect to the projecting parts [tois eschatois]* [*Phys. Z*, 2, 263a (24-26)]. The vast majority of authors admits that Aristotle did indeed attempt to solve PM (though not PP!) that way, although his solution is generally dismissed as false or no longer mathematically relevant: *We won't pursue this position, for the actual/potential distinction is not applicable to modern mathematics.*³⁹ This is hardly acceptable a priori when one realises that it throws us back to a problem already posed in Plato's *Phaedo*: what does it mean to divide a continuous one into two parts? Aristotle comments: *For whoever divides the continuum into two halves thereby confers a double function on the point of division, for he makes it both a beginning and an end* [*Phys. Θ* 8, 263a (23-25)].⁴⁰ And the points of partition serve as boundaries to the parts, be they potential or actual in number, i.e., discernable and countable or not.⁴¹ Zeno's Gedanken-experiment, by investigating the ultimate consequences of the infinite divisibility of a physical being, hits on the said difference between the physical and the mathematical and thus creates the preconditions necessary to establish its various later forms. Poincaré discussed this crucial difference in a way that will prove of great

³⁸See J. Stenzel, *Zahl und Gestalt Bei Platon und Aristoteles*, Teubner, Leipzig, 1933, p. 30 sq.; p. 60 sq.

³⁹N. Huggett, o.c., p. 40.

⁴⁰translations are after Wicksteed and Cornford in LOEB₂.

⁴¹This relationship is exposed admirably clear by Mary Tyles, *The Philosophy of Set Theory. An Historical Introduction into Cantor's Paradise*, Dover, N.Y. 2004 [1th ed. 1989], especially pp. 10-31. The book discusses the foundations of set theory with the clash between finitists and non-finitists on the foundations of mathematics as its vantage point. Interestingly enough it has a logical counterpart as well. C. Vidal showed in his *Maîtrise de philosophie*: "Georg Cantor et la découverte des infinis", Paris I-Sorbonne, 2002-2003, p. 40, that a far from innocent inversion of logical quantifiers is involved.

relevance to the mathematical representation we are going to build in the remainder of this paper.⁴² Tannery refers in this context to the critique of Protagoras on the geometers as quoted in Aristotle [*Met.* B, ii, 997b(33)-998a(5)]: (...) *for as sensible lines are not like those of which the geometrician speaks (since there is nothing sensible which is straight or curved in that sense; the circle touches the ruler not at a [single] point, as Protagoras used to say refuting the geometricians).*⁴³ So, again, we cannot find salvation with logic, nor with space and time⁴⁴, nor with the continuous and the discrete, just with Zeno's division throughout. The only other thing we can rely upon is Parmenides's *Being-now*. This analysis imposes two criteria that have to be fulfilled by whatever formal representation of Zeno's paradox: **constructivity** and **simultaneity**. It indeed endorses a hitherto hardly recognised line of approach. It is Abraham who (overlooking Parmenides, but reference to him only strengthens the reasoning) opens up in a brilliant argumentation this possibility, which comes down to accepting fully the consequences of the fact that Zeno's division is a timeless division. To start with, let us follow what he has to say:

*The objection that Zeno assumes the completion of an infinite task assumes that, when he postulates that the being is divided **through and through** and so on infinitely, he is introducing end-products which logically cannot be further divided, or he is assuming a least division beyond which there is no other, and so, a last part. Now even though there is an actual infinite number of points in a line at any of which points the line may be divided, the finite line does have terminal points (...). But it would be a howler, committed by Johan Bernoulli, and decried by Leibniz, that a terminal point would be "the infinitieth point" on the line. (...) To say that it is infinitely divided is no more than to say it actually has an infinite number of points at every one of which it is divisible. The point to note is that the infinite divisibility means not an infinite number of points of alternative⁴⁵ division (such that the alternatives are inexhaustible) but rather an infinite number of points of simultaneous division. The points of division, being points on the being, belong to it not alternatively, but **simultaneously**. It is this simultaneity (and not a process) which is articulated by the postulate of the complete division. It is clear that if Zeno's complete division thus is a **cardinal** completion rather than an **ordinal** completion, the infinite division of the given being does not imply a last division or last part, any more*

⁴²H. Poincaré, "Le continu mathématique", *Reveu de métaphysique et de morale*, 1, 1893, pp. 26-34. A reprint entitled "La grandeur mathématique et l'expérience" in *SHYP*, pp. 47-60. He deepens his ideas in "La notion d'espace", reprinted in *SVAL*, pp. 55-76.

⁴³In a rare display of negligence, DK destroy exactly the point of the argument by translating *κατόνοχος* by *Tangente* instead of *ruler!* And although Tannery places this discussion explicitly "dans le cadre de Zénon", he concludes: (...) *la question est donc d'un autre ordre que celles soulevées par Zénon, et sa dialectique était impuissante à la résoudre* (...), the reason being that also he takes Zeno's argument as constituting the dilemma exposed above. It will be clear that I do not approve of either position: when understood properly, Zeno does not have this problem at all. See [DK 80B 7], transl. in vol. II, p. 266; P. Tannery, *o.c.*, pp. 396-397. I used the translation given by H. Tredennick, LOEB₁, Aristotle, *Metaphysics*, p. 115. The [] are mine.

⁴⁴As KRS, p. 273, point out with regard to the Arrow Paradox.

⁴⁵i.e., stepwise. The italics are in the original. The bold further down the quotation is mine.

*than the simultaneity of the points on a line imply an infinitieth point.*⁴⁶

The central point thus is that by being simultaneous (i.e., by occurring in no lapse of time) the completion by division is at once, cardinal, not stepwise, ordinal. This refers to the arithmetic of “infinity”, developed towards the end of the nineteenth century by G. Cantor, who proved that different kinds of infinity exist which he called *cardinal* and *ordinal* infinity.⁴⁷ Cardinality (“Zahl”) expresses the total number of elements of a given set; ordinality (“Anzahl”) concerns the way these elements can be ordered stepwise. He furthermore showed that the set of natural numbers \mathbb{N} and the set of finite fractions \mathbb{Q} possess the same *countably infinite* cardinality, which he labelled Aleph-null (\aleph_0). The basic ordinality that goes with it he called ω . It is possible to construct an infinite sequence of ω 's which comprise different ordinalities that all belong to the same *number class*, i.e., discern levels of equal cardinality: $\omega_i = Z(\aleph_1)$; $\omega'_i = Z(\aleph_2)$, &c. The difference only becomes relevant from the moment the numbers implied are infinite. Consider for instance the set of natural numbers ordered in the traditional manner $\{0, 1, 2, \dots\}$ and ordered alternatively $\{1, 2, \dots, 0\}$. The cardinal number of these sets will be equal; their ordinal numbers will be respectively ω and $\omega + 1$. Cantor also showed by means of his famous diagonalisation argument that $2^{\mathbb{N}}$, the cardinality of the set of real numbers \mathbb{R} ⁴⁸ — the mathematical face of the idea of continuity —, is an infinity *bigger* than the cardinality of \mathbb{N} or \mathbb{Q} : they do *not* belong to the same number class.⁴⁹ The infinity of the continuum is *uncountable*. Abraham's intention with respect to Zeno's division now becomes more clear. He apparently claims that Zeno's procedure *at once* generates the *uncountable* cardinality of the continuum instead of the merely *countable* one which would be attainable when one interpretes Zeno's procedure *stepwise*. This reminds us of the viewpoint also defended by authors like Tannery and Luria, castigated by Grünbaum for reasons given in the following comment: *it is essential to realize that the cardinality of an interval is not a function of the length of that interval. The independence of cardinality and length becomes demonstrable by combining our definition of length with Cantor's proof of the equivalence of the set of all real points between 0 and 1 with the set of all real points between any two fixed points on the number axis.*⁵⁰ And it is exactly this error that Grünbaum predicates on Zeno's plurality paradoxes: according to him, Zeno maintains that a longer part “contains more points”. This is nothing but another variant of the ‘Bernoullian fallacy’ which he believes also to be present in the paradoxes of motion. Now it is precisely Abraham's aim to show that this error is *not* present in Zeno's plurality-argument, for it would imply a divisional process *through time*, and Zeno nowhere mentions ‘time’. But this does not yet suffice to completely solve the riddle, because it leaves untouched a related problem raised by Grünbaum: how to construct an extended object out of parts with no extension whatsoever? Zeno cannot just intend that his division generates the unextended points composing the continuous line, for then only the ‘being nothing’-part of his paradox would remain. Zeno's divisional procedure generates an infinity of

⁴⁶W.E. Abraham, “Plurality”, p. 48. My bold.

⁴⁷G. Cantor, “Beiträge zur Begründung der transfiniten Mengenlehre”, *Gesammelte Abhandlungen* [GA in what follows], E. Zermelo Ed., Georg Olms Verlag, Hildesheim, 1932/1962, pp. 312-356.

⁴⁸F. Hausdorff, *Mengenlehre*, Chelsea Publishing Company, N.Y., 1949, pp. 62-64.

⁴⁹G. Cantor, “Über eine elementare Frage der Mannigfaltigkeitslehre”, *GA*, pp. 279-281.

⁵⁰A. Grünbaum, *o.c.*, p. 127.

partitions and a *different* infinity of parts at once and jointly *in any part independent of its length*. The simultaneous and uninterrupted [*apeiron*] repetition of partitions is clearly stated by Zeno himself: *to say this once is as good as saying it forever [aei]*. The result is an infinity of parts which must at least be dense: *for none will be the last nor one will be apart from another one and For there will always be others in between of the beings, and there again others in between*. We know moreover that it results in parts with and without magnitude, whence we may safely assume that this strange fact is somehow connected to the presence of different infinities: we do not only have density but also arbitrary length! It is tempting to conclude that Zeno's way of putting his problem betrays an intuitive awareness of the notion of infinite cardinality, which moreover would render Aristotle's bewildering step to discriminate between two infinities, potential and actual, not only comprehensible, but places it in a glaring light. This is confirmed by Aristotle's own interpretation: *For in two ways it can be said that a distance or a period or any other continuum is infinite [apeiron], viz., with respect to the partitions [diairesin] or with respect to the projecting parts [tois eschatois], although Aristotle in all likelihood would deny that Zeno himself realised this*. But a drawback of our interpretation up to now is that it does not fit into the received view on the paradoxes of motion, of which some are incontestably based on dichotomy as well, as again the Stagirite diagnoses: *This argument [the Achilles] is the same as the former which depends on dichotomia [Phys. Z, 9, 239b (20-21)]*. The received view on Zenonian plurality on the contrary does, at least partially, comply to this criterion. I can circumvent this objection only by devising an interpretation that gives us PM as the result of a division through and through. This is precisely the nature of my claim with respect to them, as I hope to convincingly argue towards the end of this article.

A SIMPLE MATHEMATICAL REPRESENTATION.— In accordance with Zeno's already mentioned realism towards everyday phenomena like plurality and change, we shall develop a mathematical representation of Zeno's divisional procedure \exists that is as simple as possible, that does not make any presupposition other than those explicitly retracable to our philosopher, and is applicable to all his paradoxes alike. So, then, what do we know about Zeno's division?

- i) it goes on "infinitely";
- ii) it is symmetrical (proportion 1:2);
- iii) it results somehow in parts with and without magnitude;
- iv) it is a simultaneous procedure;
- v) it pops up in all his paradoxes.

What we need is a procedure whereby "two different kinds of infinity are generated simultaneously", and in which "the points of division are used twice". Let us take as a model object a measuring rod M , of which we conventionally call the left-hand side 0 and the right-hand side 1, and which we arbitrarily set equal to unity.⁵¹ This we can do, given that the specific length of the object by no means influences the argument. What will happen when we Zenonian-wise divide this model-object through and through? We can see this division as a kind of cell division, whereby in each generation the

⁵¹I owe this illustrative example to an electronic discussion with J. Helfand.

number of parts generated doubles: when generation n has 2^n parts, generation $n + 1$ will have 2^{n+1} parts. And we know that $n \rightarrow \infty$. This can be represented graphically by a divisional tree. The cells function at every step in two different ways: as partitions in generation $n - 1$ and as parts in generation n . In every generation, generation by addition and generation by division thus coincide. The number of partitions should at least reach $n \leq \omega$, with ω the basic ordertype of \mathbb{N} :

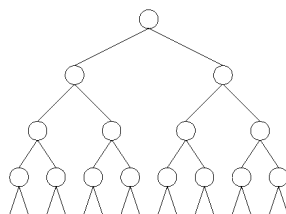

The measuring rod M and the tree of cell-divisions.

The simultaneous division-lattice stands for the totality of \mathfrak{Z} , and thence equally bears a twofold interpretation: by looking at the “last row” at generation ω and *dividing once more*, or by mapping the whole procedure on the \mathbb{N} -lattice by relating the number of partitions to number of cells, and the number of parts to the number of paths between them. The first procedure comes intuitively closer to what Zeno intended, but inevitably introduces an inappropriate notion of time, a flaw which is absent from the second one. Anyhow, the result in both cases is the same: the number of partitions $|\mathbb{N}|$ with its concomittant number of parts $|\mathbb{R}| = 2^{\mathbb{N}}$ are generated simultaneously and with a clearly *different* status. So I am *not* saying that the result of Zeno’s procedure is merely a set with the cardinality of the continuum, like the Euclidean straight line. That would, moreover, be nothing new, as I indicated when discussing Tannery’s and Abraham’s views. It nevertheless is already remarkable enough that such a construction of the continuum should be possible at all. Attempts to do something akin to it have been proposed in the context of constructive or intuitionistic mathematics.⁵² In order to make the difference with our own procedure completely clear, we will devote ourselves now to a short and non-rigorous discussion of the approach on the basis of Brouwer’s dissertation and Troelstra’s fundamental work.⁵³ Briefly stated, **intuitionistic mathematics** was conceived by L.E.J. Brouwer in a reaction to the discovery of the logical

⁵²My attention was drawn to intuitionistic mathematics by the discussion in M. Tiles’s book, *o.c.*, p. 90-94.

⁵³A.S. Troelstra, *Principles of Intuitionism*, Springer, Berlin/Heidelberg, 1969, p. 22, 52; pp. 57-64.

and set theoretic paradoxes at the beginning of the twentieth century. The basic philosophical ideas shoring up his *démarche* are 1) mathematics *precedes* logic, not the other way around; and 2) classical logic fails in universally applying the principle of the excluded middle (TND), which states that *all* logically valid propositions have either the values “true” or “false” attached to them. Both principles are intimately connected to Brouwer’s attitude towards the mathematical infinite. To talk about “all” or “for every” when the number of objects considered is infinite amounts into absurdity according to him. He holds that in mathematics the infinite can only be *potential*, i.e., so as to be stepwise approached but never reached, while the *actual* infinite of the standard view of the continuum cannot have real existence. In his *Proefschrift* [dissertation], Brouwer writes: *Het continuum als geheel was ons echter intuïtief gegeven; een opbouw ervan, een handeling die “alle” punten ervan geïndividualiseerd door de mathematische intuïtie zou scheppen, is ondenkbaar en onmogelijk. De mathematische intuïtie is niet in staat anders dan aftelbare hoeveelheden geïndividualiseerd te scheppen, n.l. zó, dat men een procédé geeft, dat elk element der verzameling na een eindig aantal operaties genereert.*⁵⁴ The question then becomes how much standard mathematics we can get back on such a constrained conceptual basis. Brouwer himself advanced the idea that the continuum could be constructed by means of finite sequences — a countable number of “dualbreuken, ternaalbreuken” [dual, ternary fractions, i.e., rationals written in binary or ternary form] — which approach points P , the “dubbelpunten” [double points]⁵⁵ demarcated by neighbourhoods which remain outside the “schaal” [scale] determined by the “voortschrijdingswet” [Law of Progression] of the sequence.⁵⁶ It is as if one covers the given continuum with another one full of tiny holes [“lacunes”] which one can then “samendenken” [think together] by the process of approximation.⁵⁷ This process can be represented by a “boom” [tree]⁵⁸, to the decreasing parts of which one can associate a binary representation.⁵⁹ Troelstra formalises these ideas; the basic notions required are a *species*, a *sequence* and a *tree* or *spread*. Species are the intuitionistic analog for classical sets. They comply to a specific form of the *axiom of comprehension*, predicated on a precise interpretation of the concept of *well-definedness* based on the idea of provability. (Again, we shall not forget that intuitionism originated in the wake of the discovery of the famous set theoretic paradoxes.) Now let a sequence be a mapping, i.e. a ***process*** which associates with every natural number a mathematical

⁵⁴*The continuum as a whole was given to us intuitively however; to construct it by means of an act of mathematical intuition that would create “all” of its points individually, is unthinkable and impossible. Mathematical intuition can only create countable quantities individually, i.e., such, that a procedure is given which generates every element of the collection after a finite number of operations.* L.E.J. Brouwer, “Over de grondslagen der wiskunde. Academisch Proefschrift [1907]”, in D. Van Dalen, *L.E.J. Brouwer en de grondslagen der wiskunde*, Epsilon, Utrecht, 2001, p. 73. [My translation.]

⁵⁵L.E.J. Brouwer, *o.c.*, pp. 56.

⁵⁶L.E.J. Brouwer, *o.c.*, pp. 43-45.

⁵⁷*Zo kan een gegeven continuüm door een ander continuüm met lacunes worden overdekt [covered]; we behoeven daartoe op het eerste continuüm maar een ordetype η te bouwen, dat het niet overal dicht [dense] bedekt en vervolgens bij dat ordetype η het continuüm te construeren; we kunnen dan altijd een punt van het tweede continuüm identiek noemen met het grenspunt van zijn benaderingsreeks [the limit-point of its approaching sequence] op het eerste continuüm.* L.E.J. Brouwer, *o.c.*, p. 73. The “ordetype η ” belongs to Cantor’s first number class, as Brouwer makes clear on pp. 42-43 [cfr. ft. 72 infra].

⁵⁸L.E.J. Brouwer, *o.c.*, pp. 73-76.

⁵⁹H. Weyl, *Philosophie der Mathematik und Naturwissenschaft*, München, 1926, p. 43; p. 51.

object belonging to a certain species X : $(\mathbb{N})X : \mathbb{N} \longrightarrow X$.⁶⁰ These sequences are introduced in order to develop an intuitionistic theory of real numbers. Given a map ξ , the species X can be **represented** by a spread with an equivalence relation \sim if $\langle a, \xi \rangle$ is a spread, and if X^* , the species of equivalence classes with respect to \sim can be mapped bi-uniquely (injectively) onto X . So X can be represented by $\langle a, \xi \rangle$ via its partition X^* . *The spread represents a set of nodes of a growing "tree" of finite sequences of natural numbers, with branches directed downwards; the topmost node corresponds always with the empty sequence.*⁶¹ The tree may be branched up to an arbitrarily high level. It will be clear that this construction does *not* fulfill the criteria which emerged out of our analysis of Zeno's procedure 3. For, as Troelstra himself unambiguously states, his procedure implies a *process* consisting of a finite though unspecified number of steps. And in a related context, Brouwer himself says that he sees the sequence of divisions generated by it as taking place *door den tijd [through time]*. The open-endedness of the procedure is of course a necessity if one wants to approximate the real numbers by means of it.⁶² But how then to avoid the Bernoullian fallacy? By rehabilitating the Aristotelian notion of the *potentially* infinite, the idea of an infinite process that theoretically could, but in reality never will, be concluded. *The totality of all potentially infinite sequences of rationals (...) is a potentially infinite whole containing members which are never fully determinate, for they themselves are potentially infinite, and always actually finite but necessarily incomplete.* As a matter of fact, *since the process of focusing is not, and can never be complete, the continuum is never resolved into points, only into ever smaller regions.*⁶³ Hermann Weyl, who stresses exactly this aspect of Brouwer's approach, links it to Plato: *Brouwer erblickt genau wie Plato in der Zwei-Einigkeit die Wurzel des mathematischen Denkens.* Plato's ἀόριστος δυνάς [*indeterminate twoness*] is the principle of generation underlying *diairesis* [*conceptual division*] by means of which both the Large and the Small come about. As Aristotle explains in Book *N* of the *Metaphysics*, it is closely related to Platonic number-theory.⁶⁴ We will see later that Weyl's account in fact only reckons the 'Large'-part of Platonic *diairesis*. It is outside our scope to dwell on this more elaborately here, but the parallel with Zeno's analysis will nevertheless be clear: Plato's Large-and-Small τὸ μέγα καὶ τὸ μικρόν⁶⁵ and Zeno's large[s]-and-small[s] μέγαλα καὶ μικρά both refer to the paradoxical result of an infinite and through and through division.⁶⁶ Plato's metaphysical preoccupation with non-paradoxical plurality however forces him

⁶⁰A. Troelstra, *o.c.*, p. 16.

⁶¹A. Troelstra, *o.c.*, p. 52.

⁶²H. Weyl, *o.c.*, p. 44.

⁶³M. Tiles, *o.c.*, pp. 91-92.

⁶⁴This fact is in itself quite undeniable and its recognition does not imply a position in the controversy surrounding the "Tübinger Schule" interpretation of Plato's philosophy. Traces of Platonic *diairesis* can be found back in the earliest dialogues, and arguably contributed to the development of Plato's theory of Forms, at least according to M.K. Krizan, "A Defense of *Diairesis* in Plato's *Gorgias*, 463e5-466a3", *Philosophical Inquiry*, XII(1-2), 1-21. For a recent and moderate overview of the issues at stake, see D. Pesce, *Il Platone di Tubinga, E due studi sullo Stoicismo*, Paideia, Brescia, 1990.

⁶⁵Cited by Aristotle in e.g. [*Met. A*, 987b(20)]. Cfr. J. Stenzel, *Zahl und Gestalt Bei Platon und Aristoteles*, Teubner, Leipzig, 1933 (2nd ed.), p. 6.

⁶⁶Although I found it nowhere discussed from this perspective in the literature. The singular in Plato's expression stems from the fact that he applies the paradoxical property to the abstract principle by which division is obtained, while with Zeno the plural directly refers to its result.

to enlarge the 'here'-part of Zeno's deictic standpoint into an in principle unlimited number of partial perspectives that cover the totality of the divisional tree. Thanks to an idea of M. Serfati, it will be possible to formally distinguish the set of perspectives (*l'ensemble des points de vue*) from the tree itself.⁶⁷ For the human mind, however, the relocation of the infinite to the realm of the Ideas makes that the part of the tree accessible to it always remains partial, while with Zeno the totality of the divisional process is given in the here-and-now. But again with Plato, being ideal does not mean being unreal, quite the contrary! That is why the Platonic spectator of Being in its One/Many-marked appearance retains a definitely paradoxical flavour.

SOME PRELIMINARY NOTIONS.— In order to fully establish \exists we need, I repeat, a procedure whereby “two different kinds of infinity are generated simultaneously”, and in which “the points of division are used twice”. The two kinds of infinity are *simultaneously* there and have a *different* status: as partitions and as parts. Because of the constructive simultaneity, they do not only come both about at once, but pop up as well without anything else intervening between them. This latter point gives us a clue as to where to look for a viable mathematical approach, for in set theory a very important hypothetical theorem deals exactly with this type of situation. This is **Cantor's continuum hypothesis**. But before we can appropriately make use of it ourselves, we first have to turn our attention to the question that underlies it. Let us briefly review its mathematical and conceptual content. We saw that Zeno's plurality paradox can be seen as a divisional procedure for constructing the continuum as instantiated in a finitely extended body representable as a part of the real line. It would be nice to know how much 'parts' are exactly needed to build it up. This is precisely the zest of Cantor's continuum problem: *How many points are there on a straight line in Euclidean space?*⁶⁸ We already saw that multiple infinite cardinalities exist. They are represented by indexed Hebrew characters called alephs (\aleph_i). The continuum hypothesis is the question: what is the cardinality \aleph_c (or c , in a to-day more common notation) of the continuum? Let us take a look at it more closely. Cantor defined the magnitude of a set by means of its *cardinality*. Two sets are equivalent, that is, a bijective relationship between their elements exists, when their cardinalities are equal.⁶⁹ But there is an other number that expresses a basic characteristic of a set, its *ordinality*. Cardinality expresses the simultaneous totality, the number of elements present of a given set; ordinality concerns the order by way of which these elements are generated stepwise. “*Mächtigkeit*” oder “*Kardinalzahl*” nennen wir den Allgemeinbegriff, welcher mit Hilfe unseres aktiven Denkvermögens dadurch aus der Menge M hervorgeht, daß von der Beschaffenheit ihrer verschiedenen Elemente m und von der Ordnung ihres Gegebenseins abstrahiert wird.⁷⁰ In the finite case there is no problem: a basket containing eight apples is a set

⁶⁷M. Serfati, “Quasi-ensembles d'ordre r et approximations de répartitions ordonnées”, *Math. Inf. Sci. hum.*, **143**, 1998, pp. 5-26.

⁶⁸K. Gödel, “What is Cantor's continuum problem?”, *BPPM*, p. 470.

⁶⁹unter eine “Belegung von N mit M ” verstehen wir ein Gesetz, durch welches mit jedem Elemente n von N je ein bestimmtes Element von M verbunden ist (...). Das mit n verbundene Element von M ist gewissermaßen eine eindeutige Funktion von n und kann etwa mit $f(n)$ bezeichnet werden (...); G. Cantor, “Beiträge zur Begründung der transfiniten Mengenlehre”, *GA*, p. 287.

⁷⁰G. Cantor, “Beiträge”, *GA*, p. 282.

with cardinality eight, its ordinality being eight as well, given that we count the apples one by one. We can add one apple; now we have nine. We can get to any arbitrarily big natural number this way. This is how Cantor constructs *potential* infinity. He furthermore showed that the set of natural numbers \mathbb{N} and the set of finite fractions \mathbb{Q} possess the same *countably infinite* cardinality, which means that, although their elements can be enumerated, they can never be exhausted by means of enumeration. He labelled it Aleph-null (\aleph_0). Thus the set of natural numbers \mathbb{N} and the set of finite fractions \mathbb{Q} are equivalent. The basic ordinality that goes with it he called ω . It is possible to construct an infinite sequence of different ordinal numbers ω_i that all belong to that same *number class* of cardinality \aleph_0 . The difference between ordinals becomes relevant from the moment the numbers so defined are infinite. Consider for instance the set of natural numbers ordered in the traditional manner $\{0, 1, 2, \dots\}$ and ordered alternatively $\{1, 2, \dots, 0\}$. The cardinal number of these sets will be equal; their ordinal numbers will be respectively ω and $\omega + 1$. The set $\{2, 4, 6, \dots; 1, 3, 5, \dots\}$ (even and odd numbers) has ordinality 2ω . The number of possible rearrangements is clearly unlimited. Nevertheless, they all belong to the number class of \aleph_0 . Now it is possible to build an infinite sequence of ordinalities by application of two different “Erzeugungsprinzipien” or Principles of Generation⁷¹:

- First Principle of Generation: *Addition of a unit to the previously formed number*;
- Second Principle of Generation: *Definition of the limit of every infinite sequence of numbers as the nearest limit value [supremum] outside of it.*

Thus a new number is created justly outside the infinite sequence of already existing ordinalities with cardinality \aleph_0 , which represents an infinity necessarily *greater* than \aleph_0 . Cantor calls this new, bigger infinite cardinality naturally enough \aleph_1 . The first infinite cardinality \aleph_0 defines the second number class $Z(\aleph_1)$.⁷² The new basic ordinality can now be used to construct a new sequence of ordinalities, all belonging to $Z(\aleph_2)$, the third number class. A sequence of ever greater alephs can be built by systematically applying the two principles of generation so that no upper bound can be assigned to it; with each aleph a new, bigger cardinality equivalent to the smallest ordinality of its respective number class: $\omega_i = Z(\aleph_{i+1})$; $\omega_{i+1} = Z(\aleph_{i+2})$, &c. Cantor proves by means of an argument known as *diagonalisation* that indeed $\aleph_0 < \aleph_1$. Another way to prove it is Cantor’s powerset Theorem: $E \prec \mathcal{P}(E)$.⁷³ From his powerset theorem Cantor infers the general theorem that for each and every cardinal number, as well as set of cardinal numbers, an immediate successor exists: $\aleph_n < \aleph_{n+1}$, with $n \in \mathbb{N}$.⁷⁴ It will be clear that one thus not only obtains ascending sequences of ordinal, but also of cardinal numbers $\aleph_0, \aleph_1, \aleph_2 \dots!$ ⁷⁵ The sequence of *all* possible ordinals Cantor

⁷¹G. Cantor, “Beiträge”, *GA*, pp. 312-356. Accessible treatments can be found in R. Rucker, *Infinity and the Mind. The Science and Philosophy of the Infinite*, Princeton University Press, Princeton, 1982 [1995], p. 65 sq, p. 223; and M. Tyles, *o.c.*, pp. 104-107, of whom I borrow the English terminology.

⁷²The first number class $Z(\aleph_0)$ comprises the finite ordinalities embodied by the set \mathbb{N} .

⁷³F. Hausdorff, *Mengenlehre*, pp. 56-57; G.S. Boolos and R.C. Jeffrey, *Computability and Logic*, CUP, Cambridge, 1974/1989, p. 1 sq.

⁷⁴F. Hausdorff, *Mengenlehre*, pp. 67-68.

⁷⁵Cantor exposes his method in a succinct and clear way in a letter to Dedekind (1899). A translated version in J. Heyenoort, *From Frege to Gödel*, Harvard, 1967, pp. 113-117.

called Ω ; the sequence of all possible cardinals $\aleph_0, \aleph_1, \aleph_2 \dots$ he called \beth .⁷⁶ These objects are themselves not sets, for “thinking them as a whole” leads to paradoxes.⁷⁷ Such collections, let us say to ‘big’ to be thought as a whole, Cantor termed *inconsistent multiplicities*. Every possible cardinal number will be represented somewhere in the sequence \beth . In order to prove this latter point, one needs the often contested, but critical, *Axiom of Choice* [AC].⁷⁸ Intuitively, the AC allows that a *simultaneous choice of distinguished elements is in principle always possible for an arbitrary set of sets*.⁷⁹ Zermelo, in his edition of Cantor's collected work, castigates him for failing to have realised this, thus committing a variant of the familiar Bernoullian fallacy: *Only through the use of the AC, which postulates the possibility of a simultaneous choice (...)*⁸⁰ Although essential to its logical viability, this simultaneous character of AC is often forgotten or dismissed, while Zermelo himself never gets tired of stressing its importance. We now possess the instruments to reformulate our original question: which one of the alephs in our sequence is equal to the number of points 2^{\aleph_0} on the continuous line? Where exactly in the totality of all possible cardinalities this number is to be situated?⁸¹ Cantor demonstrated by means of diagonalisation that $2^{\aleph_0} > \aleph_0$, and advanced the hypothesis that it should be its immediate successor, \aleph_1 . This is Cantor's famous Continuum Hypothesis (CH)⁸²:

$$2^{\aleph_0} = \aleph_1$$

Every infinite subset of the continuum has the power either of the set of integers, or of the whole of the continuum, with no intermediate cardinalities intervening. As could be expected, the hypothesis can again be generalised, so as to comprise all possible cardinalities: the Generalised Continuum Hypothesis.⁸³ We will notwithstanding limit ourselves to CH, for the nature of our problem is demarcated by Zeno clearly to the realm of the physical, even when encountered in its mathematical expression: the reality of plurality and motion, as problematised in the clash between continuous and

⁷⁶*Idem*, *FTG*, pp. 113-117.

⁷⁷In the case of Ω the Burali-Forti paradox: if the set of ordinals is well ordered (i.e., every segment has a least element), it has an ordinal, which is at the same time an element of this set and greater than any of its elements. It is a variant of the more familiar Russell paradox. G. Cantor, “Letter to Dedekind”, in: J. Van Heijenoort, *From Frege to Gödel* [FTG in what follows], pp. 115-117. See also the paper by C. Burali-Forti, *id.*, pp. 104-112. This fact — *diese ominöse “Menge W”* [E. Zermelo] — was the source of a vivid controversy at the beginning of the last century. In addition to the papers present (in translation) in *FTG*, one will profitably consult the volume composed by G. Heinzmann, *Poincaré, Russell, Zermelo et Peano. Textes de la discussion (1906-1912) sur les fondements des mathématiques: des antinomies à la prédicativité*, Blanchard, Paris, 1986, where a number of relevant but sometimes less well known papers are collected in their original form. The Zermelo-quote stems from that source, p. 119. A relation to the axiom of choice is exposed in M. Potter, *Set Theory and its Philosophy*, Oxford University Press, Oxford, 2004, p. 243 sq.

⁷⁸K. Gödel, “What is Cantor's continuum problem?”, *BPPM*, p. 471.

⁷⁹E. Zermelo, “A new proof of the possibility of a well-ordering”, *FTG*, p. 186.

⁸⁰E. Zermelo in *FTG*, p. 117, ft. 3, to Cantor's letter to Dedekind reprinted therein.

⁸¹*Il faut distinguer entre l'hypothèse du continu et le problème du continu (Kontinuumproblem), qui consiste à déterminer la place occupée par le continu parmi les alephs, c.à.d. à déterminer le nombre ordinal α pour lequel $2^{\aleph_0} = \aleph_\alpha$* , explains W. Sierpiński, *Hypothèse du Continu*, Z Subwencji Funduszu Kultury Narodowej, Warszawa/Lwów, 1934 (reprinted in 1956 by the Chelsea Publishing Company), p. 5.

⁸²K. Gödel, “What is Cantor's continuum problem?”, *BPPM*, p. 472.

⁸³Maar: $|2^{\aleph_0}|$ kan iets anders zijn dan \aleph_1 !

discrete: *the objects of transfinite set theory (...) clearly do not belong to the physical world and even their indirect connection with physical experience is very loose.*⁸⁴ Cantor's Continuum Hypothesis is an important but contested mathematical statement that brings together countable \mathbb{N} and uncountable $2^{\mathbb{N}}$ infinities in a simultaneous way and with no other cardinality intervening. It is contested because its validity is undecidable within the framework of Zermelo-Fraenkel axiomatics (equipped with AC) for set theory, as has been proven by Gödel and Cohen. We do not presuppose ZF, however, and will speak about sets in an utterly naive way. We claim that, by generating the large[s]-and-small[s], Zeno's procedure \mathfrak{Z} really does the same as CH. We shall see in what follows that in Zeno's construction do indeed appear the cardinalities associated with the naturals and the reals, and nothing else, so that in the world made up from the elements of Zeno's paradox — plurality, extension and change —, Cantor's Continuum Hypothesis is valid, or, put otherwise, that they are aequivalent:

$$\mathfrak{Z} \equiv \aleph_0 \neq 2^{\aleph_0} = \aleph_1$$

OUTLINE OF THE PROOF.— It is natural to represent a Zenonian extended body by a finite continuous line segment.⁸⁵ We therefore conceive of \mathfrak{Z} as applied to such an idealised measuring rod M , which we arbitrarily set equal to unity. Now M will be dichotomised Zenonian-wise, i.e., **at infinity, through and through, and simultaneously**. We label the resulting left-hand parts 0, the right-hand parts 1 in every subsequent generation. At each division a *canonical choice* is required that sends the divisional sequence down along a specific path. We obtain a collection of nodes and paths, each equipped with a unique binary representation.⁸⁶ Thanks to the simultaneity, *the procedure and its result coincide*, so that we can look at it constructively, without being forced into an intuitionistic approach. In the \mathbb{N} -th generation, at the ω -divisional level, the collection forms the set $\{0, 1\}^{\mathbb{N}}$, that contains all possible partitions (nodes) with their parts (connecting paths). It represents all possible orders on \mathbb{N} . The set thus generated must be aequivalent to the powerset-lattice for \mathbb{N} . But this is only a part of the story, because the pathways followed by generation matter as well. As already indicated, the procedure can be viewed from two different perspectives: a stepwise doubling of the number of cells at every generation, the number of generations being $n \leq \omega$, or the totality of all possible combinations of zeros and ones, viz. the power set of $\mathcal{P}(\mathbb{N}) = \{0, 1\}^{\mathbb{N}}$ *with some additional structure*; this object being the simplest possible instance of the **Cantor set**. The first process is simultaneously contained in the second. We thus obtain the two kinds of infinity constituting a finite body: an infinity of extended parts — the *ever smaller regions* of the intuitionists — which would generate when left on its own an infinitely large body. And an infinity of unextended parts — points — which, when left on its own, would generate a body with no extension at all. This absurdity does *not* arise because division generates them both together — *kai* — and at once. Conclusion: Zeno's divisional procedure can be represented by a binary

⁸⁴K. Gödel, "What is Cantor's continuum problem?", *BPPM*, p. 483. The quotation at the beginning of this paragraph is on p. 483 of that same book.

⁸⁵VLAS, p. 222, shows that of an existant only extension is considered.

⁸⁶Weyl was the first to formulate this idea, but he linked binary numbers with the nodes of the tree, thus only capturing the potential infinity encoded by it. Given his finitist a priori this was natural enough. H. Weyl, *o.c.*, pp. 43-54. See also Tyles, *o.c.*, pp. 64-67.

tree, a Zenonian semi-lattice in which the nodes represent the *megala*, while the *micra* are given by its paths, in two different infinities, as follows:

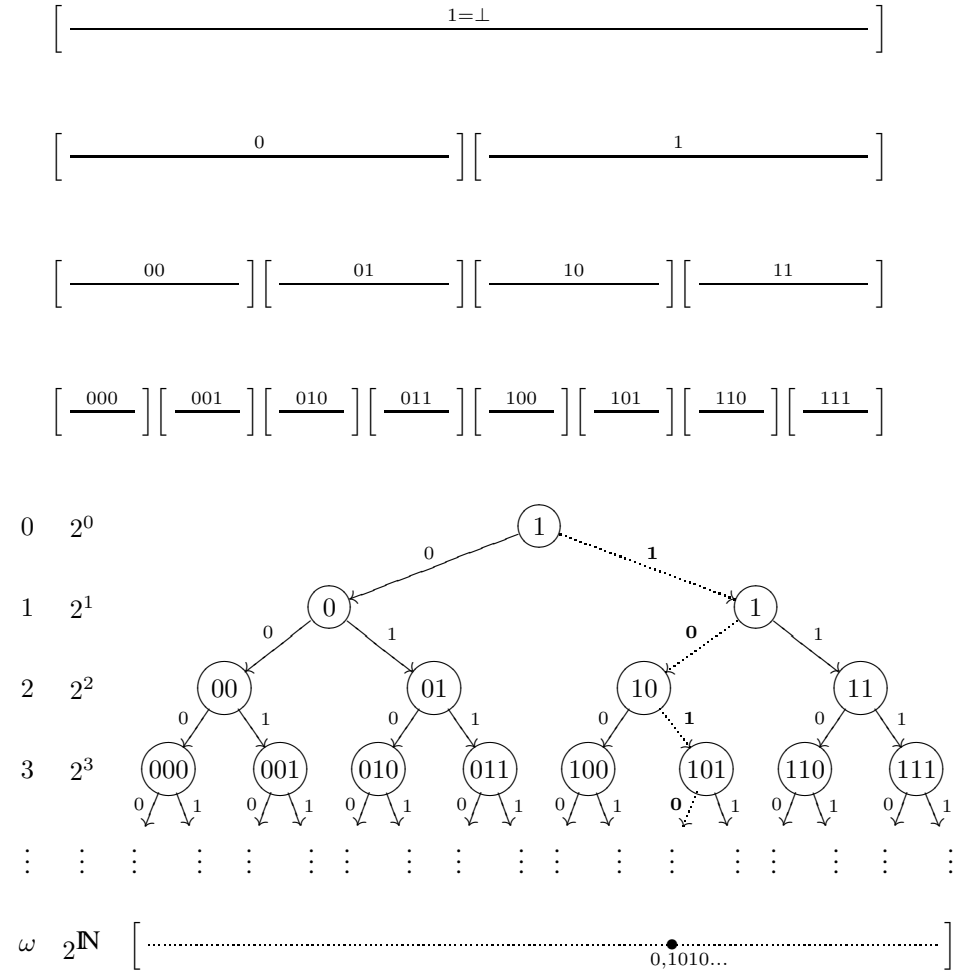

The measuring rod $M \{0, 1\}^{\mathbb{N}}$, the *Philebian set* \mathbb{P} .

For in two ways it can be said that a distance or a period or any other continuum is infinite [*apeiron*], viz., with respect to the partitions or with respect to the projecting parts [Aristotle, *Phys. Z*, 2, 263a (24-26)].

For whoever divides the continuum into two halves thereby confers a double function on the point of division, for he makes it both a beginning and an end [*Phys. Θ* 8, 263a (23-25)].

A formal language appropriate to describe such structures is **domain theory**.⁸⁷ Let us once again review some basic notions. Given is the partially ordered set (P, \leq) . A subset S of P is an *upper set* if $\forall s, t \in S$ with $s \leq t : s \in S \Rightarrow t \in S$. The symbol $\uparrow s$ denotes all elements above an $s \in S$. An element v of P is an upper bound for $S \subseteq P$ if for any $s \in S : s \leq v$. The least element of the set of upper bounds of S is called the *supremum* (or *join*) $\bigvee S$. An element $t \in P$ is *maximal* if there is no other element of P above it. A *directed upper set or filter* S of P is a nonempty set of which every pair of elements has an upper bound in S . If the condition $\uparrow s$ is met, S is called a *principal filter*. The dual notions *lower (or down) set* $\downarrow s$, lower bound, *infimum* (or *meet*) $\bigwedge S$, minimal element and *directed lower set or ideal* appear by reversing the order (arrows). Order in the case of Zenonian division increases with decreasing intervals, so that $(10) \rightarrow (101)$ implies $(10) < (101)$. The smallest element is unity, the measuring rod M itself. Zeno's division operates by the application of two simple rules of mathematical construction, two functions that map partitions on parts:

1. $r_1 : n \rightarrow 2n$ division stepwise \rightsquigarrow 'small' \mathcal{Z} ;
2. $r_2 : n \rightarrow 2^n$ simultaneous division, with $n \leq \omega \rightsquigarrow$ 'large' \mathfrak{Z} .

Application of these two rules suffices to build \mathfrak{Z} constructively⁸⁸ as the simplest instance possible of the Cantor set. The constructive reasoning used does *not* compel us to an intuitionistic point of view since thanks to simultaneity we can work with actual infinities in a logically consistent way. We discussed before the Zenonian principle of **the equivalence of the parts and the whole**.⁸⁹ It is essential to translate this principle, a direct consequence of Zeno's deictically realistic, exhaustive procedure, into a variant of the basic constructivist credo.⁹⁰ Let us extract the principle underlying this construction and summarise it as follows:

Zeno's Principle (ZP): *In a construction appear only those objects that are constructed effectively, by using rules of construction given explicitly.*

The proof basically goes in three steps. Firstly, the simultaneous jump from countably many *megala* to uncountably many *micra* can be rigorously described as the ideal completion of the small semi-lattice (\mathcal{Z}, \leq) into the large semi-lattice (\mathfrak{Z}, \leq) .⁹¹ Every node

⁸⁷S. Abramski and A. Jung, "Domain Theory", in *Handbook for Logic in Computer Science*, S. Abramski, D. M. Gabbay and T.S.E. Maibaum [eds.], Clarendon Press, Oxford, 1994, chapters 1,2. I thank Bob Coecke (Oxford) for clarifying discussions on this subject.

⁸⁸A bit in the spirit intended by Smyth when he writes: *It may be asked whether (...) we adhere to constructive reasoning in our proofs. Actually our procedure is somewhat eclectic.* M.B Smyth, *The Constructive Maximal Point Space and Partial Metrizable*, preprint: <http://www.comp.leeds.ac.uk/anthonyr/dtg/papers.htm>.

⁸⁹W.E. Abraham, "Plurality", *Phronesis*, **17**, 1972, pp. 40-52.

⁹⁰The importance of an explicit formulation of Zeno's Principle was brought home to me during a discussion with R. Hinnion (ULB), for it clearly demarcates the nature of the proposed representation. Propositions with regard to CH or AC in the following pages are valid within the confines of Zeno's construction; they do not imply any claim with respect to, say, the Zermelo-Fraenkel axiomatisation of set theory.

⁹¹C.q. cardinal vs. ordinal completion; W.E. Abraham, "Plurality", pp. 40-52.

at the ω -divisional level or, alternatively, every possible branch in the \mathbb{N}^{th} generation, i.e., every element z generated by \mathfrak{Z} , represents a unique sequence $f(z) = (x_n)_{n \in \mathbb{N}}$. The finite ideals $\downarrow x$ can be ordered by inclusion. They all have a supremum. The supremum of the infinite ω -chain of which they are a part is the maximal element $\uparrow z \cap \mathfrak{Z} = \{z\}$. Appropriately enough, a constructive interpretation of the notion of maximality as a criterion or *test of fineness* has been developed by Martin-löf.⁹² Each ω -chain defines a unique order on \mathbb{N} . Every ordinality on \mathbb{N} coincides in a unique way with such a chain and, by virtue of ZP, no other chains do appear. This gives the orderstructure of $\mathcal{P}(\mathbb{N})$. Therefore the Zenonian semi-lattice (\mathfrak{Z}, \leq) is a directed and complete partial order or *dcpo*.

But \mathfrak{Z} is a total order \prec as well. For by the canonical numbering of the parts, an additional order per generation is imposed, and all elements z will be comparable: $\forall z, z'; z \prec z' \vee z' \prec z$; whence (\mathfrak{Z}, \prec) is a directed and complete total order or *dcto*. This order catches the influence exercised on the structure by the divisional pathways. Semantically speaking: the logic encoded by them is intensional, not extensional. This total order is lexicographic, i.e., according to the *principle of first differences*⁹³ like in Hausdorff's dictionary.⁹⁴ \triangleleft

Our next step is to establish the existence of certain bijective relationships. This demonstration essentially relies on the well-known Cantor-Schröder-Bernstein theorem. It will not be admissible, however, to equate the left and right hand variants of the binary representations of partitions, the points of division at the rational multiples of 2^{-n} , as in the standard case.⁹⁵ They will on the contrary be used as the lefthand d and righthand d' closure of the adjacent, non-overlapping parts, represented by intervals, produced in every generation. This by the way completely justifies Aristotle's seemingly enigmatic comment: *For in two ways it can be said that a distance or a period or any other continuum is infinite, viz., with respect to the partitions or with respect to the projecting parts* [*Phys. Z*, 2, 263a (24-26)]. In honour of Brouwer, we will call them **dubbelpunten** [double points] or simply **dubbels** [doubles].⁹⁶

$$M \xrightarrow{1} \text{semi-lattice} = \{0, 1\}^{\mathbb{N}} \xleftrightarrow{2} [0, 1] \xrightarrow{3} \mathbb{R}$$

The set of all possible binary sequences $f(z)$ is $\{0, 1\}^{\mathbb{N}}$. We already saw that $|\{0, 1\}^{\mathbb{N}}| = 2^{\mathbb{N}}$. Let us now remove one of every pair of doubles d and d' that came with the rational partitions in \mathfrak{Z} from our set of sequences, by making a **canonical choice** for the lefthand side (L_c) or the righthand side (R_c) in every instance at every generation. A canonical choice is a function $f_c : A \dot{\cup} B \xrightarrow{\cong} \{0, 1\}^{\mathbb{N}}$. Let $d = L_c$. We choose in all cases the zero-side by L_c .

$$A = \{(x_n)_n \in \{0, 1\}^{\mathbb{N}} \mid \nexists N : \forall n > N : x_n = 1\}$$

⁹²Discussed in M.B. Smyth, *o.c.*, p. 3, p. 7 sq.

⁹³K. Kuratowski and M. Mostowski, *Set Theory*, North Holland, Amsterdam, 1968, pp. 224-227.

⁹⁴R. Rucker, *o.c.*, pp. 82-83.

⁹⁵P.J. Cameron, *Sets, Logic an Categories*, Springer, London etc., 1999, p. 128-129.

⁹⁶L.E.J. Brouwer, *o.c.*, p. 56.

A does not contain any sequences that exhibit only ones from a certain x_n on. We filter out the right hand representations of the rational multiples of 2^{-n} . The so-called redundancy in the binary representation of the real numbers is now removed. Our set A is thus identical with the standard interval $[0, 1]$. In our case, however, the removed sequences are not simply deleted, but carefully collected in a separate set B .

$$B = \{(x_n)_n \in \{0, 1\}^{\mathbb{N}} \mid \exists N : \forall n > N : x_n = 1\}$$

This set contains exactly those sequences that do exhibit only ones from a certain x_n onwards; its cardinality will be $|\mathbb{N}|$. From our definition it follows that $A = B^c$, such that $A \dot{\cup} B = \{0, 1\}^{\mathbb{N}}$. The cardinality of the coproduct or disjoint union $A \dot{\cup} B$ is equal to the sum of the cardinalities of the sets composing it: $|[0, 1]| + |\mathbb{N}| = 2^{\mathbb{N}}$. Indeed, from Cantor's diagonalisation argument we know that $2^{\aleph_0} + \aleph_0 = 2^{\aleph_0}$.⁹⁷ Equal powers imply equivalence; thus we can conclude $\{0, 1\}^{\mathbb{N}} \longleftrightarrow [0, 1]$. By virtue of its total order, our set $\{0, 1\}^{\mathbb{N}}$ is complete, and a complete set which has a countably dense subset is a continuum. And every continuum is isomorphic to the real line.⁹⁸ (The equivalence of $[0, 1]$ with \mathbb{R} is standard and can be shown by geometrical means.) This establishes the required equivalences. \triangleleft

Thirdly regarding order. Our situation reminds us of that of infinite sets which, an equal cardinality notwithstanding, possess different ordinalities. Plato makes plain that this divisional procedure can proceed by "twoness", but equally well by "threeness", or any other number [*Philebus*, 16(e)], although the examples given are always carried out by means of *aoristos duas*. Therefore we will call in what follows $\{0, 1\}^{\mathbb{N}}$ the **Philebian set**, symbolised by \mathbb{P} . This brings us to the theorem: the sets \mathbb{P} and \mathbb{R} possess equal cardinality but different ordinality⁹⁹:

$$\{0, 1\}^{\mathbb{N}} \text{ is } \mathbf{not\ order-isomorphic} \text{ to } [0, 1]$$

Now X is order-isomorphic with Y iff a bijection exists that satisfies the following condition: $k : (X, \leq) \rightarrow (Y, \leq)$ with $x \leq y \Leftrightarrow k(x) \leq k(y)$. This implies that, if (Y, \leq) is dense, then (X, \leq) will be dense as well. Indeed, suppose Y to be dense. Let k be an order-isomorphism, such that $k : X \rightarrow Y : a < b \Leftrightarrow k(a) < k(b)$.

Take $c < d \in Y$ then $\exists! a, b \in X : k(a) = c, k(b) = d$. But Y is dense, therefore $\exists m \in Y : c < m < d$ and so $a = k^{-1}(c) \leq k^{-1}(m) \leq b = k^{-1}(d)$. However, we demonstrated before that the order generated by \mathfrak{Z} is lexicographic by nature. This order is preserved even for the rational doubles d and d' , for which the inequality $d < d'$ holds. But $\nexists m \in \{0, 1\}^{\mathbb{N}} : d < m < d'$. Then $\{0, 1\}^{\mathbb{N}}$ cannot be dense everywhere. By our canonical choice L_c we removed all d' from $\{0, 1\}^{\mathbb{N}}$, thus generating a

⁹⁷The difficulties going with arbitrary sums of infinite powers are discussed in M. Potter, *o.c.*, p. 170 sq.

⁹⁸The conditions for completeness are either that every non-empty subset of a considered set which has an upper bound has a supremum, or that every non-empty subset with a lower bound has a minimum. Given the order imposed on $\{0, 1\}^{\mathbb{N}}$, the second condition is trivially fulfilled. M. Potter, *o.c.*, pp. 119-121.

⁹⁹I owe this idea to a discussion with Tim Van der Linden.

set A which clearly has the property of being dense, in exactly the same way as $[0, 1]$. Therefore $[0, 1]$ and $\{0, 1\}^{\mathbb{N}}$ cannot be order-isomorphic. Furthermore all ideals $\downarrow x$ included in each unique sequence $f(z) = (x_n)_{n \in \mathbb{N}}$ in \mathbb{P} are finite and non-empty. A well-order S is a total order in which every non-empty subset of S has a least element. This is trivially the case here; whence \mathbb{P} is a well-order. And well-ordering is equivalent to the AC. Thus Zeno's procedure comes about as a precept for the construction of a well-ordered continuum! \triangleleft

Now consider the following statement:

*Though Zermelo's theorem assures that every set can be well-ordered, no specific construction for well-ordering any uncountable set (say, the real numbers) is known. Furthermore, there are sets for which no specific construction of a total order (let alone a well-order) is known (...)*¹⁰⁰

CONCLUSION.— For Zeno's divisional procedure we proved the following¹⁰¹

- * Divisional procedure $\mathfrak{Z} \equiv (\mathfrak{Z}, \prec)$ (simultaneity)
- * Immediate successor (ideal completion)
- * Two different kinds of infinity $|\mathbb{N}| \neq |2^{\mathbb{N}}|$ (Cantor's Theorem)
- * Axiom of Choice (well-ordering)
- * $M \xrightarrow{1} \text{lattice} = \{0, 1\}^{\mathbb{N}} \xrightarrow{2} [0, 1] \xrightarrow{3} \mathbb{R}$ (Cantor-Bernstein)

Contrary to the above statement, our claim is that Zeno's divisional procedure provides a specific way to construct a well-ordered continuum isomorphic to the real number line (though *not* to \mathbb{R}), in which Cantor's continuum hypothesis is valid:

$$\mathfrak{Z} \equiv \aleph_0 \neq 2^{\aleph_0} = \aleph_1$$

REMARK.— Every real number in this construction is represented and defined by a unique order on the set of natural numbers, a specific subset $f(z) \in \mathcal{P}(\mathbb{N})$. Moreover, thanks to ZP all orders on \mathbb{N} are included, and nothing else, hence the argument is truly constructive. The “line” formed by the divisional *loci* (d_i, d'_i) is isomorphic to the rational line. Is it possible to get the rational line per se, so that the point intervals to which each of the (d_i, d'_i) supplies an ending and an opening bracket contain exactly the irrationals? A promising line of thought could be to generalise the divisional

¹⁰⁰J. Dugundji, *Topology*, Allyn and Bacon, Boston, 1966, p. 35.

¹⁰¹C. Vidal (Sorbonne) attracted my attention to a book by A.W. Moore, *The Infinite*, Routledge, London and N.Y., 2001 [1990], in which, though without invoking Zeno, a promising line of ideas is developed, proposing a link between “infinity by addition” and “infinity by division” — clearly the same concepts as our “stepwise” and “simultaneous” division —, the continuum hypothesis and the cardinalities of \mathbb{N} and \mathbb{R} , but only to dismiss the possibility! The reason apparently is that it implies according to Moore a variant of the Bernoullian fallacy, given his reference to (rational) density. See pp. 154-158 of the cited work. I want to stress once more that Zeno does not commit any such fallacy, and refer to our own, but also to Abraham's analysis of Zeno's ideas. For the latter, see Abraham's already referenced Plurality-article.

procedure over all prime numbers, a suggestion bestowed with some authority by tradition.¹⁰² It is clear that one should include as well the powers of the primes np^k , with $n, k \in \mathbb{N}$. All rationals are doubly represented in that case, an apt way to enhance their character of finite fractions. But even then not all possible intervals are covered, thanks to the one dimensional a priori implicit in the division. This not yet suffices to recover all ordinals of ordertype zero, for we still do not cover all possible divisional intervals. In order to do that, one should introduce multiples of powers of primes. One then of course calls upon the availability of the natural numbers, but this is no problem, since \exists generates these. This would, however, constitute a deviation of Zeno's intentions — the one-dimensional a priori being inhaerent to his procedure — which is neither appropriate, neither necessary here. So we are left with an infinity of infinitely tiny holes in Zeno's strange continuum. Intuitively, they are so small as to be numbers smaller than whatever real number given, but different from $0 : h < r$ with $r \in \mathbb{R}$. In other words, they do not obey the Archimedean axiom: $\forall x, y \in \mathbb{R}$ with $x < y : \exists m \in \mathbb{N} : m \cdot x > y$, which precisely excludes the existence of infinitesimally small numbers.¹⁰³ Put otherwise: h is an infinitesimal iff $\forall m \in \mathbb{N} : |m \cdot h| < 1$. This implies that, whatever they are, they are not reals. But there are numbers in mathematics that fulfill the criterium of being smaller than whatever given real. They are called **infinitesimals**. They suffer from a bad reputation, however, for they are held responsible for the notoriously shaky nature of the foundations on which the early calculus rests. It is well known that the *locus classicus* of modern natural science, Newton's monumental *Principia* [1687]¹⁰⁴, uses a theory of infinitesimals in a geometrically disguised manner. The underlying *theory of fluxions*, which explicitly uses infinitesimals, got published only afterwards, although it was developed twenty years before the *Principia* appeared. A clear exposition of the fluxion-theory cast in a geometrical framework can be found in the short tract *De Quadratura curvarum*, published as an appendix to Clarke's latin translation of the *Opticks* [1706].¹⁰⁵ That other giant, Leibniz, published his own version of the calculus as the *Nova Methodus* in the *Acta Eruditorum* [1684].¹⁰⁶ The notations currently in use in calculus are introduced therein, together with a proof of Leibniz's "chain rule". We already explained that an infinitesimal number is a number smaller than any given real number, while it remains different from 0. Newton and Leibniz dealt with these quantities in their attempts to formalise consistently the apparently natural notions shoring up the newly emerging infinitesimal calculus. But they hit upon deeply rooted logical paradoxes. Berkeley with apparent taste exposed them in a devastating way in his *The analyst*.¹⁰⁷ The problem essentially boils down to the fact that something being

¹⁰²J. Stenzel, *o.c.*, p. 53 sq. refers to a passage in Book A of the *Metaphysics*. See especially p. 56.

¹⁰³R. Courant and F. John, *Introduction to Calculus and Analysis*, vol. I, Wiley/Interscience, 1965., p. 94.

¹⁰⁴A modern edition known as the *variorum* edition has been edited by A. Koyré and I.B. Cohen, *Isaac Newton's Philosophiæ Naturalis Principia Mathematica, The Third Edition (1726) with variant readings*, Cambridge University Press, Cambridge, 1972.

¹⁰⁵A discussion of Newton's underlying 'finitist' approach towards descriptions of natural phenomena, as well as his reasons for sticking to the classic geometrical approach, can be found in G. Guicciardini, *Reading the Principia. The Debate on Newton's Mathematical Methods for Natural Philosophy from 1687 to 1736*, Cambridge University Press, Cambridge, 1999/2003, p. 27 sq.

¹⁰⁶G.W. Leibniz, "Nova methodus pro maximis et minimis, itemque tangentibus, quae nec fractas nec irrationales quantitates moratur, et singulare pro illis calculi genus", *Acta Eruditorum*, vol. III, 1684.

¹⁰⁷I consulted the electronic edition edited by D.R. Wilkins: <http://www.maths.tcd.ie/pub/HistMath/People/>

in the sense of extended) transforms into something being not, whence his notorious expression that they are *the ghosts of departed quantities*. These logical problems concomitant to the direct use of infinitesimals in calculus led to the development of the Cauchy theory of limits, and the subsequent reformulation of the basic definitions of calculus in terms of Weierstrassian ϵ - δ formalism.¹⁰⁸ One can however doubt whether the problem really disappeared because an axiom of continuity has to be invoked to render the method unambiguous. The concept of infinitesimal resurfaced again during the second half of the twentieth century, thanks to the work of Abraham Robinson, who explicitly considers his work as an actualisation of Leibniz's ideas. In order to avoid the logical problems intrinsic to them, he introduced infinitesimals defined as *hyper-real numbers* by means of *model theory*.¹⁰⁹ In this paper, a minimalistic, at first purely algebraic approach will be followed based on *dual* or *nilpotent* numbers, in which the *détour* via model theory can be avoided. It is an alternative to a more geometrical approach developed by Bell.¹¹⁰ It will bring about its own logical problems nevertheless, while being entitled to a historical provenance of an ancestry comparable to the other systems. Now the suggestion is to fill out the divisional holes by means of infinitesimals. Let us follow up this suggestion.

ZENONIAN INFINITESIMALS.— Although the set \mathbb{P} generated by \mathfrak{J} clearly is a continuum, we would rather like to be certain with regard to its precise nature, for we would like to do analysis and other things that allow us to apply mathematics on the real world, as in the case of the paradoxes of motion. On the other hand, our problem might at first not seem very serious, for it apparently suffices to systematically equate the unequal objects d_i and d'_i to get back to \mathbb{R} , and be able to do calculus perfectly well. But that would bring us off the track we set out at the start, which is to stay loyal to Zeno's intentions as much as possible. Luckily enough a way out has been opened up for us by Henri Poincaré. It consists of carefully distinguishing between the different notions of "continuum" which in general are uncritically mixed up, and to make explicit these differences formally. Developing an idea he already launched in *La science et l'hypothèse*¹¹¹, Poincaré writes: *Il arrive que nous sommes capables de distinguer deux impressions l'une de l'autre, tandis que nous ne saurions distinguer chacune d'elles d'une même troisième*.¹¹² We could, say, distinguish a weight of 12 grammes from one of 10 grammes, while the intermediate weight of 11 grammes would be indistinguishable from either of both. In our experience of physical reality, there would be a continuum between them. This amounts into the following paradoxical definition of *le continu physique*:

$$A = B, B = C, A < C$$

Berkeley/Analyst/Analyst.html.

¹⁰⁸R. Courant and F. John, *o.c.*, vol. I, pp. 95-97.

¹⁰⁹A. Robinson, *Non-Standard Analysis*, North-Holland, Amsterdam/London, 1966/1974. For Leibniz, see p. 2; p. 260 sq. Also J.M. Henle and E.M. Kleinberg, *Infinitesimal Calculus*, Dover, 1979/2003.

¹¹⁰Nilpotent infinitesimals have been re-introduced by J.L. Bell in the realm of intuitionistic mathematics. The standard reference is: J.L. Bell, *A Primer of Infinitesimal Analysis*, Cambridge University Press, Cambridge, 1998.

¹¹¹*SHYP*, p. 51 sq.

¹¹²*SVAL*, p. 61.

which clearly violates the *Principium Contradictionis*. But suppose we enlarge our perceptive capacities; would then the difficulty not simply disappear? No, for it would be easy enough to find elements D, E that can be intercalated between A, B so that

$$A = D, D = B, A < B; B = E, E = C, B < C$$

and so on, ad infinitum, in analogy with infinite division. The difficulty does only recede, not disappear. It is remarkable how close this comes to Brouwer's original starting point: *we [zullen] nader ingaan op de oer-intuïtie der wiskunde (...) als het van qualiteit ontdane substraat van alle waarneming van verandering, een eenheid van continu en discreet, een mogelijkheid van samendenken van meerdere eenheden, verbonden door een "tussen", dat door inschakeling van nieuwe eenheden, zich nooit uitput.*¹¹³ This is why Poincaré calls the physical continuum *une nébuleuse non résolue*. The mathematical continuum will serve to resolve this cloud and thus to remove the intolerable contradiction: *c'est le continue mathématique qui est la nébuleuse résolue en étoiles.*¹¹⁴ That this description really catches the notion of division we explicated in §3 on behalf of Zeno is plain, because of the decisive property it shares with the latter: *Celui-ci est une échelle dont les échelons (nombres commensurables ou incommensurables)¹¹⁵ sont en nombre infini, mais sont extérieurs les un aux autres, au lieu d'empiéter les un sur les autres comme le font, conformément à la formule précédente, les éléments du continu physique.* Now let us give the name of **Poincaré continuity** to this paradoxical property of the physical continuum. I remind the reader here of Aristotle's utterly correct observation: *For whoever divides the continuum into two halves thereby confers a double function on the point of division, for he makes it both a beginning and an end.* Our claim with respect to the difference between \mathbb{R} and \mathbb{P} can be summarised as:

the set \mathbb{R} is Poincaré continuous,

and therefore represents the *physical* instead of the mathematical continuum, contrary to the standard view. It is the set $\{0, 1\}^{\mathbb{N}}$ which, by appropriately discriminating between d and d' , resolves the unresolved nebula and thus represents the *mathematical* continuum, precisely because it contains an infinity of infinitely tiny holes. We showed however that this is indeed the case, and will now try to find a way to render the mathematical continuum intuitively continuous again.

We look for a notion of infinitesimals that does not treat them as the mere logical consequence of the introduction of a special operator, as is the case with Robinson (although we retain his notion of 'hyperreality'), but as mathematical entities in their own right. Infinitesimals of this kind have been introduced at the very outset of the development of modern natural science and the calculus by **Bernard Nieuwentijt**, a

¹¹³we will take a closer look at the fundamental mathematical intuition (...) as the substrate to all perceptions of change, stripped off all its qualities, a unity of continuous and discrete, a possibility of the thinking-together of several individualities linked by a "between" that will never be exhausted by adding new individualities in between. L.E.J. Brouwer, *o.c.*, p. 43. [My translation.]

¹¹⁴SVAL, p. 61.

¹¹⁵i.e., rational or irrational numbers!

seventeenth century Dutch mathematician and theologian.¹¹⁶ He defends them in a controversy with Leibniz over the years 1694-1696 about presumed inconsistencies in the latter's variant of the calculus. Nieuwentijt's main criticism obviously concerns the use of higher order differentials.¹¹⁷ It thus comes close to Berkeley's attack on the Newtonians in his *Analyst*¹¹⁸, though on radically different grounds, for he does not reject — as with Berkeley — Newton's use of the potential infinite; he on the contrary accepts (on logical and theological grounds) the actual infinite as well! Nieuwentijt's approach has — in certain respects — a very 'modern' smell about it. He was unsatisfied by the *ad hoc* nature of many solutions to specific problems presented by Newton and Leibniz. He pursued to develop a logically consistent, general foundation for the calculus, based on a study of the properties of the infinite. This problem is related to the ontological status of infinitesimal quantities: do they really exist or are they merely limiting cases, i.e., finite approximations? It will be clear that in the latter case only potential infinity is assumed, in accordance with Archimedes's geometrical method of exhaustion, to which both Newton and Leibniz painstakingly show their methods to correspond.¹¹⁹ Nieuwentijt's criticism is that such an approximative description cannot supplant an exact definition, hence cannot serve as a basis for valid logical deductions in calculus. He formulates a fundamental axiom on the basis of which infinitesimals could be exactly defined: *everything which, when multiplied by an infinitely great number, does not render a given [finite] number, whatever small, cannot be counted as a being but should in the realm of geometry be considered as a pure nothing*. On this basis he formulates the arithmetical rules for the infinite. He moreover proves that from this axiom it follows that the square of an infinitesimal — taken as the number $a = A/m$, with $m = \infty$ and A finite — must be zero. Indeed, multiplying a^2 by m is by definition $(\frac{A}{m})^2 m$, and this equals $\frac{A^2}{m}$, again an infinitesimal, and so by the grounding axiom equal to 0.¹²⁰ For whatever you do to get it over the border of mathematical visibility will fail, and so it must be no-thing. Nieuwentijt thence defines infinitesimals as follows: *Si pars qualibet data minor b/m ducatur in se ipsam, vel aliam qualibet data minorem c/m , erit productum bb/mm seu bc/mm aequale nihilo seu non quantum. [When a certain infinitesimal part b/m is applied onto itself, or on another infinitesimal part c/m , the product bb/mm or bc/mm will be equal to zero, or have no quantity.]*¹²¹ Although themselves different from zero, the infinitesimals are so small that their square vanishes. Intuitively this is not so strange as it may seem at first

¹¹⁶I encountered this name for the first time in an article by J. L. Bell, "Infinitesimals and the Continuum", *Mathematical Intelligencer*, 17, 2, 1995, fn 2. A more elaborate treatment in J.L. Bell, *The Continuous and the Infinitesimal in Mathematics and Philosophy*, Polimetria, Milano, 2005.

¹¹⁷R.H. Vermij, *Secularisering en natuurwetenschap in de zeventiende en achttiende eeuw: Bernard Nieuwentijt*, Rodopi, Amsterdam, 1991, p. 24 sq.; P. Mancosu, *Philosophy of mathematics and mathematical practice in the seventeenth century*, Oxford University Press, N.Y., 1996.

¹¹⁸N. Guicciardini, *o.c.*, pp. 199-200.

¹¹⁹N. Guicciardini, *o.c.*, p. 164 sq.

¹²⁰R.H. Vermij, *o.c.*, p. 19. A more detailed exposition of Nieuwentijt's mathematical methods in H. Weisenborn, *Die Prinzipien der höheren Analysis in ihrer Entwicklung von Leibniz bis auf Lagrange, als ein historisch-kritischer Beitrag zur Geschichte der Mathematik*, H.W. Schmidt, Halle, 1856.

¹²¹Bernhardi Nieuwentijt, *Analysis infinitorum seu curvilinearum proprietates ex polygonorum natura deductae*, Amstelaedami, Wolters, 1695, Praefatio, lemma 10. That he really has infinitesimals in mind becomes clear from the definitions on p. 1 of his book: "data major" = "infinitam" and "data minor" = "infinitesimam". Thus the bigger m becomes, the smaller b/m will be.

glance: consider the square of the real number 0,0001! Thus the infinitesimal character becomes a definable property in its own right. This is where the concept “nilpotency” comes in.

Now let us look in more detail at the set of Nieuwentijt infinitesimals \mathbb{IB} (‘B’ from Bernard) of nilpotent numbers.¹²² We consider \mathbb{IB} as a plane $\mathbb{R} \times \mathbb{R}$ in which the number (a, b) consists of a real component a and a hyperreal component b . The latter one is the coefficient of the infinitesimal h . Addition of two such hyperreals is component-wise: $(a+bh) + (c+dh) = (a+b) + (c+d)h$. For multiplication we have: $(a+bh) \cdot (c+dh) = ac + adh + bhc + bdh^2 = ac + (ad + bc)h$, or $(a, b)(c, d) = (ac, ad + bc)$. In other words, we multiply $a + bh$ en $c + dh$ as polynomials in the variable h , with $h^2 = 0$. This of course holds true for all multiples of h^2 . As we noted already, our number $(0, 1)$ is so small that, although itself different from 0, its square equals 0.¹²³

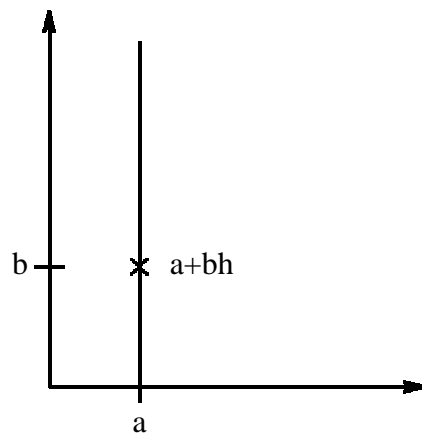

Figure 1: The nilpotent number $a + bh$

Thanks to these properties, \mathbb{IB} is a commutative ring with unity, which forms an algebra over the field \mathbb{R} . This \mathbb{R} -algebra is the ringtheoretic quotient $\mathbb{R}[h]/(h^2)$ of $\mathbb{R}[h]$. $\mathbb{R}[h]$ is the polynomial ring in the variable h , where (h^2) , the ideal generated by h^2 , is divided out, so that the ring $\mathbb{R}[h]/(h^2)$ really is the ring of nilpotent numbers. The representation in $\mathbb{R} \times \mathbb{R}$ allows for a geometrical interpretation of $h_r = a + bh$ for $r \in \mathbb{R}$, as can be seen in figure 1. This figure gives further information on the ordertopology on \mathbb{IB} . The hyperreal part b clearly assigns a unique position to the bh on the straight line parallel to the

ordinal through a . These parallels in their turn occupy a unique position on the abscissa, assigned by a . The relation satisfies the criterion for total order: $\forall h_r \in \mathbb{IB} : (a, b) \leq (c, d) \text{ or } (c, d) \leq (a, b)$. The total order on \mathbb{IB} will be determined by means of the *first difference*, so that it is not merely total, but lexicographical as well. This is in agreement with what we obtained when dividing Zenonian-wise. It furthermore will be possible to embed \mathbb{R} in \mathbb{IB} in by means of the injection $\iota : \mathbb{R} \hookrightarrow \mathbb{R} \times \mathbb{R} : r \mapsto h_r$ with $h_r = (r, 0)$. This embedding preserves the order. Let us now return to our initial question: given that the lexicographical order that equally governs $\{0, 1\}^{\mathbb{N}}$ prevents the double points $d < d'$ from coinciding, how to fill out the gaps in \mathbb{P} that arise as a consequence of their presence? Our answer will obviously be that the Nieuwentijt infinitesimals lie exactly between them. But this answer implies that it should be possible to somehow construct a viable completion of $\mathbb{P} \times \mathbb{P}$ in \mathbb{IB} , and show that the result remains aequivalent to $\mathfrak{3}$. We are facing immediately a problem here, because, while the number of points a on the abscissa is uncountable, we only have a countable number of places (d, d') available to insert what I propose to call a *prime needle* for

¹²²The initial suggestion that dual or nilpotent infinitesimals are the best match for our purposes stems from Didier Deses (VUB). Concerning the algebra, W. Lowen (Paris VII) made many valuable suggestions.

¹²³Division can be defined by means of the adjoint. It is the inverse operation of multiplication, with the caveat that, in order to remain consistent, $b \neq 0$.

reasons that do not concern us here. But let us neglect this problem at first by arbitrarily supposing that not every a possesses this power to instantiate a hyperreal monad¹²⁴, and look what happens when we insert a prime needle D_i between the members of each couple (d_i, d'_i) , thus executing graphically the construction exactly as we need it. This construction does indeed generate the Euclidean plane, thanks to an at first glance improbable THEOREM S proven by W. Sierpiński that states:

the plane is a sum of a countably infinite number of curves.

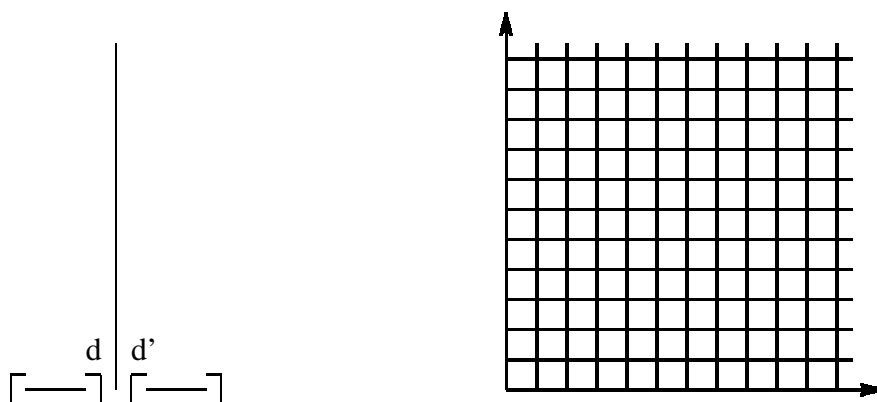

Figure 2: The nilpotent numbers complete $\mathbb{P} \times \mathbb{P}$ into \mathbb{B}

Since we demonstrated before the equivalence of \mathfrak{Z} with CH, for our needs equivalence of S with the latter would do. But this is exactly Sierpiński's point: to prove that theorem S quoted above is equivalent to CH.¹²⁵ Sierpiński's starts by proving the weaker THEOREM S*: *The set of all points of the plane is itself a sum of two sets of which one is at most countable on every straight line parallel to the ordinate, the other one at most countable on every parallel to the abscissa.* Our initial hypothesis that only on the rational number of loci (d_i, d'_i) the real part a will possess the power to instantiate a hyperreal monad bh along the prime needle D_i , Our embedding now of course will be $\epsilon : \mathbb{P} \hookrightarrow \mathbb{P} \times \mathbb{P} : r \mapsto h_r$ with $h_r = (r, 0)$, which preserves the order. But it is far from clear yet what this exactly means in terms of the *Gedanken*-experiment which is at the heart of Zeno's procedure. Therefore we will have to elucidate further its physical meaning, by taking a closer look at its geometrical implications. At first we need to discuss the paradoxes of motion, and see how they fit into the play.

ZENONIAN PLURALITY IN THE MOTION PARADOXES.— The classical interpretation again presents us Zeno's argumentative strategy as a dilemma, at bottom concern-

¹²⁴This terminology stems from Robinson's seminal work, and, although a bit unfashionable these days, I insist on using it as a tribute to him. Cfr. A. Robinson, *o.c.*, p. 57.

¹²⁵W. Sierpiński, *Hypothèse du Continu*, Z Subwencji Funduszu Kultury Narodowej, Warszawa/Lwów, 1934, pp. 9-12. [Reprinted by Chelsea Publishing Company 1956]

ing the continuity of space, and, as a corollary, the continuity of time.¹²⁶ An alternative though related interpretation centers upon the denseness postulate for both space and time.¹²⁷ We will shortly consider the applicability of our representation \mathfrak{J} to Zeno's motion paradoxes, confining ourselves to an outline of the possibility, and leaving a more elaborate discussion for future work. It will be indicated furthermore how this links to the question at the end of the preceding paragraph. This comes down to devising an interpretation that subsumes PM under Zeno's simultaneous and through and through divisional procedure (as we modelled it), which indeed matches the nature of our claim with respect to them.

Zeno's famous Paradoxes of Motion are transmitted to us by Aristotle [*Phys.*, Z 9, 239b], with the comment that they are notoriously difficult to refute. And indeed attempts to either refute, either resolve them have been at the order of the day up to the present: *no one has ever touched Zeno without refuting him, and every century thinks it worthwhile to refute him.*¹²⁸ Let it suffice to say that, however relevant in themselves for future developments in, say, mathematics, *all* presumed refutations hinge on non-Zenonian premisses, so that, whatever it was that was refuted, it was certainly not Zeno. Again, it is not Zeno who presupposes space or time; nor does he assume hypothetical positions on their being discrete or continuous. The only thing needed to find PM back is Zeno's simultaneous and through and through division. Our analysis of PP thus should be applicable to PM as well. The reason invariably is that "to move" implies "to count the uncountable", or, which boils down to the same, to measure implies to apply commensurable units to incommensurable quantities.

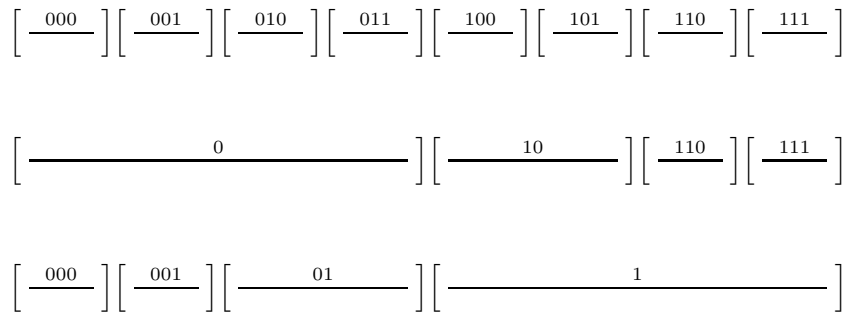

Figure 3: The paradoxes of motion

Bell puts it like this: *Continuity and discreteness are united in the process of measurement in which the continuous is expressed in terms of separate units, that is numbers.*¹²⁹ This is the fundamental point one loses out of sight when one throws actual infinity out. One assumption implicitly underlying the execution of Zeno's procedure

¹²⁶W. C., Salmon (ed.), *Zeno's Paradoxes*, Hackett, Indianapolis, 2001 [1970]. Owen succeeds in bringing all motion paradoxes on a par by referring explicitly to the plurality problem. G.E.L. Owen, *op. cit.*

¹²⁷A. Grünbaum, *o.c.*, p. 37 sq.

¹²⁸A.N. Whitehead, *Essays in Science and Philosophy*, Philosophical Library, New York, 1947.

¹²⁹J.L. Bell, *Oppositions and Paradoxes in Mathematics and Philosophy*, [forthcoming in *Axiomathes*].

— we touched it already before, but here it becomes particularly relevant — is the one-dimensional, horizontal orientation of the divisional process. This assumption allows Zeno to go over without any further ado from plurality at rest to plurality in motion. When one reads the PM-fragments from this angle, the astonishing coherence of the arguments immediately hits the eye. The problems treated by Zeno as embodied in the four arguments given by Aristotle are, by levels of ascending perplexity¹³⁰:

- i) motion cannot take a start;
- ii) motion, once started, cannot be completed;
- iii) moving bodies passing each other are subject to the same paradoxes;
- iv) motion is self-contradictory.

Zeno's point precisely is to show that, *however small the distance*, the number of parts to cross will remain the same, i.e. $2^{\mathbb{N}}$, while the number of partitions (steps) will never exceed \mathbb{N} , and in reality be only finite. Time, being related to distance, is irrelevant in exactly the same way as the length of our measuring rod was irrelevant. It would moreover be quite strange that Zeno, in order to defend Parmenides's stance with respect to the deictical unreality of time, would introduce it to make his point. 'To count the uncountable' is thus the motion-face of the plurality-coin, which, as the reader will remember, can be summed up in the slogan 'to consist out of parts with and without magnitude'. One sees that Aristotle's choice, far from being arbitrary, was to pick out exactly those renderings (from an undoubtedly larger corpus) that develop the paradox step by step, in order to lay bare its many faces, and to bring out why it is so difficult to resolve. But although the Stagirite realised the nature of the underlying problem, he apparently did not believe that Zeno himself did. This — together with the fact that we know Aristotle's analysis only from lecture notes taken by his students — explains methinks their somewhat muddled-up phrasing and sometimes cumbersome argumentative development.

The Runner (The Dichotomy) [DK 29A (25)]

[Arist., *Phys.*, Z 9, 239b(11)] *The first [argument] is the one which declares movement to be impossible because, however near the mobile is to any given point, it will always have to cover the half, and then the half of that, end so without end before it gets to the goal. (...) Hence Zeno's argument makes a false assumption in asserting that it is impossible to pass over an infinity or to touch one by one infinitely many in a finite time. For there are two senses in which length and time and the continuum in general are said to be unbounded: with respect to partition and with respect to the extended parts. Therefore it cannot be assumed possible to touch an infinite quantity of things [i.e., parts] in a finite time, though this can be assumed for partition, because time itself is infinite in the same way.*

¹³⁰Traditionally the numbering of the two last ones is switched, although it is clear that the Arrow concludes Zeno's stupendous argumentative sequence. We concord partially with Owen's scheme.

▷ MOTION CANNOT TAKE A START.— Aristotle reads Zeno's argument as a *reductio*: whether you have to start or arrive, seen from whatever distance you are at, the goal to start from or to arrive at will be unattainable. Interestingly enough, in the 'to start' variant this version of the paradox rises problems even to contemporary limit-based approaches. Apparently the transition of nothing into something — from standstill to motion — is more problematic than its opposite, from something into nothing, which in itself should arouse suspicion.¹³¹ The reason obviously is that the formalisation of the solution of the received view — finite limits to infinite Cauchy sequences do exist — is not applicable in the 'to start' case. This becomes understandable when we realise that the runner has to traverse $2^{\mathbb{N}}$ distances to make even his first step! Aristotle correctly interprets Zeno's intentions, insofar as he admits that two kinds of infinity are involved: one with respect to the — countable — number of partitions, one with respect to the — uncountable — number of parts. It is well worth the effort to lay bare Aristotle's approach in some detail. First he imputes Zeno with a false assumption, viz., "that it is impossible to pass over an infinity or to touch one by one infinitely many in a finite time", while we know that 1) Zeno nowhere mentions time, and 2) this is not an assumption, but a distorted version of the conclusion reached to the argument on plurality gone before. Thus Aristotle's strategy involves two steps: to introduce 'time' as an underlying hypothesis and to discard the plurality arguments, although he certainly was aware of them. Even more, this same pattern turns up against all arguments on motion. Why? The first and major reason obviously is that Aristotle does not want to expose, but to kill off the paradoxes. This stance is exemplified in the basic axiom shoring up both his metaphysics and his logic, the *Principium Contradictionis* or contradiction principle (PC): *it is not admissible* that something is and is not in any sense at the same place at the same time [*Met.*, γ 3, 1005b(19-26); B 2, 996b(30)].¹³² For Aristotle paradoxes are a *problema* most urgently in need for a solution. Secondly, that solution has to take a specific form. This follows from his criticism of the solution proposed by Plato, who aimed at dismantling Zeno's plurality-argument (in the form given to it according to him by Zeno's master, Parmenides).¹³³ Aristotle's reasoning apparently is that if one were to avoid the flaws in Plato's system, one were to avoid the paradoxes of plurality as well, and turn instead to the paradoxes of motion. This, however, is impossible without mutilating them. To attain his goal, the Stagirite proceeds in a most subtle way. Indeed it is impossible to "touch" stepwise the infinity of parts because the infinities involved are different. But counting is a method of time-measurement — think of the metre in poetry or music — therefore the divisibility of time will be 'parallel' to that of partition. So instead of looking at partitions and parts, let us look at partitions *over time*. Aristotle most cleverly shifts our attention from (discrete) counting and (continuous) extension to merely counting (steps) and counting (time). No wonder that the problem

¹³¹The embarrassment is plain in e.g. Clark's commentary on the "regressive" formulation of the paradox, see M. Clark, *o.c.*, p. 160.

¹³²LOEB₂. For an in depth discussion, see J. Lukasiewicz, *Über den Satz des Widerspruchs bei Aristoteles*, trans. J.M. Bochenski, Georg Olms Verlag, Hildesheim etc., 1993.

¹³³K. Verelst and B. Coecke, "Early Greek Thought and Perspectives for the Interpretation of Quantum Mechanics: Preliminaries for an Ontological Approach", in: *Metadebates on Science. The Blue Book of Einstein meets Magritte*, G.C. Cornelis, S. Smets and J.-P. Van Bendegem, Kluwer Academic Press, Dordrecht, 1999, pp. 163-196.

disappears! This is why he says that Zeno's argument fails because time itself is infinite "in the same way". Moreover, however long we *count*, e.g., by "touching", the number of "touches" remains finite. You only *approach* infinity, you never reach it. Thus one never trespasses the PC by making the inevitable cardinal jump that is so proper to Zeno's procedure. Once you introduced time, you can postpone that fatal moment as long as you wish. This is Aristotle's famous *potential* infinity. Even if a stretch of time itself is finite, it consists of a potential infinity of very very small but nevertheless *finite* parts: the faster you count, the smaller the parts. The paradox disappears because the very large but finite number of parts of any extended body at whatever finitely remote moment coincides to this same potential infinity, which is exactly what countability means. You always use commensurable quantities, or in modern terms, you relate rationals to rationals. This corresponds to what we continue to do by using the notion of a mathematical limit. You can maintain you reached the endpoint (of the racecourse, say) because the gap that separates you from it becomes so small that you can neglect it. But this explains as well why no explicit *construction* of the irrational numbers as such — and not merely some arbitrary objects considered equivalent to them — is available. Gödel remarks with sore precision: *It is demonstrable that the formalism of classical mathematics does not satisfy the vicious circle principle in its first form, since the axioms imply the existence of real numbers definable in this formalism only by reference to all real numbers.*¹³⁴ Or more caustically: *The calculus presupposes the calculus.*¹³⁵ With Zeno's paradoxical construction one does not suffer from this kind of circularity.

The Achilles [DK 29A (26)]

[Arist., *Phys.*, Z 9, 239b(14)] *The second [argument] is the so-called Achilles. This is that the slowest runner will never be overtaken by the swiftest, since the pursuer must first reach the point from which the pursued started, and so the slower must always be ahead. This argument is essentially the same as that depending on dichotomy, but differs from it in that the added lengths are not divided into halves.*

▷ MOTION CANNOT COME TO ITS END.— Here the case is simple, for Aristotle comments: *This argument [the Achilles] is the same as the former which depends on dichotomia* [*Phys. Z*, 9, 239b (20-21)]. The case is slightly more complicated by the fact that both the moving body and the goal to attain are themselves in motion, but the complication is not substantial, as Aristotle points out himself: it merely implies that the distances to cross will not decrease symmetrically. He mentions *διχοτομῆν* [*Phys.*, Z 3, 239b(19)], symmetric two-division (in his treatment implicitly oriented and stepwise decreasing), but takes care to make clear that even if another number of division is used, this would not make any real difference, something we already know from Plato's *Philebus*. The received view presents us Zeno's argumentation as flawed by an elementary mathematical error, due to a lack of mathematical sophistication. In accordance with Aristotle's distorted rendering of Zeno's argument, it is presented as a potentially infinite sequence decreasing geometrically: $\sum \frac{1}{2^n}$, the sum of which can

¹³⁴K. Gödel, "Russell's Mathematical Logic", *BPPM*, p. 455.

¹³⁵L. Wittgenstein, *Philosophical Remarks*, Blackwell, Oxford, 1975, p. 130.

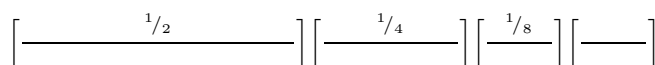

Figure 4: The Received view on the motion paradoxes

very well have a finite total, because the underlying sequence converges to its finite Cauchy-limit.¹³⁶ As we already mentioned Vlastos, given his direct acquaintance with the sources of ancient Greek thought at unease with this modern self-sufficiency, looks for other explanations,¹³⁷ and proposes alternative interpretations based on the notion of ‘supertask’, developed in the fifties by Thomson and Black.¹³⁸ A supertask requires the execution of a countable infinity of acts in a finite stretch of time. Thomson and Black argue that such actions are — under specific circumstances — carried out in reality, and that they can be used to explain Zeno’s motion paradoxes. But although we ever only make finitely many steps, even if we could make countably many, the stretches to cross would be uncountable in number. Thus a Zenonian supertask properly speaking would require an infinity of acts in no time!

The Stadium [DK 29A (28)]

[Arist., *Phys.*, Z 9, 239b(33)] (a) *The fourth is the one about the two rows of equal bodies which move past each other in a stadium with equal velocities in opposite directions, the one row originally stretching from the goal [to the middle-point], the other from the middle-point [to the starting point]. This, he thinks, involves the conclusion that half a given time is equal to its double. The fallacy lies in assuming that a body takes an equal time to pass with equal velocity a body that is in motion and a body of equal size at rest (...).*

▷ THE FIRST TWO ARGUMENTS COMBINED FOR EXTENDED BODIES.— This argument, traditionally known as the fourth argument logically is the third, because it simply combines the former two. What happens when two measuring rods — our model for Zeno’s extended bodies, and one used in this case by Aristotle as well — pass each other at constant velocity in opposite directions? So we now not only consider the relation rest/motion, but motion/motion as well. Of course there still is the fixed measuring rod with respect to which division through and through takes place (and which creates the impression of time and direction): the floor of the stadium. *And this for all generations at once.* The Received View here is that Zeno did not understand the (Galilean) relativity governing the motions of bodies in inertially moving frames of reference, as in the case of two cars crossing each other with equal speed on a highway: *The unanimous verdict on Zeno is that he was hopelessly confused about relative velocity in this paradox.*¹³⁹ But in Zeno’s description, every part at every moment faces its doubling

¹³⁶R. Courant and F. John, *o.c.*, vol. I, p. 70 sq.

¹³⁷VLAS, p. 234.

¹³⁸M. Black, ‘Achilles and the Tortoise’, *Analysis*, **XI**, 1950, pp. 91-101; J. Thomson, ‘Tasks and Super-Tasks’, *Analysis*, **XV**, 1954, pp. 1-13.

¹³⁹STF, <http://plato.stanford.edu/archives/sum2004/entries/paradox-zeno/>.

by division, whether it be in comparison to a stable measuring rod, or a rod passing by. The problem arises from the fact that, because of simultaneous through-and-through division, “to double” here involves a transition from ordinal to cardinal, from countable to uncountable, from potential to actual infinity. The infamous “doubling of the times” only takes into account the potential, stepwise part of the argument. For of course, every body, while being a continuum, “touches” (counts) the other one everywhere when it passes (measures). It remains just the same cardinal problem. Their speed proportional to each other does not change anything to this fact, analogous to what we saw with the Achilles: they are at every moment passing each other at infinitely many parts, which, by facing each other’s unlimited division, count each other’s uncountability.

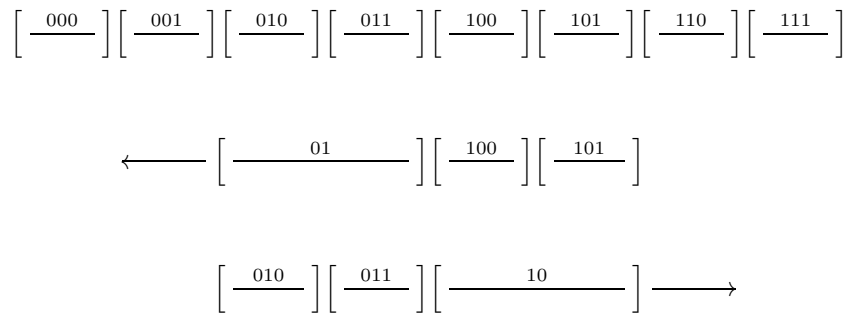

Figure 5: The Stadium

Moreover, the number of partitions – steps — involved here really is (countably) infinite. Aristotle’s dictum equally applies: *For there are two senses in which a distance or a period (or indeed any continuum) may be regarded as unbounded, viz., with respect to partition and with respect to the parts.* Let us stress once more that Zeno does not imply that motion does not exist, only that it is paradoxical. Graphical representations that do not take this fact into account do not account for Zeno’s third argument, as is the case with all drawings based on Alexander, as given in Kirk *et al.*¹⁴⁰

The Arrow [DK 29A (27)]

[Arist., *Phys.*, Z 9, 239b(30)] *The **Third** is that just given above, that the flying arrow is at rest. This conclusion follows from the assumption that time is composed of instants; for if this is not granted the conclusion cannot be inferred.*

▷ MOTION IS SELF-CONTRADICTORY.— The Arrow radicalises the reasoning by combining the first two arguments pointwise, so that the contradiction plainly arises. Indeed, even in this case the doubling of parts occurs, as again the Stagirite notes. He does nevertheless not credit Zeno with this insight. Probably because in this variant the

¹⁴⁰KRS, p. 274.

paradox does not leave any room for anything timelike to be smuggled in, Aristotle has to take recourse to praemiss of the parallelism of divisibility of space and time, which is why he introduces as an explicit assumption instants conceived as 'time-atoms'¹⁴¹, "for otherwise the conclusion will not follow" — after you have discarded actual infinity, that is. He then rejects these time-atoms, and proposes his potential divisibility as a more apt solution [*Phys.*, Z 9, 239a(20-24)]. But of course chronons, like atoms, are non-Zenonian. This is another nice example of Aristotle's general neutralising strategy with respect to Zeno's paradoxes: to introduce a seemingly self-evident hypothesis on Zeno's behalf, such that his own principle of contradiction can subsequently be applied successfully. When parts considered are of the *megala* type, one can still be impressed by seeing the motion that takes place. When looked at it from the point of view of the *mikra* the paradox becomes unescapable, for one cannot see motion over an unextended "distance" in the unextended now. These parts in effect cannot be further divided, which is why the atomistic point of view seems to fit in naturally. But one then forgets an essential thing: the arrow is a finite object consisting of *megala* and *mikra*, which nevertheless flies. The last two arguments show that, whether we consider the *megala* or the *mikra*, the paradox remains the same. This is where the reading of the last two arguments as a dilemma stems from. Indeed Zeno's argumentation becomes here somewhat of a mocking variant of the dilemma imposed on him by later times. Considered as an absurdity, it seldomly is discussed with the zeal devoted to the other paradoxes of motion. But once the true nature of Zeno's paradoxes is assimilated, this last argument reveals itself as the contrary of how it is generally perceived: a clear and incontestable exposure of the paradoxical nature of motion and change, and not an incomprehensible enigma. If you let motion, conceived of as covering all systematically smaller extended parts of a line by counting the uncountable in every single part, come to an end by mentally letting the extension of the parts decrease to nought, then division 'comes to an end' too, and the only thing that remains is the naked paradox. This explains why this paradox in the literature has been considered as the most enigmatic one, while it actually only sums up Zeno's conclusion in a concise way.

GEOMETRICAL IMPLICATIONS.¹⁴²— To conclude, I will give a short sketch of some geometrical consequences — to be worked out in more detail in a subsequent paper — which throw light on Zeno's paradoxes from a more physical perspective, and which allow to bring the Received View on the paradoxes of motion into the picture again. At first an observation that serves as a guideline. We will work in the spirit of the notorious *Erlanger Programm*, formulated by F. Klein in 1872.¹⁴³ Instead of focusing on geometric objects *per se*, one studies objects that stay invariant under the action of a group of transformations. Now the algebraic expression for Nieuwentijt infinitesimals is a first order polynome, the equation of an Euclidean straight line. Such a polynome $a + \eta b$ can also be regarded as a point (a, b) in a two-dimensional space. The usefulness

¹⁴¹Developed afterwards by Diodorus Cronus. See R. Sorabji, *Time, Creation and the Continuum. Theories in antiquity and the early middle ages*, Duckworth, London, 1983, p. 17 sq.

¹⁴²On this subject I was helped enormously in developing the ideas sketched here by some clarifying discussions with P. Cara (VUB) and F. Buekenhout (ULB).

¹⁴³F. Klein, "Vergleichende Betrachtungen über neuere geometrische Forschungen", *Mathematische Annalen*, 43, p. 63 sq., 1893.

of this representation is clear from the example of the complex numbers $g = a + ib$, with $i^2 = -1$ for $\eta = i$; their geometrical representation is the complex face of the Euclidean plane with its accompanying static, Euclidean geometry. Let us call $a + \eta b$ a two dimensional number¹⁴⁴ and ask whether for other values of η a geometrical representation exists.¹⁴⁵ Is there a likely candidate to fulfill such a role for our Nieuwentijt infinitesimals $g = a + hb$; $h^2 = 0$, with $\eta = h$? Although less well known, there indeed is: **Galilean geometry**.¹⁴⁶ The geometry in which the motions of bodies in classical mechanics take place is non-Euclidean! We see that the first order polynome describing each Nieuwentijt number is the equation of a uniform linear motion in Euclidean space. The transition from static to kinematic is not so innocent as it would seem, for it is by introducing *time* that one captures motion; in which case limit-like approximations become possible, and the traditional view on PM can be recovered. Euclidean geometry gives us merely the situation of a particle instantaneously. Now if we take the hyperreal part bh as representing the velocity-component of the Galilean transformation $x' = x + vt$ (with h as Galilean time t), we see that only on the *loci* of the *dubbels* the hyperreal monads have the power to generate a space-time worldline: the idea is that there some *action* is involved. We saw also that we nevertheless will get back the Euclidean plane. When the bh -coordinate on the time axis of a hyperreal monad will differ from zero, transition from Euclidean to Galilean geometry takes place, i.e., the thing sitting on these coordinates is set into motion. But this way of building Galilean geometry seems awkward, since it implies that points can transform into straight lines. However, a geometry does exist in which certain points can explode into "higher order" points under specific conditions, i.e., lines, or even curves. This is **Cremona geometry**¹⁴⁷, the geometry of birational transformations of the plane. Let us summarise its basic tenets and show by analogy of argumentation that it is reasonable to expect it to be the appropriate geometrical description of the transformations implicit in Zeno's approach.

Let a *birational transformation* φ be a birational function of the coordinates of x , whereby $\varphi : V \rightarrow V' : x \rightarrow x'$. The function φ is not defined everywhere for at certain points the denominator will become zero and singularities will arise. Thence points do not always have an image under transformation, so they cannot be invariant. Those who are not are called singular points; we can think of them as 'black' or 'invisible'. We are here in the realm of algebraic geometry. In order to get rid of our divisions by zero, we work preferably in the completed, projective plane. In that case the transformation can be written as homogeneous polynomials of the coordinates of x .¹⁴⁸ Singular points are characterised by higher order 'points', or approximations in their infinitesimal neighbourhoods. Such points can then be taken as transformed into curves by division through zero. They are represented by polynomes of order n , in the same

¹⁴⁴A suggestion by K. Lefever.

¹⁴⁵Emch

¹⁴⁶J.M. Yaglom, *A Simple Non-Euclidean Geometry and its Physical Basis*, Springer-Verlag, N. Y., 1979.

¹⁴⁷F. Enriques, *Lezioni sulla teoria geometrica delle equazioni e delle funzioni algebriche*, N. Zanichelli Editore, Bologna, 1915.

¹⁴⁸In which case they can be simply rational. J. Tits, *The Cremona Plane*, Lecture notes by H. Van Maldeghem and F. Buekenhout, VUB-ULB, 1999.

way analysis approximates functions by means of Taylor expansions.¹⁴⁹ In our case all approximations will be first order polynomials representing Nieuwentijt infinitesimals at every *locus* where a double $[d_i, d'_i]$ exists, thus transforming singular points into straight lines. Physically speaking this comes down to derivation, another way to ascertain that the traditional, time-dependent perspective on the paradoxes of motion is included in our approach. Owing to Sierpiński's theorem mentioned above, our completed plane would be a special instance of the projective plane over the division ring of nilpotent numbers \mathbb{B} ; we will label it $P_2(\mathbb{B})$ (this remains to be rigorously shown).¹⁵⁰ Cremona Geometry was axiomatised by J. Tits in the context of incidence geometry, in which geometrical properties are expressed as symmetrical relations of intersection and inclusion.¹⁵¹ In every "black point" Tits defines a tree of approximations which resembles (\mathcal{Z}, \leq) . Far from being empty, the singular point appears to be a highly structured entity! These trees are the foundation on which the Cremona plane can be constructed as a *building*, incidence geometrically speaking. They constitute thin subgeometries, and are called *apartments*.¹⁵² What is the precise nature of these apartments? Given the strong analogy between the structures in Tits's axiomatisation and the semi-lattices arising from our Zeno-approach, F. Buekenhout proposed the following theorem:

The 'thin' Zeno-plane (the small Zeno-semilattice \mathcal{Z}) gives the [aequivalence class of] apartments in the building constituted by the Cremona plane.

It of course remains to be demonstrated that this theorem does indeed establish the desired link. When this works it means that the "Zeno-line" is identical to the Cremona line. In that case one could use a kind of "Zeno microscope" to elucidate the internal structure of the Nieuwentijt infinitesimal, which, far from being structureless, repeats fractal-wise the Zenonian tree in its own fine structure. This could be the first step towards an understanding of why the 'cardinal jump' so crucial to Zeno's paradoxical procedure comes about. The question then remains to be answered what the birational transformations are under which Nieuwentijt infinitesimals are invariant. Settling this question would bring us back to Galilean geometry, i.e., to classical mechanics, which really is where Zeno's paradoxes of motion belong.

ACKNOWLEDGMENTS.— I want to express my gratitude to the people of the Department of Mathematics at the Vrije Universiteit Brussel, for not only tolerating but even actively encouraging a (lonely) philosopher working among them and foraying their noble discipline for what at first instance could only have appeared as wild speculations. I especially thank Tim Vanderlinden and Philippe Cara, who not only critically followed my attempts at precise mathematical formulation, but even contributed substantially to the development of my ideas. Furthermore I thank Rudger Kieboom, Tomas Everaert and Mark Sioen (dept. Math., VUB), Wendy Lowen (Institut. de Math. de Jussieu, Paris VII), as well as Roland Hinnion and Francis Buekenhout (dept. Math.,

¹⁴⁹F. Enriques, *o.c.*, vol. II, p. 327 sq.

¹⁵⁰F. Buekenhout and P. Cameron, "Projective and Affine Geometry over Division Rings", in F. Buekenhout (ed.), *Handbook of Incidence Geometry*, Elsevier, Amsterdam, 1995, pp. 27-62.

¹⁵¹J. Tits: *Théorie des groupes*, Collège de France, Résumé des cours et travaux, 1998-1999.

¹⁵²In Tits's original vocabulary these objects were called "squelettes" and "ossuaires"!

Université Libre de Bruxelles). Bob Coecke (Comlab, Oxford University) is a long-standing support, and introduced me to the secrets of Domain Theory. To Rudolf De smet and Wilfried Van Rengen (Classical Studies, VUB) I am indebted for competent advise with respect to philological issues. A final word of thanks to Koen Lefever, whose intellectual influence is less specific, but acts as a light-house to my ongoing philosophical quest.

A LIST OF BIBLIOGRAPHICAL SIGLA.— Abbreviations used throughout the text are assembled here. For further bibliographical information the reader is referred to the footnotes.

DK : H. Diels and W. Kranz, *Fragmente der Vorsokratiker*, erster Band, Weidmann, Dublin, Zürich, 1951 [1996].

BPPM : P. Benacerraf & H. Putnam, *Philosophy of Mathematics*, Cambridge University Press, Cambridge, 1964 [1991].

FTG : J. Van Heijenoort, *From Frege to Gödel*, Harvard University Press, Cambridge Mass., 1967.

GA : G. Cantor, *Gesammelte Abhandlungen*, E. Zermelo Ed., Georg Olms Verlag, Hildesheim, 1932 [1962].

LEE : H.D.P. Lee, *Zeno of Elea. A Text, with Translation and Notes*, Cambridge University Press, Cambridge, 1936.

KRS : G.S. Kirk, J.E. Raven and M. Schofield, *The Presocratic Philosophers. A critical History with a Selection of Texts*, Cambridge Univ. Press, Cambridge, 1957 [1983].

LOEB₁ : Aristotle, *Metaphysics*, Books I-IX, transl. H. Tredennick, Harvard University Press, Harvard, 1933 [1996].

LOEB₂ : Aristotle, *Physics*, Books I-VIII, transl. P.H. Wicksteed and F.M. Cornford, Harvard University Press, Cambridge, Mass., 1933 [1995].

LOEB₃ : Plato, Vol. I, trans. H.N. Fowler, Harvard University Press, Cambridge, Mass., 1914 [1999].

LOEB₄ : Plato, Vol. VIII, trans. H.N. Fowler and W.R.M. Lamb, Harvard University Press, Cambridge, Mass., 1925 [1999].

SHYP : H. Poincaré, *La science et l'hypothèse*, Flammarion, Paris, 1902 [1968].

STF : E.N. Zalta (ed.), The Stanford Encyclopedia of Philosophy (on the Internet).

SVAL, H. Poincaré, *La valeur de la science*, Flammarion, Paris, 1970 [1905].

VLAS : G. Vlastos, *Studies in Greek Philosophy. Vol. I: The Presocratics*, Princeton University Press, Princeton, 1993.