

## THE KERVAIRE–LAUDENBACH CONJECTURE AND PRESENTATIONS OF SIMPLE GROUPS\*

Anton A. Klyachko

Faculty of Mechanics and Mathematics, Moscow State University  
 Moscow 119992, Leninskie gory, MSU  
 klyachko@daniil.math.msu.su

The statement “no nonabelian simple group can be obtained from a nonsimple group by adding one generator and one relator”

1) is equivalent to the Kervaire–Laudenbach conjecture;

2) becomes true under the additional assumption that the initial nonsimple group is either finite or torsion-free.

*Key words:* Kervaire–Laudenbach conjecture, relative presentations, simple groups, car motion, cocar comotion.

*AMS MSC:* 20E32, 20F05, 20F06.

**1. Conventions**

For a group  $G = \langle X \mid R \rangle$ , the symbol  $\tilde{G}$  denotes the group  $\langle G, t \mid w = 1 \rangle \stackrel{\text{def}}{=} \langle X \cup \{t\} \mid R \cup \{w\} \rangle$  obtained from  $G$  by adding one generator and one (arbitrary) relator.

In this paper, the term “simple group” means “nonabelian simple group”.

**2. Introduction**

Recall an old well-known unproven group-theoretic conjecture with topological origin.

**Kervaire–Laudenbach conjecture (KL)** (see, e.g., [LS77], [MKS66]). *If a group  $G$  is nontrivial, then the group  $\tilde{G}$  is also nontrivial.*

Let us state a similar conjecture.

**“Simple” Kervaire–Laudenbach conjecture (KLs).** *If a group  $G$  is nonsimple, then the group  $\tilde{G}$  is also nonsimple.*

These problems are more than similar.

**Proposition 1.** *The conjecture **KL** is equivalent to the conjecture **KLs**.*

The best-known result partially confirming the conjecture **KL** is the following remarkable theorem.

**Theorem** (Gerstenhaber and Rothaus [GR62]). *If a group  $G$  is finite and nontrivial, then the group  $\tilde{G}$  is also nontrivial.\*\**

From this result, it is easy to derive the analogous “simple” theorem.

**Theorem 1.** *If a group  $G$  is finite and nonsimple, then the group  $\tilde{G}$  is also nonsimple.*

Consider another result partially confirming the conjecture **KL**.

**Theorem** [K93]. *If a group  $G$  is torsion-free and nontrivial, then the group  $\tilde{G}$  is also nontrivial.*

The analogous “simple” theorem is as follows.

**Theorem 2.** *If a group  $G$  is torsion-free and nonsimple, then the group  $\tilde{G}$  is also nonsimple.*

The proof of Theorem 1 and Proposition 1 is very short. The main contents of this paper are a proof of Theorem 2. Actually, we establish a stronger fact.

**Main theorem.** *If a group  $G$  is torsion-free, then the group  $\tilde{G}$  is simple if and only if  $G$  is simple and the word  $w$  is conjugate in the free product  $G * \langle t \rangle_\infty$  to a word of the form  $t^{\pm 1}g$ , where  $g \in G$ .*

We do not know whether or not the similar strengthening of Theorem 1 is true.

Note that the main theorem and the well-known fact that any torsion-free group embeds into a simple torsion-free group immediately implies the following result of Cohen and Rourke.

**Theorem** [CR01]. *If a group  $G$  is torsion-free, then the natural mapping  $G \rightarrow \tilde{G}$  is surjective if and only if  $w$  is conjugate in the free product  $G * \langle t \rangle_\infty$  to a word of the form  $t^{\pm 1}g$ , where  $g \in G$ .*

Our proof of the main theorem almost immediately divides, depending on the word  $w$ , into two cases — easy and difficult. It is amusing that the difficult case corresponds precisely to the words of complexity 1 (in the sense of Forester and Rourke [FoR03]); it is much easier to deal with words of higher complexity.

Among other things, this paper contains a complete and self-contained exposition of the method of comotions, which we apply to prove the main theorem in the difficult case, while in the easy case our geometric argument is reduced to a simple application of the car-motion lemma from [K93].

\* This work was supported by the Russian Foundation for Basic Research, project no. 02-01-00170.

\*\* Actually, the Gerstenhaber–Rothaus theorem is more general; we formulate only the most important special case (see [LS77]).

### 3. Proof of Proposition 1 and Theorem 1

Let a cyclically reduced form of the word  $w$  be

$$w \equiv g_1 t^{\varepsilon_1} \dots g_n t^{\varepsilon_n}, \quad \text{where } \varepsilon_i \in \{\pm 1\}, g_i \in G.$$

(These denotations are assumed to be fixed throughout the paper.)

The following reformulation of the Kervaire–Laudenbach conjecture is well-known.

**Proposition 2** (folklore). *The conjecture **KL** is equivalent to the following conjecture **KL'**.*

**Conjecture **KL'****. *If  $\sum \varepsilon_i = \pm 1$ , then the natural mapping  $G \rightarrow \tilde{G}$  is injective.*

**Proof.** Let us suppose that **KL'** is true and prove **KL**. If  $G \neq \{1\}$  and  $\sum \varepsilon_i = \pm 1$ , then  $\tilde{G}$  is nontrivial, because it contains a nontrivial subgroup isomorphic to  $G$ . If  $\sum \varepsilon_i \neq \pm 1$ , then  $\tilde{G}$  is nontrivial, because it admits an epimorphism onto the nontrivial group  $\mathbb{Z}/(\sum \varepsilon_i)\mathbb{Z}$ .

Now, let us suppose that **KL'** is false and disprove **KL**. Let  $\sum \varepsilon_i = \pm 1$ , and let  $N \neq \{1\}$  be the kernel of the natural mapping  $G \rightarrow \tilde{G}$ . It is well known that any group  $G$  embeds into a simple group  $H$  (see, e.g., [LS77]). The group  $\tilde{H} \stackrel{\text{def}}{=} \langle H, t \mid w = 1 \rangle$  is obviously trivial:

$$\tilde{H} \simeq \tilde{H} / \langle\langle N \rangle\rangle \simeq \tilde{H} / \langle\langle H \rangle\rangle \simeq \mathbb{Z} / (\sum \varepsilon_i)\mathbb{Z} \simeq \{1\}.$$

Here (and throughout this paper),  $\langle\langle X \rangle\rangle$  denotes the normal subgroup generated by a set  $X$ . Proposition 2 is proven.

**Proof of Proposition 1.** Suppose that **KL** is false, i.e., for some nontrivial group  $G$ , the group  $\tilde{G}$  is trivial. Let  $S$  be a simple group. The group  $G \times S$  is nonsimple, but  $\langle G \times S, t \mid w = 1 \rangle \simeq S$  is simple. Thus, **KLs** is also false.

Now, suppose that **KLs** is false, i.e., for some nonsimple group  $G$ , the group  $\tilde{G}$  is simple. First of all, note that  $G$  is nonabelian and  $\sum \varepsilon_i = \pm 1$ , because otherwise  $\tilde{G}$  would not coincide with its commutator subgroup (or would be trivial) and, therefore, would not be simple. If the natural mapping  $G \rightarrow \tilde{G}$  is not injective, then **KL** is false by Proposition 2. Suppose that the natural mapping  $G \rightarrow \tilde{G}$  is injective. Let  $N$  be a proper nontrivial normal subgroup of  $G$ . Then the quotient group  $\tilde{G} / \langle\langle N \rangle\rangle$ , on the one hand, is trivial (because  $\tilde{G}$  is simple, and  $N \neq \{1\}$  in  $\tilde{G}$  by virtue of the injectivity of the mapping  $G \rightarrow \tilde{G}$ ), and, on the other hand, is isomorphic to the group  $\langle G/N, t \mid w' = 1 \rangle$ , where  $w'$  is obtained from  $w$  by reduction modulo  $N$ . Thus, **KL** is also false. This completes the proof of Proposition 1.

**Proof of Theorem 1.** Theorem 1 can be derived from the Gerstenhaber–Rothaus theorem exactly as **KLs** is derived from **KL**; we need only to mention that a quotient group of a finite group is finite and that any finite group embeds into a simple finite group (e.g., in the alternating one).

Note that it is not so easy to prove Theorem 2, because a quotient group of a torsion-free group may have torsion. The remaining part of this paper is the proof of Theorem 2 (to be more precise, of the main theorem).

### 4. Algebraic lemmata

**Notation** which we use is mainly standard. Note only that if  $k \in \mathbb{Z}$ ,  $x$  and  $y$  are elements of a group, and  $\varphi$  is a homomorphism from this group to another, then  $x^y$ ,  $x^{ky}$ ,  $x^{-y}$ ,  $x^\varphi$ ,  $x^{k\varphi}$ , and  $x^{-\varphi}$  denote  $y^{-1}xy$ ,  $y^{-1}x^ky$ ,  $y^{-1}x^{-1}y$ ,  $\varphi(x)$ ,  $\varphi(x^k)$ , and  $\varphi(x^{-1})$ , respectively.

**Lemma 1.** *Let  $A$  and  $B$  be torsion-free groups, and let  $u \in (A * B) \setminus A$ . Then  $\langle A, u \rangle = A * \langle u \rangle_\infty$ . If, in addition,  $A$  is nontrivial and  $B$  is noncyclic, then there exists a word  $v \in A * B$  such that  $\langle A, u, v \rangle = A * \langle u \rangle_\infty * \langle v \rangle_\infty$ .*

**Proof.** Clearly, we can assume that the first and last letters of the reduced form of  $u$  lie in  $B$ . For such  $u$ , the first assertion of the lemma is obvious. Let us prove the second assertion. If  $u \in B$ , then we can take  $v = a^b$ , where  $b$  is an arbitrary element of  $B \setminus \langle u \rangle$  and  $a$  is any element of  $A \setminus \{1\}$ . If  $u \notin B$ ,  $u = b_1 a_1 \dots b_k$ , then we can take  $v = a^b$ , where  $b \in B \setminus \{b_1^{\pm 1}, b_k^{\pm 1}\}$  and  $a \in A \setminus \{1\}$ . Lemma 1 is proven.

The following lemma is a version of an algebraical trick from [K93], which was several times used for studying equations over groups and similar matter (see [KP95], [CG95], [CG00], [CR01], [FeR96], [FeR98], [FoR03]). A geometrical interpretation of this trick can be found in [FoR03].

**Lemma 2.** Suppose that the group  $G$  is torsion-free,

$$\sum \varepsilon_i = 1, \quad \text{and} \quad n > 1. \quad (1)$$

Then the group  $\tilde{G}$  has a (relative) presentation of the form

$$\tilde{G} \simeq \left\langle H, t \mid \{p^t = p^\varphi, p \in P \setminus \{1\}\}, ct \prod_{i=0}^m (b_i a_i^t) = 1 \right\rangle, \quad (2)$$

where  $H$  is a group,  $a_i, b_i, c \in H$ ,  $P$  and  $P^\varphi$  are isomorphic subgroups of  $H$ ,  $\varphi: P \rightarrow P^\varphi$  is an isomorphism, and the following conditions hold:

- 1)  $m \geq 0$  (i.e., the product in (2) is nonempty);
- 2)  $a_i \notin P$  and  $b_i \notin P^\varphi$ ;
- 3)  $\langle P, a_i \rangle = P * \langle a_i \rangle_\infty$  and  $\langle P^\varphi, b_i \rangle = P^\varphi * \langle b_i \rangle_\infty$  in  $H$ ;
- 4) if  $G$  is noncyclic and  $P \neq \{1\}$ , then, for each  $i$ , there exist elements  $a'_i, b'_i \in H$  such that  $\langle P, a_i, a'_i \rangle = P * \langle a_i \rangle_\infty * \langle a'_i \rangle_\infty$  and  $\langle P^\varphi, b_i, b'_i \rangle = P^\varphi * \langle b_i \rangle_\infty * \langle b'_i \rangle_\infty$  in  $H$ ;
- 5) the groups  $H$ ,  $P$ , and  $P^\varphi$  are free products of finitely many isomorphic copies of  $G$ :  $H = G^{(0)} * \dots * G^{(s)}$ ,  $P = G^{(0)} * \dots * G^{(s-1)}$ ,  $P^\varphi = G^{(1)} * \dots * G^{(s)}$ , where  $s \geq 0$  (for  $s = 0$ ,  $P$  and  $P^\varphi$  are assumed to be trivial), and the isomorphism  $\varphi$  is the shift:  $(G^{(i)})^\varphi = G^{(i+1)}$ .

**Proof.** First, let us show that the group  $\tilde{G}$  has a presentation of the form (2) satisfying condition 5. Since  $\sum \varepsilon_i = 1$ , the word  $w$  can be written in the form

$$w = \left( \prod g_i^{t^{k_i}} \right) t.$$

Conjugating, if necessary,  $w$  by  $t$ , we can assume that  $k_i \geq 0$ . We set  $g^{(i)} = g^{t^i}$  for  $g \in G$ ,  $G^{(i)} = G^{t^i}$ ,  $s = \max k_i$ , and  $c = \prod g_i^{(k_i)}$ . We see that  $\tilde{G}$  has the presentation

$$\tilde{G} \simeq \left\langle G^{(0)} * \dots * G^{(s)}, t \mid \left\{ \left( g^{(i)} \right)^t = g^{(i+1)}, i = 0, \dots, s-1, g \in G \right\}, ct = 1 \right\rangle,$$

which is a presentation of the form (2) (with  $m = -1$ ) satisfying condition 5.

Now, from all presentations of the form (2) satisfying condition 5, we choose presentations with minimal  $s$ , and from all these presentations with minimal  $s$ , we choose one with minimal  $m$ . The obtained presentation (2) is as required.

Indeed, if  $m < 0$  (i.e.,  $w = ct$ , where  $c \in H$ ), then  $s = 0$ , because otherwise we might decrease  $s$  replacing all fragments  $g^{(s)}$  in the word  $c$  by  $(g^{(s-1)})^t$ . But the conditions  $m < 0$  and  $s = 0$  mean that the initial word  $w$  has the form  $w = ct$ , where  $c \in G$ , which contradicts the assumption  $n > 1$ . Thus, condition 1 holds.

Condition 2 holds because otherwise in presentation (2) we might replace a fragment  $t^{-1}a_i t$  with  $a_i \in P$  (or a fragment  $tb_i t^{-1}$  with  $b_i \in P^\varphi$ ) by  $a_i^\varphi$  (or by  $b_i^{\varphi^{-1}}$ , respectively), thereby decreasing  $m$  (and not increasing  $s$ ).

Conditions 3 and 4 follow from conditions 2 and 5 by Lemma 1. Lemma 2 is proven.

## 5. Maps and motions

Throughout this paper, the term ‘‘surface’’ means ‘‘closed oriented two-dimensional surface’’.

A map  $M$  on a surface  $S$  is a finite set of continuous mappings  $\{\mu_i: D_i \rightarrow S\}$ , where  $D_i$  is a compact oriented two-dimensional disk, called the  $i$ th *face*, or *cell*, of the map; the boundary of each face  $D_i$  is partitioned into finitely many intervals  $e_{ij} \subset \partial D_i$ , called the *pre-edges* of the map, by a nonempty set of points  $c_{ij} \in \partial D_i$ , called the *corners* of the map. The images of the corners  $\mu_i(c_{ij})$  and pre-edges  $\mu_i(e_{ij})$  are called the *vertices* and *edges* of the map, respectively. It is assumed that

- 1) the restriction of  $\mu_i$  to the interior of each face  $D_i$  is a homeomorphic embedding preserving orientation; the restriction of  $\mu_i$  to each pre-edge is a homeomorphic embedding;
- 2) different edges do not intersect;
- 3) the images of the interiors of different faces do not intersect;
- 4)  $\bigcup \mu_i(D_i) = S$ .

Sometimes, we interpret a map  $M$  as a continuous mapping  $M: \coprod D_i \rightarrow S$  from a discrete union of disks onto the surface.

The union of all vertices and edges of a map is a graph on the surface, called the *1-skeleton*. The *multiplicity* of a point of the 1-skeleton is the number of edges incident to this point if this point is a vertex; if this point lies on an edge, then its multiplicity is assumed to be two. In other words, the multiplicity of a point  $p$  is  $|M^{-1}(p)|$ .

We say that a corner  $c$  is a corner at a vertex  $v$  if  $M(c) = v$ . There is a natural cyclic order on the set of all corners at a vertex  $v$ ; we call two corners at  $v$  *adjacent* if they are neighboring with respect to this order.

By abuse of language, we say that a point or a subset of the surface is contained in a face  $D_i$  if it lies in the image of  $\mu_i$ . Similarly, we say that a face  $D_i$  is contained in some subset  $X \subseteq S$  of the surface  $S$  if  $M(D_i) \subseteq X$ .

Figure 1 presents a map on the sphere with 5 faces —  $A, B, C, D,$  and  $E$ , 18 corners —  $a_i, b_i, c_i, d_i,$  and  $e_i$ , 6 vertices, 9 edges, and 18 pre-edges. Note that the number of corners always equals the number of pre-edges and is twice the number of edges, and the value

$$e(S) \stackrel{\text{def}}{=} (\text{the number of vertices}) - (\text{the number of edges}) + (\text{the number of faces})$$

does not depend on the choice of a map on the surface  $S$  and is called *the Euler characteristic* of this surface. The Euler characteristic of the sphere (the only surface of our real interest in this paper) is two.

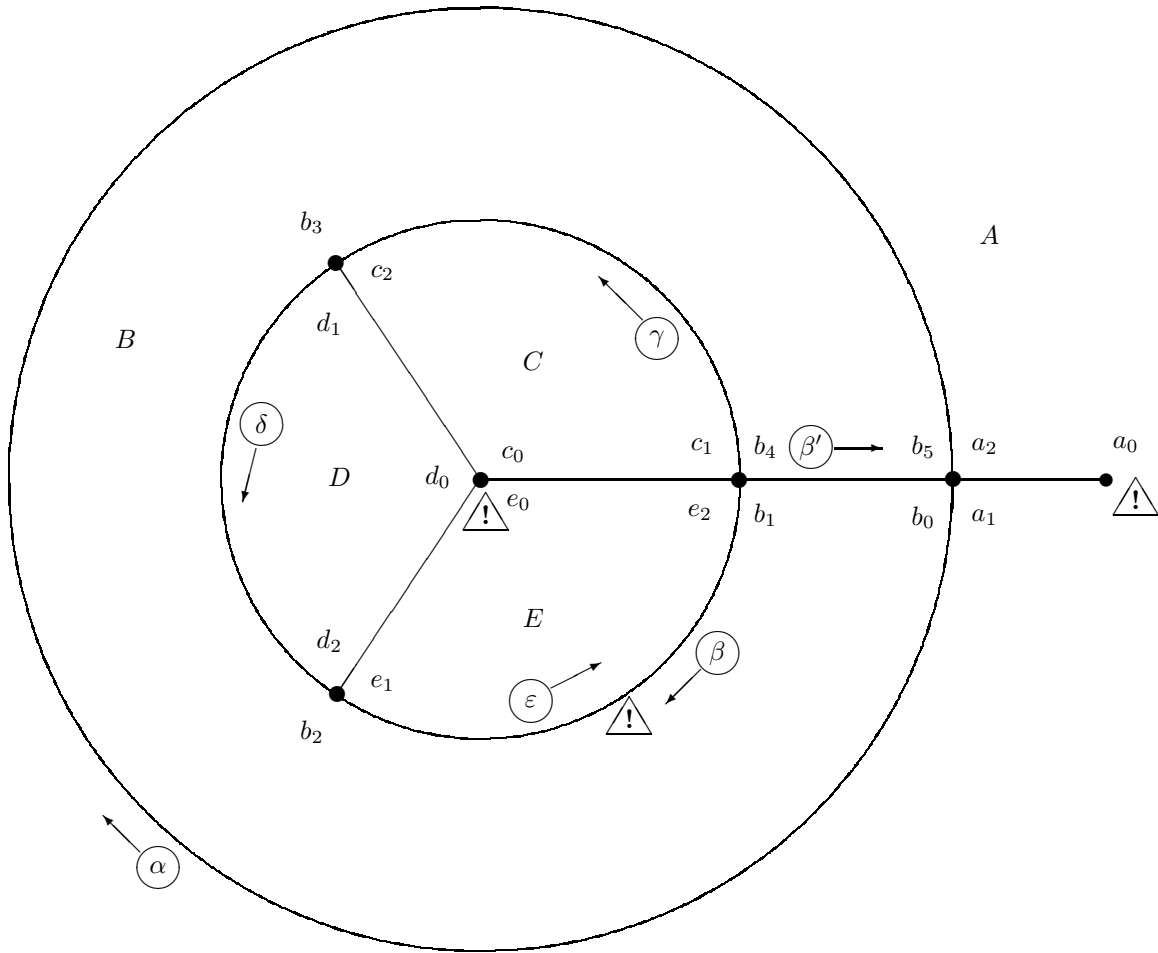

Fig. 1

A *motion* on a surface  $S$  is a map  $M: \coprod D_i \rightarrow S$  on this surface and a set of continuous mappings  $\alpha_i: \mathbb{R} \rightarrow \partial D_i$ . The mapping  $\alpha_i$  is called a *car* moving around the face  $D_i$ . We say that a car  $\alpha_i$  is at a corner  $c \in \partial D_i$  at a moment of time  $t \in \mathbb{R}$  if  $\alpha_i(t) = c$ ; We also say that a car  $\alpha_i$  is at a point  $p \in S$  at a moment  $t \in \mathbb{R}$  if  $\mu_i(\alpha_i(t)) = p$ . If the number of cars being at moment  $t \in \mathbb{R}$  at a point  $p$  of the 1-skeleton of  $S$  equals the multiplicity of this point (in other words,  $\bigcup \alpha_i(t) \supseteq M^{-1}(p)$ ), then we say that at the point  $p$  at the moment  $t$  a *complete collision* occurs; The point  $p$  is called a *point of complete collision*. Points of complete collision lying on edges are called simply *points of collision*.

A motion is called *regular* if the mappings  $\alpha_i$  are orientation-preserving coverings. Simply speaking, in a regular motion, a car moves around the boundary of its face anticlockwise (the interior of the face remains on the left from the car) without U-turns, stops, and “infinite decelerations and accelerations”.

**Example 1.** On the map shown on Figure 1, we specify a regular motion as follows: the cars  $\alpha$ ,  $\beta$ ,  $\gamma$ ,  $\delta$ , and  $\varepsilon$  moving around the faces  $A$ ,  $B$ ,  $C$ ,  $D$ , and  $E$ , respectively, move with unit speed (one edge per unit time) in the positive direction and, at the zero moment of time, the cars visit the corners  $a_0$ ,  $b_0$ ,  $c_0$ ,  $d_0$  and  $e_0$ , respectively (at corners with number  $i$ , the cars are at the moment  $t = i$ ). In Figure 1, the positions of the cars and the direction of their motion at the moment  $t = 4/3$  are shown (the car  $\beta'$  should be ignored for a while). This motion has 3 points of complete collision, they are marked by the exclamation signs in Figure 1: at the moments being multiples of 3, complete collisions of the cars  $\gamma$ ,  $\delta$ , and  $\varepsilon$  occur; at the moments  $t \in 3/2 + 6\mathbb{Z}$ , the cars  $\beta$  and  $\varepsilon$  collide on an edge; in addition, at the moments being multiples of 3, the car  $\alpha$  is at the dead end, this is also a complete collision, according to the definition. We can vary slightly the schedule of the motion and reduce the number of complete collision points to two (e.g., we can make the car  $\varepsilon$  to move with speed 2 on the edges  $[e_0, e_1]$  and  $[e_1, e_2]$  and with speed  $1/2$  on the edge  $[e_2, e_0]$ ). The further optimization of the schedule is impossible, as the following lemma shows.

**Lemma 3** [K93] (see also [FeR96]). *Any regular motion on the sphere has at least two points of complete collision.*

Sometimes (see [K93] or [FeR96]), it is useful to consider motions slightly more general than regular.

We call a continuous mapping  $\alpha: X \rightarrow Y$  from an oriented line or circle  $X$  to an oriented circle  $Y$  (locally) *nondecreasing* if the preimage of any interval  $U \subset Y$  is a union of such intervals that the restriction of  $\alpha$  to each of these intervals is a nondecreasing function (in the usual sense, as a function from one oriented interval to another). We call a mapping  $\alpha: X \rightarrow Y$  from a line to a circle *proper* if the image of any half-line  $U \subset X$  is the entire circle  $Y$ .

The preimage of a point under a proper nondecreasing mapping from a line to a circle is a discrete union of points and closed intervals. A point  $y \in Y$  whose preimage is nondiscrete is called a *stop point* of the mapping.

A motion on a surface  $S$  is called a *motion with separated stops* if every car is a proper nondecreasing function each of whose stop points is a corner (i.e., simply speaking, each car moves without U-turns and infinite decelerations and accelerations moving around the boundary of its face anticlockwise, possibly stopping for a finite time at some corners); and there exists a set of corners called the *stop corners* such that

- 1) the cars stop only at stop corners (possibly, at some stop corners, the cars do not stop);
- 2) at each vertex  $v$  having stop corners at it, the stops are separated in the following sense: let  $c_1, \dots, c_k$  be all stop corners at  $v$  enumerated anticlockwise; it is required that, for each  $i$ , at corners  $c_i$  and  $c_{i+1}$  (subscripts are modulo  $k$ ), cars are never located simultaneously. (In particular, this implies that  $k \geq 2$ .)

**Lemma 4** [K93] (see also [FeR96]). *Any motion with separated stops on the sphere has at least two points of complete collision.*

**Proof.** First, note that the motion of a car moving via a stop corner can be slightly changed in a small neighborhood of this corner in such a way that this car does stop at this corner, no new points of complete collision arise, and the separated stops condition is not violated.

Now, assuming that each car does stop every time moving via a stop corner, we make the following transformation of the map called *blowing-up of stop corners* (see Fig. 2): we take a vertex  $v$  at which there are  $k \geq 2$  stop corners  $c_1, \dots, c_k$ ; for each  $i$ , we cut the surface along a small arc drawn from the vertex  $v$  “inside” the corner  $c_i$ ; the boundary of this cut is denoted  $x_i$  (the left boundary if to look from  $v$ ) and  $y_i$  (the right boundary if to look from  $v$ ). When we have made these cuts for all  $i = 1, \dots, k$ , there appears a hole on the surface with boundary consisting of the consecutive segments  $y_1, x_1, y_2, x_2, \dots, y_k, x_k$ ; let us remove this hole by glueing each segment  $x_i$  with  $y_{i+1}$  (the subscripts are modulo  $k$ ); we obtain a new map  $M'$  on the same surface. This new map has the additional pre-edges  $x_i$  and  $y_i$  (instead of the stop corners  $c_i$ ) and the additional edges  $M'(x_i) = M'(y_{i+1})$ .

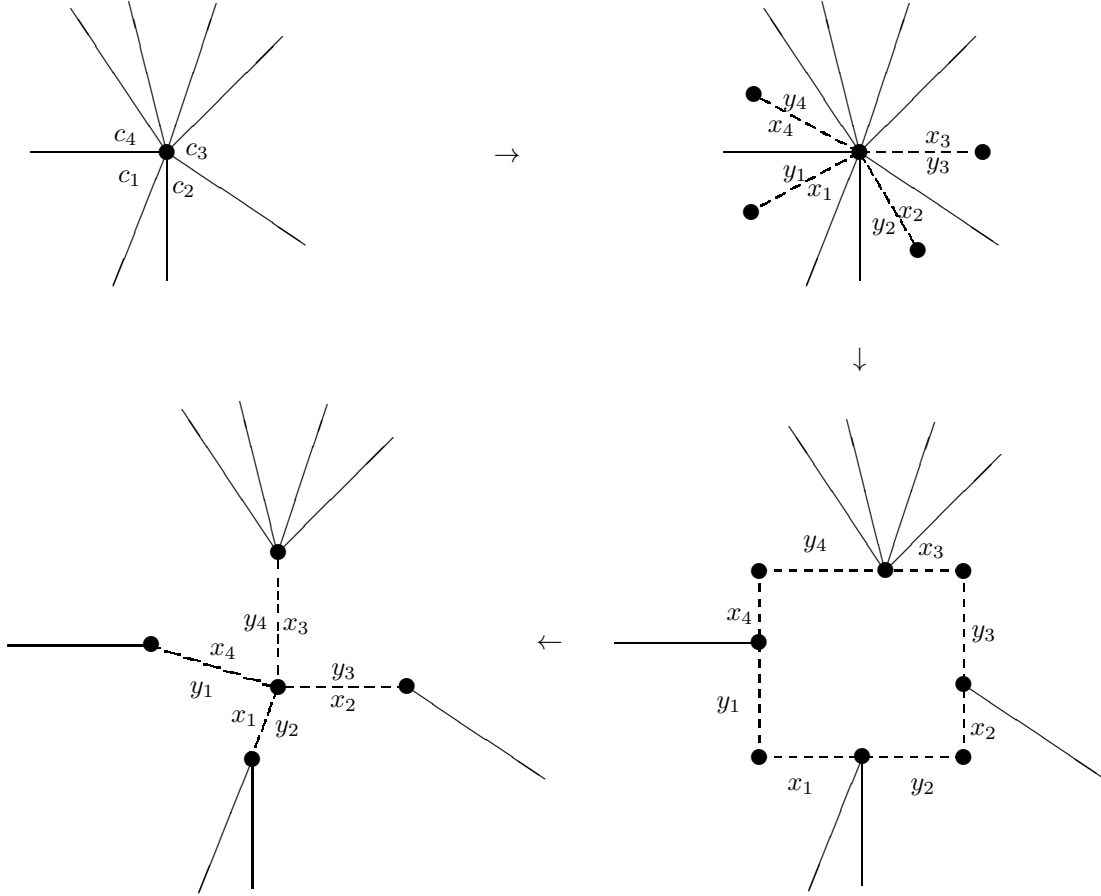

Fig. 2

Having made the transformation described above for each vertex  $v$  with stop corners at it, we specify a regular motion on the obtained map as follows: the cars move as on the initial map, but, during the time when a car on the initial map is staying at a stop corner  $c_i$ , the corresponding car on the new map moves uniformly along the pre-edges  $x_i$  and  $y_i$ . The stops separated condition implies that this regular motion on the new map has no complete collisions on the additional edges and at their ends. Thus, the assertion of the lemma follows from Lemma 3.

Note that the separated stops condition means, in particular, that no complete collision can occur at a vertex at which there is at least one stop corner.

## 6. Howie diagrams

Suppose that we have a map  $M$  on a surface  $S$ , the corners of the map are labeled by elements of a group  $H$ , and the edges are oriented (in the figures, we draw arrows on the edges) and labelled by elements of a set  $\{t_1, t_2, \dots\}$  disjoint from the group  $H$ . The label of a corner or an edge  $x$  is denoted by  $\lambda(x)$ .

The *label of a vertex*  $v$  of such a map is defined by the formula

$$\lambda(v) = \prod_{i=1}^k \lambda(c_i),$$

where  $c_1, \dots, c_k$  are all corners at  $v$  listed clockwise. The label of a vertex is an element of the group  $H$  determined up to conjugacy.

The *label of a face*  $D$  is defined by the formula

$$\lambda(D) = \prod_{i=1}^k (\lambda(M(e_i)))^{\varepsilon_i} \lambda(c_i),$$

where  $e_1, \dots, e_k$  and  $c_1, \dots, c_k$  are all pre-edges and all corners of  $D$  listed anticlockwise, the endpoints of  $e_i$  are  $c_{i-1}$  and  $c_i$  (subscripts are modulo  $k$ ), and  $\varepsilon_i = \pm 1$  depending on whether the homeomorphism  $e_i \xrightarrow{M} M(e_i)$  preserves or reverses orientation. Simply speaking, to obtain the label of a face, we should go around its boundary anticlockwise,

writing out the labels of all corners and edges we meet, the label of an edge traversed against the arrow should be raised to the power  $-1$ .

The label of a face is an element of the group  $H * F(t_1, t_2, \dots)$  (the free product of  $H$  and the free group with basis  $\{t_1, t_2, \dots\}$ ) determined up to a cyclic permutation. More precisely, the right-hand side of our formula for  $\lambda(D)$  is called the *label of the face  $D$  written starting with the pre-edge  $e_1$* .

Such a labelled map is called a *Howie diagram* (or simply *diagram*) over a relative presentation

$$\langle H, t_1, t_2, \dots \mid w_1 = 1, w_2 = 1, \dots \rangle \tag{*}$$

if

- 1) some vertices and faces are separated out and called *exterior*, the remaining vertices and faces are called *interior*;
- 2) the label of each interior face is a cyclic permutation of one of the words  $w_i^{\pm 1}$ ;
- 3) the label of each interior vertex is the identity element of  $H$ .

A diagram is said to be *reduced* if it contains no such edge  $e$  that both faces containing  $e$  are interior, these faces are different and their labels written starting with the M-preimages of  $e$  are mutually inverse; such a pair of faces with a common edge is called a *reducible pair*.

The following lemma is an analog of the van Kampen lemma for relative presentations.

**Lemma 5** [H83]. *The natural mapping from a group  $H$  to the group with relative presentation (\*) is noninjective if and only if there exists a spherical diagram over this presentation with no exterior faces and a single exterior vertex whose label is not 1 in  $G$ . A minimal (with respect to the number of faces) such diagram is reduced.*

*If this natural mapping is injective, then we have the equivalence: the image of an element  $u \in H * F(t_1, t_2, \dots) \setminus \{1\}$  is 1 in the group (\*) if and only if there exists a spherical reduced diagram over this presentation without exterior vertices and with a single exterior face with label  $u$ . A minimal (with respect to the number of faces) such diagram is also reduced.*

Diagrams on the sphere with a single exterior face and no exterior vertices are also called *disk diagrams*, the boundary of the exterior face of such a diagram is called the *contour* of the diagram.

Let  $\varphi: P \rightarrow P^\varphi$  be an isomorphism between two subgroups of a group  $H$ . A relative presentation of the form

$$\langle H, t \mid \{p^t = p^\varphi; p \in P \setminus \{1\}\}, w_1 = 1, w_2 = 1, \dots \rangle \tag{**}$$

is called a  $\varphi$ -*presentation*. A diagram over a  $\varphi$ -presentation (\*\*) is called  $\varphi$ -*reduced* if it is reduced and different interior cells with labels of the form  $p^t p^{-\varphi}$ , where  $p \in P$ , have no common edges.

**Lemma 6.** *A minimal (with respect to the number of faces) diagram among all spherical diagrams over a given  $\varphi$ -presentation without exterior faces and with a single exterior vertex with nontrivial label is  $\varphi$ -reduced. If no such diagrams exists, then a minimal diagram among all disk diagrams with a given label of contour is  $\varphi$ -reduced. In other words, the complete  $\varphi$ -analog of Lemma 5 is valid.*

**Proof.** Indeed, if in some diagram over presentation (\*\*) a pair of cells corresponding to relations of the form  $p^t p^{-\varphi}$ , where  $p \in P$  has a common edge, then either this pair of cells is a reducible pair or we can remove this common edge (Fig. 3) and obtain a diagram with a smaller number of cells and with the same labels of exterior faces and vertices; this means that the initial diagram is not minimal and proves the lemma.

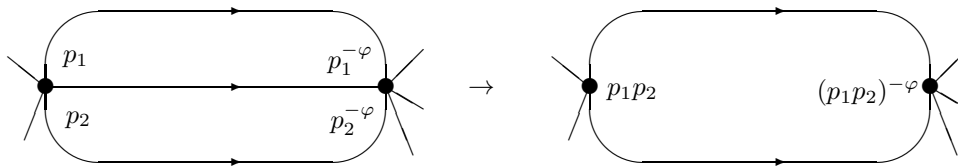

Fig. 3

A relative presentation ( $\varphi$ -presentation) over which there exists no reduced (respectively,  $\varphi$ -reduced) spherical diagrams with a single exterior vertex are called *aspherical* (respectively,  $\varphi$ -*aspherical*).

**Lemma 7.** *Suppose that the group  $H$  in presentation  $(*)$  is nontrivial and there exists a word  $w \in H * F(t_1, t_2, \dots)$  nonconjugate to the elements of  $H \cup \{w_i^{\pm 1}\}$  in  $H * F(t_1, t_2, \dots)$  and such that the presentation*

$$L = \langle H, t_1, t_2, \dots \mid w = 1, w_1 = 1, w_2 = 1, \dots \rangle$$

*is aspherical (or  $\varphi$ -aspherical, if the initial presentation  $(*)$  is a  $\varphi$ -presentation). Then the group  $K$  with presentation  $(*)$  is nonsimple.*

**Proof.** The ( $\varphi$ -)asphericity of the presentation  $L$  implies the ( $\varphi$ -)asphericity of presentation  $(*)$ .

Let us show that  $w \neq 1$  in the group  $K$ . Indeed, otherwise, by virtue of the ( $\varphi$ -)asphericity of  $(*)$  and Lemmata 5 and 6, over this presentation there would exist a ( $\varphi$ -)reduced disk diagram whose contour label is  $w$ . But such a diagram can be considered as a ( $\varphi$ -)reduced spherical diagram over the presentation  $L$  without exterior faces and vertices, which contradicts the asphericity of  $L$ .

The natural mapping from  $H$  to  $L$  is injective by Lemma 5 (and Lemma 6). Thus,  $L = K / \langle\langle w \rangle\rangle \neq \{1\}$ , and  $\langle\langle w \rangle\rangle$  is a proper nontrivial normal subgroup of  $K$ . Q.E.D.

### 7. Standard motion

Consider a map whose edges are oriented (e.g., a Howie diagram). Such a map can have corners of four kinds  $(++)$ ,  $(--)$ ,  $(+-)$ , and  $(-+)$  (Fig. 4).

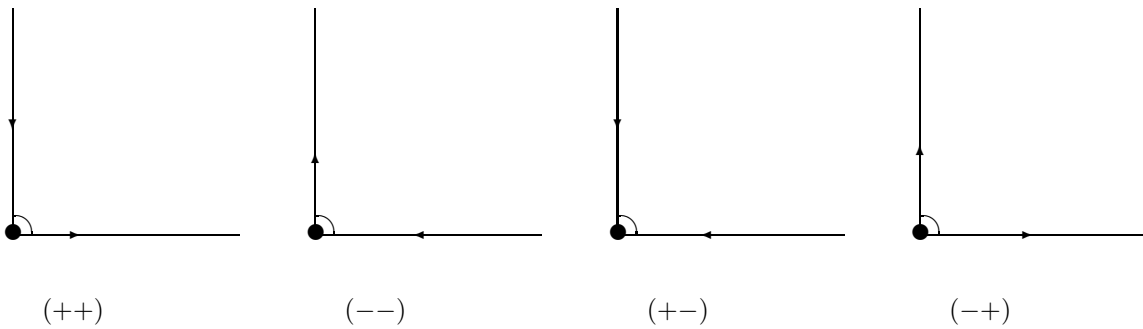

Fig. 4

The following lemma is obvious.

**Lemma 8.** *In the anticlockwise listing of the corners at a vertex  $v$ , the corners of type  $(++)$  alternate with corners of type  $(--)$ . If at a vertex  $v$  there are no corners of type  $(++)$ , or, equivalently, there are no corners of type  $(--)$ , then either all corners at  $v$  are of type  $(+-)$  (in this case,  $v$  is called a *sink*), or all corners at  $v$  are of type  $(-+)$  (in this case,  $v$  is called a *source*) (Fig. 5).*

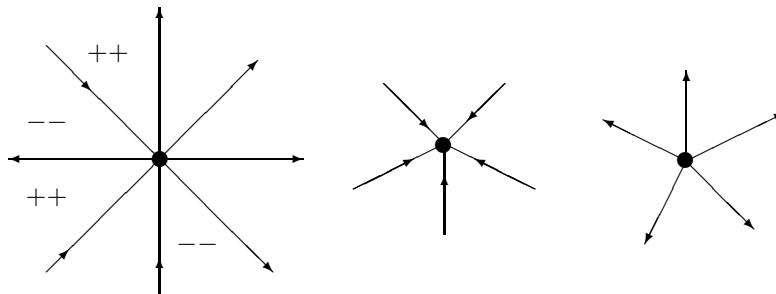

Fig. 5

We say that a map with oriented edges is of type  $A_m$ ,  $m \geq 0$ , if the sequence of pre-edge orientations of each face has one of the following four forms:

- a)  $+-$  (Figure 6a);
- b)  $+(+-)^{m+1}$  (Figure 6b);
- c)  $-(-+)^{m+1}$  (Figure 6c);
- d)  $(+)^{k+1}(-)^{l+1}$ , where  $k, l \geq 1$  (Figure 6d).



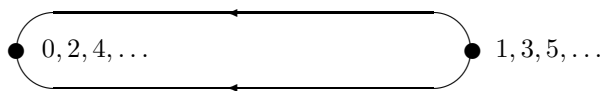

Fig. 6a

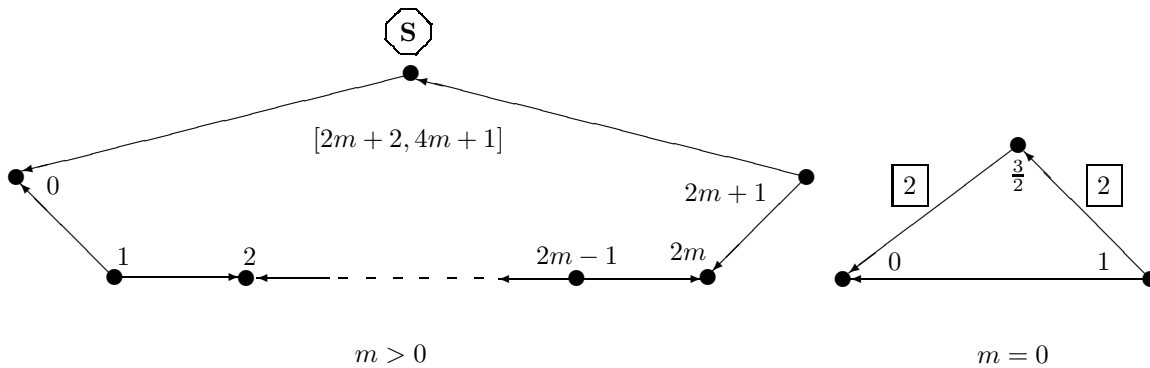

Fig. 6b

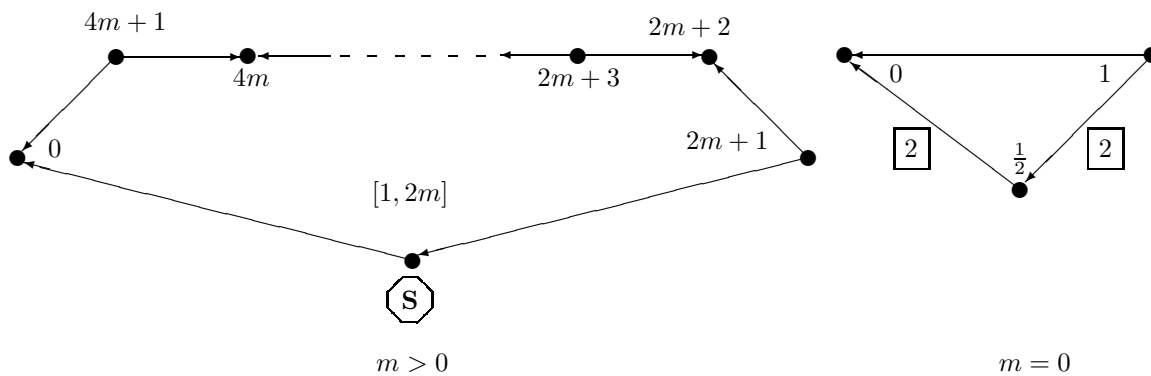
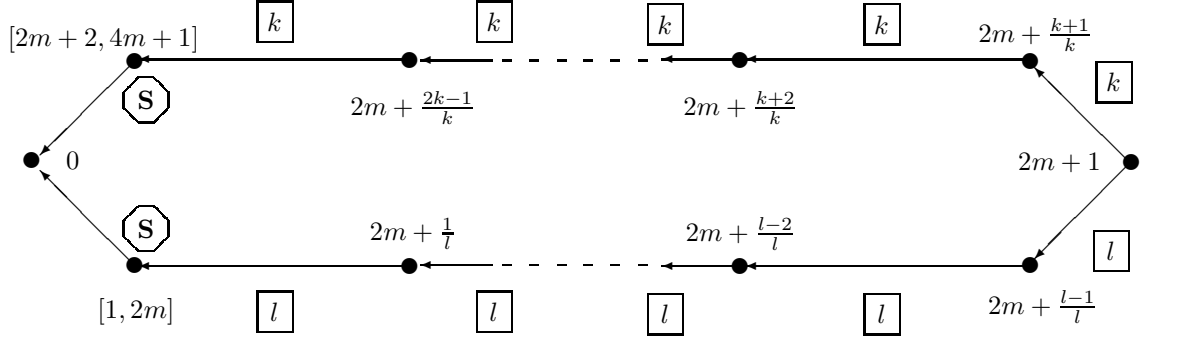
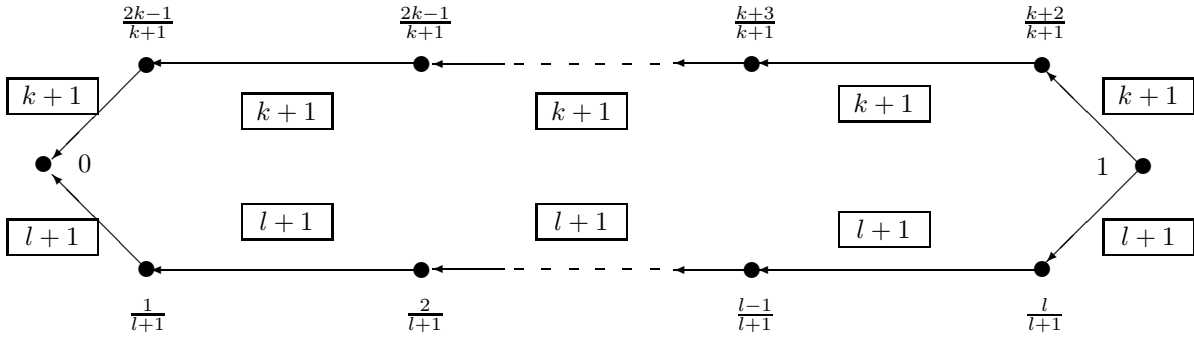

Fig. 6c



$m > 0$



$m = 0$

Fig. 6d

We define the *standard motion* on a map of type  $A_m$  as follows:

- the car going around a face of type  $+ -$  moves anticlockwise uniformly with unit speed (one edge per unit time) visiting the corner of type  $(+ -)$  at the even moments of time (Fig. 6a);
- for  $m > 0$ , the car moving around a face of type  $+(+ -)^{m+1}$  stays at the corner of type  $(+ +)$  during the time intervals  $[2m + 2, 4m + 1] + (4m + 2)\mathbb{Z}$ , and moves anticlockwise uniformly with unit speed all the remaining time; for  $m = 0$ , such a car moves without stops with speed 2 on the positive pre-edges and with speed 1 on the negative ones visiting the corner of type  $(+ -)$  at the even moments of time (Fig. 6b);
- for  $m > 0$ , the car moving around a face of type  $-(- +)^{m+1}$  stays at the corner of type  $(- -)$  during the time intervals  $[1, 2m] + (4m + 2)\mathbb{Z}$ , and go anticlockwise uniformly with unit speed all the remaining time; for  $m = 0$ , such a car moves without stops with speed 2 on the negative pre-edges and with speed 1 on the positive ones visiting the corner of type  $(+ -)$  at the even moments of time (Fig. 6c);
- for  $m > 0$ , the car moving around a face of type  $(+)^{k+1}(-)^{l+1}$  is at the corner of type  $(+ -)$  at time zero; then, it moves along the first negative pre-edge with unit speed; after that, it stops and waits during the time interval  $[1, 2m]$ ; next, it goes with speed  $l$  along the remaining  $l$  negative pre-edges and with speed  $k$  along the  $k$  positive pre-edges; after that, it stops and waits during the time interval  $[2m + 2, 4m + 1]$ ; then, it moves with unit speed through the last positive pre-edge and returns at the moment  $4m + 2$  again to the corner of type  $(+ -)$ ; after that, everything is repeated with period  $4m + 2$ . For  $m = 0$  such a car moves without stops with speed  $l + 1$  on the negative pre-edges and with speed  $k + 1$  on the positive ones visiting the corner of type  $(+ -)$  at the even moments of time (Fig. 6d).

The standard motion is periodic with period  $4m + 2$  (on the faces of type  $+ -$ , the minimal period is 2). Figure 6 shows the detailed schedule of the motion during the time interval  $[0, 4m + 2)$ , the boxed numbers near edges indicate the speed of the car on these edges (by default, the speed is 1). At corners labelled by the letter **S** the car stops for time  $2m - 1$ .

**Lemma 9.** *The standard motion on a map of type  $A_m$  is a motion with separated stops. The complete collisions can occur only at vertices being sources or sinks and only at integer moments of time.*

**Proof.** Let us declare all corners of types  $(++)$  and  $(--)$  to be the stop corners. Then, the stops are separated by virtue of Lemma 8 and the fact that the schedule of the standard motion is such that cars are never located simultaneously at corners of types  $(++)$  and  $(--)$  (the corners of type  $(--)$  are visited only during the first half of the period, i.e., at moments from the intervals  $(0, 2m + 1) + (4m + 2)\mathbb{Z}$ , while the corners of type  $(++)$  are visited during the second half of the period, i.e., at moments from the intervals  $(2m + 1, 4m + 2) + (4m + 2)\mathbb{Z}$ ).

A collision on an edge at a moment  $t$  means that at this moment the direction of the motion of one of the cars coincides with the direction of the edge, while the direction of the motion of the other colliding car is opposite to the direction of the edge (Fig. 7).

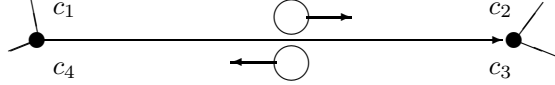

Fig. 7

But the schedule of the standard motion is such that, at each moment  $t$ , either all cars being on edges move in the direction of the edge (this is so when the integer part of  $t$  is odd), or all cars being on edges move in the direction opposite to the direction of the edge (this is so when the integer part of  $t$  is even). Therefore, collisions can occur only at vertices; the separatedness of stops implies that a vertex of complete collision can not have stop corners and, therefore, is a source or a sink. The cars visit such vertices only at integer moments of time (even for sinks and odd for sources). The lemma is proven.

### 8. Proof of the main theorem. The easy case

The “if” part of the main theorem is obvious. Let us prove the “only if” part. Clearly, the simplicity of  $\tilde{G}$  implies that the group  $G$  coincides with its commutator subgroup and  $\sum \varepsilon_i = \pm 1$  (because otherwise  $\tilde{G}$  would not coincide with its commutator subgroup). We suppose that  $G$  coincides with its commutator subgroup and conditions (1) hold; we have to prove that  $\tilde{G}$  is nonsimple.

By Lemma 2,  $\tilde{G}$  has presentation (2). The easy case considered in this section is the case when  $P \neq \{1\}$  in presentation (2) or, equivalently, the word  $w$  is not conjugate to a word of the form  $ct \prod_{i=0}^m (b_i a_i^t)$ , where  $c, a_i, b_i \in G$ . The nonsimplicity of  $\tilde{G}$  in this case is a corollary of Lemma 7 and the following fact.

**Lemma 10.** *Suppose that  $G$  is a noncyclic torsion-free group, conditions (1) hold, and  $P \neq \{1\}$  in presentation (2), then there exist elements  $a, b \in H$  such that the presentation*

$$\tilde{G} / \langle\langle a^{t^2} b \rangle\rangle \simeq \left\langle H, t \mid \{p^t = p^\varphi, p \in P \setminus \{1\}\}, ct \prod_{i=0}^m (b_i a_i^t) = 1, a^{t^2} b = 1 \right\rangle \quad (3)$$

obtained from presentation (2) by adding the relator  $a^{t^2} b = 1$  is  $\varphi$ -aspherical.

**Proof.** Let  $a$  and  $b$  be such elements of  $H$  that  $\langle P, a_m, a \rangle = P * \langle a_m \rangle_\infty * \langle a \rangle_\infty$  and  $\langle P^\varphi, b_0, b \rangle = P * \langle b_0 \rangle_\infty * \langle b \rangle_\infty$ . Such elements exist by Lemma 2 (property 4).

We have to show that there is no  $\varphi$ -reduced spherical diagram over presentation (3) without exterior faces and with a single exterior vertex. The cells of such a diagram have the forms shown in Figure 8. We see that the diagram is a map of type  $A_m$ . Let us show that all complete collisions of the standard motion on this map occur only at the exterior vertex.

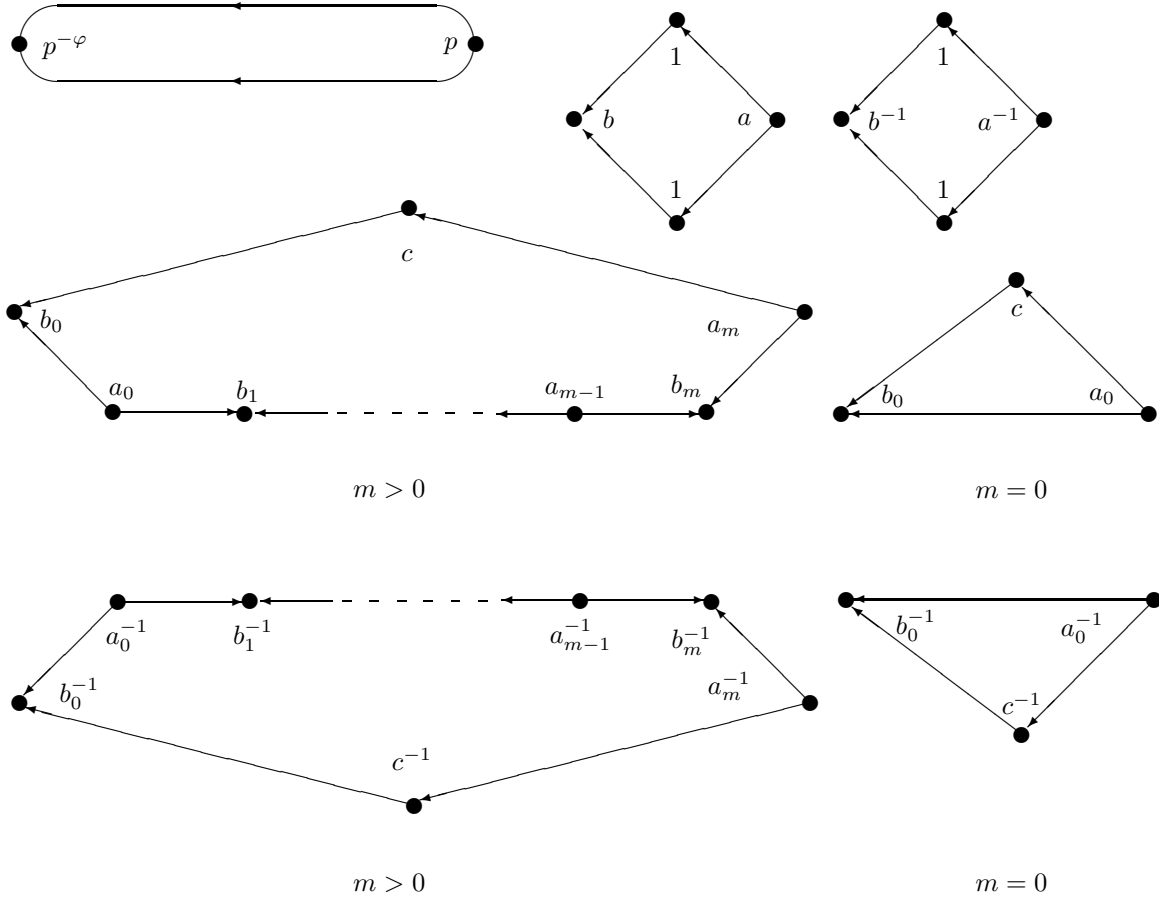

Fig. 8

According to Lemma 9, a complete collision can occur only at vertices being sinks or sources.

Suppose that a vertex of complete collision is a sink. Then, all corners at this vertex are of type  $(+-)$ ; the label of each of these corners is either  $p^\varphi$  (where  $p \in P$ ),  $b_i^{\pm 1}$ , or  $b^{\pm 1}$  (see Fig. 8). If at this vertex there are a corner labelled by  $b_i^{\pm 1}$  and a corner labelled by  $b_j^{\pm 1}$ , where  $i \neq j$ , then a complete collision does not occur at this vertex, because these two corners are never visited simultaneously (compare Figs. 8, 6b, and 6c). If at this vertex there is a corner labelled by  $b^{\pm 1}$ , then a complete collision can occur only at the moment  $0 \pmod{4m+2}$ , because only in this moment a car visit such a corner (Figs. 8 and 6d); but then, this vertex of complete collision can not have corners with labels  $b_i^{\pm 1}$ , where  $i \neq 0$ , because such corners are not visited at the moment  $0 \pmod{4m+2}$  (Figs. 8, 6b, and 6c). Thus, the label of a vertex being a sink at which a complete collision occurs is either

$$\prod_j (b_i^{\varepsilon_j} p_j^\varphi) \quad \text{or} \quad \prod_j (x^{\varepsilon_j} p_j^\varphi),$$

where  $\varepsilon_j \in \mathbb{Z}$ ,  $p_j \in P$ , and  $x \in \{b, b_0\}$ . But the label of an interior vertex must be 1. This means that we have a nontrivial (because the diagram is  $\varphi$ -reduced) relation of the specified form, which contradicts property 3 from Lemma 2 and the choice of  $b$ .

Similarly, supposing that a complete collision at a moment  $t$  occurs at an interior vertex being a source, we obtain a nontrivial relation of the form

$$\prod_j (a_i^{\varepsilon_j} p_j) = 1 \quad (\text{if } t \neq 2m+1 \pmod{4m+2}) \quad \text{or} \quad \prod_j (x^{\varepsilon_j} p_j) = 1 \quad (\text{if } t = 2m+1 \pmod{4m+2}),$$

where  $\varepsilon_j \in \mathbb{Z}$ ,  $p_j \in P$ , and  $x \in \{a, a_m\}$ , which contradicts property 3 from Lemma 2 and the choice of  $a$ .

Thus, a complete collision can occur only at the exterior vertex, but Lemma 4 says that there must be at least two different points of complete collision. This contradiction completes the proof of Lemma 10 and of the easy case of the main theorem.

**Remark.** Note that as a byproduct we have proven the following fact. *Suppose that we have a motion on a  $\varphi$ -reduced diagram over presentation (2) satisfying properties 1 and 3 from Lemma 2 which is standard on the interior faces. Then complete collisions can occur only at exterior vertices and on the boundaries of exterior faces.* In particular, this implies (by virtue of Lemmata 2, 4, 5, and 6) the main result of [K93]: *if a group  $G$  is torsion-free and  $\sum \varepsilon_i = 1$ , then the natural mapping  $G \rightarrow \tilde{G}$  is injective.*

## 9. Comotions and multiple motions

In this section, we expose the theory of comotions, which were introduced and applied to study equations over group in [K94] and [K97]. Our present exposition differs from that of the works mentioned above in terminology and generality.

The notion of a comotion is dual to that of a periodic motion.

**Definition.** A *comotion*  $A$  on a surface  $S$  is a map  $M: \coprod D_i \rightarrow S$  on this surface and a set of continuous mappings  $\{\alpha_i: \partial D_i \rightarrow \mathbf{T}\}$ , where  $\mathbf{T}$  is an oriented circle, called the circle of time. Sometimes, we shall interpret a comotion as a continuous mapping  $A: \coprod \partial D_i \rightarrow \mathbf{T}$ . The mapping  $\alpha_i$  is called the *cocar* moving around the face  $D_i$ . We say that a cocar  $\alpha_i$  is at a point  $p \in S$  at time  $t \in \mathbf{T}$  if  $\alpha_i(\mu_i^{-1}(p)) \ni t$ . We say that a *complete collision* occurs at a point  $p$  of the 1-skeleton of the surface  $S$  at a moment  $t \in \mathbf{T}$  if  $A^{-1}(t) \supseteq M^{-1}(p)$ ; the point  $p$  is called a *point of complete collision*. Points of complete collision lying on edges are called simply *points of collision*. A comotion is said to be *regular* if all the mappings  $\alpha_i$  are nondecreasing.

Note that, for a continuous nondecreasing mapping from one circle to another, the number of simply connected components of the preimage of a point is always finite, does not depend on the point, and coincides with the degree of the mapping.

The main property of comotions used in this paper is as follows.

**Lemma 11.** *For a regular comotion  $\{\alpha_i\}$  on a surface  $S$ ,*

$$(the\ number\ of\ points\ of\ complete\ collision) + \sum_i (1 - \deg \alpha_i) \geq e(S).$$

In fact, this inequality is a simple corollary of an equality, to write which we need some additional denotations.

Take a one-to-one continuous orientation preserving mapping  $f: [0; T) \rightarrow \mathbf{T}$  from a half-open interval  $[0; T)$  ( $T \in \mathbb{R}$ ) onto a circle. Let us define the functions  $\chi: \mathbf{T} \times \mathbf{T} \rightarrow \mathbb{Z}$  and  $\psi: \coprod_{k \in \mathbb{N}} \mathbf{T}^k \rightarrow \mathbb{Z}$  by the formulae

$$\chi(x, y) = \begin{cases} 0 & \text{if } f^{-1}(x) \leq f^{-1}(y); \\ 1 & \text{if } f^{-1}(x) > f^{-1}(y); \end{cases}$$

$$\psi(t_1, \dots, t_k) = \chi(t_1, t_2) + \chi(t_2, t_3) + \dots + \chi(t_k, t_1); \quad \psi(t_1) = 0.$$

**Lemma 12.** *The function  $\psi$  has the following properties:*

- 1) *it does not depend on the choice of the function  $f$  and can be defined invariantly as follows: consider an oriented circle  $X$ , points  $x_1, \dots, x_k \in X$  lying on this circle in the specified order, and a continuous nondecreasing mapping  $F: X \rightarrow \mathbf{T}$ , which maps each point  $x_i$  to a point  $t_i$  and the arc  $[x_i, x_{i+1}]$  onto the arc  $[t_i, t_{i+1}]$  (here the subscripts are modulo  $k$  and an arc with coinciding endpoints is assumed to be the singleton); then  $\psi(t_1, \dots, t_k) = \deg F$ ;*
- 2) *it takes integer nonnegative values;*
- 3)  *$\psi(t_1, \dots, t_k) = 0$  if and only if all  $t_i$  are equal.*

**Proof.** Properties 2 and 3 are obvious. To prove property 1, note that, by definition,  $\psi(t_1, \dots, t_k)$  equals to the number of the half-open arcs  $(t_i, t_{i+1}]$  containing  $f(0)$  (here the subscripts are modulo  $k$  and a half-open arc with coinciding endpoints is assumed to be empty). This number, in its turn, is the number of  $F$ -preimages of the point  $f(T - \varepsilon)$ , where  $\varepsilon$  is a sufficiently small positive real number. The lemma is proven.

**Lemma 13.** *Let  $A: \coprod \partial D_i \rightarrow \mathbf{T}$  be a regular comotion on a surface  $S$ . Let us define the weight  $\nu$  for a face  $D_i$ , an edge  $e$ , and a vertex  $v$  by the following formulae:*

$$\nu(D_i) = 1 - \deg \alpha_i,$$

$$\nu(e) = -1 + (\text{the number of connected components of the set of points of } e \text{ not being points of collision}),$$

$$\nu(v) = 1 - \psi(A(c_0), \dots, A(c_k)),$$

where  $c_0, \dots, c_k$  are all corners at the vertex  $v$  enumerated anticlockwise. Then the sum of the weights of all faces, edges, and vertices equals the Euler characteristic of the surface  $S$ . (Recall that, according to the definition, edge's endpoints do not belong to the edge.)

**Proof.** Note that the total weight of the faces, edges, and vertices is invariant with respect to subdivision of edges, i.e., it remains the same when a new vertex  $v$  dividing an edge  $e$  into two edges  $e_1$  and  $e_2$  is added. Indeed, if the new

vertex  $v$  is a point of the edge  $e$  at which no collision occurs, then the total number of connected components of the set of points of the edges  $e_1$  and  $e_2$  not being points of collision is large by one than the similar value for the edge  $e$ , and the weight of the vertex  $v$  is 0. Thus, the total weight does not change:  $\nu(e_1) + \nu(e_2) + \nu(v) = \nu(e)$ . If the new vertex  $v$  is a collision point of the edge  $e$ , then the total number of connected components of the set of points of the edges  $e_1$  and  $e_2$  not being points of collision equals the similar value for the edge  $e$ , and the weight of the vertex  $v$  is 1. Thus, the total weight does not change either.

Subdividing the edges, we can achieve the situation when each edge  $e$  has the following properties:

- 1) at some moment of time, there are no cocars on the closure of  $e$ ;
- 2) either there occur no collisions on  $e$ , or collisions occur at each point of  $e$  (in the latter case, the function  $A$  is constant on  $M^{-1}(e)$ ).

Note that the weight of an edge  $e$  having these properties equals either 0 or  $-1$  and can be written in the form

$$\nu(e) = \psi(A(c_1), A(c_2), A(c_3), A(c_4)) - 1,$$

where  $c_1, c_2, c_3, c_4$  are the corners adjacent to  $e$  enumerated clockwise (as in Figure 7). The validity of this formula can be easily verified by using the properties of function  $\psi$  (Lemma 12) and the fact that the properties 1 and 2 of the edge  $e$  imply that the intervals  $(A(c_1), A(c_2))$  and  $(A(c_3), A(c_4))$  are disjoint.

According to Lemma 12, the weight of a face can be written in the form

$$\nu(D_i) = 1 - \psi(\alpha_i(c_0), \dots, \alpha_i(c_k)),$$

where  $c_0, \dots, c_k$  are all corners of the face  $D_i$  enumerated anticlockwise. To complete the proof, we use the following obvious fact.

**Lemma 14.** *Suppose that we have a map on a surface  $S$  and two functions  $g$  and  $h$  assigning numbers to pairs of corners. Let us define the weight  $\nu$  for a face  $D$ , an edge  $e$ , and a vertex  $v$  by the following formulae:*

$$\begin{aligned} \nu(D) &= 1 - \sum_{i=0}^k g(c_i, c_{i+1}), \\ \nu(e) &= -1 + g(c_1, c_2) + h(c_2, c_3) + g(c_3, c_4) + h(c_4, c_1), \\ \nu(v) &= 1 - \sum_{i=0}^k h(c_i, c_{i+1}); \end{aligned}$$

*in the first formula,  $c_0, \dots, c_k$  are all corners of the face  $D$  enumerated anticlockwise; in the second formula,  $c_1, \dots, c_4$  are all corners adjacent to the edge  $e$  enumerated clockwise (Fig. 7); and, in the last formula,  $c_0, \dots, c_k$  are all corners at the vertex  $v$  enumerated anticlockwise. Then the total weight of all faces, edges, and vertices equals the Euler characteristic of the surface  $S$ .*

To prove this fact, it is sufficient to note that, when the weights are summed, all the values of the functions  $g$  and  $h$  are cancelled: each term  $g(x, y)$  which occurs in the weight of a face with a minus sign occurs also in the weight of an edge with a plus sign; similarly, each term  $h(x, y)$  occurring in the weight of a vertex with a minus sign occurs also in the weight of an edge with a plus sign.

To complete the proof of Lemma 13 we should put  $g(c_1, c_2) = h(c_1, c_2) = \chi(A(c_1), A(c_2))$  in Lemma 14.

Lemma 11 immediately follows from Lemma 13; we should only note that the weight of an edge (from Lemma 13) is not higher than the number of collision points of this edge, and the weight of a vertex is 1 if a complete collision occurs at this vertex and is nonpositive otherwise.

**Definition.** A *multiple motion of period  $T \in \mathbb{R}$*  on a surface  $S$  is a map  $\{\mu_i: D_i \rightarrow S \mid i \in I\}$  on this surface and a set of mappings  $\{\alpha_{i,j}: \mathbb{R} \rightarrow \partial D_i; i \in I, j = 1, \dots, d_i\}$  (called cars) satisfying the following periodicity conditions:

- 1)  $\alpha_{i,j}(t + T) = \alpha_{i,j+1}(t)$  for any  $t \in \mathbb{R}$  and  $j \in \{1, \dots, d_i\}$  (subscripts are modulo  $d_i$ );
- 2) there exists such a partitioning of each circle  $\partial D_i$  into  $d_i$  arcs that during the time interval  $[0, T]$  each car  $\alpha_{i,j}$  moves along the  $j$ th arc.

The positive integers  $d_i$  are called the *multiplicities* of the multiple motion. A multiple motion is called *regular* if all the function  $\alpha_{i,j}$  are orientation-preserving coverings.

**Example 2.** Let us specify a multiple motion on the map shown in Figure 1 as follows: the cars  $\alpha, \beta, \gamma, \delta,$  and  $\varepsilon$  going around the faces  $A, B, C, D,$  and  $E,$  respectively, move as in Example 1, i.e., with unit speed (one edge per unit time) in the positive direction being at time zero at the corners  $a_0, b_0, c_0, d_0,$  and  $e_0,$  respectively; in addition, there is also a car  $\beta'$  going around the face  $B$  in the positive direction with unit speed, being at time zero at the corner  $b_3.$  In Figure 1, the positions of the cars at time  $t = 4/3$  are shown. This multiple motion is regular, it has period 3 and set of multiplicities  $\{1, 2, 1, 1, 1\}.$  The complete collisions occur at the same three points as in Example 1 (they are marked by the exclamation signs in Figure 1). However, in this example, no variation of the motion schedule can decrease the number of points of complete collision.

**Lemma 15.** *The number of points of complete collision of a regular multiple motion with multiplicities  $\{d_i; i \in I\}$  on a surface  $S$  cannot be smaller than*

$$e(S) + \sum_{i \in I} (d_i - 1).$$

**Proof.** A regular multiple motion  $\{\alpha_{i,j}\}$  induces a comotion  $\{\beta_i: \partial D_i \rightarrow \mathbb{R}/T\mathbb{Z}\}.$  It is sufficient to put  $\beta_i(x)$  to be such  $t$  that  $\alpha_{i,j}(t) = x;$  this function does not depend on  $j,$  is well-defined modulo  $T,$  and is a covering of degree  $d_i.$  To complete the proof, it remains to note that the points of complete collision of this comotion coincide with the points of complete collision of the initial multiple motion and apply Lemma 11.

A multiple motion  $\{\alpha_{i,j}\}$  is called a *multiple motion with separated stops* if all the cars  $\alpha_{i,j}$  are nondecreasing functions and the stops are separated in the sense of the definition from Section 5.

**Lemma 16.** *The number of points of complete collision of a multiple motion with separated stops on a surface  $S$  cannot be smaller than*

$$e(S) + \sum_{i \in I} (d_i - 1),$$

where  $d_i$  are the multiplicities of the multiple motion.

This lemma is derived from Lemma 15 in exactly the same way as Lemma 4 is derived from Lemma 3.

We say that a map on a surface is *2-graded* if it has the following additional structure: some vertices and some faces are distinguished and called *exterior*, the remaining vertices and faces are called *interior*; in addition, some faces are called *large*, the remaining faces are called *small*.

Suppose that we have a (multiple) motion on a 2-graded map  $M$  on a surface  $S.$  We say that two different large faces  $A$  and  $B$  *badly contact each other* if they have such corners  $a_1, a_2 \in \partial A$  and  $b_1, b_2 \in \partial B$  that

- 1)  $a_i$  and  $b_i$  are nonadjacent corners at some interior vertex of complete collision  $v_i = M(a_i) = M(b_i)$  (for  $i = 1, 2$ );
- 2)  $v_1 \neq v_2;$
- 3) the closed path on the surface  $S$  formed by the fragment  $[a_1, a_2]$  of the boundary of the face  $A$  and the fragment  $[b_2, b_1]$  of the boundary of the face  $B$  does not meet exterior vertices and bounds a disk submap all of whose vertices are interior and all cells are small and interior.

We say that a large face  $A$  *badly contacts itself* if either it has such four different corners  $a_1, a_2, b_2, b_1 \in \partial A$  (disposed in this order) that the above conditions 1), 2), and 3) hold, or it has corners  $a, b \in \partial A$  being different nonadjacent corners at some interior vertex of complete collision  $v = M(a) = M(b)$  and the fragment  $[a, b]$  of the boundary of  $A$  does not meet exterior vertices on the surface  $S$  and bounds a disk submap all of whose vertices are interior and all cells are small and interior.

Figure 9 illustrates all cases of bad contact (contiguity); the asterisks mark submaps containing no exterior vertices, no exterior faces, and no large faces; at the vertices marked by the exclamation signs, complete collisions occur.

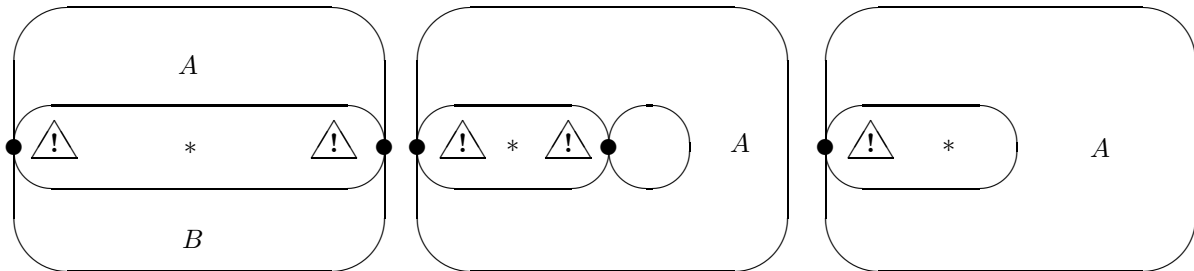

Fig. 9

**Lemma 17.** *No spherical 2-graded map with a single exterior vertex and without exterior faces admits a multiple motion with separated stops satisfying the following conditions:*

- 1) *the multiplicity of the motion is at least 4 on each large face and at least 1 on each small face;*
- 2) *at each interior point of complete collision, there are at least 2 nonadjacent corners of large cells;*
- 3) *there are no badly contacting (themselves or others) large cells.*

**Proof.** To obtain a contradiction with Lemma 16, it is sufficient to show that conditions 2) and 3) imply that

$$(the\ number\ of\ interior\ points\ of\ complete\ collision) < 3 \cdot (the\ number\ of\ large\ faces) + 1.$$

Let us take a point  $v_D$  inside each large face  $D$ . At each interior point of complete collision  $p$ , let us choose 2 nonadjacent corners  $a$  and  $b$  lying on large faces, which we call  $A$  and  $B$ , respectively. Let us draw an arc on the sphere from the point  $v_A$  through the interior of the face  $A$  via the corner  $a$  to the point  $p$  and, further, via the corner  $b$  through the interior of the face  $B$  to the point  $v_B$ . If we draw these arcs in such a way that they do not intersect each other (this is possible, of course), then we obtain a graph  $\Gamma$  on the sphere. The number of vertices of this graph equals the number of large cells of the map, and the number of edges of the graph equals the number of interior points of complete collision. To complete the proof, it remains to note that condition 3) means that the graph  $\Gamma$  satisfies the conditions of the following lemma.

**Lemma 18.** *Suppose that we have a finite (not necessarily connected) graph  $\Gamma$  on the sphere  $S^2$  such that the perimeter of each simply connected component of  $S^2 \setminus \Gamma$ , except maybe one, is at least 3. Then the number of edges of this graph is not larger than the tripled number of its vertices.*

Here, the perimeter of a region is the number of edges on the boundary of this region, where an edge is counted twice if the region lies on both sides from this edge.

**Proof.** If the graph has no edges, then we have nothing to prove. Assuming that edges exist, let us use induction on the number of connected components of  $\Gamma$ . If the graph is connected, then the Euler formula gives  $V - E + F = 2$ , where  $V$ ,  $E$ , and  $F$  are the numbers of vertices, edges, and faces of the corresponding map on the sphere. Adding one vertex inside the exceptional component and joining it by a new edge with a vertex on the boundary of this component, we obtain a map each of whose face is at least a triangle. Therefore,  $F \leq \frac{2}{3}(E + 1)$ . Hence,  $V - E + \frac{2}{3}E = V - \frac{1}{3}E \geq 2 - \frac{2}{3} = \frac{4}{3}$ . Thus, for connected graphs, the lemma is true.

If edges exist, but the graph is not connected, then we join a connected nonsingleton component with another component by a new edge. We thereby decrease the number of connected components without changing the number of vertices, and increase the number of edges; the new simply connected component of the complement to the graph has perimeter at least three. The application of the induction hypothesis completes the proof of Lemma 18 and also of Lemma 17.

We say that a map with oriented edges is of type  $B_m$ ,  $m \geq 0$ , if the sequence of pre-edge orientations of each face has one of the following three forms:

- a)  $+(+-)^{m+1}$  (Figure 6b);
- b)  $-(-+)^{m+1}$  (Figure 6c);
- c)  $((+)^{k+1}(-)^{l+1})^s$ , where  $k, l, s \geq 1$  (Figure 10).



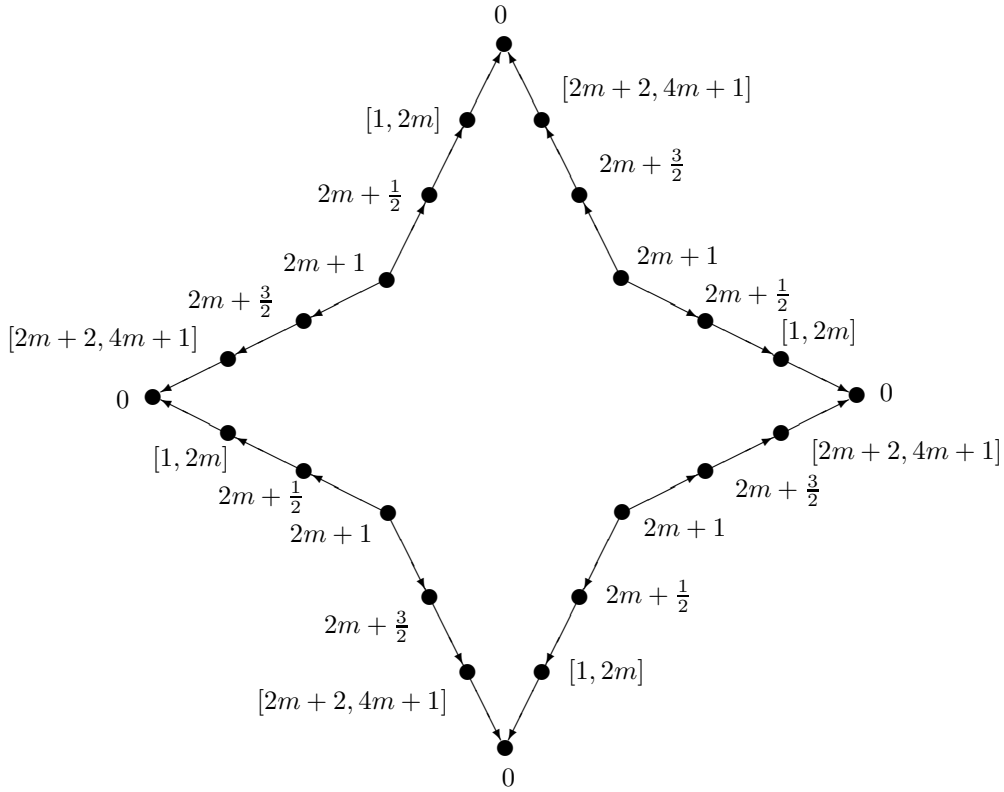

Fig. 10

Let us define the *standard multiple motion* on a map of type  $B_m$  as follows. On the faces of types  $+(+ -)^{m+1}$  and  $-(- +)^{m+1}$ , the standard motion (of multiplicity 1) coincides with the standard motion on such faces from the definition of the standard motions on maps of type  $A_m$  (Fig. 6b and 6c). On a face of type  $((+)^{k+1}(-)^{l+1})^s$ , we define an  $s$ -multiple motion as the lift of the standard motion on a face of type  $(+)^{k+1}(-)^{l+1}$  (from the definition of the standard motion on a map of type  $A_m$ ). To be more precise, there is a natural pre-edge orientation preserving  $s$ -fold covering  $\pi: \partial B \rightarrow \partial A$ , where  $B$  is a face of type  $((+)^{k+1}(-)^{l+1})^s$  and  $A$  is a face of type  $(+)^{k+1}(-)^{l+1}$ ; the standard car  $\alpha: \mathbb{R} \rightarrow \partial A$  has precisely  $s$  liftings, i.e., such functions  $\alpha_1, \dots, \alpha_s: \mathbb{R} \rightarrow \partial B$  that  $\alpha = \pi\alpha_i$ ; these functions are called the standard cars moving around  $B$ .

Figure 10 presents the schedule of the standard multiple motion on a face of type  $((+)^{k+1}(-)^{l+1})^s$  for  $k = l = 2$  and  $s = 4$ : the number near a vertex is the time (mod  $4m + 2$ ) when one of the four cars visits this vertex. In this schedule, we assume, of course, that  $m > 0$ ; for  $m = 0$ , all the 4 cars move uniformly with speed  $k + 1 = l + 1 = 3$  and visit the vertices marked by the number 0 at time zero.

**Lemma 19.** *The standard motion on a map of type  $B_m$  is a multiple motion with separated stops. Complete collisions can occur only at vertices being sources or sinks and only at integer moments of time.*

The proof of this lemma is a word-by-word repetition of the proof of Lemma 9.

## 10. Proof of the main theorem. The difficult case

As above, we assume that the group  $G$  is torsion-free and conditions (1) hold. It is sufficient to prove that  $\tilde{G}$  is nonsimple. The group  $\tilde{G}$  has presentation (2), where we assume  $P = \{1\}$ , i.e., presentation (2) has the form

$$\tilde{G} \simeq \left\langle G, t \mid ct \prod_{i=0}^m (b_i a_i^t) = 1 \right\rangle, \quad m \geq 0. \quad (4)$$

**Lemma 20.**  $G^t \cap G = \{1\}$  in  $\tilde{G}$ .

**Proof.** Assuming the contrary, by Lemma 5 (and the remark after Lemma 10) we conclude that there exists a reduced spherical diagram over presentation (4) with a single exterior face, and the label of this face is  $g^t h$ , where  $g, h \in G \setminus \{1\}$ . This diagram is a map of type  $A_m$ . It has one (exterior) cell of type  $+ -$  (Fig. 6a), the remaining cells are of types  $+(+ -)^{m+1}$  (Fig. 6b) and  $-(- +)^{m+1}$  (Fig. 6c). Consider the standard motion of period  $4m + 2$  on this map. According to the remark after Lemma 10, complete collisions can occur only at vertices  $A$  and  $B$  lying on the boundary of the

exterior face. By Lemma 4, complete collisions must happen at both these vertices. By Lemma 9, collisions can occur only in sources and sinks. Therefore, the vertex  $A$ , at which the  $(-+)$ -corner of the exterior face lies, is a source, and the vertex  $B$ , at which the  $(+-)$ -corner of the exterior face lies, is a sink. For  $m = 0$ , this implies immediately that the labels of all interior corners at the vertex  $A$  are  $a_0^{\pm 1}$  (because  $A$  is a source), but not all of these labels are equal (because  $B$  is a sink) (Fig. 11); hence, the diagram contains a reducible pair of cells and is not reduced.

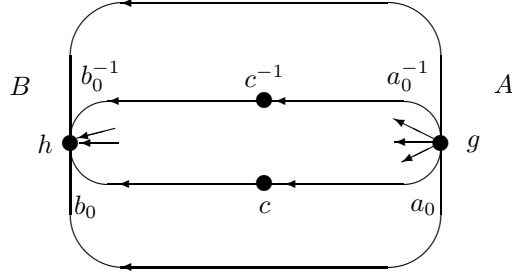

Fig. 11

If  $m > 0$ , then complete collisions cannot happen at both vertices  $A$  and  $B$ . Indeed, suppose that at the vertex  $A$  a complete collision occurs at time  $t$ . Then one car, moving around an interior face visits the vertex  $B$ , at the moment  $t_1 = t + 1$ , and another car visits  $B$  at the moment  $t_2 = t - 1$ . But  $t_1$  never equals  $t_2$  modulo the motion period, because, for  $m > 0$ , the period is larger than 2. Thus, no complete collision occurs at  $B$ . This contradiction completes the proof.

**Lemma 21.** For any  $g, h \in G$ , we have either  $\langle g \rangle^{t^2} \cap \langle h \rangle = \{1\}$  in  $\tilde{G}$  or  $\langle g \rangle^{t^3} \cap \langle h \rangle = \{1\}$  in  $\tilde{G}$ .

**Proof.** Assume the contrary:

$$g^{kt^2} = h^l, \quad g^{k't^3} = h^{l'}.$$

Let us raise these equalities to the powers  $k'$  and  $k$ , respectively:

$$g^{kk't^2} = h^{lk'}, \quad g^{kk't^3} = h^{kl'}.$$

Conjugating the first equality by  $t$ , we obtain

$$h^{lk't} = h^{kl'},$$

whence  $h = 1$  by virtue of Lemma 20 and the absence of torsion in  $G$ .

**Lemma 22.** There exists such  $d \in \{2, 3\}$  that

$$u \equiv \prod_{i=1}^s y_i x_i^{t^d} \neq 1 \text{ in } \tilde{G}$$

for any positive integer  $s$  and any  $x_i, y_i \in G$  such that  $|\{i \mid x_i \in \langle a_m \rangle\}| + |\{i \mid y_i \in \langle b_0 \rangle\}| \leq 2$  and  $u \neq 1$  in  $G * \langle t \rangle_\infty$ .

**Proof.** Let  $d$  be such number that  $\langle a_m \rangle^{t^d} \cap \langle b_0 \rangle = \{1\}$ ; such a  $d \in \{2, 3\}$  exists by Lemma 21.

Proving by contradiction, consider a counterexample with the minimal possible  $s$ . By Lemma 5 (and the remark after Lemma 10), there exists a diagram over presentation (4) on the sphere with a single exterior face whose label is  $u$ .

First, let us show that at each vertex there is at most one corner of type  $(+-)$  of the exterior face. Indeed, supposing that exterior face's corners labelled by  $y_1$  and  $y_r$  are corners at the same vertex and considering the corresponding subdiagrams, we obtain that the equality  $u = 1$  decomposes into a product of two equalities

$$\left( \prod_{i=1}^{r-1} y_i x_i^{t^d} \right) g = 1 \quad \text{and} \quad g^{-1} \prod_{i=r}^s y_i x_i^{t^d} = 1, \quad \text{where } g \in G,$$

(see Fig. 12, where  $s = 5$ ,  $d = 2$ , and  $r = 3$ ), at least one of which contradicts the minimality of the counterexample. Similarly, we can show that at each vertex, there is at most one corner of type  $(-+)$  of the exterior face.

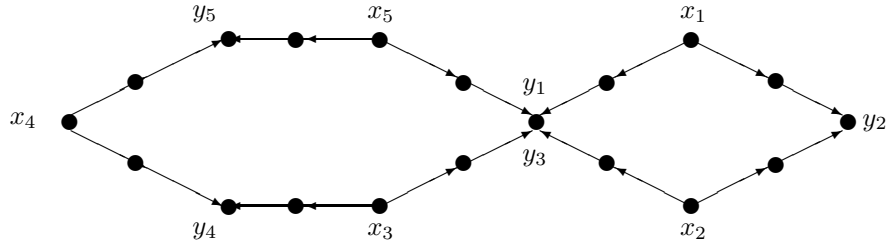

Fig. 12

Note that the diagram is a map of type  $B_m$ . Consider the standard multiple motion on this map. According to the remark after Lemma 10, complete collisions can occur only at vertices lying on the boundary of the exterior face. Moreover, by Lemma 19, a vertex of complete collision must be a source or a sink. Therefore, at each vertex of complete collision, there is exactly one corner of the exterior face, and a complete collision can occur only at the moments 0 and  $2m + 1 \pmod{4m + 2}$ , because only at these moments the cars moving around the exterior face visit corners of types  $(+-)$  and  $(-+)$ . Since in these moments all the remaining cars are at corners labelled by  $b_0^{\pm 1}$  (at the moment 0) and  $a_m^{\pm 1}$  (at the moment  $2m + 1$ ), the label of exterior face's corner at a vertex of complete collision must belong to  $\langle b_0 \rangle$  (for a corner of type  $(+-)$ ) or to  $\langle a_m \rangle$  (for a corner of type  $(-+)$ ). But the exterior face has at most two such corners. Hence, there is at most two points of complete collision. But according to Lemma 16, there must be at least  $s + 1$  such points. Therefore,  $s = 1$ , and  $u$  has the form  $b_0^k a_m^{lt^d}$ ; but such a word does not equal 1 in  $\tilde{G}$  by virtue of the choice of  $d$ . The lemma is proven.

**Lemma 23.** *There exists such  $d \in \{2, 3\}$  that the presentation*

$$\tilde{G} \simeq \left\langle G, t \mid ct \prod_{i=0}^m (b_i a_i^t) = 1, (a^{t^d} b)^4 = 1 \right\rangle, \quad \text{where } m \geq 0,$$

is aspherical for any elements  $a, b \in G$  such that  $a^2 \notin \langle a_m \rangle$  and  $b^2 \notin \langle b_0 \rangle$ .

**Proof.** Let  $d$  be the number, whose existence is asserted by Lemma 22.

Proving by contradiction, consider a spherical reduced diagram over this presentation with a single exterior vertex and without exterior faces. This diagram is a map of type  $B_m$ . Consider the standard multiple motion on this map. Let us call the cells with boundary label  $(a^{t^d} b)^{\pm 4}$  large, the other cells will be called small.

Let us show that conditions 1), 2), and 3) from Lemma 17 hold.

Condition 1) holds by the definition of the standard multiple motion.

Let us show that condition 2) holds. At each vertex of complete collision, there is at least one corner of a large cell (see the remark after Lemma 10). By Lemma 19, a vertex of complete collision must be a source or a sink; such vertices are visited by cars moving around large cells only at the moments 0 and  $2m + 1 \pmod{4m + 2}$ , because only at these moments a car moving around a large cell visits corners of types  $(+-)$  and  $(-+)$ . At these moments, the cars moving around small cells are at corners labelled  $b_0^{\pm 1}$  (at the moment 0) and  $a_m^{\pm 1}$  (in the moment  $2m + 1$ ). Therefore, the label of each corner at a vertex of complete collision is  $a_m^{\pm 1}$  or  $a^{\pm 1}$  if this vertex is a source and  $b_0^{\pm 1}$  or  $b^{\pm 1}$  if this vertex is a sink. The labels of adjacent corners are not mutually inverse, because the diagram is reduced. Suppose that condition 2) does not hold, i.e., at some interior vertex of complete collision, there is no pair of different nonadjacent corners of large cells, that is, corners with labels  $a^{\pm 1}$  or  $b^{\pm 1}$ . Suppose that this vertex is a source (the cast of a sink is quite similar). Then its label has the form

$$\text{either } a^{\pm 1} a_m^k \quad \text{or } a^{\pm 2} a_m^k, \quad \text{or } a^{\pm 3}.$$

On the other hand, this label must be 1 in  $G$ , because it is the label of an interior vertex. Thus, we have three equalities, one of which must hold in the group  $G$ . The first two of these equalities contradict the condition  $a^2 \notin \langle a_m \rangle$ , and the third contradicts the absence of torsion in  $G$ . This shows that condition 2) of Lemma 17 holds.

Suppose that condition 3) does not hold. We have a disk subdiagram (not containing the exterior vertex) whose interior cells are small and the label of the contour has the form

$$u = \prod_{i=1}^s y_i x_i^{t^d},$$

where  $s \in \mathbb{N}$ ,  $x_i, y_i \in G \setminus \{1\}$ ,  $|\{i \mid x_i \neq a^{\pm 1}\}| + |\{i \mid y_i \neq b^{\pm 1}\}| \leq 2$ , and one or two exceptional coefficients are nonzero powers of  $b_0$  or  $a_m$  (Fig. 13). This means (by Lemma 5) that  $u = 1$  in  $\tilde{G}$ , which is impossible by Lemma 22.

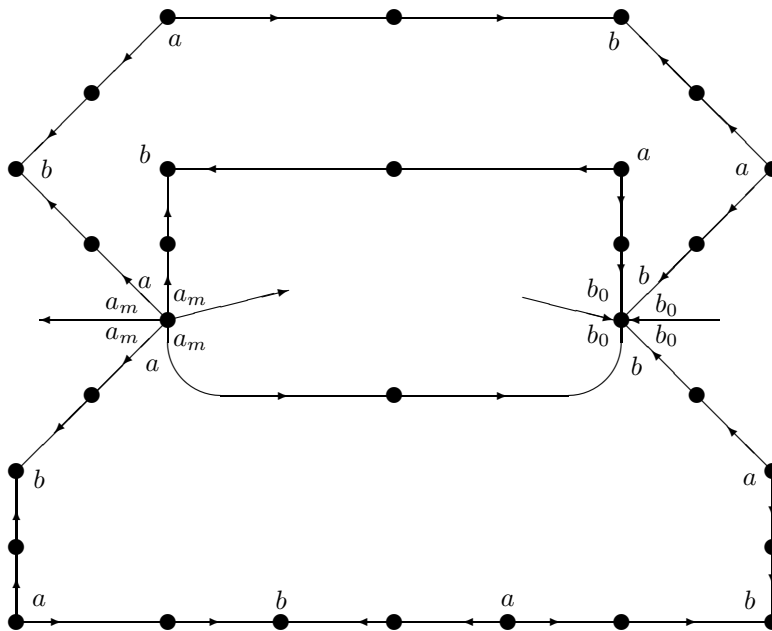

Fig. 13

Thus, the diagram under consideration has properties 1), 2), and 3) from Lemma 17, which asserts that such diagrams do not exist. This contradiction completes the proof of Lemma 23.

The assertion of the main theorem (in the difficult case) follows from Lemmata 23 and 7 and the obvious fact that if the squares of all elements of the nontrivial group  $G$  lie in the same cyclic subgroup, then  $G$  does not coincide with its commutator subgroup (because it is metabelian) and, therefore,  $\bar{G}$  does not coincide with its commutator subgroup either.

#### REFERENCES

- [CG95] Clifford A., Goldstein R. Z. Tessellations of  $S^2$  and equations over torsion-free groups // Proc. Edinburgh Math. Soc. 1995. V.38. P.485–493.
- [CG00] Clifford A., Goldstein R. Z. Equations with torsion-free coefficients // Proc. Edinburgh Math. Soc. 2000. V.43. P.295–307.
- [CR01] Cohen M. M., Rourke C. The surjectivity problem for one-generator, one-relator extensions of torsion-free groups // Geometry & Topology. 2001. V.5. P.127–142.
- [FeR96] Fenn R., Rourke C. Klyachko’s methods and the solution of equations over torsion-free groups // L’Enseignement Mathématique. 1996. T.42. P.49–74.
- [FeR98] Fenn R., Rourke C. Characterisation of a class of equations with solution over torsion-free groups, from “The Epstein Birthday Schrift”, (I. Rivin, C. Rourke and C. Series, editors), Geometry and Topology Monographs. 1998. V.1. P.159–166.
- [FoR03] Forester M., Rourke C. Diagrams and the second homotopy group. // arXiv:math.AT/0306088. v.1. 5 Jun 2003
- [GR62] Gerstenhaber M., Rothaus O. S. The solution of sets of equations in groups // Proc. Nat. Acad. Sci. USA. 1962. V.48 P.1531–1533.
- [H83] Howie J. The solution of length three equations over groups // Proc. Edinburgh Math. Soc. 1983. V.26. P.89–96.
- [K93] Klyachko Ant. A. A funny property of a sphere and equations over groups // Comm. Algebra. 1993. V.21. P.2555–2575.
- [K94] Klyachko Ant. A. Kervaire–Laudenbach conjecture and equation over groups, Cand. Sci. Dissertation, Moscow: MSU, 1994.
- [K97] Klyachko Ant. A. Asphericity tests // J. Algebra. 1997. V.7. P.415–431.
- [KP95] Klyachko Ant. A., Prishchepov M. I. The descent method for equations over groups // Moscow Univ. Math. Bull. 1995, V.50 P. 56–58.
- [LS77] Lyndon R. C., Schupp P. E. Combinatorial group theory, Springer-Verlag, Berlin/Heidelberg/New York, 1977.
- [MKS66] Magnus W., Karrass A., Solitar D. Combinatorial group theory, Interscience Publishers, John Wiley & Sons, New York/London/Sidney, 1966.