

A Hopf operad of forests of binary trees and related finite-dimensional algebras

Frédéric Chapoton

October 20, 2018

Abstract

The structure of a Hopf operad is defined on the vector spaces spanned by forests of leaf-labeled, rooted, binary trees. An explicit formula for the coproduct and its dual product is given, using a poset on forests.

0 Introduction

The theme of this paper is the algebraic combinatorics of leaf-labeled rooted binary trees and forests of such trees. We shall endow these objects with several algebraic structures.

The main structure is an operad, called the Bessel operad, which is the suspension of an operad defined by a distributive law between the suspended commutative operad and the operad of commutative non-associative algebras (sometimes called Griess algebras). The Bessel operad may be seen as an analog of the Gerstenhaber operad [9], which is the suspension of an operad defined by a distributive law between the suspended commutative operad and the Poisson operad. Unlike the Gerstenhaber operad, the Bessel operad has a simple combinatorial basis, given explicitly by forests of leaf-labeled rooted binary trees.

The Bessel operad, like the Gerstenhaber operad, is a Hopf operad. More precisely, they are both endowed with a cocommutative coproduct. This gives rise to a family of finite-dimensional coalgebras. In the dual vector spaces of the Bessel operad, one gets algebras based on forests of leaf-labeled binary trees.

An explicit formula is obtained for the coproduct in these coalgebras of forests (and therefore for their dual products), using a poset structure on the set of forests, which may be of independent interest.

The first section is devoted to the definition of a distributive law between the suspended commutative operad and the Griess operad. The suspension of the operad defined by this distributive law is introduced in the next section. The coproduct is defined and shown to be given by an explicit sum in the third section. In the fourth section, the dual algebras are briefly studied.

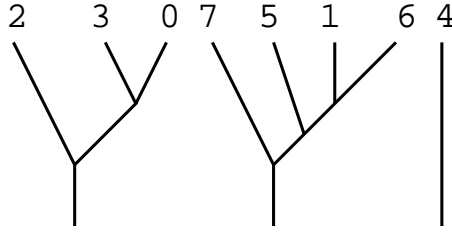

Figure 1: A forest on $\{0, 1, 2, \dots, 7\}$.

1 A distributive law

All the operads considered here are in the monoidal category of complexes of vector spaces over \mathbb{Q} with zero differential, *i.e.* the category of vector spaces over \mathbb{Q} which are graded by \mathbb{Z} , with Koszul sign rules for the tensor product. An operad [3, 7, 8] is seen through its underlying functor from the groupoid of finite sets to this monoidal category. An Hopf operad is an operad \mathcal{P} with a coassociative morphism of operad from \mathcal{P} to $\mathcal{P} \otimes \mathcal{P}$.

A *tree* is a leaf-labeled rooted binary tree and a *forest* is a set of such trees, see Fig. 1. Vertices are either inner vertices (valence 3) or leaves and roots (valence 1). By convention, edges are oriented towards the root. Leaves are bijectively labeled by a finite set. An half-edge is a pair made of an inner vertex and an incident edge (incoming or outgoing). Trees and forests are pictured with their roots down and their leaves up, but are not to be considered as planar.

1.1 The determinant operad and orientations

An *orientation* of a finite set X is a maximal exterior power of the elements of this set, *i.e.* a generator of the \mathbb{Z} -module $\Lambda^{|X|}\mathbb{Z}X$.

Let us recall the definition of the suspended commutative associative operad Det introduced by Ginzburg and Kapranov [3]. Let I be a finite set, then $\text{Det}(I)$ is the determinant vector space of $\mathbb{Q}I$. This vector space is one-dimensional, spanned by the orientations of I (for example $1 \wedge 3 \wedge 4 \wedge 2$ in $\text{Det}(\{1, 2, 3, 4\})$) and is placed in degree $|I| - 1$. The composition of the operad Det is given by the rule

$$(x \wedge \star) \circ_{\star} y = x \wedge y, \quad (1)$$

for all $x \in \text{Det}(I)$ and $y \in \text{Det}(J)$.

It is well known and easy to check that Det has the presentation by the antisymmetric generator $e_{i,j} = i \wedge j$ of degree 1 in $\text{Det}(\{i, j\})$ satisfying

$$e_{i,\star} \circ_{\star} e_{j,k} = e_{k,\star} \circ_{\star} e_{i,j}. \quad (2)$$

The operad Det is binary quadratic and Koszul, see [3] for the definitions of these notions.

1.2 The Griess operad and rooted binary trees

The operad Gri describing commutative but not necessarily associative algebras (sometimes called Griess algebras) admits the following description. The space $\text{Gri}(I)$ has a basis indexed by rooted binary trees with leaves labeled by I and the composition is grafting. This vector space is placed in degree 0. In fact, Gri is the free operad on a binary symmetric generator $\omega_{i,j}$ of degree 0 corresponding to the unique rooted binary tree with two leaves labeled by $\{i,j\}$. The operad Gri is binary quadratic and Koszul.

1.3 The operad B of root-oriented forests

For the definition and properties of the notion of distributive law from an operad to another one, see [6].

Proposition 1.1 *The following formula defines a distributive law from $\text{Gri} \circ \text{Det}$ to $\text{Det} \circ \text{Gri}$:*

$$\omega_{i,\star} \circ_{\star} e_{j,k} = e_{j,\star} \circ_{\star} \omega_{i,k} - e_{k,\star} \circ_{\star} \omega_{i,j}. \quad (3)$$

Proof. As Gri is a free operad, one has only to check that the rewriting of

$$\omega_{i,\star} \circ_{\star} (e_{j,\#} \circ_{\#} e_{k,\ell}) - \omega_{i,\star} \circ_{\star} (e_{k,\#} \circ_{\#} e_{\ell,j}), \quad (4)$$

using (3) as a replacement rule, gives zero modulo the relation (2) which defines Det. Indeed, one has

$$\begin{aligned} \omega_{i,\star} \circ_{\star} (e_{j,\#} \circ_{\#} e_{k,\ell}) &= (\omega_{i,\star} \circ_{\star} e_{j,\#}) \circ_{\#} e_{k,\ell} \\ &= (e_{j,\star} \circ_{\star} \omega_{i,\#} - e_{\#, \star} \circ_{\star} \omega_{i,j}) \circ_{\#} e_{k,\ell} \\ &= e_{j,\star} \circ_{\star} (\omega_{i,\#} \circ_{\#} e_{k,\ell}) - (e_{\#, \star} \circ_{\star} \omega_{i,j}) \circ_{\#} e_{k,\ell} \\ &= e_{j,\star} \circ_{\star} (e_{k,\#} \circ_{\#} \omega_{i,\ell} - e_{\ell,\#} \circ_{\#} \omega_{i,k}) - (e_{\#, \star} \circ_{\star} e_{k,\ell}) \circ_{\#} \omega_{i,j} \\ &= (e_{j,\star} \circ_{\star} e_{k,\#}) \circ_{\#} \omega_{i,\ell} - (e_{j,\star} \circ_{\star} e_{\ell,\#}) \circ_{\#} \omega_{i,k} - (e_{\#, \star} \circ_{\star} e_{k,\ell}) \circ_{\#} \omega_{i,j} \\ &= (e_{j,\star} \circ_{\star} e_{k,\#}) \circ_{\#} \omega_{i,\ell} + (e_{j,\star} \circ_{\star} e_{\#, \ell}) \circ_{\#} \omega_{i,k} + (e_{\#, \star} \circ_{\star} e_{k,\ell}) \circ_{\#} \omega_{i,j} \\ &= (e_{j,\star} \circ_{\star} e_{k,\#}) \circ_{\#} \omega_{i,\ell} + (e_{\ell,\star} \circ_{\star} e_{j,\#}) \circ_{\#} \omega_{i,k} + (e_{k,\star} \circ_{\star} e_{\ell,\#}) \circ_{\#} \omega_{i,j}. \end{aligned}$$

This expression is invariant by cyclic permutation of j, k, ℓ . This shows that the rewriting of (4) is zero, which proves the proposition. \blacksquare

Let us summarize the description of the operad defined by this distributive law.

Proposition 1.2 *The operad B defined on $\text{Det} \circ \text{Gri}$ by this distributive law is isomorphic to the quotient of the free operad generated by $e_{i,j}$ antisymmetric in degree 1 and $\omega_{i,j}$ symmetric in degree 0 by the following relations.*

$$e_{i,\star} \circ_{\star} e_{j,k} = e_{k,\star} \circ_{\star} e_{i,j}, \quad (5)$$

$$\omega_{i,\star} \circ_{\star} e_{j,k} = e_{j,\star} \circ_{\star} \omega_{i,k} - e_{k,\star} \circ_{\star} \omega_{i,j}. \quad (6)$$

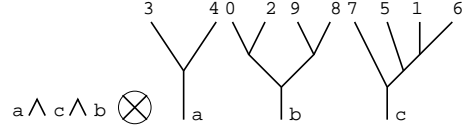

Figure 2: A root-oriented forest on $\{0, 1, 2, \dots, 9\}$.

A root-orientation of a forest F is an orientation of the set of roots of F . A *root-oriented forest* is a tensor product of a root-orientation and a forest, see Fig. 2. By the construction of B by a distributive law, the vector space $B(I)$ has a basis indexed by root-oriented forests. The degree of a root-oriented forest is the number of roots minus one.

Proposition 1.3 *The operad B is binary quadratic and Koszul.*

Proof. Koszulness follows from a theorem of Markl [6] since B is defined by a distributive law between two Koszul operads. ■

Here is a description of the composition in the generators. The generator $e_{i,j}$ acts on forests by disjoint union. Let $F_1 \sqcup F_2$ be the disjoint union of two forests F_1 and F_2 . We use (from now on) the abuse of notation $(-1)^x$ for $(-1)^{\deg(x)}$ when x is homogeneous and also $(-1)^o$ instead of $(-1)^{\deg(o)}$ for any kind of orientation o . The degree of an orientation is the number of wedge signs that it contains.

Proposition 1.4 *Let $o_1 \otimes F_1$ and $o_2 \otimes F_2$ be two root-oriented forests. Then*

$$e_{\star, \#} \circ_{\star} (o_1 \otimes F_1) \circ_{\#} (o_2 \otimes F_2) = (-1)^{o_1} o_1 \wedge o_2 \otimes (F_1 \sqcup F_2). \quad (7)$$

Proof. The proposition can be restated as follows. Let $x \in B(I)$ and $y \in B(J)$. Then

$$(e_{\star, \#} \circ_{\star} x) \circ_{\#} y = (-1)^x x \wedge y,$$

Indeed, one has $e_{\#, \star} \circ_{\star} x = \# \wedge x$ and $(x \wedge \#) \circ_{\#} y = x \wedge y$ by the composition rule of Det. The sign is given by $e_{\#, \star} = -e_{\star, \#}$ and $\# \wedge x = (-1)^{x+1} x \wedge \#$. ■

The generator $\omega_{i,j}$ acts on trees by grafting. Let $T_1 \vee T_2$ be the tree obtained by grafting T_1 and T_2 on the two leaves of the tree with one inner vertex.

Proposition 1.5 *Let $o_1 \otimes T_1$ and $o_2 \otimes T_2$ be two root-oriented trees. Then*

$$\omega_{\star, \#} \circ_{\star} (o_1 \otimes T_1) \circ_{\#} (o_2 \otimes T_2) = o \otimes (T_1 \vee T_2), \quad (8)$$

where o is the unique root-orientation of the tree $T_1 \vee T_2$.

Proof. This is just the composition of Gri, restated inside B , by definition of the composition in an operad defined by a distributive law. ■

2 The Bessel operad as a suspension

This section is devoted to the operad $\text{Bess} = \text{Det} \otimes B$ which is a suspended version of B . This suspension is necessary for the definition of a Hopf operad structure in the next section.

The generating series of the operad Bess has for coefficients the Bessel polynomials [4, 5], which are known to count the forests (sets) of rooted leaf-labeled binary trees, hence the chosen name.

2.1 Outer and inner orientations

By its definition, the vector space $\text{Bess}(I)$ has a basis indexed by tensor products $o_1 \otimes o_2 \otimes F$ where o_1 is an orientation of I and o_2 is a root-orientation of the forest F . This tensor product of two orientations is called an *outer orientation* of F . In this section, an alternative description is given for this kind of orientation, which will be more convenient later.

A *global orientation* of a forest F is an orientation of the set $V(F) \sqcup \{R_F\}$, where $V(F)$ is the set of inner vertices of F and R_F is an auxiliary element.

A *local orientation* of a forest F at an inner vertex v is an orientation of its 3 incident half-edges (which is of course equivalent to a cyclic order).

An *inner-oriented forest* is a tensor product $o \otimes \bigotimes_{v \in V(F)} o_v \otimes F$, where o is a global orientation of the forest F and the o_v are local orientations of F at its inner vertices. This will from now on be abridged $o \otimes F$, where o is a global orientation, the local orientations being implicit. Notice that the order in the product of the local orientations do not matter, as they have degree 2.

One can identify an outer orientation $o_1 \otimes o_2$ with an inner orientation in the following way.

1. Consider the exterior product $o_1 \wedge R_F \wedge o_2$ where R_F is an auxiliary element.
2. Remove from this exterior product all possible pairs $\ell \wedge r$ where ℓ is a leaf and r is a root which are related by an edge.
3. Add to this exterior product pairs $e^+ \wedge e^-$ for all edges e between two inner vertices. Here e^+ (resp. e^-) stands for the upper (resp. lower) half-edge.

The result is an exterior product on all half-edges of F and an auxiliary element R_F . One can assume that half-edges are gathered by three according to their incident inner vertex. Replacing each such triple $e_v^1 \wedge e_v^2 \wedge e_v^3$ by the vertex v , one gets a global orientation of F . One has to keep track of what has been replaced. This is done by assigning the local orientation $o_v = e_v^1 \wedge e_v^2 \wedge e_v^3$ to the inner vertex v .

Here is an example of this equivalence of orientations. Consider the outer-oriented forest shown in Fig. 3. One can compute the corresponding inner



Figure 3: An outer-oriented forest on $\{1, 2, 3, 4, 5\}$.

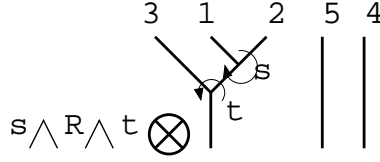

Figure 4: An inner-oriented forest on $\{1, 2, 3, 4, 5\}$.

orientation.

$$\begin{aligned}
& 1 \wedge 2 \wedge 4 \wedge 3 \wedge 5 \wedge R_F \wedge a \wedge c \wedge b \\
&= 1 \wedge 2 \wedge 3 \wedge 5 \wedge R_F \wedge a \wedge b \\
&= 1 \wedge 2 \wedge 3 \wedge R_F \wedge a \\
&= 1 \wedge 2 \wedge 3 \wedge R_F \wedge a \wedge e^+ \wedge e^- \\
&= (1 \wedge 2 \wedge e^+) \wedge R_F \wedge (3 \wedge a \wedge e^-),
\end{aligned}$$

where e^+ and e^- are the upper and lower half-edges of the unique inner edge. Hence one can take the global orientation to be $s \wedge R_F \wedge t$ (where s is the upper vertex and t the lower one) and the local orientations to be $1 \wedge 2 \wedge e^+$ at vertex s and $3 \wedge a \wedge e^-$ at vertex t . The result is shown in Fig. 4.

The grading is modified (but its parity is not changed) in order that the forests with no inner vertex are in degree 0, which will be convenient in the next section. From now on, the degree of an inner-oriented forest is the number of its inner vertices.

2.2 Presentation of Bess

From the known presentation of B , a presentation of Bess by generators and relations is given in this section.

Let $E_{i,j}$ be the inner-oriented forest with two trees on $\{i, j\}$ defined by the outer-oriented formula $E_{i,j} = (j \wedge i) \otimes e_{i,j}$. It is symmetric of degree 0. As an inner-oriented forest, it is

$$R \otimes \left| \begin{array}{c} ij \\ | \\ | \end{array} \right|. \quad (9)$$

Let $\Omega_{i,j}$ be the inner-oriented tree on $\{i, j\}$ defined by the outer-oriented formula $\Omega_{i,j} = (i \wedge j) \otimes \omega_{i,j}$. It is antisymmetric of degree 1. As an inner-oriented tree, it is given by Fig. 5.

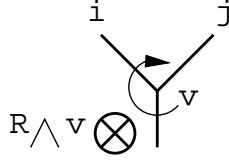

Figure 5: $\Omega_{i,j}$ as an inner-oriented tree.

Proposition 2.1 *The operad Bess is isomorphic to the quotient of the free operad on the generators $E_{i,j}$ symmetric of degree 0 and $\Omega_{i,j}$ antisymmetric of degree 1 by the relations*

$$E_{i,\star} \circ_{\star} E_{j,k} = E_{k,\star} \circ_{\star} E_{i,j}, \quad (10)$$

$$\Omega_{i,\star} \circ_{\star} E_{j,k} = E_{j,\star} \circ_{\star} \Omega_{i,k} + E_{k,\star} \circ_{\star} \Omega_{i,j}. \quad (11)$$

Proof. The tensor product by the operad Det acts essentially by changing all the signs. It is well known that the suspended operad has a presentation by similar generators and relations (up to sign) as it is simply given by a shift of grading at the level of algebras. Let us compute the new relations for our chosen generators. First,

$$\begin{aligned} E_{i,\star} \circ_{\star} E_{j,k} &= ((\star \wedge i) \otimes e_{i,\star}) \circ_{\star} ((k \wedge j) \otimes e_{j,k}) \\ &= ((i \wedge \star) \circ_{\star} (k \wedge j)) \otimes (e_{i,\star} \circ_{\star} e_{j,k}) \\ &= (i \wedge k \wedge j) \otimes (e_{i,\star} \circ_{\star} e_{j,k}). \end{aligned}$$

Therefore $E_{i,\star} \circ_{\star} E_{j,k}$ is invariant by cyclic permutation of i, j, k . One also has

$$\begin{aligned} \Omega_{i,\star} \circ_{\star} E_{j,k} &= ((i \wedge \star) \otimes \omega_{i,\star}) \circ_{\star} ((k \wedge j) \otimes e_{j,k}) \\ &= ((i \wedge \star) \circ_{\star} (k \wedge j)) \otimes (\omega_{i,\star} \circ_{\star} e_{j,k}) \\ &= (i \wedge k \wedge j) \otimes (e_{j,\star} \circ_{\star} \omega_{i,k} - e_{k,\star} \circ_{\star} \omega_{i,j}). \\ &= (j \wedge i \wedge k) \otimes (e_{j,\star} \circ_{\star} \omega_{i,k}) + (k \wedge i \wedge j) \otimes (e_{k,\star} \circ_{\star} \omega_{i,j}) \\ &= E_{j,\star} \circ_{\star} \Omega_{i,k} + E_{k,\star} \circ_{\star} \Omega_{i,j}. \end{aligned}$$

■

The action of E is then described as follows.

Proposition 2.2 *Let $o_1 \otimes F_1$ and $o_2 \otimes F_2$ be two inner-oriented forests. Then*

$$E_{\star,\#} \circ_{\star} (o_1 \otimes F_1) \circ_{\#} (o_2 \otimes F_2) = (o_1 \sqcup o_2) \otimes (F_1 \sqcup F_2), \quad (12)$$

where the global orientation $o_1 \sqcup o_2$ is obtained from $o_1 \wedge r \wedge o_2$ by replacing $R_1 \wedge r \wedge R_2$ by R . The local orientations are unchanged.

Proof. Let $o'_1 \otimes o''_1$ and $o'_2 \otimes o''_2$ be the corresponding outer orientations of F_1 and F_2 . Using Prop. 1.4, one has

$$\begin{aligned} E_{\star, \#} \circ_{\star} (o_1 \otimes F_1) \circ_{\#} (o_2 \otimes F_2) &= ((\# \wedge \star) \otimes e_{\star, \#}) \circ_{\star} (o'_1 \otimes o''_1 \otimes F_1) \circ_{\#} (o'_2 \otimes o''_2 \otimes F_2) \\ &= (-1)^{o'_1 + o'_2 + o'_2 o''_1} ((\# \wedge \star) \circ_{\star} o'_1 \circ_{\#} o'_2) \otimes (e_{\star, \#} \circ_{\star} (o''_1 \otimes F_1) \circ_{\#} (o''_2 \otimes F_2)) \\ &= (-1)^{(1+o''_1)(1+o'_2)} o'_1 \wedge o'_2 \otimes o''_1 \wedge o''_2 \otimes (F_1 \sqcup F_2). \end{aligned}$$

Hence the corresponding inner orientation is given by

$$(-1)^{(1+o''_1)(1+o'_2)} o'_1 \wedge o'_2 \wedge R \wedge o''_1 \wedge o''_2.$$

On the other hand, let us compute the orientation corresponding to $o_1 \sqcup o_2$.

$$o'_1 \wedge R_1 \wedge o''_1 \wedge r \wedge o'_2 \wedge R_2 \wedge o''_2 = (-1)^{(1+o''_1)(1+o'_2)} o'_1 \wedge o'_2 \wedge R \wedge o''_1 \wedge o''_2.$$

Therefore the two orientations are the same. \blacksquare

The action of Ω on trees has the following description.

Proposition 2.3 *Let $o_1 \otimes T_1$ and $o_2 \otimes T_2$ be two inner-oriented trees. Then*

$$\Omega_{\star, \#} \circ_{\star} (o_1 \otimes T_1) \circ_{\#} (o_2 \otimes T_2) = (o_1 \vee o_2) \otimes (T_1 \vee T_2), \quad (13)$$

where the global orientation $o_1 \vee o_2$ is defined by $(-1)^{o_1} o_1 \wedge o_2$ modulo $R_1 \wedge R_2 = R \wedge v$ where v is the inner vertex of Ω . The local orientations are unchanged.

Proof. Let $o'_1 \otimes \text{root}_1$ and $o'_2 \otimes \text{root}_2$ be the corresponding outer orientations of T_1 and T_2 . Using Prop. 1.5, one has

$$\begin{aligned} \Omega_{\star, \#} \circ_{\star} (o'_1 \otimes \text{root}_1 \otimes T_1) \circ_{\#} (o'_2 \otimes \text{root}_2 \otimes T_2) \\ &= ((\star \wedge \#) \circ_{\star} o'_1 \circ_{\#} o'_2) \otimes (\omega_{\star, \#} \circ_{\star} \text{root}_1 \otimes T_1 \circ_{\#} \text{root}_2 \otimes T_2) \\ &= (-1)^{o'_1} (o'_1 \wedge o'_2) \otimes \text{root} \otimes (T_1 \vee T_2). \end{aligned}$$

So the corresponding orientation is $(-1)^{o'_1} o'_1 \wedge o'_2 \wedge R \wedge \text{root}$. Introducing pairs of half-edges gives

$$(-1)^{o'_1} o'_1 \wedge o'_2 \wedge R \wedge \text{root} \wedge \text{root}_1 \wedge e_1^- \wedge \text{root}_2 \wedge e_2^-,$$

where e_1^- and e_2^- are lower half-edges. This is equivalent with the local orientation $(\text{root} \wedge e_1^- \wedge e_2^-)$ at vertex v (which is the local orientation of Ω , see figure 5) and orientation

$$(-1)^{o'_1} o'_1 \wedge o'_2 \wedge R \wedge \text{root}_1 \wedge v \wedge \text{root}_2.$$

On the other hand, the proposed orientation is

$$(-1)^{o_1} o'_1 \wedge R_1 \wedge \text{root}_1 \wedge o'_2 \wedge R_2 \wedge \text{root}_2 = (-1)^{o_1} o'_1 \wedge o'_2 \wedge R_1 \wedge \text{root}_1 \wedge R_2 \wedge \text{root}_2.$$

This matches the computed orientation, as $R_1 \wedge R_2 = R \wedge v$ and $(-1)^{o_1} = (-1)^{o'_1}$. \blacksquare

Let us extend the definition of \vee from trees to forests, as follows. Let $F_1 = T_1^1 \sqcup T_1^2 \sqcup \dots \sqcup T_1^m$ and $F_2 = T_2^1 \sqcup T_2^2 \sqcup \dots \sqcup T_2^n$ be forests, where the T are trees. Define $F_1 \vee F_2$ to be the sum

$$\sum_{1 \leq a \leq m} \sum_{1 \leq b \leq n} (T_1^a \vee T_2^b) \sqcup T_1^1 \sqcup \dots \sqcup \widehat{T_1^a} \sqcup \dots \sqcup T_2^2 \sqcup \dots \sqcup \widehat{T_2^b} \sqcup \dots,$$

where \widehat{T} means that this term is absent. In words, $F_1 \vee F_2$ is the sum over all possible pairings of a tree from T_1 and a tree from T_2 , where these two trees are replaced in the disjoint union $F_1 \sqcup F_2$ by their \vee product.

Then Prop. 2.3 is still true for forests instead of just trees, with the extended definition just given for \vee .

Proposition 2.4 *Let $o_1 \otimes F_1$ and $o_2 \otimes F_2$ be two inner-oriented forests. Then*

$$\Omega_{\star, \#} \circ_{\star} (o_1 \otimes F_1) \circ_{\#} (o_2 \otimes F_2) = (o_1 \vee o_2) \otimes (F_1 \vee F_2), \quad (14)$$

where the global orientation $o_1 \vee o_2$ is defined by $(-1)^{o_1} o_1 \wedge o_2$ modulo $R_1 \wedge R_2 = R \wedge v$ where v is the inner vertex of Ω . The local orientations are unchanged.

Proof. By recursion on the total number of trees in F_1 and F_2 . The proposition is true if F_1 and F_2 are trees. Let us assume that F_2 has at least two trees.

One the one hand,

$$\begin{aligned} & \Omega_{\star, \#} \circ_{\star} (o_1 \otimes F_1) \circ_{\#} ((o_2 \sqcup o_3) \otimes (F_2 \sqcup F_3)) \\ &= \Omega_{\star, \#} \circ_{\star} (o_1 \otimes F_1) \circ_{\#} (E_{\Delta, \infty} \circ_{\Delta} (o_2 \otimes F_2) \circ_{\infty} (o_3 \otimes F_3)) \\ &= \Omega_{\star, \#} \circ_{\#} E_{\Delta, \infty} \circ_{\star} (o_1 \otimes F_1) \circ_{\Delta} (o_2 \otimes F_2) \circ_{\infty} (o_3 \otimes F_3) \\ &= (E_{\Delta, \#} \circ_{\#} \Omega_{\star, \infty} + E_{\infty, \#} \circ_{\#} \Omega_{\star, \Delta}) \circ_{\star} (o_1 \otimes F_1) \circ_{\Delta} (o_2 \otimes F_2) \circ_{\infty} (o_3 \otimes F_3) \\ &= (-1)^{o_2 o_3} E_{\Delta, \#} \circ_{\#} \Omega_{\star, \infty} \circ_{\star} (o_1 \otimes F_1) \circ_{\infty} (o_3 \otimes F_3) \circ_{\Delta} (o_2 \otimes F_2) \\ &\quad + E_{\infty, \#} \circ_{\#} \Omega_{\star, \Delta} \circ_{\star} (o_1 \otimes F_1) \circ_{\Delta} (o_2 \otimes F_2) \circ_{\infty} (o_3 \otimes F_3) \\ &= (-1)^{o_2 o_3} E_{\Delta, \#} \circ_{\#} ((o_1 \vee o_3) \otimes (F_1 \vee F_3)) \circ_{\Delta} (o_2 \otimes F_2) \\ &\quad + E_{\infty, \#} \circ_{\#} ((o_1 \vee o_2) \otimes (F_1 \vee F_2)) \circ_{\infty} (o_3 \otimes F_3) \\ &= (-1)^{o_2 o_3} ((o_1 \vee o_3) \sqcup o_2) \otimes ((F_1 \vee F_3) \sqcup F_2) + ((o_1 \vee o_2) \sqcup o_3) \otimes ((F_1 \vee F_2) \sqcup F_3). \end{aligned}$$

On the other hand, the definition of \vee implies that

$$\begin{aligned} & (o_1 \vee (o_2 \sqcup o_3)) \otimes (F_1 \vee (F_2 \sqcup F_3)) \\ &= (o_1 \vee (o_2 \sqcup o_3)) \otimes ((F_1 \vee F_3) \sqcup F_2) + (o_1 \vee (o_2 \sqcup o_3)) \otimes ((F_1 \vee F_2) \sqcup F_3). \end{aligned}$$

So it remains to compare the orientations. Using their defining properties, it is easy to see that

$$(-1)^{o_2 o_3} (o_1 \vee o_3) \sqcup o_2 = o_1 \vee (o_2 \sqcup o_3) = (o_1 \vee o_2) \sqcup o_3.$$

The proposition is proved. ■

3 A coproduct on Bess

In this section, a map from Bess to Bess \otimes Bess is first defined on generators, then shown to be given by an explicit formula.

3.1 Definition on generators

Let us define a coproduct $\Delta : \text{Bess} \rightarrow \text{Bess} \otimes \text{Bess}$ on the generators $E_{i,j}$ and $\Omega_{i,j}$ of Bess by

$$\Delta(E_{i,j}) = E_{i,j} \otimes E_{i,j}, \quad (15)$$

$$\Delta(\Omega_{i,j}) = E_{i,j} \otimes \Omega_{i,j} + \Omega_{i,j} \otimes E_{i,j}. \quad (16)$$

Proposition 3.1 *These formulas define a coassociative cocommutative morphism of operad from Bess to Bess \otimes Bess, i.e. the structure of a Hopf operad on Bess. In particular, each Bess(I) inherits a structure of cocommutative coalgebra.*

Proof. Coassociativity and cocommutativity are clear on generators. One has to check that the relations (10) and (11) of Bess are annihilated by Δ . First,

$$\Delta(E_{i,\star} \circ_{\star} E_{j,k}) = (E_{i,\star} \otimes E_{i,\star}) \circ_{\star} (E_{j,k} \otimes E_{j,k}) = (E_{i,\star} \circ_{\star} E_{j,k}) \otimes (E_{i,\star} \circ_{\star} E_{j,k}),$$

which inherits the invariance of $E_{i,\star} \circ_{\star} E_{j,k}$ under cyclic permutations of i, j, k . Hence Δ vanishes on the relation (10). For the other relation, on the one hand

$$\begin{aligned} \Delta(\Omega_{i,\star} \circ_{\star} E_{j,k}) &= (E_{i,\star} \otimes \Omega_{i,\star} + \Omega_{i,\star} \otimes E_{i,\star}) \circ_{\star} (E_{j,k} \otimes E_{j,k}) \\ &= (E_{i,\star} \otimes \Omega_{i,\star}) \circ_{\star} (E_{j,k} \otimes E_{j,k}) + (\Omega_{i,\star} \otimes E_{i,\star}) \circ_{\star} (E_{j,k} \otimes E_{j,k}) \\ &= (E_{i,\star} \circ_{\star} E_{j,k}) \otimes (\Omega_{i,\star} \circ_{\star} E_{j,k}) + (\Omega_{i,\star} \circ_{\star} E_{j,k}) \otimes (E_{i,\star} \circ_{\star} E_{j,k}) \\ &= (E_{i,\star} \circ_{\star} E_{j,k}) \otimes (E_{j,\star} \circ_{\star} \Omega_{i,k}) + (E_{i,\star} \circ_{\star} E_{j,k}) \otimes (E_{k,\star} \circ_{\star} \Omega_{i,j}) \\ &\quad + (E_{j,\star} \circ_{\star} \Omega_{i,k}) \otimes (E_{i,\star} \circ_{\star} E_{j,k}) + (E_{k,\star} \circ_{\star} \Omega_{i,j}) \otimes (E_{i,\star} \circ_{\star} E_{j,k}). \end{aligned}$$

On the other hand,

$$\begin{aligned} \Delta(E_{j,\star} \circ_{\star} \Omega_{i,k}) &= (E_{j,\star} \otimes E_{j,\star}) \circ_{\star} (E_{i,k} \otimes \Omega_{i,k} + \Omega_{i,k} \otimes E_{i,k}) \\ &= (E_{j,\star} \circ_{\star} E_{i,k}) \otimes (E_{j,\star} \circ_{\star} \Omega_{i,k}) + (E_{j,\star} \circ_{\star} \Omega_{i,k}) \otimes (E_{j,\star} \circ_{\star} E_{i,k}) \\ &= (E_{i,\star} \circ_{\star} E_{j,k}) \otimes (E_{j,\star} \circ_{\star} \Omega_{i,k}) + (E_{j,\star} \circ_{\star} \Omega_{i,k}) \otimes (E_{i,\star} \circ_{\star} E_{j,k}), \end{aligned}$$

and a similar formula holds for $\Delta(E_{k,\star} \circ_{\star} \Omega_{i,j})$. From these formulas, it is clear that Δ vanishes on relation (11). This proves the proposition. \blacksquare

3.2 A poset on forests

There is an explicit formula for the coproduct, which is a sum over subsets of the set of inner vertices. A poset on forests involved in this formula is described first.

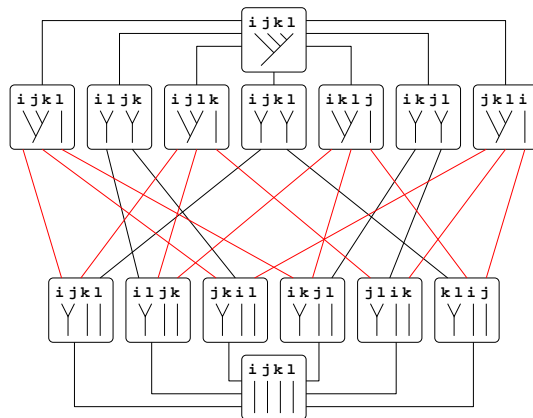

Figure 6: An interval in the poset of forests on $\{i, j, k, \ell\}$.

A leaf is an *ancestor* of a vertex if there is path from the leaf to the root going through the vertex.

Let F and F' be two forests on the set I . Then $F' \leq F$ if there is a topological map from F' to F with the following properties :

1. It is increasing with respect to orientation towards the root.
2. It maps inner vertices to inner vertices injectively.
3. It restricts to the identity on leaves.

In fact, such a topological map from F' to F is determined by the image of inner vertices of F' . Indeed one can recover the map by joining the image of an inner vertex with its ancestor leaves in F' .

This relation defines a partial order on the set of forests on I . The maximal elements of this poset are the trees. This poset is ranked by the number of inner vertices. Fig. 6 displays an interval in the poset of forests on the set $\{i, j, k, \ell\}$.

Remark : As can be seen on Fig. 6, the interval in this poset between the minimal element and one of the “comb” trees (which have a leaf with all the inner vertices belonging to its path to the root) can be identified to the partition lattice. The proof is by identifying a forest with the partition of the set of leaves defined by its trees. Details will be given elsewhere.

If F is a forest on the set I and V is a subset of the set $V(F)$ of inner vertices of F , let $\gamma(F, V)$ be the sum of forests F' such that $F' \leq F$ and the inner vertices of F' are identified with the elements of V . The sum $\gamma(F, V)$, which is an element of the free \mathbb{Z} -module generated by the set of forests on the finite set I , can also be considered as a set, as it has no multiplicity. Indeed, there is at most one way to complete a injection of inner vertices into a topological map from a given forest F' to a given forest F .

Lemma 3.2 *Let \sqcup and \vee be the bilinear extensions of the operations \sqcup and \vee on forests.*

1. *Let $T = T_1 \vee T_2$ be a tree and $V' = \{v\} \sqcup V'_1 \sqcup V'_2$ be a subset of $V(T)$ containing the bottom vertex v . Then $\gamma(T, V') = \gamma(T_1, V'_1) \vee \gamma(T_2, V'_2)$.*
2. *Let $T = T_1 \vee T_2$ be a tree and $V' = V'_1 \sqcup V'_2$ be a subset of $V(T)$ not containing the bottom vertex v . Then $\gamma(T, V') = \gamma(T_1, V'_1) \sqcup \gamma(T_2, V'_2)$.*
3. *Let $F = F_1 \sqcup F_2$ be a forest and $V' = V'_1 \sqcup V'_2$ be a subset of $V(F)$. Then $\gamma(F, V') = \gamma(F_1, V'_1) \sqcup \gamma(F_2, V'_2)$.*

Proof. The second and third cases are essentially the same and easy consequences of the definition of the poset. If two sets V_1, V_2 of inner vertices of a forest F have no ancestor leaf in common, then the set $\gamma(F, V_1 \sqcup V_2)$ is in bijection with the product $\gamma(F, V_1) \times \gamma(F, V_2)$. For γ seen as a sum, this gives the expected result.

The first case now. Any element of $\gamma(T, V')$ is a forest F with inner vertices V' . This forest can be restricted to V'_1 and to V'_2 to give two forests F_1 and F_2 . To be able to recover the forest F from F_1 and F_2 , it is necessary and sufficient to know to which tree of F_1 and to which tree of F_2 the vertex v was connected in F . Therefore the set $\gamma(T, V')$ is in bijection with the set of quadruples $(F_1, \alpha, F_2, \beta)$ where F_1 and F_2 are in $\gamma(T_1, V'_1)$ and $\gamma(T_2, V'_2)$, α is a tree of F_1 and β is a tree of F_2 .

Therefore, seen as a sum, $\gamma(T, V')$ is exactly given by the bilinear extension of the operation \vee on forests, which is a sum over the set of pairs of subtrees. ■

3.3 Explicit formula for the coproduct

Proposition 3.3 *Let $o \otimes F$ be an inner-oriented forest. Then*

$$\Delta(o \otimes F) = \sum_{V(F)=V' \sqcup V''} (o' \otimes \gamma(F, V')) \otimes (o'' \otimes \gamma(F, V'')). \quad (17)$$

where the local orientations are unchanged and the global orientations satisfy $o' \wedge r \wedge o'' = o$ modulo $R' \wedge r \wedge R'' = R$.

Proof. The proof is a recursion on the number of inner vertices. The proposition is clear for trees with no inner vertex. The proof of the recursion step is done separately for trees and for forests with at least two trees.

The case of trees Let $o_1 \otimes T_1$ and $o_2 \otimes T_2$ be two inner-oriented trees and let $o \otimes T = (o_1 \vee o_2) \otimes (T_1 \vee T_2)$. Then

$$\begin{aligned} \Delta(o \otimes T) &= \Delta(\Omega_{\star, \#} \circ_{\star} (o_1 \otimes T_1) \circ_{\#} (o_2 \otimes T_2)) \\ &= \sum_{V(T_1)=V'_1 \sqcup V''_1} \sum_{V(T_2)=V'_2 \sqcup V''_2} (\Omega_{\star, \#} \otimes E_{\star, \#} + E_{\star, \#} \otimes \Omega_{\star, \#}) \\ &\quad \circ_{\star} (o'_1 \otimes \gamma'_1 \otimes o''_1 \otimes \gamma''_1) \circ_{\#} (o'_2 \otimes \gamma'_2 \otimes o''_2 \otimes \gamma''_2), \quad (18) \end{aligned}$$

where γ_i^* stands for $\gamma(T_i, V_i^*)$.

The first half of this formula corresponding to the expansion of the composition in $\Omega_{\star, \#} \otimes E_{\star, \#}$ is given by

$$\begin{aligned} & \sum_{V(T_1)=V'_1 \sqcup V''_1} \sum_{V(T_2)=V'_2 \sqcup V''_2} (-1)^{o'_2 o'_1} \\ & (\Omega_{\star, \#} \circ_{\star} (o'_1 \otimes \gamma'_1) \circ_{\#} (o'_2 \otimes \gamma'_2)) \otimes (E_{\star, \#} \circ_{\star} (o''_1 \otimes \gamma''_1) \circ_{\#} (o''_2 \otimes \gamma''_2)) \\ & = \sum_{V(T_1)=V'_1 \sqcup V''_1} \sum_{V(T_2)=V'_2 \sqcup V''_2} (-1)^{o'_2 o'_1} \bar{o}' \otimes (\gamma'_1 \vee \gamma'_2) \otimes \bar{o}'' \otimes (\gamma''_1 \sqcup \gamma''_2), \end{aligned} \quad (19)$$

the orientations satisfying

$$\begin{aligned} o'_1 \wedge r_1 \wedge o''_1 &= o_1 & R'_1 \wedge r_1 \wedge R''_1 &= R_1 \\ o'_2 \wedge r_2 \wedge o''_2 &= o_2 & R'_2 \wedge r_2 \wedge R''_2 &= R_2 \\ (-1)^{o'_1} o'_1 \wedge o'_2 &= \bar{o}' & R' \wedge s &= R'_1 \wedge R'_2 \\ o''_1 \wedge r'' \wedge o''_2 &= \bar{o}'' & R'' \wedge s &= R''_1 \wedge R''_2. \end{aligned}$$

On the other hand, one has to compute

$$\sum_{\substack{V(T)=V' \sqcup V'' \\ v \in V'}} o' \otimes \gamma(T, V') \otimes o'' \otimes \gamma(T, V''). \quad (20)$$

As $V(T) = \{v\} \sqcup V(T_1) \sqcup V(T_2)$, one can replace the sum by a double sum, using Lemma 3.2 :

$$\sum_{V(T_1)=V'_1 \sqcup V''_1} \sum_{V(T_2)=V'_2 \sqcup V''_2} o' \otimes (\gamma'_1 \vee \gamma'_2) \otimes o'' \otimes (\gamma''_1 \sqcup \gamma''_2),$$

with the orientations determined by

$$\begin{aligned} o' \wedge r \wedge o'' &= o_1 \vee o_2 & R' \wedge r \wedge R'' &= R \\ (-1)^{o_1} o_1 \wedge o_2 &= o_1 \vee o_2 & R_1 \wedge R_2 &= R \wedge s. \end{aligned}$$

All these conditions on orientations together imply that the orientations $o' \otimes o''$ and $(-1)^{o'_2 o'_1} \bar{o}' \otimes \bar{o}''$ are the same. Therefore (19) and (20) are equal.

The other half of the sum (18), corresponding to the expansion of the composition in $E_{\star, \#} \otimes \Omega_{\star, \#}$, is shown in the same way to be equal to

$$\sum_{\substack{V(T)=V' \sqcup V'' \\ v \in V''}} o' \otimes \gamma(T, V') \otimes o'' \otimes \gamma(T, V''). \quad (21)$$

Therefore the full sum (18) is given by the expected formula (17) and the recursion step is done for trees.

The case of true forests Let $o_1 \otimes F_1$ and $o_2 \otimes F_2$ be two inner-oriented forests and let $o \otimes F = (o_1 \sqcup o_2) \otimes (F_1 \sqcup F_2)$. One has

$$\begin{aligned}
\Delta(o \otimes F) &= \Delta(E_{\star, \#} \circ_{\star} o_1 \otimes F_1 \circ_{\#} o_2 \otimes F_2) \\
&= \sum_{V_1=V'_1 \sqcup V''_1} \sum_{V_2=V'_2 \sqcup V''_2} (E_{\star, \#} \otimes E_{\star, \#}) \circ_{\star} (o'_1 \otimes \gamma'_1 \otimes o''_1 \otimes \gamma''_1) \circ_{\#} (o'_2 \otimes \gamma'_2 \otimes o''_2 \otimes \gamma''_2) \\
&= \sum_{V_1=V'_1 \sqcup V''_1} \sum_{V_2=V'_2 \sqcup V''_2} (-1)^{o'_2 o''_1} (E_{\star, \#} \circ_{\star} o'_1 \otimes \gamma'_1 \circ_{\#} o'_2 \otimes \gamma'_2) \otimes (E_{\star, \#} \circ_{\star} o''_1 \otimes \gamma''_1 \circ_{\#} o''_2 \otimes \gamma''_2) \\
&= \sum_{V_1=V'_1 \sqcup V''_1} \sum_{V_2=V'_2 \sqcup V''_2} (-1)^{o'_2 o''_1} \bar{o}' \otimes (\gamma'_1 \sqcup \gamma'_2) \otimes \bar{o}'' \otimes (\gamma''_1 \sqcup \gamma''_2), \quad (22)
\end{aligned}$$

where γ_i^* stands for $\gamma(F_i, V_i^*)$ and the orientations satisfy

$$\begin{aligned}
o'_1 \wedge r_1 \wedge o''_1 &= o_1 & R'_1 \wedge r_1 \wedge R''_1 &= R_1 \\
o'_2 \wedge r_2 \wedge o''_2 &= o_2 & R'_2 \wedge r_2 \wedge R''_2 &= R_2 \\
o'_1 \wedge r' \wedge o'_2 &= \bar{o}' & R'_1 \wedge r' \wedge R'_2 &= R' \\
o''_1 \wedge r'' \wedge o''_2 &= \bar{o}'' & R''_1 \wedge r'' \wedge R''_2 &= R''.
\end{aligned}$$

On the other hand, one has to compute

$$\sum_{V(F)=V' \sqcup V''} o' \otimes \gamma(F, V') \otimes o'' \otimes \gamma(F, V''). \quad (23)$$

As $V(F) = V(F_1) \sqcup V(F_2)$, one can replace the summation by two separate summations, using Lemma 3.2 :

$$\sum_{V(F_1)=V'_1 \sqcup V''_1} \sum_{V(F_2)=V'_2 \sqcup V''_2} o' \otimes (\gamma'_1 \sqcup \gamma'_2) \otimes o'' \otimes (\gamma''_1 \sqcup \gamma''_2), \quad (24)$$

with the orientations satisfying

$$\begin{aligned}
o' \wedge r \wedge o'' &= o_1 \sqcup o_2 & R' \wedge r \wedge R'' &= R \\
o_1 \wedge r_{12} \wedge o_2 &= o_1 \sqcup o_2 & R_1 \wedge r_{12} \wedge R_2 &= R.
\end{aligned}$$

One can then show by using all the conditions above that the orientations $o' \otimes o''$ and $(-1)^{o'_2 o''_1} \bar{o}' \otimes \bar{o}''$ are the same, which implies that (22) and (23) are equal. The recursion step is done for forests.

The proposition is proved. \blacksquare

Proposition 3.4 *The projection to the one-dimensional degree zero component is a counit. The inclusion of this degree zero component is an augmentation.*

Proof. For a finite set I , there is just one forest of degree zero, which has no inner vertex. By inspection of the formula for the coproduct, this forest is grouplike. The second part of the proposition follows. This forest can only be obtained in the coproduct of F for the two summands given by $V(F) \sqcup \emptyset$ and $\emptyset \sqcup V(F)$, and the counit property is easily checked. \blacksquare

4 Algebras of labeled binary trees

As it is sometimes more convenient to work with algebras rather than coalgebras, we introduce here the algebra structure on the dual vector space of $\text{Bess}(I)$.

4.1 Description and properties

Let us consider the dual basis, still indexed by inner-oriented forests, of the dual vector space $\text{Bess}^*(I)$, defined by the following pairing from $\text{Bess}(I) \otimes \text{Bess}^*(I)$ to \mathbb{Q} .

$$\langle o \otimes F, o' \otimes F' \rangle = \begin{cases} 0 & \text{if } F \neq F', \\ 1 & \text{if } F = F' \text{ and } o = o'. \end{cases}$$

The induced pairing from $\text{Bess}(I) \otimes \text{Bess}(I) \otimes \text{Bess}^*(I) \otimes \text{Bess}^*(I)$ to \mathbb{Q} is denoted again by $\langle \rangle$.

It appears to be more convenient to use the opposite of the dual product.

Proposition 4.1 *The opposite of the dual product is given by*

$$(o_1 \otimes F_1) \times (o_2 \otimes F_2) = \sum_{(F, V_1 \sqcup V_2)} o \otimes F, \quad (25)$$

where the orientations satisfy $o_1 \wedge r \wedge o_2 = o$ and $R_1 \wedge r \wedge R_2 = R$, the sum being over the set of pairs $(F, V_1 \sqcup V_2)$ where F is a forest and $V(F) = V_1 \sqcup V_2$ a partition of the set of inner vertices of F such that F_1 appears in $\gamma(F, V_1)$ and F_2 appears in $\gamma(F, V_2)$.

Proof. The defining property of the dual product \times^{op} is

$$\langle o_1 \otimes F_1 \otimes o_2 \otimes F_2, \Delta(o \otimes F) \rangle = \langle (o_1 \otimes F_1) \times^{op} (o_2 \otimes F_2), o \otimes F \rangle. \quad (26)$$

Let $\Delta(o \otimes F) = \sum o' \otimes \gamma' \otimes o'' \otimes \gamma''$, with the orientations given by $o' \wedge r \wedge o'' = o$ and $R' \wedge r \wedge R'' = R$. The left hand-side of (26) can be computed as follows.

$$\begin{aligned} & \sum \langle o_1 \otimes F_1 \otimes o_2 \otimes F_2, o' \otimes \gamma' \otimes o'' \otimes \gamma'' \rangle \\ &= \sum (-1)^{o' o_2} \langle o_1 \otimes F_1, o' \otimes \gamma' \rangle \langle o_2 \otimes F_2, o'' \otimes \gamma'' \rangle \\ &= (-1)^{o_1 o_2} \delta_{o', o_1} \delta_{F_1 \in \gamma'} \delta_{o'', o_2} \delta_{F_2 \in \gamma''}, \end{aligned}$$

where $\delta_{F \in \gamma}$ is 1 if F belongs to the set/sum γ and else 0, and the orientations are identified in an obvious way. Here was used the fact that the sum $\gamma(F, V)$ is without multiplicity.

Therefore, as taking the opposite product exactly removes the sign $(-1)^{o_1 o_2}$, one has

$$\langle (o_1 \otimes F_1) \times (o_2 \otimes F_2), o \otimes F \rangle = \delta_{o', o_1} \delta_{F_1 \in \gamma'} \delta_{o'', o_2} \delta_{F_2 \in \gamma''}.$$

The proposition follows. ■

Let the *support* of a forest F , denoted by $\text{Supp}(F)$, be the set of leaves which are not linked to the root by an edge, *i.e.* such that the path to the root contains at least one inner vertex.

Lemma 4.2 *Let F be any forest appearing in the product of F_1 and F_2 . Then $\text{Supp}(F) = \text{Supp}(F_1) \cup \text{Supp}(F_2)$.*

Proposition 4.3 *Let F_1, F_2 be two forests with disjoint supports. Then the only forest appearing in the product of F_1 and F_2 is the forest F with $\text{Supp}(F) = \text{Supp}(F_1) \sqcup \text{Supp}(F_2)$ which coincides with F_1 and F_2 on their respective support.*

Proof. Any forest appearing in the product should have support the disjoint union of supports. The condition that $F_1 \leq F$ implies that the number of inner vertices of F which are linked to the support of F_1 is greater or equal than the number of inner vertices of F_1 . The same is true for F_2 and its support. But the number of inner vertices of F is the sum of those of F_1 and F_2 , therefore there is equality and the proposition follows. ■

Let $Y_{i,j}$ be the element of $\text{Bess}^*(I)$ corresponding to the forest with one inner vertex, with support $\{i, j\}$ and orientation as in Fig. 5.

Lemma 4.4 *Let F be a forest with $j \notin \text{Supp}(F)$. Then the forests appearing in $F \times Y_{i,j}$ are exactly all forests obtained from F by grafting a leaf j to any edge in the path from i to the root.*

Proof. It is clear that each such forest do appear in the product. We need only to show that there are no others. The forests which appear should have a vertex with leaves i and j as ancestors. As j do not belong to the support of F , this vertex should be added to F . It can only be added on an edge of the path from i to the root. ■

4.2 Some relations and open questions

Let us introduce some notation. Let $\text{LLL}(i, j, k, \ell)$ be the inner-oriented forest on any set I containing $\{i, j, k, \ell\}$, which is defined on its support $\{i, j, k, \ell\}$ by the same orientations and tree as Fig. 7.

Let $\text{Y}_Y\text{Y}(i, j, k, \ell)$ be the inner-oriented forest on any set I containing $\{i, j, k, \ell\}$, which is defined on its support $\{i, j, k, \ell\}$ by the same orientations and tree as Fig. 8.

Lemma 4.5 *One has*

$$\text{LLL}(i, j, k, \ell) = -\text{LLL}(i, j, \ell, k), \quad (27)$$

$$\text{Y}_Y\text{Y}(i, j, k, \ell) = -\text{Y}_Y\text{Y}(i, j, \ell, k), \quad (28)$$

$$\text{Y}_Y\text{Y}(i, j, k, \ell) = \text{Y}_Y\text{Y}(k, \ell, i, j). \quad (29)$$

The following relations are satisfied in any algebra $\text{Bess}^*(I)$.

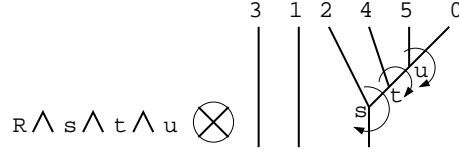

Figure 7: LLL(2, 4, 5, 0) on $\{0, 1, 2, 3, 4, 5\}$.

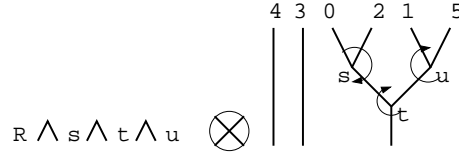

Figure 8: $Y_Y Y(0, 2, 1, 5)$ on $\{0, 1, 2, 3, 4, 5\}$.

Proposition 4.6 *Let i, j, k be three distinct elements of I . Then*

$$Y_{i,j} \times Y_{j,k} \times Y_{k,i} = 0. \quad (30)$$

Proof. There can be no forest with 3 inner vertices and support of cardinal 3. The proposition therefore follows from lemma 4.2. ■

Remark that $Y_{i,j} \times Y_{j,k} \times Y_{k,\ell} = Y_{\ell,k} \times Y_{k,j} \times Y_{j,i}$.

Proposition 4.7 *Let i, j, k, ℓ be four distinct elements of I . Then*

$$\sum Y_{i_1, i_2} \times Y_{i_2, i_3} \times Y_{i_3, i_4} = 0, \quad (31)$$

where the sum is over the set of total orders on $\{i, j, k, \ell\}$ up to reversal.

Proof. Using the product rule for the orientations and Lemma 4.4, one computes

$$\begin{aligned} Y_{i,j} \times Y_{j,k} \times Y_{k,\ell} &= \text{LLL}(i, j, k, \ell) + \text{LLL}(i, \ell, j, k) \\ &\quad + \text{LLL}(\ell, i, k, j) + \text{LLL}(\ell, k, j, i) + Y_Y Y(i, j, k, \ell). \end{aligned}$$

The sum of all 12 similar terms obtained from this one by permutations of $\{i, j, k, \ell\}$ is then seen to vanish, using the antisymmetry and symmetry properties of LLL and $Y_Y Y$ stated in Lemma 4.5. ■

It is an interesting open problem to give a presentation by generators and relations of the algebras $\text{Bess}^*(I)$.

Question 1 *Do the elements $Y_{i,j}$ generate $\text{Bess}^*(I)$?*

Assuming an affirmative answer, one can then ask

Question 2 *Do the relations above give a presentation of $\text{Bess}^*(I)$?*

4.3 Differential forms and hyperplane arrangement

Let I be a finite set and \mathbb{C}^I be the vector space with coordinates $(x_i)_{i \in I}$. Let \mathbf{H}_I be union of all hyperplanes $x_i - x_j = 0$ for $i \neq j$ in the subspace $\sum_{i \in I} x_i = 0$ of \mathbb{C}^I .

It is well known from the work of Cohen (see [2, 9]) that the Gerstenhaber operad is the homology of the little discs operad, whose underlying spaces are homotopy equivalent to the complement of the complex arrangements \mathbf{H}_I . Therefore, by the classical theorem of Arnold [1] computing the cohomology of this complement of arrangement, the coalgebra associated to a finite set I defined by the Hopf structure of the Gerstenhaber operad has the following description : it is isomorphic to the dual of the subalgebra generated by all forms $d(x_i - x_j)/(x_i - x_j)$ for $i \neq j$ in I inside the algebra of differential forms on the complement of \mathbf{H}_I ,

The differential forms $Y_{i,j} = d(x_i - x_j)/(x_i - x_j)^2$ for $i \neq j$ in I are defined on the complement of \mathbf{H}_I . Obviously, they satisfy $Y_{i,j} = -Y_{j,i}$.

Let i, j, k be three distinct elements of I . Then one has clearly

$$Y_{i,j} \wedge Y_{j,k} \wedge Y_{k,i} = 0. \quad (32)$$

Further experimental evidence has been obtained showing that the algebra on forests of binary trees considered in this article should be isomorphic to a quotient of the subalgebra generated by the $Y_{i,j}$ inside the algebra of differential forms on the complement of \mathbf{H}_I .

References

- [1] V. I. Arnold. The cohomology ring of the group of dyed braids. *Mat. Zametki*, 5:227–231, 1969.
- [2] F. R. Cohen. The homology of \mathcal{C}_{n+1} -spaces, $n \geq 0$. In *The homology of iterated loop spaces*, volume 533 of *Lecture Notes*, pages 207–351. Springer-Verlag, 1976.
- [3] V. Ginzburg and M. Kapranov. Koszul duality for operads. *Duke Math. J.*, 76(1):203–272, 1994.
- [4] E. Grosswald. *Bessel polynomials*. Springer, Berlin, 1978.
- [5] H. L. Krall and O. Frink. A new class of orthogonal polynomials: The Bessel polynomials. *Trans. Amer. Math. Soc.*, 65:100–115, 1949.
- [6] M. Markl. Distributive laws and Koszulness. *Ann. Inst. Fourier (Grenoble)*, 46(2):307–323, 1996.
- [7] M. Markl, S. Shnider, and J. Stasheff. *Operads in algebra, topology and physics*. American Mathematical Society, Providence, RI, 2002.

- [8] J. P. May. Definitions: operads, algebras and modules. In *Operads: Proceedings of Renaissance Conferences (Hartford, CT/Luminy, 1995)*, pages 1–7, Providence, RI, 1997. Amer. Math. Soc.
- [9] A. A. Voronov. Homotopy Gerstenhaber algebras. In *Conférence Moshé Flato 1999, Vol. II (Dijon)*, pages 307–331. Kluwer Acad. Publ., Dordrecht, 2000.