

NBI-HE-94-37
August, 1994

On entropy of 3-dimensional simplicial complexes

D.V. Boulatov

*The Niels Bohr Institute, University of Copenhagen
Blegdamsvej 17, DK-2100 Copenhagen Ø, Denmark
and*

*International School for Advanced Studies (SISSA/ISAS)
via Beirut 2-4, I-34014 Trieste, Italy.**

Abstract

We prove that the number of 3-dimensional simplicial complexes having the spherical topology grows exponentially as a function of a volume. It is suggested that the 3d simplicial quantum gravity has qualitatively the same phase structure as the $O(n)$ matrix model in the dense phase.

*) Present address.

1 Introduction

The success of the matrix models as a theory of 2D quantum gravity and non-critical strings has brought about a hope that analogous discrete approaches might be instructive in higher dimensions as well. The most natural way to introduce discretized quantum gravity is to consider simplicial complexes instead of continuous manifolds. Then, a path integral over metrics (which is the crux of any approach to quantum gravity) can be simply defined as a sum over all complexes having some fixed properties. For example, it is natural to restrict their topology. In the present paper, we consider only the 3-dimensional case, where, by definition, a simplicial complex is a collection of tetrahedra glued by their faces in such a way that any two of them can have at most one triangle in common.

To introduce metric properties, one can assume that complexes represent piece-wise linear manifolds glued of equilateral tetrahedra [1]. The volume is proportional to the number of them. In a continuum limit, as this number grows, the length of links, a , simultaneously tends to zero: $a \rightarrow 0$. In three dimensions, there is the one-to-one correspondence between topological classes of piece-wise linear and smooth manifolds, therefore the model is self-consistent.

Within a piece-wise linear approximation, the curvature is singular: the space is flat everywhere off links. Therefore, one should consider integrated quantities, the main of which is the mean scalar curvature

$$\int d^3x \sqrt{g}R = a \left(2\pi N_1 - 6N_3 \arccos \frac{1}{3} \right) \quad (1)$$

a is the lattice spacing; N_0 , N_1 , N_2 , N_3 are the numbers of vertices, links, triangles and tetrahedra, respectively.

For manifolds in 3 dimensions, the Euler character vanishes $\chi = N_0 - N_1 + N_2 - N_3 = 0$. Together with the other constraint $N_2 = 2N_3$, it means that only 2 of N_i 's are independent, $N_1 = N_0 + N_3$, and a natural lattice action depends on 2 dimensionless parameters. Now, we are in a position to define the partition function for simplicial gravity [2, 3, 4, 5]:

$$\mathcal{Z}(\alpha, \mu) = \sum_{\{S^3\}} e^{\alpha N_0 - \mu N_3} = \sum_{N_3}^{\infty} Z_{N_3}(\alpha) e^{-\mu N_3} \quad (2)$$

where, for concreteness, we have restricted the topology of complexes: $\sum_{\{S^3\}}$ denotes the sum over all simplicial 3-spheres, S^3 .

It can be shown that, for N_3 fixed, N_0 is restricted from above as $N_0 < \frac{1}{3}N_3 + \text{const}$. Therefore, it is natural, keeping α fixed, to tend μ to its critical value, μ_c , when the sum over N_3 in Eq. (2) becomes divergent and the mean volume, $\langle N_3 \rangle$, tends to the infinity. In the vicinity of μ_c one could expect to find critical behavior corresponding to a continuum limit of the model.

For this scenario, it is crucial that μ_c is finite: $0 < \mu_c < +\infty$, *i.e.*, the number of complexes as a function of the volume, N_3 , should grow at most exponentially [2]. The purpose of the present paper is to show that it is indeed the case. More precisely, we prove

THEOREM: *There exists a finite constant $0 < \mu^* < +\infty$ such that the number of 3-dimensional simply-connected simplicial complexes, $\mathcal{N}(N_3)$, constructed of the given number of 3-simplexes, N_3 , obeys the restriction*

$$\mathcal{N}(N_3) < e^{\mu^* N_3} \quad (3)$$

for big enough values of N_3 .

“Simply-connected” means that all loops in a complex C are contractible, *i.e.*, $\pi_1(C) = 0$. If the Poincaré hypothesis is true, this class of complexes coincides with homeomorphic spheres. If not, it is somehow wider. However, the statement of the theorem will obviously hold for the spheres as well.

2 Proof of the theorem

We want to estimate $\mathcal{N}(N_3)$ from above being unable to calculate it precisely. The general principle can be formulated as follows. Let $S(\alpha)$ be a finite set of objects defined by a set of descriptions α . *If $\alpha \subset \beta$, then $S(\beta) \subseteq S(\alpha)$ and $|S(\beta)| \leq |S(\alpha)|$* , where $|S|$ denotes the number of objects in a set S . In other words, being less specific, one cannot decrease the number of objects.

Throughout the paper we use the following trick: *if $S = \cup_{\{A\}} B_A$, then $|S| \leq |A| \max_{\{A\}} |B_A|$ and, if all $B_A \neq \emptyset$, then $|A| \leq |S|$* . Less formally, let us notice that the existence of the exponential bound (3) is not spoiled, if one weights every complex with a non-zero weight which itself depends on N_3 and grows at most exponentially. Also, if one manages to represent a sum over complexes as a weighted sum over another class of objects and to prove

that the weights are exponentially bounded, then one can put them all equal to 1 and simply estimate the number of objects in the new class.

The simplest example of a weighted sum over complexes is given by the micro-canonical partition function $Z_{N_3}(\alpha)$ in Eq. (2). Another example of physical interest is the partition function in the presence of free matter fields. To introduce it let us consider the set of cell complexes dual to simplicial ones. Their 1-skeletons are some ϕ^4 Feynman graphs whose vertices correspond to tetrahedra and propagators are dual to triangles. Such a graph can be defined by the adjacency matrix

$$G_{ij} = \begin{cases} 1 & \text{if vertices } i \text{ and } j \text{ are connected by a link} \\ 0 & \text{otherwise} \end{cases} \quad (4)$$

Of course, the set of ϕ^4 graphs is not identical to the one of simplicial complexes, similarly as, in two dimensions, the set of ordinary ϕ^3 diagrams is different from the one of triangulations (one has to introduce the notion of fat graphs to establish the equivalence). However, we shall loosely use the term “ ϕ^4 -diagram” because of its commonness.

If one attaches the n -component free matter field x_i^μ ($\mu = 1, \dots, n$) to the i -th vertex, the resulting gaussian integral can be performed explicitly for every given graph G :

$$\int \prod_{i=1}^{N_3-1} \prod_{\mu=1}^n dx_i^\mu \exp \left[-\frac{1}{2} \sum_{i,j=1}^{N_3-1} G_{ij} (x_i^\mu - x_j^\mu)^2 \right] = \det^{-\frac{n}{2}} L \quad (5)$$

where L is the discrete Laplacian

$$L_{ij} = 4\delta_{ij} - G_{ij} \quad (6)$$

for the determinant of which there is the nice combinatorial representation given by the Kirchhoff theorem:

$$\det L = |T(G)| \quad (7)$$

where $T(G)$ is the set of all maximal connected trees embedded into the ϕ^4 graph G or, equivalently, the number of ways to cut links of the graph such that it becomes a connected tree. To kill the zero mode in Eq. (5), we fixed the field at the N_3 -th vertex, therefore we consider rooted trees with the root attached to this vertex.

The case we are interested in is the 2-component Grassmann field, where we obtain the partition function[†]

$$\mathcal{Z}^{(1)}(\alpha, \mu) = \sum_{\{S^3\}} \det L e^{\alpha N_0 - \mu N_3} = \sum_{N_3}^{\infty} Z_{N_3}^{(1)}(\alpha) e^{-\mu N_3} \quad (8)$$

The weights, $\det L$, are non-zero integers, hence,

$$Z_{N_3}(\alpha) < Z_{N_3}^{(1)}(\alpha) \quad (9)$$

In two dimensions, this type of matter has the central charge $c = -2$ and the corresponding matrix model has been solved explicitly [7]. We can repeat the same trick in 3 dimensions:

$$Z_{N_3}^{(1)}(\alpha) = \sum_{\{G\}} \det L e^{\alpha N_0} = \sum_{\{G\}} \sum_{\{T(G)\}} e^{\alpha N_0} = \sum_{\{T\}} \sum_{\{G(T)\}} e^{\alpha N_0} \quad (10)$$

Namely, we have the sum over complexes (ϕ^4 graphs), $\sum_{\{G\}}$, weighted with the number of maximal trees in each $\sum_{\{T(G)\}}$. We can obtain exactly the same configurations taking the sum over all possible trees, $\sum_{\{T\}}$, weighted with the number of complexes, $\sum_{\{G(T)\}}$, which can be recovered from a given tree, T , by restoring cut links.

In 3 dimensions, the appearing trees are dual to spherical simplicial balls obtained from a single tetrahedron by subsequently gluing other tetrahedra to faces of the boundary. If we denote n_0 , n_1 , n_2 the numbers of vertices, links and triangles on the boundary of a ball, we find that

$$n_0 = N_3 + 3 \quad n_2 = 2(N_3 + 1) \quad (11)$$

The set of the boundaries are a subset of all planar spherical triangulations, and their number is exponentially bounded as a function of N_3 . Therefore, the remaining problem is to estimate the maximal number of closed 3-dimensional simplicial spheres which can be obtained from an arbitrary spherical ball by pair-wise identifying triangles on its boundary.

It seems to be rather difficult to find a criterion which would single out only homeomorphic spheres from all possible configurations. Therefore, we

[†]) This model was considered by V.A.Kazakov several years ago as the simplest generalization of the corresponding 2-dimensional matrix model [6].

demand instead that all final complexes are to be simply-connected, *i.e.*, having the trivial fundamental group.

Let us consider loops embedded into a ϕ^4 diagram dual to a simplicial complex C (which is the 1-skeleton of a dual cell complex, \tilde{C}). As any closed loop is contractible, it can be represented as the boundary of some 2-dimensional disc embedded into the complex \tilde{C} . It means simply that, to shrink a loop, one has to pull it subsequently through 2-cells of \tilde{C} (they are in correspondence with links in C). Obviously, we have to allow for self-intersections and multiple coverings of the same face. However, any k -cell of the disc has to cover one and only one k -cell of \tilde{C} . In other words, we consider only regular (*i.e.*, locally unambiguous) embeddings.

If two triangles on the surface of a ball are identified, there is always a closed in \tilde{C} loop represented by a segment lying completely inside the ball with the ends attached to the identified triangles. Having cut \tilde{C} , one cuts any disc spanned by the loop. The discs are represented by planar graphs and the cut links form what is called “rainbow diagrams”, *i.e.*, collections of self-avoiding segments. If a cut disc remains connected, these segments form rainbows consisting of embedded arches. The deepest segment connects a pair of triangles having a common side on the surface of the ball, thus recovering a 2-cell of \tilde{C} . If the disc is disconnected by cutting \tilde{C} , such configurations may be absent.

PROPOSITION 1 *Let \tilde{C}_b be a cell complex dual to a simplicial ball (*i.e.*, obtained from some closed complex \tilde{C} by cutting its links). If, by cutting a link in \tilde{C}_b , one disconnects all discs embedded into \tilde{C}_b and spanned by loops going through the link, while the complex remains connected, then \tilde{C}_b is not simply connected.*

PROOF: If a cut disconnects all the discs, it means that the link enters at least twice in any closed contractible loop going through it. As the complex remains connected, there must be another path connecting the ends of the link. The union of this path and the link represents a closed loop which cannot be a boundary of any disc, hence, it is not contractible.

Now, let us notice that, if one starts with an arbitrary closed simply-connected complex, a final ball does not depend on a sequence in which cuts are performed. One can choose a particular sequence never creating non-contractible loops, owing to the following fact.

PROPOSITION 2 *Let \tilde{C}_b be a cell complex defined above. If, by cutting any link in \tilde{C}_b , one creates a non-contractible loop, then \tilde{C}_b is not simply-connected.*

PROOF: Let a cut create a new non-contractible loop. It is a collection of links of \tilde{C}_b . Before the cut, it was contractible, therefore there was a disc spanned by it. The cutting made it a ring, hence, the cut link belongs to the disc. Moreover, it belongs to any disc whose boundary is homotopic to the new loop. As it holds for any link, we are considering an effectively 2-dimensional object, *i.e.*, a collection of surfaces with holes having some identified vertices, links and/or faces. If, by deleting a link, we create a non-contractible loop in a simply-connected 2-dimensional space, it means that it has the homotopy type of a disc. A disc must have a boundary. However, we cannot create a non-contractible loop by cutting a link belonging to the boundary, Hence, we find a contradiction: one cannot fulfill all the conditions simultaneously.

Thus, any simply-connected simplicial complex can be obtained from a ball by subsequently gluing up triangles having a common side on the surface and such a pair always exists. Obviously, the number of inequivalent sequences of such identifications is bigger than the actual number of complexes: two triangles may have two common sides and it may happen at any step. It means an overcounting. However, the gain is that we obtain a purely 2-dimensional problem now.

The boundary of the ball can become a collection of disconnected 2-dimensional spheres but any identification of triangles belonging to different components produces a non-contractible loop.

So, one starts with an arbitrary 2-dimensional spherical ϕ^3 diagram and applies the operation which can be represented as the flip of a link with the subsequent elimination of it:

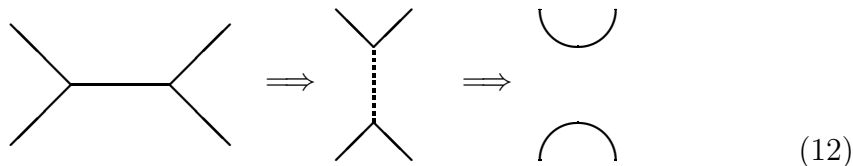

Both of these moves are well known and have been used in Monte-Carlo simulations of triangulated surfaces [7]. Having glued all triangles, one finishes with a collection of self-avoiding closed loops, the number of which equals $N_0 - 1$.

Let us notice that, instead of removing links, we can mark them with dashed propagators. For it we need the infinite set of vertices

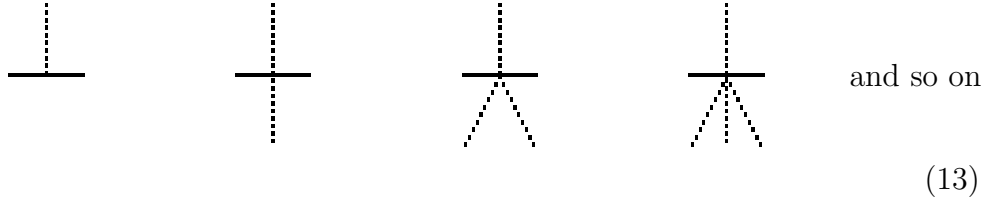

which are generated by flips. For example,

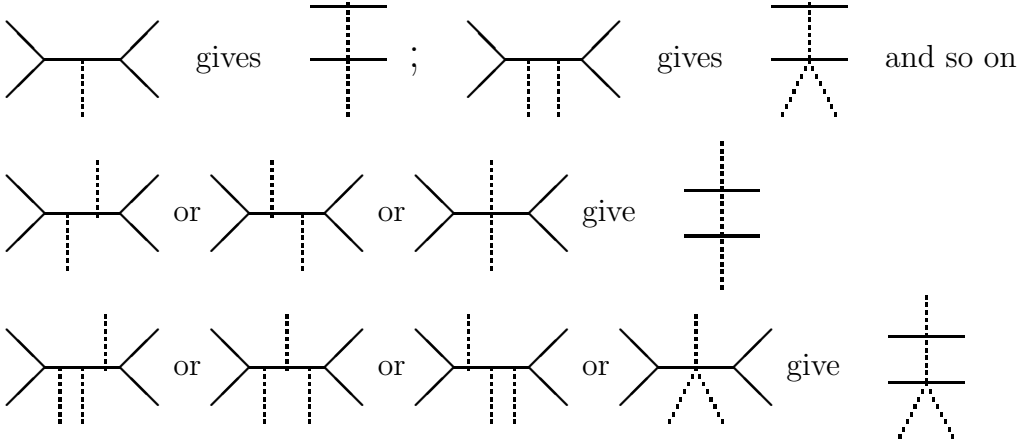

and so on.

In the end, we obtain planar diagrams with two types of propagators: solid ones produce closed loops while dashed form arbitrary clusters. To recover initial diagrams one has to flip dashed links in all possible ways. For any given cluster, the number of final configurations is a subset of all planar ϕ^3 diagrams, hence, is exponentially bounded as a function of the number of links. Let us show it. At first, flips have to be performed in linear clusters which gives all possible planar ϕ^3 trees doubled in a “mirror”:

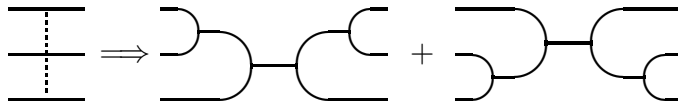

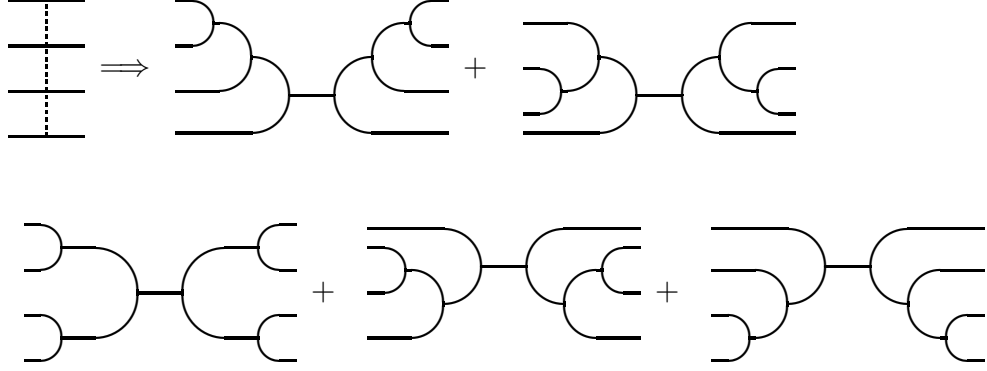

and so on. The number of configurations with n dashed links, C_n , is given by Catalan's numbers generated by the function

$$C(x) = \sum_{n=0}^{\infty} C_n x^n := \sum_{n=0}^{\infty} \left(\text{Diagram of a tree with } n+1 \text{ dashed links} \right) x^n = \frac{1}{2x} (1 - \sqrt{1 - 4x}) \quad (14)$$

After that dashed propagators attached to the ends of the linear cluster have to be reattached in all possible ways to links of these "doubled trees". The number of configurations can be estimated as follows.

First, we have to calculate the generating function for the number of possible attachments of dashed propagators to a solid line:

$$q(\nu, \mu) := \sum_{n,m} \left(\text{Diagram of a solid line with } n \text{ dashed links above and } m \text{ dashed links below} \right) \nu^n \mu^m \quad (15)$$

It can be obtained from the equation

$$q(\nu, \mu) = \left[\frac{\nu}{1 - \mu} + \frac{\mu}{1 - \nu} - \nu\mu \right] q(\nu, \mu) + 1 \quad (16)$$

which gives

$$q(\nu, \mu) = \frac{(1-\nu)(1-\mu)}{(1-\nu-\mu)^2 - (\nu+\mu)\nu\mu + \nu^2\mu^2} \quad (17)$$

Second, we have to know the generating function for the number of all possible attachments of dashed propagators to a k -legged tree on the left (or on the right but not on both sides):

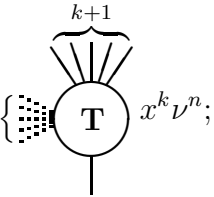
$$t(x, \nu) := \sum_{k,n} \left\{ \begin{array}{c} \text{\scriptsize } k+1 \\ \text{---} \\ \text{\textcircled{T}} \end{array} \right\} x^k \nu^n; \quad t(x, 0) = C(x) \quad (18)$$

The equation for it is simply

$$t(x, \nu) = xC(x) \frac{t(x, \nu)}{1-\nu} + 1 \quad (19)$$

which gives

$$t(x, \nu) = \frac{1-\nu}{1-\nu-xC(x)} \quad (20)$$

Then, the quantity we need to calculate is

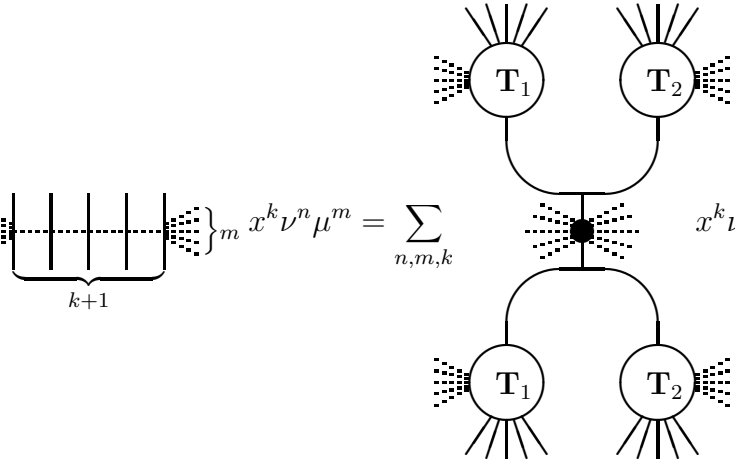
$$T(x, \nu, \mu) = \sum_{n,m,k} \left\{ \begin{array}{c} \text{\scriptsize } k+1 \\ \text{---} \\ \text{---} \end{array} \right\} x^k \nu^n \mu^m = \sum_{n,m,k} \left\{ \begin{array}{c} \text{\scriptsize } k+1 \\ \text{\textcircled{T}_1} \text{---} \text{\textcircled{T}_2} \\ \text{\textcircled{T}_1} \text{---} \text{\textcircled{T}_2} \end{array} \right\} x^k \nu^n \mu^m \quad (21)$$

Newly appearing clusters have to be expanded in all possible ways according to the same procedure. What is important is that their number is restricted by the coefficients of $q(\nu, \mu)$, which is a factor in (21), and does not depend on a volume of the trees. Therefore, one simply iterates till all dashed links disappear. The combinatorial reason for the existence of an exponential bound for the number of obtained configurations is clear: they are all planar!

To calculate the number of “unflipped” configurations, we can use the following matrix integral generating all vertices from (13) with equal weights

$$\begin{aligned} I &= \int \prod_{a=1}^{\nu} d^{N^2} X_a d^{N^2} Y \exp \left[-\frac{N}{2} \sum_{a=1}^{\nu} \text{tr} X_a^2 - \frac{N}{2} \text{tr} Y^2 + \mu N \sum_{a=1}^{\nu} \text{tr} \left(Y X_a \frac{1}{1-\mu Y} X_a \right) \right] \\ &= \int d^{N^2} Y \exp \left[-\frac{N}{2} \text{tr} Y^2 - \frac{\nu}{2} \text{tr}^2 \log \left(1 \otimes 1 - \mu Y \otimes \frac{1}{1-\mu Y} - \frac{1}{1-\mu Y} \otimes \mu Y \right) \right] \end{aligned} \quad (22)$$

which reminds the Kostov’s representation for the $O(n)$ matrix model in the dense phase [8]. We have attached the lower index to the gaussian X variable to weight the closed loops. Thus,

$$I(\nu, \mu) = \sum_{\{\mathcal{D}\}} \nu^{N_0-1} \mu^{N_3} \quad (23)$$

where $\sum_{\{\mathcal{D}\}}$ is the sum over all the diagrams. This matrix model belongs to the same universality class as the $O(n)$ -model in the dense phase. $I(\nu, \mu)$ has a finite radius of convergence as a function of μ . Thus, the theorem is established.

3 Discussion

It is very difficult to take account of the entropy of configurations in order to improve the representation (22). Therefore, let us consider the simplest self-consistent model, which is equivalent to the dense phase of the $O(n)$ matrix model [8]:

$$I_{O(n)} = \int d^{N^2} Y \exp \left[-\frac{N}{2} \text{tr} Y^2 - \frac{\nu}{2} \text{tr}^2 \log \left(1 \otimes 1 - \mu Y \otimes 1 - 1 \otimes \mu Y \right) \right] \quad (24)$$

Let us suppose that this truncated model bears nevertheless some qualitative features of 3-dimensional simplicial gravity.

The critical behavior of the $O(n)$ matrix model is well known [8]. For $\nu < 2$, it describes 2-d gravity interacting with $c < 1$ conformal matter

$$c = 1 - 6 \frac{(1 - g_0)^2}{g_0}; \quad \nu = -2 \cos \pi g_0 \quad (25)$$

while for $\nu > 2$ the corresponding matter is non-critical and the model trivializes. In this phase, the number of closed loops is proportional to the volume and the mean length of each remains finite.

In the vicinity of a critical point μ_c , the partition function behaves as

$$I_{O(n)} \approx (\mu_c - \mu)^{2 - \gamma_{\text{str}}} \quad (26)$$

Two main quantities of interest are

$$\langle N_3 \rangle_{O(n)} = \mu \frac{\partial}{\partial \mu} \log I_{O(n)} \approx -(2 - \gamma_{\text{str}}) \frac{\mu_c}{\mu_c - \mu} \quad (27)$$

and

$$\begin{aligned} \langle N_0 \rangle_{O(n)} &= \nu \frac{\partial}{\partial \nu} \log I_{O(n)} \approx (2 - \gamma_{\text{str}}) \frac{\nu \mu'_c(\nu)}{\mu_c(\nu) - \mu} - \nu \frac{\partial \gamma_{\text{str}}}{\partial \nu} \log |\mu_c - \mu| \\ &\approx -\nu \frac{\mu'_c}{\mu_c} \langle N_3 \rangle_{O(n)} + \nu \frac{\partial \gamma_{\text{str}}}{\partial \nu} \log \langle N_3 \rangle_{O(n)} \end{aligned} \quad (28)$$

where the coefficients can be calculated explicitly using the Gaudin and Kostov's exact solution [8]

$$\frac{\partial}{\partial \nu} \log \mu_c = -\frac{1}{2} \frac{1}{\nu + 2}; \quad \frac{\partial \gamma_{\text{str}}}{\partial \nu} = \frac{1}{2\pi g_0^2 \sin \pi(1 - g_0)} \quad (29)$$

If $2 - \nu \ll 1$, then

$$\langle N_0 \rangle_{O(n)} \approx \frac{1}{4} \langle N_3 \rangle_{O(n)} + \frac{1}{\pi \sqrt{2 - \nu}} \log \langle N_3 \rangle_{O(n)} \quad (30)$$

If $\nu > 2$, then $\gamma_{\text{str}} = -\frac{1}{2}$ is independent of ν and $\langle N_0 \rangle_{O(n)}$ is proportional to $\langle N_3 \rangle_{O(n)}$.

This behavior is strikingly similar to the results of numerical simulations! In Ref. [4], a phase transition in the model (2) with respect to the fugacity

for the number of vertices, α , was found. In the “cold” phase, $\alpha > \alpha_c$, the mean number of vertices, $\langle N_0 \rangle$, is strictly proportional to a volume, $\langle N_3 \rangle$. In the “hot” phase, $\alpha < \alpha_c$, $\langle N_0 \rangle$ is a non-trivial function of $\langle N_3 \rangle$. The analogy with the $O(n)$ matrix model suggests that the most probable scaling is[‡] $\langle N_0 \rangle \approx c_1 \langle N_3 \rangle + c_2 \log \langle N_3 \rangle$ with c_2 singular at the critical point α_c . Presumably, it is a type of this singularity that can be, in principle, calculated in continuum theory in order to compare predictions of both approaches. The obvious problem for such a hypothetical comparison is that α is a bare coupling. Therefore, in the lattice model, only critical points with respect to it could show some universal features.

Of course, the $O(n)$ matrix model cannot give us precise information about simplicial gravity. However, it is very plausible that it has qualitatively the same phase structure as models (2) and (8) and may be quite instructive from this point of view.

To conclude, let us express the hope that, when 3-dimensional simplicial gravity is solved, it will reveal as much beautiful mathematical and physical structure as the matrix models have been doing.

Acknowledgments

This work has appeared as a result of the numerous discussions with J.Ambjørn, B.Durhuus, T.Jonsson, V.A.Kazakov and A.A.Migdal, who have for many years been sharing with me their ideas and knowledge.

Financial support from the EEC Program “Human Capital and Mobility” under the contract ERBCHBICT9941621 is gratefully acknowledged.

References

- [1] T. Regge, *Nuovo Cimento* **19** (1961) 558
- [2] J.Ambjørn, B.Durhuus and T.Jonsson, *Mod. Phys. Lett.* **A6** (1991) 1133

[‡]) Unfortunately, numerical experiments cannot provide an accuracy sufficient to completely rule out other possibilities, *e.g.*, a power scaling.

- [3] M.E. Agishtein and A.A. Migdal, *Mod. Phys. Lett.* **A6** (1991) 1863; J.Ambjørn and S. Varsted, *Phys. Lett.* **B226** (1991) 258 and *Nucl. Phys.* **B373** (1992) 557.
- [4] D.V. Boulatov and A. Krzywicki, *Mod. Phys. Lett.* **A6** (1991) 3005; J.Ambjørn, D.V. Boulatov, A. Krzywicki and S. Varsted, *Phys. Lett.* **B276** (1992) 432.
- [5] D.V.Boulatov, *Mod. Phys. Lett.* **A7** (1992) 1629 and “*3D gravity and gauge theories*”, preprint NBI-HE-93-67 (November, 1993).
- [6] V.A.Kazakov, private communication.
- [7] V.A.Kazakov, I.K.Kostov and A.A.Migdal, *Phys. Lett.* **B157** (1985) 295; D.V.Boulatov, V.A.Kazakov, I.K.Kostov and A.A.Migdal *Nucl. Phys.* **B275** (1986) 641.
- [8] I.K.Kostov, *Mod. Phys. Lett.* **A4** (1989) 217; M.Gaudin and I.K.Kostov, *Phys. Lett.* **B220** (1989) 200.