

# BOUNDARY S-MATRIX AND BOUNDARY STATE IN TWO-DIMENSIONAL INTEGRABLE QUANTUM FIELD THEORY

Subir Ghoshal<sup>†</sup> and Alexander Zamolodchikov<sup>‡</sup> \*

Department of Physics and Astronomy  
Rutgers University  
P.O.Box 849, Piscataway, NJ 08855-0849

## Abstract

We study integrals of motion and factorizable S-matrices in two-dimensional integrable field theory with boundary. We propose the “boundary cross-unitarity equation” which is the boundary analog of the cross-symmetry condition of the “bulk” S-matrix. We derive the boundary S-matrices for the Ising field theory with boundary magnetic field and for the boundary sine-Gordon model.

## 1. INTRODUCTION

In this paper we study two-dimensional integrable field theory with boundary. Exact solution to such a field theory could provide better understanding of boundary-related phenomena in statistical systems near criticality[1]. Quantum field theory with boundary can be applied to study quantum systems with dissipative forces[2]. From a more general point of view, studying integrable models could throw some light on the structure of the “space of boundary interactions”, the object of primary significance in open string field theory[3].

An integrable field theory possesses an infinite set of mutually commutative integrals of motion<sup>1</sup>. In the “bulk theory” (i.e. without a boundary) these integrals of motion follow from the continuity equations for an infinite set of local currents. These currents can be shown to exist in many 2D quantum field theories, both the ones defined in terms of an action functional (like sine-Gordon or nonlinear sigma-models[4]) and those which

---

<sup>†</sup> E-mail: GHOSHAL@ruhets.rutgers.edu

<sup>‡</sup> E-mail: SASHAZ@ruhets.rutgers.edu

\* Supported in part by the Department of Energy under grant No. DE-FG0590ER40559

<sup>1</sup> With some reservations, this property is widely believed to be a sufficient condition. In practice, it is usually enough to find the first few integrals of motion of spin  $s > 1$  to argue about integrability (this argument works in all known cases).

are defined as “perturbed conformal field theories”[5]. In presence of a boundary, the existence of these currents is not sufficient to ensure integrability. Integrals of motion appear only if particular “integrable” boundary conditions are chosen. In general, the boundary condition can be specified either through the “boundary action functional” or as the “perturbed conformal boundary condition”<sup>2</sup>. In Sect.2 we show how the integrals of motion of the “bulk” theory get modified (in most cases destroyed) in presence of the boundary and how one can find “integrable” boundary conditions.

An important characteristic of an integrable field theory is its factorizable S-matrix. In the “bulk theory”, the factorizable S-matrix is completely determined in terms of the two-particle scattering amplitudes, the latter being required to satisfy the Yang-Baxter equation (also known as the “factorizability condition”), in addition to the standard equations of unitarity and crossing symmetry[4]. These equations have much restrictive power, determining the S-matrix up to the so-called “CDD ambiguity”. At present many examples of factorizable scattering theory are known (see e.g.[4,9-12]), most of which are obtained by explicitly solving the above equations (eliminating the “CDD ambiguity” usually requires a lot of guesswork).

It is known since long[13] that the concept of factorizable scattering can be generalized in a rather straightforward way to the case where a reflecting boundary is present. The S-matrix is expressed in terms of the “bulk” two-particle S-matrix and specific “boundary reflection” amplitudes, the latter, again, being required to satisfy an appropriate generalization of the Yang-Baxter equation (which we call here the “Boundary Yang-Baxter equation”) <sup>3</sup>. Generalization of the unitarity condition is also fairly straightforward. What was not known was the appropriate analog of the crossing-symmetry equation. In Section 3 we fill this gap by deriving what we call the “boundary cross-unitarity equation”. Together with this, the above equations have exactly the same restrictive power as the corresponding “bulk” system, i.e. they allow one to pin down the factorizable boundary S-matrix up to the “CDD factors”.

We also study integrable boundary conditions in two particular models (off-critical Ising field theory and sine-Gordon theory) and find the associated boundary S-matrices. This is done in Sections 4 and 5.

## 2.INTEGRALS OF MOTION

Consider a 2D Euclidean field theory, in flat space with coordinates  $(x^1, x^2) = (x, y)$ . There are basically two ways to define a 2D field theory. In the Lagrangian approach one specifies the action

$$\mathcal{A} = \int_{-\infty}^{\infty} dx \int_{-\infty}^{\infty} dy \quad a(\varphi, \partial_{\mu}\varphi) \tag{2.1}$$

---

<sup>2</sup> Conformal field theories with boundary are studied in [6,7,8] where, in particular, it is shown how to classify conformally-invariant boundary conditions and boundary operators.

<sup>3</sup> This equation found important applications in quantum inverse scattering method[14], generalized to the systems with boundary[15,16].

where  $\varphi(x, y)$  is some set of “fundamental fields” and the action density  $a(\varphi, \partial_\mu\varphi)$  is a local function of these fields and derivatives  $\partial_\mu\varphi = \partial\varphi/\partial x^\mu$  with  $\mu = 1, 2$ . Another approach is to consider the “perturbed conformal field theory”; in this case one writes the “symbolic action”

$$\mathcal{A} = \mathcal{A}_{CFT} + \int_{-\infty}^{\infty} \Phi(x, y) dx dy \quad (2.2)$$

where  $\mathcal{A}_{CFT}$  is the “action of conformal field theory (CFT)” and  $\Phi(x, y)$  is a specific relevant field of this CFT. In both approaches one can define a symmetric stress tensor  $T_{\mu\nu} = T_{\nu\mu}$  which satisfies the continuity equations

$$\partial_{\bar{z}}T = \partial_z\Theta \quad ; \quad \partial_z\bar{T} = \partial_{\bar{z}}\bar{\Theta} \quad (2.3)$$

Here we use complex coordinates  $z = x + iy$ ,  $\bar{z} = x - iy$  and denote the appropriate components  $T = T_{zz}$ ,  $\bar{T} = T_{\bar{z}\bar{z}}$ ,  $\Theta = T_{z\bar{z}}$  of the stress tensor. To achieve Hamiltonian formulation one chooses an arbitrary direction, say the  $y$ -direction, to be the “euclidean time”, and associates a Hilbert space  $\mathcal{H}$  with any “equal time section”  $y = const.$ ,  $x \in (-\infty, \infty)$ . States are vectors in  $\mathcal{H}$  and their “time evolution” is described by the Hamiltonian operator

$$H = \int_{-\infty}^{\infty} dx T_{yy} = \int_{-\infty}^{\infty} dx [T + \bar{T} + 2\Theta] \quad (2.4)$$

Let us assume that the field theory (2.1) or (2.2) is integrable. In particular, the equations (2.3) appear to be the first representatives of an infinite sequence

$$\partial_{\bar{z}}T_{s+1} = \partial_z\Theta_{s-1} \quad \partial_{\bar{z}}\bar{T}_{s+1} = \partial_z\bar{\Theta}_{s-1} \quad (2.5)$$

where  $T_{s+1}, \Theta_{s-1}$  ( $\bar{T}_{s+1}, \bar{\Theta}_{s-1}$ ) are local fields of spins  $s + 1, s - 1$  respectively and the integrals of motion (IM)

$$P_s = \int_{-\infty}^{\infty} (T_{s+1} + \Theta_{s-1}) dx; \quad \bar{P}_s = \int_{-\infty}^{\infty} (\bar{T}_{s+1} + \bar{\Theta}_{s-1}) dx \quad (2.6)$$

constitute an infinite set of mutually commutative operators in  $\mathcal{H}$ . The spin  $s$  of IM (2.6) takes integer values  $s_1, s_2, \dots$  in the infinite set  $\{s\}$  which is an important characteristic of an integrable field theory[5]. In any case,  $s_1 = 1$ ; for this value of  $s$  (2.5) coincides with (2.3) and

$$H = (P_1 + \bar{P}_1) \quad (2.7)$$

Now, let us consider this field theory in the semi-infinite plane,  $x \in (-\infty, 0]$ ,  $y \in (-\infty, \infty)$ , the  $y$ -axis being the boundary. Again, the boundary conditions are specified in different ways in the two approaches, (2.1) and (2.2). In the lagrangian approach one chooses the “boundary action density”  $b(\varphi_B(y), \frac{d}{dy}\varphi_B(y))$ , as a local function of the “boundary field”  $\varphi_B$ ,  $\varphi_B(y) = \varphi(x, y)|_{x=0}$ , and writes the full action in the form

$$\mathcal{A}_B = \int_{-\infty}^{\infty} dy \int_{-\infty}^0 dx a(\varphi, \partial_\mu \varphi) + \int_{-\infty}^{\infty} dy b(\varphi_B, \frac{d}{dy} \varphi_B) \quad (2.8)$$

To write down the analog of (2.2) in presence of the boundary, one starts with conformal field theory on the same semi-infinite plane with certain conformal boundary conditions (CBC) at the boundary  $x = 0$ , and defines ‘‘CBC perturbed by relevant boundary operator  $\Phi_B(y)$ ’’. In general, this perturbation of boundary condition goes along with the perturbation (2.2) of the bulk theory. This strategy is summarised by the symbolic ‘‘action’’

$$\mathcal{A} = \mathcal{A}_{\mathcal{CFT}+\mathcal{CBC}} + \int_{-\infty}^{\infty} dy \int_{-\infty}^0 dx \Phi(x, y) + \int_{-\infty}^{\infty} dy \Phi_B(y) \quad (2.9)$$

As is argued by Cardy[6], in CFT the equation  $T_{xy}|_{x=0} = 0$  is satisfied with any choice of CBC. In the perturbed theory (2.9) this condition is changed to

$$T_{xy}|_{x=0} = (-i)(T - \bar{T})|_{x=0} = \frac{d}{dy} \theta(y) \quad (2.10)$$

where  $\theta(y)$  is some local boundary field. As the theory (2.8) or (2.9) is still symmetric with respect to translations along the  $y$ -axis, the equation (2.10) can be easily derived as a consequence of this symmetry. In the ‘‘perturbed CFT’’ approach, it is relatively easy to relate the field  $\theta(y)$  to the ‘‘boundary perturbation’’  $\Phi_B(y)$ (see below).

The continuity equations (2.3) guarantee that the contour integrals

$$P_1(\mathcal{C}) = \int_{\mathcal{C}} (Tdz + \Theta d\bar{z}) \quad ; \quad \bar{P}_1(\mathcal{C}) = \int_{\mathcal{C}} (\bar{T}d\bar{z} + \Theta dz) \quad (2.11)$$

do not change under deformations of the integration contours  $\mathcal{C}$ . Consider the contour  $\mathcal{C} = \mathcal{C}_1 + \mathcal{C}_{12} + \mathcal{C}_2$  shown in Fig.1. Obviously,  $P_1(\mathcal{C}) = \bar{P}_1(\mathcal{C}) = 0$ . If we take the combination

$$0 = P_1(\mathcal{C}) + \bar{P}_1(\mathcal{C}) = P_1(\mathcal{C}_1) + \bar{P}_1(\mathcal{C}_1) + P_1(\mathcal{C}_2) + \bar{P}_1(\mathcal{C}_2) + P_1(\mathcal{C}_{12}) + \bar{P}_1(\mathcal{C}_{12}) \quad (2.12)$$

the integration over  $\mathcal{C}_{12}$  part of this contour is easily done in view of (2.10)

$$P_1(\mathcal{C}_{12}) + \bar{P}_1(\mathcal{C}_{12}) = \theta(y_1) - \theta(y_2) \quad (2.13)$$

and hence the integral

$$H_B(y) = \int_{-\infty}^0 (T + \bar{T} + 2\Theta) dx + \theta(y) \quad (2.14)$$

is in fact  $y$ -independent, i.e. it is an integral of motion in (2.8) or (2.9).

Even if the bulk theory (2.1) or (2.2) is integrable, in general the boundary conditions in the semi-infinite system (2.8) or (2.9) will spoil integrability. Suppose, however, that we can choose particular boundary conditions, such that the equation

$$[T_{s+1} + \bar{\Theta}_{s-1} - \bar{T}_{s+1} - \Theta_{s-1}]|_{x=0} = \frac{d}{dy}\theta_s(y) \quad (2.15)$$

is satisfied for some  $s \in \{s\}$ ; here again  $\theta_s(y)$  is some local boundary field. Then repeating the above argument, one finds that the quantity

$$H_B^{(s)} = \int_{-\infty}^0 [T_{s+1}(x, y) + \Theta_{s-1}(x, y) + \bar{T}_{s+1}(x, y) + \bar{\Theta}_{s-1}(x, y)] dx + \theta_s(y) \quad (2.16)$$

does not depend on  $y$ , i.e. it appears as a non-trivial integral of motion. We will call the boundary conditions “integrable” (and refer to the theory (2.8)((2.9)) as “integrable boundary field theory”) if the equation (2.15) holds for any  $s$  out of an infinite set  $\{s\}_B$ , subset in  $\{s\}$ .

There are two alternative natural ways to introduce the Hamiltonian picture in the theory (2.8)((2.9)). First, one can take again the direction along the boundary ( $y$ -direction) to be the “time”. In this case the boundary appears as the “boundary in space”, and the Hilbert space of states  $\mathcal{H}_B$  is associated with the semi-infinite line  $y = const$ ,  $x \in (-\infty, 0]$ . Then the quantities (2.14), (2.16) appear as operators acting in  $\mathcal{H}_B$ , and  $H_B (= H_B^{(1)})$  is naturally identified with the Hamiltonian. The correlation functions of any local fields  $O_i(x, y)$  in presence of the boundary can be computed in this picture as the matrix elements

$$\langle O_1(x_1, y_1) \dots O_N(x_N, y_N) \rangle = \frac{{}_B\langle 0 | \mathcal{T}_y O_1(x_1, y_1) \dots O_N(x_N, y_N) | 0 \rangle_B}{{}_B\langle 0 | 0 \rangle_B} \quad (2.17)$$

where  $|0\rangle_B \in \mathcal{H}_B$  is the ground state of  $H_B$ , and  $O_i(x_i, y_i)$  in the r.h.s. are understood as the corresponding Heisenberg operators

$$O_i(x, y) = e^{-yH_B} O_i(x, 0) e^{yH_B} \quad (2.18)$$

and  $\mathcal{T}_y$  means the “ $y$ -ordering”. In an integrable theory the operators  $H_B^{(s)}$ ;  $s \in \{s\}_B$ , constitute a commutative set of IMs.

Alternatively, one could take  $x$  to be the “euclidean time”. In this case the “equal time section” is the infinite line  $x = const$ ,  $y \in (-\infty, \infty)$ . Hence the associated space of states is the same  $\mathcal{H}$  as in the bulk theory (2.1)((2.2)), and the Hamiltonian operator is given by the same eq.(2.4) (with  $x$  and  $y$  interchanged). The boundary at  $x = 0$  appears as the “time boundary”, or “initial condition” at  $x = 0$  which is described by the particular “boundary state”<sup>4</sup>  $|B\rangle \in \mathcal{H}$ . It is the state  $|B\rangle$  that concentrates all information about the boundary condition in this picture. The correlation functions (2.17) are expressed as

$$\langle O_1(x_1, y_1) \dots O_N(x_N, y_N) \rangle = \frac{\langle 0 | \mathcal{T}_x(O_1(x_1, y_1) \dots O_N(x_N, y_N)) | B \rangle}{\langle 0 | B \rangle} \quad (2.19)$$

---

<sup>4</sup> The notion of boundary state is discussed in the context of CFT in [7].

where now  $|0\rangle \in \mathcal{H}$  is the ground state of  $H$  and  $O_i(x, y)$  in the r.h.s. are the Heisenberg field operators

$$O_i(x, y) = e^{-xH} O_i(0, y) e^{xH} \quad (2.20)$$

corresponding to this picture;  $\mathcal{T}_x$  means “ $x$ -ordering”. In an integrable theory, the same equations (2.6) (again with  $x$  and  $y$  interchanged) define an infinite set of mutually commutative operators  $P_s, \bar{P}_s; s \in \{s\}$ , acting in  $\mathcal{H}$ . As a direct consequence of (2.15) one finds that the boundary state  $|B\rangle$  satisfies the equations

$$(P_s - \bar{P}_s) |B\rangle = 0 \quad ; \quad s \in \{s\}_B. \quad (2.21)$$

To expose an example of an integrable boundary field theory, let us consider the perturbed CFT (2.9) with  $\mathcal{A}_{CFT}$  taken to be any  $c < 1$  minimal model, and the degenerate spinless field  $\Phi_{(1,3)}$  taken as the bulk perturbation,

$$\Phi_{(x,y)} = \lambda \Phi_{(1,3)}(x, y). \quad (2.22)$$

where  $\lambda$  is a constant of dimension  $[\text{length}]^{2\Delta-2}; \Delta = \Delta_{(1,3)}$ . The local integrals of motion in the corresponding bulk theory (2.2) are discussed in [5]. The fields  $T_{s+1}$  are composite fields built up from  $T = T_{zz}$  and its derivatives, for example

$$T_2 = T \quad ; \quad T_4 =: T^2 : \quad ; \quad T_6 =: T^3 : - \frac{c+2}{6} : (\partial_z T)^2 : \quad ; \quad \dots \quad (2.23)$$

where  $: :$  denotes appropriately regularized products ( $\bar{T}_{s+1}$  are built from  $\bar{T}$  in similar ways). The characteristic feature of the fields  $T_{s+1}$  is that, in the conformal limit  $\lambda = 0$  their OPE’s with  $\Phi_{(1,3)}$  have the form

$$T_{s+1}(z) \Phi_{(1,3)}(w, \bar{w}) = \sum_{k=1}^s \frac{\Psi_{s-k+1}^{(k)}(w, \bar{w})}{(z-w)^k} + \text{regular terms} \quad (2.24)$$

( $\Psi_{s-k+1}^{(k)}$  are particular conformal descendants of  $\Phi_{(1,3)}$ ) with

$$\Psi_s^{(1)}(w, \bar{w}) = \partial_w Q_{s-1}(w, \bar{w}), \quad (2.25)$$

where  $Q_{s-1}$  are local fields. The “null-vector” equation

$$(L_{-3} - \frac{2}{\Delta+1} L_{-1} L_{-2} + \frac{1}{(\Delta+1)(\Delta+2)} L_{-1}^3) \Phi_{(1,3)}, \quad (2.26)$$

satisfied by the degenerate field  $\Phi_{(1,3)}$ , is used to prove (2.25). The equation (2.25) is sufficient to show that the field  $T_{s+1}$  satisfy (2.5) in the perturbed theory, up to first order in  $\lambda$ . Then dimensional analysis shows that (2.5) is exact. There are infinitely many fields  $T_{s+1}$  satisfying (2.24)-(2.25), one for each odd  $s$ . So, the set  $\{s\}$  in this theory contains all positive odd integers.

Conformal boundary conditions in  $c = 1 - \frac{6}{p(p+1)}$  minimal CFT are classified in [7]. There are finitely many possible conformal boundary conditions, each corresponding to

a particular cell  $(r, s)$  of the Kac table. In each case possible boundary operators are degenerate primary boundary fields  $\psi_{(n,m)}$  (plus their Virasoro descendants), such that the fusion rule coefficients  $N_{(n,m)(r,s)}^{(r,s)}$  are non-zero (the other degenerate boundary fields, with  $N_{(n,m)(r,s)}^{(r,s)} = 0$  correspond to “juxtapositions” of different conformal boundaries, see [7] for details). The field  $\Phi_{(1,3)}$  satisfies this condition for any  $(r, s)$ . We take this field to be the boundary perturbation in (2.9), i.e.

$$\Phi_B(y) = \lambda_B \psi_{(1,3)}(y). \quad (2.27)$$

Its conformal dimension  $\Delta = \Delta_{(1,3)} < 1$ , so that it is a relevant perturbation. We want to show that under this choice the theory (2.9) is integrable.

To warm up, let us consider the components  $T$  and  $\bar{T}$  of the stress tensor itself. In the conformal limit  $\lambda = 0, \lambda_B = 0$ , these components satisfy the boundary condition

$$[T(y+ix) - \bar{T}(y-ix)]|_{x=0} = 0, \quad (2.28)$$

i.e. the field  $\bar{T}(\bar{z})$  is just the analytic continuation of  $T(z)$  to the lower half-plane  $Imz < 0$ . Let us “turn on” the boundary perturbation,  $\lambda_B \neq 0$ , still keeping  $\lambda = 0$ , and consider the correlation function

$$\begin{aligned} & \langle [T(y+ix) - \bar{T}(y-ix)]X \rangle_{\lambda_B} = \\ & Z_{\lambda_B}^{-1} \langle [T(y+ix) - \bar{T}(y-ix)]X e^{-\lambda_B \int_{-\infty}^{\infty} \psi_{(1,3)}(y') dy'} \rangle_{CFT}, \end{aligned} \quad (2.29)$$

where  $X$  is any product of fields located away from the boundary  $x = 0$  and  $Z_{\lambda_B}^{-1} = \langle e^{-\lambda_B \int_{-\infty}^{\infty} \psi_{(1,3)}(y) dy} \rangle_{CFT}$ . In the limit  $x \rightarrow 0$  the contribution to (2.29) is controlled by OPE

$$\begin{aligned} & (T(y+ix) - T(y-ix))\lambda_B \psi_{(1,3)}(y') = \\ & \lambda_B \left\{ \frac{\Delta_{(1,3)}}{(y-y'+ix)^2} - \frac{\Delta_{(1,3)}}{(y-y'-ix)} + \frac{1}{(y-y'+ix)} \frac{\partial}{\partial y'} - \frac{1}{(y-y'-ix)} \frac{\partial}{\partial y'} \right\} \psi_{(1,3)}(y') \rightarrow \\ & \rightarrow \lambda_B \left\{ \Delta_{(1,3)} \delta'(y-y') + \delta(y-y') \frac{\partial}{\partial y'} \right\} \psi_{(1,3)}(y'). \end{aligned} \quad (2.30)$$

This shows that for  $\lambda_B \neq 0$  the fields  $T(x, y)$  and  $\bar{T}(x, y)$  satisfy (2.10) with

$$\theta(y) = (1 - \Delta)\lambda_B \psi_{(1,3)}(y). \quad (2.31)$$

Now, dimensional analysis, exactly parallel to that carried out in [5] shows that the equations (2.10), (2.30) remain valid if we turn on the bulk perturbation, i.e. at  $\lambda \neq 0$ .

The above arguments can be repeated for the higher currents  $T_{s+1}$ ,  $s = 3, 5, \dots$ . To see this, note that the null vector equation (2.26), crucial for the validity of (2.25), is satisfied by  $\psi_{(1,3)}$  as well. Therefore, in the conformal limit  $\lambda = \lambda_B = 0$  the fields  $T_{s+1}(z)$  satisfy the OPEs

$$T_{s+1}(z)\psi_{(1,3)}(y) = \sum_{k=1}^s \frac{1}{(z-y)^k} \chi_{s+1-k}^{(k)}(y) + \text{regular terms},$$

$$\chi_s^{(1)}(y) = \frac{d}{dy} q_s(y), \quad (2.32)$$

similar to (2.24),(2.25) where  $q_s, \chi$  are descendants of  $\psi_{(1,3)}$ . Whence

$$\begin{aligned} & \text{limit}_{x \rightarrow 0} (T_{s+1}(y+ix) - T_{s+1}(y-ix)) \lambda_B \psi_{(1,3)}(y') \\ &= \lambda_B (\delta(y-y') \frac{d}{dy'} q_s(y') + \sum_{k=2}^s \frac{1}{(k-1)!} \frac{d^{k-1}}{dy'^{k-1}} \delta(y-y') \chi_{s+1-k}^k(y')), \end{aligned} \quad (2.33)$$

and we conclude that for  $\lambda = 0$  and in the first order in  $\lambda_B$  the equation holds

$$[T_{s+1}(x, y) - \bar{T}_{s+1}(x, y)]_{x=0} = \frac{d}{dy} \theta_s \quad (2.34)$$

with

$$\theta_s(y) = \lambda_B [q_s(y) + \sum_{k=2}^s \frac{1}{(k-1)!} \frac{d^{k-1}}{dy^{k-1}} \chi_{s+1-k}^k(y)]. \quad (2.35)$$

The higher powers of  $\lambda_B$  can contribute to (2.34) through the “resonance terms” similar to those discussed in [5]. It is plausible, however, that these do not spoil the general form of (2.34) but simply modify (2.35) by higher order terms in  $\lambda_B$ . It is also plausible (and can be supported to some extent by dimensional analysis of [5]) that “turning on” the bulk perturbation,  $\lambda \neq 0$ , converts (2.34) to (2.15).

We realise that the above arguments do not constitute a rigorous proof. First, we did not solve the problem of the “resonance terms” (this problem remains open in the bulk theory, too). More importantly, we did not analyse possible effects of mixing between the boundary and the bulk perturbations. We have shown, however, that the field theory (2.9) with (2.22) and (2.26) satisfies some very non-trivial necessary (but not sufficient) conditions of integrability and we conjecture that this boundary field theory with boundary is integrable.

### 3. BOUNDARY S-MATRIX

If the field theory (2.1) ((2.2)) is massive the space  $\mathcal{H}$  is the Fock space of multiparticle states. After rotation  $y = it$  to 1 + 1 Minkowski space-time these states are interpreted as the asymptotic (“in-” or “out-”) scattering states. For an integrable field theory the scattering is purely elastic and the corresponding S-matrix is factorizable. The factorizable scattering theory in infinite space is discussed in many papers and reviews (see e.g. [4,5,9-12]); below, we describe just some basics of the theory. The boundary theory (2.8)((2.9)) in Minkowski space is also interpreted as a scattering theory. For the integrable boundary



field theory this scattering theory is again purely elastic and the corresponding S-matrix is the “factorizable boundary S-matrix”. The “factorizable boundary scattering theory” is developed in close parallel with the “bulk” theory (see [13]). However there are still some gaps in this parallel (most importantly, the boundary analog of crossing-symmetry condition of the “bulk” S-matrix is not absolutely straightforward). It is the aim of this Section to fill these gaps.

We start with a brief description of the basics of the factorizable scattering theory in the infinite space (“bulk theory”). Assume that the theory contains  $n$  sorts of particles  $A_a$ ;  $a = 1, 2, \dots, n$  with the masses  $m_a$ . As usual, we describe the kinematic states of the particles in terms of their rapidities  $\theta$ ,

$$p_0 + p_1 = me^\theta; \quad p_0 - p_1 = me^{-\theta}, \quad (3.1)$$

where  $p_\mu$  are the components of the two-momentum and  $m$  is the particle mass. The asymptotic particle states are generated by the “particle creation operators”  $A_a(\theta)$

$$| A_{a_1}(\theta_1)A_{a_2}(\theta_2)\dots A_{a_N}(\theta_N) \rangle = A_{a_1}(\theta_1)A_{a_2}(\theta_2)\dots A_{a_N}(\theta_N) | 0 \rangle. \quad (3.2)$$

The state (3.2) is interpreted as an “in-state” if the rapidities  $\theta_i$  are ordered as  $\theta_1 > \theta_2 > \dots > \theta_N$ ; if instead  $\theta_1 < \theta_2 < \dots < \theta_N$  (3.2) is understood as an “out-state” of scattering. The “creation operators”  $A_a(\theta)$  satisfy the commutation relations

$$A_{a_1}(\theta_1)A_{a_2}(\theta_2) = S_{a_1 a_2}^{b_1 b_2}(\theta_1 - \theta_2)A_{b_2}(\theta_2)A_{b_1}(\theta_1) \quad (3.3)$$

which are used to relate the “in-” and the “out-” bases and hence completely describe the S-matrix. The coefficient functions  $S_{a_1 a_2}^{b_1 b_2}(\theta)$  are interpreted as the two-particle scattering amplitudes describing the processes  $A_{a_1}A_{a_2} \rightarrow A_{b_1}A_{b_2}$  (see Fig.2). The asymptotic states (3.2) diagonalise the local IM (2.6), the eigenvalues being determined by the relations

$$[P_s, A_a(\theta)] = \gamma_a^{(s)} e^{s\theta} A_a(\theta); \quad [\bar{P}_s, A_a(\theta)] = \gamma_a^{(s)} e^{-s\theta} A_a(\theta); \quad (3.4)$$

$$P_s | 0 \rangle = 0; \quad \bar{P}_s | 0 \rangle = 0, \quad (3.5)$$

where  $\gamma_a^{(s)}$  are constants ( $\gamma_a^{(1)} = m_a$ ). These IM must commute with the S-matrix; it follows in particular that the amplitude  $S_{a_1 a_2}^{b_1 b_2}(\theta)$  is zero unless  $m_{a_1} = m_{b_1}$  and  $m_{a_2} = m_{b_2}$  (other consequences are discussed in [5]).

Charge conjugation  $\mathbf{C}$  acts as an involution of the set of particles  $\{A_a\}$ , i.e.  $\mathbf{C} : A_a \leftrightarrow A_{\bar{a}}$ , where  $A_{\bar{a}} \in \{A_a\}$ , so that each particle in  $\{A_a\}$  is either neutral  $\mathbf{C}A_a = A_a$  or belongs to the particle-antiparticle pair  $(A_a, A_{\bar{a}})$ . In this Section we assume for simplicity that the theory under consideration respects  $\mathbf{C}$ ,  $\mathbf{P}$  and  $\mathbf{T}$  symmetries, i.e.

$$S_{a_1 a_2}^{b_1 b_2}(\theta) = S_{\bar{a}_1 \bar{a}_2}^{\bar{b}_1 \bar{b}_2}(\theta) = S_{a_2 a_1}^{b_2 b_1}(\theta) = S_{\bar{b}_2 \bar{b}_1}^{\bar{a}_2 \bar{a}_1}(\theta). \quad (3.6)$$

The two-particle S-matrix  $S_{a_1 a_2}^{b_1 b_2}(\theta)$  is the basic object of the theory. It must satisfy several general requirements

1. Yang-Baxter (or “factorization”) equation

$$S_{a_1 a_2}^{c_1 c_2}(\theta) S_{c_1 a_3}^{b_1 c_3}(\theta + \theta') S_{c_2 c_3}^{b_2 b_3}(\theta') = S_{a_2 a_3}^{c_2 c_3}(\theta') S_{a_1 c_3}^{c_1 b_3}(\theta + \theta') S_{c_1 c_2}^{b_1 b_2}(\theta); \quad (3.7)$$

here and below summation over repeated indices is assumed. This equation is illustrated in Fig.3. Formally, this equation appears as the associativity condition for the algebra (3.3).

## 2. Unitarity condition

$$S_{a_1 a_2}^{c_1 c_2}(\theta) S_{c_1 c_2}^{b_1 b_2}(-\theta) = \delta_{a_1}^{b_1} \delta_{a_2}^{b_2}. \quad (3.8)$$

Graphic representation of this equation is shown in Fig.4. It can also be obtained as the consistency condition for the algebra (3.3) (one applies (3.3) twice).

3. Analyticity and Crossing symmetry. The amplitudes  $S_{a_1 a_2}^{b_1 b_2}(\theta)$  are meromorphic functions of  $\theta$ , real at  $Re\theta = 0$ . The domain  $0 < Im\theta < \pi$  is called the “physical strip”. The physical scattering amplitudes of the “direct channel”  $A_{a_1} A_{a_2} \rightarrow A_{b_1} A_{b_2}$  are given by the values of the functions  $S_{a_1 a_2}^{b_1 b_2}(\theta)$  at  $Im\theta = 0$ ,  $Re\theta > 0$ . The values of these functions at  $Im\theta = 0$ ,  $Re\theta < 0$  describe the amplitudes of the “cross-channel”  $A_{a_2} A_{\bar{b}_1} \rightarrow A_{b_2} A_{\bar{a}_1}$ . The functions  $S_{a_1 a_2}^{b_1 b_2}(\theta)$  satisfy the crossing symmetry relation

$$S_{a_1 a_2}^{b_1 b_2}(\theta) = S_{a_2 \bar{b}_1}^{b_2 \bar{a}_1}(i\pi - \theta) \quad (3.9)$$

(see Fig.5). Combining this and the Eq.(3.8) one can derive the “cross-unitarity equation”

$$S_{a_1 c_2}^{c_1 b_2}(i\pi - \theta) S_{a_2 c_1}^{c_2 b_1}(i\pi + \theta) = \delta_{a_1}^{b_1} \delta_{a_2}^{b_2}. \quad (3.10)$$

4. Bootstrap condition. The only singularities of  $S_{a_1 a_2}^{b_1 b_2}(\theta)$  admitted in the physical strip are poles located at  $Re\theta = 0$ . The simple poles are interpreted as bound states, either of the direct or of the cross channel. As the bound states are stable particles they must be in the set  $\{A_a\}$ . Let  $iu_{a_1 a_2}^c$  be the position of the pole of  $S_{a_1 a_2}^{b_1 b_2}(\theta)$  associated with the “bound state”  $A_c$  of the direct channel. Then  $u_{a_1 a_2}^c$  must satisfy the relation

$$m_{a_1}^2 + m_{a_2}^2 - m_c^2 = -2m_{a_1} m_{a_2} \cos u_{a_1 a_2}^c, \quad (3.11)$$

i.e. the quantity  $\bar{u}_{a_1 a_2}^c = \pi - u_{a_1 a_2}^c$  can be interpreted as the internal angle of the euclidean triangle with the sides  $m_{a_1}, m_{a_2}, m_c$ . The pole term

$$S_{a_1 a_2}^{b_1 b_2}(\theta) \simeq i \frac{f_{a_1 a_2}^c f_c^{b_1 b_2}}{\theta - iu_{a_1 a_2}^c} \quad (3.12)$$

corresponds to the diagram in Fig.6, where the vertices represent the “three-particle couplings”  $f$  (Fig.7). In this situation the two-particle S-matrix satisfies the “bootstrap equation”

$$f_{a_1 a_2}^c S_{ca_3}^{bb_3}(\theta) = f_{c_1 c_2}^b S_{a_1 c_3}^{c_1 b_3}(\theta + i\bar{u}_{a_1 \bar{c}}^{\bar{a}_2}) S_{a_2 a_3}^{c_2 c_3}(\theta - i\bar{u}_{a_2 \bar{c}}^{\bar{a}_1}) \quad (3.13)$$

which is illustrated by Fig.8.

More details about the factorizable scattering theory and many examples can be found in the original papers and reviews (see e.g.[4,5,9-12]). Most of the examples are constructed

directly, by solving the Eq.(3.7-3.9) above. Following this approach one can pin down the S-matrix  $S_{a_1 a_2}^{b_1 b_2}(\theta)$  up to the so-called ‘‘CDD ambiguity’’

$$S_{a_1 a_2}^{b_1 b_2}(\theta) \rightarrow S_{a_1 a_2}^{b_1 b_2}(\theta)\Phi(\theta), \quad (3.14)$$

where the ‘‘CDD factor’’  $\Phi(\theta)$  is an arbitrary function satisfying the equations

$$\Phi(\theta) = \Phi(i\pi - \theta); \quad \Phi(\theta)\Phi(-\theta) = 1. \quad (3.15)$$

The bootstrap equation may impose further restrictions on this function.

Let us turn now to the semi-infinite system (2.8)((2.9)). Here again the states in  $\mathcal{H}_B$  can be classified as asymptotic scattering states. The scattering occurs in the semi-infinite  $1 + 1$  Minkowski space-time  $(x, t), t = -iy, x < 0$ . The initial state

$$| A_{a_1}(\theta_1)A_{a_2}(\theta_2)\dots A_{a_N}(\theta_N)\rangle_{B,in} \quad (3.16)$$

(the subscript  $B$  indicates that  $|\dots\rangle_B \in \mathcal{H}_B$ ) of the scattering consists of some number ( $N$ ) of ‘‘incoming’’ particles moving towards the boundary at  $x = 0$ , i.e. all the rapidities  $\theta_1, \theta_2, \dots, \theta_N$  are positive. In the infinite future,  $t \rightarrow \infty$ , this state becomes a superposition of the ‘‘out-states’’

$$| A_{b_1}(\theta_1')A_{b_2}(\theta_2')\dots A_{b_M}(\theta_M')\rangle_{B,out} \quad (3.17)$$

each containing some number of ‘‘outgoing’’ particles moving away from the boundary with negative rapidities  $\theta_1', \theta_2', \dots, \theta_M'$ . In integrable boundary field theory this process is constrained by the IM (2.16). Like in the ‘‘bulk’’ theory the operators  $H_s$  are diagonal in the basis of asymptotic states and

$$H_s | A_{a_1}(\theta_1)A_{a_2}(\theta_2)\dots A_{a_N}(\theta_N)\rangle_{B,in(out)} = \left( \sum_{i=1}^N 2\gamma_{a_i}^{(s)} \cosh(s\theta_i) + h^{(s)} \right) | A_{a_1}(\theta_1)A_{a_2}(\theta_2)\dots A_{a_N}(\theta_N)\rangle_{B,in(out)} \quad (3.18)$$

where  $h^{(s)}$  are some constants. The constraints

$$\sum_{i=1}^N \gamma_{a_i}^{(s)} \cosh(s\theta_i) = \sum_{j=1}^M \gamma_{b_j}^{(s)} \cosh(s\theta_j') \quad (3.19)$$

which follow from (3.18) show that  $M = N$  and the set of rapidities  $\{\theta_1', \theta_2', \dots, \theta_N'\}$  can differ only by permutation from  $\{-\theta_1, -\theta_2, \dots, -\theta_N\}$ , i.e. the boundary scattering theory is purely elastic. It is possible to argue that the S-matrix in this case has a factorizable structure.

The factorizable boundary scattering theory can be described in complete analogy with the ‘‘bulk’’ scattering theory. Again, the asymptotic states (3.16),(3.17) are generated by the ‘‘creation operators’’  $A_a(\theta)$  satisfying the same commutation relations (3.3). If  $\theta_1 > \theta_2 > \dots > \theta_N > 0$  the in-state (3.16) can be written as

$$A_{a_1}(\theta_1)A_{a_2}(\theta_2)\dots A_{a_N}(\theta_N) | 0 \rangle_B, \quad (3.20)$$

where  $| 0 \rangle_B$  is the ground state of  $H_B$ . One can think of the boundary as an infinitely heavy impenetrable particle  $B$  sitting at  $x = 0$  and formally write the state  $| 0 \rangle_B$  as

$$| 0 \rangle_B = B | 0 \rangle \quad (3.21)$$

in terms of “operator”  $B$  which we call the “boundary creating operator” (formally  $B : \mathcal{H} \rightarrow \mathcal{H}_B$ ; it is an interesting question whether (3.21) makes any more than just formal sense). The “operator”  $B$  satisfies the relations

$$A_a(\theta)B = R_a^b(\theta)A_b(-\theta)B, \quad (3.22)$$

the coefficient functions  $R_a^b(\theta)$  being interpreted as the amplitudes of one-particle reflection off the boundary, as shown in Fig.9. The Eq.(3.18) is reproduced if we assume (3.4), (3.5) and  $[H_s, B] = h^{(s)}B$ . It follows from (3.17) that  $R_a^b(\theta)$  vanishes if  $m_a \neq m_b$ . By purely algebraic manipulations, with the use of relations (3.3) and (3.22), one can expand any in-state (3.20) in terms of the out-states

$$A_{b_1}(-\theta_1)A_{b_2}(-\theta_2)\dots A_{b_N}(-\theta_N) | 0 \rangle_B, \quad (3.23)$$

( $\theta_1 > \theta_2 > \dots > \theta_N > 0$ ) thus expressing the  $N$ -particle S-matrix

$$\begin{aligned} & A_{a_1}(\theta_1)A_{a_2}(\theta_2)\dots A_{a_N}(\theta_N) | 0 \rangle_B = \\ & R_{a_1 a_2 \dots a_N}^{b_1 b_2 \dots b_N}(\theta_1, \theta_2, \dots, \theta_N) A_{b_1}(-\theta_1)A_{b_2}(-\theta_2)\dots A_{b_N}(-\theta_N) | 0 \rangle_B \end{aligned} \quad (3.24)$$

in terms of the “fundamental amplitudes”  $S_{a_1 a_2}^{b_1 b_2}(\theta)$  and  $R_a^b(\theta)$  which are basic objects of the factorizable boundary scattering theory. The amplitudes  $R_a^b(\theta)$  have to satisfy several general requirements analogous to the requirements 1 – 4 of the “bulk” theory above.

1'.Boundary Yang-Baxter equation

$$\begin{aligned} & R_{a_2}^{c_2}(\theta_2)S_{a_1 c_2}^{c_1 d_2}(\theta_1 + \theta_2)R_{c_1}^{d_1}(\theta_1)S_{d_2 d_1}^{b_2 b_1}(\theta_1 - \theta_2) = \\ & S_{a_1 a_2}^{c_1 c_2}(\theta_1 - \theta_2)R_{c_1}^{d_1}(\theta_1)S_{c_2 d_1}^{d_2 b_1}(\theta_1 + \theta_2)R_{d_2}^{b_2}(\theta_2) \end{aligned} \quad (3.25)$$

(represented graphically in Fig.10) can be obtained as the associativity condition of the algebra (3.22), (3.3). These equations have been introduced first in [13] and studied in relation with the quantum inverse scattering method for the integrable systems with boundary in many subsequent papers (see e.g. [15-17]). Note that (3.25) is the direct analog of (3.7).

2'.Boundary Unitarity condition

$$R_a^c(\theta)R_c^b(-\theta) = \delta_a^b \quad (3.26)$$

is also an absolutely straightforward generalization of (3.8) (see Fig.11). One obtains (3.26) applying (3.22) twice.

3'. The boundary analog of crossing-symmetry condition (3.9) is far less straightforward. Note that without any additional conditions the equations (3.25) and (3.26) are not restrictive enough. The ambiguity in the solution is

$$R_a^b(\theta) \rightarrow R_a^b(\theta)\Phi_B(\theta) \quad (3.27)$$

with arbitrary function  $\Phi_B$  which satisfy the equation

$$\Phi_B(\theta)\Phi_B(-\theta) = 1 \quad (3.28)$$

only, which does not even imply (contrary to (3.15)) that  $\Phi_B$  is analytic (meromorphic) in the full complex plane of  $\theta$ .

To reveal the analog of the “cross channel” of the scattering process (3.24) one has to use the alternative Hamiltonian picture for the boundary field theory mentioned in Sect.2. Consider 1 + 1 Minkowski space-time  $(\tau, y)$  with  $\tau = ix(\tau > 0)$  interpreted as time. The “equal time” section now is the infinite line  $-\infty < y < \infty$  and the space of states  $\mathcal{H}$  is the same as in the “bulk” theory. The boundary condition at  $x = 0$  appears in this picture as the initial condition at  $\tau = 0$ ; it is described by the “boundary state”  $|B\rangle$  as explained in Sect.2. As  $|B\rangle \in \mathcal{H}$  this state is a superposition of the asymptotic states (3.2) of the “bulk” theory. In integrable theory with “integrable boundary” the states (3.2) admitted to contribute to  $|B\rangle$  are restricted to satisfy (2.21). Noting that the eigenvalue of the operator  $P_s - \bar{P}_s$  on (3.2) is

$$\sum_{i=1}^N 2\gamma_{a_i}^{(s)} \sinh(s\theta) \quad (3.29)$$

we conclude that the particles  $A_a$  can enter the state  $|B\rangle$  only in pairs  $A_a(\theta)A_b(-\theta)$  of equal-mass particles of the opposite rapidities<sup>5</sup>. Thus we can write

$$|B\rangle = \mathcal{N} \sum_{N=0}^{\infty} \int_{0 < \theta_1 < \theta_2 < \dots < \theta_N} d\theta_1 d\theta_2 \dots d\theta_N K_{2N}^{a_N a_{N-1} \dots a_1, b_1 b_2 \dots b_N}(\theta_1, \theta_2, \dots, \theta_N) \\ A_{a_N}(-\theta_N) A_{a_{N-1}}(-\theta_{N-1}) \dots A_{a_1}(-\theta_1) A_{b_1}(\theta_1) A_{b_2}(\theta_2) \dots A_{b_N}(\theta_N) |0\rangle \quad (3.30)$$

where we have chosen the expansion in terms of the out-states;  $K_{2N}$  are certain coefficient functions which can be related to the amplitudes  $R$  in (3.24). The overall factor  $\mathcal{N}$  in (3.30) is chosen in such a way that  $K_0 = 1$ ; it is possible to argue that in the massive theory with a non-degenerate ground state  $|0\rangle_B$ , which we consider here, one can choose  $\mathcal{N} = 1$  by adding an appropriate constant term to the boundary action density  $b$  in (2.8) (or to the “perturbing field”  $\phi_B$  in (2.9)); in what follows we assume this choice. By applying the standard reduction technique to the equality (2.17), (2.19) one can show that (under appropriate normalization of the operators  $A_a(\theta)$ ) the following equations hold

---

<sup>5</sup> The possibility of zero rapidity particles  $A_a(0)$  entering the boundary state, which is evidently consistent with (2.21), is discussed below.

$$K^{a_N a_{N-1} \dots a_1, b_1 b_2 \dots b_N}(\theta_1, \theta_2, \dots, \theta_N) = R_{\bar{a}_1 \bar{a}_2 \dots \bar{a}_N}^{b_1 b_2 \dots b_N} \left( \frac{i\pi}{2} - \theta_1, \frac{i\pi}{2} - \theta_2, \dots, \frac{i\pi}{2} - \theta_N \right), \quad (3.31)$$

up to a constant phase factor which depends on the normalizations of the operators  $A_a(\theta)$ ; in what follows we assume that they are normalized in such a way that (3.31) holds as it stands.

Let us concentrate attention on the amplitude  $K^{ab}(\theta) \equiv K_2^{a,b}(\theta)$  describing the contribution

$$|B\rangle = \left( 1 + \int_0^\infty K^{ab}(\theta) A_a(-\theta) A_b(\theta) + \dots \right) |0\rangle \quad (3.32)$$

of the two-particle out-state  $A_a(-\theta) A_b(\theta) |0\rangle$  to the boundary state  $|B\rangle$ . It satisfies

$$K^{ab}(\theta) = R_{\bar{a}}^b \left( \frac{i\pi}{2} - \theta \right) \quad (3.33)$$

i.e. the “elementary reflection amplitude”  $R_{\bar{a}}^b(\theta)$  can be obtained by analytic continuation of the amplitude  $K^{ab}(\theta)$  to the domain  $Im\theta = \frac{i\pi}{2}, Re\theta < 0$ . The values of  $K^{ab}(\theta)$  at negative real  $\theta$  (corresponding to the “lower edge” of the cut in the energy plane) are interpreted as the coefficients of expansion of  $|B\rangle$  in terms of the *in*-states  $A_a(\theta) A_b(-\theta) |0\rangle, \theta > 0$

$$|B\rangle = \left( 1 + \int_0^\infty K^{ab}(-\theta) A_a(\theta) A_b(-\theta) + \dots \right) |0\rangle \quad (3.34)$$

As the *in*- and the *out*- states are related through the S-matrix, the amplitude  $K^{ab}(\theta)$  has to satisfy the following “boundary cross-unitarity condition”

$$K^{ab}(\theta) = S_{a'b'}^{ab}(2\theta) K^{b'a'}(-\theta) \quad (3.35)$$

which we consider to be the boundary analog of (3.10). It is illustrated by the diagram in Fig.12. With this equation added, the ambiguity in the solution of (3.25), (3.26) and (3.35) reduces to (3.27) with  $\Phi_B$  satisfying (3.28) and

$$\Phi_B(\theta) = \Phi_B(i\pi - \theta) \quad (3.36)$$

which is exactly the same as the “CDD ambiguity” (3.14), (3.15) in the “bulk” theory. Let us note that (3.35) allows one to write (3.32) as

$$|B\rangle = \left( 1 + \frac{1}{2} \int_{-\infty}^\infty K^{ab}(\theta) A_a(-\theta) A_b(\theta) + \dots \right) |0\rangle \quad (3.37)$$

Using the Equation (3.31) one can express all the amplitudes  $K_{2N}$  in (3.30) in terms of the two-particle boundary amplitudes  $K^{ab}(\theta)$  and the elements of the two-particle S-matrix  $S_{ab}^{cd}(\theta)$ . The result is in exact agreement with the following simple expression

$$|B\rangle = \Psi[K(\theta)] |0\rangle = \exp\left( \int_{-\infty}^\infty d\theta K(\theta) \right) |0\rangle \quad (3.38)$$

where

$$K(\theta) = \frac{1}{2} K^{ab}(\theta) A_a(-\theta) A_b(\theta) \quad (3.39)$$

Note that although the “creation operators”  $A_a(\theta)$  do not commute, the bilinear expressions (3.39) satisfy the commutativity conditions

$$[K(\theta), K(\theta')] = 0 \quad (3.39)$$

as a direct consequence of the “boundary Yang-Baxter equation” (3.25) and (3.33); therefore there is no ordering problem in (3.38). The commutativity (3.39) is crucial for the interpretation of  $\Psi$  in (3.38) as the “wave function” of the boundary state.

The “crossing equations” (3.33), (3.35) and the expression (3.38) for the boundary state are the main results of this Section. We feel that the simple universal form (3.38) of the boundary state is not accidental. However at the moment we do not have a satisfactory understanding of its profound meaning and we can not offer anything better than the direct derivation through (3.31).

4'. Now we turn to the “boundary bootstrap conditions”. There are two sorts of these: the bootstrap conditions describing the boundary scattering of the “bound-state” particles and the conditions related to possible existence of the “boundary bound states”.

If the particle  $A_c$  can be interpreted as the bound state of  $A_a A_b$  (i.e. the pole at  $\theta = iu_{ab}^c$ , with  $u_{ab}^c$  satisfying (3.11)), the boundary S-matrix elements  $R_c^d(\theta)$  can be obtained by taking the appropriate residue in the bound-state pole of the two-particle boundary S-matrix  $R_{ab}^{ab}(\theta_1, \theta_2)$ . This way one gets the equation

$$f_d^{ab} R_c^d(\theta) = f_c^{b_1 a_1} R_{a_1}^{a_2}(\theta + i\bar{u}_{ad}^b) S_{b_1 a_2}^{b_2 a} (2\theta + i\bar{u}_{ad}^b - i\bar{u}_{bd}^a) R_{b_2}^b(\theta - i\bar{u}_{bd}^a) \quad (3.40)$$

( $\bar{u} \equiv i\pi - u$ ) which has the diagrammatic representation shown in Fig.13. If the particles  $A_a$  and  $A_b$  have equal masses one can expect the appearance of a pole of  $R_a^b(\theta)$  at  $\theta = \frac{i\pi}{2} - \frac{u_{ab}^c}{2} = \bar{u}_{ab}^c - \frac{i\pi}{2}$  due to the diagram in Fig.14. The corresponding residue can be written as

$$K^{ab}(\theta) \simeq \frac{i}{2} \frac{f_c^{ab} g^c}{\theta - iu_{ab}^c}, \quad (3.41)$$

where the “three-particle couplings”  $f$  are the same as in (3.12) but  $g^c$  are new constants describing the “couplings” of the particles  $A_c$  to the boundary (Fig.14). More precisely, the nonzero value of  $g^c$  indicates that the boundary state  $|B\rangle$  contains a separate contribution of the zero-momentum particle  $A_c$ , i.e.

$$|B\rangle = \mathcal{N} \left( 1 + g^c A_c(0) + \frac{1}{2} \int_{-\infty}^{\infty} d\theta K^{ab}(\theta) A_a(-\theta) A_b(\theta) + \dots \right) |0\rangle. \quad (3.42)$$

Let us stress again that in our previous analysis of the boundary state we have ignored this possibility, i.e. strictly speaking validity of the equation (3.38) above is limited to the case when  $g^c = 0$  for all the particles  $A_c$  in the theory. It is easy to show that

$$[g^c A_c(0), K(\theta)] = 0, \quad (3.43)$$

where  $K(\theta)$  is the bilinear operator (3.39), and so in the general case one can look for the “boundary wave function” in the form  $\Psi[g^c A_c(0), K(\theta)]$ . The commutativity (3.43) follows from the relation

$$g^{c'} K^{a'b}(\theta) S_{c'a'}^{ca}(\theta) = g^{c'} K^{ab'}(\theta) S_{b'c'}^{cb}(\theta) \quad (3.44)$$

(Fig.15) which is easily obtained if one considers the limit  $\theta \rightarrow \frac{i\pi}{2} - \frac{1}{2}u_{a_1 b_1}^c$  in (3.25) and takes into account (3.13). It is also possible to show that if  $g^{c_1}, g^{c_2} \neq 0$  the amplitude  $K^{c_1 c_2}(\theta)$  has the pole at  $\theta = 0$  with the residue

$$K^{c_1 c_2}(\theta) \simeq -\frac{i}{2} \frac{g^{c_1} g^{c_2}}{\theta}; \quad (3.45)$$

This pole term is illustrated by the diagram in Fig.16.

Let us illustrate these bootstrap conditions with an example of the so-called “Lie-Yang field theory”. This field theory describes the scaling limit of Ising Model with purely imaginary external field, the critical point being the “Lie-Yang edge singularity” (see [18]). It is a massive field theory which can be obtained by perturbing the  $c = -\frac{22}{5}$  minimal CFT by its only nontrivial primary field  $\varphi \equiv \Phi_{(1,2)}$ , which has a conformal dimension  $\Delta = -\frac{1}{5}$ . Mussardo and Cardy[11] have shown that the “bulk” theory is integrable; they have also found the corresponding factorizable “bulk” S-matrix. The theory contains only one species of particles,  $A$ , and the “bulk” S-matrix is described by

$$A(\theta_1)A(\theta_2) = S(\theta_1 - \theta_2)A(\theta_2)A(\theta_1) \quad (3.46)$$

with

$$S(\theta) = \frac{\sinh \theta + i \sin \frac{2\pi}{3}}{\sinh \theta - i \sin \frac{2\pi}{3}}. \quad (3.47)$$

The pole of  $S(\theta)$  at  $\theta = \frac{2\pi i}{3}$  (which has negative residue thus making non-unitarity of this theory manifest) corresponds to the same particle  $A$  appearing as the “ $AA$  bound state”. Here we do not attempt to analyze the possible integrable boundary conditions in this theory; we just assume that such ones do exist. Then the factorizable boundary S-matrix is described by (3.46) and

$$A(\theta)B = R(\theta)A(-\theta)B, \quad (3.48)$$

where the boundary scattering amplitude  $R$  has to satisfy (3.26) and (3.35) (the boundary Yang-Baxter equation (3.25) is satisfied identically), i.e.

$$R(\theta)R(-\theta) = 1; \quad K(\theta) = S(2\theta)K(-\theta); \quad K(\theta) = R\left(\frac{i\pi}{2} - \theta\right). \quad (3.49)$$

As the particle  $A$  appears as the “bound state”, the equation (3.40) has to be imposed as well,



$$R(\theta) = S(2\theta)R(\theta + \frac{i\pi}{3})R(\theta - \frac{i\pi}{3}). \quad (3.50)$$

There are two “minimal” solutions to (3.49), (3.50)<sup>6</sup>,

$$R_{(1)}(\theta) = -\frac{\sinh(\frac{\theta}{2} + \frac{i\pi}{4}) \sinh(\frac{\theta}{2} + \frac{i\pi}{12}) \sinh(\frac{\theta}{2} - \frac{i\pi}{3})}{\sinh(\frac{\theta}{2} - \frac{i\pi}{4}) \sinh(\frac{\theta}{2} - \frac{i\pi}{12}) \sinh(\frac{\theta}{2} + \frac{i\pi}{3})}, \quad (3.51)$$

$$R_{(2)}(\theta) = \frac{\sinh(\frac{\theta}{2} - \frac{i\pi}{4}) \sinh(\frac{\theta}{2} - \frac{5i\pi}{12}) \sinh(\frac{\theta}{2} - \frac{i\pi}{3})}{\sinh(\frac{\theta}{2} + \frac{i\pi}{4}) \sinh(\frac{\theta}{2} + \frac{5i\pi}{12}) \sinh(\frac{\theta}{2} + \frac{i\pi}{3})} \quad (3.52)$$

(of course  $R_{(1)}$  and  $R_{(2)}$  are related through the “CDD factor” (3.27)). These two solutions have rather different physical properties.  $R_{(1)}(\theta)$  exhibits a pole at  $\theta = \frac{i\pi}{6}$  associated with the diagram in Fig.14. This means that for this solution the boundary state  $|B\rangle_{(1)}$  contains the single-particle contribution

$$|B\rangle_{(1)} = (1 + g_{(1)}A(0) + \dots) |0\rangle \quad (3.53)$$

with non-zero amplitude  $g_{(1)}$ . Explicit calculation gives

$$g_{(1)} = 2i\sqrt{2\sqrt{3} - 3}. \quad (3.54)$$

Accordingly, the amplitude  $R_{(1)}(\theta)$  has a pole at  $\theta = \frac{i\pi}{2}$  with the residue

$$R_{(1)}(\theta) \simeq \frac{ig_{(1)}^2}{2\theta - i\pi}. \quad (3.55)$$

The solution  $R_{(2)}$  does not have any poles in the physical strip, i.e.  $g_{(2)} = 0$ .

In the general case the poles (3.41) and (3.45) do not exhaust all possible singularities the amplitudes  $R_a^b(\theta)$  may have in the “physical strip”  $0 \leq Im\theta \leq \pi$ . Even with given boundary action (2.8)((2.9)) the boundary can exist in several stable states  $|\alpha\rangle_B$ ;  $\alpha = 0, 1, \dots, n_B - 1$  (let us stress that all these states belong to  $\mathcal{H}_B$ ). These states are eigenstates of the operators (2.16)

$$H_s |\alpha\rangle_B = h_\alpha^{(s)} |\alpha\rangle_B, \quad (3.56)$$

with some eigenvalues  $h_\alpha^{(s)}$ ; in particular  $e_\alpha = h_\alpha^{(1)}$  is the energy of the state  $|\alpha\rangle_B$ . We assume that  $e_0$  is the smallest of  $e_\alpha$ , i.e. as before the state  $|0\rangle_B$  is the ground state of  $H_B$ <sup>7</sup>. If  $e_\alpha - e_0 < \min m_a$  the state  $|\alpha\rangle_B$  is stable just because its decay is forbidden energetically; higher IM  $H_s$  could ensure stability of  $|\alpha\rangle_B$  even if  $e_\alpha - e_0 > \min m_a$ . In any case, the states  $|\alpha\rangle_B$  must show up as the virtual states in the boundary scattering processes. The amplitudes  $R_a^b(\theta)$  can exhibit the poles

---

<sup>6</sup> We call “minimal” the solution which has “minimal” set of zeroes and poles in the physical strip  $0 \leq Im\theta \leq \pi$ , i.e. one can not reduce the total number of zeroes and poles in this strip without violating (3.49), (3.50).

<sup>7</sup> Here we assume that the ground state is not degenerate.

$$R_a^b(\theta) \simeq \frac{i}{2} \frac{g_{a0}^\alpha g_\alpha^{b0}}{\theta - iv_{0a}^\alpha}, \quad (3.57)$$

where  $g_{a0}^\alpha$  are “boundary-particle couplings” and  $v_{0a}^\alpha$  satisfy

$$e_0 + m_a \cos(v_{0a}^\alpha) = e_\alpha, \quad (3.58)$$

see Fig.17. Thus the states  $|\alpha\rangle_B$  with  $e_\alpha > e_0$  can be interpreted as the “boundary bound states”,  $e_\alpha - e_0$  being the binding energy.

In this situation it is natural to generalize (3.22) to

$$A_a(\theta)B_\alpha = R_{a\alpha}^{b\beta}(\theta)A_b(-\theta)B_\beta, \quad (3.59)$$

where  $B_\alpha$  are formal “boundary creating operators” analogous to (3.21) and  $R_{a\alpha}^{b\beta}(\theta)$  are amplitudes of the scattering process involving the change of the state of boundary, as shown in Fig.18. Again, the amplitude  $R_{a\alpha}^{b\beta}(\theta)$  does not vanish only if  $m_a = m_b$  and  $e_\alpha = e_\beta$ , as it follows from (3.56). The equations (3.25), (3.26), (3.33), (3.35), (3.40) above can be generalized in an obvious way to include these amplitudes. Here we quote only the “boundary bound state bootstrap equation”

$$g_{a\alpha}^\gamma R_{b\gamma}^{b'\beta}(\theta) = g_{a_2\gamma}^\beta S_{ba}^{b_1 a_1}(\theta - iv_{a\alpha}^\beta) R_{b_1\alpha}^{b_2\gamma}(\theta) S_{a_1 b_2}^{a_2 b'}(\theta + iv_{a\alpha}^\beta) \quad (3.60)$$

shown in Fig.19; here the parameter  $v_{a\alpha}^\beta$  satisfies the equation

$$e_\alpha + m_a \cos(v_{a\alpha}^\beta) = e_\beta, \quad (3.61)$$

analogous to (3.38), and  $g_{a\alpha}^\beta$  are the “particle-boundary coupling constants” (Fig.20) entering the residues

$$R_{a\alpha}^{b\beta}(\theta) \simeq \frac{i}{2} \frac{g_{a\alpha}^\gamma g_\gamma^{b\beta}}{\theta - iv_{a\alpha}^\gamma}. \quad (3.62)$$

Note that (3.44) and (3.45) can be considered as particular cases  $\alpha = \beta = \gamma = 0$  of (3.60) and (3.62), resp., if we think of the ground state  $|0\rangle_B$  as the “bound state” of some particle  $A_c$  (with  $g^c \neq 0$ ) and itself.

We have implicitly assumed in the above discussion that the ground state  $|0\rangle_B$  is non-degenerate. This assumption is taken for the sake of simplicity only; it is not necessary either from a physical point of view or for mathematical consistency. It is straightforward to incorporate the possibility of degenerate ground states into the above picture. In the next two Sections, where we consider examples of the factorizable boundary scattering theory, we will encounter this interesting possibility.

#### 4.ISING MODEL.

As is known, the scaling limit of the Ising Model with zero external field is described by the free Majorana fermion field theory

$$\mathcal{A} = \int dydx \quad a_{FF}(\psi, \bar{\psi}), \quad (4.1)$$

where

$$a_{FF}(\psi, \bar{\psi}) = \psi \partial_{\bar{z}} \psi - \bar{\psi} \partial_z \bar{\psi} + m \psi \bar{\psi}. \quad (4.2)$$

Here  $(z, \bar{z})$  are complex coordinates and  $m \simeq T_c - T$ . The field theories corresponding to the high-temperature ( $T - T_c \rightarrow 0^+$ ) and the low temperature ( $T - T_c \rightarrow 0^-$ ) phases of the Ising Model are equivalent (they are related through the duality transformation  $\psi \rightarrow \psi; \quad \bar{\psi} \rightarrow -\bar{\psi}$ , which changes the sign of  $m$  in (4.1)). Here we will assume that  $m > 0$  and interpret this field theory as the low-temperature phase. In this phase there are two degenerate ground states,  $|0, \pm\rangle$ , so that the corresponding expectation values of the spin field  $\sigma(x)$  are  $\langle \sigma(x) \rangle_{\pm} = \pm \bar{\sigma}$ , where  $\bar{\sigma} \sim m^{\frac{1}{8}}$  is the spontaneous magnetization.

The bulk theory (4.1) contains one sort of particles - the free fermion  $A$  with the mass  $m$ . Intuitively, this particle can be understood as a ‘‘kink’’ (or ‘‘domain wall’’) separating domains of opposite magnetization. The corresponding particle creation operator  $A^\dagger(\theta)$  (we denote it here  $A^\dagger$  to comply with the conventional notations) can be defined through the decomposition

$$\begin{aligned} \psi(x, t) &= \int_{-\infty}^{\infty} d\theta [\omega e^{\frac{\theta}{2}} A(\theta) e^{imx \sinh \theta + imt \cosh \theta} + \bar{\omega} e^{\frac{\theta}{2}} A^\dagger(\theta) e^{-imx \sinh \theta - imt \cosh \theta}], \\ \bar{\psi}(x, t) &= \int_{-\infty}^{\infty} d\theta [\bar{\omega} e^{-\frac{\theta}{2}} A(\theta) e^{imx \sinh \theta + imt \cosh \theta} + \omega e^{-\frac{\theta}{2}} A^\dagger(\theta) e^{-imx \sinh \theta - imt \cosh \theta}], \end{aligned} \quad (4.3)$$

where  $t = iy$  and  $\omega = \exp(\frac{i\pi}{4}); \quad \bar{\omega} = \exp(-\frac{i\pi}{4})$ . The operators  $A(\theta), A^\dagger(\theta)$  satisfy canonical anticommutation relations  $\{A(\theta), A^\dagger(\theta')\} = \delta(\theta - \theta'); \quad \{A(\theta), A(\theta')\} = \{A^\dagger(\theta), A^\dagger(\theta')\} = 0$ . The last of these relations,

$$A^\dagger(\theta) A^\dagger(\theta') = -A^\dagger(\theta') A^\dagger(\theta), \quad (4.4)$$

has the same meaning as (3.3) so that the free-fermion two particle S-matrix is [19]

$$S = -1. \quad (4.5)$$

Let us consider now this field theory in the half-plane  $x < 0$ , with the boundary at  $x = 0$ . Assuming that the boundary conditions are chosen to be integrable, we can define the boundary scattering amplitude  $R(\theta)$ ,

$$A^\dagger(\theta) B = R(\theta) A^\dagger(-\theta) B. \quad (4.6)$$

As is discussed in Sect.3, this amplitude has to satisfy (3.26), (3.33), (3.35), i.e.

$$R(\theta) R(-\theta) = 1; \quad K(\theta) = -K(-\theta);$$

$$K(\theta) = R\left(\frac{i\pi}{2} - \theta\right). \quad (4.7)$$

We consider first two simplest boundary conditions - the “free” and the “fixed” ones<sup>8</sup>.

a). “Fixed” boundary condition. In the microscopic theory this boundary condition corresponds to fixing the boundary spins to be, say, +1. Obviously, this boundary condition removes the ground state degeneracy. In terms of the fermion fields  $\psi, \bar{\psi}$  the “fixed” boundary condition can be written as

$$(\psi + \bar{\psi})_{x=0} = 0. \quad (4.8)$$

In presence of the boundary, the fields  $\psi, \bar{\psi}$  still enjoy the decomposition (4.3), although the operators  $A, A^\dagger$  (now acting in  $\mathcal{H}_B$ ) are not all independant but satisfy the relations

$$\begin{aligned} (\omega e^{\frac{\theta}{2}} + \bar{\omega} e^{-\frac{\theta}{2}})A(\theta) &= -(\bar{\omega} e^{\frac{\theta}{2}} + \omega e^{-\frac{\theta}{2}})A(-\theta); \\ (\bar{\omega} e^{\frac{\theta}{2}} + \omega e^{-\frac{\theta}{2}})A^\dagger(\theta) &= -(\omega e^{\frac{\theta}{2}} + \bar{\omega} e^{-\frac{\theta}{2}})A^\dagger(-\theta) \end{aligned} \quad (4.9)$$

which follow from (4.8). From the last of (4.9) we find

$$R_{fixed}(\theta) = i \tanh\left(\frac{i\pi}{4} - \frac{\theta}{2}\right). \quad (4.10)$$

Alternatively, one could use another hamiltonian picture, with  $\tau = -ix$  interpreted as the time. In this picture the fields  $\chi = \omega\psi, \bar{\chi} = \bar{\omega}\bar{\psi}$  enjoy the same decomposition (4.3) with the substitution  $x \rightarrow y, t \rightarrow \tau$  and operators  $A(\theta), A^\dagger(\theta)$  acting in the Hilbert space  $\mathcal{H}$  of the bulk theory. The boundary condition (4.6) appears as the initial condition  $(\chi + i\bar{\chi})_{\tau=0} = 0$  which is understood as the equation

$$(\chi + i\bar{\chi})_{\tau=0} | B_{fixed} \rangle = 0 \quad (4.11)$$

for the corresponding boundary state  $| B_{fixed} \rangle$ . In terms of  $A, A^\dagger$  this equation reads

$$[\cosh(\theta/2)A(\theta) + i \sinh(\theta/2)A^\dagger(-\theta)] | B_{fixed} \rangle = 0, \quad (4.12)$$

and hence the boundary state can be written as

$$| B_{fixed} \rangle = \exp\left\{\frac{1}{2} \int_{-\infty}^{\infty} d\theta K_{fixed}(\theta) A^\dagger(-\theta) A^\dagger(\theta)\right\} | 0 \rangle \quad (4.13)$$

with

$$K_{fixed}(\theta) = i \tanh \frac{\theta}{2} \quad (4.14)$$

and  $| 0 \rangle = | 0, + \rangle$ . Although (4.13) with  $| 0 \rangle = | 0, - \rangle$  solves (4.12) as well, it is easy to see that in the infinite system this state does not contribute to  $| B_{fixed} \rangle$  (in a large system,

---

<sup>8</sup> In the conformal field theory of the Ising model (which describes the case  $m = 0$ ), these are just the two possible conformal boundary conditions; they are analyzed in [7,8].

finite in the  $y$ -direction,  $-L/2 < y < L/2$ , its contribution is suppressed as  $\exp(-mL)$ . Note that (4.10), (4.14) satisfy (4.7).

b). “Free” boundary condition. In the microscopic theory one imposes no restrictions on the boundary spins. Correspondingly, the ground state is still two-fold degenerate. Again, in terms of the fermions  $\psi, \bar{\psi}$  this boundary condition has a very simple form

$$(\psi - \bar{\psi})_{x=0} = 0. \quad (4.15)$$

The same computation as in the previous case gives

$$R_{free}(\theta) = -i \coth\left(\frac{i\pi}{4} - \frac{\theta}{2}\right). \quad (4.16)$$

Note that the corresponding boundary state amplitude

$$K_{free}(\theta) = -i \coth \frac{\theta}{2} \quad (4.17)$$

exhibits a pole at  $\theta = 0$  (this pole is related to the existence of the zero-energy mode  $\psi = \bar{\psi} \sim \exp mx$  which satisfies (4.15)), which indicates that the boundary state  $|B_{free}\rangle$  contains the contribution of a zero-momentum one-particle state,

$$|B_{free}\rangle = (1 + A^\dagger(0) + \dots) |0\rangle. \quad (4.18)$$

Of course, this feature is easily understood in physical terms. Semi-infinite Ising Model at  $T, T_c$  with free boundary condition admits a particular equilibrium state, characterized by the asymptotic conditions  $\langle\sigma(x, y)\rangle \rightarrow +\bar{\sigma}$  as  $y \rightarrow +\infty$  and  $\langle\sigma(x, y)\rangle \rightarrow -\bar{\sigma}$  as  $y \rightarrow -\infty$ . This state contains an infinitely long (fluctuating) “domain wall” attached to the boundary, which separates two domains of opposite magnetization, as shown in Fig.21. This “domain wall” configuration is interpreted as a zero-momentum particle emitted by the boundary state. It is not difficult to check that the boundary state

$$|B_{free}\rangle = (1 + A^\dagger(0)) \exp\left\{\frac{1}{2} \int_{-\infty}^{\infty} K_{free}(\theta) A^\dagger(-\theta) A^\dagger(\theta)\right\} |0\rangle \quad (4.19)$$

satisfies the boundary state equation

$$\int d\theta f(\theta) [\sinh(\theta/2) A(\theta) - i \cosh(\theta/2) A^\dagger(-\theta)] |B_{free}\rangle = 0 \quad (4.20)$$

( $f(\theta)$  is an arbitrary smooth function) which follows from the “initial condition”  $(\chi - i\bar{\chi})_{\tau=0} = 0$ .

The simple boundary conditions above can be obtained as the two limiting cases of the more general integrable boundary condition which we describe below.

c). “Boundary magnetic field”. This boundary condition is obtained by introducing a nonzero external field  $h$  (“boundary magnetic field”) which couples only to the boundary spins. Obviously,  $h = 0$  correspond to the “free” case above while in the limit  $h \rightarrow \infty$  one recovers the “fixed” boundary condition. The boundary magnetic field can be considered as the perturbation of the “free” boundary condition,

$$\mathcal{A}_h = \mathcal{A}_{free} + h \int_{-\infty}^{\infty} dy \sigma_B(y), \quad (4.21)$$

where  $\sigma_B(y)$  is the “boundary spin operator” [7,8]<sup>9</sup>. The action  $\mathcal{A}_{free}$  is

$$\mathcal{A}_{free} = \int_{-\infty}^{\infty} dy \int_{-\infty}^0 dx a_{FF}(\psi, \bar{\psi}) + 1/2 \int_{-\infty}^{\infty} dy [(\psi \bar{\psi})_{x=0} + a \dot{a}]. \quad (4.22)$$

Here  $\dot{a} = \frac{d}{dy}a$ , and  $a(y)$  is an additional (fermionic) boundary degree of freedom which is introduced to describe the ground-state degeneracy. The quantum operator  $a$  associated with the boundary field  $a(y)$  anticommutes with  $\psi, \bar{\psi}$  and satisfies

$$a^2 = 1, \quad (4.23)$$

so that for the free boundary condition one has

$$a |0, \pm\rangle_B = |0, \mp\rangle_B. \quad (4.24)$$

The equation (4.15) follows directly from the action (4.22). The boundary spin operator  $\sigma_B(y)$  is analyzed (along with other boundary operators) in [7,8]. It is identified with the degenerate primary boundary field  $\psi_{(1,3)}$  of dimension  $\Delta = 1/2$ . In the Lagrangian picture described above it can be written as

$$\sigma_B(y) = \frac{1}{2}(\psi + \bar{\psi})_{x=0}(y)a(y), \quad (4.25)$$

so that the dimension of  $h$  in (4.21) is  $[mass]^{1/2}$ .

One obtains, from (4.21) and (4.25), the boundary condition for the fermi fields  $\psi, \bar{\psi}$ ,

$$i \frac{d}{dy}(\psi - \bar{\psi})_{x=0} = \frac{h^2}{2}(\psi + \bar{\psi})_{x=0}. \quad (4.26)$$

With this, it is straightforward to compute the boundary scattering amplitude for (4.21),

$$R_h(\theta) = i \tanh(i\pi/4 - \theta/2) \frac{\kappa - i \sinh \theta}{\kappa + i \sinh \theta}, \quad (4.27)$$

where

$$\kappa = 1 - \frac{h^2}{2m}. \quad (4.28)$$

Note that for  $h > 0$  the amplitude  $R_h(\theta)$  does not have a pole at  $\theta = i\pi/2$  and hence there is no one-particle (and any odd-number particle) contributions to the corresponding boundary state  $|B_h\rangle$ ; this state has therefore the general form (3.38) with  $|0\rangle = |0, \pm\rangle$ , for  $h = \pm|h|$ , resp., and with

---

<sup>9</sup> This perturbation generates a “flow” from the free boundary condition down to the fixed one. In the case of conformal “bulk” theory ( $m = 0$ ) this flow was studied in [20].

$$K_h(\theta) = i \tanh(\theta/2) \frac{\kappa + \cosh \theta}{\kappa - \cosh \theta}. \quad (4.29)$$

Again, this is not very surprising. The nonzero boundary magnetic field removes the ground-state degeneracy; for  $h$  sufficiently small, the two-fold degenerate ground state  $|0, \pm\rangle_B$  of the “free” boundary splits into two non-degenerate states  $|0\rangle_B$  and  $|1\rangle_B$ , where  $|1\rangle_B$  can be interpreted as the boundary bound state. For  $0 < h^2 < 2m$  we can parametrize (4.28) as

$$\kappa = \cos v. \quad (4.30)$$

with real  $v$ ,  $0 < v < \pi/2$ . In this domain the amplitude (4.27) exhibits a pole in the physical strip at  $\theta = i(\pi/2 - v)$  which is associated with the state  $|1\rangle_B$ . Physical interpretation of this boundary bound state is simple. For  $h \neq 0$  the equilibrium “ground state” which minimizes the free energy features an asymptotic behaviour  $\langle \sigma(x, y) \rangle_0 \rightarrow +\text{sign}(h)\bar{\sigma}$  as  $x \rightarrow -\infty$ . However, for  $h$  sufficiently small, there exists another stable equilibrium state with  $\langle \sigma(x, y) \rangle_1 \rightarrow -\text{sign}(h)\bar{\sigma}$  as  $x \rightarrow -\infty$ . Although its free energy is higher by a positive boundary term, it is indeed stable as in the infinite system there is no finite kinetics of decay (in a system finite in the  $y$  direction the decay probability is suppressed as  $\exp(-mL \cos v)$ ). Clearly, the energies  $e_0$  and  $e_1$  of the states  $|0\rangle_B$  and  $|1\rangle_B$  have the meaning of specific (per unit boundary length) boundary free energies of these two equilibrium states. From (4.27) we have

$$e_1 - e_0 = m \sin v. \quad (4.31)$$

It is also clear that the expectation values  $\langle \dots \rangle_1$  can be obtained by analytic continuation of  $\langle \dots \rangle_0$  from  $h$  to  $-h$ . So, in this very domain  $|h| < \sqrt{2m}$  “boundary hysteresis”[21] can be observed. It is possible to show that these expectation values can be computed as the matrix elements

$$\langle \dots \rangle_1 = \frac{{}_B\langle 1 | \dots | 1 \rangle_B}{{}_B\langle 1 | 1 \rangle_B} = \frac{\langle 0' | \dots | B'_h \rangle}{\langle 0' | B'_h \rangle}, \quad (4.32)$$

where the last expression contains the “excited boundary state”

$$|B'_h\rangle = \exp\left(\frac{1}{2} \int_{\mathcal{C}} d\theta K_h(\theta) A^\dagger(-\theta) A^\dagger(\theta)\right) |0'\rangle \quad (4.33)$$

with the integration taken along contour  $\mathcal{C}$  shown in Fig.2, and  $|0'\rangle = |0, \mp\rangle$  for  $h = \pm|h|$ .

As  $h$  approaches the “critical” value  $h_c = \sqrt{2m}$  (i.e.  $v$  approaches  $\pi/2$ ), the “boundary bound state” becomes weakly bound;  $e_1 - e_0 - m = -2m \sin^2(\pi/4 - v/2) \rightarrow 0$ , and its effective size  $\xi = (e_1 - e_0 - m)^{-1}$  diverges as  $(h_c - h)^{-2}$ . Correspondingly, the equilibrium state  $\langle \dots \rangle_1$  develops large boundary fluctuations which propagate deep into the bulk,

$$\langle \sigma(x, y) \rangle_1 + \bar{\sigma} \simeq \exp(x/\xi) \quad \text{as } x \rightarrow -\infty. \quad (4.34)$$

At  $h = h_c$  the boundary condition (4.26) reduces to

$$\frac{\partial}{\partial x}(\psi + \bar{\psi})_{x=0} = 0 \quad (4.35)$$

and the boundary scattering amplitude can be written as

$$R_{h=h_c}(\theta) = -i \tanh(i\pi/4 - \theta/2) \quad (4.36)$$

which differs only by a sign from (4.10). This difference is very significant though; (4.36) admits the state  $A^\dagger(0) | 0 \rangle_B$  - remnant of  $| 1 \rangle_B$ .

For  $2m < h^2 \leq 4m$  we can still parametrize  $\kappa$  as in (4.30), with real  $v$ . However, now  $\pi/2 \leq v \leq \pi$ . The pole of  $R_h$  at  $\theta = i(\pi/2 - v)$  leaves the physical strip; there is no “boundary bound state” in this domain, and the equilibrium state is unique. At  $h = 2\sqrt{m}$  the expression (4.27) simplifies as

$$R_{h=2\sqrt{m}}(\theta) = -i \tanh^3(i\pi/4 - \theta/2), \quad (4.37)$$

i.e. the boundary-state amplitude  $K_{h=2\sqrt{m}}$  possesses a third-order zero at  $\theta = 0$ . This seems to affect the  $x \rightarrow -\infty$  asymptotic of  $\langle \sigma(x, y) \rangle$ , but at the moment we do not have a clear physical interpretation of this phenomenon.

Finally, at  $h^2 > 4m$  one can write  $\kappa = -\cosh \theta_0$  with  $\theta_0$  real and positive. In this regime the amplitude  $R_h$  shows two “resonance” poles at  $\theta = -i\pi/2 \pm \theta_0$ . As  $h$  grows these poles depart to infinity and ultimately  $R_\infty$  reduces to (4.10).

Clearly, the behavior described above agrees with the expected “flow” from the “free” boundary condition down to the “fixed” one[20]. This example is particularly simple because the described boundary field theory is not only integrable but free - both the bulk and the boundary equations of motion for  $\psi, \bar{\psi}$  are linear. It is easy to show that all solutions of (4.7) correspond to free-field boundary conditions, generalizing (4.26) in an obvious way.

## 5. BOUNDARY SINE-GORDON MODEL

In this Section we consider the integrable boundary theory for the sine-Gordon model. The bulk sine-Gordon field theory is described by the euclidean action (2.1) with

$$a(\varphi, \partial_\mu \varphi) = \frac{1}{2} (\partial_\mu \varphi)^2 - \frac{m^2}{\beta^2} \cos(\beta\varphi) \quad (5.1)$$

where  $\varphi(x, y)$  is a scalar field and  $\beta$  is a dimensionless coupling constant. This model is well known to be integrable both as classical and quantum field theories (see e.g.[22]. In the quantum theory, the discrete symmetry  $\varphi \rightarrow \varphi + \frac{2\pi}{\beta} N, N \in \mathbf{Z}$  is spontaneously broken at  $\beta^2 < 8\pi$ [23]; in this domain the theory is massive and its particle spectrum consists of a soliton-antisoliton pair  $(A, \bar{A})$  (with equal masses) and a number (which depends on  $\beta$ ) of neutral particles (“quantum breathers”)  $B_n, n = 1, 2, \dots < \lambda$ , where

$$\lambda = \frac{8\pi}{\beta^2} - 1. \quad (5.2)$$



The soliton (antisoliton) carries a positive (negative) unit of “topological charge”

$$q = \frac{\beta}{2\pi} \int_{-\infty}^{+\infty} dx \frac{\partial}{\partial x} \varphi(x, y) = \frac{\beta}{2\pi} [\varphi(+\infty, y) - \varphi(-\infty, y)]. \quad (5.3)$$

The charge conjugation  $\mathbf{C} : A \leftrightarrow \bar{A}$  is related to  $\varphi \leftrightarrow -\varphi$  symmetry of (5.1). The particles  $B_n$  are neutral (they are interpreted as the soliton-antisoliton bound states),  $B_n$  with even (odd)  $n$  being  $\mathbf{C}$ -even ( $\mathbf{C}$ -odd). The masses of  $B_n$  are

$$m_n = 2M_s \sin\left(\frac{n\pi}{2\lambda}\right); \quad n = 1, 2, \dots < \lambda, \quad (5.4)$$

where  $M_s$  is the soliton mass.

Factorizable scattering of solitons is described by the commutation relations

$$\begin{aligned} A(\theta)A(\theta') &= a(\theta - \theta')A(\theta')A(\theta), & \bar{A}(\theta)\bar{A}(\theta') &= a(\theta - \theta')\bar{A}(\theta')\bar{A}(\theta), \\ A(\theta)\bar{A}(\theta') &= b(\theta - \theta')\bar{A}(\theta')A(\theta) + c(\theta - \theta')A(\theta')\bar{A}(\theta), \end{aligned} \quad (5.5)$$

where  $A(\theta)$  and  $\bar{A}(\theta)$  are soliton and antisoliton creation operators and the two-particle scattering amplitudes  $a, b, c$  are given by

$$\begin{aligned} a(\theta) &= \sin(\lambda(\pi - u))\rho(u), \\ b(\theta) &= \sin(\lambda u)\rho(u), \\ c(\theta) &= \sin(\lambda\pi)\rho(u), \end{aligned} \quad (5.6)$$

where  $u = -i\theta$  and

$$\begin{aligned} \rho(u) &= -\frac{1}{\pi} \Gamma(\lambda) \Gamma(1 - \lambda u/\pi) \Gamma(1 - \lambda + \lambda u/\pi) \prod_{l=1}^{\infty} \frac{F_l(u) F_l(\pi - u)}{F_l(0) F_l(\pi)}; \\ F_l(u) &= \frac{\Gamma(2l\lambda - \lambda u/\pi) \Gamma(1 + 2l\lambda - \lambda u/\pi)}{\Gamma((2l+1)\lambda - \lambda u/\pi) \Gamma(1 + (2l-1)\lambda - \lambda u/\pi)}. \end{aligned} \quad (5.7)$$

The amplitudes of  $AB_n$  and  $B_n B_m$  scatterings can be obtained from these with the use of (3.13), they can be found in [4].

Let us consider now this field theory in presence of the boundary at  $x = 0$ , described by the action (2.8). The first question which arises here is how to choose the “boundary action”  $b(\varphi_B, d/dy\varphi_B)$  in (2.8) in order to preserve integrability. General classification of integrable boundary actions seems to be an interesting open problem. Here we just claim that the boundary sine-Gordon theory (2.8), (5.1) with

$$b(\varphi) = -M \cos\left(\frac{\beta}{2}(\varphi - \varphi_0)\right), \quad (5.8)$$

where  $M$  and  $\varphi_0$  are free parameters, is integrable. This claim is supported by an explicit computation of the first nontrivial integral of motion in the Appendix, where we restrict attention to the classical case; we believe this computation can be extended to the quantum

theory along the lines explained in Sect.2. We want to describe the factorizable boundary scattering theory associated with (5.8).

The soliton (antisoliton) boundary scattering amplitudes can be encoded in the commutation relations (see Section 2)

$$\begin{aligned} A(\theta)B &= P_+(\theta)A(\theta)B + Q_+(\theta)\bar{A}(\theta)B; \\ \bar{A}(\theta)B &= P_-(\theta)\bar{A}(\theta)B + Q_-(\theta)A(\theta)B. \end{aligned} \quad (5.9)$$

Here  $P_+$ ,  $Q_+$  ( $P_-$ ,  $Q_-$ ) are the amplitudes of soliton (antisoliton) one-particle boundary scattering processes shown in Fig.23. Some comments are in order. Except for the case  $M = \infty$  (see below), the boundary value  $\varphi(x = 0, y)$  is not fixed in the boundary field theory (5.8) and hence the topological charge

$$q = \frac{\beta}{2\pi} \int_{-\infty}^0 dx \frac{\partial}{\partial x} \varphi(x, y) \quad (5.10)$$

is not conserved. Therefore the boundary scatterings are allowed to violate this charge conservation by an even number. In particular, an incoming soliton can go away as an antisoliton and vice versa. The amplitudes  $Q_{\pm}$  are introduced to describe these processes. The exceptional case is  $M = \infty$  (“fixed” boundary condition); in this case we must have  $Q_{\pm} = 0$ . Also, at  $\varphi_0 \neq 0 \pmod{2\pi/\beta}$  (and  $M \neq 0$ ) the boundary interaction violates charge-conjugation symmetry; that is why in the general case the amplitudes  $P_+$ ,  $Q_+$  and  $P_-$ ,  $Q_-$  are expected to be different.

With (5.9), the boundary Yang-Baxter equation (3.25) leads to six distinct functional equations,

$$Q_+(\theta')c(\theta + \theta')Q_-(\theta)a(\theta - \theta') = Q_-(\theta')c(\theta + \theta')Q_+(\theta)a(\theta - \theta'), \quad (5.11a)$$

$$\begin{aligned} P_-(\theta')b(\theta + \theta')P_+(\theta)c(\theta - \theta') + P_+(\theta')c(\theta + \theta')P_+(\theta)b(\theta - \theta') = \\ P_-(\theta')c(\theta + \theta')P_-(\theta)b(\theta - \theta') + P_+(\theta')b(\theta + \theta')P_-(\theta)c(\theta - \theta'), \end{aligned} \quad (5.11b)$$

$$\begin{aligned} P_+(\theta')a(\theta + \theta')Q_+(\theta)c(\theta - \theta') + Q_+(\theta')b(\theta + \theta')P_+(\theta)b(\theta - \theta') + Q_+(\theta')c(\theta + \theta')P_-(\theta)c(\theta - \theta') = \\ Q_+(\theta')a(\theta + \theta')P_+(\theta)a(\theta - \theta') + P_-(\theta')c(\theta + \theta')Q_+(\theta)a(\theta - \theta') \end{aligned} \quad (5.11c)$$

$$\begin{aligned} P_+(\theta')a(\theta + \theta')Q_+(\theta)b(\theta - \theta') + Q_+(\theta')b(\theta + \theta')P_+(\theta)c(\theta - \theta') + Q_+(\theta')c(\theta + \theta')P_-(\theta)b(\theta - \theta') = \\ P_+(\theta')b(\theta + \theta')Q_+(\theta)a(\theta - \theta'), \end{aligned} \quad (5.11d)$$

(the other two are obtained from (5.11c), (5.11d) by  $+$   $\leftrightarrow$   $-$  substitution). The solution to these equations is found in a recent paper[24]<sup>2</sup>; it reads

$$\begin{aligned} P_+(\theta) &= \cos(\xi + \lambda u)R(u); \\ P_-(\theta) &= \cos(\xi - \lambda u)R(u); \end{aligned}$$

---

<sup>2</sup> We learned about [24] after we had found this solution independently.

$$\begin{aligned}
Q_+(\theta) &= \frac{k_+}{2} \sin(2\lambda u) R(u); \\
Q_-(\theta) &= \frac{k_-}{2} \sin(2\lambda u) R(u),
\end{aligned} \tag{5.12}$$

where again  $u = -i\theta$ ;  $\xi, k_{\pm}$  are free parameters and  $R(u)$  is an arbitrary function<sup>3</sup>.

The free parameters in (5.12) have to be related to the parameters of the boundary action. The solution (5.12) seems to contain one parameter more than the action (5.8). It is easy to see however that one of the two parameters  $k_{\pm}$  in (5.12) can be removed by an appropriate gauge transformation

$$A(\theta) \rightarrow e^{i\alpha} A(\theta), \bar{A}(\theta) \rightarrow e^{-i\alpha} \bar{A}(\theta) \tag{5.13}$$

which leaves all the charge-conserving amplitudes unchanged and transforms the amplitudes  $Q_{\pm}$  as

$$Q_+(\theta) \rightarrow e^{-2i\alpha} Q_+(\theta); \quad Q_-(\theta) \rightarrow e^{+2i\alpha} Q_-(\theta). \tag{5.14}$$

Considered from the Lagrangian point of view, this transformation amounts to adding a total derivative term to the boundary action density (5.8),

$$b(\varphi) \rightarrow b(\varphi) + \frac{2\pi\alpha}{\beta} \frac{d}{dy} \varphi. \tag{5.15}$$

We use this freedom to set  $k_+ = k_- = k$ . This leaves us with two parameters,  $\xi$  and  $k$ , which correspond to the two-parameters  $M$  and  $\varphi_0$  in (5.8).

The function  $R(u)$  in (5.12) can be determined with the use of the ‘‘boundary unitarity’’ and the ‘‘boundary cross-unitarity’’ equations (3.26) and (3.35). These equations reduce to

$$R(u)R(-u) = [\cos^2(\xi) - \sin^2(\lambda u) - k^2 \sin^2(\lambda u) \cos^2(\lambda u)]^{-1}; \tag{5.16}$$

$$K(u) = \sin \lambda(\pi + 2u) \rho(2u) K(-u); \quad K(u) = R(\pi/2 - u). \tag{5.17}$$

It is not difficult to solve these equations. In fact, it is convenient to solve (5.16) and (5.17) ‘‘separately’’. Let us factorize the function  $R(u)$  as

$$R(u) = R_0(u)R_1(u); \quad K(u) = K_0(u)K_1(u), \tag{5.18}$$

where  $K_0(u) = R_0(\pi/2 - u)$ ,  $K_1(u) = R_1(\pi/2 - u)$  so that these factors satisfy

$$R_0(u)R_0(-u) = 1; \quad K_0(u) = \sin \lambda(\pi + 2u) \rho(2u) K_0(-u) \tag{5.19}$$

and

$$R_1(u)R_1(-u) = [\cos^2(\xi) - (1 + k^2) \sin^2(\lambda u) + k^2 \sin^4(\lambda u)]^{-1}; \quad K_1(u) = K_1(-u). \tag{5.20}$$

---

<sup>3</sup> This is the general solution for generic  $\lambda$ . For integer  $\lambda$  there are additional solutions.

The equations (5.19) do not contain the boundary parameters  $\xi$  and  $k$ ; the solution can be written as

$$\begin{aligned}
R_0(u) &= F_0(u)/F_0(-u); \\
F_0(u) &= \frac{\Gamma(1 - 2\lambda u/\pi)}{\Gamma(\lambda - 2\lambda u/\pi)} \times \\
&\prod_{k=1}^{\infty} \frac{\Gamma(4\lambda k - 2\lambda u/\pi)\Gamma(1 + 4\lambda k - 2\lambda u/\pi)\Gamma(\lambda(4k + 1))\Gamma(1 + \lambda(4k - 1))}{\Gamma(\lambda(4k + 1) - 2\lambda u/\pi)\Gamma(1 + \lambda(4k - 1) - 2\lambda u/\pi)\Gamma(1 + 4\lambda k)\Gamma(4\lambda k)} \quad (5.21)
\end{aligned}$$

The factor  $R_0$  contains the poles in the “physical strip”  $0 < u < \pi/2$  located at  $u = u_n = n\pi/2\lambda; n = 1, 2, \dots < \lambda$ . Appearance of these poles is very well expected. In the generic case, the boundary state  $|B\rangle$  associated with the boundary condition (5.8) is expected to contain the contributions of the zero-momentum particles  $B_n$ , which leads to the poles (3.41). So, these poles of  $R_0$  correspond to the diagrams in Fig.24. Note that these poles should not appear in the amplitudes  $Q_{\pm}$  and the factor  $\sin(2\lambda u)$  in (5.12) takes care of this.

The equation (5.20) contains all the information about the boundary condition (i.e. the parameters  $\xi$  and  $k$ ). Its solution can be written as

$$R_1(u) = \frac{1}{\cos \xi} \sigma(\eta, u) \sigma(i\vartheta, u) \quad (5.22)$$

where

$$\begin{aligned}
\sigma(x, u) &= \frac{\Pi(x, \pi/2 - u)\Pi(-x, \pi/2 - u)\Pi(x, -\pi/2 + u)\Pi(-x, -\pi/2 + u)}{\Pi^2(x, \pi/2)\Pi^2(-x, \pi/2)}; \\
\Pi(x, u) &= \prod_{l=0}^{\infty} \frac{\Gamma(1/2 + (2l + 1/2)\lambda + x/\pi - \lambda u/\pi)\Gamma(1/2 + (2l + 3/2)\lambda + x/\pi)}{\Gamma(1/2 + (2l + 3/2)\lambda + x/\pi - \lambda u/\pi)\Gamma(1/2 + (2l + 1/2)\lambda + x/\pi)} \quad (5.23)
\end{aligned}$$

solves

$$\sigma(x, u)\sigma(x, -u) = [\cos(x + \lambda u)\cos(x - \lambda u)]^{-1}; \quad \sigma(x, \pi/2 - u) = \sigma(x, \pi/2 + u), \quad (5.24)$$

and the parameters  $\eta$  and  $\vartheta$  are determined through the equations

$$\cos(\eta) \cosh(\vartheta) = -\frac{1}{k} \cos \xi; \quad \cos^2(\eta) + \cosh^2(\vartheta) = 1 + \frac{1}{k^2}. \quad (5.25)$$

The above boundary S-matrix has a very rich structure. The factor  $\sigma(i\vartheta, u)$  in (5.22) brings in an infinite set of singularities at complex values of  $u$ ; some of these complex poles probably can be interpreted as resonance states of the boundary. The factor  $\sigma(\eta, u)$  exhibits infinitely many poles at real  $u$ ; depending on the parameter  $\eta$ , some of these poles can occur in the “physical strip”  $0 < u < \pi/2$  thus giving rise to the boundary bound

states. We did not carry out a complete analysis of the possible boundary phenomena described by this S-matrix. In order to do this one must find the an exact relation between the parameters  $M$  and  $\varphi_0$  in the boundary action and  $\xi$  and  $k$  (or  $\eta$  and  $\vartheta$ ) in the S-matrix. A brief analysis shows that in the general case this relation is very complicated. We leave this problem for future studies. Here we analyze only two particular cases.

a). “Fixed” boundary condition  $\varphi(x, y)_{x=0} = \varphi_0$  can be obtained from (5.8) in the limit  $M = \infty$ . In this case the topological charge is conserved and the amplitudes  $Q_{\pm}$  in (5.9) must vanish. Hence this case corresponds to  $k = 0$ . We have two amplitudes,  $P_+$  and  $P_-$  which describe soliton scattering processes schematically shown in Fig.25. For  $k = 0$ , the “resonance” factor  $\sigma(i\vartheta, u)$  disappears and the equation (5.22) simplifies as

$$R_1(u) = \frac{1}{\cos \xi} \sigma(\xi, u), \quad (5.26)$$

where  $\xi$  is related in some way to  $\varphi_0$ . Obviously,  $\varphi_0 = 0$  corresponds to  $\xi = 0$  as at  $\varphi_0 = 0$  the boundary theory respects  $\mathbf{C}$  symmetry and we must have  $P_+ = P_-$ . At  $\xi = 0$  the function  $R_1(u)$  does not exhibit any poles in the physical strip (and hence there are no boundary bound states), the nearest singularity being the double pole at  $u = -\pi/2\lambda$ . At  $\xi \neq 0$  (i.e.  $\varphi_0 \neq 0$ ) this double pole splits into two simple poles at  $u = u_{\pm} = -\pi/2\lambda \pm \xi/\lambda$ . Note that due to the factors  $\cos(\xi \pm \lambda u)$  in (5.12) the pole  $\theta = iu_+$  ( $\theta = iu_-$ ) appears only in  $P_+$  ( $P_-$ ). At  $\xi > \pi/2$  the pole at  $\theta = iu_+$  enters the physical strip. Appearance of such a “boundary bound state” is well expected. For  $0 < \varphi_0 < \pi/\beta$  the ground state  $|0\rangle_B$  of the boundary sine-Gordon theory is characterized by the asymptotic behaviour  $\langle \varphi(x, y) \rangle_B \rightarrow 0$  as  $x \rightarrow -\infty$ . Classically, there is another stable state with  $\langle \varphi(x, y) \rangle \rightarrow 2\pi/\beta$  as  $x \rightarrow -\infty$ . If  $\varphi_0$  is small (compared to the quantum parameter  $\beta$ ), quantum fluctuations can destroy its stability. However, if  $\varphi_0$  is not too small, this state is expected to be stable in the quantum theory, too. At  $\varphi_0 = \pi/\beta$  this state has the same energy as the ground state which hence becomes degenerate. In this case the amplitude  $P_+(\theta)$  has to have a pole at  $\theta = i\pi/2$  corresponding to the “emission” of a zero-momentum soliton by the associated boundary state, as is explained in Sect.3. We can conclude that  $\varphi_0 = \pi/\beta$  corresponds to the case  $u_+ = \pi/2$ . Assuming a linear relation between  $\xi$  and  $\varphi_0$ , we find

$$\xi = \frac{4\pi}{\beta} \varphi_0. \quad (5.27)$$

Let us stress that the assumed linear relation (and hence (5.27)) is no more than a conjecture. Also, the relation (5.27) is conjectured only for the “fixed” case  $M = \infty$ ; it is not expected to hold in the general case of finite  $M$ .

b). “Free” boundary condition corresponds to  $M = 0$  in (5.8). In this case the full action enjoys the symmetry  $\varphi \rightarrow -\varphi$  ( $\mathbf{C}$  symmetry) and hence we must have  $P_+ = P_- = P_{free}$  and  $Q_+ = Q_- = Q_{free}$ , i.e. we have to choose  $\xi = 0$ . Note that under this choice the factors  $\cos(\lambda\theta)$  in (5.12) cancel the poles at  $\theta = iu_{2n+1}$  of the factor (5.21). This agrees with the expectation that in the  $\mathbf{C}$ -symmetric case the boundary state can not emit the  $\mathbf{C}$ -odd particles  $B_{2n+1}$ <sup>3</sup>. In addition, in the “free” case one expects all the amplitudes

---

<sup>3</sup> In fact, it is easy to argue that in general the choice  $\xi = 0$  corresponds to the  $\mathbf{C}$

(5.12) to have a pole at  $\theta = i\pi/2$ , for exactly the same reason which we discussed in the previous Section. To ensure this property one has to choose  $\eta = \frac{\pi}{2}(\lambda + 1)$  (and  $\vartheta = 0$ ), i.e.  $k = [\sin(\pi\lambda/2)]^{-1}$ . So in the “free” case the amplitudes (5.12) can be written as

$$P_{free}(\theta) = \sin(\pi\lambda/2)R_{free}(u); \quad Q_{free}(\theta) = \sin(\lambda u)R_{free}(u) \quad (5.28)$$

where

$$R_{free}(u) = \frac{\cos(\lambda u)}{\sin(\lambda\pi/2)}R_0(u)\sigma(4\pi^2/\beta^2, u)\sigma(0, u). \quad (5.29)$$

## 6.DISCUSSION

Obviously, there is much room for further development.

More detailed analysis of “integrable boundary conditions” is needed. In Section 2 we assumed that the boundary action  $b$  in (2.8) depends only on boundary values  $\varphi_B(y)$ ,  $d/dy\varphi_B(y)$  of the “bulk” field  $\varphi(x, y)$ . In general, the boundary action can contain also specific boundary degrees of freedom. Clearly, this provides more possibilities for the integrable boundary field theories.

Further study of possible solutions to Boundary Yang-Baxter equations ((3.25) is of much interest. A new class of solutions is found in a recent paper [24].

Many integrable “bulk” theories exhibit nonlocal integrals of motion of fractional spin [25-27], along with the local ones. Analysis of these nonlocal integrals provides valuable information about the S-matrix. We expect that the nonlocal integrals of motion exist in some integrable boundary field theories. A natural place to look for the nonlocal IM is boundary sine-Gordon model considered in Section 5. As in the case of bulk sine-Gordon theory, where nonlocal IM generate the so-called “affine quantum group symmetry” [27], appropriate modifications of these IM could help to find an exact relation between the parameters of the action ( $M$  and  $\varphi_0$  in (5.8)) and of the S-matrix ( $\xi, k$  in (5.12))(which we found very difficult to guess).

The most interesting problem is how to extract any off-shell data from the S-matrix. In the bulk theory, two approaches have proven to be the most successful. One is the “formfactor bootstrap” proposed by Smirnov[27]. It would be interesting to generalize the formfactor bootstrap equations to the case of integrable boundary field theory, both for bulk operators in presence of boundary and for boundary operators. Another approach is known as “thermodynamic Bethe ansatz”(TBA)[29]. At the present stage of development, it is capable of providing the ground state energy of a finite-size system (with spatial coordinate compactified on a circle), once the S-matrix is known. This approach can be generalized in different ways to incorporate the boundary effects. In particular, the expression (3.38) for the boundary state allows one to find the analog of TBA equations for spatially finite systems with integrable boundaries. We intend to study these equations elsewhere.

---

-symmetric boundary action (5.8) with  $\varphi_0 = 0$ . Even in this case the relation between  $M$  and  $k$  seems to be rather complicated.

It was understood recently that many interesting “massless flows” in the bulk theory can be described in terms of “massless factorizable S-matrices”, through TBA equations[30]. This approach can be modified to incorporate “massless boundary S-matrices” [31], thus providing the possibility of a similar description of the “boundary flows”[32].

After this work was finished we received a recent paper [31] where some results of Section 3 (notably, the “boundary bootstrap equation”(3.40)) are obtained. However, the “boundary cross-unitarity equation” (3.35) (which we think to be the most significant of our results) is not considered there; that is why we decided that our paper is still worth publishing.

## APPENDIX

Here we carry out a preliminary study of integrable boundary conditions in the sine-Gordon model (5.1). We restrict attention to the classical case  $\beta \rightarrow 0$ . In this limit it is convenient to work with the field  $\phi(x, y) = \beta\varphi(x, y)$  so that the “bulk” equation of motion takes the form

$$\partial_z \partial_{\bar{z}} \phi = \sin \phi, \quad (A.1)$$

where we set  $m^2 = 4$ . As is known [22], there are infinitely many conserved currents  $(T_{s+1}, \Theta_{s-1})$  and  $(\bar{T}_{s+1}, \bar{\Theta}_{s-1})$  with  $s = 1, 3, 5, \dots$ , which satisfy (2.5) in this “bulk” theory; the first two have the form

$$T_2 = (\partial_z \phi)^2; \quad \Theta_0 = -2 \cos \phi, \quad (A.2)$$

$$T_4 = (\partial_z^2 \phi)^2 - \frac{1}{4}(\partial_z \phi)^4; \quad \Theta_2 = (\partial_z \phi)^2 \cos \phi \quad (A.3)$$

( $\bar{T}$  and  $\bar{\Theta}$  are obtained from (A.2) by substitution  $z \rightarrow \bar{z}$ ). The current (A.2) is just the energy-momentum tensor, and (A.3) leads to the first nontrivial IM.

As is explained in Section 2, the current (A.3) would lead to a nontrivial IM in presence of the boundary, too, provided the boundary condition at  $x = 0$  is chosen in such a way that

$$[T_4 + \bar{\Theta}_2 - \bar{T}_4 - \Theta_2]_{x=0} = \frac{d}{dy} \theta_3, \quad (A.4)$$

where  $\theta_3$  is some local boundary field. Let us consider the simplest case of the boundary action  $b$  independent of the derivative  $\frac{d}{dy} \phi$ , i.e. the total action of the form

$$\mathcal{A} = \frac{1}{\beta^2} \left\{ \int_{-\infty}^{\infty} dy \int_{-\infty}^0 dx \left[ \frac{1}{2} (\partial_\mu \phi(x, y))^2 - 4 \cos \phi(x, y) \right] + \int_{-\infty}^{\infty} dy V(\phi(x=0, y)) \right\}. \quad (A.5)$$

The boundary condition which follows from (A.5) is

$$[\partial_x \phi + V'(\phi)]_{x=0} = 0. \quad (A.6)$$

With this, the l.h.s of (A.4) can be written (up to an overall numerical factor) as

$$V'(\phi)(\partial_y\phi)^3 + 8V''(\phi)(\partial_{yy}^2\phi)(\partial_y\phi) - [(V'(\phi))^3 + 4V''(\phi)\sin\phi + 2V'(\phi)\cos\phi](\partial_y\phi). \quad (A.7)$$

This reduces to a total  $d/dy$  derivative if the function  $V(\phi)$  satisfies

$$4V''(\phi) + V(\phi) = 0, \quad (A.8)$$

that is

$$V(\phi) = -\Lambda \cos\left(\frac{\phi - \phi_0}{2}\right), \quad (A.9)$$

where  $\Lambda$  and  $\phi_0$  are constants. Returning to the original normalization, one gets (5.8).



## REFERENCES.

- 1.K.Binder, in “Phase Transitions and Critical Phenomena”, v.8, C.Domb and J.Lebowitz ed., Academic Press, London, 1983.
- 2.C.G.Callan, L.Thorlacius. Nucl.Phys.B329(1990),117.
- 3.E.Witten. Phys.Rev.46D(1992)p.5467., K.Li, E.Witten. Preprint IASSNS-HEP-93/7, 1993.
- 4.A.B.Zamolodchikov, Al.B.Zamolodchikov. Ann.Phys.120 (1979), 253.
- 5.A.B.Zamolodchikov. Advanced Studies in Pure Mathematics 19 (1989), 641.
- 6.J.Cardy. “Conformal Invariance and Surface Critical Behavior”, in “Conformal Invariance and Applications to Statistical Mechanics”, E.Itzykson, H.Saleur, J.B.Zuber eds., World Scientific, 1988.
- 7.J.Cardy. Nucl.Phys.B324(1989)p. 581.
- 8.J.Cardy, D.Lewellen. Phys.Lett. 259B (1991) p.274.
- 9.E.Ogievetsky, N.Reshetikhin, P.Wiegmann. Nucl.Phys B280 [FS 18] (1987), p.45.
- 10.V.Fateev, A.Zamolodchikov. “Conformal Field Theory and Purely Elastic S-Matrices”, in “Physics and Mathematics of Strings”, memorial volume for Vadim Knizhnik, L.Brink, D.Friedan, A.Polyakov eds., World Scientific, 1989.
- 11.J.Cardy, G.Mussardo. Phys. Lett. B225 (1989) 243.
- 12.P.Freund, T.Classen, E.Melzer. Phys.Lett. 229B (1989) p.243; G.Sotkov, C.Zhu. Phys.Lett. 229B (1989) p.391; P.Christe, G.Mussardo. Nucl.Phys. B330 (1990) p.465.
- 13.I.Cherednik. Theor.Math.Phys., 61, 35 (1984) p.977.
- 14.L.Takhtadjian, L.Faddeev. Usp.Mat.Nauk. 34 (1979) p.13.
- 15.E.Sklyanin. J.Phys. A:Math.Gen. 21 (1988) p.2375
- 16.L.Mezincescu, R.Nepomechie. Int.J.Mod.Phys. A6, 5231 (1991).
- 17.P.Kulish, E.Sklyanin. “Algebraic Structures related to Reflection Equation”. Preprint YITP/K-980, 1992.
- 18.J.Cardy. Phys.Rev.Lett. 54 (1985) p.1354.
- 19.M.Sato, T.Miwa, M.Jimbo. Proc. Japan Acad., 53A (1977), 6.
- 20.I.Affleck, A.Ludwig. “Universal Non-integer Groundstate Degeneracy in Critical Quantum Systems”. Preprint UBCTP-91-007, 1991.
- 21.B.McCoy, T.T.Wu. “The two-dimensional Ising Model”, Harward University Press. 1973.
- 22.L.Takhtadjian, L.Faddeev. Theor.Math.Phys. 21, (1974) p.160., V.Korepin, L.Faddeev. Theor.Math.Phys. 25 (1975) p.147.
- 23.S.Coleman. Phys.Rev. D11, (1975) p.2088.
- 24.H.J.DeVega, A.Gonzalez Ruiz. Preprint LPTHE 92-45.
- 25.M.Luscher. Nucl.Phys. B135 (1978) p.1.
- 26.A.B.Zamolodchikov.”Fractional-Spin Integrals of Motion in Perturbed Conformal Field Theory”, in “Fields, Strings and Quantum Gravity”, H.Guo, Z.Qiu, H.Tye eds., Gordon and Breach, 1989.
- 27.D.Bernard, A.LeClaire. Commun.Math.Phys., 142 (1991) p.99.
- 28.F.Smirnov. “Formfactors in Completely Integrable Models of QFT”,

- Adv. Series in Math.Phys.14, World Scientific, 1992.
- 29.Al.Zamolodchikov. Nucl.Phys. B342 (1990) p.695.
- 30.Al.Zamolodchikov. Nucl.Phys. B385 (1991) p.619., A.Zamolodchikov,  
Al.Zamolodchikov. Nucl.Phys. B379 (1992) p.602.
- 31.P.Fendley. "Kinks in the Kondo Problem". Preprint BUHEP-93-10.
- 32.A.Fring, R.Koberle. "Factorized Scattering in the Presence of  
Reflecting Boundaries". Preprint USP-IFQSC/TH/93-06, 1993.

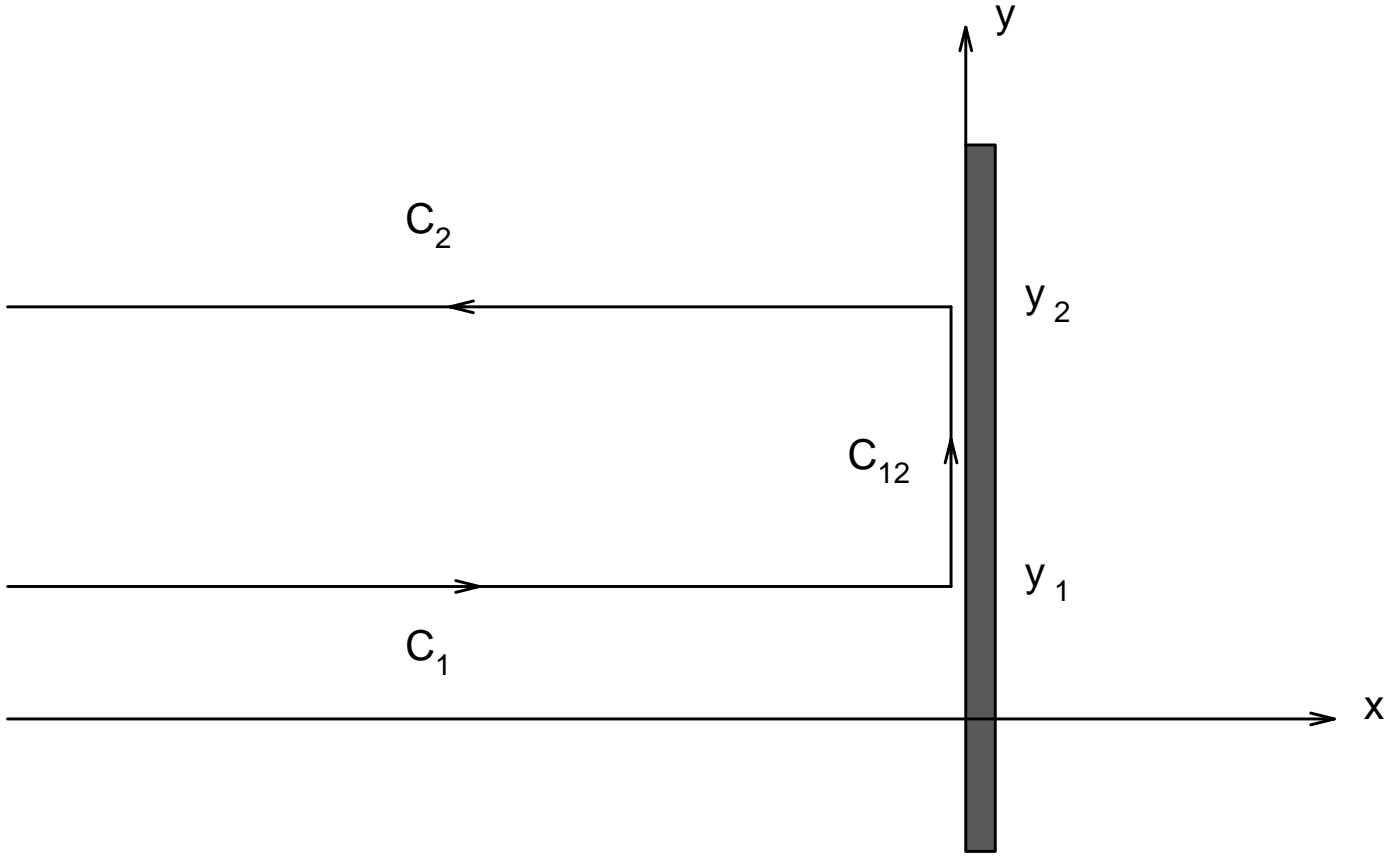
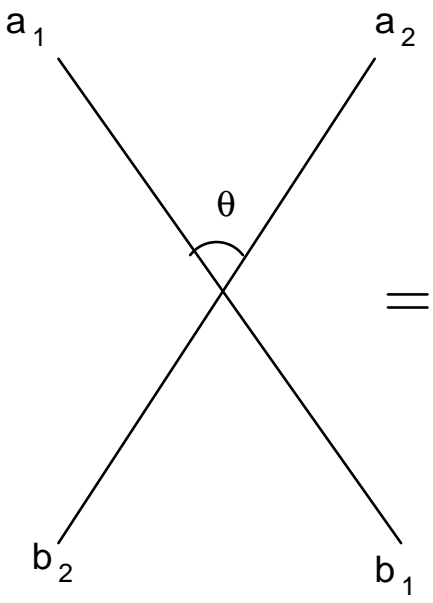

FIG-1



=

$$S_{a_1 a_2}^{b_1 b_2}(\theta)$$

=

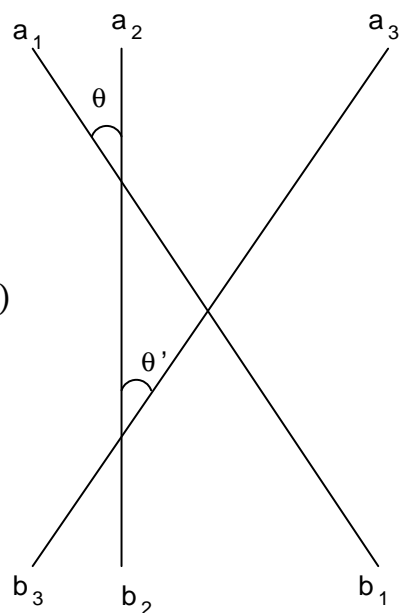

FIG-2

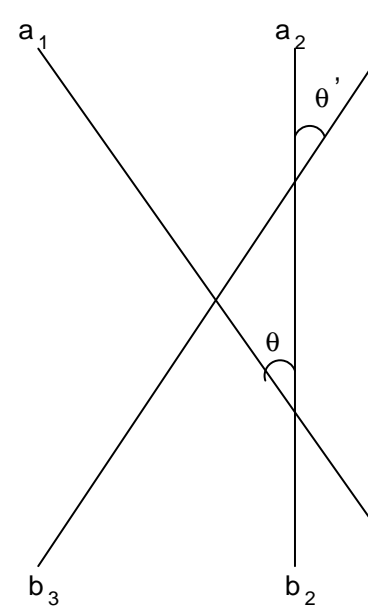

FIG-3

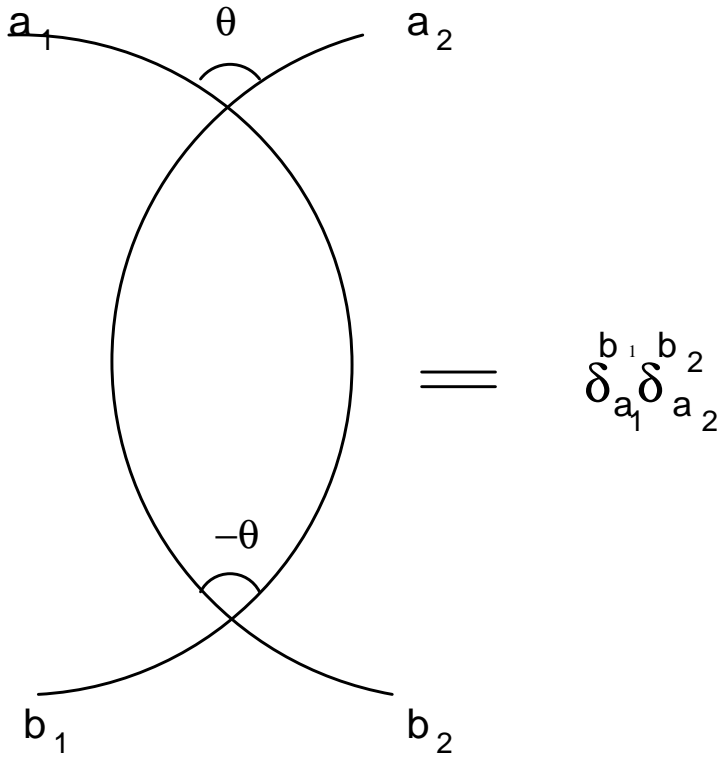

FIG-4

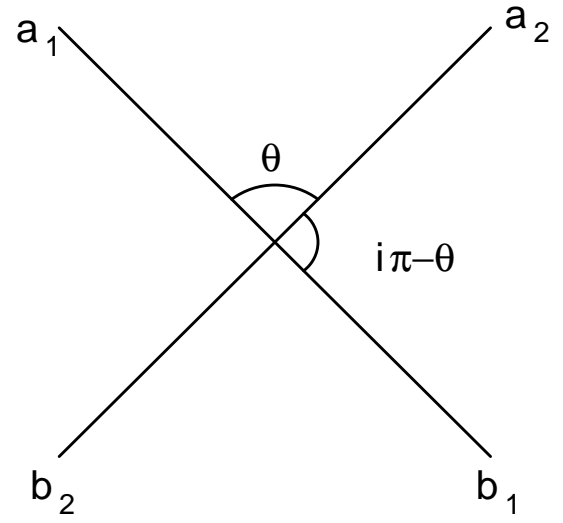

FIG-5

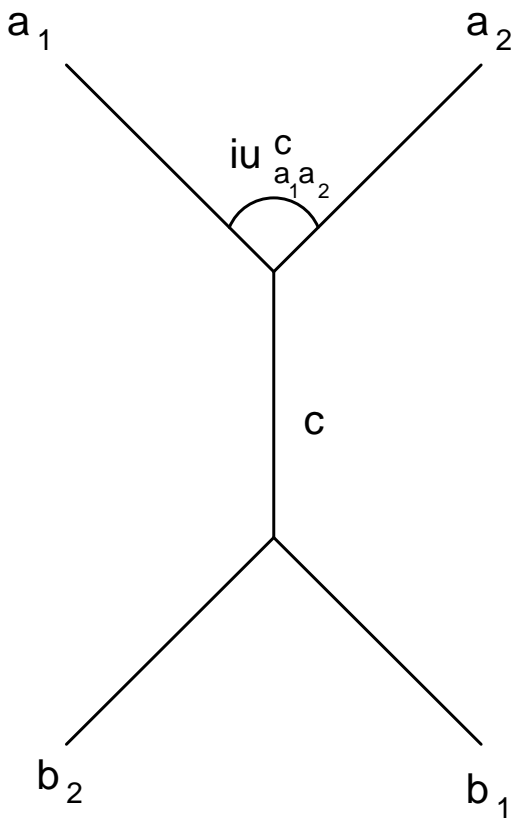

FIG-6

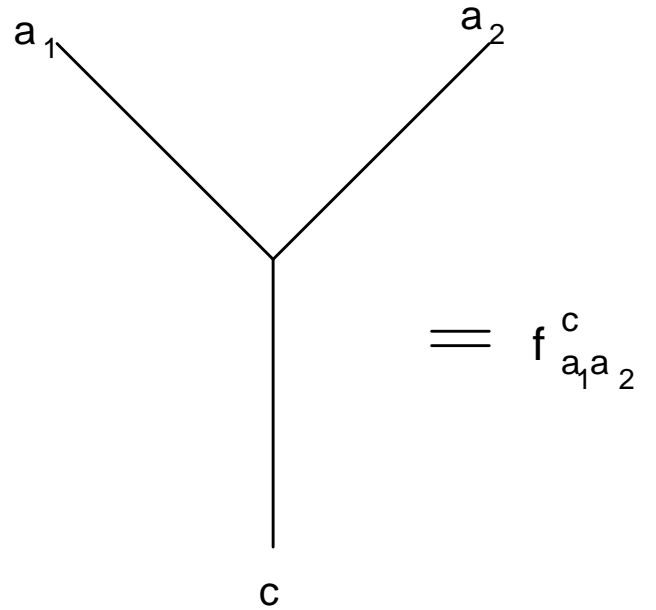

FIG-7

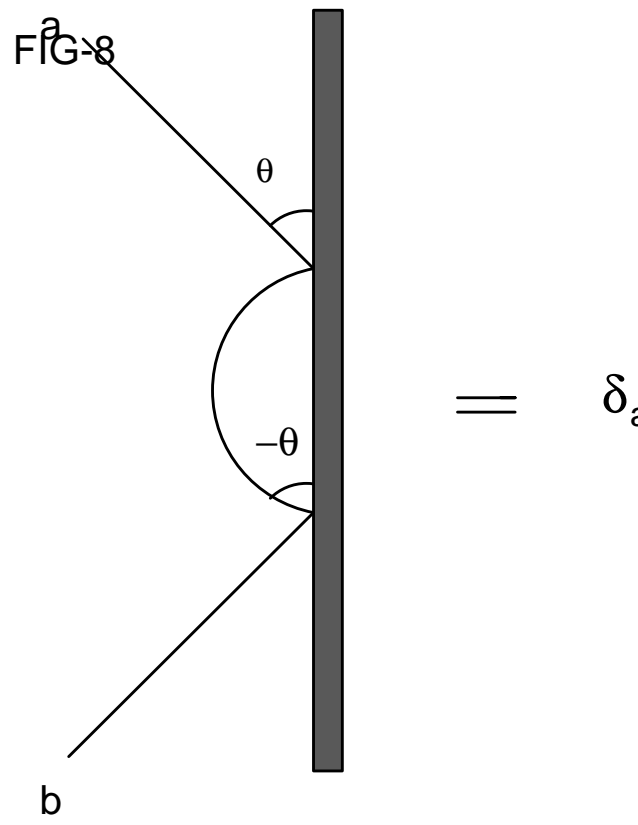
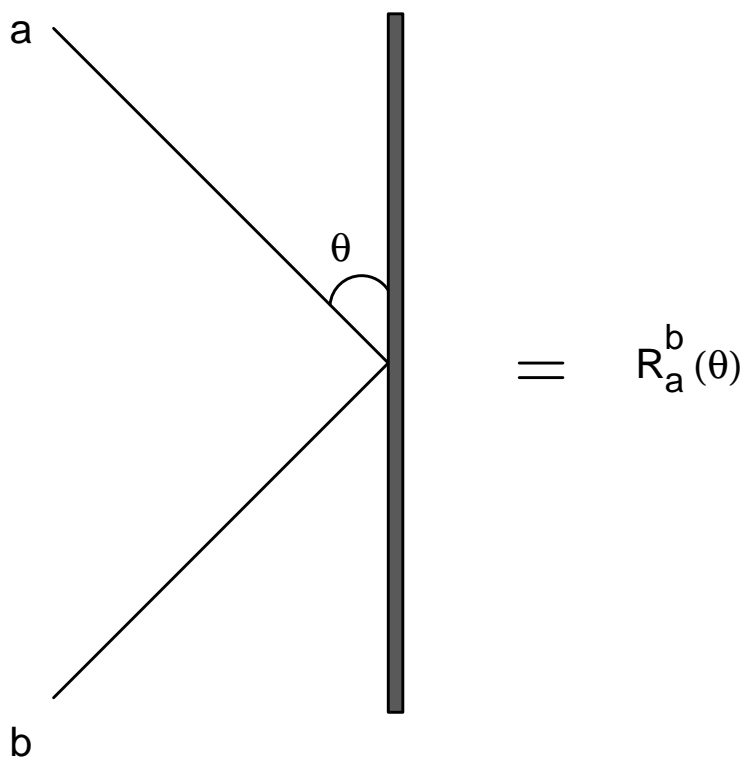
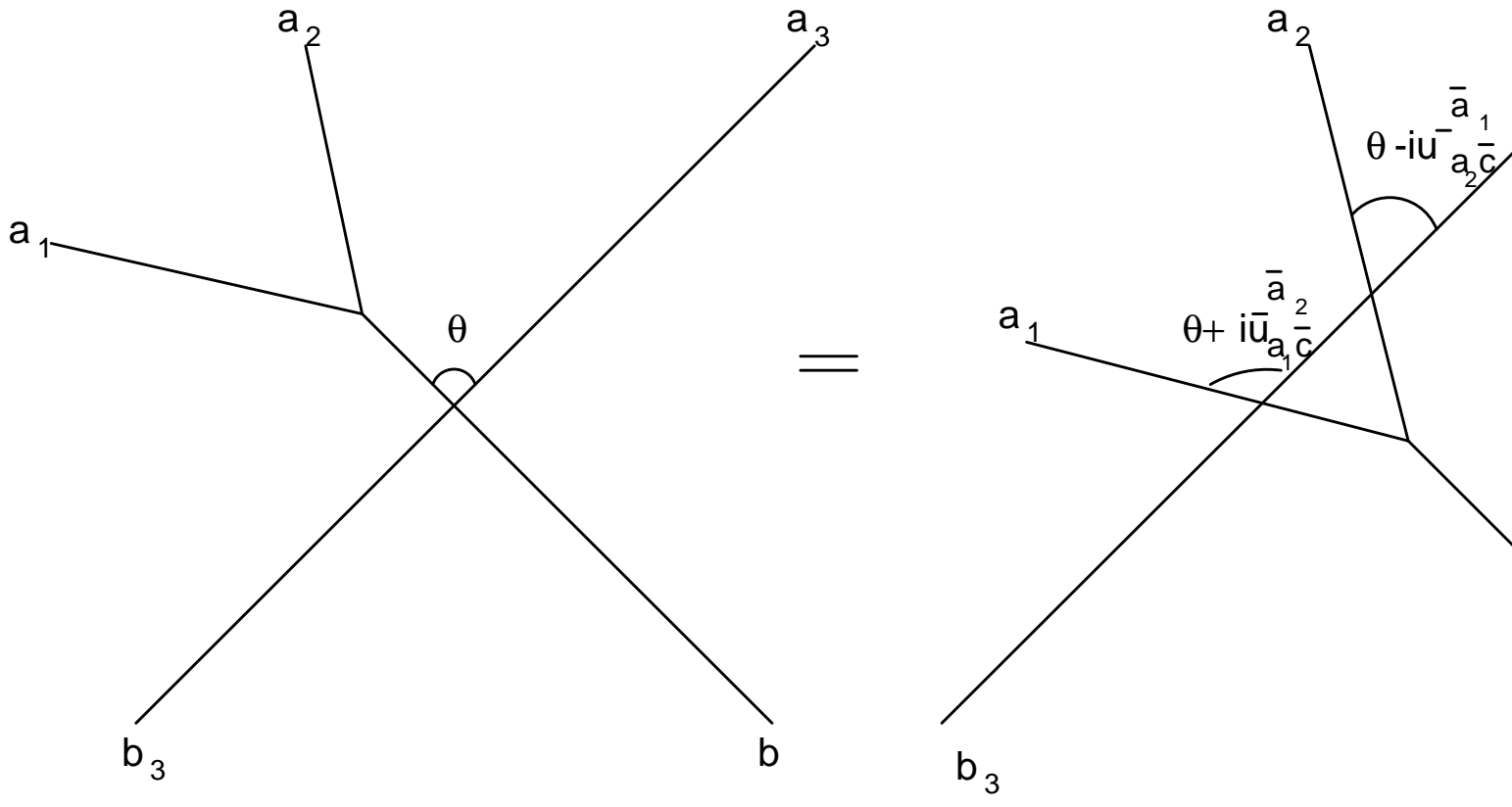

FIG-9

FIG-11

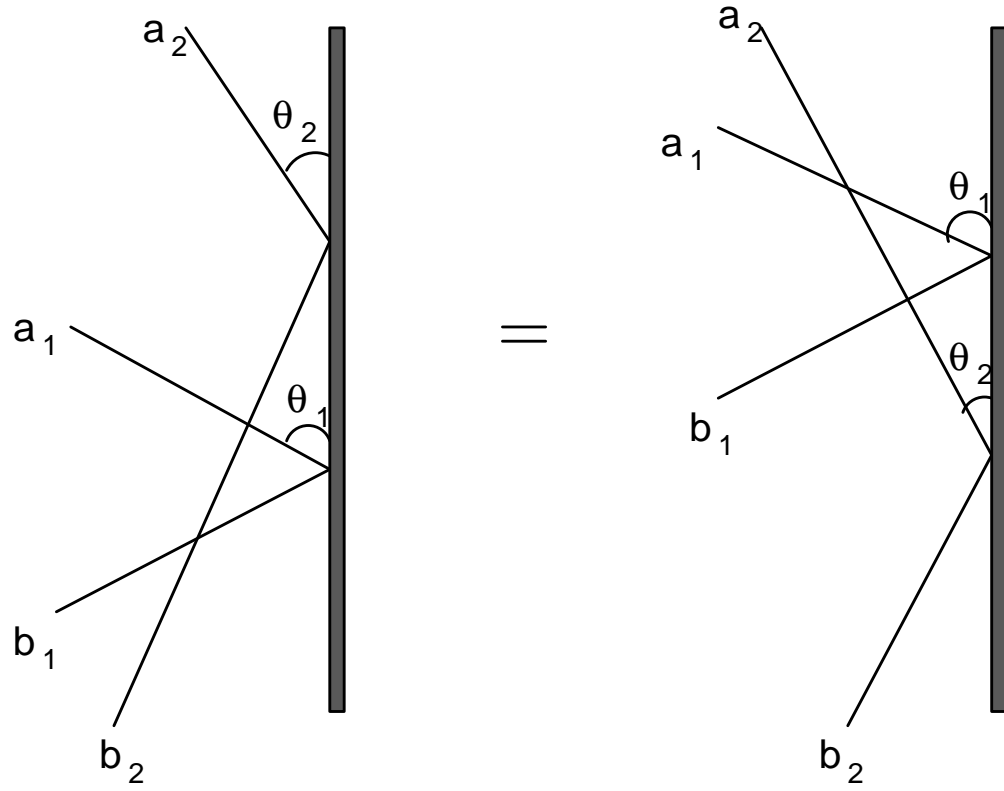
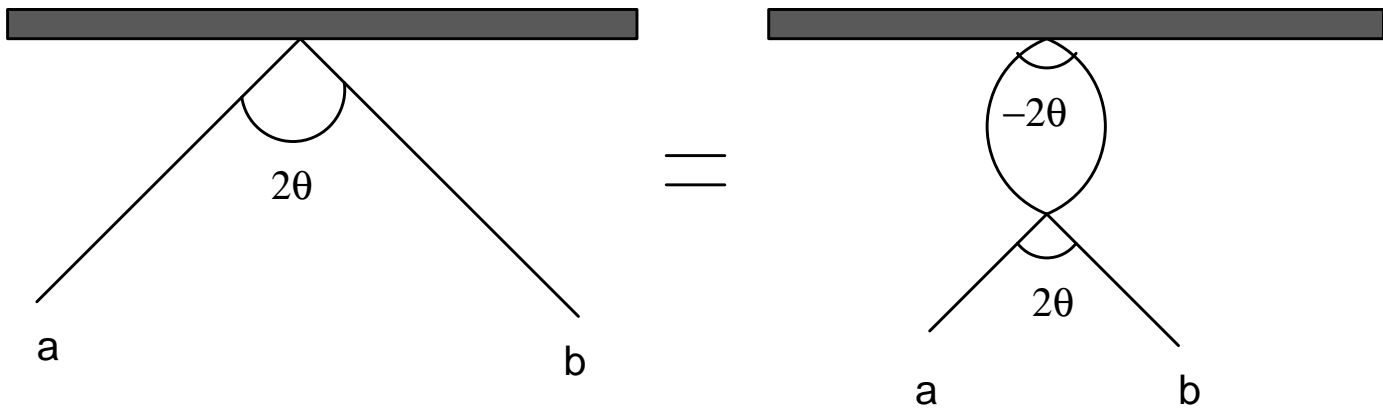
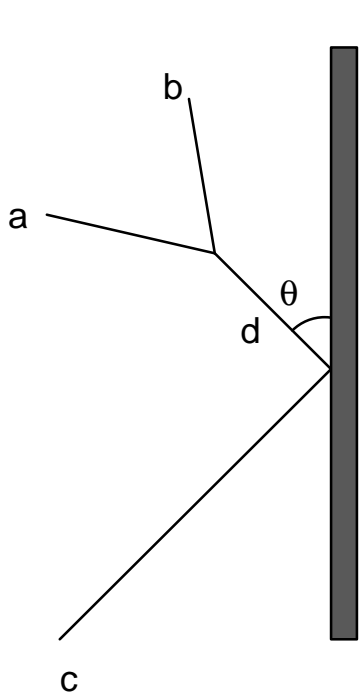

FIG-10



38 FIG-12



=

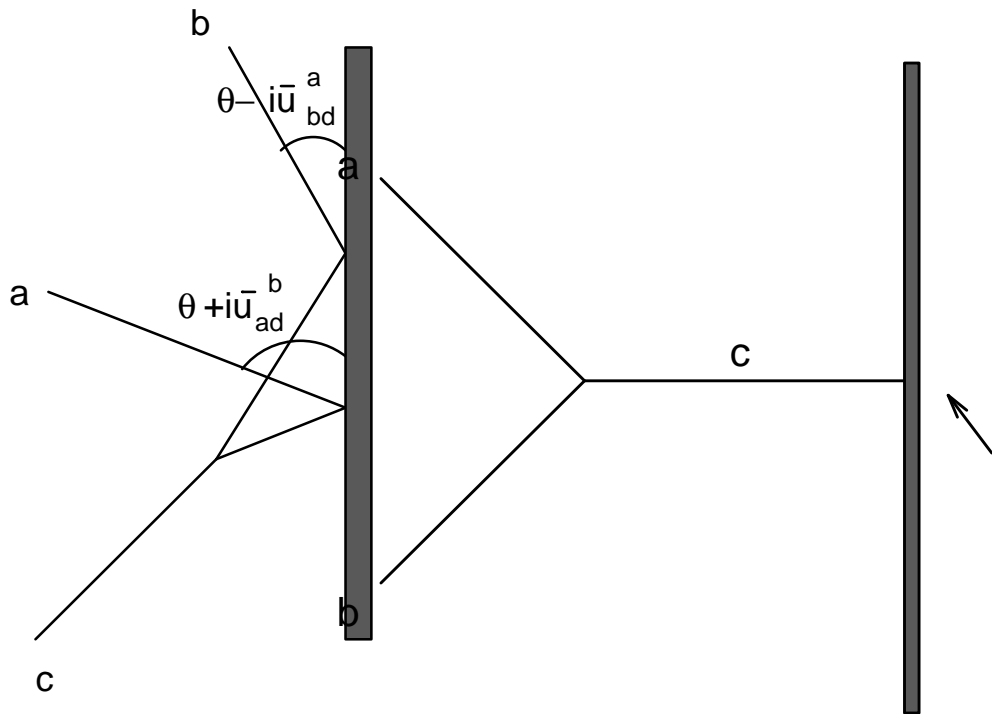
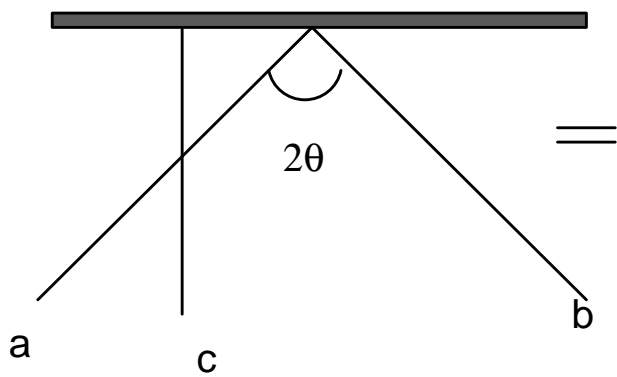

FIG-13

FIG-14



=

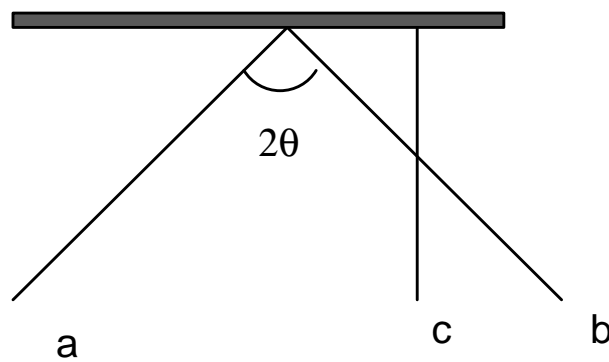

FIG-15

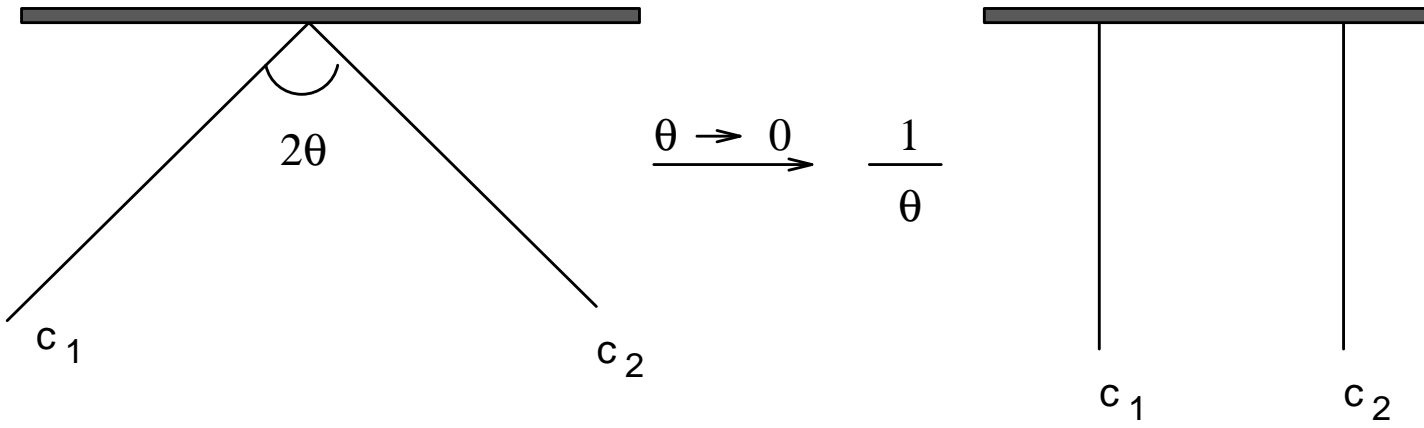

FIG-16

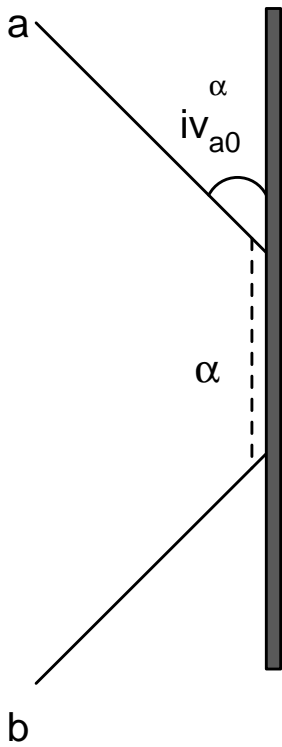

FIG-17

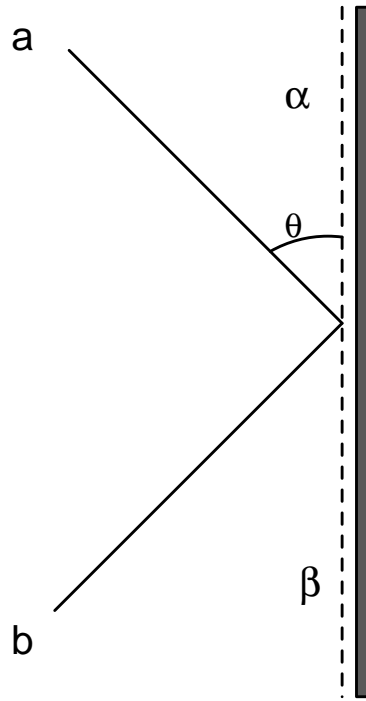

FIG-18

$$= R_{a\alpha}^{b\beta}(\theta)$$



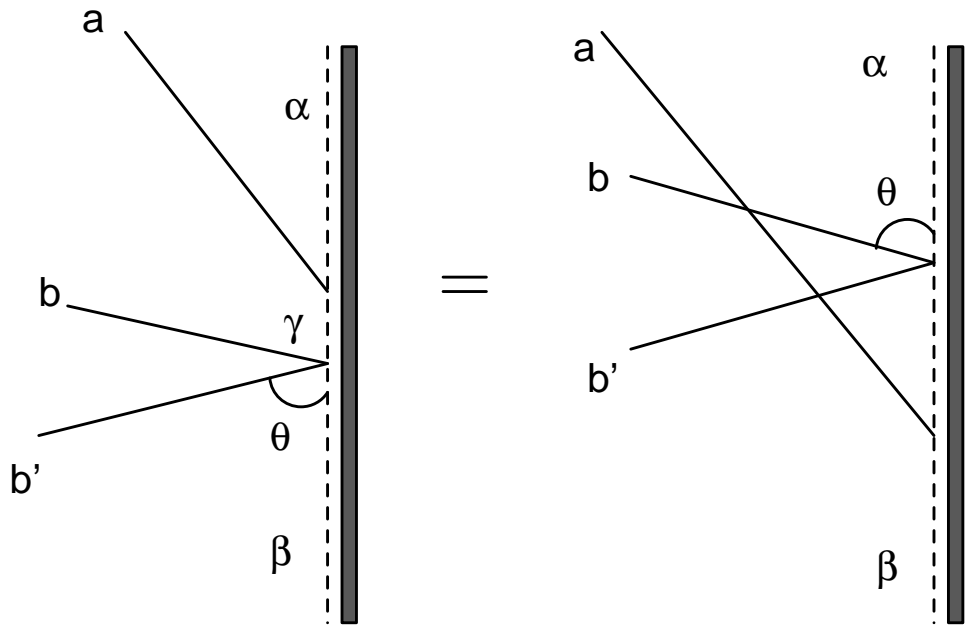

FIG-19

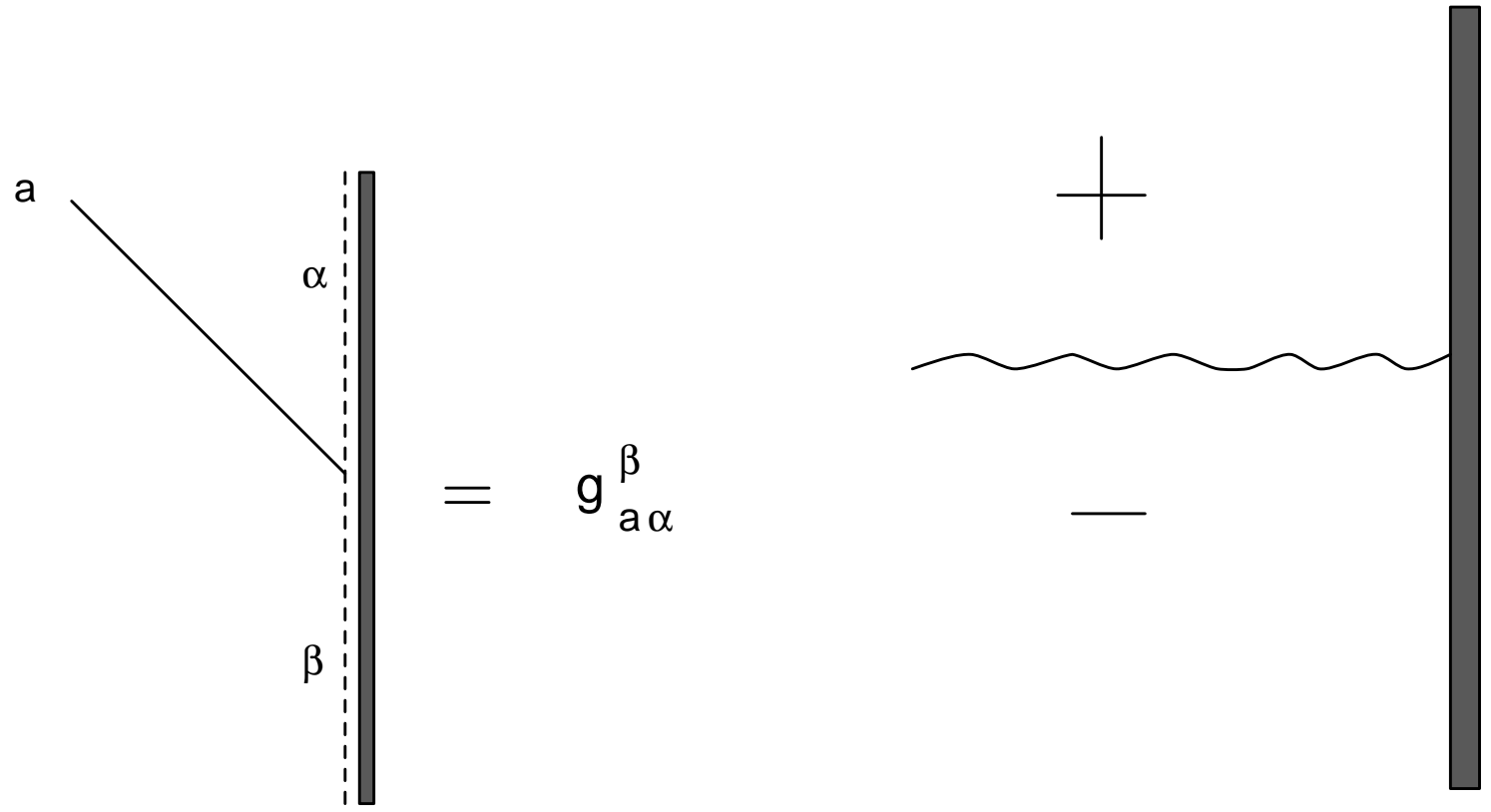

FIG-20

FIG-21

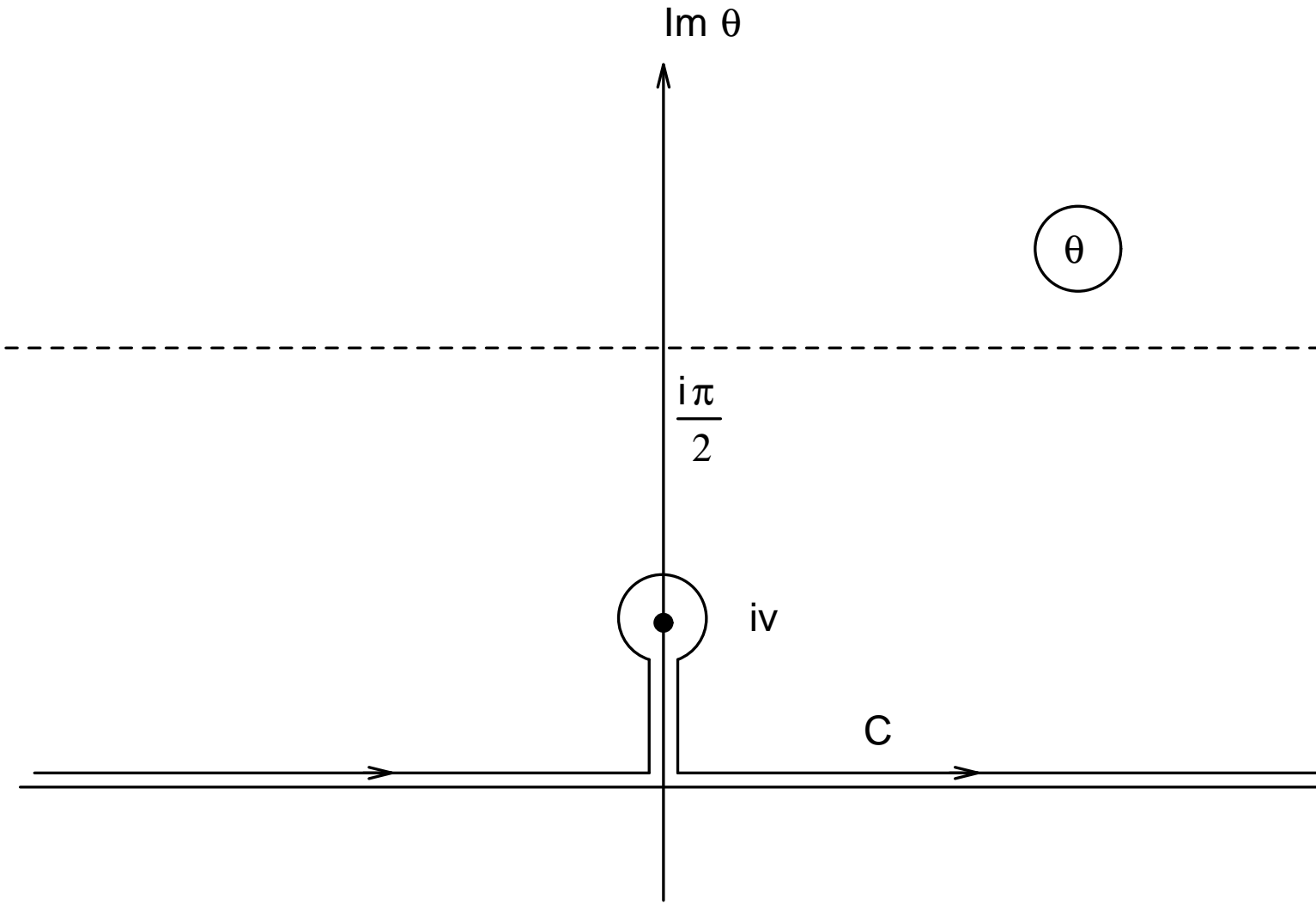

FIG-22

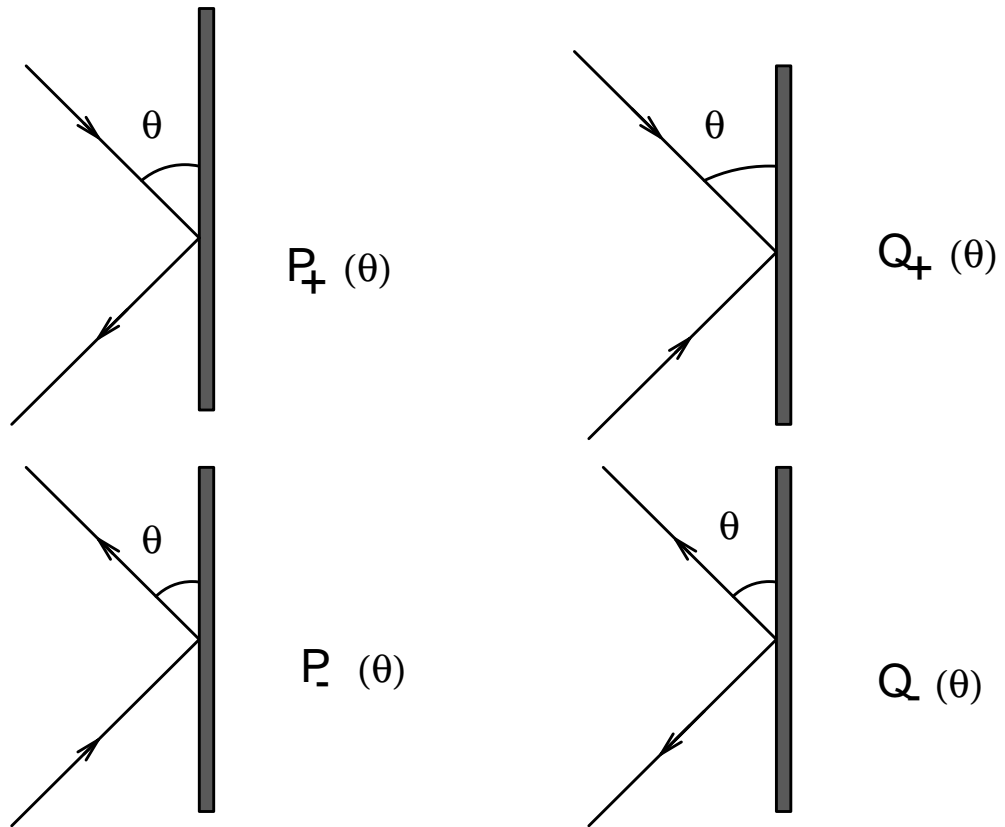

FIG-23

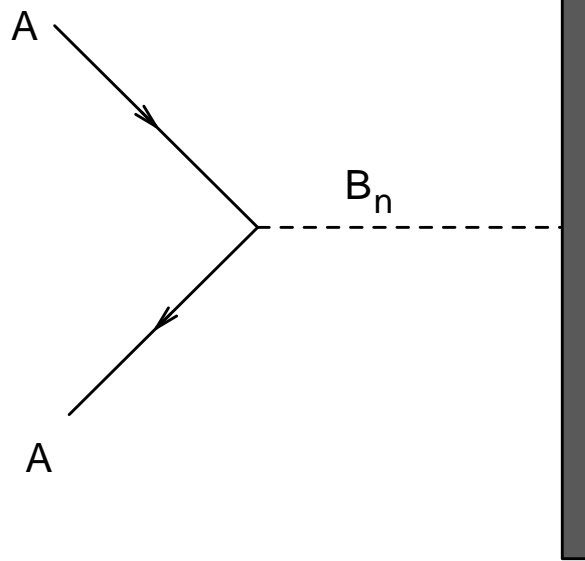

FIG-24

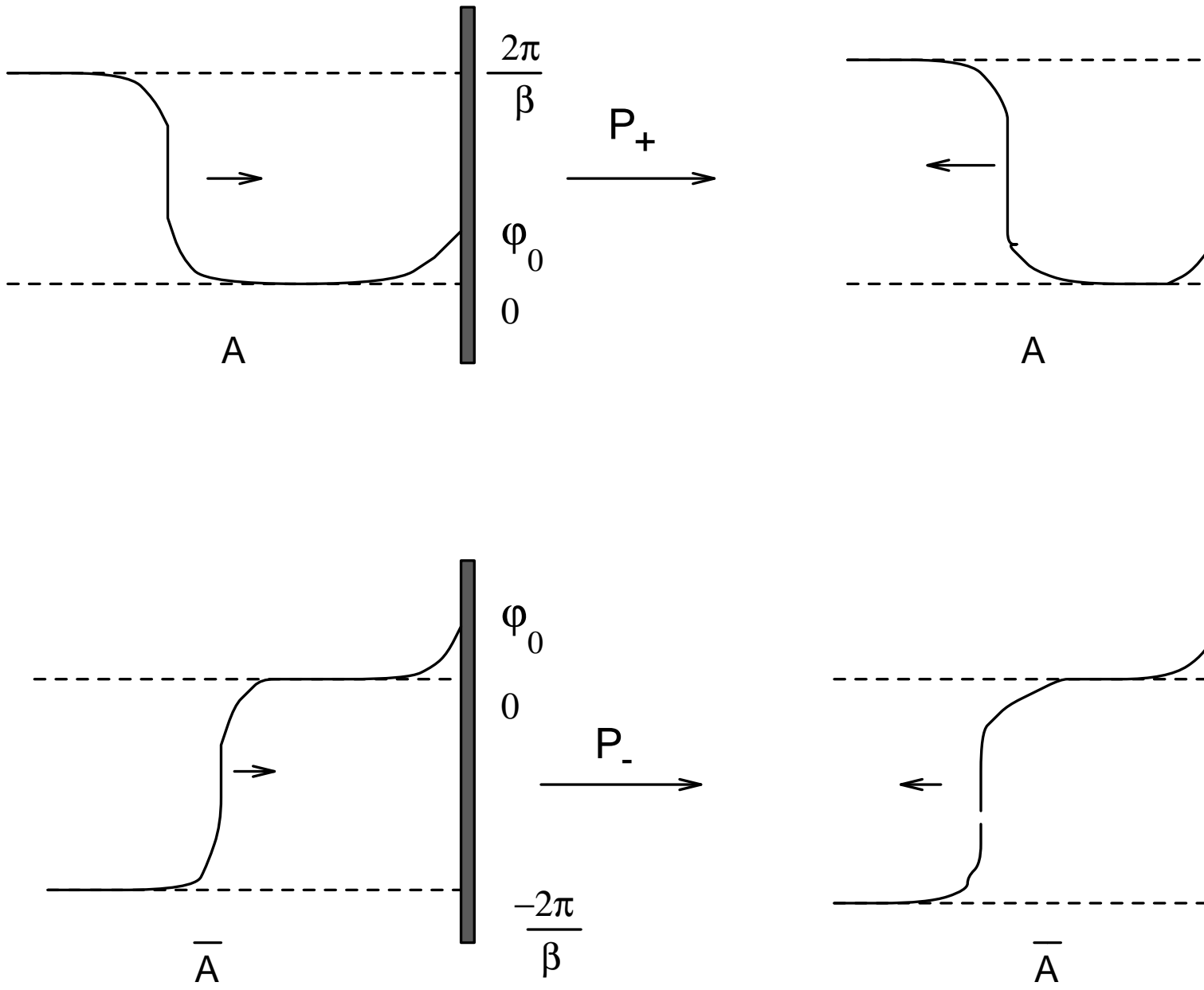

FIG-25

This figure "fig1-1.png" is available in "png" format from:

<http://arxiv.org/ps/hep-th/9306002v2>

This figure "fig2-1.png" is available in "png" format from:

<http://arxiv.org/ps/hep-th/9306002v2>

This figure "fig3-1.png" is available in "png" format from:

<http://arxiv.org/ps/hep-th/9306002v2>

This figure "fig4-1.png" is available in "png" format from:

<http://arxiv.org/ps/hep-th/9306002v2>



This figure "fig5-1.png" is available in "png" format from:

<http://arxiv.org/ps/hep-th/9306002v2>