

NEW VECTOR BOSONS IN THE ELECTROWEAK SECTOR: A RENORMALIZABLE MODEL WITH DECOUPLING

R. Casalbuoni, S. De Curtis and D. Dominici
Dipartimento di Fisica, Università di Firenze
I.N.F.N., Sezione di Firenze

M. Grazzini
Dipartimento di Fisica, Università di Parma
I.N.F.N., Gruppo collegato di Parma

ABSTRACT

A linear realization of a model of dynamical electroweak symmetry breaking describing additional heavy vector bosons is proposed. The model is a $SU(2)_L \otimes U(1) \otimes SU(2)'_L \otimes SU(2)'_R$ gauge theory, breaking at some high scale u to $SU(2)_{weak} \otimes U(1)_Y$ and breaking again in the standard way at the electroweak scale v to $U(1)_{em}$. The model is renormalizable and reproduces the Standard Model in the limit $u \rightarrow \infty$. This decoupling property is shown to hold also at the level of radiative corrections by computing, in particular, the ϵ parameters.

1 Introduction

Existing experimental data confirm with great accuracy the Standard Model (SM) of the electroweak interactions. Therefore, only extensions which smoothly modify the SM predictions are still conceivable. The Minimal Supersymmetric Standard Model (MSSM) [1] is the most favorite one because, in addition to many other interesting features, in the heavy limit (that is the limit in which all superpartner masses become heavy) decoupling holds and the MSSM becomes at low energy indistinguishable from the SM with a low Higgs mass [2]. However, this decoupling property is not peculiar of the MSSM; for instance, it is satisfied also in the non supersymmetric two Higgs model [3]. There are also examples of dynamical symmetry breaking schemes satisfying such a property. In fact, in a previous paper [4] we have considered a model (degenerate BESS) of a strong electroweak breaking sector describing, besides the standard W^\pm , Z and γ vector bosons, two new triplets of spin 1 particles, V_L and V_R . These new states are degenerate in mass if one neglects their mixing to the ordinary vector bosons. The description of the model was based on a non-linear gauged σ -model and we refer to [4] for more details. The interest in this scheme was due to the fact that it decouples: in the limit of infinite mass of the heavy vector bosons one gets back the Higgsless SM. This is a rather non trivial property because one is dealing with a non-linear theory with couplings increasing with the heavy masses. In fact, the decoupling originates from an accidental global symmetry that the model possesses when the gauge couplings are turned off. This is also the symmetry from which the quasi-degeneracy of the heavy vector states arises.

The original philosophy of the non-linear version was based on the idea that the non-linear realization would be the low-energy description of some underlying dynamics giving rise to the breaking of the electroweak symmetry. In a recent paper [5] we have suggested a linear realization of this model, which might appear as based on a completely different standpoint. We are thinking of a scenario very close to the one arising in technicolor [6] and in generalizations as non-commuting technicolor models [7], where one has an underlying strong dynamics producing heavy Higgs composite particles. In this sense we are trying to describe the theory at the level of its composite states, vectors (the new heavy bosons), and scalars (Higgs bosons). That is, we are looking at a scale in which the Higgs bosons are yet relevant degrees of freedom. The advantage is to deal with a renormalizable theory. By that, one is able to discuss the decoupling at the level of radiative corrections.

The model is a $SU(2)_L \otimes U(1) \otimes SU(2)'_L \otimes SU(2)'_R$ gauge theory, breaking at some high scale u to $SU(2)_{weak} \otimes U(1)_Y$ and breaking again in the standard way at the electroweak scale v to $U(1)_{em}$. In this paper we will show that this model in the limit of large u decouples also at one loop level, and consequently that the high-energy physics is not relevant at the LEPI scale. Therefore the model we present is identical to the SM in

its low energy manifestations, although at higher energies the differences can be rather dramatic [4, 8].

To show the decoupling we have concentrated on the observables which are relevant to LEPI physics, that is, on the so called ϵ parameters [9] (or the corresponding S , T , U parameters [10]). The universality property holds in the model, so we need only to consider the parameters ϵ_i , $i = 1, 2, 3$. We have performed the calculation of the corrections coming from the heavy sector of the model, following the scheme outlined in [2]. In this scheme one has to evaluate the self-energy corrections to the standard gauge boson propagators, the vertex corrections to $Z \rightarrow e^+e^-$ and the corrections to the Fermi coupling constant. At the end one collects all the various contributions together in order to reconstruct the physical quantities. For this reason we have not studied in detail the renormalization property of the model, but rather we have evaluated the different corrections in dimensional regularization and in the unitary gauge. In fact, as it must be, all the ultraviolet divergences cancel out when we evaluate the ϵ_i parameters. To make the calculations easier we have performed a particular transformation on the gauge parameters, in such a way to make the SM limit transparent. Also, we have chosen to work with mass eigenstates, because this makes those couplings, which increase with the heavy mass, to appear in only two sectors of the model. The first one is the Higgs sector, which, however, is not relevant in our calculations barring the standard hierarchy problem. The second one is the heavy-Higgs heavy-vector sector. This is shown to be harmless in the text. By following the previous procedure we show explicitly that no contribution to the ϵ_i parameters survive in the heavy mass limit, proving the decoupling of the model. This property appears to be strictly related to the absence of couplings increasing with the heavy scale in the light-light sector and in the heavy-light one (except for the Higgs case, as mentioned before). In fact, this is what one would expect from the Appelquist-Carazzone theorem [11]. However, the absence of these couplings is evident only in the unitary gauge, where the cancellations among the different contributions to the observable quantities are far from being trivial.

In Section 2 we will review the linearized version of the model. In Section 3 the scalar potential and the symmetry breaking are studied. In Section 4 the spectrum of gauge vector bosons and their interactions with the fermions are analyzed, showing in particular how the SM relations are obtained in the $u \rightarrow \infty$ limit. In Section 5 we perform the calculation at tree level of the ϵ parameters in the $u \rightarrow \infty$ limit, showing that they are of $O(v^2/u^2)$. General formulas for the ϵ parameters in terms of vacuum polarization amplitudes for the W , Z and γ , contributions to vector and axial-vector form factors at the Z pole in the Ze^+e^- vertex and one loop corrections to the μ decay amplitude are given in Section 6. Explicit one loop results for the vacuum polarization amplitudes in the $u \rightarrow \infty$ limit are given in Section 7. In Section 8 we derive some one loop general result for box, vertex and fermion self-energy amplitudes. In Section 9 one loop corrections to G_F in the $u \rightarrow \infty$ limit are considered, showing that they vanish. In Section 10 we show

that one loop corrections to vector and axial-vector form factors at the Z pole vanish in the same limit. In Appendix we give the explicit expressions of the relevant Higgs and gauge boson interaction terms.

2 The Model

The model [5], that we briefly recall here, is based on a gauge group $SU(2)_L \otimes U(1) \otimes SU(2)'_L \otimes SU(2)'_R$ and has a scalar sector consisting of scalar fields belonging to the following representations of the group $SU(2)_L \otimes SU(2)_R \otimes SU(2)'_L \otimes SU(2)'_R$

$$\tilde{L} \in (2, 0, 2, 0), \quad \tilde{U} \in (2, 2, 0, 0), \quad \tilde{R} \in (0, 2, 0, 2), \quad (2.1)$$

that is with transformation properties

$$\tilde{L}' = g_L \tilde{L} h_L, \quad \tilde{U}' = g_L \tilde{U} g_R^\dagger, \quad \tilde{R}' = g_R \tilde{R} h_R, \quad (2.2)$$

where

$$\begin{aligned} g_L &\in SU(2)_L, & g_R &\in SU(2)_R, \\ h_L &\in SU(2)'_L, & h_R &\in SU(2)'_R. \end{aligned} \quad (2.3)$$

We will see that with this system of scalar fields it is possible to break the gauge symmetries through the following chain

$$\begin{aligned} &SU(2)_L \otimes U(1) \otimes SU(2)'_L \otimes SU(2)'_R \\ &\quad \downarrow u \\ &SU(2)_{\text{weak}} \otimes U(1)_Y \\ &\quad \downarrow v \\ &U(1)_{\text{em}} \end{aligned} \quad (2.4)$$

The two breakings are induced by the expectation values $\langle \tilde{L} \rangle = \langle \tilde{R} \rangle = u$ and $\langle \tilde{U} \rangle = v$ respectively. The first two expectation values make the breaking $SU(2)_L \otimes SU(2)'_L \rightarrow SU(2)_{\text{weak}}$ and $U(1) \otimes SU(2)'_R \rightarrow U(1)_Y$, whereas the second breaks in the standard way $SU(2)_{\text{weak}} \otimes U(1)_Y \rightarrow U(1)_{\text{em}}$. In the following we will assume that the first breaking corresponds to a scale $u \gg v$.

Proceeding in a completely standard way, we can build up covariant derivatives with respect to the local $SU(2)_L \otimes U(1) \otimes SU(2)'_L \otimes SU(2)'_R$

$$\begin{aligned} D\tilde{L} &= \partial\tilde{L} + ig_0 \frac{\vec{\tau}}{2} \cdot \vec{W}\tilde{L} - ig_2 \tilde{L} \frac{\vec{\tau}}{2} \cdot \vec{V}_L, \\ D\tilde{R} &= \partial\tilde{R} + ig_1 \frac{\tau_3}{2} Y \tilde{R} - ig_3 \tilde{R} \frac{\vec{\tau}}{2} \cdot \vec{V}_R, \\ D\tilde{U} &= \partial\tilde{U} + ig_0 \frac{\vec{\tau}}{2} \cdot \vec{W}\tilde{U} - ig_1 \tilde{U} \frac{\tau_3}{2} Y, \end{aligned} \quad (2.5)$$

where \vec{V}_L (\vec{V}_R) are the gauge fields in $SU(2)'_L$ ($SU(2)'_R$), with the corresponding gauge couplings g_2 , and g_3 , whereas g_0 , g_1 , are the gauge couplings of the $SU(2)_L$ and $U(1)$ gauge groups respectively.

This model contains, besides the standard Higgs sector given by the field \tilde{U} , the additional scalar fields \tilde{L} and \tilde{R} .

The Lagrangian for the kinetic terms of these scalar fields is given by

$$\mathcal{L}^h = \frac{1}{4} \left[\text{Tr}(D_\mu \tilde{U})^\dagger (D^\mu \tilde{U}) + \text{Tr}(D_\mu \tilde{L})^\dagger (D^\mu \tilde{L}) + \text{Tr}(D_\mu \tilde{R})^\dagger (D^\mu \tilde{R}) \right]. \quad (2.6)$$

We have then to discuss the scalar potential which is supposed to break the original symmetry down to the $U(1)_{\text{em}}$ group. The most general potential invariant with respect to the group $SU(2)_L \otimes SU(2)_R \otimes SU(2)'_L \otimes SU(2)'_R$ is given by

$$\begin{aligned} V(\tilde{U}, \tilde{L}, \tilde{R}) = & \mu_1^2 \text{Tr}(\tilde{L}^\dagger \tilde{L}) + \frac{\lambda_1}{4} [\text{Tr}(\tilde{L}^\dagger \tilde{L})]^2 + \mu_2^2 \text{Tr}(\tilde{R}^\dagger \tilde{R}) + \frac{\lambda_2}{4} [\text{Tr}(\tilde{R}^\dagger \tilde{R})]^2 \\ & + m^2 \text{Tr}(\tilde{U}^\dagger \tilde{U}) + \frac{h}{4} [\text{Tr}(\tilde{U}^\dagger \tilde{U})]^2 + \frac{f_3}{2} \text{Tr}(\tilde{L}^\dagger \tilde{L}) \text{Tr}(\tilde{R}^\dagger \tilde{R}) \\ & + \frac{f_1}{2} \text{Tr}(\tilde{L}^\dagger \tilde{L}) \text{Tr}(\tilde{U}^\dagger \tilde{U}) + \frac{f_2}{2} \text{Tr}(\tilde{R}^\dagger \tilde{R}) \text{Tr}(\tilde{U}^\dagger \tilde{U}). \end{aligned} \quad (2.7)$$

In the following we will also require, for the scalar potential, the discrete symmetry $L \leftrightarrow R$, which implies

$$\begin{aligned} g_3 &= g_2, \\ \mu_1 &= \mu_2 = \mu, \\ \lambda_1 &= \lambda_2 = \lambda, \\ f_1 &= f_2 = f. \end{aligned} \quad (2.8)$$

The total Lagrangian is obtained by adding the kinetic terms for the gauge fields:

$$\mathcal{L} = \mathcal{L}^h - V(\tilde{U}, \tilde{L}, \tilde{R}) + \mathcal{L}^{\text{kin}}(W, Y, V_L, V_R), \quad (2.9)$$

where

$$\begin{aligned} \mathcal{L}^{\text{kin}}(W, Y, V_L, V_R) = & \frac{1}{2} \text{tr}[F_{\mu\nu}(W)F^{\mu\nu}(W)] + \frac{1}{2} \text{tr}[F_{\mu\nu}(Y)F^{\mu\nu}(Y)] \\ & + \frac{1}{2} \text{tr}[F_{\mu\nu}(V_L)F^{\mu\nu}(V_L)] + \frac{1}{2} \text{tr}[F_{\mu\nu}(V_R)F^{\mu\nu}(V_R)]. \end{aligned} \quad (2.10)$$

Notice that, when neglecting the gauge interactions, the Lagrangian is invariant under an extended symmetry corresponding to $(SU(2)_L \otimes SU(2)_R)^3$. In fact, in this case, we are free to change any of the fields \tilde{U} , \tilde{L} , \tilde{R} by an independent transformation of a group $SU(2)_L \otimes SU(2)_R$ [4]. As far as the fermions are concerned they transform as in the SM with respect to the group $SU(2)_L \otimes U(1)$, correspondingly the Yukawa terms are built up exactly as in the SM.

3 The scalar potential

Let us parameterize the scalar fields as

$$\tilde{L} = \rho_L L, \quad \tilde{R} = \rho_R R, \quad \tilde{U} = \rho_U U, \quad (3.1)$$

with $L^\dagger L = I$, $R^\dagger R = I$ and $U^\dagger U = I$.

The scalar potential after these transformations can be rewritten as

$$\begin{aligned} V(\rho_U, \rho_L, \rho_R) &= 2\mu^2(\rho_L^2 + \rho_R^2) + \lambda(\rho_L^4 + \rho_R^4) + 2m^2\rho_U^2 + h\rho_U^4 \\ &+ 2f_3\rho_L^2\rho_R^2 + 2f\rho_U^2(\rho_L^2 + \rho_R^2). \end{aligned} \quad (3.2)$$

To study the minimum conditions, let us consider the first derivatives of the potential

$$\frac{\partial V}{\partial \rho_L} = 4\rho_L(\mu^2 + \lambda\rho_L^2 + f_3\rho_R^2 + f\rho_U^2), \quad (3.3)$$

$$\frac{\partial V}{\partial \rho_R} = 4\rho_R(\mu^2 + \lambda\rho_R^2 + f_3\rho_L^2 + f\rho_U^2), \quad (3.4)$$

$$\frac{\partial V}{\partial \rho_U} = 4\rho_U(m^2 + h\rho_U^2 + f(\rho_L^2 + \rho_R^2)). \quad (3.5)$$

By substituting the vacuum expectation values $\langle \rho_U \rangle = v$ and $\langle \rho_L \rangle = \langle \rho_R \rangle = u$, the minimum conditions are

$$\mu^2 + (f_3 + \lambda)u^2 + fv^2 = 0, \quad (3.6)$$

$$m^2 + 2fu^2 + hv^2 = 0. \quad (3.7)$$

From the second derivatives of the potential we get the mass matrix for the three Higgs particles

$$8 \begin{pmatrix} \lambda u^2 & f_3 u^2 & fuv \\ f_3 u^2 & \lambda u^2 & fuv \\ fuv & fuv & hv^2 \end{pmatrix}. \quad (3.8)$$

The mass eigenvalues are

$$\begin{aligned} M_{\rho_U}^2 &= 4[(f_3 + \lambda)u^2 + hv^2 - \sqrt{8u^2v^2f^2 + ((f_3 + \lambda)u^2 - hv^2)^2}], \\ M_{\rho_L}^2 &= 8\lambda u^2(1 - \frac{f_3}{\lambda}), \\ M_{\rho_R}^2 &= 4[(f_3 + \lambda)u^2 + hv^2 + \sqrt{8u^2v^2f^2 + ((f_3 + \lambda)u^2 - hv^2)^2}]. \end{aligned} \quad (3.9)$$

Let us comment on the limitations on the parameters coming from the study of the positivity of the eigenvalues. Adding the requirement $u^2 > 0$, $v^2 > 0$, with the hypothesis $m^2, \mu^2 < 0$ together with $\lambda, h > 0$ for the boundedness of the potential, we finally get

$$\lambda - f_3 > 0, \quad h > f \frac{m^2}{\mu^2}, \quad (3.10)$$

and

$$\lambda + f_3 > 2f \frac{\mu^2}{m^2} \quad \text{for } f > 0, \quad \text{or} \quad (3.11)$$

$$\lambda + f_3 > 2 \frac{f^2}{h} \quad \text{for } f < 0. \quad (3.12)$$

As shown in [5] the limit $u \rightarrow \infty$ gives the SM with a Higgs field light with respect to the scale u , with the following redefinition of the gauge coupling constants

$$\begin{aligned} \frac{1}{g^2} &= \frac{1}{g_0^2} + \frac{1}{g_2^2}, \\ \frac{1}{g'^2} &= \frac{1}{g_1^2} + \frac{1}{g_2^2}. \end{aligned} \quad (3.13)$$

At the lowest order in the large u expansion we get for the Higgs mass eigenvalues

$$\begin{aligned} M_{\rho_U}^2 &\sim 8v^2 \left(h - 2 \frac{f^2}{f_3 + \lambda} \right), \\ M_{\rho_L}^2 &\sim 8u^2 (\lambda - f_3), \\ M_{\rho_R}^2 &\sim 8u^2 (\lambda + f_3). \end{aligned} \quad (3.14)$$

The scalar potential, after the shift $\rho_L \rightarrow \rho_L + u$, $\rho_R \rightarrow \rho_R + u$ and $\rho_U \rightarrow \rho_U + v$, and by substituting m^2 , μ^2 as functions of the other parameters by using the minimum conditions (3.6) and (3.7), becomes

$$\begin{aligned} V(\rho_U, \rho_L, \rho_R) &= 4hv^2 \rho_U^2 + 8fuv \rho_U (\rho_L + \rho_R) + 4\lambda u^2 (\rho_L^2 + \rho_R^2) + 8f_3 u^2 \rho_L \rho_R \\ &+ 4hv \rho_U^3 + 4\lambda u (\rho_L^3 + \rho_R^3) + 4fu \rho_U^2 (\rho_L + \rho_R) + 4fv \rho_U (\rho_L^2 + \rho_R^2) \\ &+ 4f_3 u (\rho_R \rho_L^2 + \rho_L \rho_R^2) + h \rho_U^4 + \lambda (\rho_L^4 + \rho_R^4) \\ &+ 2f_3 \rho_L^2 \rho_R^2 + 2f \rho_U^2 (\rho_L^2 + \rho_R^2). \end{aligned} \quad (3.15)$$

Since we will not be interested in the Higgs self-interactions, we will not give the explicit expression of the scalar potential in terms of the mass eigenstates. It can be easily obtained by using the matrix \mathbf{H} which transforms the fields (ρ_L, ρ_R, ρ_U) appearing

in eq. (3.15) into the Higgs eigenstates which we will keep on calling in the same way. At the first order in

$$r = \frac{v^2 g^2}{u^2 g_2^2}, \quad (3.16)$$

we get

$$\mathbf{H}^{-1} = \begin{pmatrix} \frac{1}{\sqrt{2}} & \frac{1}{\sqrt{2}}(1 - \frac{q^2}{s_\varphi^2}r) & -\frac{q}{s_\varphi}\sqrt{r} \\ -\frac{1}{\sqrt{2}} & \frac{1}{\sqrt{2}}(1 - \frac{q^2}{s_\varphi^2}r) & -\frac{q}{s_\varphi}\sqrt{r} \\ 0 & \frac{q}{s_\varphi}\sqrt{2r} & 1 - \frac{q^2}{s_\varphi^2}r \end{pmatrix}, \quad (3.17)$$

with

$$q = \frac{f}{f_3 + \lambda}, \quad (3.18)$$

and

$$s_\varphi = \frac{g}{g_2}, \quad (3.19)$$

in terms of which

$$g_0 = \frac{g}{c_\varphi}, \quad (3.20)$$

and

$$\frac{g_1}{g_0} = \frac{c_\varphi s_\theta}{\sqrt{P}}, \quad (3.21)$$

where

$$\tan \theta = \frac{g'}{g}, \quad (3.22)$$

and

$$P = c_\theta^2 - s_\varphi^2 s_\theta^2. \quad (3.23)$$

4 Gauge vector boson spectrum and interactions

The vector boson mass spectrum can be studied in the unitary gauge $U = L = R = I$ by shifting the scalar fields as $\rho_U \rightarrow \rho_U + v$, $\rho_{L,R} \rightarrow \rho_{L,R} + u$. We get

$$\begin{aligned} \mathcal{L}^h &= \frac{1}{2} [(\partial_\mu \rho_L)^2 + (\partial_\mu \rho_R)^2 + (\partial_\mu \rho_U)^2] \\ &+ \frac{1}{8} \{(\rho_L + u)^2 [g_0^2 (W_3^2 + 2W^+ W^-) - 2g_0 g_2 (W_3 V_{3L} + W^- V_L^+ + W^+ V_L^-)] \\ &+ g_2^2 (V_{3L}^2 + 2V_L^+ V_L^-)] \\ &+ (\rho_R + u)^2 [g_1^2 Y^2 - 2g_1 g_2 V_{3R} Y + g_2^2 (V_{3R}^2 + 2V_R^+ V_R^-)] \\ &+ (\rho_U + v)^2 [g_0^2 (W_3^2 + 2W^+ W^-) - 2g_0 g_1 W_3 Y + g_1^2 Y^2] \}. \end{aligned} \quad (4.1)$$

Here we are interested in the mass matrices for large mass eigenvalues of $V_{L,R}$, $\rho_{L,R}$. First of all, it turns out to be convenient to re-express the results in terms of the parameters g and g' defined in eq. (3.13). In fact, as we have said, these are the relevant parameters in the limit $u \rightarrow \infty$. Let us study the mass eigenvalues of the vector bosons in the charged and in the neutral sector.

Charged gauge sector

The fields V_R^\pm are unmixed and their mass is given by

$$M_{V_R}^2 = \frac{1}{4}g_2^2 u^2 \equiv M^2. \quad (4.2)$$

The absence of mixing terms is a consequence of the invariance of the Lagrangian under the phase transformation $V_R^\pm \rightarrow \exp(\pm i\alpha)V_R^\pm$. In fact, from (2.5), only V_{3R} mixes with the light vector fields. Notice that the parameter r in eq. (3.16) can be written also in the following way

$$r = \frac{1}{4} \frac{g^2 v^2}{M^2}. \quad (4.3)$$

The remaining two eigenvalues, in the limit of small r are (we continue to call W^\pm , V_L^\pm the mass eigenvectors)

$$\begin{aligned} M_W^2 &= \frac{v^2}{4}g^2(1 - rs_\varphi^2 + \dots), \\ M_{V_L}^2 &= \frac{v^2}{4}g^2\left(\frac{1}{r} \frac{1}{c_\varphi^2} + \frac{s_\varphi^2}{c_\varphi^2} + rs_\varphi^2 + \dots\right). \end{aligned} \quad (4.4)$$

Notice that for $r \rightarrow 0$, M_W^2 coincides with the SM expression for the W mass.

Let us call \mathbf{C} the matrix which transforms the fields (W^\pm, V_L^\pm) appearing in the Lagrangian (4.1) into the charged eigenstates. At the first order in r we get

$$\mathbf{C}^{-1} = \begin{pmatrix} c_\varphi(1 - s_\varphi^2 r) & -s_\varphi(1 + c_\varphi^2 r) \\ s_\varphi(1 + c_\varphi^2 r) & c_\varphi(1 - s_\varphi^2 r) \end{pmatrix}. \quad (4.5)$$

Neutral gauge sector

In this sector there is a null eigenvector corresponding to the photon:

$$\gamma = (s_{\bar{\theta}}W_3 + c_{\bar{\theta}}Y) \cos \psi + \frac{1}{\sqrt{2}}(V_{3L} + V_{3R}) \sin \psi, \quad (4.6)$$

where

$$\begin{aligned}\tan \tilde{\theta} &= c_\varphi s_\theta \sqrt{P}, \\ \tan \psi &= \sqrt{2} s_\theta \frac{g_0}{g_2} = \sqrt{2} \frac{s_\varphi s_\theta}{\sqrt{1 - 2s_\varphi^2 s_\theta^2}}.\end{aligned}\quad (4.7)$$

The remaining eigenvalues are, again in the limit of small r ,

$$\begin{aligned}M_Z^2 &= \frac{v^2 g^2}{4 c_\theta^2} \left(1 - r s_\varphi^2 \frac{1 - 2c_\theta^2 + 2c_\theta^4}{c_\theta^4} + \dots\right), \\ M_{V_{3L}}^2 &= \frac{v^2 g^2}{4} \left(\frac{1}{r c_\varphi^2} + \frac{s_\varphi^2}{c_\varphi^2} - r s_\varphi^2 \frac{c_\theta^2}{1 - 2c_\theta^2} + \dots\right), \\ M_{V_{3R}}^2 &= \frac{v^2 g^2}{4 c_\theta^2} \left(\frac{1 c_\theta^4}{r P} + \frac{s_\varphi^2 s_\theta^4}{P} + r \frac{s_\varphi^2 s_\theta^8}{c_\theta^4 (1 - 2c_\theta^2)} + \dots\right).\end{aligned}\quad (4.8)$$

Only for $\varphi = 0$ the heavy vectors are degenerate in mass.

Let us call \mathbf{N} the matrix which transforms the fields (W_3, Y, V_{3L}, V_{3R}) appearing in the Lagrangian (4.1) into the neutral eigenstates which we will call $(\gamma, Z, V_{3L}, V_{3R})$. At the first order in r we get

$$\mathbf{N}^{-1} = \begin{pmatrix} c_\varphi s_\theta & c_\varphi (c_\theta - \frac{s_\varphi^2 r}{c_\theta}) & -s_\varphi (1 + c_\varphi^2 r) & \frac{c_\varphi s_\varphi s_\theta^4 \sqrt{P}}{c_\theta^3 (1 - 2c_\theta^2)} r \\ \sqrt{P} & -\frac{s_\theta}{c_\theta} \sqrt{P} (1 - \frac{s_\varphi^2 s_\theta^2}{c_\theta^4} r) & -\frac{c_\varphi s_\varphi s_\theta \sqrt{P}}{1 - 2c_\theta^2} r & -\frac{s_\varphi s_\theta}{c_\theta} (1 + \frac{s_\theta^2 P}{c_\theta^4} r) \\ s_\varphi s_\theta & s_\varphi c_\theta (1 + \frac{c_\varphi^2 r}{c_\theta^2}) & c_\varphi (1 - s_\varphi^2 r) & -\frac{s_\theta^2 P^{3/2}}{c_\theta^3 (1 - 2c_\theta^2)} r \\ s_\varphi s_\theta & -\frac{s_\varphi s_\theta^2}{c_\theta} (1 + \frac{P}{c_\theta^4} r) & \frac{c_\varphi^3 s_\theta^2}{1 - 2c_\theta^2} r & \frac{\sqrt{P}}{c_\theta} (1 - \frac{s_\varphi^2 s_\theta^4}{c_\theta^4} r) \end{pmatrix}. \quad (4.9)$$

We will now consider the couplings of the vector bosons to the fermions. We assume that the fermions have standard transformation properties under the group $SU(2)_L \otimes U(1)_Y$, and therefore the couplings to the heavy bosons arise only through the mixing.

In the charged sector, at the first order in r the couplings are given by

$$\mathcal{L}_{\text{fermions}}^{\text{charged}} = -(h_W W_\mu^- + h_L V_{L\mu}^-) J_L^{\mu-} + h.c., \quad (4.10)$$

with

$$h_W = \frac{g}{\sqrt{2}} (1 - s_\varphi^2 r), \quad (4.11)$$

$$h_L = -\frac{g}{\sqrt{2}} (1 + c_\varphi^2 r) \tan \varphi, \quad (4.12)$$

and $J_L^\pm = \bar{\psi}_L \gamma^\mu \tau^\pm \psi_L$. Notice that there is no coupling of V_R^\pm to fermions, because these particles do not mix with the W^\pm 's. Also, for $r = 0$ the couplings of W^\pm to the fermions coincide with the standard ones.

In the neutral sector the couplings are defined by

$$\begin{aligned} \mathcal{L}_{\text{fermions}}^{\text{neutral}} = & -eJ_{em}\gamma - [AJ_{3L} + BJ_{em}]Z \\ & -[CJ_{3L} + DJ_{em}]V_{3L} - [EJ_{3L} + FJ_{em}]V_{3R}, \end{aligned} \quad (4.13)$$

with

$$e = gs_\theta, \quad (4.14)$$

and

$$\begin{aligned} A &= \frac{g}{c_\theta} \left(1 - s_\varphi^2 \frac{s_\theta^4 + c_\theta^4}{c_\theta^4} r\right), \\ B &= \frac{g}{c_\theta} \left(-s_\theta^2 + \frac{s_\varphi^2 s_\theta^4}{c_\theta^4} r\right), \\ C &= \frac{g}{c_\theta} \left(-\tan \varphi c_\theta + \frac{c_\varphi s_\varphi c_\theta^3}{2c_\theta^2 - 1} r\right), \\ D &= \frac{g}{c_\theta} \frac{c_\varphi s_\varphi s_\theta^2 c_\theta}{2c_\theta^2 - 1} r, \\ E &= \frac{g}{c_\theta} \left(\frac{s_\varphi s_\theta^2}{\sqrt{P}} + \frac{s_\varphi s_\theta^6 \sqrt{P}}{c_\theta(1 - 2c_\theta^2)} r\right), \\ F &= \frac{g}{c_\theta} \left(-\frac{s_\varphi s_\theta^2}{\sqrt{P}} - \frac{s_\varphi s_\theta^4 \sqrt{P}}{c_\theta^4} r\right). \end{aligned} \quad (4.15)$$

The expression for the electric charge is valid to all order in r , while the other coefficients in (4.15) are given only at first order in r . In particular the couplings of the Z to fermions go back to their SM values for $r \rightarrow 0$. Notice that there are no couplings increasing when $r \rightarrow 0$, both in the charged and in the neutral sector.

We can rewrite the fermionic couplings of a generic gauge boson V in a form which will be useful later:

$$\bar{\psi}[v^V + a^V \gamma_5] \gamma_\mu \psi V^\mu, \quad (4.16)$$

where, by comparing with eqs. (4.10-4.15), we get for the charged sector:

$$\begin{aligned} v^W &= -\frac{h_W}{2}, & a^W &= v^W, \\ v^L &= -\frac{h_L}{2}, & a^L &= v^L, \end{aligned} \quad (4.17)$$

and, for the neutral one:

$$\begin{aligned}
v^Z &= -\left(A\frac{\tau_3}{4} + BQ_{em}\right), & a^Z &= -A\frac{\tau_3}{4}, \\
v^{3L} &= -\left(C\frac{\tau_3}{4} + DQ_{em}\right), & a^{3L} &= -C\frac{\tau_3}{4}, \\
v^{3R} &= -\left(E\frac{\tau_3}{4} + FQ_{em}\right), & a^{3R} &= -E\frac{\tau_3}{4}.
\end{aligned} \tag{4.18}$$

5 The ϵ parameters: tree level

At tree level, the definition of the Fermi constant G_F is

$$\frac{G_F}{\sqrt{2}} = \frac{1}{4} \left(\frac{h_W^2}{M_W^2} + \frac{h_L^2}{M_{V_L}^2} \right) = \frac{1}{2v^2}, \tag{5.1}$$

This is an exact result, and it can be verified at the order r by using eqs. (4.11), (4.12) and (4.4).

From the expression of M_Z^2 in (4.8), by using (4.14) and (5.1) we get at the first order in r

$$c_\theta^2 = c_{\theta_0}^2 \left(1 + r\Delta \frac{s_\theta^2}{c_\theta^2 - s_\theta^2} \right), \tag{5.2}$$

with

$$\begin{aligned}
\Delta &= s_\varphi^2 \frac{1 - 2c_\theta^2 + 2c_\theta^4}{c_\theta^4}, \\
c_{\theta_0}^2 &= \frac{1}{2} + \sqrt{\frac{1}{4} - \frac{\pi\alpha}{\sqrt{2}G_F M_Z^2}}.
\end{aligned} \tag{5.3}$$

Notice that the θ_0 angle, here defined, coincides with the θ angle given in eq. (44) of ref. [4]. In ref. [5] we were interested in the leading order $r = 0$ and so we did not distinguish between θ and θ_0 .

By using the expressions for M_W and M_Z in eqs. (4.4) and (4.8), the eq. (5.2) and the definition of Δr_W given by

$$\frac{M_W^2}{M_Z^2} = c_{\theta_0}^2 \left(1 - \frac{s_\theta^2}{c_\theta^2 - s_\theta^2} \Delta r_W \right), \tag{5.4}$$

we obtain

$$\Delta r_W = -r \frac{s_\varphi^2}{c_\theta^2}. \tag{5.5}$$

From the standard definition

$$\mathcal{L}_{\text{fermions}}^Z = -\frac{e}{s_{\theta_0}c_{\theta_0}}\left(1 + \frac{\Delta\rho}{2}\right)[J_{3L} - s_{\theta_0}^2(1 + \Delta k)J_{em}], \quad (5.6)$$

by comparing with (4.13) and using (5.1) we get

$$\begin{aligned} \Delta\rho &= -rs_\varphi^2 \frac{c_\theta^4 + s_\theta^4}{c_\theta^4}, \\ \Delta k &= -2rs_\varphi^2 \frac{s_\theta^2}{c_\theta^2 - s_\theta^2}, \end{aligned} \quad (5.7)$$

from which we extract the expressions for the ϵ parameters at the first order in r [4]:

$$\begin{aligned} \epsilon_1 &= -rs_\varphi^2 \frac{c_\theta^4 + s_\theta^4}{c_\theta^4}, \\ \epsilon_2 &= -rs_\varphi^2, \\ \epsilon_3 &= -r\frac{s_\varphi^2}{c_\theta^2}. \end{aligned} \quad (5.8)$$

This shows that at tree level the heavy sector decouples, at least as far as its contribution to LEPI physics is concerned. The restrictions on the parameter space coming from (5.8) have been recently discussed in [8].

6 The ϵ parameters: one loop level

To evaluate the radiative corrections to the ϵ parameters, we will use the definition given in [2] which is more suitable than the one used in the previous Section in terms of the observables. Obviously the two definitions lead to the same result. For instance the result in eq. (5.8) was verified in ref. [12] by using the procedure which will be discussed below.

Following the definitions of the ϵ parameters given in [2] we need to calculate, besides the corrections to the vacuum polarization amplitudes for the W , Z and γ , the contributions to the vector and the axial-vector form factors at the Z pole in the Zl^+l^- vertex and the one loop corrections (boxes, vertices, new vector boson and fermion self-energies) to the μ decay amplitude at zero external momenta.

Let us define the vacuum self-energies

$$\Pi_{ij}^{\mu\nu}(p) = -ig^{\mu\nu}\Pi_{ij}(p^2) + p^\mu p^\nu \text{ terms}, \quad (6.1)$$

where

$$\Pi_{ij}(p^2) = A_{ij}(0) + p^2 F_{ij}(p^2), \quad (6.2)$$

with $i, j = W, \gamma, Z$.

The corrections to the vector and axial-vector form factors at $p^2 = M_Z^2$ in the Z leptonic interactions from proper vertex and fermion self-energies are parameterized as

$$-i \frac{e}{2c_{\theta_0}s_{\theta_0}} \bar{\nu} \gamma_\mu [\delta g_V - \gamma_5 \delta g_A] u, \quad (6.3)$$

where θ_0 is defined in eq. (5.3).

The third contribution comes from the one loop corrections to G_F from the μ decay (except the W self-energy [2]):

$$-i \delta G_F [\bar{e} \gamma_\mu (1 - \gamma_5) \nu_e] [\bar{\nu}_\mu \gamma^\mu (1 - \gamma_5) \mu]. \quad (6.4)$$

In terms of these quantities one can express the ϵ parameters as

$$\begin{aligned} \epsilon_1 &= e_1 - e_5 - \frac{\delta G_F}{G_F} - 4\delta g_A, \\ \epsilon_2 &= e_2 - s_{\theta_0}^2 e_4 - c_{\theta_0}^2 e_5 - \frac{\delta G_F}{G_F} - \delta g_V - 3\delta g_A, \\ \epsilon_3 &= e_3 + c_{\theta_0}^2 e_4 - c_{\theta_0}^2 e_5 + \frac{c_{\theta_0}^2 - s_{\theta_0}^2}{2s_{\theta_0}^2} \delta g_V - \frac{1 + 2s_{\theta_0}^2}{2s_{\theta_0}^2} \delta g_A, \end{aligned} \quad (6.5)$$

with

$$\begin{aligned} e_1 &= \frac{A_{33}(0) - A_{WW}(0)}{M_W^2}, \\ e_2 &= F_{WW}(M_W^2) - F_{33}(M_Z^2), \\ e_3 &= \frac{c_{\theta_0}}{s_{\theta_0}} F_{30}(M_Z^2), \\ e_4 &= F_{\gamma\gamma}(0) - F_{\gamma\gamma}(M_Z^2), \\ e_5 &= M_Z^2 F'_{ZZ}(M_Z^2), \end{aligned} \quad (6.6)$$

where the indices 0, 3 refer to Y, W_3 bosons and the following relations hold:

$$\begin{aligned} \Pi_{30} &= -s_{\theta_0} c_{\theta_0} \Pi_{ZZ} + s_{\theta_0} c_{\theta_0} \Pi_{\gamma\gamma} + (c_{\theta_0}^2 - s_{\theta_0}^2) \Pi_{Z\gamma}, \\ \Pi_{33} &= c_{\theta_0}^2 \Pi_{ZZ} + 2s_{\theta_0} c_{\theta_0} \Pi_{Z\gamma} + s_{\theta_0}^2 \Pi_{\gamma\gamma}. \end{aligned} \quad (6.7)$$

We will evaluate the contribution to the ϵ parameters at one loop level, by using dimensional regularization for the UV divergences in the loops and we will introduce the arbitrary mass scale parameter μ . Since we are interested in the decoupling properties of the model only for observable quantities, the ultraviolet divergent terms will not play any role and in fact they cancel out. Therefore we will not perform the full renormalization procedure of the model.

7 Vacuum polarization amplitudes

We list here the results for the vector boson self-energy diagrams. In evaluating the vacuum polarization amplitudes, since we are interested in proving the decoupling, we keep only the potentially dangerous terms and we neglect terms proportional to r . Of course we will not consider diagrams with only light particles because they give the SM contribution plus corrections of order r that we neglect. All the relevant couplings are given in the Appendix. We will list here the contributions to the various vacuum polarization functions.

For the W self-energy, we have contributions from the graphs S_1 , S_2 and S_3 (Fig. 1). In particular, by indicating with $\Pi^{(i)}$ the amplitude from S_i , we get

$$\begin{aligned} \Pi_{WW}^{(1)}(p) &= g^2 \left\{ r^2 s_\varphi^2 c_\varphi^2 A_1(p, M_W, M_{V_{3L}}) + r^2 \frac{s_\varphi^2 s_\theta^4 P}{c_\theta^6} A_1(p, M_W, M_{V_{3R}}) \right. \\ &\quad \left. + (1 - 2r(1 - 2c_\varphi^2)) A_1(p, M_{V_L}, M_{V_{3L}}) + r^2 \frac{s_\varphi^2 c_\varphi^2}{c_\theta^2} A_1(p, M_{V_L}, M_Z) \right\}, \end{aligned} \quad (7.1)$$

$$\Pi_{WW}^{(2)}(p) = \frac{g^2}{2} (1 - 2r(1 - 2c_\varphi^2)) \{ A_2(M_{V_L}) + A_2(M_{V_{3L}}) \}, \quad (7.2)$$

$$\Pi_{WW}^{(3)}(p) = g^2 \frac{s_\varphi^2}{c_\varphi^2} M_W^2 A_3(p, M_{\rho_U}, M_{V_L}) + 2g^2 \frac{r}{s_\varphi^2} q^2 M_W^2 A_3(p, M_{\rho_R}, M_W). \quad (7.3)$$

The functions A_i are the result of the various loop integrals. As already said, we will neglect all the contributions to the self-energies going to zero with r . For this reason we give the explicit expressions of the A_i functions only up to the order which leads to non vanishing results. The exact results for A_1 and A_3 can be found in [13]. We have

$$A_1(p, M_H, M_H) = \frac{1}{16\pi^2} \left\{ \left(\frac{9}{2} M_H^2 + 7p^2 \right) Y_H - \frac{3}{4} M_H^2 - \frac{2}{3} p^2 \right\} + \mathcal{O}\left(\frac{1}{M_H^2}\right), \quad (7.4)$$

$$A_1(p, m, M_H) = \frac{1}{16\pi^2} \frac{M_H^4}{m^2} X_H + \mathcal{O}(M_H^2), \quad (7.5)$$

$$A_2(M_H) = -\frac{1}{16\pi^2} \left\{ \frac{9}{2} M_H^2 Y_H - \frac{3}{4} M_H^2 \right\}, \quad (7.6)$$

$$A_3(p, m, M_H) = \frac{1}{16\pi^2} X_H + \mathcal{O}\left(\frac{1}{M_H^2}\right), \quad (7.7)$$

$$A_3(p, M_H, m) = \frac{1}{16\pi^2} \frac{M_H^2}{m^2} \left(\frac{1}{4} Y_H - \frac{3}{8} \right) + \mathcal{O}(\log M_H^2), \quad (7.8)$$

with

$$\begin{aligned} Y_H &= -\frac{2}{\epsilon} + \gamma + \log \frac{M_H^2}{4\pi\mu^2}, \\ X_H &= \frac{5}{8} - \frac{3}{4}Y_H, \end{aligned} \quad (7.9)$$

where $\epsilon = 4 - D$, with D the space-time dimension, γ the Euler constant and M_H the mass increasing with M . Notice that in the $\Pi_{WW}^{(1)}(p)$ term, there is no contribution from the (V_L, V_{3R}) exchange, because the coupling WV_LV_{3R} is of order r (see eq. (A.8)) and the loop contribution is $\mathcal{O}(M^2)$.

Let us comment on the Higgs particle exchange in the S_3 loops. Since the first loop contribution is $\mathcal{O}(\log(M))$, only the constant part in r of $\mathcal{L}_{\text{heavy-light}}^h$ given in eq. (A.2) is relevant. As a consequence we have to consider only the ρ_U exchange (see Fig. 1), since the ρ_L and ρ_R exchanges are suppressed by a \sqrt{r} factor in the vertex. There is also a contribution from the $W\rho_R$ exchange (see Fig. 1), because the loop diagram is now behaving as $M^2 \log(M)$, and so the factors \sqrt{r} in the vertices are not enough to suppress this term. However, this is true only for the momentum constant part in the self-energy. Then, it can be seen immediately that there is no correction to the e_1 parameter, due to the custodial symmetry. That is this contribution cancels with the analogous one coming from Π_{ZZ} (see Fig. 2).

Notice that M_{V_L} and $M_{V_{3L}}$ differ of terms of order r , therefore they can be taken to be equal at the order we consider here. Their common value will be called M_{V_L} .

Summing all the contributions and retaining only the leading order in r we get

$$\begin{aligned} \Pi_{WW}(p) &= \frac{g^2}{16\pi^2} \left\{ 7p^2 Y_{V_L} + 3M_W^2 \frac{s_\varphi^2}{c_\varphi^2} X_{V_L} + M_W^2 \frac{s_\varphi^2 s_\theta^4}{c_\theta^2 P} X_{V_{3R}} - \frac{2}{3} p^2 \right. \\ &\quad \left. + \frac{2q^2}{s_\varphi^2} M_W^2 \frac{M_{\rho_R}^2}{M^2} \left(\frac{1}{4} Y_{\rho_R} - \frac{3}{8} \right) \right\}. \end{aligned} \quad (7.10)$$

For the Z self-energy, we have contributions from the graphs S_1 , S_2 and S_3 (Fig. 2):

$$\begin{aligned} \Pi_{ZZ}^{(1)}(p) &= g^2 \left\{ 2r^2 \frac{s_\varphi^2 c_\varphi^2}{c_\theta^2} A_1(p, M_W, M_{V_L}) + (c_\theta^2 + 2r(2c_\varphi^2 - 1)) A_1(p, M_{V_L}, M_{V_L}) \right. \\ &\quad \left. + \frac{s_\theta^4}{c_\theta^2} \left(1 + \frac{2r}{c_\theta^4} P \right) A_1(p, M_{V_R}, M_{V_R}) \right\}, \end{aligned} \quad (7.11)$$

$$\Pi_{ZZ}^{(2)}(p) = g^2 \left\{ (c_\theta^2 + 2r(2c_\varphi^2 - 1)) A_2(M_{V_L}) + \frac{s_\theta^4}{c_\theta^2} \left(1 + \frac{2r}{c_\theta^4} P \right) A_2(M_{V_R}) \right\}, \quad (7.12)$$

$$\begin{aligned}
\Pi_{ZZ}^{(3)}(p) &= g^2 \left\{ \frac{s_\varphi^2}{c_\varphi^2 c_\theta^2} M_W^2 A_3(p, M_{\rho_U}, M_{V_{3L}}) + \frac{s_\varphi^2 s_\theta^4}{c_\theta^4 P} M_W^2 A_3(p, M_{\rho_U}, M_{V_{3R}}) \right. \\
&\quad \left. + 2 \frac{r}{c_\theta^2 s_\varphi^2} q^2 M_Z^2 A_3(p, M_{\rho_R}, M_Z) \right\}. \tag{7.13}
\end{aligned}$$

As far as the Higgs particles exchange is concerned, the same comment we have done for $\Pi_{WW}^{(3)}$ holds.

Summing up all the contributions and using eqs. (7.4)-(7.7), we get

$$\begin{aligned}
\Pi_{ZZ}(p) &= \frac{g^2}{16\pi^2} \left\{ 7p^2 (c_\theta^2 Y_{V_L} + \frac{s_\theta^4}{c_\theta^2} Y_{V_R}) + 3M_Z^2 \frac{s_\varphi^2}{c_\varphi^2} X_{V_L} + M_Z^2 \frac{s_\varphi^2 s_\theta^4}{c_\theta^2 P} X_{V_{3R}} - \frac{2}{3} p^2 c_\theta^2 (1 + \frac{s_\theta^4}{c_\theta^4}) \right. \\
&\quad \left. + 2 \frac{q^2}{c_\theta^2 s_\varphi^2} M_W^2 \frac{M_{\rho_R}^2}{M^2} \left(\frac{1}{4} Y_{\rho_R} - \frac{3}{8} \right) \right\}. \tag{7.14}
\end{aligned}$$

The contributions to the photon self-energy come from the graphs S_1 and S_2 (Fig. 3):

$$\Pi_{\gamma\gamma}^{(1)}(p) = g^2 s_\theta^2 \left\{ A_1(p, M_{V_L}, M_{V_L}) + A_1(p, M_{V_R}, M_{V_R}) \right\}, \tag{7.15}$$

$$\Pi_{\gamma\gamma}^{(2)}(p) = g^2 s_\theta^2 [A_2(M_{V_L}) + A_2(M_{V_R})]. \tag{7.16}$$

By using eqs. (7.4), (7.6), we get

$$\Pi_{\gamma\gamma}(p) = p^2 \frac{g^2}{16\pi^2} s_\theta^2 (7(Y_{V_L} + Y_{V_R}) - \frac{4}{3}). \tag{7.17}$$

To the γZ self-energy contribute the graphs S_1 and S_2 (Fig. 4):

$$\Pi_{\gamma Z}^{(1)}(p) = g^2 \left\{ s_\theta c_\theta (1 - \frac{r}{c_\theta^2} (1 - 2c_\varphi^2)) A_1(p, M_{V_L}, M_{V_L}) - \frac{s_\theta^3}{c_\theta} (1 + \frac{r}{c_\theta^4} P) A_1(p, M_{V_R}, M_{V_R}) \right\}, \tag{7.18}$$

$$\Pi_{\gamma Z}^{(2)}(p) = g^2 \left\{ s_\theta c_\theta (1 - \frac{r}{c_\theta^2} (1 - 2c_\varphi^2)) A_2(M_{V_L}) - \frac{s_\theta^3}{c_\theta} (1 + \frac{r}{c_\theta^4} P) A_2(M_{V_R}) \right\}. \tag{7.19}$$

Again by using eqs. (7.4), (7.6), we get

$$\Pi_{\gamma Z}(p) = p^2 \frac{g^2}{16\pi^2} [7(s_\theta c_\theta Y_{V_L} - \frac{s_\theta^3}{c_\theta} Y_{V_R}) + \frac{2}{3} s_\theta c_\theta (\frac{s_\theta^2}{c_\theta^2} - 1)]. \tag{7.20}$$

From eq. (6.6) and the previous results we obtain (up to corrections $\mathcal{O}(r)$)

$$e_1 = e_2 = e_3 = 0. \tag{7.21}$$

Furthermore e_4 and e_5 are zero at the order here considered, because $F_{\gamma\gamma}$ and F_{ZZ} are independent of p^2 .

8 Expressions for the relevant loops

The loop diagrams which will be relevant for the calculation, besides the gauge boson self-energy loops studied in the previous Section, are listed in Fig. 5. Here we will give the generic expression for these loops in the $M \rightarrow \infty$ limit. We have explicitly verified that, doing this limit in the loop integrand of the amplitudes, no singularity appears in the integration over the Feynman parameters. So we can safely expand the amplitudes in $1/M$.

For the graph (a) the amplitude is given by

$$\begin{aligned}
g_{V_1 V_2 V_3} \epsilon_{abc} \int \frac{d^D k_1}{(2\pi)^D} & \left((2p + k_1)^\nu g^{\mu\rho} + (k_1 - p)^\rho g^{\mu\nu} - (2k_1 + p)^\mu g^{\nu\rho} \right) \\
& (-i) \left(g_{\nu\alpha} - \frac{k_{1\nu} k_{1\alpha}}{M_1^2} \right) (-i) \left(g_{\rho\sigma} - \frac{(p + k_1)_\rho (p + k_1)_\sigma}{M_2^2} \right) \\
& i(v^1 + a^1 \gamma_5) \gamma^\alpha i \frac{\not{k} + \not{k}_1}{(k + k_1)^2} i(v^2 + a^2 \gamma_5) \gamma^\sigma \frac{1}{k_1^2 - M_1^2} \frac{1}{(p + k_1)^2 - M_2^2}, \quad (8.1)
\end{aligned}$$

where p is the momentum of the incoming gauge boson V_3 , k and $p - k$ are the momenta of the outgoing fermions, which we will take massless. In eq. (8.1) $g_{V_1 V_2 V_3}$ is the trilinear gauge coupling which can be directly read from eqs. (A.7-A.9), v^i and a^i ($i = 1, 2$) are the vector and axial vector couplings of the gauge vector bosons V^i to the fermions (see eqs. (4.17-4.18)) and $M_{1(2)}$ is the mass of the gauge boson $V_{1(2)}$.

In the $M_1 \gg M_2$ limit, the term $[(p + k_1)_\rho (p + k_1)_\sigma / M_2^2] (g_{\nu\alpha} - k_{1\nu} k_{1\alpha} / M_1^2)$ gives the leading contribution:

$$g_{V_1 V_2 V_3} \epsilon_{abc} \left\{ \left([v^1 v^2 + a^1 a^2] \gamma_\mu + [v^1 a^2 + a^1 v^2] \gamma_5 \gamma_\mu \right) \frac{1}{M_1^2} A_1(p, M_2, M_1) + \mathcal{O}(\log M_1) \right\}, \quad (8.2)$$

where A_1 is given in eq. (7.5). We have considered just the leading behavior because this loop always contributes to the amplitudes with a suppression factor $\mathcal{O}(r)$ as we will see explicitly in the following.

For large $M_1 = M_2$, eq. (8.1) would give terms $\mathcal{O}(\log M_1)$, but cancellations, due to mass degeneracy, occur and therefore one gets a finite result:

$$g_{V_1 V_2 V_3} \epsilon_{abc} \left\{ \left([v^1 v^2 + a^1 a^2] \gamma_\mu + [v^1 a^2 + a^1 v^2] \gamma_5 \gamma_\mu \right) \frac{3}{2} \frac{1}{16\pi^2} + \mathcal{O}\left(\frac{1}{M_1^2}\right) \right\}. \quad (8.3)$$

For the graph (b), in Fig. 5, the amplitude is given by:

$$\begin{aligned}
\int \frac{d^D k_1}{(2\pi)^D} & i(v^{1'} + a^{1'} \gamma_5) \gamma^\nu i(\not{p} + \not{k}_1) i(v^3 + a^3 \gamma_5) \gamma^\mu i \not{k}_1 i(v^1 + a^1 \gamma_5) \gamma^\rho \\
& (-i) \left(g_{\nu\rho} - \frac{(k + k_1)_\nu (k + k_1)_\rho}{M_1^2} \right) \frac{1}{(k + k_1)^2 - M_1^2} \frac{1}{(p + k_1)^2} \frac{1}{k_1^2}, \quad (8.4)
\end{aligned}$$

where p is the momentum of the incoming gauge boson V_3 , k and $p-k$ are the momenta of the outgoing fermions again considered massless and we have used the *prime* to distinguish between the two vertices of the V_1 gauge boson with the fermions. Here v^3 and a^3 are the couplings of the external gauge boson V_3 to the fermion pair. Since the amplitude is dimensionless, in the large M_1 limit, one expects terms which are at most $\mathcal{O}(\log M_1)$. However the explicit calculation shows again that these divergent terms cancel out leaving a finite contribution:

$$\begin{aligned}
& -\left\{ \left[v^3[v^1 v^{1'} + a^1 a^{1'}] + a^3[v^1 a^{1'} + a^1 v^{1'}] \right] \gamma_\mu \right. \\
& \left. + \left[v^3[v^1 a^{1'} + a^1 v^{1'}] + a^3[v^1 v^{1'} + a^1 a^{1'}] \right] \gamma_5 \gamma_\mu \right\} \frac{3}{2} \frac{i}{16\pi^2} + \mathcal{O}\left(\frac{1}{M_1^2}\right). \quad (8.5)
\end{aligned}$$

For the graph (c), the amplitude is given by:

$$\begin{aligned}
& \int \frac{d^D k_1}{(2\pi)^D} \quad i(v^{1'} + a^{1'} \gamma_5) \gamma^\nu i(\not{p} - \not{k}_1) i(v^1 + a^1 \gamma_5) \gamma^\rho \\
& \quad (-i) \left(g_{\nu\rho} - \frac{k_{1\nu} k_{1\rho}}{M_1^2} \right) \frac{1}{k_1^2 - M_1^2} \frac{1}{(p - k_1)^2}. \quad (8.6)
\end{aligned}$$

In the large M_1 limit, one expects terms which are at most $\mathcal{O}(\log M_1)$. However the explicit calculation shows that these divergent terms cancel out leaving a finite contribution:

$$-\frac{i}{16\pi^2} \not{p} \frac{3}{2} \left\{ (v^1)^2 + (a^1)^2 - 2v^1 a^1 \gamma_5 + \mathcal{O}\left(\frac{1}{M_1^2}\right) \right\}. \quad (8.7)$$

Notice that we have also neglected UV divergent terms of the type $\not{p}(p^2/M_1^2)(2/\epsilon)$. These terms, which arise in theory with massive vector fields in the unitary gauge, are not a problem for the renormalizability since one can show [14] that all the corresponding counterterms vanish by the equations of motion. Or, said in different words, they do not contribute to the S -matrix elements.

For the graph (d) we find:

$$\begin{aligned}
& \int \frac{d^D k}{(2\pi)^D} \quad \left\{ [i(v^2 + a^2 \gamma_5) \gamma^\rho i(\not{p}_1 - \not{k}) i(v^1 + a^1 \gamma_5) \gamma^\mu] \right. \\
& \quad \otimes [i(v^{2'} + a^{2'} \gamma_5) \gamma^\sigma i(-\not{p}_2 + \not{k}) i(v^{1'} + a^{1'} \gamma_5) \gamma^\nu] \\
& \quad \left. (-i) \left(g_{\mu\nu} - \frac{k_\mu k_\nu}{M_1^2} \right) (-i) \left(g_{\rho\sigma} - \frac{(p_1 - k + p'_1)_\rho (p_1 - k + p'_1)_\sigma}{M_2^2} \right) \right\} \\
& \quad \frac{1}{k^2 - M_1^2} \frac{1}{(p_1 - k)^2} \frac{1}{(p_1 - k + p'_1)^2 - M_2^2} \frac{1}{(k - p_2)^2}. \quad (8.8)
\end{aligned}$$

The momenta of the external fermions can be read in Fig. 5-(d) and we have used the *prime* to denote the couplings of the gauge bosons V_1 and V_2 to the fermion pairs on the right-hand-side of the figure.

In the case $M_1 \gg M_2$, the leading contribution comes from terms of the type k^4/M_2^2 and $k^6/(M_2^2 M_1^2)$ in the expression between curl brackets in eq. (8.8). The result is:

$$\begin{aligned}
& i \left\{ (v^1 v^2 + a^1 a^2)(v^{1'} v^{2'} + a^{1'} a^{2'}) \gamma_\mu \otimes \gamma^\mu \right. \\
& + (v^2 a^1 + a^2 v^1)(v^{2'} a^{1'} + a^{2'} v^{1'}) \gamma_5 \gamma_\mu \otimes \gamma_5 \gamma^\mu \\
& + (v^2 v^1 + a^2 a^1)(v^{2'} a^{1'} + a^{2'} v^{1'}) \gamma_\mu \otimes \gamma_5 \gamma^\mu \\
& \left. + (v^2 a^1 + a^2 v^1)(v^{2'} v^{1'} + a^{2'} a^{1'}) \gamma_5 \gamma_\mu \otimes \gamma^\mu \right\} \\
& \times \left[\frac{1}{M_1^4} A_1(p, M_2, M_1) + \mathcal{O}\left(\frac{1}{M_1^2}\right) \right]. \tag{8.9}
\end{aligned}$$

In the calculation of the four fermion amplitude we have to take into account, in addition to the box diagram of Fig. 5-(d), the one with the exchange $V_1 \rightarrow V_2$ and the corresponding crossed diagrams. In the limit $M_1 \gg M_2$ it turns out that the amplitude corresponding to the $V_1 \rightarrow V_2$ exchange is still given by eq. (8.9) while the result for each of crossed boxes give minus the amplitude of eq. (8.9). Finally let us observe that the exchange of two heavy particles in the box diagrams is suppressed by an additional $1/M^2$ factor and therefore it will be neglected.

Notice that, apart from the finite terms, all the relevant amplitudes in the limit are expressed through the same function A_1 , which occurs in the calculation of the vector boson self-energy corrections.

9 One loop corrections to G_F

The one loop corrections to G_F from the μ decay (except the W self-energy [2]) are illustrated in Fig. 6. The black dots stand for the proper vertices, fermion and new vector boson self-energy contributions, as illustrated in Figs. 8-12.

First of all let us consider the box diagrams. The relevant contributions are given in Fig. 7 where for simplicity we have not drawn the crossed diagrams. Due to the fact that for the μ decay process we necessarily have the exchange of a charged gauge boson, whose coupling to fermions satisfy the relation $v = a$, the box diagram contribution of eq. (8.9) can be rewritten as

$$i v^1 v^{1'} (v^2 + a^2)(v^{2'} + a^{2'}) \frac{1}{M_1^4} A_1(p, M_2, M_1) [\gamma_\mu + \gamma_5 \gamma_\mu] \otimes [\gamma^\mu + \gamma_5 \gamma^\mu], \tag{9.1}$$

where v_1 and v'_1 denote the couplings of the charged gauge boson V_1 to the fermion pairs. So the one loop corrections to G_F coming from the box diagrams are of the form of eq. (6.4).

In particular it is easy to show that, due to the couplings of V_{3R} to fermions, the sum of the four amplitudes, corresponding to the direct and the crossed box diagrams, of the (W, V_{3R}) exchange vanishes. The sum of the contributions from the (W, V_{3L}) and (V_L, Z) exchanges (Fig. 7) is (taking into account also the crossed diagrams):

$$-i\delta G_F^{(a)} = -i\frac{g^4 s_\varphi^2}{8 c_\varphi^2 M_{V_3}^4} \left[A_1(p, M_W, M_{V_{3L}}) + c_\theta^2 A_1(p, M_Z, M_{V_L}) \right]. \quad (9.2)$$

We have neglected the box diagrams with (V_L, ρ_U) exchange since the ρ_U couplings to fermions are proportional to their masses.

To compute the Fig. 6-(b) amplitudes we need the W vertex corrections, $\Gamma_{W e\bar{\nu}}^\mu$, given in Fig. 8 and the V_L ones, $\Gamma_{V_L e\bar{\nu}}^\mu$, given in Fig. 9. Because these are corrections to charged gauge boson vertices, the results given in eqs. (8.2), (8.3), (8.5) factor out in terms proportional to $\gamma_\mu + \gamma_5 \gamma_\mu$.

To the $\Gamma_{W e\bar{\nu}}^\mu$ contribute two types of loops L_1 and L_2 . For each graph L_1 in Fig. 8 we have also to consider the one obtained by exchanging the external fermionic lines. In particular in the case of the (W, V_{3R}) exchange the total contribution vanishes due to the V_{3R} fermion couplings. The result coming from the L_1 loops is the following:

$$\Gamma_{W e\bar{\nu}}^{\mu(1)} = -i\frac{g^3}{2\sqrt{2}} \frac{s_\varphi^2}{c_\varphi^2} \left[\frac{r c_\varphi^2}{M_{V_L}^2} (A_1(p, M_Z, M_{V_L}) + A_1(p, M_W, M_{V_{3L}})) - \frac{3}{2} \frac{1}{16\pi^2} \right] (\gamma^\mu + \gamma_5 \gamma^\mu), \quad (9.3)$$

where the last term is due to the (V_L, V_{3L}) exchange (see eq. (8.3)).

The result from the L_2 loop is:

$$\Gamma_{W e\bar{\nu}}^{\mu(2)} = -\frac{i}{16\pi^2} \frac{3}{2} \frac{g^3}{8\sqrt{2}} \frac{s_\varphi^2}{c_\varphi^2} \left[1 - \frac{c_\varphi^2 s_\theta^4}{c_\theta^2 P} \right] (\gamma^\mu + \gamma_5 \gamma^\mu). \quad (9.4)$$

To the $\Gamma_{V_L e\bar{\nu}}^\mu$ contributes only the L_1 loop. This is because in the four fermion amplitude there is an additional factor $1/M^2$ coming from the V_L propagator. As already said, for each graph L_1 in Fig. 9 we have also to consider the one obtained by exchanging the external fermionic lines. The result is the following:

$$\Gamma_{V_L e\bar{\nu}}^\mu = -i\frac{g^3}{2\sqrt{2}} \frac{s_\varphi}{c_\varphi} \frac{1}{M_{V_L}^2} \left[c_\theta^2 A_1(p, M_Z, M_{V_L}) + A_1(p, M_W, M_{V_{3L}}) \right] (\gamma^\mu + \gamma_5 \gamma^\mu). \quad (9.5)$$

Let us now evaluate the contribution of the fermion self-energies to $\Gamma_{V_3 ff'}^\mu$ where V_3 is a generic vector boson (Fig. 10). Of course the self-energy insertion on the external

fermionic legs must be taken with a factor 1/2. The explicit expression for each of the graphs of Fig. 10, in the $M_1 \rightarrow \infty$ limit, is, by using eq. (8.7)

$$\Gamma_{V_3 f f'}^{\mu(s.e.)} = \frac{3i}{32\pi^2} \frac{1}{2} \left\{ [v^3((v^1)^2 + (a^1)^2) + 2a^3 v^1 a^1] \gamma^\mu + [a^3((v^1)^2 + (a^1)^2) + 2v^3 v^1 a^1] \gamma_5 \gamma^\mu \right\}. \quad (9.6)$$

Again, when we consider a charged boson vertex correction the result factors out in a term proportional to $\gamma^\mu + \gamma_5 \gamma^\mu$. Using the general expression (9.6) we can evaluate the contribution to $\Gamma_{W e \bar{\nu}}^\mu$ due to the self-energy corrections coming from the exchange of V_L , V_{3L} and V_{3R} :

$$\Gamma_{W e \bar{\nu}}^{\mu(s.e.)} = -\frac{i}{16\pi^2} \frac{3}{2} \frac{g^3}{8\sqrt{2}} \frac{s_\varphi^2}{c_\varphi^2} \left[3 + \frac{c_\varphi^2 s_\theta^4}{c_\theta^2 P} \right] (\gamma^\mu + \gamma_5 \gamma^\mu). \quad (9.7)$$

The sum of the contributions coming from the graphs in Fig. 6-(b,c) is again of the form given in eq. (6.4) with

$$-i\delta G_F^{(b,c)} = -i \frac{g^4}{4} \frac{s_\varphi^2}{c_\varphi^2} \frac{1}{M_{V_L}^4} A_1(p, M_Z, M_{V_L}) s_\theta^2. \quad (9.8)$$

The contribution to the four fermion amplitudes due to the WV_L self-energy (Fig. 6-(d)) comes from the loops in Fig. 11. In the case of loops with two heavy gauge bosons, as we have already found in the calculation of the vector boson self energies, there is a cancellation of the most divergent terms with the corresponding tadpole contributions. As a result, the sum of the loops S_1 and S_2 with two heavy gauge bosons is $\mathcal{O}(\log M)$ and so it is suppressed in the four fermion amplitude due to the factor $1/M^2$ coming from the V_L propagator. For the same reason we have not drawn loops with only a logarithmic divergence, like for example the one with the (V_L, ρ_U) exchange.

The only graphs giving a finite contribution in the $M \rightarrow \infty$ limit are the S_1 ones with the (W, V_{3L}) and (V_{3L}, Z) exchanges (Fig. 11). The result is again in the form of eq. (6.4) with

$$-i\delta G_F^{(d)} = i \frac{g^4}{4} \frac{s_\varphi^2}{c_\varphi^2} \frac{1}{M_{V_L}^4} \left[A_1(p, M_W, M_{V_{3L}}) + A_1(p, M_Z, M_{V_L}) \right]. \quad (9.9)$$

Finally, let us consider the contribution from the V_L vacuum polarization diagrams (Fig. 6-(e)) given in Fig. 12 where we have considered only loops which diverge at least as M^4 . The corresponding correction to G_F is

$$-i\delta G_F^{(e)} = -i \frac{g^4}{8} \frac{s_\varphi^2}{c_\varphi^2} \frac{1}{M_{V_L}^4} \left[A_1(p, M_W, M_{V_{3L}}) + c_\theta^2 A_1(p, M_Z, M_{V_L}) \right]. \quad (9.10)$$

Notice that contribution to the V_L self-energy coming from the loop with one V_L and one heavy Higgs boson, $\rho_{L,R}$, is vanishing in the limit, although the corresponding trilinear couplings are increasing with \sqrt{r} . In fact, the loop is only logarithmic in M . The sum of the $\delta G_F^{(a,b,c,d,e)}$ contributions vanishes.

10 One loop corrections to the Ze^+e^- vertex

To evaluate the extra contributions to the vector and axial-vector form factors δg_V and δg_A at the Z pole we need, besides the one loop vertex corrections, the fermion self-energies and the "heavy-light" vector boson self-energies in which the light boson is a Z (Fig. 13).

The one loop contribution to $\Gamma_{Ze^+e^-}^\mu$ given in Fig. 13-(a) is the sum of the graphs L_1 and L_2 (Fig. 14). In particular from the graph L_1 we get:

$$\Gamma_{Ze^+e^-}^{\mu(1)} = \left[i \frac{g^3 s_\varphi^2}{2 c_\theta} r \frac{1}{M_{V_L}^2} A_1(p, M_W, M_{V_L}) + \frac{g^3}{4} c_\theta \frac{s_\varphi^2}{c_\varphi^2} \left(-\frac{3}{2} \frac{i}{16\pi^2} \right) \right] (\gamma^\mu + \gamma_5 \gamma^\mu). \quad (10.1)$$

The first term comes from two equal contributions from the (V_L^+, W^-) and (V_L^-, W^+) exchanges, the second one from the (V_L, V_L) exchange.

To the graph L_2 we have three contributions from the V_{3L} , V_L and V_{3R} exchanges:

$$\begin{aligned} \Gamma_{Ze^+e^-}^{\mu(2)} = & \left\{ \left[\frac{g^3 s_\varphi^2}{16 c_\varphi^2 c_\theta} (1 - 2s_\theta^2) \right] + \left[-\frac{g^3 s_\varphi^2}{8 c_\varphi^2 c_\theta} \right] \right\} (\gamma^\mu + \gamma_5 \gamma^\mu) \\ & + \frac{g^3 s_\varphi^2 s_\theta^4}{16 c_\theta^3 P} \left[(1 - 10s_\theta^2) \gamma_\mu + (1 + 6s_\theta^2) \gamma_5 \gamma^\mu \right] \left(-\frac{3}{2} \frac{i}{16\pi^2} \right). \end{aligned} \quad (10.2)$$

The amplitude corresponding to Fig. 13-(b) get contributions from the graphs S_1 and S_2 in Fig. 15. In the case of loops with two heavy gauge bosons, as we already said, there is a cancellation of the most divergent terms with the corresponding tadpole contributions. As a result, the sum of S_1 and S_2 in this case is $\mathcal{O}(1/M^2)$ due to the heavy gauge boson propagator. So the only non vanishing term in the amplitude of Fig. 13-(b), comes from two equal contributions from the (V_L^+, W^-) and (V_L^-, W^+) exchanges in the loop. The result is:

$$\Gamma_{Ze^+e^-}^{\mu(b)} = -i \frac{g^3 s_\varphi^2}{2 c_\theta} r \frac{1}{M_{V_L}^2} A_1(p, M_W, M_{V_L}) (\gamma^\mu + \gamma_5 \gamma^\mu). \quad (10.3)$$

Concerning the contribution from Fig. 13-(c) the relevant ZV_{3R} self-energy diagrams are given in Fig. 16. Since we have the same cancellation of the most divergent terms between the graphs S_1 and S_2 the result is $\mathcal{O}(1/M^2)$ due to the heavy gauge boson V_{3R} propagator.

Finally, the corrections to the Ze^+e^- vertex due to the fermionic self-energy contributions (Fig. 13-(d)) come from the exchange of V_{3L} , V_L and V_{3R} . As already observed

for the δG_F calculation, these terms must be considered with a factor 1/2, and using eq. (9.6) we get

$$\Gamma_{Ze^+e^-}^{\mu(d)} = \left\{ \left[\frac{g^3}{16} \frac{s_\varphi^2}{c_\varphi^2 c_\theta} 3(1 - 2s_\theta^2) \right] (\gamma^\mu + \gamma_5 \gamma^\mu) + \left[\frac{g^3}{16} \frac{s_\varphi^2 s_\theta^4}{c_\theta^3 P} (1 - 10s_\theta^2) \gamma_\mu + (1 + 6s_\theta^2) \gamma_5 \gamma^\mu \right] \right\} \left(\frac{3}{2} \frac{i}{16\pi^2} \right). \quad (10.4)$$

The sum of all the one loop corrections to the Ze^+e^- vertex vanishes at the leading order in the $M \rightarrow \infty$ limit. Therefore, from the definition given in eq. (6.3) we get

$$\delta g_V = \delta g_A = 0. \quad (10.5)$$

We have also checked that in this limit we have no extra corrections at the leading order to the vertices $\Gamma_{Zf_1 f_2}^\mu$, and $\Gamma_{Wf_1 f_2}^\mu$.

11 Conclusions

We have developed an extension of the SM based on the gauge group $SU(2)_L \otimes U(1) \otimes SU(2)'_L \otimes SU(2)'_R$ with two different energy scales: the electroweak one, v , and a higher scale u . The model is a linear realization of a dynamical breaking of the electroweak symmetry previously proposed, containing two new triplets of spin one particles V_L and V_R (degenerate BESS). The interest in this model was due to its decoupling property: in the limit of infinite mass of the heavy vector bosons ($u \rightarrow \infty$), one recovers the Higgsless SM. In the linear version one has also scalar states in the spectrum, and in this case, in the limit of large u , one gets back to the SM.

To show the decoupling we have considered the observables relevant to LEPI physics. In particular we have computed the tree value of the ϵ parameters, which turns out to be $\mathcal{O}(v^2/u^2)$. Being the Lagrangian of the model renormalizable, we have also shown that the decoupling property holds also at the level of radiative corrections.

We have performed the calculation of the contributions to the ϵ parameters due to the new physics at one loop by evaluating the self-energy corrections to W , Z , γ propagators, the vertex corrections to Ze^+e^- and to the Fermi coupling constant. Dimensional regularization and unitary gauge have been used. The result is a cancellation of all divergent and finite contributions in the $u \rightarrow \infty$ limit. The corrections to the ϵ observables at the order v^2/u^2 turn out to be, in general, numerically smaller than the tree level ones (taken at the same order), due to the factor $1/16\pi^2$ coming from the loops.

Even if we are not proving in general the complete decoupling of the high-energy sector, we have shown that at the LEPI energy the model is undistinguishable from the SM, whereas the signatures at high energy can be very different [8].

Appendix

From eq. (4.1), using the new couplings defined in eq. (3.13), and expressing the vector and Higgs fields in terms of the corresponding mass eigenstates, we derive the Higgs-vector interactions at the leading order in r .

Let us observe that, since there are trilinear couplings of the order $1/\sqrt{r}$ (see eq. (4.1)), and we have evaluated the mass diagonalization matrices up to $\mathcal{O}(r)$, the result for \mathcal{L}^h is correct up to $\mathcal{O}(\sqrt{r})$. For the light sector we obtain an expression which coincides with the analogous one in the SM (remember that now $W, V_L, V_R, Z, V_{3L}, V_{3R}$ as well as ρ_U, ρ_L, ρ_R denote the mass eigenstates)

$$\mathcal{L}_{\text{light}}^h = \frac{g^2}{4}(\rho_U^2 + 2\rho_U v)(W^+W^- + \frac{1}{2c_\theta^2}Z^2). \quad (\text{A.1})$$

For the heavy-light sector we get

$$\begin{aligned} \mathcal{L}_{\text{heavy-light}}^h &= \frac{g^2}{4} \left\{ (\rho_U^2 + 2\rho_U v + \frac{2}{s_\varphi} \sqrt{2r} q \rho_U \rho_R) [-\tan \varphi (W^+V_L^- + W^-V_L^+ + \frac{1}{c_\theta} ZV_{3L}) \right. \\ &+ \frac{s_\varphi \tan^2 \theta}{\sqrt{P}} ZV_{3R} + \tan^2 \varphi (V_L^+V_L^- + \frac{1}{2}V_{3L}^2) \\ &+ \frac{1}{2} \frac{s_\varphi^2 s_\theta^4}{c_\theta^2 P} V_{3R}^2 - \frac{s_\varphi^2 s_\theta^2}{c_\varphi c_\theta \sqrt{P}} V_{3L} V_{3R}] \\ &+ \frac{2}{s_\varphi} q v \sqrt{2r} \rho_R [-\tan \varphi (W^+V_L^- + W^-V_L^+ + \frac{1}{c_\theta} ZV_{3L}) + \frac{s_\varphi \tan^2 \theta}{\sqrt{P}} ZV_{3R}] \\ &+ \frac{2}{s_\varphi} \sqrt{2r} q \rho_R (\rho_U + v) (W^+W^- + \frac{1}{2c_\theta^2} Z^2) \\ &+ v \sqrt{2r} [\frac{1}{c_\varphi} (W^+V_L^- + W^-V_L^+ + \frac{1}{c_\theta} ZV_{3L}) (\rho_L + \rho_R) \\ &- \frac{s_\theta^2}{c_\theta^2 \sqrt{P}} ZV_{3R} (\rho_R - \rho_L)] \\ &- \frac{1}{c_\varphi^2 s_\varphi^2} \rho_U q (\frac{\sqrt{2r}}{s_\varphi} (\rho_L + \rho_R) + 2v) (V_L^+V_L^- + \frac{1}{2}V_{3L}^2) \\ &+ \left. \frac{1}{s_\varphi^2} \rho_U q (\frac{\sqrt{2r}}{s_\varphi} (\rho_L - \rho_R) - 2v) (V_R^+V_R^- + \frac{1}{2} \frac{c_\theta^2}{P} V_{3R}^2) \right\}, \quad (\text{A.2}) \end{aligned}$$

and for the heavy sector we get

$$\mathcal{L}_{\text{heavy}}^h = \frac{g^2}{4} \left\{ \frac{1}{c_\varphi^2 s_\varphi^2} [\frac{1}{2} (\rho_L + \rho_R)^2 + \sqrt{2} \frac{s_\varphi}{\sqrt{r}} v (\rho_L + \rho_R) - \frac{\sqrt{2r}}{s_\varphi} v q^2 \rho_R] (V_L^+V_L^- + \frac{1}{2}V_{3L}^2) \right.$$

$$\begin{aligned}
& + \frac{1}{s_\varphi^2} \left[\frac{1}{2} (\rho_L - \rho_R)^2 - \sqrt{2} \frac{s_\varphi}{\sqrt{r}} v (\rho_L - \rho_R) - \frac{\sqrt{2r}}{s_\varphi} v q^2 \rho_R \right] (V_R^+ V_R^- + \frac{1}{2} \frac{c_\theta^2}{P} V_{3R}^2) \\
& + 2\rho_R \sqrt{2r} v \frac{q}{s_\varphi} \left[\tan^2 \varphi (V_L^+ V_L^- + \frac{1}{2} V_{3L}^2) + \frac{1}{2} \frac{s_\varphi^2 s_\theta^4}{c_\theta^2 P} V_{3R}^2 - \frac{s_\varphi^2 s_\theta^2}{c_\varphi c_\theta \sqrt{P}} V_{3L} V_{3R} \right] \\
& - \frac{v \sqrt{2r} s_\theta^2}{s_\varphi (1 - 2c_\theta^2)} \left(\frac{\sqrt{P}}{c_\varphi c_\theta} (\rho_L + \rho_R) + \frac{c_\varphi c_\theta}{\sqrt{P}} (\rho_R - \rho_L) \right) V_{3L} V_{3R} \}. \tag{A.3}
\end{aligned}$$

Concerning the Higgs self interactions, we can obtain the scalar potential in terms of the Higgs field eigenstates by simply rewriting eq. (3.15) in terms of the transformed fields.

Finally, let us derive the vector boson self-couplings. Notice that, since in \mathcal{L}^{kin} given in eq. (2.10) the couplings are $\mathcal{O}(1)$ and we have evaluated the mass diagonalization matrices up to $\mathcal{O}(r)$, the result for \mathcal{L}^{kin} is correct up to $\mathcal{O}(r)$.

Let us define the following formal combination

$$AB^-C^+ = A^{\mu\nu} B_\mu^- C_\nu^+ + A^\nu (B_{\mu\nu}^- C^{\mu+} - B_{\mu\nu}^+ C^{\mu-}), \tag{A.4}$$

where

$$A^{\mu\nu} = \partial^\mu A^\nu - \partial^\nu A^\mu, \tag{A.5}$$

and similar expression for $B_{\mu\nu}^\pm$. Then the trilinear gauge boson couplings in terms of the original fields are given by

$$\mathcal{L}^{tril} = i[g_0 W_3 W^- W^+ + g_2 V_{3L} V_L^- V_L^+ + g_2 V_{3R} V_R^- V_R^+]. \tag{A.6}$$

Using the redefinition of the couplings and the expressions for the mass eigenstates, we find, again at the first order in r , for the light sector

$$\mathcal{L}_{light}^{tril} = ig[s_\theta \gamma W^- W^+ + c_\theta Z W^- W^+], \tag{A.7}$$

for the heavy-light sector

$$\begin{aligned}
\mathcal{L}_{heavy-light}^{tril} & = ig[s_\theta \gamma (V_L^- V_L^+ + V_R^- V_R^+) + (c_\theta + r \frac{1}{c_\theta} (2c_\varphi^2 - 1)) Z V_L^- V_L^+ \\
& + c_\varphi s_\varphi \frac{r}{c_\theta} (Z W^- V_L^+ + Z V_L^- W^+) - \frac{s_\theta^2}{c_\theta} (1 + r \frac{1}{c_\theta^4} P) Z V_R^- V_R^+ \\
& + (1 - r(1 - 2c_\varphi^2)) (V_{3L} W^- V_L^+ + V_{3L} V_L^- W^+) + r c_\varphi s_\varphi V_{3L} W^- W^+ \\
& - r \frac{c_\varphi s_\theta^2 \sqrt{P}}{c_\theta (1 - 2c_\theta^2)} (V_{3R} W^- V_L^+ + V_{3R} V_L^- W^+) \\
& + r \frac{s_\varphi s_\theta^2 \sqrt{P}}{c_\theta^3} V_{3R} W^- W^+], \tag{A.8}
\end{aligned}$$

and for the heavy sector

$$\begin{aligned}
\mathcal{L}_{\text{heavy}}^{\text{tril}} &= ig\left[\left(\frac{2c_\varphi^2 - 1}{c_\varphi s_\varphi} - 3c_\varphi s_\varphi r\right)V_{3L}V_L^-V_L^+ + \frac{c_\varphi^3 s_\theta^2}{s_\varphi(1 - 2c_\theta^2)}rV_{3L}V_R^-V_R^+ \right. \\
&\quad \left. + \frac{s_\theta^2(s_\varphi^2 - c_\theta^2)\sqrt{P}}{s_\varphi c_\theta^3(1 - 2c_\theta^2)}rV_{3R}V_L^-V_L^+ + \frac{\sqrt{P}}{s_\varphi c_\theta}(1 - r\frac{s_\varphi^2 s_\theta^4}{c_\theta^4})V_{3R}V_R^-V_R^+\right]. \tag{A.9}
\end{aligned}$$

The quadrilinear couplings are obtained starting from

$$\begin{aligned}
\mathcal{L}^{\text{quad}} &= -\frac{g_0^2}{2}S_{\mu\nu\rho\sigma} [W_\mu^+W_\nu^-(W_\rho^+W_\sigma^- + W_{3\rho}W_{3\sigma}) \\
&\quad + \frac{1}{\tan^2\varphi}V_{L\mu}^+V_{L\nu}^-(V_{L\rho}^+V_{L\sigma}^- + V_{3L\rho}V_{3L\sigma}) \\
&\quad + \frac{1}{\tan^2\varphi}V_{R\mu}^+V_{R\nu}^-(V_{R\rho}^+V_{R\sigma}^- + V_{3R\rho}V_{3R\sigma})], \tag{A.10}
\end{aligned}$$

with $S_{\mu\nu\rho\sigma} = 2g_{\mu\nu}g_{\rho\sigma} - g_{\mu\rho}g_{\nu\sigma} - g_{\mu\sigma}g_{\nu\rho}$.

At the lowest order in r one gets for the light part

$$\begin{aligned}
\mathcal{L}_{\text{light}}^{\text{quad}} &= -\frac{g^2}{2}S^{\mu\nu\rho\sigma} [W_\mu^+W_\nu^-(W_\rho^+W_\sigma^- + c_\theta^2 Z_\rho Z_\sigma \\
&\quad + 2c_\theta s_\theta \gamma_\rho Z_\sigma + s_\theta^2 \gamma_\rho \gamma_\sigma)], \tag{A.11}
\end{aligned}$$

for the heavy-light part

$$\begin{aligned}
\mathcal{L}_{\text{heavy-light}}^{\text{quad}} &= -\frac{g^2}{2}S^{\mu\nu\rho\sigma} \{ (1 - 2r(1 - 2c_\varphi^2))W_\mu^+W_\nu^-(V_{3L\rho}V_{3L\sigma} + V_{L\rho}^+V_{L\sigma}^-) \\
&\quad + (W_\mu^+V_{L\nu}^- + V_{L\mu}^+W_\nu^-)[(1 - 2r(1 - 2c_\varphi^2))(V_{L\rho}^+W_\sigma^- + W_\rho^+V_{L\sigma}^-) \\
&\quad + (\frac{2c_\varphi^2 - 1}{c_\varphi s_\varphi} + r\frac{1 - 6c_\varphi^2 + 6c_\varphi^4}{c_\varphi s_\varphi})(V_{L\rho}^+V_{L\sigma}^- + V_{3L\rho}V_{3L\sigma})] \\
&\quad + V_{L\mu}^+V_{L\nu}^-[(1 - 2r(1 - 2c_\varphi^2))W_\rho^+W_\sigma^- + (c_\theta^2 - 2r(1 - 2c_\varphi^2))Z_\rho Z_\sigma \\
&\quad + 2(c_\theta s_\theta - r\frac{s_\theta}{c_\theta}(1 - 2c_\varphi^2))\gamma_\rho Z_\sigma + s_\theta^2 \gamma_\rho \gamma_\sigma \\
&\quad + (\frac{2c_\varphi^2 - 1}{c_\varphi s_\varphi} + r\frac{1 - 6c_\varphi^2 + 6c_\varphi^4}{c_\varphi s_\varphi})(V_{L\rho}^+W_\sigma^- + W_\rho^+V_{L\sigma}^-) \\
&\quad + 2(\frac{2c_\varphi^2 - 1}{c_\varphi s_\varphi}c_\theta + r\frac{1 - 3c_\varphi^2 s_\varphi^2(1 + c_\theta^2)}{c_\varphi s_\varphi s_\theta})V_{3L\rho}Z_\sigma \\
&\quad + 2(\frac{2c_\varphi^2 - 1}{c_\varphi s_\varphi}s_\theta - 3rc_\varphi s_\varphi s_\theta)V_{3L\rho}\gamma_\sigma]
\end{aligned}$$

$$\begin{aligned}
& +V_{R\mu}^+ V_{R\nu}^- \left[\left(\frac{s_\theta^4}{c_\theta^2} + 2r \frac{s_\theta^4}{c_\theta^6} P \right) Z_\rho Z_\sigma - 2 \left(\frac{s_\theta^3}{c_\theta} + r \frac{s_\theta^3}{c_\theta^5} P \right) \gamma_\rho Z_\sigma \right. \\
& + s_\theta^2 \gamma_\rho \gamma_\sigma - 2 \frac{s_\theta^2 \sqrt{P}}{s_\varphi c_\theta^2} \left(1 + r \frac{-2s_\varphi^2 s_\theta^2 + c_\theta^2 (1 + s_\varphi^2 s_\theta^2)}{c_\theta^4} \right) V_{3R\rho} Z_\sigma \\
& \left. + 2 \frac{s_\theta \sqrt{P}}{c_\theta s_\varphi} \left(1 - r \frac{s_\varphi^2 s_\theta^4}{c_\theta^4} \right) V_{3R\rho} \gamma_\sigma \right], \tag{A.12}
\end{aligned}$$

and for the heavy part

$$\begin{aligned}
\mathcal{L}_{\text{heavy}}^{\text{quad}} = & -\frac{g^2}{2} S^{\mu\nu\rho\sigma} \left\{ \left(\frac{1 - 3c_\varphi^2 + 3c_\varphi^4}{c_\varphi^2 s_\varphi^2} + 4r(1 - 2c_\varphi^2) \right) \right. \\
& V_{L\mu}^+ V_{L\nu}^- (V_{3L\rho} V_{3L\sigma} + V_{L\rho}^+ V_{L\sigma}^-) \\
& + V_{R\mu}^+ V_{R\nu}^- \left[\frac{P}{s_\varphi^2 c_\theta^2} \left(1 - 2r \frac{s_\varphi^2 s_\theta^4}{c_\theta^4} \right) V_{3R\rho} V_{3R\sigma} \right. \\
& \left. \left. + \frac{1}{s_\varphi^2} V_{R\rho}^+ V_{R\sigma}^- \right] \right\}. \tag{A.13}
\end{aligned}$$

Both the trilinear and quadrilinear light parts of the Lagrangian agree with the SM results, and the heavy-light sectors do not show any coupling increasing with the heavy mass M .

Acknowledgements

This work has been carried out within the Program Human Capital and Mobility: ‘‘Tests of electroweak symmetry breaking and future European colliders’’, CHRXCT94/0579.

References

- [1] H.P.Nilles, Phys. Rep. **C110** (1984) 1; H.E.Haber and G.L.Kane, Phys. Rep. **C117** (1985) 75; R.Barbieri, Riv. Nuovo Cim. **11** (1988) 1.
- [2] R.Barbieri, F.Caravaglios and M.Frigeni, Phys. Lett. **B279** (1992) 169.
- [3] H.E.Haber, SCIPP-94-39, Dec 1994. Presented at the Workshop on Electro-Weak Symmetry Breaking, Budapest, Hungary, Jul 11-15, 1994 and the Joint U.S.-Polish Workshop on Physics from Planck Scale to Electro-Weak Scale (SUSY 94), Warsaw, Poland, 21-24 Sep 1994. Published in Budapest Electroweak (1994), 1(QCD161:B81:1994).

- [4] R.Casalbuoni, A.Deandrea, S.De Curtis, D.Dominici, F.Feruglio, R.Gatto and M.Grazzini, Phys. Letters **B349** (1995) 533; R.Casalbuoni, D.Dominici, A.Deandrea, R.Gatto, S.De Curtis and M.Grazzini, Phys. Rev. **D53** (1996) 5201.
- [5] R.Casalbuoni, D.Dominici, S.De Curtis and M.Grazzini, Phys. Lett. **B388** (1996) 112.
- [6] S.Weinberg, Phys. Rev. **D13** (1976) 974; *ibidem* **D19** (1979) 1277; L.Susskind, *ibidem* **D20** (1979) 2619.
- [7] R.S.Chivukula, E.H.Simmons and J.Terning, Phys. Rev. **D53** (1996) 5258.
- [8] R.Casalbuoni, D.Dominici, P.Chiappetta, A.Deandrea, S.De Curtis and R.Gatto, CPT-97/P.3456, hep-ph 9702325.
- [9] G.Altarelli and R.Barbieri, Phys. Lett. **B253** (1991) 161; G.Altarelli, R.Barbieri and S.Jadach, Nucl. Phys. **B369** (1992) 3; G.Altarelli, R.Barbieri and F.Caravaglios, Nucl. Phys. **B405** (1993) 3.
- [10] M.E.Peskin and T.Takeuchi, Phys. Rev. Lett. **65** (1990) 964 and Phys. Rev. **D46** (1991) 381.
- [11] T.Appelquist and J.Carazzone, Phys. Rev. **D11** (1975) 2856.
- [12] R.Casalbuoni, S.De Curtis, D.Dominici, F.Feruglio and R.Gatto, Phys. Lett. **B258** (1991) 161.
- [13] R.Casalbuoni, S.De Curtis and M.Grazzini, Phys. Lett. **B317** (1993) 151.
- [14] J.Collins, *Renormalization*, Cambridge (1984).

Figure Captions

- Fig. 1** - Graphs contributing to the W self-energy, Π_{WW} .
- Fig. 2** - Graphs contributing to the Z self-energy, Π_{ZZ} .
- Fig. 3** - Graphs contributing to the γ self-energy, $\Pi_{\gamma\gamma}$.
- Fig. 4** - Graphs contributing to the γZ self-energy, $\Pi_{\gamma Z}$.
- Fig. 5** - The generic loop diagrams for the evaluation of the ϵ parameters (except for the vector boson self-energies).
- Fig. 6** - One loop diagrams for the μ -decay, necessary to evaluate the corrections to G_F .
- Fig. 7** - The box diagrams relevant to the corrections to G_F .
- Fig. 8** - The vertices $\Gamma_{We\bar{\nu}}^\mu$ relevant to the corrections to G_F .
- Fig. 9** - The vertices $\Gamma_{VLe\bar{\nu}}^\mu$ relevant to the corrections to G_F .
- Fig. 10** - The fermion self-energy contributions to the generic vertex $\Gamma_{V_3ff'}^{\mu(s.e.)}$ relevant to the corrections to G_F .
- Fig. 11** - Graphs contributing to the WV_L self-energy, Π_{WV_L} .
- Fig. 12** - Graphs contributing to the V_L self-energy, $\Pi_{V_LV_L}$.
- Fig. 13** - One loop diagrams relevant to the corrections to δg_V , δg_A .
- Fig. 14** - The vertices $\Gamma_{Ze^+e^-}^\mu$ relevant to the corrections to δg_V , δg_A .
- Fig. 15** - Graphs contributing to the ZV_{3L} self-energy, $\Pi_{ZV_{3L}}$.
- Fig. 16** - Graphs contributing to the ZV_{3R} self-energy, $\Pi_{ZV_{3R}}$.

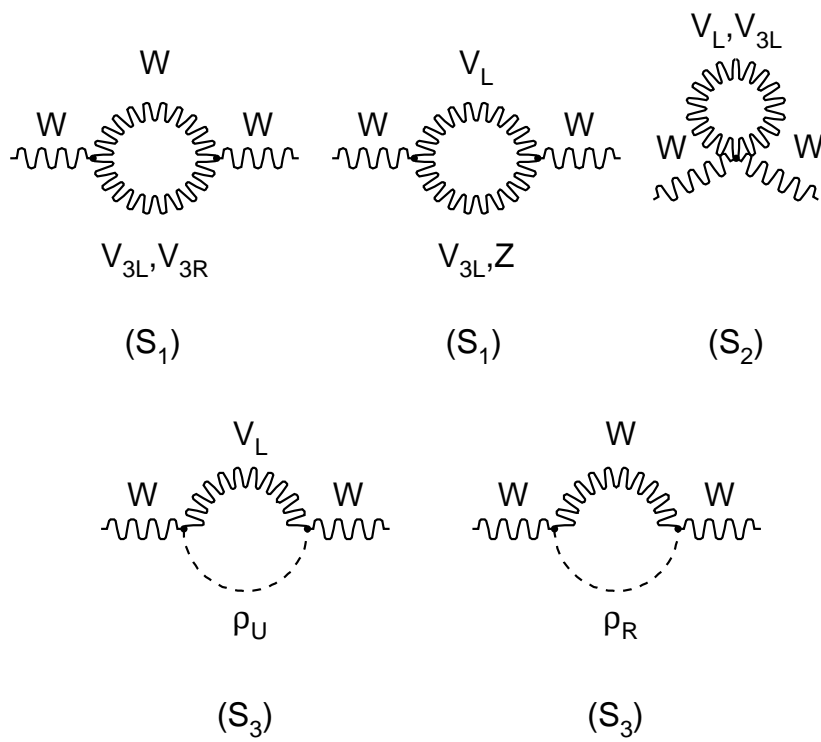

Fig. 1

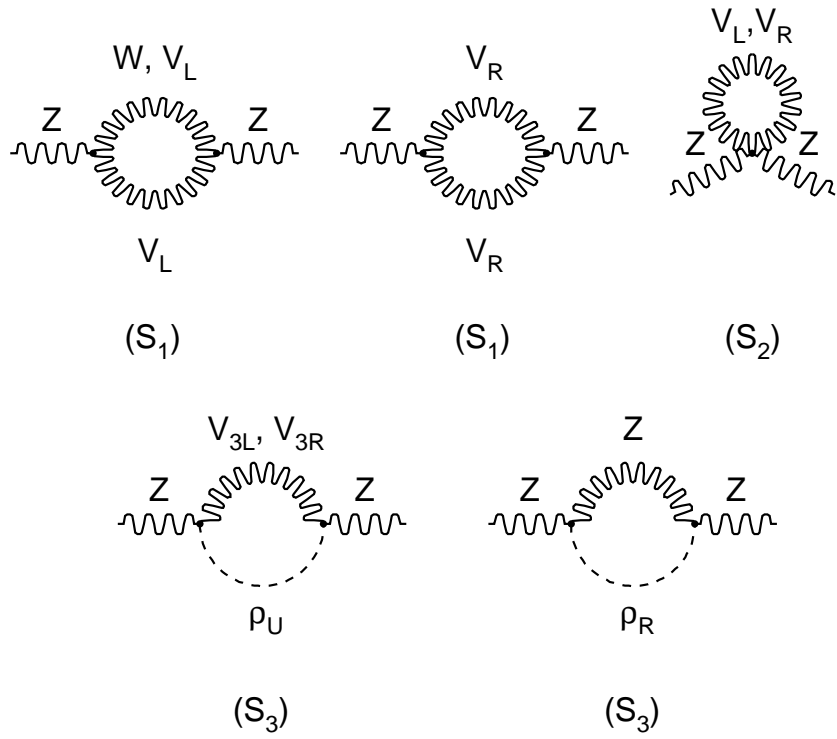

Fig. 2

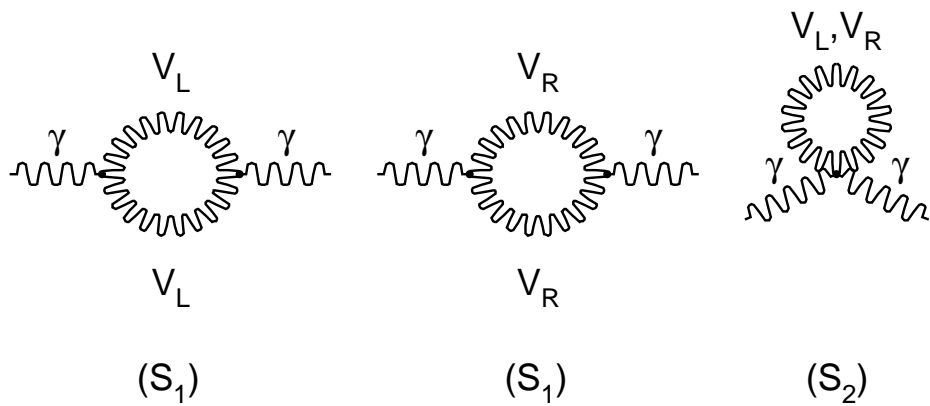

Fig. 3

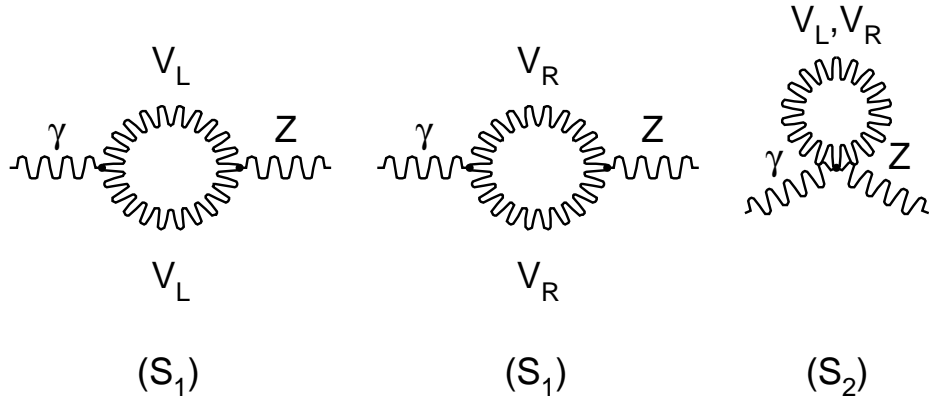

Fig. 4

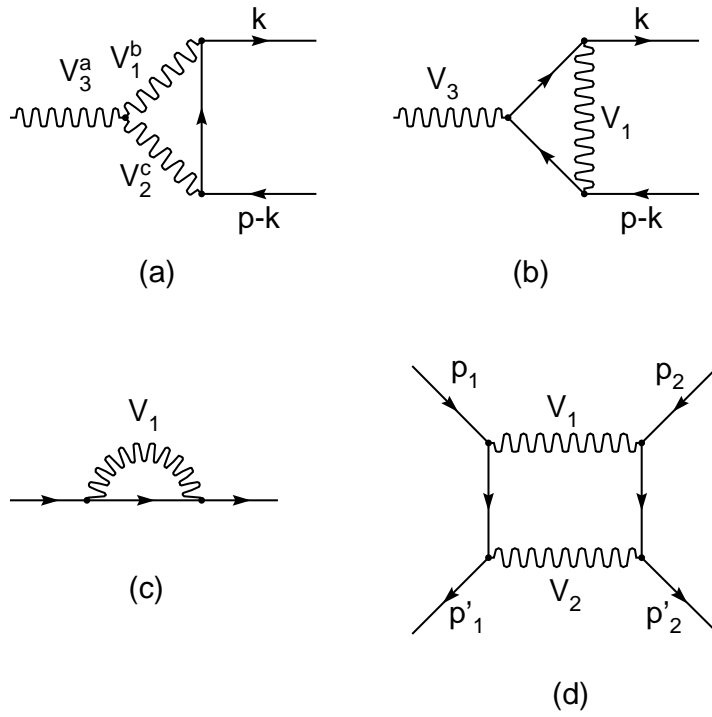

Fig. 5

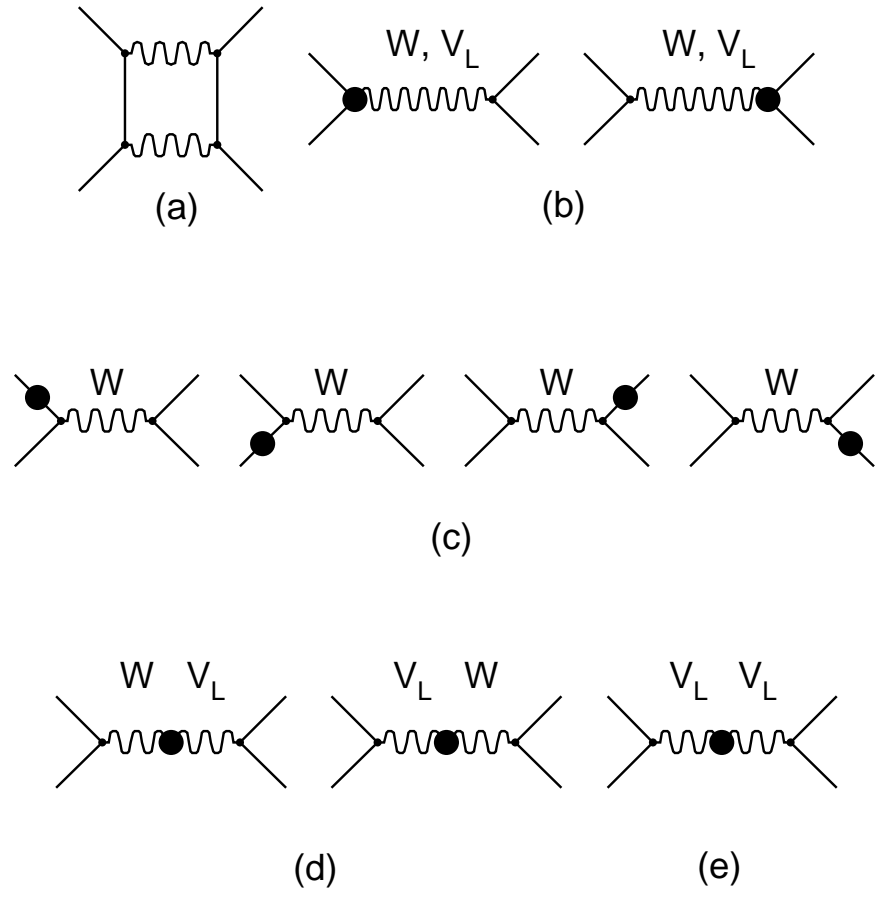

Fig. 6

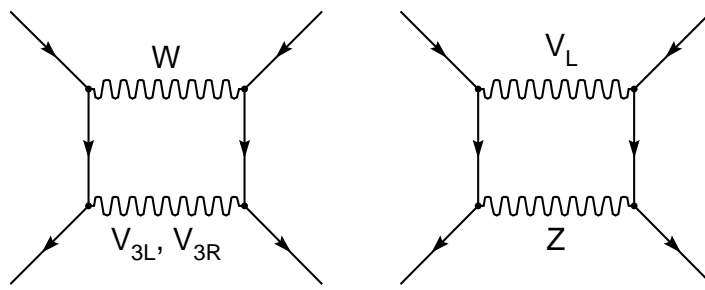

Fig. 7

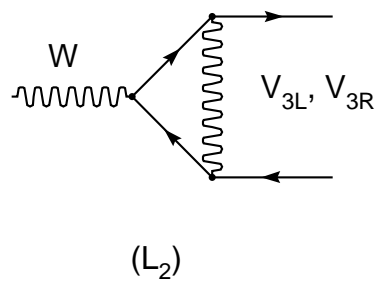
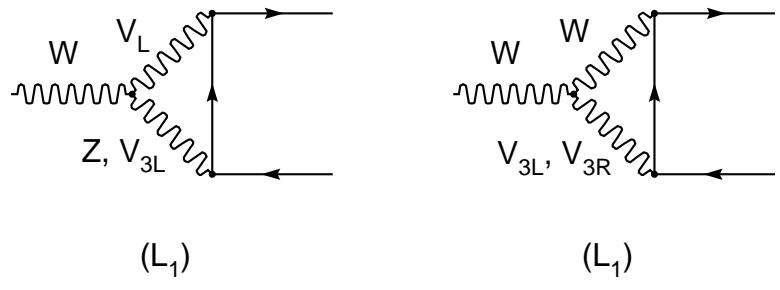

Fig. 8

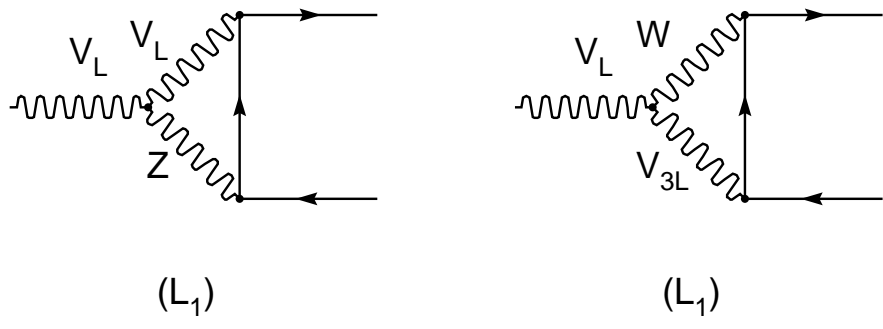

Fig. 9

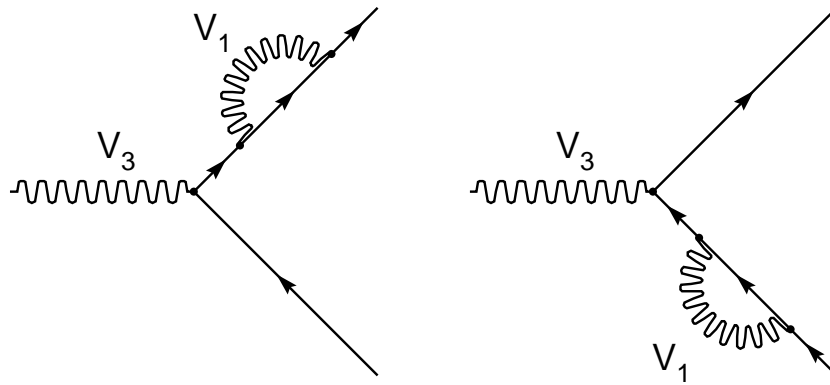

Fig. 10

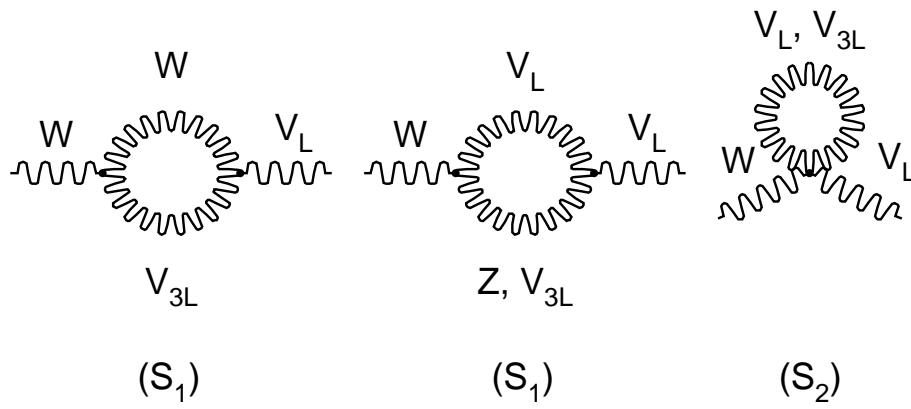

Fig. 11

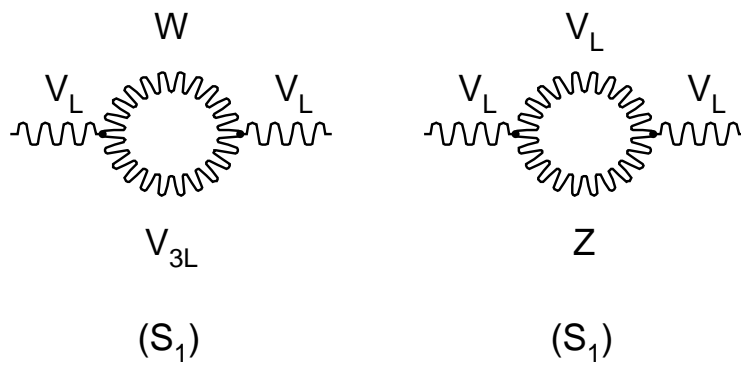

Fig. 12

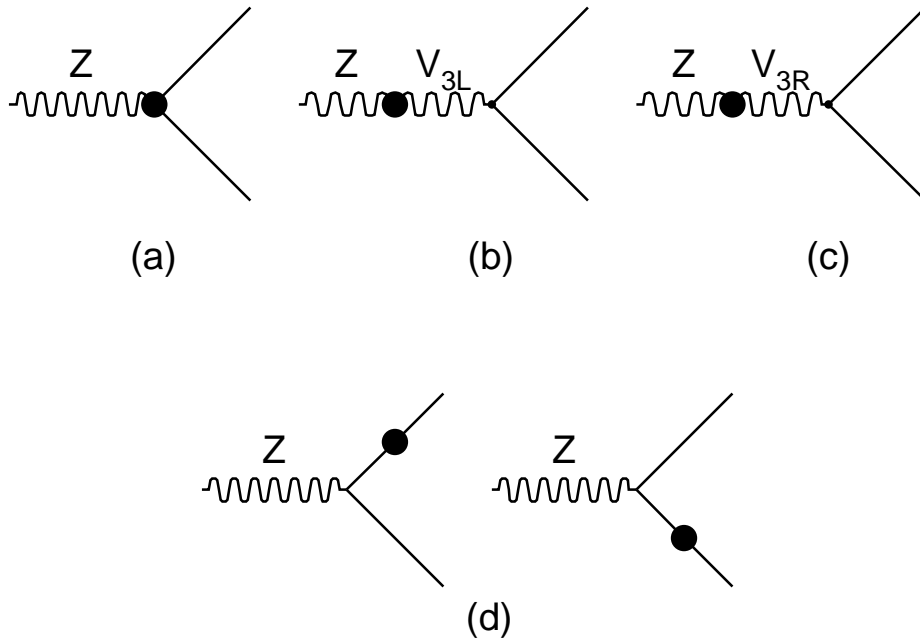

Fig. 13

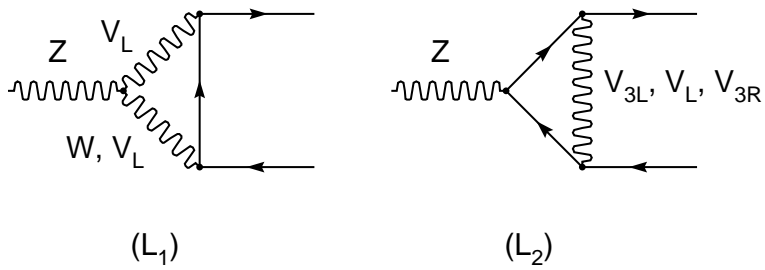

Fig. 14

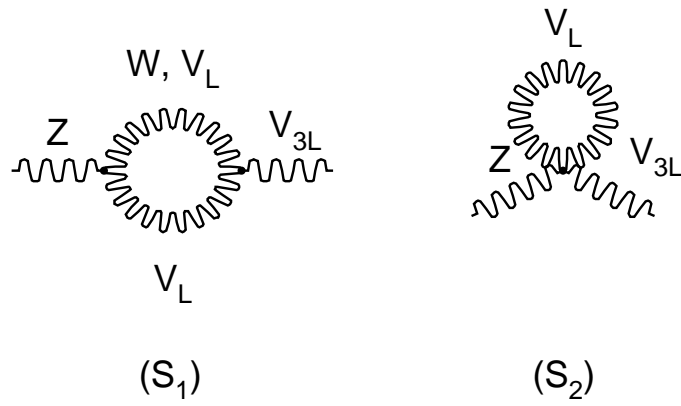

Fig. 15

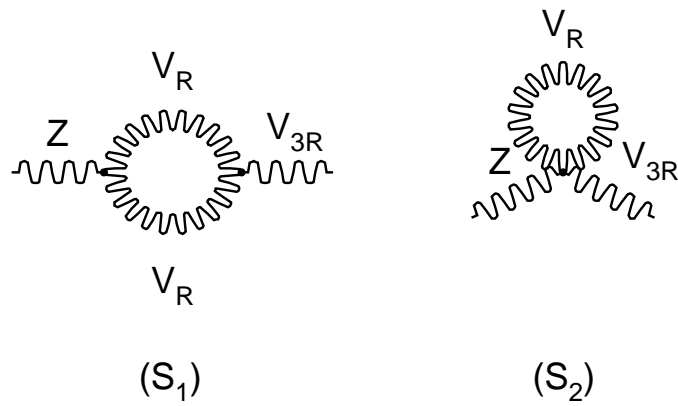

Fig. 16