

Quasiclassical mass spectrum of the black hole model with selfgravitating dust shell.

A. Yu. Neronov

Department of Mathematics and Mechanics, Lomonosov Moscow State University, 119899,

Moscow, Russia

e-mail: aneronov@mech.math.msu.su

(November 2, 2021)

Abstract

We consider a quantum mechanical black hole model introduced in *Phys.Rev.*, **D57**, 1118 (1998) that consists of the selfgravitating dust shell. The Schroedinger equation for this model is a finite difference equation with the shift of the argument along the imaginary axis. Solving this equation in quasiclassical limit in complex domain leads to quantization conditions that define discrete quasiclassical mass spectrum. One of the quantization conditions is Bohr-Sommerfeld condition for the bound motion of the shell. The other comes from the requirement that the wave function is unambiguously defined on the Riemannian surface on which the coefficients of Schroedinger equation are regular. The second quantization condition remains valid for the unbound motion of the shell as well, and in the case of a collapsing null-dust shell leads to $m \sim \sqrt{k}$ spectrum.

PACS number(s): 04.70Dy, 04.20Gz

Typeset using REVTeX

INTRODUCTION.

The black hole physics gives us an example of the strong gravitational fields. The existence of the event (apparent) horizons causes the Hawking's evaporation of the black holes. The fate of the evaporating black holes becomes a subject of interest. The quantum theory may throw some light on many problems of the classical black hole physics. In the absence of the theory of quantum gravity we have to construct a new theory every time we want to quantize some classical gravitating object.

The simplest black holes models which nevertheless capture some important properties of the system consisting of the gravitational field interacting with matter are of special importance in the theory of black holes. Many authors have considered the models where the interaction of the gravitational field with matter in the form of a thin spherically symmetric shell was taken in account in the selfconsistent way [2,5,6,11].

In [1] the classical geometrodynamics for the system of a thin dust matter shell in its own gravitational field was constructed. The canonical transformation was found which reduce the system of constraints to a rather simple system of functions on the phase space. The constraints are easily realized on the quantum level. Quantization of such a model in the coordinate representation leads to the Schroedinger equation in finite differences. The shift in the argument is along imaginary axis which has very important consequences. One of them is that the wave functions which are the solutions to such an equation should be analytical functions on the appropriate Riemannian surface.

In the ordinary quantum mechanics we are dealing with the second order differential equations. We demand that the solution should be at least two times differentiable. To find eigenfunctions and spectrum we need to specify a class of functions, usually by imposing appropriate boundary conditions. In the case of the finite differences operator with the shift along the imaginary axis we must specify a class of functions by demanding analyticity (except in the branching points). In [1] it was the analyticity requirement that enabled us to find the mass spectrum in the limit of large black holes. The spectrum depends on two

quantum numbers. This is explained by the fact that we succeeded in accounting for the motion of the shell in all regions of Kruskal space-time. The configuration space variable, the radius R of the shell takes its values on the cross (see Fig. 3) with intersection at the horizon point $R = R_g$ (R_g is the gravitational radius of the shell). R changes from 0 to R_g on two of the hands of the cross in T_{\pm} regions of the space-time and from R_g to ∞ on the other two hands in R_{\pm} regions of Kruskal space-time. So the principal difference from the usual one dimensional quantum mechanics, where the particle moves along a real line, R^1 was that the configuration space was not even two copies of a real line but some nontrivial topological space (a cross) which is not even a manifold. The nontrivial topology of the configuration space results in an appearance of the second quantum number.

In this paper we consider the quasiclassical solutions of the finite-difference Schroedinger equation of the quantum black hole model considered in [1]. The Riemannian surface on which the finite difference Schroedinger equation is defined turns out to be a sphere with two punctured points which are two spatial infinities at R_+ and R_- regions of Kruskal space-time (Fig. 3). There is a nontrivial cycle on this Riemannian surface. The usual Bohr-Sommerfeld condition, that corresponds to the bound motion of the shell, gives one of the quantum numbers in the spectrum. Apart from this condition there appears to exist another nontrivial quantization condition which stems from the requirement for the wave function to be a regular function on the relevant Riemannian surface. It therefore should have trivial monodromy along the nontrivial cycle on the Riemannian surface. This requirement leads to another Bohr-Sommerfeld-like condition on the mass spectrum. So the quasiclassical mass spectrum depends on two quantum numbers. It becomes clear in our considerations that the appearance of the second quantum number is due to the nontrivial topology of the classical configuration space of the model.

We will remind the black hole model considered in [1] in sections I and II and write the finite difference Schroedinger equation which we will analyze (it is slightly different from the one considered in [1] because of another factor ordering). Then the method of construction of quasiclassical solutions of differential equations in complex domain will be

explained in section III. We show how Bohr-Sommerfeld quantization condition arises from gluing the global quasiclassical solution from solutions defined in different regions of the complex plane. In sections IV and V we apply this method for the Schroedinger equation of our black hole model and obtain the quasiclassical mass spectrum which posses the special properties mentioned above. It is different from the large black hole spectrum obtained in [1] but coincides with it in a certain limit. In section VI we show that one of the quantization conditions remains valid for the unbound motion of the shell and therefore defines the spectrum of the states of the collapsing shell. In the case of a null-dust shell when the continuous parameter M – bare mass of the shell is absent, this quantization condition leads to discrete mass spectrum for unbound motion. This spectrum turns out to be $m \sim m_{pl}\sqrt{k}$, $k \in Z$ – the spectrum found by Bekenstein and Mukhanov [4].

I. HAMILTONIAN DYNAMICS OF THE SELFGRAVITATING THIN SHELL.

We consider the following model of the black hole [1]. This is a self-gravitating spherically symmetric dust thin shell, endowed with a bare mass M . The whole space-time is divided into three different regions: the inner part (I), the outer part (II) both containing no matter fields and separated by a thin layer (III), that contains the dust matter of the shell (Fig. 1 where the Carter-Penrose diagram of the space-time is presented.). The general metric of a spherically symmetric space-time is:

$$ds^2 = -N^2 dt^2 + L^2(dr + N^r dt)^2 + R^2(d\theta^2 + \sin^2\theta d\phi^2) \quad (1)$$

where (t, r, θ, ϕ) are space-time coordinates, N, N^r, L, R are some functions of t and r only. The trajectory of the thin shell is some 3-dimensional surface Σ in the space-time given by some function $\hat{r}(t)$: $\Sigma^3 = \{(t, r, \theta, \phi) : r = \hat{r}(t)\}$. In the region I $r < \hat{r} - \epsilon$, in the region II $r > \hat{r} + \epsilon$, and the region III is a thin layer $\hat{r} - \epsilon < r < \hat{r} + \epsilon$. We require that metric coefficients N, N^r, L and R are continuous functions, but jump discontinuities could appear in their derivatives at the points of Σ when the limit $\epsilon \rightarrow 0$ is taken. The action functional for the system of the spherically symmetric gravitational field and the thin shell is

$$\begin{aligned}
S = S_{gr} + S_{shell} &= \frac{1}{16\pi G} \int_{I+II+III} {}^{(4)}R\sqrt{-g}d^4x \\
&+ (\text{surface terms}) - M \int_{\Sigma} d\tau
\end{aligned} \tag{2}$$

It consists of the standard Einstein-Hilbert action for the gravitational field and the matter part of the action that describes the thin shell of dust.

The complete set of degrees of freedom of our system consists of the set of $N(r, t)$, $N^r(r, t)$, $L(r, t)$, $R(r, t)$ which describe the gravitational field and $\hat{r}(t)$ which describes the motion of the shell. The metric (1) has the standard ADM form for 3+1 decomposition of a space-time with lapse function N , shift vector $N^i = (N^r, 0, 0)$ and space metric $h_{ik} = \text{diag}(L^2, R^2, R^2 \sin^2 \theta)$.

Substitution of the expression (1) for the metric into the action (2) gives in Hamiltonian formalism [1]

$$\begin{aligned}
S = \int_{I+II} (P_L \dot{L} + P_R \dot{R} - NH - N^r H_r) dr dt + \int_{\Sigma} \hat{\pi} \hat{\dot{r}} - \\
\hat{N} \left(\hat{R} [R'] / (G \hat{L}) + \sqrt{m^2 + \hat{\pi}^2 / \hat{L}^2} \right) - \\
\hat{N}^r \left(-\hat{L} [P_L] - \hat{\pi} \right) dt
\end{aligned} \tag{3}$$

where $P_R(r)$, $P_L(r)$ are momenta conjugate to $R(r)$ and $L(r)$, π is momentum conjugate to \hat{r} , hats denote the variables defined on the shell surface Σ , dots denote time derivatives $\partial/\partial t$ and primes denote derivatives $\partial/\partial r$. Square brackets denote the jump of a function on the shell surface: $[\mathcal{A}] = \lim_{\epsilon \rightarrow 0} (\mathcal{A}(\hat{r} + \epsilon) - \mathcal{A}(\hat{r} - \epsilon))$. The lapse $N(r)$ and \hat{N} , the shift $N^r(r)$ and \hat{N}^r functions become the Lagrange multipliers as usual in ADM formalism and H and H^r are the constraints:

$$\left\{ \begin{array}{l}
H = G \left(\frac{LP_L^2}{2R^2} - \frac{P_L P_R}{R} \right) + \\
\frac{1}{G} \left(-\frac{L}{2} - \frac{(R')^2}{2L} + \left(\frac{RR'}{L} \right)' \right) \\
H_r = P_R R' - L P_L'.
\end{array} \right. \tag{4}$$

The system of constraints contain two surface constraints in addition to usual Hamiltonian and momentum constraints of the ADM formalism.

ADM constraints:

$$\begin{cases} H = 0 \\ H_r = 0 \end{cases} \quad (5)$$

Shell constraints:

$$\begin{cases} \hat{H}_r = \hat{\pi} + \hat{L}[P_L] = 0 \\ \hat{H} = \frac{R[R']}{GL} + \sqrt{M^2 + \hat{\pi}^2/L^2} = 0 \end{cases} \quad (6)$$

Karel Kuchar [7] proposed some specific canonical transformation of the variables (R, P_R, L, P_L) to new canonical set (R, \bar{P}_R, m, P_m) in which Hamiltonian and momentum constraints given by (4) are equivalent to the very simple set of constraints :

$$\begin{cases} \bar{P}_R = 0 \\ m' = 0 \end{cases} \quad (7)$$

The idea is to use the Schwarzschild ansatz for the space-time metric instead of the metric (1):

$$ds^2 = -F(R, m)dT^2 + \frac{1}{F(R, m)}dR^2 + R^2(d\theta^2 + \sin^2\theta d\phi^2) \quad (8)$$

where T, R and m are some functions of (r, t) and $F(R, m) = 1 - 2Gm/R$. One could construct a canonical transformation between (R, P_R, L, P_L) and (R, \bar{P}_R, m, P_m) so that the system of constraints (5) is equivalent to the system of constraints (7) in new variables in the phase space.

In the presence of the thin shell the configuration space also contains the coordinates \hat{R}, \hat{L} and \hat{r} . If we introduce the coordinates

$$\hat{p} = \hat{\pi} + L[P_L] \quad (9)$$

$$\hat{P}_{\hat{R}} = \pm \left[\frac{1}{2G} R \ln \left| \frac{RR' - GLP_L}{RR' + GLP_L} \right| \right]$$

on the shell surface we could see that these coordinates turn out to be conjugate to \hat{R} and \hat{r} [1]. The set $(m(r), P_m(r), R(r), \bar{P}_R(r), \hat{R}, \hat{P}_{\hat{R}}, \hat{r}, \hat{p})$ gives the canonical coordinates in

the whole phase space of the system. One could consider the whole set of constraints (5) and (6) in the phase space $\Pi = \{(R(r, t), P_R(r, t), L(r, t), P_L(r, t), \hat{r}(t), \hat{\pi}(t))\}$. The surface momentum constraint $\hat{H}_r = 0$ (6) takes the form

$$\hat{p} = 0 \quad (10)$$

The shell Hamiltonian constraint is expressed through the variables as follows

$$\hat{H} = \frac{R}{G} \sqrt{\sqrt{F_{out}} - \sqrt{F_{in}} \exp\left(\frac{G\hat{P}_{\hat{R}}}{R}\right)} \sqrt{\sqrt{F_{out}} - \sqrt{F_{in}} \exp\left(-\frac{G\hat{P}_{\hat{R}}}{R}\right)} - M = 0 \quad (11)$$

which means that

$$\exp\left(\pm \frac{G\hat{P}_{\hat{R}}}{R}\right) = \frac{1}{2\sqrt{F_{in}F_{out}}} \left(F_{in} + F_{out} - \frac{M^2G^2}{R^2} \pm \frac{2MG}{R} \mathcal{Z} \right) \quad (12)$$

where

$$\mathcal{Z} = \sqrt{(F_{out} - F_{in})^2 \frac{R^2}{4M^2G^2} - \frac{1}{2}(F_{out} + F_{in}) + \frac{M^2G^2}{4R^2}} \quad (13)$$

Since the shell could be found in each of the four regions R_{\pm}, T_{\pm} of Kruskal space-time the dynamical variable \hat{R} which measures the radius of the shell Σ embedded in the space-time M could take its values on the cross, shown on Fig. 3. So the configuration space of the dynamical system under configuration has the singularity at the horizon. We will see how this singularity disappears when we turn to the quantum mechanics where we'll have to consider the realization of the relevant operators on some complex Riemannian surface (section V).

The Hamiltonian constraint (11) was derived under the assumption that both F_{in} and F_{out} are positive. It is possible to derive analogous constraints in T_{\pm} -regions, where $F < 0$. But, instead, one could consider the function $F^{1/2}$ as a complex valued function. The point of the horizon $F = 0$ becomes a branching point, and we need the rules of the bypass. We assume the following

$$\begin{aligned}
F^{1/2} &= |F| e^{i\phi} \\
\phi &= 0 \quad \text{in } R_+\text{-region} \\
\phi &= \pi/2 \quad \text{in } T_-\text{-region} \\
\phi &= \pi \quad \text{in } R_-\text{-region} \\
\phi &= -\pi/2 \quad \text{in } T_+\text{-region}
\end{aligned} \tag{14}$$

The reason for such analytical continuation is that we will be able to get the single equation on the wave function Ψ which covers all four patches of the complete Penrose diagram for the Schwarzschild space-time. Some important consequences of this fact will become evident in section V.

The case of special interest for us will be the dynamics of the null-dust shell which corresponds to the case $M = 0$ so that the shell propagates with the speed of light [11]. In this case the shell constraints (6) take a simple form

$$\begin{cases} \hat{H}_r = \hat{\pi} + \hat{L}[P_L] = 0 \\ \hat{H} = \frac{R[R']}{GL} + \hat{\pi} = 0 \end{cases} \tag{15}$$

and from (11) we get the form of shell constraint in terms of Kuchar variables:

$$\frac{R^2}{G^2} \sqrt{F_{in} + F_{out} - 2\sqrt{F_{in}F_{out}} \operatorname{ch}\left(\frac{G\hat{P}_{\hat{R}}}{\hat{R}}\right)} = 0 \tag{16}$$

which is equivalent to

$$\exp\left(\pm \frac{G\hat{P}_{\hat{R}}}{R}\right) = \sqrt{\frac{F_{in}}{F_{out}}} \tag{17}$$

In the rest of the paper we will restrict ourselves with the motions of the shell when $m_{in} = 0$. In this case it is convenient to make a canonical transformation from $(\hat{R}, \hat{P}_{\hat{R}})$ to (\hat{S}, \hat{P}_S) :

$$\begin{cases} \hat{S} = \frac{\hat{R}^2}{(2Gm)^2} = \frac{\hat{R}^2}{R_g^2} \\ \hat{P}_S = R_g^2 \frac{\hat{P}_{\hat{R}}}{2\hat{R}} \end{cases} \tag{18}$$

where R_g is the gravitational radius of the shell. Dimensionless variable \hat{S} is the surface area of the shell measured in the units of the horizon area of the shell of mass m .

II. DIRAC QUANTIZATION OF THE MODEL.

The Dirac quantization of the black hole model under consideration looks like the follows.

The phase space of our model consists of coordinates $(R(r), \tilde{P}_R(r), m(r), P_m(r), \hat{R}, \hat{P}_{\hat{R}}, \hat{r}, \hat{p}_r)$ $r \in (-\infty, \hat{r} - \epsilon) \cup (\hat{r} + \epsilon, \infty)$. Then the wave function in coordinate representation depends on configuration space coordinates:

$$\Psi = \Psi(R(r), m(r), \hat{R}, \hat{r}) \quad (19)$$

and all the momenta become operators of the form

$$\begin{aligned} \tilde{P}_R(r) &= -i \delta / \delta R(r); \quad P_m(r) = -i \delta / \delta m(r); \\ \hat{P}_{\hat{R}} &= -i \partial / \partial \hat{R}; \quad \hat{p}_r = -i \partial / \partial \hat{r}. \end{aligned} \quad (20)$$

Using the Kuchar constraints (7) and the shell constraint (10) in operator form we conclude that the wave function does not depend on $R(r)$ and \hat{r} as far as

$$\begin{cases} \partial \Psi / \partial R(r) = 0 \\ m'(r) \Psi = 0 \\ \partial \Psi / \partial \hat{r} = 0 \end{cases} \quad (21)$$

The dependence on $m(r)$ is reduced in regions I and II to $\Psi \equiv \delta(m - m_{\pm})$ where m_{\pm} do not depend on r . m_{\pm} equal to Schwarzschild masses in the inner and outer regions m_{in} and m_{out} . We restrict ourselves with the case when $m_{in} = 0$ so the dependence of the wave function on the phase space variables reduces to

$$\Psi = \Psi(m, \hat{R}) \quad (22)$$

The only nontrivial equation is the shell hamiltonian constraint (11). It contains the square root expression which is difficult to realize at quantum level. So we use the squared version of the shell Hamiltonian constraint, which in terms of the canonical pair (S, P_s) (18) reads as

$$\hat{C} = 1 - \frac{1}{2\sqrt{S}} - \frac{M^2}{8m^2 S} - \sqrt{F} \operatorname{ch} \left(\frac{\hat{P}_S}{2Gm^2} \right) = 0 \quad (23)$$

The operator \hat{C} contains the exponent of the momentum \hat{P}_S . This exponent becomes an operator of finite displacement when \hat{P}_S is the differential operator:

$$\exp\left(\frac{\hat{P}_S}{2Gm^2}\right)\Psi = \exp\left(-i\frac{m_{pl}^2}{2m^2}\frac{\partial}{\partial\hat{S}}\right)\Psi = \Psi(\hat{S} - \zeta i) \quad (24)$$

where m_{pl} is Plank mass and $\zeta = \frac{1}{2}\left(\frac{m_{pl}}{m}\right)^2$.

The constraint \hat{C} becomes an equation in finite differences if we substitute the expression (95) into (23).

$$\Psi(m, S + i\zeta) + \Psi(m, S - i\zeta) = F^{-1/2}\left(2 - \frac{1}{\sqrt{S}} - \frac{M^2}{4m^2S}\right)\Psi(m, S) \quad (25)$$

The shift in the argument of the wave function is along an imaginary axis. In the case of differential equation we require the solution to be differentiable sufficiently many times. Similarly, we have to demand the solutions of our finite differences equation (25) to be analytical functions. This condition is very restrictive but unavoidable. The importance of this requirement is shown in [5] where it is the analyticity of the wave functions and not the boundary conditions that lead to the existence of the discrete mass (energy) spectrum for bound states. In the next section we will see how it works in the quasiclassical regime.

The construction of quasiclassical solutions of the differential (finite difference) equations in complex domain requires the use of a special technic [10] explained in the next section. It is a well known fact that the quasiclassical approximation is not valid in the vicinity of the turning points of the classical trajectories of the system. When solving the equation in complex domain one could use the quasiclassical ansatze for the approximate solution only in regions that are distant from the turning points on the complex plane [3]. One need to glue the global solution defined on the whole complex plane from the solutions defined in different regions. This global solution must be an approximation to some analytical solution of the differential equation under consideration.

The next section is devoted to the explanation of the method of constructing the quasiclassical solutions of a differential equation in complex domain [10] using a simple example of nonrelativistic Schroedinger equation for the particle moving in a potential well. Then

in section V we use this method in order to build the analytical quasiclassical solutions of (25) in complex domain which will enable us to find the quasiclassical mass spectrum of our black hole model.

III. QUASICLASSICAL SOLUTIONS OF SCHROEDINGER EQUATION IN COMPLEX DOMAIN.

In this section we explain the construction of quasiclassical approximation to a regular solution of Schroedinger equation on the complex plane. The method was developed in [10] and [9] where all necessary theorems could be found.

Let us consider the nonrelativistic Schroedinger equation

$$-\hbar^2\Psi''(z) + q(z)\Psi(z) = 0 \quad (26)$$

on the complex plane $z \in C$. Let the function $q(z)$ be holomorphic in a region $D \in C$. Then in accordance with Cauchy theorem [8] equation (26) has a solution regular in D .

We look for the approximate solutions of (26) in the form of quasiclassical ansatze

$$\Psi(z) = \exp\left(\frac{i}{\hbar}\Omega(z)\right) \sum_{k=0}^{\infty} \hbar^k \phi_k \quad (27)$$

Then substituting (27) in (26) we obtain in zero order on \hbar the Hamilton-Jacobi equation on $S(z)$:

$$\left(\frac{\partial\Omega}{\partial z}\right)^2 + q(z) = 0 \quad (28)$$

If $q(z) \neq 0$ in the neighborhood U_{z_0} of some point z_0 then (28) has two solutions corresponding to the two different branches of the function $q^{1/2}(z)$:

$$\Omega(z_0, z) = \pm \int_{z_0}^z \sqrt{-q(t)} dt \quad (29)$$

and

$$\begin{aligned} \Psi(z) &= a\Phi_1(z) + b\Phi_2(z) \\ \Phi_{1,2}(z) &= (q(z))^{-1/4} \exp\left(\pm \frac{i}{\hbar} \int_{z_0}^z \sqrt{-q(t)} dt\right) \end{aligned} \quad (30)$$

The coefficients of (26) are analytical functions in the neighborhood of z_0 . Hence in accordance with Cauchy theorem in the neighborhood U_0 of a point $q(z_0) = 0$ exist two regular solutions of (26) as well. Nevertheless, if we consider the equation (26) far enough from z_0 where the quasiclassical approximation is valid, we find that the quasiclassical ansatze is not a good approximation for the regular solution in the punctured neighborhood of the point z_0 (the branching point for the function $q^{1/2}(z)$). This could be easily seen if one note that Φ_1 transforms into $i\Phi_2$ after the analytical prolongation along a closed path γ_1 which goes around z_0 (Fig. 2) while the regular solution have the trivial monodromy along this path. The approximate expression (30) for the wave function is valid only in a certain sector $\alpha < \text{Arg}(z - z_0) < \beta$ in the neighborhood of z_0 . The explanation of the effect is the following.

Let $z = z_0$ be, for example, a simple zero of the function $q : q \approx q_0(z - z_0)$ in U_0 ($q_0 = \rho_0 e^{i\phi_0}$ and $(z - z_0) = \rho e^{i\phi}$). Then

$$\Omega(z, z_0) = \frac{2}{3} q_0^{1/2} (z - z_0)^{3/2} = \frac{2}{3} \sqrt{\rho_0} \rho^{3/2} e^{i(\phi_0 + 3\phi - \pi)/2} \quad (31)$$

This function grows when $\rho = |z - z_0| \rightarrow \infty$ in the sector $-\pi < (3\phi + \phi_0 - \pi) < \pi$ confined by the lines l_1 and l_2 (Fig. 2 where ϕ_0 is taken to be $\phi_0 = \pi$), then it is pure oscillating on l_1, l_2 and l_5 and is decreasing in sectors $\pi < (3\phi + \phi_0 - \pi) < 3\pi$ and $-\pi < (3\phi + \phi_0) < -3\pi$. So the solution Φ_1 (30) grows in the sector **1** and decreases in the sectors **2** and **3** on Fig. 2. The solution Φ_2 has an opposite behavior: it grows in sectors **2** and **3** and decreases in sector **1**. Therefore in sector **1** the solution Φ_1 is exponentially large compared to Φ_2 . But in quasiclassical expression for the wave function we can not retain the exponentially small items simultaneously with exponentially large in the approximate expression for the wave function and in fact we could set the coefficient b to be equal to any number if only $a \neq 0$. The explanation for the fact that the quasiclassical ansatze fails to be the correct approximation for the regular solution is that the coefficients a, b (30) of expansion of the wave function on the system of solutions $\Phi_{1,2}$ are different in the sectors **1,2** and **3**. This fact was observed for the first time by Stokes and the phenomenon is called the Stokes

phenomenon [9]. The lines l_i defined by the equation

$$\text{Im } \Omega(z, z_0) = 0 \quad (32)$$

are called the Stokes lines. They start at the branching points $q(z_0) = 0$ and terminate at singular points of equation or at infinity. Both solutions $\Phi_{1,2}$ (30) are oscillating along these lines.

When the point z_0 is a zero of n -th order for the function $q(z)$ ($q(z) \approx q_0(z - z_0)^n$) the Stokes lines approach the rays $\text{Arg}(z - z_0) = \phi_k = \text{const}$ near z_0 . ϕ_k are given by the formula

$$\phi_k = \frac{(2k + 1)\pi - \phi_0}{n + 2} \quad (33)$$

where $\phi_0 = \text{Arg}(q_0)$. The formula remains valid when $n < 0$ and z_0 is a singular point of (26).

The global structure of the Stokes lines when $q(z)$ has the form of potential well with two turning points $q(z_{0,1}) = 0$ is shown on Fig. 2. The Stokes lines divide the complex plane into the sectors **1,2,3** and **4** (Fig. 2) in which one of solutions (30) is exponentially small compared to the other.

Let the approximate expression for the regular solution be given in one of the sectors, for example in **1**

$$\Psi(z) = a_1\Phi_1(z) + b_1\Phi_2(z), \quad z \in \mathbf{1} \quad (34)$$

The form of approximate solution in other sectors of the complex plane could be found using the using the following algorithm [10].

1) The whole complex plane is divided into the set of intersecting regions $\{D_i\}$ called the canonical regions. The boundary of each region D_i consists of some Stokes lines $\partial D_i = \cup l_k$ so that each D_i is a sum of the sectors **1,2,...** into which the Stokes lines divide the complex plane. For example, for the problem of a particle in a potential well (Fig. 2) some of canonical regions are $D_1 = \mathbf{1} \cup \mathbf{2}$, $D_2 = \mathbf{3} \cup \mathbf{3}$ and $D_3 = \mathbf{2} \cup \mathbf{4}$. The regions D_i

are foliated by the level lines $L_c = \{ \text{Im}(\Omega(z)) = c = \text{const} \}$. Each D_i is chosen so that $c = \text{Im}(\Omega)$ changes from $-\infty$ to $+\infty$ in D_i . In each of these regions the fundamental system of solutions $\Phi_{1,2}^{l_i}(z)$

$$\begin{aligned} \Psi(z) &= a_1 \Phi_1^{l_i}(z) + a_2 \Phi_2^{l_i}(z), \quad z \in D_i \\ \Phi_{1,2}^{l_i} &= \frac{1}{q^{1/4}(z)} \exp\left(\pm \frac{i}{\hbar} \Omega^{l_i}(z)\right) \end{aligned} \quad (35)$$

is introduced. In order to define the fundamental system of solutions one need to choose a branching point $z_0 \in \partial D_i$ and a Stokes line $l_i \in D_i$, $z_0 \in l_i$. Then the phase Ω of the quasiclassical wave function (27) is

$$\Omega^{l_i}(z, z_0) = \int_{z_0}^z \sqrt{-q(t)} dt + \Omega_0 \quad (36)$$

where Ω_0 is chosen so that $\text{Im}(\Omega^{l_i}) = 0$ on l_i . Assume the first solution of the fundamental system is increasing in the sector on the right (clockwise) from the reference Stokes line and is decreasing in the sector on the left (anti-clockwise) from the reference Stokes line.

2) In intersections $D_i \cap D_j$ the transition matrices $T_{i,j}$ between the corresponding systems of solutions $\Phi_{1,2}^{l_i}$ and $\Phi_{1,2}^{l_j}$ are defined:

$$\begin{aligned} \Psi &= a_i \Phi_1^{l_i} + b_i \Phi_2^{l_i} = a_j \Phi_1^{l_j} + b_j \Phi_2^{l_j}, \quad z \in D_i \cap D_j \\ \begin{pmatrix} a_i \\ b_i \end{pmatrix} &= T_{i,j} \begin{pmatrix} a_j \\ b_j \end{pmatrix} \end{aligned} \quad (37)$$

3) Let the form of the solution be given in some region D_1 . Then we could find the form of the quasiclassical solution at any point A of the complex plane. We need to draw a path γ from a point $B \in D_1$ to A and to cover it by the set of intersecting canonical regions D_1, \dots, D_k . The form of the solution in the region D_k , which contain the point A , is

$$\begin{aligned} \Psi(z) &= a_k \Phi_1^{l_k} + b_k \Phi_2^{l_k}, \quad z \in D_k \\ \begin{pmatrix} a_k \\ b_k \end{pmatrix} &= T \begin{pmatrix} a_1 \\ b_1 \end{pmatrix} \end{aligned} \quad (38)$$

where the matrix T :

$$T = T_{k,k-1} \times T_{k-1,k-2} \times \dots T_{2,1} \quad (39)$$

Let us consider the quasiclassical solutions of equation (26) in the simplest case when the function $q(z)$ has two zeros (the turning points of the classical motion) situated in points z_0 and z_1 on real line (see Fig. 2). We impose on the wave function Ψ the requirement $\Psi(z) \rightarrow 0$ when $z \rightarrow \pm\infty$ along the real line. So the solution in the region $D_1 = \mathbf{1} \cup \text{mbox}\mathbf{2}$ must be

$$\begin{aligned} \Psi(z) &= a_1 \Phi_1^{l_1} + b_1 \Phi_2^{l_1}, \quad z \in D_1 \\ \begin{pmatrix} a_1 \\ b_1 \end{pmatrix} &= \begin{pmatrix} 0 \\ 1 \end{pmatrix} \end{aligned} \quad (40)$$

since the second solution of the fundamental system in region D_1 is decreasing in the sector $\mathbf{1}$ in accordance with the convention taken for enumeration of the solutions from the fundamental system. We need to find the solution in the region $D_3 = \text{mbox}\mathbf{2} \cup \mathbf{4}$ which contain the real line on the left from the region of the classical motion

$$\Psi(z) = a_3 \Phi_1^{l_3} + b_3 \Phi_2^{l_3}, \quad z \in D_3 \quad (41)$$

We choose a path γ_2 connecting points $A \in D_3$ and $B \in D_1$ (Fig. 2). It could be covered by the three canonical regions D_1 , D_2 and D_3 so that

$$\begin{pmatrix} a_3 \\ b_3 \end{pmatrix} = T \begin{pmatrix} 0 \\ 1 \end{pmatrix} \quad (42)$$

where

$$T = T_{3,2} \times T_{2,2} \times T_{2,1} \quad (43)$$

The matrix $T_{2,2}$ has appeared in the equation because in the canonical region D_2 there exist two different fundamental systems of solutions. One of them is defined by the Stokes line l_2 and the branching point z_0 while the other is defined by the Stokes line l_2 and the branching point z_1 (Fig. 2). The transition matrix between the two fundamental systems of solutions in D_2 is

$$T_{2,2} = e^{i\epsilon} \begin{pmatrix} 0 & \exp\left(\frac{i}{\hbar} \int_{z_0}^{z_1} \sqrt{-q(z)} dz\right) \\ \exp\left(-\frac{i}{\hbar} \int_{z_0}^{z_1} \sqrt{-q(z)} dz\right) & 0 \end{pmatrix} \quad (44)$$

where $e^{i\epsilon}$ is some factor coming from the normalization of the solutions, and which is not important for us. The transition matrix between the fundamental system of solutions defined in the region D_1 with the Stokes line l_1 with the turning point z_0 and the fundamental system of solutions defined in the region D_2 with the Stokes line l_2 and the same turning point z_0 is

$$T_{2,1} = e^{i\pi/6} \begin{pmatrix} 0 & 1 \\ 1 & i \end{pmatrix} \quad (45)$$

The same transition matrix is between the region D_2 with the Stokes line l_2 and the turning point z_1 and the region D_3 with the Stokes line l_3 and the turning point z_1 . In accordance with (43) we find

$$T = e^{i(\epsilon+\pi/3)} \begin{pmatrix} \exp\left(\frac{i}{\hbar} \Omega(z_0, z_1)\right) & i \exp\left(\frac{i}{\hbar} \Omega(z_0, z_1)\right) \\ 0 & i \left(\exp\left(\frac{i}{\hbar} \Omega(z_0, z_1)\right) + \exp\left(-\frac{i}{\hbar} \Omega(z_0, z_1)\right) \right) \end{pmatrix} \quad (46)$$

where $\Omega(z_0, z_1) = \int_{z_0}^{z_1} \sqrt{-q(z)} dz$. Since we impose the requirement that the quasiclassical wave function decreases in the sector **4**, then the expansion of the wave function on the fundamental system of solutions in region D_3 must be

$$\begin{pmatrix} a_3 \\ b_3 \end{pmatrix} = \begin{pmatrix} 1 \\ 0 \end{pmatrix} \quad (47)$$

because the first solution of the fundamental system defined by the Stokes line l_3 decreases on the left from l_3 . From (42) and (46) we see that this requirement is satisfied only if

$$\exp\left(\frac{i}{\hbar} \int_{z_0}^{z_1} \sqrt{-q(z)} dz\right) = \pm i \quad (48)$$

This condition is equivalent to the well known Bohr-Sommerfeld quantization condition

$$\frac{1}{\pi\hbar} \int_{z_0}^{z_1} \sqrt{-q(z)} dz = n + \frac{1}{2}, \quad n \in Z \quad (49)$$

So we have found that in the simplest case when the regular function $q(z)$ from the Schroedinger equation (26) has just two simple zeros $q(z) = 0$ situated on the real line, the quasiclassical solution defined on the whole complex plane exists if the coefficients of the equation satisfy Bohr-Sommerfeld condition (49). The approximate expression for the solution of the form (27) is different in the different canonical regions D_i of the complex plane and the approximation itself is valid only far from the turning points $q(z) = 0$ of the equation (26).

IV. QUASICLASSICAL SOLUTIONS OF SCHROEDINGER EQUATION FOR SELFGRAVITATING DUST SHELL

In this section we will find the quasiclassical solutions in complex domain for the equation (25) which is the quantum form of Hamiltonian constraint for the system that consists of a selfgravitating thin dust shell and its own gravitational field.

A principal difference of the equation (25) from the nonrelativistic Schroedinger equation (26) that was considered in the previous section is that its coefficients contain the function

$$F^{1/2} = \sqrt{1 - \frac{1}{\rho}} = \frac{\sqrt{\rho(\rho - 1)}}{\rho} \quad (50)$$

(where $\rho = \sqrt{S}$) that is a branching analytical function on the complex plane. So we have to consider the equation (25) not on the complex plane but instead on the Riemannian surface S_F on which the coefficients of the equation are regular functions.

The Riemannian surface for the function $F^{1/2}$ (50) is a two-dimensional sphere consisting of two Riemannian spheres S_+ and S_- glued along the sides of the cuts made in both spheres along the interval $(0, 1)$. Let us consider the real section $\text{Im}(\rho) = 0$ of the Riemannian surface S_F . Its part $\rho > 0$ turns out to be a cross with two ends situated in the points $\rho = +\infty$ of S_F (see Fig. 3). so that $F^{1/2} > 0$ in $\rho = +\infty$ in S_+ (∞ at R_+ domain) and $F^{1/2} < 0$ in $\rho = +\infty$ in S_- (∞ at R_- domain). Two other ends are in the points $\rho = 0$ and the argument of $F^{1/2}$ is $+\pi/2$ (T_- domain) in one of the ends and $-\pi/2$ (T_+ domain) in the

other. So we could naturally identify the cross in the real section of the Riemannian surface S_F with the cross discussed in the section I which is the classical configuration space of the dynamical system under consideration.

An important feature of the form of Hamiltonian constraint for the black hole model introduced in [1] is that by ascribing the special choice of the argument for the function $F^{1/2}$ as a complex valued function one could obtain the constraint which is valid in all the four regions of Kruskal space-time R_+, R_-, T_+ and T_- . The price for this was that the classical configuration space of the dynamical system had a singular point at the black hole horizon and the configuration space turned out to be the cross (which is not even a manifold). Nevertheless, when we pass to the quantum mechanical problem, we have to consider the complex Riemannian surface S_F as the configuration space for the system which is a manifold and, as it will be shown, the dynamical system has no singular point at the horizon if we choose the coordinate which is regular on the surface S_F in the neighborhood of the horizon.

We will construct the quasiclassical wave function of the equation (25) on the whole surface S_F . According to the method explained in the previous section we need first to find the turning and singular points of the equation. Then we have to determine the structure of Stokes lines and canonical regions on the Riemannian surface S_F . The last step is to find the corresponding fundamental system of solutions in each region and the transition matrices between them.

In the limit of large black holes the displacement parameter $\zeta = m_{pl}^2 / 2m^2$ becomes small and we could cut the Taylor expansion of $\Psi(S + i\zeta)$ on the second term [1]. Then equation (25) becomes an ordinary differential equation:

$$-\zeta^2 \Psi''(S) + \left(2 - F^{-1/2} \left(2 - \frac{1}{\sqrt{S}} - \frac{M^2}{4m^2 S} \right) \right) \Psi(S) = 0 \quad (51)$$

This approximate equation is valid rather far from the horizon ($|\rho| \gg 1$) in both S_+ and S_- components of S_F . So we expect that the two equations (25) and (51) have common quasiclassical solutions in the vicinities of $\rho = \infty$ in S_+ and S_- . We will use this assumption in order to glue the quasiclassical solutions of (25) in different canonical regions in the

neighborhood of infinities.

One important note should be made at this point. We have seen in the previous section that the quasiclassical ansatz could not be valid in the neighborhood of any turning point ($q(z) = 0$) of nonrelativistic Schrodinger equation. Nevertheless, the Cauchy theorem guaranteed that there exists a regular solution of the equation in a domain containing this point and we could build its quasiclassical approximation everywhere except for the neighborhoods of the turning points. Now the picture is different. We have no theorem for the equation in finite differences which affirms the existence of regular solutions of the equation with regular coefficients. So the assumption we made is in fact the assumption that there exists a solution of the equation (25) regular everywhere on S_F except for the singular points of the finite difference equation (25) (which are $\rho = \infty$ at S_+ and S_- components of S_F as we will see) and we look for its approximate expression in the form of quasiclassical ansatz in the regions located far from turning and singular points of (25) on S_F .

For the massive dust shell there exist three qualitatively different types of classical motion, described in [1].

a) when $m < M < 2m$ the trajectory has the form shown on Fig. 1a. It starts from $\rho = 0$ in T_+ region, crosses its own horizon $\rho = 1$, expands to some maximal radius $\rho_{max} > 1$ in R_+ region (it could be observed by an observer at infinity during this period) and then it collapses to the singularity in the T_- region (the situation is called "the black hole case" in terms of [1]).

b) when $M > 2m$ the shell is in R_- region at the moment of its maximal expansion as it is shown on Fig. 1b, so for the external observer at R_+ infinity it does not appear from its horizon during the whole evolution ("the wormhole case").

c) the case $M < m$ describes the situation of collapse (Fig. 1c) when the trajectory goes from $\rho = \infty$ in R_+ region to $\rho = 0$ in T_- region.

We will consider in the next section the wave function of the black hole case (a).

V. THE QUASICLASSICAL WAVE FUNCTION IN THE CASE OF BLACK HOLE.

Let us choose the wave function in the form

$$\Psi(S) = \exp\left(\frac{i}{\hbar}\Omega(S)\right) (\phi(S) + \hbar\phi(S) + \dots) \quad (52)$$

of quasiclassical ansatz. Then the phase $\Omega(S)$ satisfies the Hamilton-Jacobi equation

$$\text{ch}\left(\frac{\partial\Omega}{\partial S}\right)^2 - F^{-1/2}\left(1 - \frac{1}{2\sqrt{S}} - \frac{M^2}{8m^2S}\right) = 0. \quad (53)$$

Its solutions are given by the functions $\Omega = \int_{S_0}^S P_s(s) ds$:

$$P_s = \ln\left(F^{-1/2}\left(1 + \frac{1}{2\sqrt{S}} + \frac{M^2}{8m^2S} \pm \frac{M}{2m\sqrt{S}}\mathcal{Z}\right)\right) \quad (54)$$

where \mathcal{Z} is given by (13). In terms of the coordinate ρ on the Riemannian surface S_F

$$\begin{cases} \rho = \sqrt{S} \\ P_\rho = 2\rho P_s \end{cases} \quad (55)$$

we have

$$P_\rho = 2\rho \ln\left(F^{-1/2}\left(1 + \frac{1}{2\rho} + \frac{M^2}{8m^2\rho^2} \pm \frac{M}{2m\rho}\mathcal{Z}\right)\right). \quad (56)$$

The turning points $P_s = (\partial\Omega/\partial S) = 0$ are the solutions of the equation

$$\begin{aligned} \mathcal{Z} &= \sqrt{\frac{m^2}{M^2} - 1 + \frac{1}{2\rho} + \frac{M^2}{16m^2\rho^2}} = 0 \\ \rho_1 &= \frac{M^2}{4m^2(M/m - 1)}, \text{ in } R_+ \text{ region} \\ \rho_2 &= -\frac{M^2}{4m^2(M/m + 1)}, \text{ in } V_- \text{ region} \end{aligned} \quad (57)$$

one of them is in S_+ component of S_F (this is the maximum radius of expansion of the shell) and the other is in S_- component and is situated in the region $\rho < 0$ which is denoted as V_- on Fig. 3. In the neighborhood of these turning points P_s is close to zero and in the equation

$$\text{sh}(P_s) = \frac{\mathcal{Z}M}{4m\sqrt{S}F^{1/2}} \quad (58)$$

we could set $\text{sh}(P_s) \approx P_s$ and find that in terms of regular coordinate ρ

$$P_\rho \sim \sqrt{\rho - \rho_i}, \quad i = 1, 2 \quad (59)$$

so the turning points are just like simple turning points of nonrelativistic Schroedinger equation considered in the previous section. In accordance with formula (33) we find that three Stokes lines originate from each of these turning points as it is shown on Fig. 4.

In the neighborhood of infinity in R_+ region the regular coordinate is

$$\begin{cases} t = \frac{1}{\rho} \\ P_t = -\frac{P_s}{2t^3} \end{cases} \quad (60)$$

The solutions of Hamilton-Jacobi equation in the neighborhood of infinity are

$$P_t = -\frac{1}{2t^3} \ln \left\{ \frac{1}{\sqrt{1-t}} \left(1 - \frac{1}{2}t - \frac{M^2}{8m^2}t^2 \pm \frac{M}{2m}t\mathcal{Z} \right) \right\} \quad (61)$$

The argument of logarithm is close to one so taking $\text{sh}(P_s) \approx P_s$ we obtain

$$P_t \approx \pm \frac{i}{8t^2} \sqrt{\frac{M^2}{m^2} - 1} \quad (62)$$

So the infinity in R_+ region is a singular point of the 4-th order and from (33) we find that the two Stokes lines originate from this point as shown on Fig. 5. This means that the Stokes lines in the S_+ component of the Riemannian surface S_F have vertical asymptotes.

In the neighborhood of infinity point in R_- region Hamilton-Jacobi equation takes the form

$$\text{ch}(-2t^3 P_t) = -\frac{1}{\sqrt{1-t}} \left(1 - \frac{1}{2}t - \frac{M^2}{8m^2}t^2 \right) \approx -1 \quad (63)$$

and

$$2P_t t^3 \approx \pm i\pi; \quad P_t \sim \frac{1}{t^3} \quad (64)$$

This singular point is of the 6-th order with four Stokes lines originating from it, as it is shown on Fig. 5. The Stokes lines in S_- component of S_F approach asymptotically the lines tilted with the angles $\phi = \pm\pi/4$ with respect to the real line.

The regular coordinate in the point $\rho = 1$ is

$$\begin{cases} u = \sqrt{\rho - 1} \\ P_u = 4u(1 + u^2)P_s \end{cases} \quad (65)$$

In terms of this coordinate

$$F^{1/2} = \frac{u}{\sqrt{1 + u^2}} \quad (66)$$

and

$$P_u = 4u(1 + u^2) \ln \left\{ \frac{1}{u} \left(\sqrt{1 + u^2} - \frac{1}{2\sqrt{1 + u^2}} - \frac{M^2}{8m^2(1 + u^2)^{3/2}} \pm \frac{M}{2m\sqrt{1 + u^2}} \mathcal{Z} \right) \right\} \quad (67)$$

The coefficients of the equation (25) have singularities in the point $\rho = 1$. But we see from (67) that $P_u \rightarrow 0$ as $u \rightarrow 0$ and the phase

$$\begin{aligned} \Omega = \int P_s dS = \int P_u du = -2u^2(\ln u - 1/2) + \\ (regular\ part) \end{aligned} \quad (68)$$

also remains finite as $u \rightarrow 0$. So in terms of the regular coordinate on the Riemannian surface S_F in the neighborhood of $\rho = 1$ this point is in fact a turning point ($P_u = 0$) of the quasiclassical solution.

If we consider the truncated equation (51) in terms of regular coordinate on S_F near the horizon we will see that the point $u = 0$ is the turning point for this equation as well. Indeed, Hamilton-Jacobi equation for (51) has the form

$$\frac{P_u^2}{16u^2(1 + u^2)^2} = \frac{1}{u} \left(2\sqrt{1 + u^2} - \frac{1}{\sqrt{1 + u^2}} - \frac{M^2}{4m^2(1 + u^2)^{3/2}} \right) - 2 \quad (69)$$

and

$$P_u \sim \sqrt{u} \quad (70)$$

in the neighborhood of $u = 0$. So the turning point is just simple turning point and three Stokes lines originate from it as shown on Fig. 6. Note that the R_+ , R_- , T_+ and T_- lines intersect at the horizon as it is shown on Fig. 6. So one of the Stokes lines coincides with R_+ while the two others lie between R_- and T_{\pm} lines which means that they both belong to S_- component of S_F .

We are looking for the quasiclassical solution of the finite difference equation (25) in regions far from the turning points. In these regions the approximate equation (51) is valid. So we expect that the two equations have the same set of approximate solutions. So we will use the transition functions between the fundamental systems of solutions in different canonical regions (see previous section) calculated for the quasiclassical solutions of (51) in order to glue the quasiclassical solutions of (25) in different canonical regions. As it was noted at the beginning of the section there is no general theorem about the existence of solutions of finite difference equations. The method we use is based on our assumption about the existence of regular solutions of (25) in the neighborhood of the turning points and they could be approximated by the quasiclassical solutions in regions far from the turning points.

The remaining singular point is $\rho = 0$. Again, we pass to the regular coordinate on S_F near this point:

$$\begin{cases} v = S^{1/4} \\ P_v = 4v^3 P_s \end{cases} \quad (71)$$

then in terms of this coordinate

$$F^{1/2} = i \frac{\sqrt{1-v^2}}{v} \quad (72)$$

and the solution of Hamilton-Jacobi equation is

$$P_v = 4v^3 \ln \left\{ \frac{i}{\sqrt{1-v^2}} \left(v - \frac{1}{2v} - \frac{M^2}{8m^2v^3} \pm \frac{M}{2mv} \mathcal{Z} \right) \right\}. \quad (73)$$

It follows from (73) that $\rho = 0$ is a turning point as well as the horizon because $P_v \rightarrow 0$ with $v \rightarrow 0$ and the phase Ω (68) of the wave function

$$\Omega = v^4(\ln v - 1/4) + (\text{regular part}) \quad (74)$$

remains finite in the vicinity of $\rho = 0$. Using the same procedure as at the horizon we find the behavior of the Stokes lines at this point using the truncated equation (51). The Hamilton-Jacobi equation for (51) is

$$\frac{P_v^2}{16v^6} = \frac{i}{\sqrt{1-v^2}} \left(2v - \frac{1}{v} - \frac{M^2}{4m^2v^3} \right) - 2 \quad (75)$$

and $v = 0$ is the turning point of third order. In accordance with (33) we draw five Stokes lines from this point. One of the Stokes lines coincides with V_- ($\text{Arg } v = \pi/2$) as far as the argument of logarithm in (73) becomes zero on this line and the other four Stokes lines are situated symmetrically with respect to $V_+ \cup V_-$ line (see Fig. 6). Two of them are in S_+ component of S_F and the two others are in S_- component.

The general structure of Stokes lines on the Riemannian surface S_F is presented on Fig. 7. The Stokes lines divide the Riemannian surface into eight regions. In regions **2** and **4** on the picture the phase of quasiclassical wave function changes in finite limits $a < \text{Im}(\Omega) < b$. In other regions the phase changes so that $0 < |\text{Im}(\Omega)| < \infty$. Given a Stokes line and a canonical region containing this Stokes line we could construct a fundamental system of solutions in this region.

Now we could construct a quasiclassical solution of (25) in the whole S_F . We will look for the solutions obeying the two following natural requirements:

- **(A)** the solution must decrease when $\rho \rightarrow \infty$ along the R_+ and R_- lines (we consider the wave function of bound motion when the shell could not propagate to infinity);
- **(B)** the solution must be an unambiguous function on the Riemannian surface S_F .

(76)

So we start from the decreasing solution in the sector **1** (Fig. 7). The canonical region which contains R_+ is $D_1 = \mathbf{1} \cup \mathbf{2} \cup \mathbf{5}$ with the reference Stokes line l_1 , then the decreasing solution is the second solution of the fundamental system:

$$\begin{aligned} \Psi &= a_1 \Phi_1^{l_1} + b_1 \Phi_2^{l_1}, \quad \rho \in D_1 \\ \begin{pmatrix} a_1 \\ b_1 \end{pmatrix} &= \begin{pmatrix} 0 \\ 1 \end{pmatrix} \end{aligned} \quad (77)$$

In order to find the form of solution on R_- line we should continue the solution along some path γ , connecting the points A on R_+ and B on R_- (see Fig. 7). To do this we need to cover γ by the set of overlapping canonical regions D_1 , $D_2 = \mathbf{2} \cup \mathbf{4} \cup \mathbf{5} \cup \mathbf{6}$ and $D_3 = \mathbf{3} \cup \mathbf{2} \cup \mathbf{5}$ (see Fig. 7) and find the transition matrix between the fundamental system of solutions Φ_1 and Φ_2 in D_1 and $\tilde{\Phi}_1, \tilde{\Phi}_2$ in D_3 :

$$\begin{aligned} T &= T_{3,2} \times T_{2,2} \times T_{2,1} \\ \begin{pmatrix} a_3 \\ b_3 \end{pmatrix} &= T \begin{pmatrix} 0 \\ 1 \end{pmatrix} \end{aligned} \quad (78)$$

The matrix $T_{2,2}$ arises by the same reason as in the transition matrix (43). In the canonical region D_2 two different systems of solutions are defined by the Stokes line l_2 and different turning points $\rho = \rho_1$ and $\rho = 1$.

The solution $\Phi_2^{l_2}$ is decreasing on R_- . So the requirement (76,A) takes the form

$$\begin{aligned} \Psi &= a_3 \Phi_1^{l_2} + b_3 \Phi_2^{l_2}, \quad \rho \in D_3 \\ \begin{pmatrix} a_3 \\ b_3 \end{pmatrix} &= \begin{pmatrix} 0 \\ 1 \end{pmatrix} \end{aligned} \quad (79)$$

As far as both turning points involved in the calculation are simple turning points, the calculations are the same as in the previous section and we find that in order to obtain the quasiclassical solution decreasing with $\rho \rightarrow \infty$ along both R_+ and R_- lines the Bohr-Sommerfeld quantization condition must be satisfied on the Stokes line l_2 (Fig. 7):

$$\frac{1}{\pi \hbar} \int_{l_2} P_s dS = n + \frac{1}{2} \quad (80)$$

Let us note the important property of the constructed solution. Consider the form of solution on T_{\pm} lines. Let us recall the classical behavior of the shell in regions T_{\pm} of space-time. T_{-} is a nonstationary region of inevitable contraction and the classical solution for the shell is just collapsing solutions while the T_{+} region is the region of inevitable expansion and the shell trajectory starting from singularity $\rho = 0$ expands up to $\rho = 1$ and leaves the T_{+} region (Fig. 1). The quasiclassical wave function for both (25) and (51) equations expresses through the two basic solutions

$$\Psi = \exp\left(\pm \frac{i}{\hbar} \Omega(S)\right) \phi \quad (81)$$

corresponding to in-going and outgoing waves respectively. So it seems at first sight that at quantum level the shell does not contract inevitably in T_{-} region. But the phase $\Omega(S) = \int P_s dS$ is complex on this line

$$P_s = \ln \left| F^{-1/2} \left(1 + \frac{1}{2\sqrt{S}} + \frac{M^2}{8m^2 S} \pm \frac{M}{2m\sqrt{S}} \mathcal{Z} \right) \right| - i \operatorname{Arg}(F^{1/2}). \quad (82)$$

In each of the regions **1..8** on which the Stokes lines divide the Riemannian surface S_F one of the solutions (81) is exponentially small compared to the other. The function $F^{1/2}$ in the neighborhood of the horizon $\rho = 1$ is given by

$$F^{1/2} = \frac{u}{\sqrt{1+u^2}} \quad (83)$$

and the argument of $F^{1/2}$ coincides with the argument of the regular coordinate u on Riemannian surface S_F in the vicinity of $\rho = 1$. The argument of u is zero on the line R_{+} so the solution is an oscillating function on this line near the horizon. On the line R_{-} the argument of u is $\pm\pi$ so we have decreasing and increasing components in the fundamental system of solutions in sector **3** of Riemannian surface S_F . The same situation is on lines T_{\pm} . The argument of u is $\pm\pi/2$ and the solution $\Psi = \exp(+i\Omega/\hbar)$ which represents an outgoing wave is decreasing on line T_{-} while the solution $\Psi = \exp(-i\Omega/\hbar)$ (an in-going wave) is increasing and therefore is exponentially large with respect to the outgoing wave on the line T_{-} . On the line T_{+} the in-going wave is exponentially dumped by the same reason. If we require

that the solution is decreasing in sector **3** of the Riemannian surface S_F and therefore the in-going and outgoing waves have equal amplitudes on the line R_+ , we conclude that the in-going wave in T_- region and out-going wave in T_+ region both have nonzero amplitudes. In quasiclassical expression for the wave function we could not retain the exponentially small part of solution simultaneously with exponentially large and therefore could not notice the outgoing wave in T_- region and the in-going wave in T_+ region.

Let us now analyze the requirement (76,B). The solution of the equation (25) or (51) is defined on the Riemannian surface S_F (which is topologically two-dimensional sphere) with six punctured points: $\rho_1, \rho_2, 0, 1$ – the turning points and two infinities in S_{\pm} components of S_F which are singular points. There exist six nontrivial basic cycles $\gamma_1, \dots, \gamma_6$ around each of the punctured points on S_F . The procedure of construction of the quasiclassical solutions in complex domain gives the wave functions with trivial monodromy along the basic cycles $\gamma_1, \dots, \gamma_4$ around all the turning points $0, 1, \rho_1, \rho_2$. So we should only require that the wave function transforms into itself when prolonged along the pass γ_5 or γ_6 around the infinities in S_{\pm} components of S_F . It suffices to satisfy the condition only on one of the cycles because the other one is

$$\gamma_6 = (\gamma_1 \bullet \gamma_2 \bullet \gamma_3 \bullet \gamma_4 \bullet \gamma_5)^{-1} \quad (84)$$

(bullet denotes the composition law in fundamental group) It will be convenient to consider the cycle Γ shown on Fig. 7 (one could easily check that it is not a composition of cycles $\gamma_1, \dots, \gamma_4$ around the turning points). One could see that we could cover all the pass Γ by two canonical regions $D_3 = \mathbf{2} \cup \mathbf{5} \cup \mathbf{3}$ and $D_4 = \mathbf{4} \cup \mathbf{5} \cup \mathbf{3}$ (see Fig. 7). Let us prolong the solution from the region **3** containing the R_- line and the point $A \in \Gamma$ (Fig. 7) corresponding to the value $t = 0$ and $t = 1$ of the parameter along Γ to the region **5** containing V_+ line and the point $B \in \Gamma$ corresponding to $t = 1/2$.

The canonical region D_3 contains two Stokes lines l_5 and l_8 . Therefore, there exists two different fundamental systems of solutions in this region $\Phi_{1,2}^{l_5}$ and $\Phi_{1,2}^{l_8}$. The solution which decrease in the sector **3** of S_F is

$$\begin{aligned}\Psi &= a_3\Phi_1^{l_5} + b_3\tilde{\Phi}_2^{l_5}, \quad \rho \in D_3 \\ \begin{pmatrix} a_3 \\ b_3 \end{pmatrix} &= \begin{pmatrix} 0 \\ 1 \end{pmatrix}\end{aligned}\tag{85}$$

In order to clear up the behavior of this solution in sector **5** which belongs to the same canonical region D_4 as the sector **3** we express the solution Ψ through the fundamental system of solutions defined by the Stokes line l_8 in canonical region D_4 . The transition matrix is

$$T_{3,3} = \begin{pmatrix} \exp\left(\frac{i}{\hbar} \int_{1,(T_-)}^0 P_s dS\right) & 0 \\ 0 & \exp\left(-\frac{i}{\hbar} \int_{1,(T_-)}^0 P_s dS\right) \end{pmatrix}\tag{86}$$

Here the integral is taken along the interval $(0, 1)$ corresponding to T_- line on the Riemannian surface S_F . So the wave function has the form

$$\Psi = \exp\left(-\frac{i}{\hbar} \int_{1,(T_-)}^0 P_s dS\right) \Phi_2^{l_8}\tag{87}$$

on the line V_+ where $\Phi_2^{l_8}$ is increasing when $\rho \rightarrow -\infty$ along V_+ .

Let us consider the form of wave function in the region D_4 . There are two Stokes lines l_4 and l_9 in this region. In terms of fundamental system of solutions defined by the Stokes line l_5 the wave function has the form:

$$\begin{aligned}\Psi &= a_4\Phi_1^{l_5} + b_4\Phi_2^{l_5}, \quad \rho \in D_4 \\ \begin{pmatrix} a_4 \\ b_4 \end{pmatrix} &= \begin{pmatrix} 1 \\ 0 \end{pmatrix}\end{aligned}\tag{88}$$

When expressed through the fundamental system of solutions defined by the Stokes line l_9 the wave function becomes

$$\Psi = \exp\left(\frac{i}{\hbar} \int_{1,(T_+)}^0 P_s dS\right) \Phi_1^{l_9}\tag{89}$$

where $\Phi_1^{l_9}$ has the property $\Phi_1^{l_9}(\rho) \rightarrow +\infty$ when $\rho \rightarrow -\infty$ in V_+ region.

From the symmetry of the construction with respect to real line we have

$$\Phi_2^{ls}(\rho) = \Phi_1^{lg}(\rho), \quad \rho \in V_+ \quad (90)$$

so the two expressions for the wave function (87) and (89) agree if

$$\exp\left(\frac{i}{\hbar}\left(\int_{1,T_-}^0 + \int_{1,T_+}^0\right)P_s dS\right) = 1 \quad (91)$$

Taking in account the fact that the wave function is in-going wave on T_- line and outgoing on T_+ line, as it is explained earlier, we see that the integral in the argument of the exponent could be written as the integral over the closed path which goes around the cut made from the point $\rho = 0$ to $\rho = 1$ on both of the Riemannian spheres S_{\pm} constituting the Riemannian surface S_F . So the quasiclassical wave function satisfy the requirement (76,B) if the quantization condition

$$\frac{1}{2\pi\hbar}\left(\oint_0^1 P_s dS\right) = k, \quad k \in Z \quad (92)$$

holds.

Collecting the results obtained in this section we conclude that in zero order on \hbar the quasiclassical solution of equation (25) defined on the Riemannian surface S_F exists if the two quantization conditions (80) and (92) hold. Taking in account the explicit expression (54) for P_s and calculating the integrals entering the quantization conditions we obtain the equations defining the quasiclassical spectrum for the bound motion of the selfgravitating dust shell:

$$\begin{aligned} \int_1^{\rho_1^2} P_s dS &= -\frac{1}{2} + \frac{M^2}{8m^2} + \frac{3}{2} \ln\left(\frac{2m}{M}\right) - \frac{2 - \frac{M^2}{m^2}}{4\sqrt{\frac{M^2}{m^2} - 1}} \left(\pi + 3\arccos\left(\frac{m}{M}\right)\right) \\ \int_0^1 P_s dS &= \frac{1}{2} - \frac{M^2}{4m^2} - \ln\left(\frac{2m}{M}\right) + \frac{2 - \frac{M^2}{m^2}}{2\sqrt{\frac{M^2}{m^2} - 1}} \arccos\left(\frac{m}{M}\right) \end{aligned} \quad (93)$$

Denoting $\cos \alpha = m/M$ we obtain

$$\begin{cases} f_1 = \frac{1}{2} - \frac{1}{4 \cos^2 \alpha} - \ln(2 \cos \alpha) + \alpha \operatorname{ctg} 2\alpha = \pi \zeta k & k \in Z \\ f_2 = -\frac{1}{2} + \frac{1}{8 \cos^2 \alpha} + \frac{3}{2} \ln(2 \cos \alpha) - \frac{(3\alpha + \pi) \operatorname{ctg} 2\alpha}{2} = \pi \zeta \left(n + \frac{1}{2}\right) & n \in Z \end{cases} \quad (94)$$

The behavior of the functions standing in the left hand side of this equation is shown on Fig. 8. Large k and large positive n correspond to wormhole states while large negative n and finite k correspond to the black hole states as one could see.

Let us consider the spectrum in the black hole case. This corresponds to the values $m < M < 2m$ of parameters on Fig. 8a. In this case the function f_1 changes in finite limits from $f_1 = \pi/(3\sqrt{3}) - 1/2$ at $m/M = 1/2$ to $f_1 = 3/4 - \ln 2$ at $m/M = 1$. So if the Schwarzschild mass m is given, then k could change only in finite limits

$$\frac{1}{\zeta} \left(\frac{1}{3\sqrt{3}} - \frac{1}{2\pi} \right) < k < \frac{1}{\pi\zeta} \left(\frac{3}{4} - \ln 2 \right) \quad (95)$$

So the black hole state with given Schwarzschild mass m (the only parameter that an observer at infinity could measure) is a superposition of the states with different k and is in fact a mixed state, having nonzero entropy. Besides, we have the inequality

$$m > m_{pl} / \sqrt{\left(\frac{1}{6\sqrt{3}} - \frac{1}{4\pi} \right)} \quad (96)$$

for the quasiclassical black hole spectrum because otherwise the inequality (95) have no solutions. This means that the minimal black hole mass exists (if we suppose that quasiclassical spectrum is valid for low energy values).

The mass spectrum for the black hole model under consideration was found in [1] in the large black hole limit using another technic. Let us compare the two spectra. From (94) we find

$$\frac{\frac{M^2}{m^2} - 1}{2\pi\zeta} + \frac{2 - \frac{M^2}{m^2}}{2\zeta \sqrt{\frac{M^2}{m^2} - 1}} = -(3k + 2n + 1) \quad (97)$$

We see that although each of quantization conditions found in [1] does not hold for the quasiclassical spectrum, their combination (97) does hold.

Let us consider the limit $M > m$, $m \rightarrow M$ which corresponds to the case when the turning point of the classical motion of the shell $\rho_1 \rightarrow \infty$. In this limit $\alpha \rightarrow 0$ and the last item in the second of equations (94) becomes large compared to the others. Then the second quantization condition (94) takes the form in this limit

$$\frac{2 - \frac{M^2}{m^2}}{4\zeta \sqrt{\frac{M^2}{m^2} - 1}} = n + \frac{1}{2} \quad (98)$$

which coincides qualitatively with the quantization condition of [1]. So the two spectra coincide in the limit $m \rightarrow M$.

VI. THE QUASICLASSICAL SPECTRUM FOR THE COLLAPSING SHELL.

In the previous section we obtained the discrete mass spectrum for the bound motion of the selfgravitating shell. One of the quantization conditions (76,A) appeared to be similar to the Bohr-Sommerfeld quantization condition on the trajectories of the bound motion of mechanical system in nonrelativistic quantum mechanics. The other quantization condition (76,B) has a different origin being the requirement for the wave function to be a regular function on the Riemannian surface S_F . The first requirement (76,A) will disappear if we consider the situation of gravitational collapse when the classical trajectory goes from $\rho = \infty$ to $\rho = 0$ (see Fig.1c). The wave function is the superposition of in-going and out-going waves near ∞ and does not decrease in this region. So the first of the quantization conditions (80), (92) disappear. The principally new feature of our model compared to the ordinary nonrelativistic quantum mechanics is that the second condition (92) which stems from the requirement (76,B) for the wave function to be an unambiguous function on the Riemannian surface S_F does not disappear in the case of unbound motion and gives the discrete spectrum for the mass of the collapsing shell.

The collapse case corresponds to the values of parameters $m > M$. In this case the integral entering the quantization condition (92) takes the form

$$\int_0^1 \text{Re} (P_s) dS = \frac{1}{2} - \frac{M^2}{4m^2} - \ln \left(\frac{2m}{M} \right) + \frac{2 - \frac{M^2}{m^2}}{2\sqrt{1 - \frac{M^2}{m^2}}} \text{arcch} \left(\frac{m}{M} \right) \quad (99)$$

Denoting $\text{ch}(\alpha) = m/M$ we obtain

$$\tilde{f}_1 = \frac{1}{2} - \frac{1}{4 \text{ch}^2(\alpha)} - \ln(2 \text{ch}(\alpha)) + \alpha \text{cth}(2\alpha) = \pi\zeta k, \quad k \in Z \quad (100)$$

The graph of this function is presented on Fig. 8b. We see that when the Schwarzschild mass is fixed there are only finite number of quantum states of the collapsing shell, because \tilde{f}_1 changes from $3/4 - \ln 2$ to $1/2$ for all the values $1 < m/M < \infty$. So

$$\frac{1}{\pi\zeta} \left(\frac{3}{4} - \ln 2 \right) < k < \frac{1}{2} \quad (101)$$

The spectrum is continuous as far as it depends on a continuous parameter M but each level $m = \text{const}$ is finite degenerate similarly to the black hole case. Similarly to the black hole case we see that equation (101) has solutions only if

$$m > \sqrt{\pi} m_{pl} \quad (102)$$

which means that the minimal mass exists for the states of the collapsing shell in the quasiclassical spectrum.

Let us consider now the collapsing null-dust shell ($M = 0$). We write according to the Dirac quantization procedure the quantum version of the constraint (16). It is the following finite difference equation:

$$\Psi(S + i\zeta) + \Psi(S - i\zeta) = F^{-1/2} \left(2 - \frac{1}{\sqrt{S}} \right) \quad (103)$$

We look for the quasiclassical solutions on the whole S_F of this equation. The corresponding Hamilton-Jacobi equation

$$\text{ch} P_s = F^{-1/2} \left(1 - \frac{1}{2\sqrt{S}} \right) \quad (104)$$

has the solutions

$$P_s = \pm \ln (F^{1/2}) \quad (105)$$

The integral entering the quantization condition (92) is

$$\int_0^1 \text{Re} (P_s) dS = \pm \frac{1}{2} \quad (106)$$

and (92) gives the spectrum

$$m^2 = \pi m_{pl}^2 k, \quad k \in Z \quad (107)$$

proposed by Bekenstein, Mukhanov and other authors.

Let us consider the quasiclassical wave function in the case $m > M$. We would expect that the quasiclassical wave function will be concentrated near the classical trajectory of the collapsing shell in the phase space. Indeed, the in-going wave quasiclassical solution corresponds to this trajectory. But it turns out that we could not set the amplitude of the out-going wave to be equal to zero. We require that the wave function in R_- region to be equal to the decreasing solution of (25) (otherwise it grows infinitely with $\rho \rightarrow \infty$ in R_- region). Then we prolong of the solution to the whole Riemannian surface S_F following the procedure described in sections III and V. We find that the in- going and out-going waves enter the wave function with equal amplitudes on R_+ line. Therefore we see that the situation resembles the reflection from a potential wall in nonrelativistic quantum mechanics. The horizon point $\rho = 1$ is a turning point $P_u = 0$ for the quasiclassical motion if we choose the regular coordinate u on the Riemannian surface S_F near the horizon. So the equation (25) describes the situation when the stationary in-going wave reflects completely from the horizon. In T_- region the wave function is an in-going wave and in T_+ it is an out-going wave similarly to the case of bound motion.

VII. CONCLUSION.

In this paper we considered the quantum mechanical model of the black hole that consists of the selfgravitating thin dust shell. The Schroedinger equation for this model is a finite

difference equation (25) with the finite shift of the argument of the wave function along the imaginary axis [1]. Therefore, the equation must be considered on a Riemannian surface S_F where the function $F^{1/2}$ (50) is regular. The analysis of the equation on this Riemannian surface gives the mass spectrum for the black hole model in the quasiclassical approximation. While constructing the quasiclassical solutions on a complex manifold we need to determine the approximate solutions of the differential equation in different canonical domains of the complex manifold. Then we glue the global solution from the solutions defined in different canonical regions with the help of transitions matrices between these regions. In the section V this method was used in order to find the quasiclassical solutions of the equation (25). The quasiclassical solution satisfying the two requirements (76,A,B) exists if the coefficients of the equation satisfy two quantization conditions (80) and (92). One of the obtained quantization conditions (94) follows from the boundary conditions at infinities in R_{\pm} regions of Kruskal space-time (requirement (76,A)) and is obtained by the same procedure as Bohr-Sommerfeld condition of nonrelativistic quantum mechanics. But the other (94) which follows from (76,B) and is expressed as the requirement of the trivial monodromy of the wave function along nontrivial cycle Γ (Fig. 7) on the Riemannian surface S_F with punctured singular points of the equation (25). It has no analogy in ordinary quantum mechanics.

Being combined together the quantization conditions (94) define the discrete mass spectrum of the model, which depends on two quantum numbers. Furthermore, one of the quantization conditions (94) remains valid for the unbound motion where it takes the form (100). The spectrum of unbound motion is continuous but each level is finite degenerate. The black hole spectrum of both bound and unbound motions are bounded from below $m > \sqrt{\pi}m_{pl}$. For the null-dust $M = 0$ the remaining quantization condition gives the discrete spectrum of unbound motion which turns out to be the spectrum found by Bekenstein and Mukhanov [4].

ACKNOWLEDGMENTS

I wish to thank V.A.Berezin, A.M.Boyarsky and A.I.Shafarevich for many fruitful discussions of the question considered in this paper. This work was supported in part by the Russian Fund for Fundamental Research (Grant No 97-02-17064-a) and by Institute "Open Society" (Grant No a98-1857).

REFERENCES

- [1] V.A.Berezin,A.M.Boyarsky,A.Yu.Neronov Phys.Rev.,**D57**, 1118, (1998)
- [2] P.Hajicek, Phys.Rev. **D 57**, 936 (1998); P.Hajicek,J.Bicak, Phys.Rev. **D 56**, 4706 (1997); J.L.Friedman, J.Louko, S.N.Winters-Hilt, Phys.Rev. **D 56**, 7674 (1997);
- [3] L.D.Landau, E.M.Lifshitz *Quantum Mechanics*. Nauka, Moscow, (1974)
- [4] J.D.Bekenstein, V.F.Mukhanov, Phys.Lett., **B 360**, 7 (1995)
- [5] V.A.Berezin, Phys.Rev. **D 55** 2139 (1997)
- [6] V.A.Berezin, Phys. Lett., **241B**, 194 (1990)
- [7] K. Kuchar Phys.Rev. **D 50** 3961 (1994)
- [8] L.V.Ahlfors, *Complex Analysis*, McGraw-Hill, (1979)
- [9] J.Heading, *An Introduction to Phase-Integral Methods*, Methuen, 1962
- [10] M.V.Fedoryuk, *Asymptotic Analysis: Linear Ordinary Differential Equations*, Nauka, Moscow, (1972), Springer-Verlag, Berlin-New-York, (1993)
- [11] J.Louko, B.F.Whitting, J.L.Friedman, *Phys.Rev.*,**D57**, 2279, (1998)

FIGURES

FIG. 1. The space-time with selfgravitating thin shell. The black hole case (a) the wormhole case (b) and the case of collapsing shell (c).

FIG. 2. The structure of Stokes lines for the potential with two turning points z_0 and z_1 .

FIG. 3. The real section of the Riemannian surface S_F is a cross naturally identified with the configuration space of classical dynamical system.

FIG. 4. The Stokes lines on S_F near the turning points ρ_1 and ρ_2 .

FIG. 5. The Stokes lines near the singular points $\rho = \infty$ in S_{\pm} .

FIG. 6. The Stokes lines in the vicinity of the horizon $\rho = 1$ and near the singularity $\rho = 0$.

FIG. 7. The global structure of Stokes lines on the Riemannian surface S_F .

FIG. 8. Functions defining the mass spectrum.

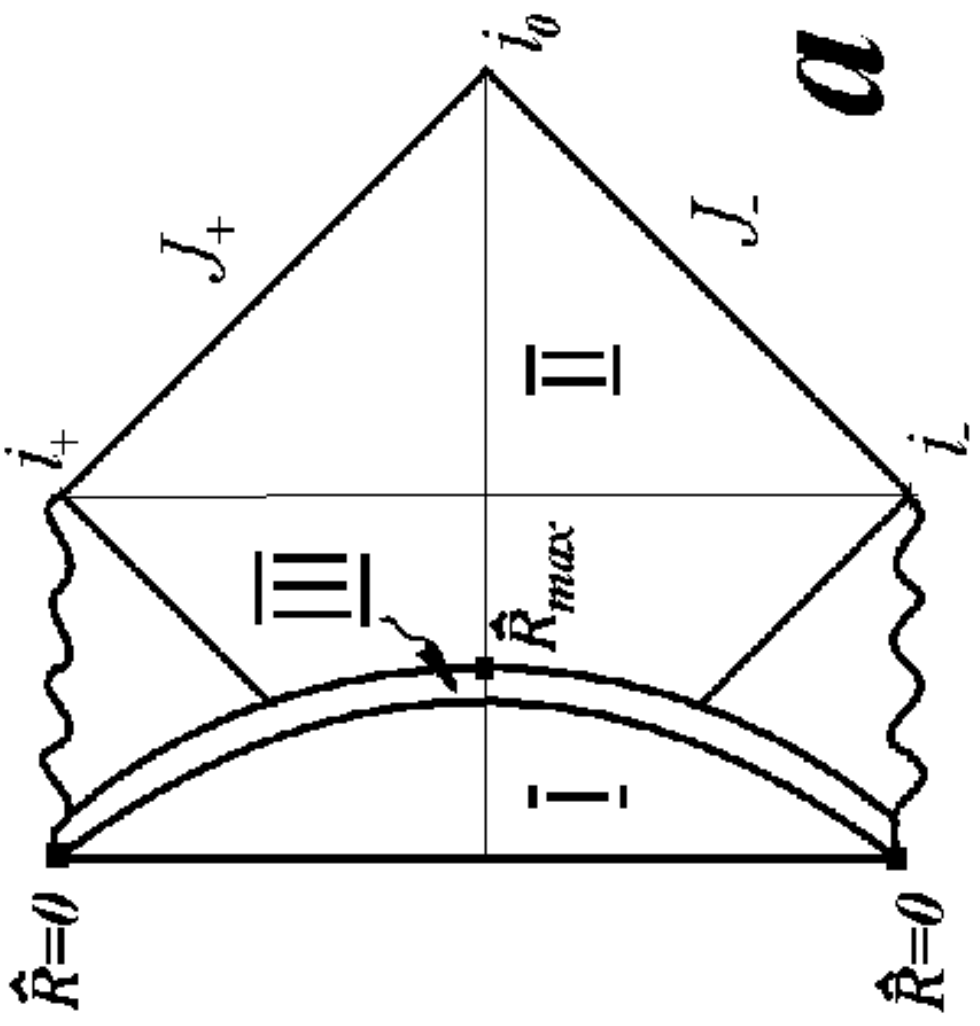

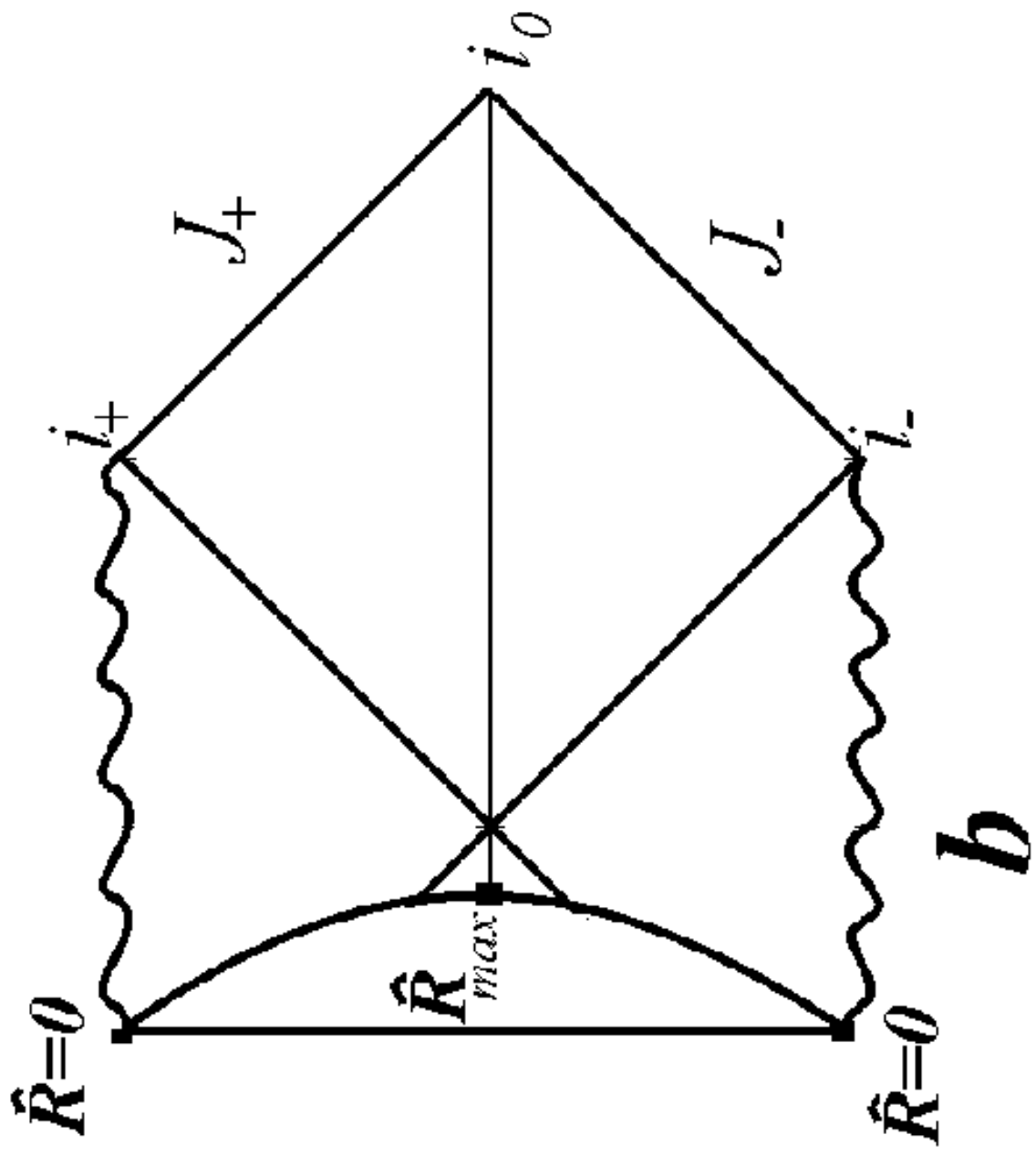

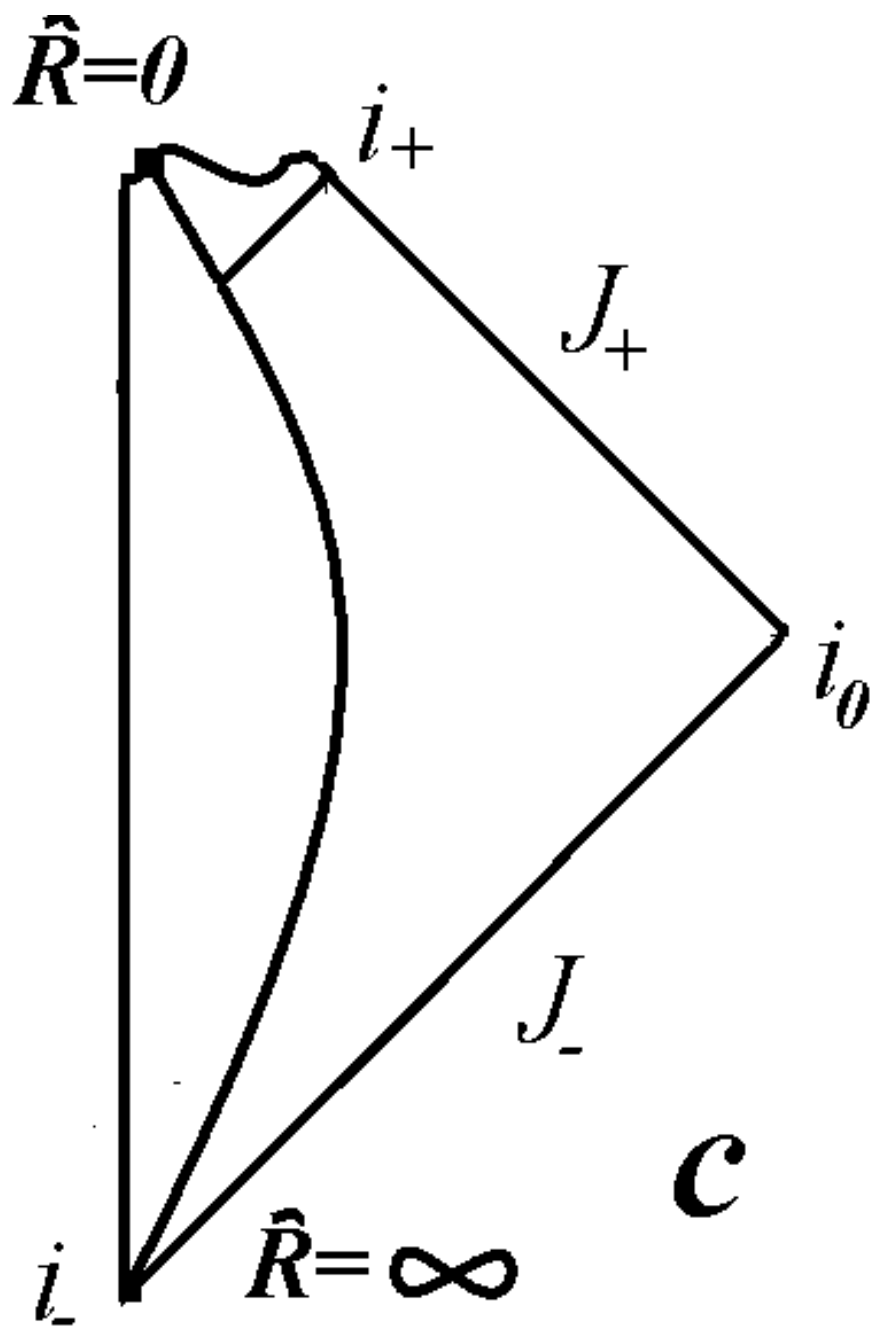

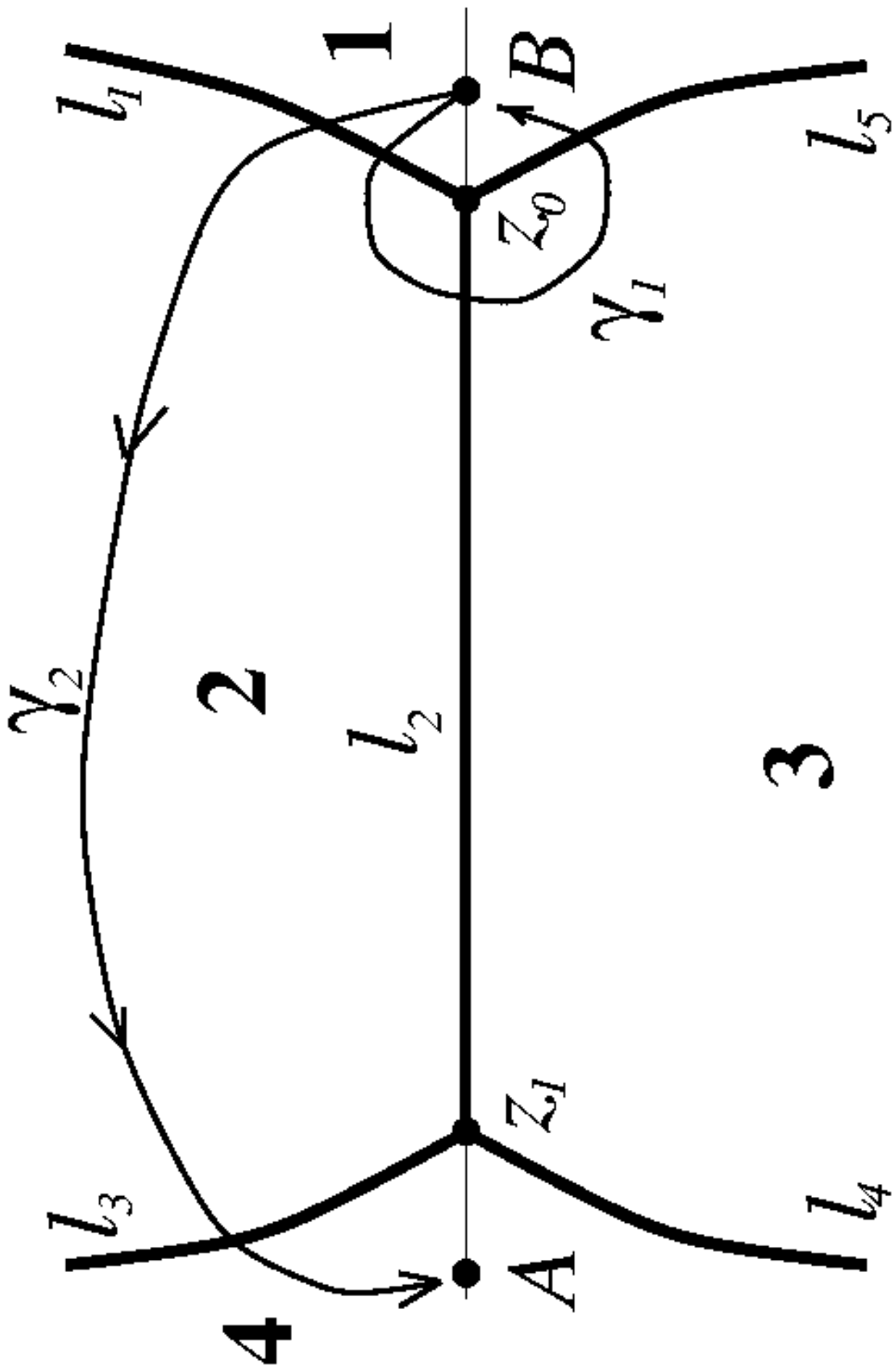

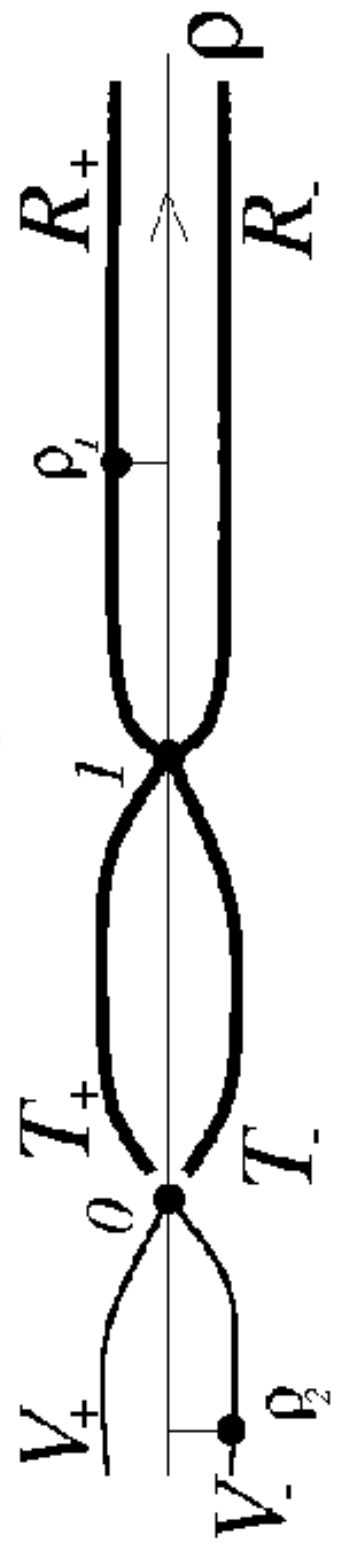
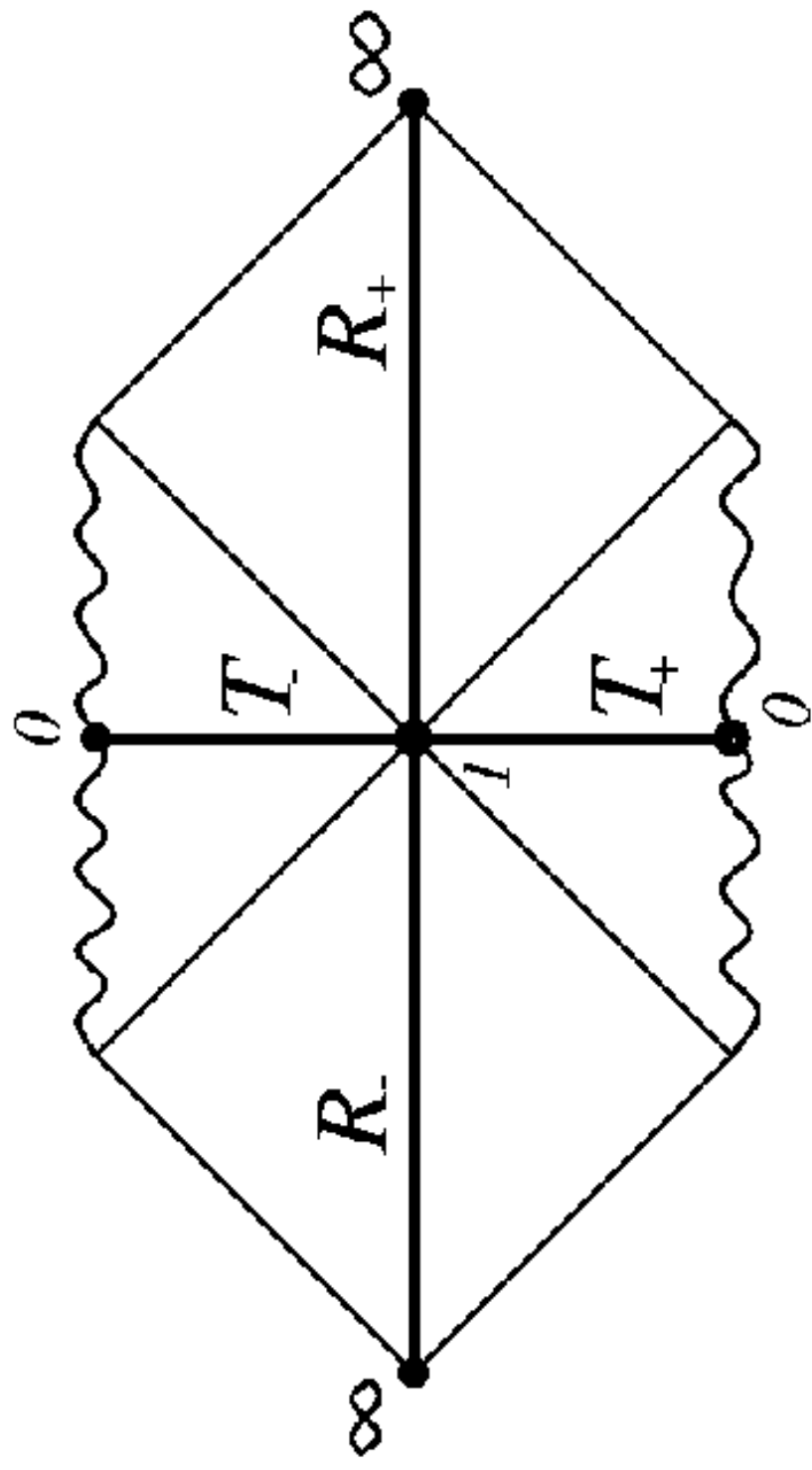

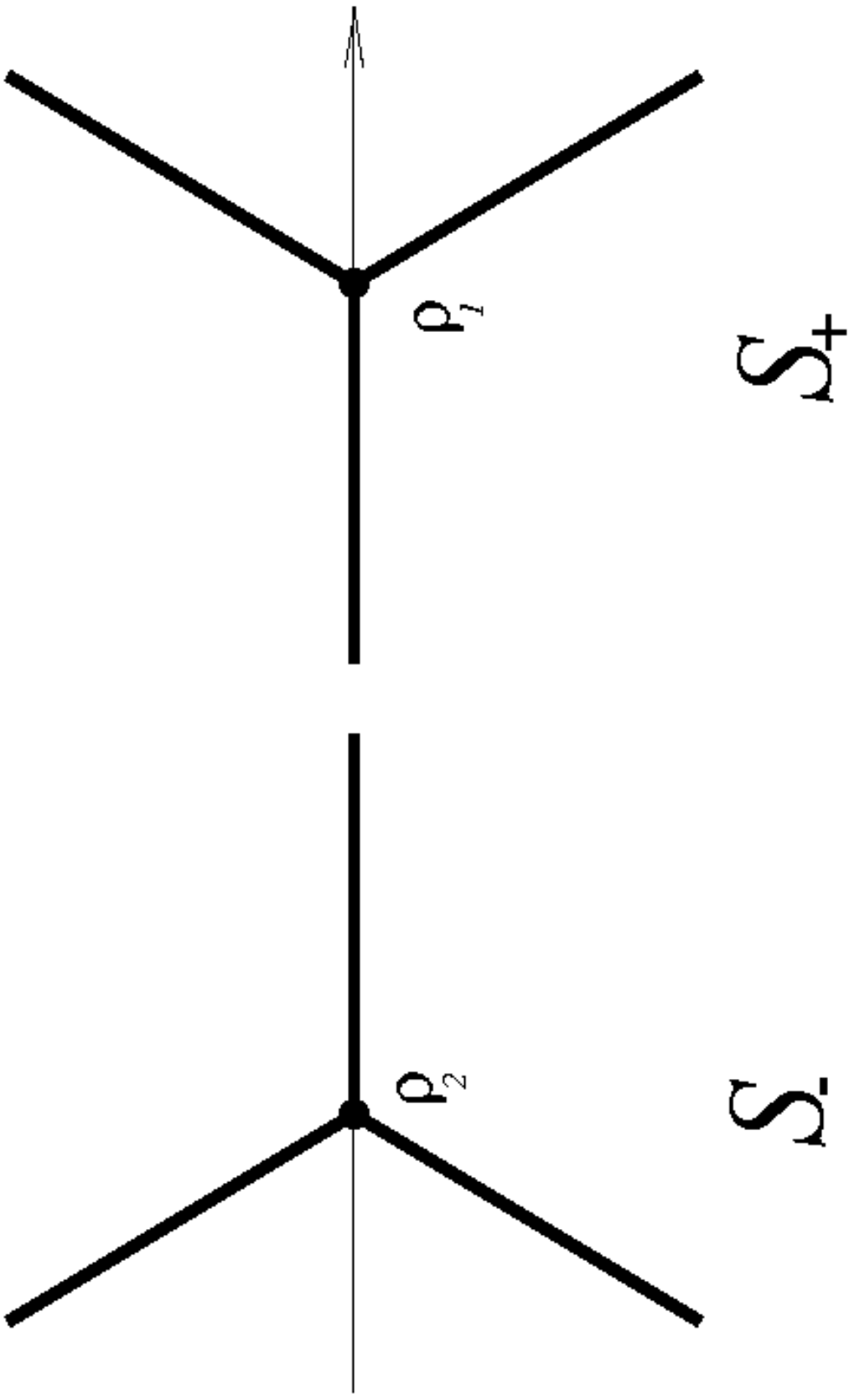

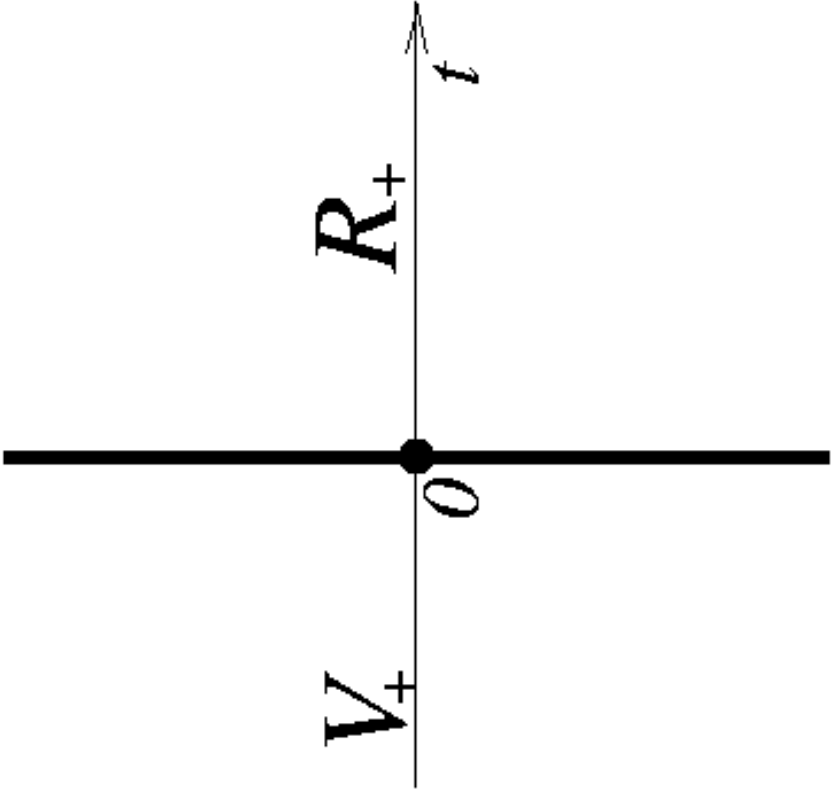

S_+

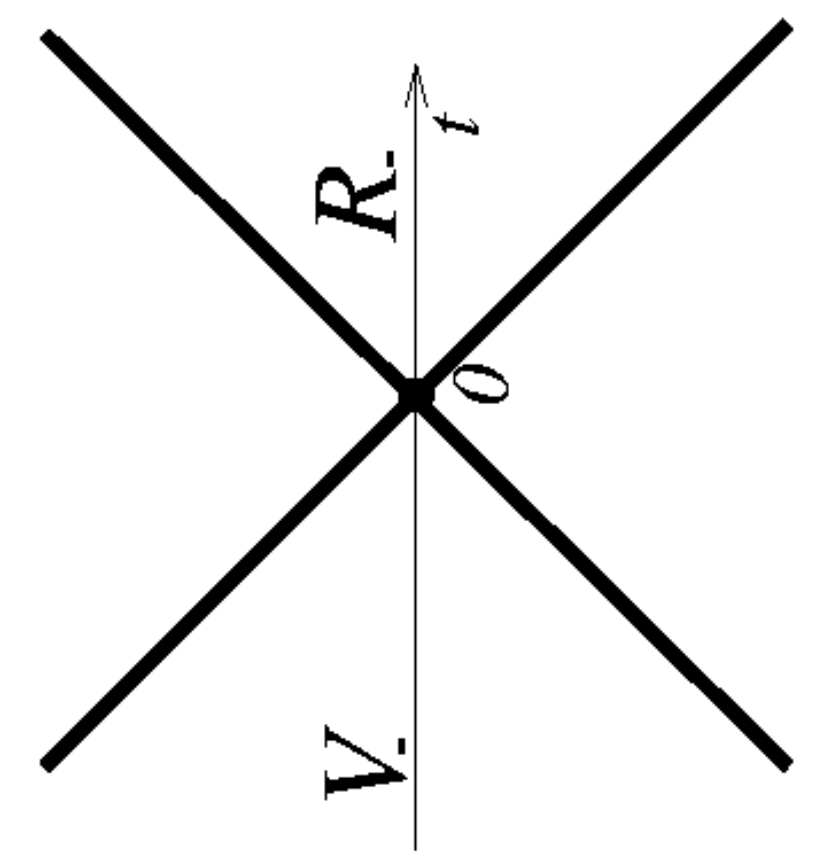

S_-

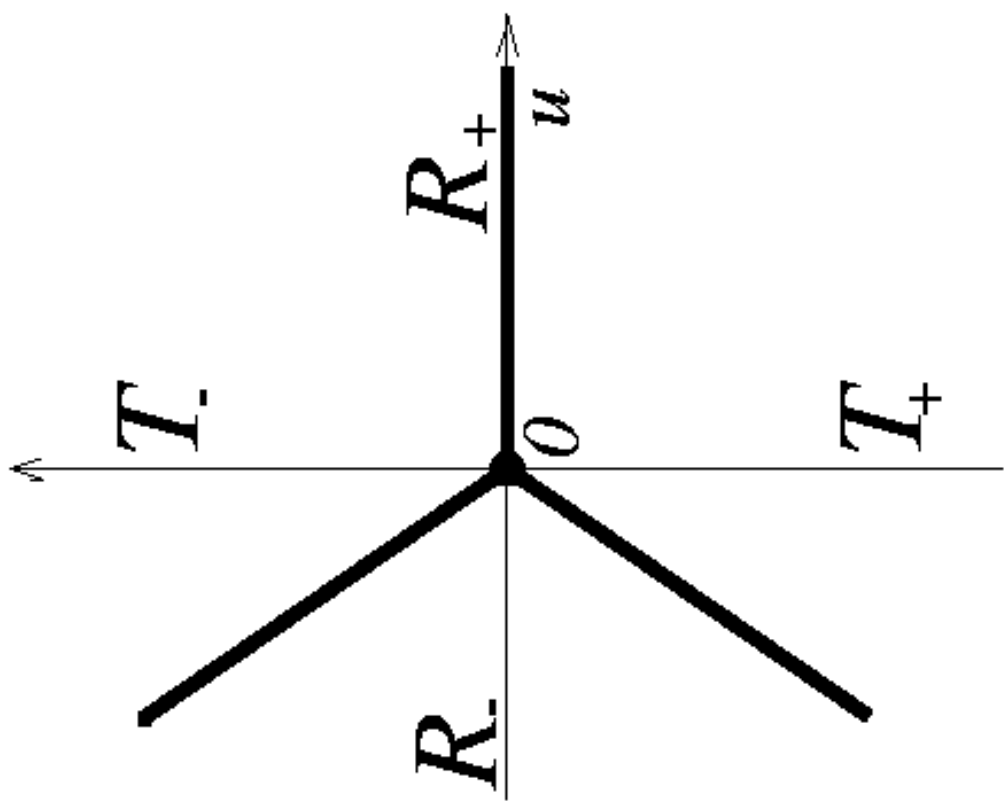
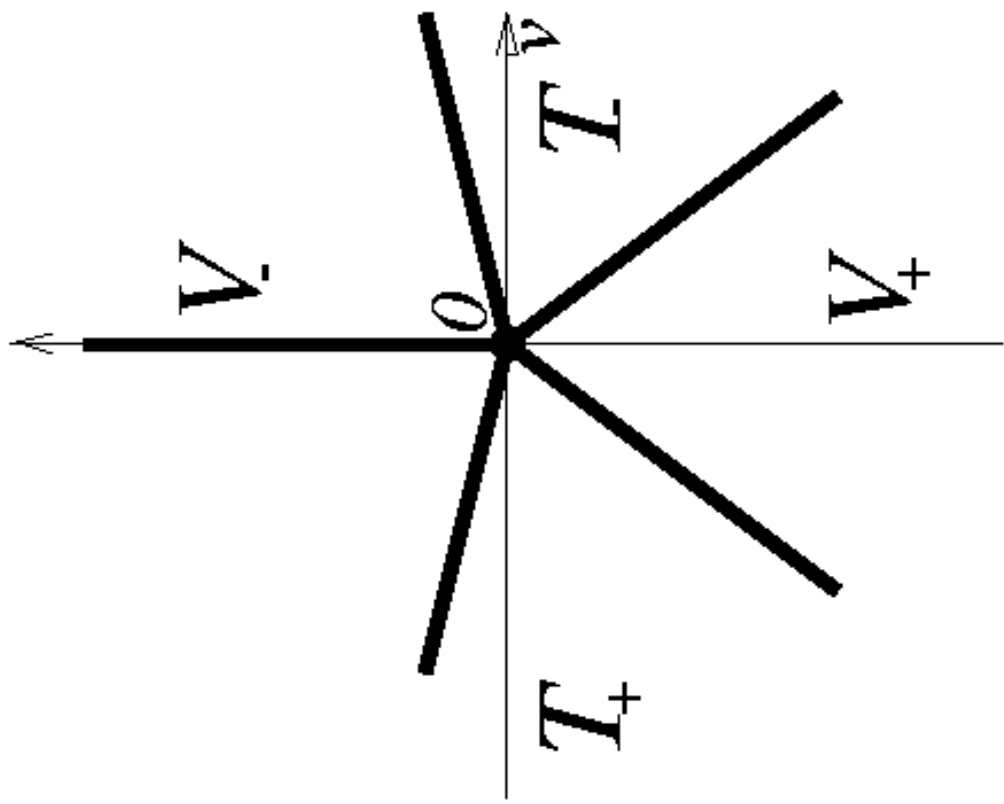

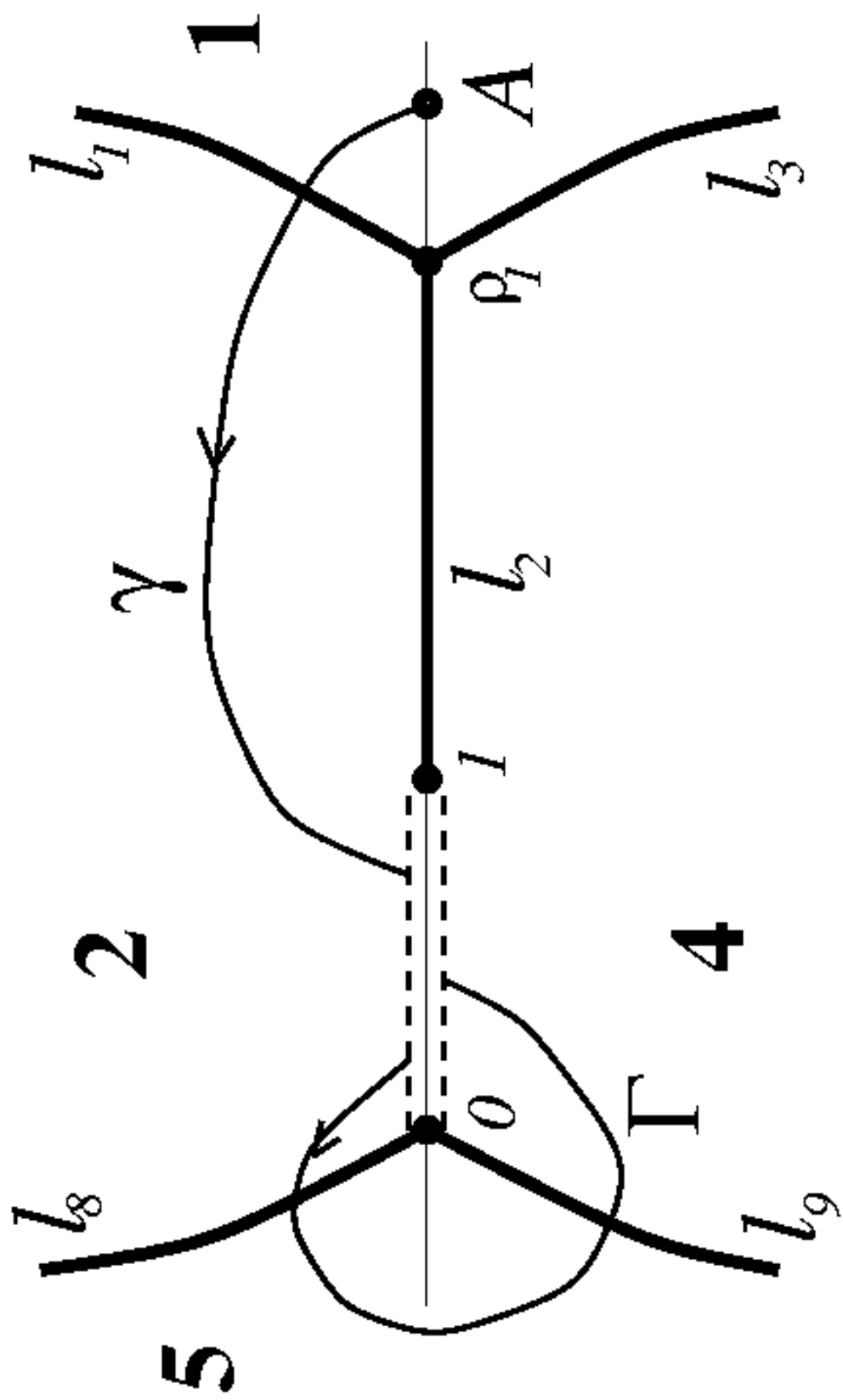

S_+

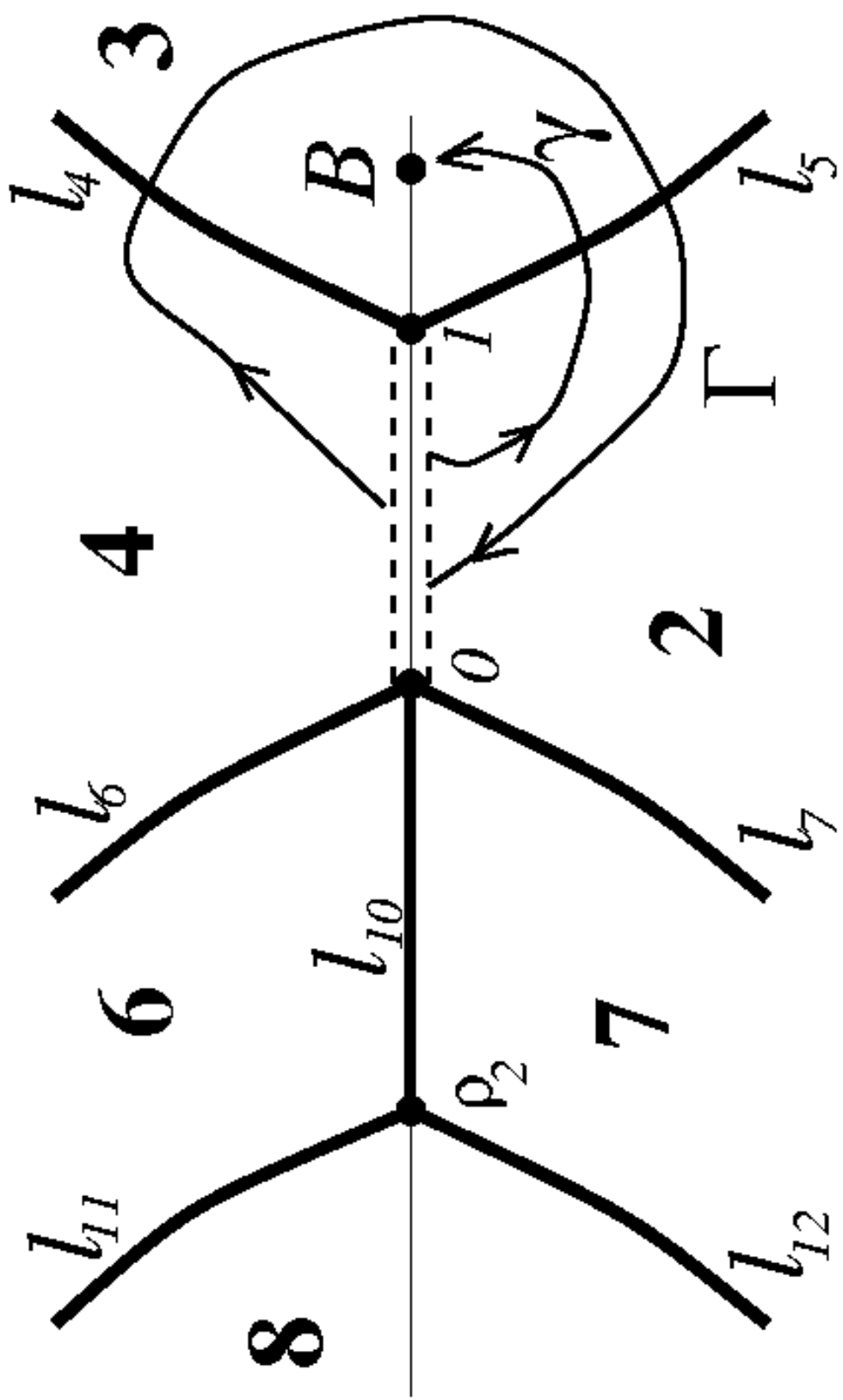

S_1

