

A Principled Solution to the Disjunction Problem of Diagrammatic Query Representations

WOLFGANG GATTERBAUER,  Northeastern University, USA

Finding unambiguous diagrammatic representations for first-order logical formulas and relational queries with arbitrarily nested disjunctions has been a surprisingly long-standing unsolved problem. We refer to this problem as *the disjunction problem* (of diagrammatic query representations).

This work solves the disjunction problem. Our solution unifies, generalizes, and overcomes the shortcomings of prior approaches for disjunctions. It extends the recently proposed Relational Diagrams and is identical for disjunction-free queries. However, it can preserve the relational patterns and the safety for all well-formed Tuple Relational Calculus (TRC) queries, even with arbitrary disjunctions. Additionally, its size is proportional to the original TRC query and can thus be exponentially more succinct than Relational Diagrams.

1 Introduction

The goal of query visualization is to transform a relational query into a visual representation that helps a user quickly understand the intent of a query [33]. While there is a very long history of visual query languages [12, 31], a problem that remains unsolved to this day is the question of how to “truthfully” represent any logical disjunction in a graphical language. Just like conjunction, disjunction is a fundamental logical operator to combine logical statements, but it is far harder to represent graphically. We call this *the disjunction problem* (of visual query representations).

The problem has vexed researchers for centuries, even for basic First-Order Logic (FOL).¹ Pierce mentions the problem already in 1896 in his influential work on Venn diagrams: “It is only disjunctions of conjunctions that cause some inconvenience” [53, Paragraph 4.365]. Gardner in his 1958 book ‘Logic Machines and Diagrams’ [28] discusses the challenging disjunction $(A \vee B) \rightarrow (C \vee D)$ and concludes that “there seems to be no simple way in which the statement, as it stands, can be diagrammed” [28, Section 4.3]. Shin in her work on the logic of diagrams writes “any form of representation for disjunctive information—whether a sign is introduced or not—is bound to be symbolic” [61, Ch. 3.2]. Englebretsen [26] in his review of Shin’s 1995 book [60] writes: “In her discussion of perception she shows that disjunctive information is not representable in any system.” Thalheim states [68, 69] that “There is no simple way to represent Boolean formulas” and gives a challenging example that is identical to Fig. 1a up to renaming of constants): $R.A = 1 \vee R.B = 2 \vee (R.C = 3 \wedge R.D = 4)$. Gatterbauer in his tutorial on visual query representations [31] lists several open problems and includes Fig. 1b as challenge: $(R.A = S.A \wedge R.B = 0) \vee (R.B = 1 \wedge R.C = 2)$. A recent paper [32] states in its conclusions that “it is not clear how to achieve an intuitive and principled diagrammatic representation for arbitrary nestings of disjunctions, such as $R.A < S.E \wedge (R.B < S.F \vee R.C < S.G)$ or $(R.A > 0 \wedge R.A < 10) \vee (R.A > 20 \wedge R.A < 30)$ ”.

Our contribution. We give a principled solution to the disjunction problem that *unifies, generalizes, and overcomes the shortcomings* of the 3 main prior graphical approaches for disjunction. Our solution, called RepresentationB, is a diagrammatic representation of well-formed Tuple Relational Calculus (TRC) that preserves the relational pattern (and a 1-to-1 correspondence with the atoms) and the safety of a query.² It is heavily inspired by Relational Diagrams [32] which was shown to help users understand queries faster and more accurately than SQL in a randomized user study.

¹FOL is basically the same as Relational Calculus and thus equivalent in expressiveness to relationally complete languages.

²Safety is a syntactic criterion that guarantees that the query is domain-independent and thus always returns finitely many answers [71]. See Section 3.2 for details. “Same pattern” is a semantic notion and means (slightly simplified) that the representation uses the set of relation variables. See Section 2.2 for details.

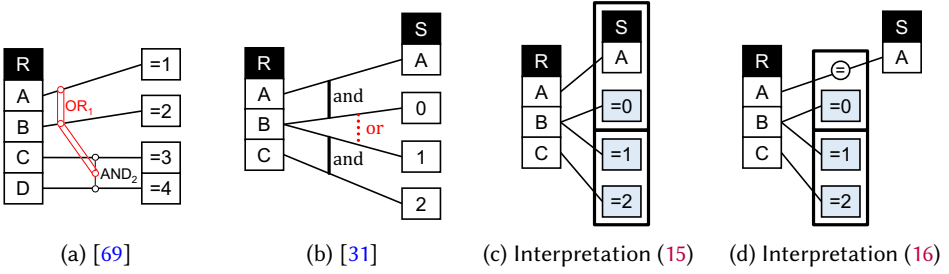

Fig. 1. (a, b): Two previously proposed approaches for representing disjunctions via edges (see text). The approaches are incomplete as they leave details of quantification ambiguous and require symbolic annotations to determine precedence of operators. (c,d): Our solution RepresentationB has precise semantics and can pattern-represent any well-formed TRC query (their interpretation is given in [Appendix E.3](#)).

However, it generalizes Relational Diagrams: it is identical for disjunction-free queries, yet it is more general and can be exponentially more concise. It also preserves the safety conditions of TRC and it is the first to achieve 100% pattern coverage on a recently proposed textbook benchmark.

Our approach in a nutshell. We proceed in two steps: **1** We first give a rigorously defined representation that *replaces join and selection predicates with built-in relations* and that uses DeMorgan to replace disjunctions. This approach solves the disjunction problem (because it gives “anchors” to predicates defined *in arbitrary nestings*) but results in a cluttered representation that loses the safety conditions of TRC. **2** We then substitute the built-in relations with prior visual formalisms (while keeping the formal semantics of built-in relations) and add a box-based visual shortcut for disjunction that brings back the safety conditions. Our definition of boxes allows disjunctions *at any nesting level*, while prior box-based approaches restrict disjunctions to be at the root.

Outline. [Section 2](#) defines our problem and classifies prior approaches for representing disjunctions. [Section 3](#) develops our notation for Tuple Relational Calculus (TRC), its safety conditions, and the notion of pattern expressiveness based on an Abstract Syntax Tree (AST) representation of TRC. These ASTs are in a 1-to-1 correspondence to our later introduced diagrammatic representations. [Section 4](#) gives our preliminary solution to the disjunction problem. It relies upon *built-in relations* that represent constants and built-in predicates, and a DeMorgan-based transformation of TRC. While complete, it is practically unsatisfying due to its visual clutter and the fact that it cannot preserve the safety conditions of TRC. [Section 5](#) replaces the built-in relations with prior proposed visual formalisms, yet keeps our rigorous and principled semantics. It reintroduces a visual symbol for disjunction called “*DeMorgan-fuse box*”, which allows us to check safety of a query. This addition leads to RepresentationB. [Section 6](#) shows how our fuse boxes unify and generalize prior approaches for disjunction, presents our solutions to the challenging queries from the introduction, and justify our perceptual choices. [Section 7](#) shows 100% pattern coverage over a test set made available by the authors of Relational Diagrams. The optional appendix includes many details, proofs, and illustrating examples.

2 Background and Related Work on Diagrammatic Query Representations

We discuss diagrammatic (visual) query representations, define notions of a *logical diagram* and *relational patterns*, and classify prior approaches for representing disjunctions.

2.1 Diagrammatic vs. Textual Representations

We use the notion of a *diagrammatic representation* synonymously with one that is visual, graphical, or non-symbolic (in contrast to *textual* or symbolic), and define logical diagrams as follows:

Definition 1 (Logical Diagram). A logical diagram is a graphical representation of a logical formula in which the topological relationships between its elements represent logical relationships between the elements of the formula.

Topological relationships are spatial relations that remain invariant under continuous deformations, such as connectivity, containment, and adjacency. Intuitively, in order for a representation to be called diagrammatic, it needs to show joins (i.e. the relationships between tables) as edges between the respective table attributes, and it cannot contain non-atomic logical sentences that require symbolic interpretation of logical connectives, such as “ $A = 1 \vee A = 2$ ”. Our definition captures the essence of many prior definitions of diagrams. We give examples: “*Diagram: a simplified drawing showing the appearance, structure, or workings of something; a schematic representation*” [43]. “*Diagram: a graphic design that explains rather than represents; especially: a drawing that shows arrangement and relations (as of parts)*” [48]. “*The relationships established between two sets of elements constitute a diagram*” [9, p. 129]. “*Logic diagram: a two-dimensional geometric figure with spatial relations that are isomorphic with the structure of a logical statement*” [28, p. 28].

Notice that while the relationships between elements are captured diagrammatically, the elements themselves are still represented as text. This is because relation names and attribute names do not constitute relational information themselves. For example, the string “Sailor” is still used to represent the name of a relation called “Sailor” (instead of an icon with domain-specific interpretation) and similarly with an attribute named “name”, however the fact that “Sailor” is the name of a relation, and the fact that “name” is one of its attributes constitute relationships. This separation of information carried by individual elements via text from relational information that can be read of diagrammatically is a key motivation of diagrammatic representations and visualizations in general. See for example Scott McCloud’s influential work on understanding comics [47] that shows that using text to convey part of the information frees up the image to focus on other content, and vice versa. In the case of diagrams, it is the topology that focuses on the relations between elements rather than the individual elements themselves. See also, Hearst’s recent discussion [38] of the complex interactions when combining text with visualizations and many references therein.

2.1.1 Constitutive vs. enabling features. De Toffoli [70] distinguishes between *constitutive* and *enabling* features of a notational system. The former have precise mathematical meaning and are essential to interpret the notation correctly (e.g. topological relationships). The latter facilitate interpretation but are not essential (e.g. colors or relative sizes). We find this distinction helpful and use it when occasionally discussing enabling (non-essential) features of our diagrammatic representation. Similar distinctions were made many times throughout history, e.g. by Manders [46] who contrasts “co-exact” attributes of a diagram (in essence, topological attributes) from “exact” attributes (geometric attributes that are unstable under perturbations, like size and shape).

2.2 Relational Patterns and the Disjunction Problem

Our goal is to find an unambiguous diagrammatic representation of a logical formula that can preserve “the structure” of arbitrary disjunctions. To properly formalize this problem, we build upon a recent definition of *the relational pattern* of a query [32]. Call the signature \mathcal{S} of a query q the set of all its *relation variables* (i.e. all the quantified references to some input table).³ Then treat each relation variable in the signature \mathcal{S} of a query q as a reference to a distinct relation value

³The word *relation variables* (and its abbreviation *relvars*) was popularized by Date and Darwen [20, 21] to distinguish between a reference to an input table (e.g., “ r ” in the TRC expression “ $\exists r \in R$ ”) and an actual instance of a relation (e.g., a concrete instance of R) which they call a *relation value*. The difference is crucial for queries with repeated references to the same table, e.g. conjunctive queries with self-joins. We also refer to relation variables as *table references*.

(i.e. a fresh input table) and call the resulting query the *dissociated query* q' over the *dissociated signature* S' . Finally define the logical function defined by q' as the relational pattern of q :

Definition 2 (Relational pattern [32]). Given a query q with signature S . The *relational pattern* of q is the logical function defined by its dissociated query $q'(S')$.

The intuition behind this formalism is that the dissociated query defines a function that maps the relation values represented by a set of relation variables (not just a set of input tables) to an output table (an output relation value). Thus, the dissociated query is a semantic definition of a relational query pattern that can be applied to any relational query language and that can be used to compare the relative pattern expressiveness of different languages. Two logically equivalent relational queries q_1 and q_2 then use the same relational pattern (they are *pattern-isomorphic*) if their dissociated queries are also logically equivalent, up to renaming and reordering of their relation variables (i.e. there is a mapping between the relation variables of their dissociated queries that preserves logical equivalence). In other words, q_2 is a *pattern-isomorphic* representation of q_1 .

This formalism allows us to give a precise definition of our problem:

Definition 3 (Disjunction problem). The disjunction problem (of diagrammatic query representation) is the problem of finding a pattern-isomorphic diagrammatic representation for any First-Order Logic (FOL) formula, and unambiguous translations back and forth.

2.3 The safety problem of DeMorgan-based representations

An additional challenge for diagrammatic representations is that the safety of relational queries is defined via syntactic criteria. A simple transformation of a safe formula via a DeMorgan (which alone cannot solve the disjunction problem) may lead to an unsafe formula.

EXAMPLE 1 (UNION OF QUERIES). Consider two unary tables $R(A)$ and $S(A)$ and the TRC query:

$$\{q(A) \mid \exists r \in R[q.A=r.A] \vee \exists s \in S[q.A=s.A]\} \quad (1)$$

This query expresses the union of the two tables and is safe according to any safety definition we know of (including Ullman's [73, Section 3.9], see also Section 3.2). We can remove the disjunction by using DeMorgan, however, the resulting query is now unsafe due to the outer \neg operator:

$$\{q(A) \mid \neg(\neg(\exists r \in R[q.A=r.A]) \wedge \neg(\exists s \in S[q.A=s.A]))\}$$

The consequence is that if a diagrammatic representation should convey preserve the safety of a formula, then it requires a visual device for disjunction that goes beyond DeMorgan.

Definition 4 (Safety problem). The safety problem (of diagrammatic query representation) is the problem of finding a diagrammatic representation of FOL formulas that preserves their safety.

2.4 Existing Visual query representations and diagrammatic reasoning systems

Visual query languages for writing queries have been investigated since the early days of databases and a 1997 survey [12] has already over 150 references, with examples such as Query-By-Example (QBE) [77] and Query By Diagram (QBD) [5, 13]. Around the same time, Ioannidis [41] lamented that most visual database interfaces were “ad hoc solutions” and that “there are several hard research problems regarding complex querying and visualization that are currently open.” Today, many commercial and open-source database systems have rudimentary graphical SQL editors, such as SQL Server Management Studio (SSMS) [65], Active Query Builder [4], QueryScope from SQLdep [55], MS Access [49], and PostgreSQL's pgAdmin3 [54]. Also, new direct manipulation visual interfaces are being developed, such as DataPlay [2, 3] and SIEUFERD [7]. More recently,

visual query representations have been proposed for the inverse functionality of understanding queries, with notable examples VisualSQL [42], QueryVis [19, 45], and SQLVis [50].

Seemingly disconnected from these developments, the diagrammatic reasoning community [22, 36, 39] studies diagrammatic representations that have sound and complete inference rules. Most noteworthy is Shin’s influential work [60] that proves that a slight modification of Venn-Peirce diagrams (see [Appendix A.3](#)) constitutes a sound and complete diagrammatic reasoning system for monadic FOL. Many variants of diagrammatic reasoning systems have since been proposed at the annual Diagrams conference [44]. However neither of these proposals can represent general polyadic predicates (the maximum are dyadic relations [67, Table 1]), many of them are either not sound or not complete ([67, Table 2]), and neither of them allow pattern-isomorphic representations, even for the fragments of logic they cover (most often, they can’t handle arbitrary disjunctions).

Recent VLDB and ICDE tutorials [30, 31] surveyed diagrammatic representations within and outside the database community and listed diagrammatic representations of disjunction as open problem, which motivated our work.

2.4.1 Relational Diagrams. Relational Diagrams [32] are a relationally complete and unambiguous diagrammatic representation of safe Tuple Relational Calculus (TRC). It uses UML notation for tables and their attributes and represents negation scopes with hierarchically nested dashed rounded rectangles that partition the canvas into zones (compartments). Join predicates are shown with directed arrows and labels on the edges (an important detail for us later). The authors validate their design in a randomized user study showing that users understand queries faster and more accurately with Relational Diagrams than SQL. However, that representation (like all prior diagrammatic representations we know of) cannot faithfully represent relational patterns involving disjunctions. Disjunctions require them to duplicate binding atoms (i.e. add fresh relation variables) and to thus change the relational pattern (see e.g. [Example 10](#)).

We draw a lot of inspiration from that work, yet develop a diagrammatic representation called RepresentationB that can represent *all relational patterns of TRC* (i.e. it is *pattern-complete* for TRC). In addition, our solution is backward compatible with Relational Diagrams (every Relational Diagram has an identical representation as RepresentationB, but not vice versa). Interestingly, we achieve this generalization by mostly redefining existing visual notations and giving them a stricter semantic interpretation. Our representation does not only preserve the table signature (the relation variables), but also the join and selection predicates, and thus all atoms from a given TRC query.

2.5 The challenge of disjunctions and prior (incomplete) approaches

We summarize here 5 conceptual approaches for representing disjunctions that we found throughout the literature. We illustrate with query $\exists r \in R[r.A=1 \vee r.A=2]$ and use a standardized and often simplified notation that focuses on the key visual elements. For the interested reader, [Appendix A](#) contains the original figures that led us to this classification.

2.5.1 Text-based disjunctions. Logical formulas can always be represented as text ([Fig. 2a](#)). This approach is not diagrammatic and we list it only for completeness. Example uses are the condition boxes by QBE [77] and handling of simple disjunctions by Dataplay [3].

2.5.2 (Vertical) form-based disjunctions. QBE [77] allows filling out two separate rows with alternative information ([Fig. 2b](#)). Recent visual query representations such as SQLVis [50] adopt this approach for simple disjunctions, such as our running example. However, this formalism does not allow disjunctions between join predicates and selection predicates (e.g., $\exists r \in R[r.A=1 \vee \exists s \in S[r.A=s.A]]$) or nested disjunctions. Datalog [14] expresses disjunctions with repeated rules, and each rule with a new relation variable, and thus not preserving the pattern: $Q :- R(1).Q :- R(2)$.

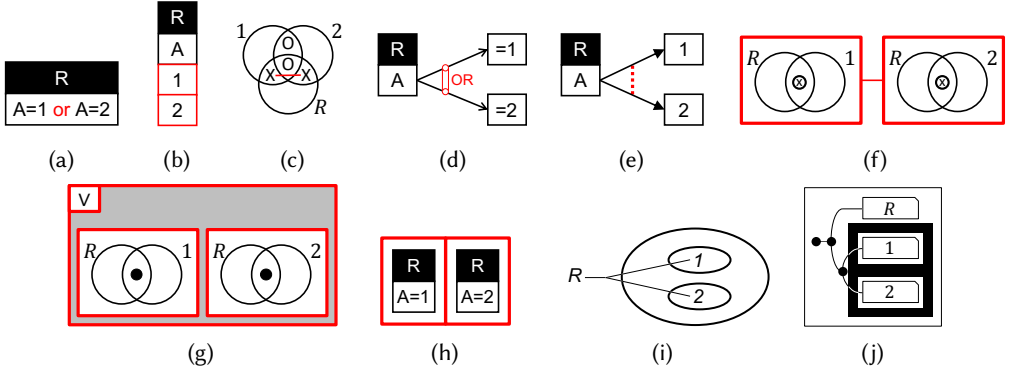

Fig. 2. Section 2.5: This summary shows 5 conceptual approaches for representing disjunctions applied to the deceptively simple problem of representing $R.A=1 \vee R.A=2$: text-based (a), form-based (b), edge-based (c-e), box-based (f-h), and DeMorgan-based (i,j).

2.5.3 Edge-based disjunctions. Around 1896, Charles Sanders Peirce [53] extended Venn diagrams [74] with edges between "O" and "X" markers to express disjunctions. An "O" means the partition is empty (false). An "X" means there is at least one member (true). A line between two markers means that at least one of these statements is true (Fig. 2c). Connecting disjunctive predicates via lines of various forms was suggested repeatedly, e.g. by VQL [51], VisualSQL [42] (Fig. 2d), and QueryViz [19] (Fig. 2e). Edges were mostly used for disjunctive filters within the same table and cannot represent complicated more formulas, such as (15) and (16) discussed in Appendix E.3.

2.5.4 Box-based disjunctions. Peirce proposed another solution to disjunctions [53]: He put unitary Venn diagrams into rectangular boxes and interpreted adjacent boxes as alternatives, i.e. disjuncts. Shin [60] adds back lines between boxes (Fig. 2f).⁴ Spider diagrams [40] remove the lines between boxes and place them in a larger "box template" with explicit \vee labels (Fig. 2g). Relational Diagrams [32] represent a union of queries via adjacent "union cells" (Fig. 2h). All of these prior box-based approaches represent disjunctions as unions of well-formed diagrams. Ours is the first to allow and give a well-defined semantics to disjunction of logical expressions *within diagrams*.

2.5.5 DeMorgan-based disjunctions. We use the term for representations that use only symbols for negation and conjunction, and apply negation in a nested way in accordance with the logical identity $A \vee B = \neg(\neg A \wedge \neg B)$. Peirce's beta existential graphs [53] use closed curves to express negation and juxtaposition for conjunctions (Fig. 2i). String diagrams [10, 37] are a variant that represent bound variables by a dot at the end of lines (Fig. 2j). We will show that DeMorgan-based disjunctions alone cannot recover the standard safety conditions of relational calculus.

3 Formal setup on Tuple Relational Calculus (TRC)

We give a succinct and necessary background on TRC. Appendix B provides a far more detailed discussion of how our formalism for TRC and the formal safety conditions compare to prior work.

3.1 Tuple Relational Calculus (TRC)

Our key claim is that our representation has a natural and pattern-preserving mapping from *any* safe TRC query. To prove this claim, we are extra careful in defining safe TRC. Our formalism is

⁴We slightly simplified here Shin's proposal. The conclusion is the same, and the appendix gives the full details.

heavily inspired by the sections on RC of several textbooks [1, 24, 56, 58, 62, 73], yet our notation is somewhat streamlined. **Example 2** gives an end-to-end example using our notations.

Well-formed TRC formulae. Given a relational vocabulary $\mathbf{R} = \{R_1, R_2, \dots\}$. A TRC formula can contain 3 types of *atoms*:

- (1) *Binding atoms* “ $r \in R$ ”, where r is a tuple variable and $R \in \mathbf{R}$ is a relation.
- (2) *Join predicates* “ $r.A \theta s.B$ ”, where r and s are tuple variables, A and B are attributes from r and s respectively, and θ is an arithmetic comparison operator from $\{<, \leq, =, \neq, >, \geq\}$.
- (3) *Selection predicates* “ $r.A \theta c$ ”, where r , A , and θ are defined as before, and c is a constant.

A (tuple) variable is said to be free unless it is bound by a quantifier (\exists, \forall). (Well-formed) formulas are built up inductively from atoms with the following 3 families of *formation rules*:

- (1) An atom is a formula.
- (2) If $\varphi_1, \varphi_2, \dots, \varphi_k$ are formulas, then so are $\neg(\varphi_1)$, $(\varphi_1 \rightarrow \varphi_2)$, $(\varphi_1 \vee \varphi_2 \vee \dots \vee \varphi_k)$, and $(\varphi_1 \wedge \varphi_2 \wedge \dots \wedge \varphi_k)$.
- (3) If φ is a formula and R_1, \dots, R_k are relations from \mathbf{R} , then $(\exists r_1 \in R_1, \dots, \exists r_k \in R_k [\varphi])$ and $(\forall r_1 \in R_1, \dots, \forall r_k \in R_k [\varphi])$ are also formulas.

We assume the usual operator precedence $(\neg) > (\wedge) > (\vee) > (\rightarrow) > (\exists, \forall)$ and can omit parentheses if this causes no ambiguity about the semantics of the formula. WLOG, no variable can be bound more than once, and no variable occurs both free and bound.

Well-formed TRC queries. A Boolean query (or sentence) is a formula without free variables. A non-Boolean query is an expression $\{q(\mathbf{H}) \mid \varphi\}$ where q is the only free variable of formula φ , and the *header* $\mathbf{H} = (A_1, \dots, A_k)$ is its schema, i.e. the list of attributes (or components) of q that appear in predicates of φ . The set builder notation defines the set of tuples that makes φ true.

Abstract Syntax Tree (AST). The Abstract Syntax Tree (AST) of a TRC query is a tree-based representation that encodes a unique logical decomposition into subexpressions. It abstracts away certain syntactic details from the parse tree and gives a unique reversal of the inductively applied formation rules. *Atoms* form the leaves (inputs). Inner nodes (gates) belong to 3 families:

- (1) The root for non-Boolean queries $\{q(\mathbf{H}) \mid \varphi\}$ is formed by a *query* node. Its two children are *output* for the output relation $q(\mathbf{H})$ and *formula* for φ . The root of Boolean queries is formed by a *formula* node.
- (2) $\exists r_1 \in R_1, \dots, \exists r_k \in R_k [\varphi]$ and $\forall r_1 \in R_1, \dots, \forall r_k \in R_k [\varphi]$ are represented by \exists and \forall quantifier nodes, respectively. Their two children are *bindings* (with k binding atoms as grandchildren), and *formula* φ .
- (3) *Logical connectives* are nodes that have either one child (\neg), two children (\rightarrow), or $k \geq 2$ children (\wedge, \vee).

We require that no \neg is the child of another \neg node (we can always cancel double negations by $\neg\neg\varphi = \varphi$) and that the polyadic connectives (\wedge, \vee) to be “flattened” [1, Sect. 5.4], i.e. they can have more than 2 children, yet no child of an \wedge is another \wedge (analogously for \vee). Similarly, quantifier nodes (\exists, \forall) can’t have a quantifier node of the same type as a grandchild, i.e. a \exists quantifier node can’t have another \exists quantifier node as child of its formula child.

Maximally scoped TRC. We call TRC formula *maximally scoped* if no \exists quantifier node is the child of an \wedge node. This is WLOG, as existential quantifiers can always be pushed before an \wedge node, as in: $\exists r \in R[\varphi_1] \wedge \exists s \in S[\varphi_2] = \exists r \in R, \exists s \in S[\varphi_1 \wedge \varphi_2]$.

3.2 Safety of TRC

The idea of *safety* is to *syntactically restrict* the well-formed TRC queries s.t. (i) safe queries are guaranteed to be domain-independent (and thus have only finitely many answers), yet (ii) this

EXAMPLE 2. Consider the following safe non-Boolean TRC query:

$$\{q(A, B) \mid (q.A=0 \wedge (\exists r \in R[q.B=r.B] \vee q.B=1)) \vee (\exists r \in R[q.A=r.A \wedge q.B=r.B] \wedge \forall s \in S[\exists r_2 \in R[r.A=r_2.A \wedge r_2.B=s.B]])\}$$

The figure to the right shows its unique AST. Notice how the 4 safety conditions are fulfilled. In particular, the two child subformulas “ $\exists r \in R[q.B=r.B]$ ” and “ $q.B=1$ ” of the lower nested disjunction have both $q(B)$ as free variable. However, the child subformulas of the higher disjunction have both $q(A, B)$ as free variable.

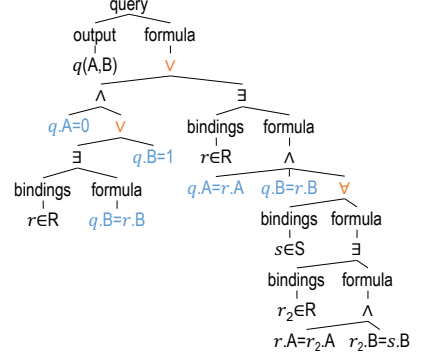

Fig. 3. Example 2: AST for TRC query with nested disjunctions.

subset can express all possible finite queries [71]. In the following, we refer to the subtree of the AST in which each node is connected to the root via a path that is not blocked by any negation (\neg), implication (\rightarrow), nor (\forall quantifier) as the *base partition* of the AST. Boolean queries (closed formulas) are by definition domain-independent and thus safe. We say that a non-Boolean TRC query $\{q(\mathbf{H}) \mid \varphi\}$ is safe if it is well-formed and the following 4 conditions hold on φ :

- (1) Every attribute A of the header \mathbf{H} is bound in φ to either (i) an attribute B of an existentially quantified table $\exists r \in R$ via an *equijoin predicate* $q.A=r.B$, or (ii) a constant c via an *equi-selection predicate* $q.A=c$. In both cases, we refer to the equality predicate as the *binding predicate* of $q.A$.
- (2) Every binding predicate is in the base partition of the AST.
- (3) If there is an \vee operator on the unique path from a binding predicate to the root node of the AST then all child subformulas of that \vee node have only one free tuple variable, and it is the same variable with the same attributes defined.
- (4) If there is no \vee operator on that path from a binding attribute involving a header attribute $q.A$ then the header attribute $q.A$ appears in no other predicate.

Call *base disjunction* any disjunction that appears in the base partition. Intuitively, these conditions ensure that safe TRC queries have an AST in which each output attribute is bound to exactly one existentially quantified table column (or a constant) in the base partition if, for all base disjunctions, all except for one subtree is removed. Figure 3 illustrates with a purposefully involved example.

4 A preliminary solution with built-in relations

This section develops an extension to Relational Diagrams that solves the disjunction problem and gives the resulting representation the same pattern expressiveness as TRC. The approach relies on “built-in relations” (i.e. unary and binary relations that are not part of the input schema and represent constant and built-in predicates). The approach is simple in that it does not require any novel visual syntactic devices (it uses even a smaller visual vocabulary than Relational Diagrams). However, it is practically unsatisfying due to its additional visual clutter, and the fact that it *cannot preserve the safety conditions* of TRC. We address these problems in the subsequent section.

Here, we first discuss two important fragments of TRC (Section 4.1), then discuss our idea of built-in relations (Section 4.2), before we prove it to be pattern-isomorphic to TRC (Section 4.3).

4.1 $\text{TRC}^{\neg\exists\wedge}$ is an atom-preserving fragment of TRC (but not safe TRC)

We first show that universal quantifiers \forall , material implications \rightarrow , and disjunctions can be replaced in TRC by using only the symbols for negation $\neg(\dots)$, existential quantification \exists , and conjunction \wedge *without changing the relational pattern*.⁵ While it is standard textbook knowledge that the connectives \neg, \wedge are truth-functionally complete [8, Sections 7.4], we show the slightly more general statement that we can preserve *all atoms* in the AST.

LEMMA 5. *Given a TRC formula φ with universal quantification, implication, or disjunction. Then there exists a logically equivalent TRC formula φ' that (i) is pattern equivalent to φ , (ii) does not use universal quantifiers, implications, or disjunction, (iii) uses the identical set of atoms, and (iv) can be found in a polynomial number of steps in the size of φ .*

We call “Existential-Negation-Conjunctive TRC” ($\text{TRC}^{\neg\exists\wedge}$) the resulting syntactic fragment of TRC that does not use the connectives \vee and \rightarrow , nor the universal quantifier \forall .⁶ We call “Existential-Negation TRC” ($\text{TRC}^{\neg\exists\vee}$) the variant of that syntactic fragment that allows disjunctions.

4.1.1 Comparison with the non-disjunctive fragment. The *non-disjunctive fragment* defined by the authors of Relational Diagrams [32], includes an extra condition requiring all predicates to be “guarded” (each predicate needs to contain a “local attribute” whose relation is quantified within the scope of the last negation). This condition leads to a reduction in logical expressiveness, which the authors fixed by adding a union operator and corresponding new visual element. It also leads to cases where expressing a query requires a *different relational signature*. This is in contrast to $\text{TRC}^{\neg\exists\vee}$ and $\text{TRC}^{\neg\exists\wedge}$ which are only syntactic restrictions of non-leaf nodes of the AST. **Example 10** in **Appendix C.2** contrasts example ASTs for $\text{TRC}^{\neg\exists\vee}$ and $\text{TRC}^{\neg\exists\wedge}$.

4.1.2 Safety is preserved by $\text{TRC}^{\neg\exists\vee}$, but not by $\text{TRC}^{\neg\exists\wedge}$. Recall that safety is a syntactic criterion, and applying DeMorgan can render a safe query unsafe and v.v. (recall **Example 1**). Thus removing disjunction from the vocabulary makes it impossible to represent all logical queries *while preserving safety*. It is easy to see that the safe query from **Example 1** cannot be expressed in $\text{TRC}^{\neg\exists\wedge}$ while maintaining safety: The output needs to be restricted to the union of $R(A)$ and $S(A)$. In the absence of disjunction \vee that can only be achieved with DeMorgan, which renders the resulting query unsafe since the output can’t be bound to any table column. In contrast, $\text{TRC}^{\neg\exists\vee}$ *preserves safety* since all transformations for removing \forall and \rightarrow from a safe TRC query must happen *outside the base partition* of its AST, and thus no binding predicate changes during the transformation.

4.2 Built-in relations reduce the visual vocabulary but extend the pattern expressiveness of Relational Diagrams

We next add unary and binary *built-in relations* to the vocabulary of Relational Diagrams and show that this addition enables the resulting visual representation to represent all patterns of TRC. The intuition is that these additional tables can serve as “anchors” for negation scopes and thus permit a direct translation from $\text{TRC}^{\neg\exists\wedge}$ to such extended Relational Diagrams.⁷ Furthermore, by expressing predicates as relations, we *do not have to introduce any new visual elements*. However, our representation loses the ability to encode safety (and becomes visually more complex). We fix both issues in the next section.

⁵This statement is not obvious. Take as an example the single connective NOR (\downarrow) which is also truth-functionally complete [8, Sections 7.4]. It is easy to see that NOR is *not pattern preserving*: $\neg(\varphi) = \varphi \downarrow \varphi$.

⁶We have consulted a long list of standard textbooks on logic [8, 25, 35], online resources, and LLMs, yet have not found a standardized, shorter, non-ambiguous terminology for this rather natural fragment, despite being often implicitly used.

⁷We call those relations “built-in” in reminiscences of “built-in predicates” like $<$ in SQL [73]. An alternative name we had considered is “anchor relations” as they give us anchors for negation and disjunction scopes.

4.2.1 Constants represented as unary built-in relations. For each constant c and each arithmetic comparison operator $\theta \in \{=, <, \leq, >, \geq, \neq\}$, we allow a new unary relation θc descriptively named “ θc ” that contains the subset of the (possibly infinite) domain that fulfills that condition. Each selection predicate “ $R.A \theta c$ ” is then represented as equijoins with a different occurrence of that relation.⁸ WLOG, we adopt Ullman’s notation [73] for the ordered, unnamed perspective and name the column \$1. **Figure 4a** shows the representation for the selection predicate “ $R.A < 4$ ”. Notice that our choice of blue background color for unary built-in relations is only “enabling” (Section 2.1.1).

4.2.2 Join predicates represented as binary built-in relations. For each arithmetic comparison operator $\theta \in \{=, <, \leq, >, \geq, \neq\}$, we allow a new binary relation θ descriptively named “ θ ” that contains the subset of the (possibly infinite) cross-product of the domain that fulfills that arithmetic comparison. Each join predicate “ $R.A \theta S.B$ ” is then represented as two equijoins of R and S with an instance of such a relation. We again adopt Ullman’s notation and name the columns \$1 and \$2, respectively. **Figure 4b** shows the representation for the join predicate “ $R.A < S.B$ ”. Notice that our choice of orange background color for binary built-in relations is again only “enabling”.

4.2.3 Correct placement of built-in relations. The placement of the labels for built-in predicates by Relational Diagrams is not important since they are interpreted as “labels” on the edges, and the correct interpretation is guaranteed by the “guard” of each predicate (i.e. the inner-most nested relations). This freedom gets restricted with built-in relations as we illustrate next.

EXAMPLE 3. Consider the two upper Relational Diagrams in Figs. 4a and 4b. According to [32], their interpretation is identical since the placement of the label \ominus does not affect its interpretation. Both are interpreted as “There exists a value in $R.A$ s.t. there is no value in $S.B$ that is bigger”, i.e.

$$\exists r \in R [\neg (\exists s \in S [r.A < s.B])] \quad (2)$$

Once we replace the built-in predicate $r.A < s.B$ with a built-in relation \ominus , the placement of that relation matters, as the two possible placements (bottom in Figs. 4a and 4b) are interpreted differently:

$$\exists r \in R [\neg (\exists s \in S, \exists j \in \ominus [r.A = j.\$1 \wedge j.\$2 = s.B])] \quad (3)$$

$$\exists r \in R, \exists j \in \ominus [\neg (\exists s \in S [r.A = j.\$1 \wedge j.\$2 = s.B])] \quad (4)$$

Query (3) is identical to (2), but query (4) states something far more permissive: “There exists a value in $R.A$ s.t. there exists a bigger value that is not in $S.B$ ”. For example, assume the database is $R(1)$ and $S(2)$. Then variant (3) is false (as expected), whereas variant (4) is true for the assignment: $R.A = \ominus.\$1 = 1$ and $\ominus.\$2 = 3$ (since the value 3 does not exist in $S.B$).

Achieving a correct translation (the expected interpretation) is straightforward: we place each built-in relation in exactly the negation scope that it appears in the TRC expression.

EXAMPLE 4 (EXAMPLE 3 CONTINUED). Our representation replaced the exact position of the join predicate with the built-in relation, which nests it in the correct negation scope:

$$\exists r \in R [\neg (\exists s \in S [\exists j \in \ominus [r.A = j.\$1 \wedge j.\$2 = s.B]])]$$

4.3 Relational Diagrams with built-in relations are pattern-complete for TRC

We are ready to state our first of two main results of this paper.

⁸When clear from the context, we write the table name instead of a table variable.

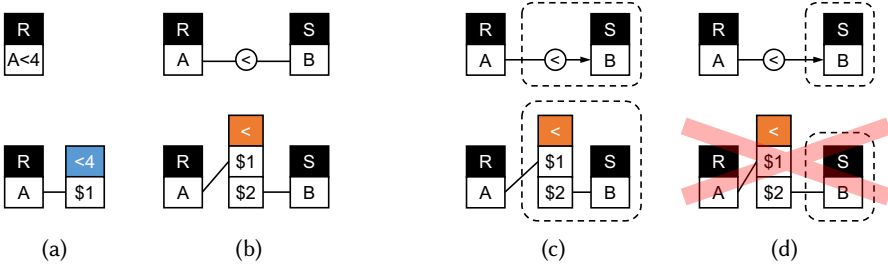

Fig. 4. Sections 4.2.1 and 4.2.2: (a) Unary (blue) and (b) binary (orange) “anchor relations” are added to the visual vocabulary of Relational Diagrams in order to give the resulting diagrammatic representation system the same pattern expressiveness as TRC. Section 4.2.3 (c), (d): the placement of operator labels does not matter for Relational Diagrams. However, it does make a difference when replacing the labels with new relations.

THEOREM 6 (FULL PATTERN EXPRESSIVENESS). *There is an algorithm that translates any well-formed TRC query into Relational Diagrams extended with built-in relations. That representation has an unambiguous logical interpretation (there is another algorithm that translates that diagram back into TRC) and has the same atoms as the original TRC query and thus has the same relational pattern.*

The proof uses constructive translations from TRC to Relational Diagrams with built-in relations and back that are pattern-preserving. We thus give a solution to the disjunction problem.

5 RepresentationB: a backward compatible solution without built-in relations

Our preliminary solution from the previous section solves the disjunction problem. However, it has arguably two important problems: (1) We lost the ability to use standard syntactic safety conditions to determine whether a query is domain-independent. (2) The built-in relations and multiple nestings of negations increase the visual complexity and make the diagrams hard to read.⁹ The two solutions we introduce in this section are conceptually simple: Section 5.1 substitute the built-in relations with visual formalisms proposed in prior literature, yet keep our rigorous and principled semantics defined earlier (recall Fig. 4). Section 5.2 reintroduces disjunctions as (visual) shortcuts for our earlier rigorous semantics. The result is a precisely defined pattern-preserving diagrammatic representation for *any* TRC query that allows visual verification of the safety conditions and that specializes into Relational Diagrams for the fragment of disjunction-free TRC.

5.1 Substituting built-in relations

5.1.1 Simpler anchors for unary built-in relations. Unary built-in relations consist of two boxes: the predicate (condition) name (e.g. $\langle 4 \rangle$) and an attribute box $\$1$. We eliminate this unnecessary indirection¹⁰ and substitute both boxes with one box containing the condition (e.g. $\langle 4 \rangle$). We thereby also recover visual formalisms from prior proposals, such as VisualSQL [42] and VQL [51] (see Figs. 2d and 2e): a selection is an equijoin between an attribute and a condition (e.g. $\overline{A} - \langle 4 \rangle$). That condition still provides an anchor and could be in a deeper nesting than the table. We call this the “canonical” representation.

If the condition is in the same negation scope as the relation, then we apply a shortcut that fuses the two attributes and thereby recovers the selection formalism used by Relational Diagrams (e.g.

⁹There is a reason why we have the disjunction operator in logic and natural language although it is not strictly necessary. Citing from [8] on disjunctions: “...the fewer connectives we have, the harder it is to understand our sentences.”

¹⁰This is similar in spirit to Tufte’s recommendation to avoid legends if possible: “labels are placed (directly) on the graphic itself; no legend is required.” [72]

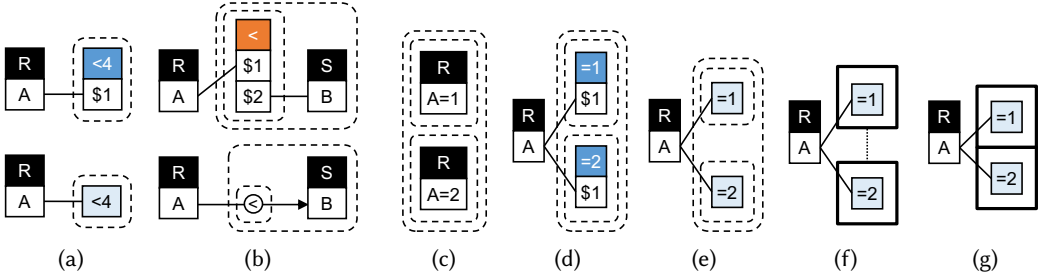

Fig. 5. **Example 5**(a-b): RepresentationB are at both the middle and bottom rows, Relational Diagrams at the bottom row, Relational Diagrams with built-in relations at the top row. **Example 6** (c-g): $\exists r \in R[r.A=1 \vee r.A=2]$: (c): Relational Diagrams. (d): Relational Diagrams with built-in relations. (e-g): RepresentationB. (f-g) show our *visual shortcut* for disjunctions, formally justified with what we refer to as “DeMorgan-fuse boxes”.

$A < 4$).¹¹ Our formalism is thus backward compatible to Relational Diagrams, yet also allows us to give the condition a separate “anchor”, which we need to express certain relational patterns.

5.1.2 Binary built-in relations. Binary built-in relations consist of three boxes: The predicate name (e.g. $<$) and two attributes connected to the respective relational attributes via equijoins. We substitute these built-in relations with the symbols that were originally used by Relational Diagrams as *labels* on directed edges (arrows) (e.g. \otimes). The important difference is that we treat the former *labels* now as *anchors* with the full semantic interpretation we developed in the last section (see e.g. Fig. 5b). This semantics allows us to explicitly place the anchor in a deeper nesting than either of the relations joined by that comparison predicate and thereby improve upon the limited pattern expressiveness of Relational Diagrams.

EXAMPLE 5 (SUBSTITUTING BUILT-IN RELATIONS). Consider the Boolean TRC query $\exists r \in R[\neg(r.A < 4)]$ shown in the lower row of Fig. 5a as RepresentationB. The top row shows Relational Diagrams with built-in relations which correspond to $\exists r \in R[\neg(\exists c \in \{<4\}[r.A=c.\$1])]$. Next, consider the Boolean query

$$\exists r \in R[\neg(\exists s \in S[\neg(r.A < S.B)])]$$

shown as RepresentationB on the bottom of Fig. 5b. The top shows Relational Diagrams with built-in relations which correspond to

$$\exists r \in R[\neg(\exists s \in S[\neg(\exists j \in \{<\}[r.A = j.\$1 \wedge j.\$2 = s.B])])]$$

5.2 Visual shortcut for disjunctions

As already mentioned earlier, frugality in primitive elements has downsides: The fewer connectives we have, the harder it is to understand our sentences. Despite negation and conjunction being truth-functionally complete, we regularly use disjunctions in logic and natural language. We next introduce a visual shortcut for disjunction that allows us to recover a checkable safety condition and that generalizes the various (incomplete) approaches for disjunctions we have seen in Section 2.5.

Our key idea is to *keep the formal semantics we have developed so far* (and that solves the disjunction problem), but to allow a visual shortcut that we refer to as “DeMorgan-fuse boxes.”

¹¹We use a slight blue background for selection conditions as enabling feature (Section 2.1.1), similar to the yellow background used by QueryVis [19].

These boxes allow us to express $\neg(\neg(\varphi_1) \wedge \dots \wedge \neg(\varphi_k))$, $k > 2$ with $\varphi_1 \vee \dots \vee \varphi_k$ by substituting nested double negations with bold rectangles, optionally connected via dotted lines.

Definition 7 (DeMorgan-fuse boxes). Bold rectangular boxes that are either adjacent to each other or connected via dotted lines are interpreted as if their anchored elements were connected via disjunctions. They are interpreted as if each of the boxes were replaced with individual negation scopes and the union of those boxes with another negation scope.

EXAMPLE 6 (SIMPLE DISJUNCTION). Consider the following disjunction from [Section 2.5](#):

$$\exists r \in R[r.A=1 \vee r.A=2] \quad (5)$$

Relational Diagrams need to show two R tables, either with union cells ([Fig. 2h](#)) or with a double negation ([Fig. 5c](#)):

$$\begin{aligned} & \exists r \in R[r.A=1] \vee \exists r \in R[r.A=2] \\ & \neg(\neg(\exists r \in R[r.A=1] \vee \exists r \in R[r.A=2])) \\ & \neg(\neg(\exists r \in R[r.A=1]) \wedge \neg(\exists r \in R[r.A=2])) \end{aligned}$$

Relational Diagrams with built-in relations replace the selection predicates with equijoins to two built-in relations ([Fig. 5d](#)):

$$\exists r \in R[\neg(\neg(\exists e_1 \in "=1"[r.A=e_1.\$1]) \wedge \neg(\exists e_2 \in "=2"[r.A=e_2.\$1]))]$$

RepresentationB can either represent the statement via De Morgan ([Fig. 5e](#)):

$$\exists r \in R[\neg(\neg(r.A=1) \wedge \neg(r.A=2))]$$

or via DeMorgan-fuse boxes ([Fig. 5g](#)), optionally connected via dotted edges ([Fig. 5f](#)).

5.3 RepresentationB is pattern-complete for TRC and solves the safety problem

We are ready to state our second of two main results of this paper.

THEOREM 8 (PATTERN-ISOMORPHISM AND SAFETY OF REPRESENTATIONB). *Every Relational Diagram with built-in predicates has a pattern-isomorphic representation as RepresentationB and vice versa. At the same time, RepresentationB preserves the safety conditions of TRC, i.e. the syntactic safety conditions can be directly verified from the diagrammatic representation.*

The proof uses constructive translations from TRC to RepresentationB and back that are pattern-preserving and safety-preserving. RepresentationB thus solves both the disjunction and the safety problem. Recall that $\text{TRC}^{\neg\exists\wedge\vee}$ preserves the relational pattern and the safety conditions. Because our translation from $\text{TRC}^{\neg\exists\wedge\vee}$ preserves the negation scopes, the disjunctions, and all atoms from the AST, the 4 safety conditions from [Section 3.2](#) can be immediately read and verified from a RepresentationB diagram. [Figure 6](#) discusses our running example.

5.3.1 Size of representation. RepresentationB has the same asymptotic size as TRC. The reason is that the leaves of the AST (and the negation and disjunction scopes) get directly mapped to objects in the diagram. At the same time, RepresentationB is an exponentially smaller representation of TRC than Relational Diagrams. This is because Relational Diagrams require CNF formulas to be first transformed into DNF (i.e. to have disjunctions or unions as the root, which requires an exponential blow-up), while our approach leaves disjunctions as *inner operators* in the AST.

PROPOSITION 9 (SIZE PRESERVATION OF REPRESENTATIONB). *RepresentationB has the same asymptotic size as TRC and can be exponentially smaller than Relational Diagrams.*

EXAMPLE 7 (EXAMPLE 2 CONTINUED). The TRC query from Example 2 is equivalent to the following safe TRC^{∃∧∨} fragment:

$$\{q(A, B) \mid (q.A = 0 \wedge (\exists r \in R[q.B = r.B] \vee q.B = 1)) \vee (\exists r \in R[q.A = r.A \wedge q.B = r.B \wedge \neg(\exists s \in S[\neg(\exists r_2 \in R[r.A = r_2.A \wedge r_2.B = s.B]])])]\} \quad (6)$$

The figure to the right shows the RepresentationB representation for this query, which also corresponds to the AST from Example 2 and Fig. 3. Notice how the 4 safety conditions can be applied directly on this diagram to verify that this query is safe.

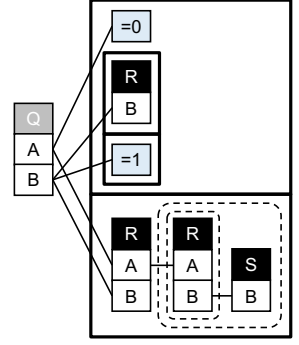

Fig. 6. Example 7 (Example 2 continued).

6 Generality of RepresentationB and enabling features

We show that RepresentationB unifies and generalizes prior approaches for disjunction (Section 6.1), justify its perceptual choices (Section 6.2), and give solutions to prior challenges (Section 6.3).

6.1 Unification of prior approaches

We formalized our disjunction boxes as a visual shortcut for DeMorgan which allow us to recover safety conditions for TRC.¹² They are also reminiscent of the “union cells” used by Relational Diagrams and prior box-based approaches going back all the way to Pierce (Section 2.5). We next show that our formalism actually *unifies and generalizes the major diagrammatic approaches for disjunction* that we have surveyed earlier (thus all except text-based and form-based in Fig. 2) and that it recovers each of them as a special case.

(1) *DeMorgan-based disjunctions*: The semantics of our approach fundamentally builds upon DeMorgan and it is thus an instance by replacing the shortcut with its semantics.

(2) *Box-based disjunctions*: our visual shortcut is similar to Peirce [53], Shin [60], compound spider diagrams [40], and the union cells for Relational Diagrams [32]. However, (i) our boxes are not just a union box, but it can be used in any nesting depth of the AST, which gives us an exponentially more succinct representation. Furthermore, (ii) our boxes are semantically justified via the DeMorgan-fuse as merely a visual shortcut for the actual semantics.

(3) *Edge-based disjunctions*: Similar to Shin [60], we allow disjunction boxes to not merely be adjacent but also connected via dotted lines. We have two reasons: (i) Lines connecting the boxes give more flexibility in the placement of the boxes and allow disjuncts to be placed in non-adjacent areas.¹³ (ii) Optional lines also allow us to recover all prior edge-based solutions: In the grammar of node-link diagrams [75] “line marks” connect “point marks” (and not other line marks). Edge-based disjunctions, however, draw specially highlighted or annotated lines between predicates, which are lines themselves (see Example 13 in Appendix E.1). As a basic visual construct, lines make a connection between entities [11]. Thus, even if not shown, the lines connected via a disjunction line require some anchor points on the predicate edges. Our disjunction boxes, even if infinitesimally small, give them these anchors and formal semantics via DeMorgan-fuse boxes.

¹²Similarly, the expansion by built-in relations gives our diagrams formal and precise semantics, and we deploy the visual symbols as a shortcut for that formal semantics.

¹³We do not discuss layout algorithms, and merely give a topological definition. It is easy to construct examples where a requirement of having anchors placed in adjacent boxes leads to overly strict constraints on the placement that would require extremely distorted join edges.

(4) *Form-based disjunctions*: Form-based approaches of disjunction like QBE [77] are not diagrammatic. However, vertically arranged boxes (alternative choices for the same predicate are shown in different rows) have become a familiar visual pattern. In order to mirror this familiar syntax we recommend showing disjunction boxes vertically aligned (as “enabling feature”, Section 2.1.1).

6.2 Perceptual choices and Peirce shading

Appendix E.2 justifies some of enabling features of the for RepresentationB, i.e. its perceptual choices. We also show how to leverage an idea of alternative shading by Peirce [53] that allows multiple readings of a given diagram and thereby even recover universal quantifiers.

6.3 Solutions to prior challenging queries

Appendix E.3 shows our solution to prior challenges mentioned in Section 1.

7 100% coverage of textbook benchmark

The authors of Relational Diagrams [32] gathered 58 queries from 5 popular database textbooks [17, 20, 24, 56, 62] and made them available on OSF.¹⁴ We refer to that set simply as “the textbook benchmark.” They evaluated the pattern expressiveness of various text-based and diagram-based languages (we replicate their numbers) and showed that Relational Diagrams covered 95% (55/58) of the queries in that benchmark. Our approach is pattern-complete for TRC and thus achieves 100% pattern coverage (Fig. 7). Appendix F lists the 3 queries that Relational Diagrams cannot pattern-represent and shows their pattern-isomorphic representation in RepresentationB.

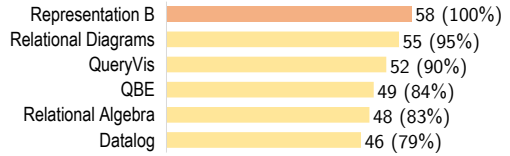

Fig. 7. Section 7: Fraction among 58 queries from 5 textbooks with pattern-isomorphic representations in listed representations. RepresentationB is the first diagrammatic representation to achieve 100% coverage.

8 Conclusion

We derived RepresentationB, a diagrammatic representation system that can represent any TRC query without changing the table signature and thus solves the disjunction problem. We arrived at this solution by first replacing join and selection predicates with relations and then defining the semantics based on placing relations in nested negation scopes and interpreting juxtaposition as conjunction. We then hid the details behind existing visual formalisms while redefining their semantics in the more rigorous relation-based interpretation (recall Fig. 4). We then defined a box-based visual shortcut that can encode safety condition and *unifies, generalizes, and overcomes the shortcomings* of the 3 major prior graphical approaches for disjunctions. It did this by showing that disjunction boxes (originally proposed by Peirce) can be pushed from the root into the branches of an AST representation of queries, while keeping their rigorous semantic interpretation.

Solving the disjunction problem is important since SQL and all relational query languages have a firm basis in mathematical logic. Any future visual query representation that can handle additional functionalities from SQL (including aggregates and grouping) needs to also incorporate a solution to the more general and longer-studied disjunction problem.

Acknowledgments

This work was supported in part by the National Science Foundation (NSF) under award IIS-1762268.

¹⁴Textbook benchmark: <https://osf.io/u7c4z/>. We noticed a slight discrepancy in the numbers and fixed the counts.

References

- [1] Serge Abiteboul, Richard Hull, and Victor Vianu. 1995. *Foundations of Databases*. Addison-Wesley. <http://webdam.inria.fr/Alice/>
- [2] Azza Abouzied, Joseph M. Hellerstein, and Avi Silberschatz. 2012. DataPlay: interactive tweaking and example-driven correction of graphical database queries. In *UIST*. ACM, 207–218. <https://doi.org/10.1145/2380116.2380144>
- [3] Azza Abouzied, Joseph M. Hellerstein, and Avi Silberschatz. 2012. Playful Query Specification with DataPlay. *PVLDB* 5, 12 (2012), 1938–1941. <https://doi.org/10.14778/2367502.2367542>
- [4] Active Query Builder. 2019. <https://www.activequerybuilder.com/>.
- [5] Michele Angelaccio, Tiziana Catarci, and Giuseppe Santucci. 1990. Query by diagram: A fully visual query system. *J. Vis. Lang. Comput.* 1, 3 (1990), 255–273. [https://doi.org/10.1016/S1045-926X\(05\)80009-6](https://doi.org/10.1016/S1045-926X(05)80009-6)
- [6] Marcelo Arenas, Pablo Barcelo, Leonid Libkin, Wim Martens, and Andreas Pieris. 2022. *Database Theory: Querying Data*. Open source at <https://github.com/pdm-book/community>.
- [7] Eirik Bakke and David R. Karger. 2016. Expressive Query Construction through Direct Manipulation of Nested Relational Results. In *SIGMOD*. ACM, 1377–1392. <https://doi.org/10.1145/2882903.2915210>
- [8] David Barker-Plummer, Jon Barwise, and John Etchemendy. 2011. *Language, Proof, and Logic: Second Edition* (2nd ed.). Center for the Study of Language and Information/SRI. <https://www.grade grinder.net/Products/lpl-index.html>
- [9] Jacques Bertin. 1981. *Graphics and graphic information-processing*. de Gruyter. <https://doi.org/10.1515/9783110854688>
- [10] Filippo Bonchi, Alessandro Di Giorgio, Nathan Haydon, and Pawel Sobocinski. 2024. Diagrammatic Algebra of First Order Logic. *arXiv:2401.07055* (2024). [arXiv:2401.07055](https://arxiv.org/abs/2401.07055)
- [11] Stuart K. Card, Jock D. Mackinlay, and Ben Shneiderman (Eds.). 1999. *Readings in information visualization: using vision to think*. Morgan Kaufmann. <https://dl.acm.org/doi/book/10.5555/300679>
- [12] Tiziana Catarci, Maria Francesca Costabile, Stefano Levialdi, and Carlo Batini. 1997. Visual Query Systems for Databases: A Survey. *J. Vis. Lang. Comput.* 8, 2 (1997), 215–260. <https://doi.org/10.1006/jvlc.1997.0037>
- [13] Tiziana Catarci and Giuseppe Santucci. 1994. Query by Diagram: A Graphical Environment for Querying Databases. In *SIGMOD*. 515. <https://doi.org/10.1145/191839.191976>
- [14] Stefano Ceri, Georg Gottlob, and Letizia Tanca. 1989. What you Always Wanted to Know About Datalog (And Never Dared to Ask). *IEEE TKDE* 1, 1 (1989), 146–166. <https://doi.org/10.1109/69.43410>
- [15] Donald D. Chamberlin. 2024. 50 Years of Queries. *Commun. ACM* 67, 8 (2024), 110–121. <https://doi.org/10.1145/3649887>
- [16] E. F. Codd. 1972. Relational Completeness of Data Base Sublanguages. *Research Report / RJ / IBM / San Jose, California* RJ987 (1972). <https://citeseerx.ist.psu.edu/document?doi=6a048dc38250f49c5e6a5040b4c91ca05e83d>
- [17] Thomas M. Connolly and Carolyn E. Begg. 2015. *Database Systems: A Practical Approach to Design, Implementation and Management, Global Edition* (5 ed.). Pearson Addison Wesley. <https://www.pearson.com/en-gb/subject-catalog/p/data-base-systems-a-practical-approach-to-design-implementation-and-management-global-edition/P200000003964/>
- [18] Wikipedia contributors. 2024. Tuple Relational Calculus – Wikipedia, The Free Encyclopedia. https://en.wikipedia.org/wiki/Tuple_relational_calculus [Online; accessed June-2024].
- [19] Jonathan Danaparamita and Wolfgang Gatterbauer. 2011. QueryViz: Helping Users Understand SQL queries and their patterns. In *EDBT*. ACM, 558–561. <https://doi.org/10.1145/1951365.1951440>
- [20] Christopher J. Date. 2003. *An introduction to database systems* (8 ed.). Pearson/Addison Wesley Longman. <https://dl.acm.org/doi/10.5555/861613>
- [21] C. J. Date and Hugh Darwen. 2000. *Foundation for future database systems: the third manifesto* (2nd ed ed.). Addison-Wesley Professional. <https://dl.acm.org/doi/10.5555/556540>
- [22] Frithjof Dau. 2009. The Advent of Formal Diagrammatic Reasoning Systems. In *ICFCA (International Conference on Formal Concept Analysis) (LNCS, Vol. 5548)*. Springer, 38–56. https://doi.org/10.1007/978-3-642-01815-2_3
- [23] Stephan Diehl. 2007. *Software visualization: visualizing the structure, behaviour, and evolution of software*. Springer, Berlin. <http://www.loc.gov/catdir/toc/fy0802/2007923067.html>
- [24] Ramez Elmasri and Sham Navathe. 2015. *Fundamentals of database systems* (7 ed.). Addison Wesley. <https://dl.acm.org/doi/book/10.5555/2842853>
- [25] Herbert Enderton and Herbert B Enderton. 2001. *A mathematical introduction to logic*. Elsevier. <https://doi.org/10.1016/C2009-0-22107-6>
- [26] George Englebretsen. 1996. Review of Sun-Joo Shin, The Logical Status of Diagrams. *Modern Logic* 6, 3 (1996), 322–330. <https://projecteuclid.org/journals/modern-logic/volume-6/issue-3/Review-of-Sun-Joo-Shin-The-Logical-Status-of-Diagrams/rml/1204835743.full>
- [27] Leonhard Euler. 1802. *Letters of Euler to a German princess, on different subjects in physics and philosophy addressed to a German Princess, Letters 103-106* (2nd ed.). Translated by Henry Hunter. <https://archive.org/details/letterseulertoa00eulegoog/page/396/mode/2up>.
- [28] Martin Gardner. 1958. *Logic Machines and Diagrams*. McGraw-Hill. <https://archive.org/details/logicmachinesdia00mart>

- [29] Wolfgang Gatterbauer. 2011. Databases will visualize queries too. Slide deck VLDB'11. https://gatterbauer.name/download/vldb2011_Database_Query_Visualization_presentation.pdf
- [30] Wolfgang Gatterbauer. 2023. A Tutorial on Visual Representations of Relational Queries. *PVLDB* 16, 12 (2023), 3890–3893. <https://doi.org/10.14778/3611540.3611578>, <https://northeastern-datalab.github.io/visual-query-representation-tutorial/>.
- [31] Wolfgang Gatterbauer. 2024. A Comprehensive Tutorial on over 100 Years of Diagrammatic Representations of Logical Statements and Relational Queries. In *ICDE*. IEEE. <https://doi.org/10.1109/ICDE60146.2024.00407> Tutorial page: <https://northeastern-datalab.github.io/diagrammatic-representation-tutorial/>.
- [32] Wolfgang Gatterbauer and Cody Dunne. 2024. On The Reasonable Effectiveness of Relational Diagrams: Explaining Relational Query Patterns and the Pattern Expressiveness of Relational Languages. *Proc. ACM Manag. Data* 2, 1 (2024), 61:1–61:27. <https://doi.org/10.1145/3639316>
- [33] Wolfgang Gatterbauer, Cody Dunne, H. V. Jagadish, and Mirek Riedewald. 2022. Principles of Query Visualization. *IEEE Data Eng. Bull.* 45, 3 (2022), 47–67. <http://sites.computer.org/debull/A22sept/p47.pdf>
- [34] Allen Van Gelder and Rodney W. Topor. 1991. Safety and Translation of Relational Calculus Queries. *ACM Trans. Database Syst.* 16, 2 (1991), 235–278. <https://doi.org/10.1145/114325.103712>
- [35] Michael Genesereth and Eric J. Kao. 2017. *Introduction to Logic* (3rd ed.). Morgan & Claypool Publishers. <http://intrologic.stanford.edu/homepage/index.html>
- [36] Janice Glasgow, N. Hari Narayanan, and B. Chandrasekaran. 1995. *Diagrammatic Reasoning: Cognitive and Computational Perspectives*. MIT Press, Cambridge, MA, USA. <https://dl.acm.org/doi/10.5555/546459>
- [37] Nathan Haydon and Pawel Sobocinski. 2020. Compositional Diagrammatic First-Order Logic. In *11th International Conference on the Theory and Application of Diagrams (DIAGRAMS) (LNCS, Vol. 12169)*. Springer, 402–418. https://doi.org/10.1007/978-3-030-54249-8_32 https://doi.org/10.1007/978-3-030-54249-8_32.
- [38] Marti A. Hearst. 2023. Show It or Tell It? Text, Visualization, and Their Combination. *Commun. ACM* 66, 10 (2023), 68–75. <https://doi.org/10.1145/3593580>
- [39] John Howse. 2008. Diagrammatic Reasoning Systems. In *ICCS (International Conference on Conceptual Structures) (LNCS, Vol. 5113)*. Springer, 1–20. https://doi.org/10.1007/978-3-540-70596-3_1
- [40] John Howse, Gem Stapleton, and John Taylor. 2005. Spider Diagrams. *LMS Journal of Computation and Mathematics* 8 (2005), 145–194. <https://doi.org/10.1112/S1461157000000942> London Mathematical Society.
- [41] Yannis E. Ioannidis. 1996. Visual User Interfaces for Database Systems. *ACM Comput. Surv.* 28, 4es (1996), 137. <https://doi.org/10.1145/242224.242399>
- [42] Hannu Jaakkola and Bernhard Thalheim. 2003. Visual SQL – High-Quality ER-Based Query Treatment. In *ER (Workshops) (LNCS)*. Springer, 129–139. https://doi.org/10.1007/978-3-540-39597-3_13
- [43] Oxford Languages. 2024. Diagram. <https://www.google.com/search?q=diagram>
- [44] Jens Lemanski, Mikkel Willum Johansen, Emmanuel Manalo, Petrucio Viana, Reetu Bhattacharjee, and Richard Burns (Eds.). 2024. *14th International Conference on Diagrammatic Representation and Inference (Diagrams 2024)*. LNCS, Vol. 14981. Springer. <https://doi.org/10.1007/978-3-031-71291-3>
- [45] Aristotelis Leventidis, Jiahui Zhang, Cody Dunne, Wolfgang Gatterbauer, H. V. Jagadish, and Mirek Riedewald. 2020. QueryVis: Logic-based Diagrams help Users Understand Complicated SQL Queries Faster. In *SIGMOD*. ACM, 2303–2318. <https://doi.org/10.1145/3318464.3389767>
- [46] Kenneth Manders. 2008. Diagram-Based Geometric Practice. In *The Philosophy of Mathematical Practice*. Oxford University Press. <https://doi.org/10.1093/acprof:oso/9780199296453.003.0004>
- [47] Scott McCloud. 1993. *Understanding Comics: The Invisible Art*. Tundra. <https://archive.org/details/understanding-comics>
- [48] Merriam-Webster.com. 2024. Diagram. <https://www.merriam-webster.com/dictionary/diagram>
- [49] Microsoft Access. 2019. <https://products.office.com/en-us/access>.
- [50] Daphne Miedema and George Fletcher. 2021. SQLVis: Visual Query Representations for Supporting SQL Learners. In *Symposium on Visual Languages and Human-Centric Computing (VL/HCC)*. IEEE, 1–9. <https://doi.org/10.1109/VL/HCC51201.2021.9576431>
- [51] Lil Mohan and Rangasami L. Kashyap. 1993. A Visual Query Language for Graphical Interaction with Schema-Intensive Databases. *TKDE* 5, 5 (1993), 843–858. <https://doi.org/10.1109/69.243513>
- [52] Charles Sanders Peirce. 1906. Prolegomena to an Apology for Pragmatism, autograph manuscript, unnumbered sheet, circa 1906. <https://library.harvard.edu/collections/charles-s-peirce-papers> MS AM 1632 (292a) p. 44. Courtesy of the Houghton Library, Harvard University..
- [53] Charles Sanders Peirce. 1933. *Collected Papers*. Vol. 4. Harvard University Press. https://archive.org/details/collectedpaperso0000unse_r5j9/
- [54] pgAdmin. 2019. <https://www.pgadmin.org/>.
- [55] QueryScope. 2019. <https://sqldep.com/>.

- [56] Raghu Ramakrishnan and Johannes Gehrke. 2002. *Database Management Systems* (3 ed.). McGraw-Hill, Inc., USA. <https://dl.acm.org/doi/book/10.5555/560733>
- [57] Don D. Roberts. 1973. *The Existential Graphs of Charles S. Peirce*. The Hague: Mouton. <https://doi.org/10.1515/9783110226225>
- [58] Nicole Schweikardt, Thomas Schwentick, and Luc Segoufin. 2010. *Database theory: query languages* (2 ed.). Chapman & Hall/CRC, 19. <https://doi.org/10.5555/1882723.1882742>
- [59] Martina Seidl, Marion Scholz, Christian Huemer, and Gerti Kappel. 2015. *UML @ Classroom - An Introduction to Object-Oriented Modeling*. Springer. <https://doi.org/10.1007/978-3-319-12742-2>
- [60] Sun-Joo Shin. 1995. *The Logical Status of Diagrams*. Cambridge University Press. <https://doi.org/10.1017/CBO9780511574696>
- [61] Sun-Joo Shin. 2002. *The Iconic Logic of Peirce's Graphs*. The MIT Press. <https://doi.org/10.7551/mitpress/3633.001.0001>
- [62] Avi Silberschatz, Henry F. Korth, and S. Sudarshan. 2020. *Database System Concepts* (7 ed.). McGraw-Hill Book Company. <https://www.db-book.com/db7/index.html>
- [63] John F. Sowa. 2008. Chapter 5 Conceptual Graphs. In *Handbook of Knowledge Representation*, Frank van Harmelen, Vladimir Lifschitz, and Bruce Porter (Eds.). Foundations of Artificial Intelligence, Vol. 3. Elsevier, 213–237. [https://doi.org/10.1016/S1574-6526\(07\)03005-2](https://doi.org/10.1016/S1574-6526(07)03005-2)
- [64] John F. Sowa. 2011. Peirce's tutorial on existential graphs. *Semiotica* 2011, 186 (2011), 347–394. <https://doi.org/10.1515/semi.2011.060>
- [65] SQL Server Management Studio. 2019. <https://www.microsoft.com/en-us/sql-server/sql-server-downloads>.
- [66] SQLvis. 2021. Visualization explanation. <https://github.com/Giraphne/sqlvis>
- [67] Gem Stapleton. 2013. Delivering the Potential of Diagrammatic Logics. In *Proceedings of the First International Workshop on Diagrams, Logic and Cognition (DLAC 2013)*. CEUR. <https://ceur-ws.org/Vol-1132/paper1.pdf>
- [68] Bernhard Thalheim. 2007. Tutorial Visual SQL: An ER-Based Introduction to Database Programming. Slide deck Christian-Albrechts-Universität zu Kiel.
- [69] Bernhard Thalheim. 2013. Visual SQL as the Alternative to Linear SQL. Slide deck Christian-Albrechts-Universität zu Kiel.
- [70] Silvia De Toffoli. 2022. What are mathematical diagrams? *Synthese* 200, 86 (2022). <https://doi.org/10.1007/s11229-022-03553-w>
- [71] Rodney Topor. 2018. Safety and Domain Independence. In *Encyclopedia of Database Systems, 2nd ed*, Ling Liu and M. Tamer Özsu (Eds.). Springer. https://doi.org/10.1007/978-1-4614-8265-9_1255
- [72] Edward R. Tufte. 1986. *The Visual Display of Quantitative Information*. Graphics Press, Cheshire, CT, USA. <https://dl.acm.org/doi/book/10.5555/33404>
- [73] Jeffrey D. Ullman. 1988. *Principles of Database and Knowledge-base Systems, Vol. I*. Computer Science Press, Inc. <https://dl.acm.org/doi/book/10.5555/42790>
- [74] John Venn. 1880. I. On the diagrammatic and mechanical representation of propositions and reasonings. *The London, Edinburgh, and Dublin Philosophical Magazine and Journal of Science* 10, 59 (1880), 1–18. <https://doi.org/10.1080/14786448008626877>
- [75] Colin Ware. 2020. *Information Visualization: Perception for Design* (4 ed.). Morgan Kaufmann Publishers Inc. <https://doi.org/10.1016/C2016-0-02395-1>
- [76] Colin Ware. 2021. *Visual Thinking for Information Design* (2 ed.). Morgan Kaufmann. <https://doi.org/10.1016/C2016-0-01395-5>
- [77] Moshé M. Zloof. 1977. Query-by-Example: A Data Base Language. *IBM Systems Journal* 16, 4 (1977), 324–343. <https://doi.org/10.1147/sj.164.0324>

A Related work: Discussion of original diagrams from prior work (Section 2.5)

This section extends Section 2.5 and gives a more detailed account of prior approaches for representing disjunctions. It notably includes screenshots from the original literature.

A.1 Text-based disjunctions

QBE [77] introduced the use of *condition boxes*. Those are non-visual representations of Boolean conditions. See Fig. 8a for an example: “Print the names of employees whose salary is between \$10000 and \$15000, provided it is not \$13000... Figure 24 illustrates the formulation of the AND operation using a condition box.” We consider text-based representations as non-diagrammatic representations.

Dataplay [2] adapted a text-based style for disjunctions. Figure 8b shows part of a query “which finds students who are in the CS department, and took any of CS11, CS16 or CS18, and got at least one A in any course.”

EMP	NAME	SAL
	P.	\$1

CONDITIONS		
S1 = (>10000 & <15000 & ≠13000)		

(a) [77, Fig. 24]

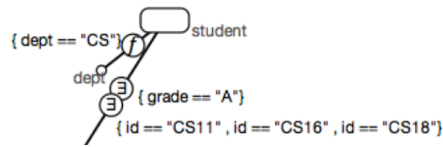

(b) [2, Fig. 2]

Fig. 8. Appendix A.1 (Option 1): Text-based disjunctions.

A.2 Vertical form-based disjunctions

QBE [77] also introduces the ability to specify disjunctions by filling out two separate rows with alternative information. Figure 9a shows a query with a disjunctive filter: “Print the names of employees whose salary is either \$10000 or \$13000 or \$16000. This is illustrated in Figure 23. Different example elements are used in each row, so that the three lines express independent queries. The output is the union of the three sets of answers.”

SQLVis [50] similarly provides a form-based interface for specifying conditions with disjunctions specified in separate rows. Fig. 9b shows a query selecting all attributes from customers whose city is either Amsterdam or Utrecht.

Datalog [14] also expresses disjunctions (or unions) with repeated rules. Each rule written in one row, the union can also be interpreted as vertical disjunction:

EMP	NAME	SAL
	P. JONES	10000
	P. LEWIS	13000
	P. HENRY	16000

(a) [77, Fig. 23]

customer c			
cID	cName	street	city
			Amsterdam
			Utrecht

(b) [66]

$Q :- R(x), x=1$

$Q :- R(x), x=2$

(c) Datalog

Fig. 9. Appendix A.2 (Option 2): (Vertical) form-based disjunctions.

A.3 Edge-based disjunctions

The first use of edges connecting anchors of statements as syntactic devices to express disjunctive information that we found is by Charles Sanders Peirce around 1896 [53] in his work on extending the at the time recently introduced Venn diagrams [74]. Peirce used “O” markers to show that a partition is empty (is false) and “X” markers to show that a partition contains at least one member (is

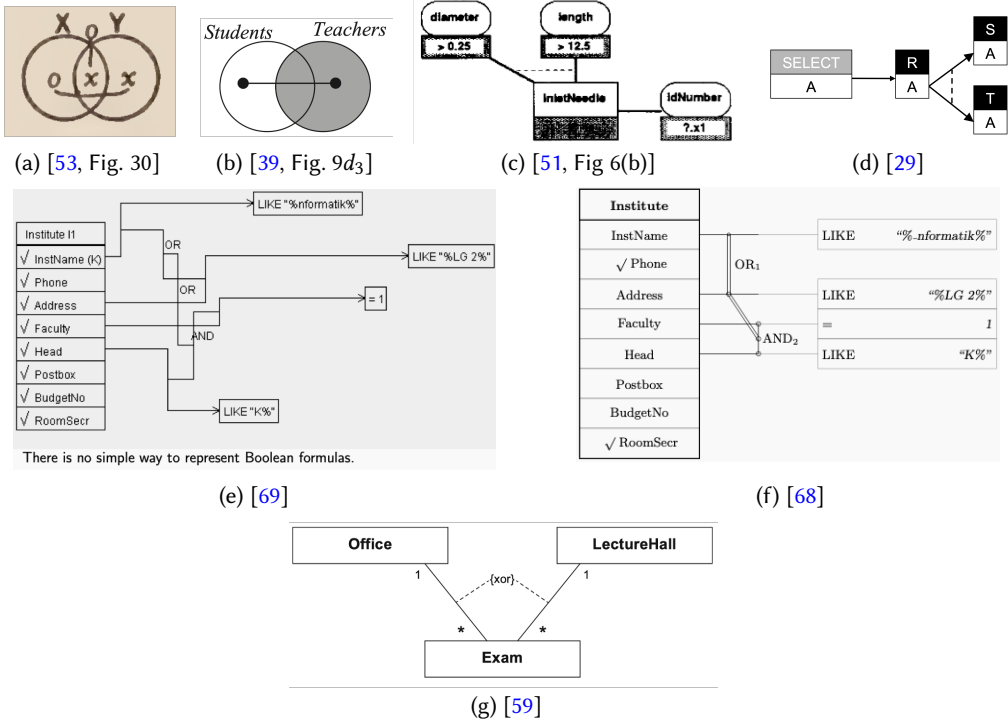

Fig. 10. Appendix A.3 (Option 3): Edge-based disjunctions.

true). To express disjunctions he placed a line between any sequence of such markers meaning that at least one of these statements must be true (Fig. 10a). Peirce writes [53, Paragraphs 4.359 and 4.360]: “Suppose, then, that signs in different compartments, if disconnected, are to be taken conjunctively, and, if connected, disjunctively, or vice versa... Let this rule then be adopted: Connected assertions are made alternatively, but disconnected ones independently, i.e., copulatively.” Figure 10a is the first figure in the literature that we found (though there may exist earlier ones that Peirce got inspired from and did not acknowledge or did not know of) that uses an edge to express disjunctions. The accompanying footnote reads: “Either all X is Y or some $\neg X$ is Y , and some X is Y or all $\neg X$ is Y .”

Spider diagrams [40] extend Euler diagrams [27] with a variant of “ X -sequences” (Peirce’s syntactic devices for disjunction limited to existential information) that are expressively equivalent to first-order monadic logic with equality. The spider diagram in Fig. 10b “asserts that there is an element that is a student or a teacher but not both, and there are no other teachers.”

This idea to connect disjunctive information via lines of various forms was taken up repeatedly in various formalisms for visual query languages in the database community. Mohan and Kashyap [51, Fig 6(b)] propose VQL and write “When two or more attributes are OR’ed in this fashion, it shows up on the visual query representation as a dashed line between those attributes as shown in Fig. 6(b).” Fig. 10c shows the representation for “Q3: Find the idNumbers of all the InletNeedles that have either diameter greater than 0.25 or have length greater than 12.5.”

In a presentation by the authors of QueryVis [19], we found Fig. 10d that uses similar visual notation. The diagram is accompanied by two SQL statements, which translated into TRC would

read as:

$$\{q(A) \mid \exists r \in R, s \in S [q.A=r.A \wedge (r.A = s.A \vee \exists t \in T [t.A=r.A])]\}$$

$$\{q(A) \mid \exists r \in R, s \in S, t \in T [q.A=r.A \wedge (r.A = s.A \vee t.A=r.A)]\}$$

Based on our formalism, only the second interpretation is valid.

UML class diagrams use a dashed line to express an XOR constraint (exclusive or) that an object of class A is to be associated with an object of class B or an object of class C but not with both. [Figure 10g](#) shows that an exam can take place either in an office or in a lecture hall but not in both [[59](#), Fig. 4.14].

All of the prior approaches can only illustrate disjunctions for simple filters within the same table. This approach does not generalize to more complicated statements involving conjunctions and disjunctions. In a presentation of VisualSQL [[42](#)], the main author Thalheim writes “There is no simple way to represent Boolean formulas” [[69](#)] and lists a challenging example shown in [Fig. 10e](#). The diagram returns Institutes where InstName LIKE “%nformatik%” or Address LIKE “%LG 2%” or (Faculty = 1 AND Head LIKE “K%”). In a different presentation, the same query is shown as [Fig. 10f](#). Notice here how the precedence between the nested Boolean operators is indicated with numbered subscripts.

A.4 Box-based disjunctions

In his chapter “Of Euler’s Diagrams,” Peirce describes the difficulty of displaying disjunctions (especially for DNF) with line-based disjunctions [[53](#), Paragraph 4.365]: “It is only disjunctions of conjunctions that cause some inconvenience; such as “Either some A is B while everything is either A or B, or else All A is B while some B is not A.” Even here there is no serious difficulty. [Fig. 59](#) ([Fig. 11a](#)) expresses this proposition. It is merely that there is a greater complexity in the expression than is essential to the meaning. There is, however, a very easy and very useful way of [Fig. 59](#) avoiding this. It is to draw an Euler’s Diagram of Euler’s Diagrams each surrounded by a circle to represent its Universe of Hypothesis. There will be no need of connecting lines in the enclosing diagram, it being understood that its compartments contain the several possible cases. Thus, [Fig. 60](#) ([Fig. 11b](#)) expresses the same proposition as [Fig. 59](#).” He thus proposed an alternative solution that we refer to as *box-based disjunctions*: He put Venn diagrams into rectangular boxes and interpreted each Venn diagram in a box as a disjunct. Intuitively, he puts certain disjunctions into DNF and then describes them as a union of expressions without disjunctions. [Figure 11b](#) is the first such figure we found.

Shin [[60](#)] keeps the “X” markers for existential statements and lines for disjunctions between existential statements from Peirce-Venn diagrams [[53](#)]. But she replaces the “O” markers (universal statements) again with the original shading from Venn, which removes their possible anchors for disjunctions. She then uses straight lines connecting different boxed diagrams to represent disjunctions *between statements at least one of which is universal* ([Fig. 11c](#)). The example from the introduction ([Fig. 2f](#)) does actually not need box-based disjunction and would be displayed by Shin as [Fig. 11d](#).¹⁵ For a more complete example, consider the statement “All R are S, or some R is S”: $\forall x [R(x) \rightarrow S(x)] \vee \exists x [R(x) \wedge S(x)]$. Peirce’s original modification to Venn would show the statement as [Fig. 11e](#), yet Shin requires the disjunction boxes in this case: [Fig. 11f](#). Overall, Shin combines an edge-based disjunction with a box-based disjunction. In Shin’s words [[60](#), Section 4] (emphasis added): “However, I find it easier to introduce a way to handle the information conveyed by a disjunction, rather than that conveyed by a negation. ... Therefore, we will introduce a new

¹⁵In the introduction, we focused on the key visual metaphors and thus wanted to keep the example consistent which required us to simplify.

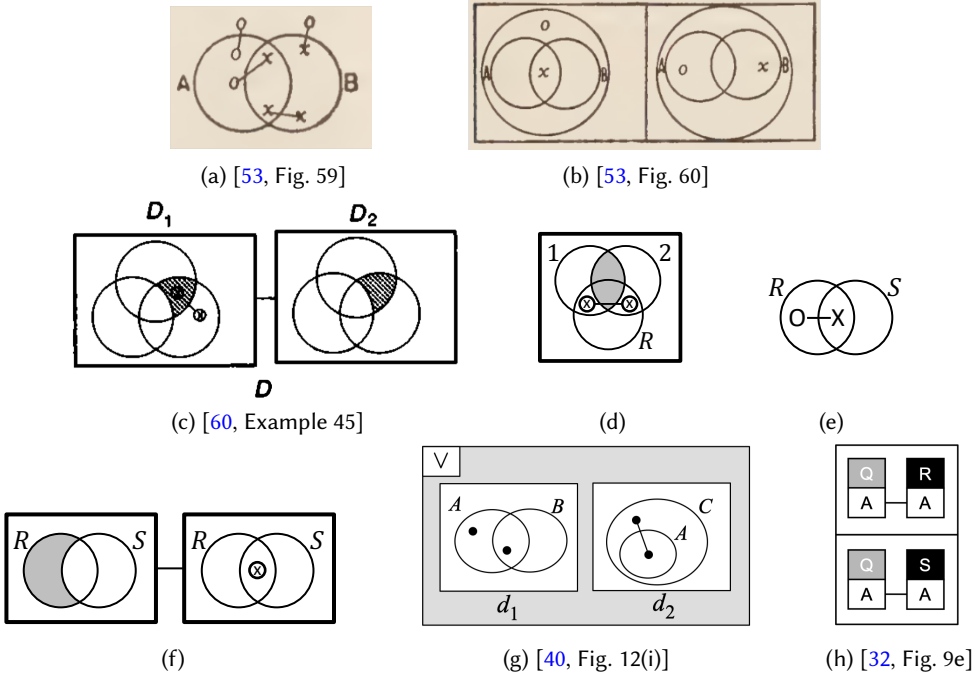

Fig. 11. Appendix A.4 (Option 4): Box-based disjunctions.

syntactic device in order to represent disjunctive information. Let us recall Peirce’s suggestions for disjunctive information... First, Peirce introduced a line that connects syntactic objects. However, to adopt this we would have to sacrifice some visual power of the diagram. Peirce’s other suggestion is to put Venn diagrams into rectangles and to interpret the Venn diagrams in each rectangle as disjunct. In this way, each of the Venn diagram(s) does not have to have a confusing line between o’s or x’s. However, in Venn-I we introduced a rectangle to represent a background set. Therefore, we will not adopt Peirce’s method directly, but will connect diagrams by a line. In this way, we do not have to introduce any new syntactic object.”

Spider diagrams by Howse et al. [40] combine idea from Euler diagrams [27], Venn diagrams [74], Peirce-Venn diagrams [53], and Shin-Venn diagrams [60] whose logical expressiveness is equivalent to first-order monadic logic with equality. They use what they call “the box template” to define k -ary compound diagrams consisting of smaller unitary (or recursively defined compound) diagrams. These box-based disjunction use explicit \vee labels (Fig. 11g).

Relational Diagrams [32] also cite inspiration from Peirce and represent a union of queries via adjacent “union cells”. In their words [32, Sect. 5]: “we allow placing several Relational Diagrams on the same canvas, each in a separate union cell. Each cell of the canvas then represents only conjunctive information, yet the relation among the different cells is disjunctive (a union of the outputs).” Figure 11h represents the query: $\{q(A) \mid \exists r \in R[q.A = r.A] \vee \exists s \in S[q[A = s.A]]\}$.

All of these prior box-based approaches represent disjunction as a union of expressions and use variants of what we call “union boxes” to represent a union of fully formed sentences. While spider diagrams allow these box templates to be nested, the resulting structure still consists of a set of unitary diagrams. We are not aware of any prior approach that pushes the nesting with boxes from the root into the leaves of logical expressions within individual diagrams (e.g. notice how the content of the disjunction boxes are still connected to diagrammatic elements outside it in Fig. 25b).

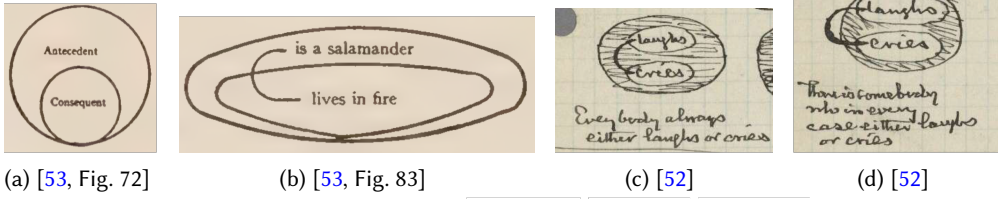

(a) [53, Fig. 72]

(b) [53, Fig. 83]

(c) [52]

(d) [52]



(e) [57, Sect. 3, Fig. 7]



Fig. 1



Fig. 2

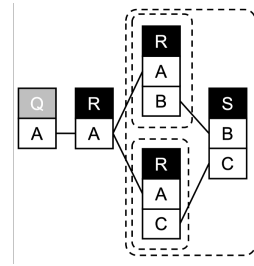

Fig. 3

(f) [57, Sect. 7.2, Fig. 1-3]

English	Existential Graphs	Principle Notation	Polish Notation
P	P	P	P
Not-P		$\neg P$	Np
P and Q	P Q	$P \cdot Q$	Kpq
P or Q		$P \vee Q$	Apq
If P then Q		$P \supset Q$	Cpq
All F is G		$(\forall x) [Fx \supset Gx]$	$\Pi x Cfxgx$
No F is G		$(\forall x) [Fx \supset \neg Gx]$	$\Pi x CfxNgx$
Some F is G		$(\exists x) [Fx \cdot Gx]$	$\Sigma x Kfxgx$
Some F is not G		$(\exists x) [Fx \cdot \neg Gx]$	$\Sigma x KfxNgx$

(g) [57, Appendix 2, condensed]



(h) [32, Fig. 9c]

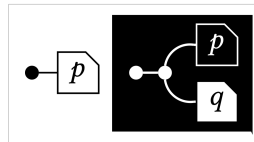

(i) [10, Fig. 8]

Fig. 12. Appendix A.5 (Option 5): DeMorgan-based disjunctions.

A.5 DeMorgan-based disjunctions

We call DeMorgan-based disjunctions, representations that use only symbols for negation and conjunction, and apply negation in a nested way in accordance with the logical identity $A \vee B = \neg(\neg A \wedge \neg B)$, which is famously named after Augustos De Morgan.

Existential graphs by Charles Sanders Peirce [53] are a diagrammatic notation for logical statements that uses closed curves to express negation and juxtaposition for conjunctions. Nesting of those closed curves (called ‘cuts’) permits expressing implication. Figure 12a is interpreted as: “The two steps of Fig. 72, taken together, form a curve which I shall call a scroll... The only essential feature is that there should be two steps, of which the inner, however drawn, may be called the inloop.” [53, Paragraph 4.436, Fig. 72]. Figure 12b is interpreted as “‘Every salamander lives in fire,’ or ‘If it be true that something is a salamander then it will always be true that something lives in fire?’” [53, Paragraph 4.449, Fig. 83]. Appropriate nesting of three such cuts then creates disjunctions as in Fig. 12c (“Everybody always either laughs or cries”) and Fig. 12d (“There is somebody who in every case either laughs or cries”).

Roberts (under the guidance of Max Harold Fisch) in the 1970s worked through the notes by Peirce and made the key ideas available to a larger audience in his influential interpretational

work [57]. We include figures from his work as Fig. 12e (“Fig. 7 can be read ‘It is false, that P is false and Q is false’”) and Fig. 12f: “a graph of even meager complexity can be read in several different English sentences, if only the reader will keep in mind two or three basic patterns. Fig. 1 is the pattern for an alternative proposition, and Fig. 2 is the pattern or a conditional. Just imagine what Fig. 3 would look like with a double cut surrounding P, and it will be obvious that ‘Either not-P or Q’ means the same as ‘If P then Q’. A student of EG will learn automatically many of the linguistic equivalences that require an excess of time and symbols in algebraic notations.” Figure 12g gives an overview of the possible cut nesting and resulting logical patterns.

Relational Diagrams [32] were inspired by the nestings of Peirce (and inspired our work). Fig. 12h shows the representation of the following query by applying De Morgan:

$$\begin{aligned} & \{q(A) \mid \exists r \in R[q.A=r.A \wedge \neg(\exists s \in S \\ & \quad [\neg(\exists r_2 \in R[(r_2.B=s.B \vee r_2.C=s.C) \wedge r_2.A=r.A])])]\} \\ = & \{q(A) \mid \exists r \in R[q.A=r.A \wedge \neg(\exists s \in S \\ & \quad [\neg(\exists r_2 \in R[r_2.B=s.B \wedge r_2.A=r.A]) \wedge \\ & \quad \neg(\exists r_3 \in R[r_3.C=s.C \wedge r_3.A=r.A])])]\} \end{aligned}$$

String diagrams [10, 37] are a variant of Peirce’s beta graphs that allow free variables in addition to bound variables. Both types of variables are represented by lines, yet bound variables are represented by a dot. Figure 12i shows the representation for $\exists x[p(x)] \wedge \forall y[p(y) \rightarrow q(y)]$

B Extended discussion on defining TRC (Section 3)

This section extends Sections 3.1 and 3.2 and provides a more detailed discussion of how our formalism for TRC and the formal safety conditions compare to prior work.

B.1 Different well-formed TRC formalisms

The database literature vastly differs in their treatment and formal definition of TRC. We give here an abbreviated comparison to our chosen formalism and explain the motivation for our choices. In essence, we believe that our streamlined formalization of TRC (and the resulting safety conditions based on ASTs) are a key reason why the translation from TRC to RepresentationB appear so natural.

B.1.1 Dedicated output variable. Several textbooks [24, 56, 62, 73] and Codd’s original formulation of TRC [16] allow a tuple variable bound to a particular table to become the output variable. For example Ramakrishnan and Gehrke [56] would allow the following notation:

$$\{r \mid r \in R \wedge r.B > 4\}$$

This notation does not make explicit the schema of the output (in this case $r(A, B)$) nor its arity. This could be partially fixed by always requiring to show the header of the output tuple. We, in contrast, always require a new free output variable (which is also required by the above notation if the output attributes are chosen from more than one table, but just not enforced when not needed) which simplifies the formation rules of well-formed formulas and also later simplifies the translation into a diagrammatic representation

We thus write the above query instead as:

$$\{q(A, B) \mid r \in R[q.A=r.A \wedge q.B=r.B \wedge r.B > 4]\}$$

B.1.2 Combined variable bindings and quantification. In our definition of well-formed formulas, we restrict any bound variable (either existentially or universally quantified) to range over a specific relation before it is used. This choice is also adopted by most textbooks such as

[56, 62]. This notation permits our concise definition of the Abstract Syntax Tree (AST) of a TRC query because bound attributes can only be referenced within a subtree of the quantifier node in the syntax tree that binds them.

Codd’s original formulation [16], and also the books by Ullman [73] and Elmasri and Navathe [24], separate our combined quantification and binding (“ $\exists r \in R$ ”) into a quantification (“ $\exists r$ ”) and a *range term* (“ $r \in R$ ”). For example, Ullman’s definition [73] would allow writing above query as

$$\{q(A, B) \mid \exists r [q.A = r.A \wedge q.B = r.B \wedge r.B > 4 \wedge r \in R]\}$$

Notice how the variable r is used in an atom (“ $q.A = r.A$ ”) whose binding is defined in a sibling node (“ $r \in R$ ”) of a shared parent conjunction node \wedge instead of a parent. This more permissive notation does not add logical expressiveness but leads to Ullman’s formal safety condition [73, Sect. 3.9] requiring an inductive argument about “limited variables” that are bound via possibly multiple equijoins. To see this, notice that the above query could also be written by defining an additional (and arguably unnecessary) tuple variable t that acts only as intermediary between output variable q and the bound variable r :

$$\{q(A, B) \mid \exists r, \exists t [q.A = t.A \wedge t.A = r.A \wedge q.B = r.B \wedge r.B > 4 \wedge r \in R]\}$$

B.1.3 Multiple bindings of the same variable. Separation of bindings and quantifications permits using the same tuple variable in multiple range terms as in

$$\{q \mid q \in R \wedge \neg(q \in S)\}$$

Our notation captures the same fragment but requires each “range term” to use a separate tuple variable, as in

$$\{q(A) \mid \exists r \in R [q.A = r.A \wedge \neg(\exists s \in S [r.A = s.A])]\}$$

B.1.4 Named vs. unnamed perspective. We follow most literature in using the named perspective of TRC. We thus assume all attribute names of relations are known and their relative order does not matter. Notable exceptions are Codd’s original formulation of TRC [16] and Ullman’s textbook [73] where they refer to the 2nd attribute (component) of a tuple variable r by “ $r.[2]$ ” as in:

$$\{r^{(2)} \mid r \in R \wedge r.[2] > 4\}$$

B.1.5 Minor notational differences. Our set notation for the binding predicate “ $r \in R_i$ ” is also used by Ramakrishnan and Gehrke [56] and Silberschatz et al. [62]. Codd [16] originally used the notation “ $P_i r$ ”, with P_i being a monadic predicate corresponding to table R_i , and called it a *range term*. Ullman [73] and Elmasri and Navathe [24] write the binding predicate instead as “ $R_i(r)$ ”.

Our notation “ $r.A$ ” for a tuple attribute (or component) is also used by Ramakrishnan and Gehrke [56] and Elmasri and Navathe [24]. Codd [16], Ullman [73], and Silberschatz et al. [62] instead use the notation “ $r[A]$ ” or “ $r(A)$ ”.

Our notation “ $\exists r \in R, \exists s \in S [r > 4]$ ” for the scope of tuple variables is similar to the notation of Ramakrishnan and Gehrke [56] and Silberschatz et al. [62]. However, we use brackets “[...]” instead of parentheses “(...)” for variable scopes, and use parentheses instead for the scope of negation $\neg(\dots)$. Other books [24, 73] use parentheses around the quantifiers as in “ $(\exists r)(\exists s)(r \in R \wedge s \in S \wedge r > 4)$ ”.

Date [20] uses a notation for “tuple calculus” that is entirely different (see e.g. Fig. 27e). The books by Abiteboul et al. [1] and Arenas et al. [6] do not cover TRC at all.

B.2 Different safety criteria for TRC

The safety conditions for TRC queries are rarely discussed in database textbooks. Abiteboul et al.’s concept of range-restricted RC queries [1] is only defined for DRC but not TRC. Ullman’s

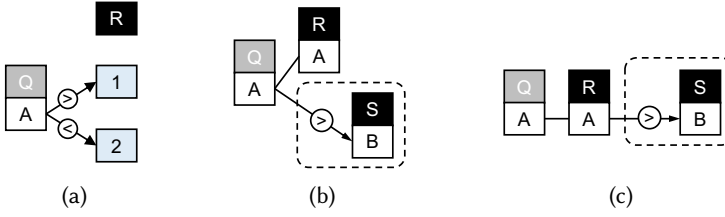

Fig. 13. **Example 8:** Three well-formed TRC queries. Only (c) is safe according to our safety conditions.

definition of safety [73] extends to TRC (we discuss it in more detail below) but it excludes correlated nested queries (e.g. find sailors who reserved all red boats), which we explicitly like to include. The books by Ramakrishnan and Gehrke [56], Elmasri and Navathe [24, Sect. 8.6.8], and Silberschatz [62, Sect. 27.2] mention the concept of safety and its connection to domain-independence but do not include any syntactic definition for safety. The very recent book in progress by Areans et al. [6] do mention safety in its current draft form. The safety definition for TRC on Wikipedia [18] is clearly wrong (it does not make a difference between existential and universal quantifiers), and has been wrong for over 10 years, according to the revision history.

Since our formal safety conditions differ slightly from prior definitions (they are at times more permissive and at other times more restrictive), we give here a more extensive justification for our choices, and at the end also a proof of them being a valid safety restriction.

B.2.1 One single binding predicates per output attribute. Our definition of safety does not allow an output attribute to be bound more than once, except if the multiple bindings correspond to disjunction in which case they are required. Our requirement simplifies the reading since every output attribute is connected via one equality predicate to exactly one table column (for each disjunct). Our requirement does not remove any expressiveness since it is always possible to remove multiple bindings except for one and replace them with join predicates, and one single binding via an equijoin is always required by safety conditions (e.g. Ullman [73] defines this condition with the notion of a “limited variable” which is bound via a sequence of equijoins to a domain).

We give two illustrating examples.

EXAMPLE 8. First, consider the following well-formed but unsafe TRC query:

$$\{q(A) \mid \exists r \in R[q.A > 1 \wedge q.A < 2]\}$$

It is not domain-independent and returns all (possibly infinite) domain values between 1 and 2, as long as the table R is not empty.

Next, consider the following unsafe but domain-independent query:

$$\{q(A) \mid \exists r \in R[q.A = r.A \wedge \neg(\exists s \in S[q.A > s.A])]\}$$

It is unsafe according to our safety definition as the output attribute $q.A$ is referenced twice. To make it safe, we can remove one occurrence and replace it with $r.A$ to which $q.A$ is equated in the binding predicate:

$$\{q(A) \mid \exists r \in R[q.A = r.A \wedge \neg(\exists s \in S[r.A > s.A])]\}$$

See Figure 13 for their respective RepresentationB representations.

EXAMPLE 9. Consider the following well-formed TRC query:

$$\{q(A) \mid \exists r \in R[q.A = r.A] \wedge q.A = 4\}$$

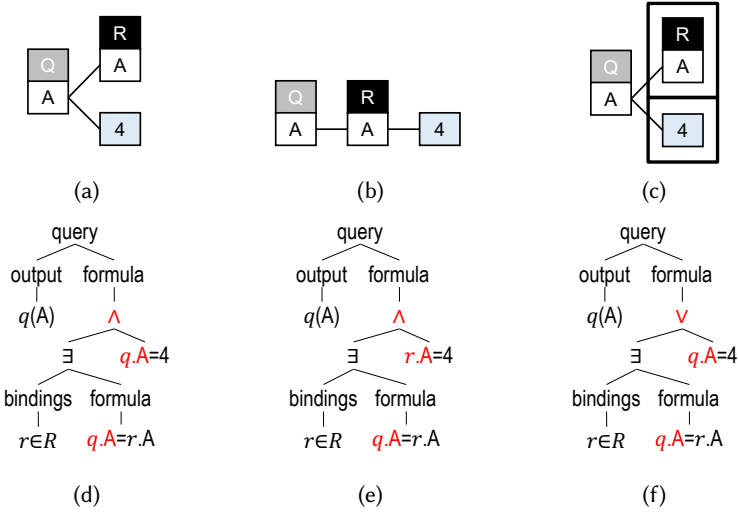

Fig. 14. **Example 9:** Three well-formed TRC queries together with their corresponding ASTs. Only (b) and (c) are safe according to our safety condition.

It is well-formed, but not safe according to our definition because $q.A$ is bound more than twice, and those bindings are connected in the AST. The query, however, is equivalent to the following safe query:

$$\{q(A) \mid \exists r \in R[q.A=r.A] \wedge r.A=4\}$$

Notice how the single output edge from $q.A$ makes the resulting RepresentationB representation easier to read. The following slight variation also binds $q.A$ twice, but those bindings are connected via a disjunct and are thus needed:

$$\{q(A) \mid \exists r \in R[q.A=r.A] \vee q.A=4\}$$

Figure 14 shows the corresponding RepresentationB representations together with their AST.

B.2.2 Comparison with Ullman’s safety criteria. Ullman’s safety criteria [73, Section 3.9] are notably more restrictive than ours in an important way. They not only disallow universal quantifiers, they also include a requirement that all free variables need to be bound to a domain for all existentially quantified subformulas, such as “ $\exists r_1 \in R_1, \dots, r_k \in R_k [\varphi]$ ”. This requirement is motivated by the fact that any such safe formula has a direct and natural translation into Datalog [73, Theorem 3.11] and thus also RA. However, this restriction forbids nested correlated queries that are allowed by our safety condition and also by SQL.

For example, consider the following subformula of query (6) in Example 7:

$$\neg(\exists s \in S[\neg(\exists r_2 \in R[r.A=r_2.A \wedge r_2.B=s.B])])$$

In Ullman’s formalism and our notation, it would be written as:

$$\neg(\exists s[s \in S \wedge \neg(\exists r_2[r_2 \in R \wedge r.A=r_2.A \wedge r_2.B=s.B])])$$

The free variable r violates Ullman’s safety condition in the maximal conjunction “ $s \in S \wedge \neg(\dots)$ ” because r is free but not “limited”, as it only appears in the 2nd conjunct “ $\neg(\exists r_2[\dots])$ ” which is negated.

As a consequence, Ullman’s safe queries *cannot express certain relational query patterns that our safety condition allows*. On the other hand, Ullman’s conditions allow using the free variables multiple times in arbitrary ways in a formula, which makes the inductive translation from RA shorter, yet does not add any pattern expressiveness.

B.2.3 Safety and DeMorgan. We give two examples of the fact that safety for disjunctions is treated differently than their DeMorgan equivalent of negation combined with conjunction, across various definitions of safety. Interestingly both directions are possible: queries with disjunction can be safe (whose DeMorgan equivalent with negation and conjunction is not), but queries with disjunctions can also be unsafe (yet they become safe after applying DeMorgan).

(1) For the syntactic criterion of “range-restricted queries” by Abiteboul et al. [1, Sect. 5.4], part of the inductive definition for the set of range-restricted variables (rr) is given by

$$\varphi_1 \wedge \varphi_2 : rr(\varphi) = rr(\varphi_1) \cup rr(\varphi_2)$$

$$\varphi_1 \vee \varphi_2 : rr(\varphi) = rr(\varphi_1) \cap rr(\varphi_2)$$

$$\neg\varphi_1 : rr(\varphi) = \emptyset$$

It follows that any safe query defined over a formula $\varphi_1 \vee \varphi_2$ immediately becomes unsafe after applying DeMorgan and writing it as the pattern-equivalent formula $\neg(\neg\varphi_1 \wedge \neg\varphi_2)$.

(2) Example 3.29 by Ullman [73] shows the DRC formula

$$r(x, y, z) \wedge \neg(p(x, y) \vee s(y, z))$$

that is not “safe” according to Ullman’s definitions of safety, because the subformula $p(x, y) \vee s(y, z)$ violates the syntactic safety condition that whenever an \vee operator is used, the two formulas connected must have the same set of free variables. However by applying DeMorgan on the negated subformula and then “flattening” (i.e. no \wedge node appears as a child of another \wedge in the AST) he derives the pattern-equivalent formula

$$r(x, y, z) \wedge \neg p(x, y) \wedge \neg s(y, z)$$

which is safe because all three variables in the conjunction are limited by the positive conjunct $r(x, y, z)$.

B.2.4 Proof of correctness of our safety definition. For completeness, we give a self-contained proof that our safety condition is a valid syntactic restriction that preserves relational completeness.

LEMMA 10. *The four conditions given in Section 3.2 are a valid safety restriction, i.e. the resulting safe TRC fragment is relationally complete and every safe TRC query is domain-independent.*

PROOF LEMMA 10. It suffices to prove two steps: (1) The safe fragment is relationally complete. We show that by giving a constructive translation of any relational algebra query into that fragment.¹⁶ (2) Every query expressed in that fragment is domain-independent.

(1) $RA \rightarrow$ safe TRC: The proof for this direction is an adaptation of the proof of Lemma 3.6 in [73]. We show by induction on the number of operators in the relational algebra expression E that there is a TRC formula, with a single free tuple variable q , that defines the same relation as E .

¹⁶We decided to prove (1) from first principles by translating from RA in order to make our results as self-contained as possible. We also we did not find a self-contained and easy-to-use safety condition for TRC in standard references: Existing definitions of safety for TRC are either too restrictive (e.g. Ullman’s definition of safety of TRC [73] is the most carefully developed we found, but prohibits the use of universal quantification, and it does not even allow nested correlated queries), or only explain but do not formally define safety (e.g. [24, 56, 62]), or do not treat TRC and its formal safety conditions at all (e.g. [1, 6, 34]).

The basis, zero operators, requires that we consider two cases: E is either a database relation R or (a relation of) constants. If E is a relation R of arity k and schema (A_1, \dots, A_k) then formula

$$\exists r \in R[q.A_1 = r.A_1 \wedge \dots \wedge q.A_k = r.A_k]$$

suffices and is safe by our definition. If E is a constant relation, say $\{r_1, \dots, r_n\}$ with header $\mathbf{H} = (A_1, \dots, A_k)$, consisting of n tuples of arity k , then we write the TRC formula

$$\begin{aligned} &(q.A_1 = r_1.A_1 \wedge q.A_2 = r_1.A_2 \wedge \dots \wedge q.A_k = r_1.A_k) \vee \\ &(q.A_1 = r_2.A_1 \wedge q.A_2 = r_2.A_2 \wedge \dots \wedge q.A_k = r_2.A_k) \vee \\ &\dots \\ &(q.A_1 = r_n.A_1 \wedge q.A_2 = r_n.A_2 \wedge \dots \wedge q.A_k = r_n.A_k) \end{aligned}$$

Notice that $r_i.A_j$ is a constant for all $i \in [n]$ and $j \in [k]$. Thus, the above formula is safe by our safety definition.

For the induction, consider an expression whose outermost operator is one of 5 operators: Union \cup , difference $-$, projection π , Cartesian product \times , or selection σ .¹⁷

Case 1: $E = E_1 \cup E_2$: From the induction, we assume that there are safe TRC formulae φ_1 and φ_2 for E_1 and E_2 , respectively. We know from the definition of the union operator that E_1 and E_2 must have the same arities and schemas. By renaming if necessary, we may assume that the lone free tuple variable in both φ_1 and φ_2 is q . Because E_1 and E_2 have the same arity, the free tuple variables of φ_1 and φ_2 must also have the same arity, thus renaming is permitted. Then $\varphi_1 \vee \varphi_2$ is a safe TRC formula for E .

Case 2: $E = E_1 - E_2$: As in case 1, assume there are formulas φ_1 and φ_2 for E_1 and E_2 with free variable q , respectively. We know by definition of the set difference that E_1 and E_2 must have the same arities and schemas. From the induction, we know that for each attribute $q.A_i$, both φ_1 and φ_2 contain binding predicates of the form $q.A_i = x_{1i}$ and $q.A_i = x_{2i}$, respectively (here each x_{ji} is either a constant or an attribute in an existentially quantified relation). Let φ'_2 be the formula we get from φ_2 by replacing every binding predicate $q.A_i = x_{2i}$ by $x_{1i} = x_{2i}$. Then $\varphi_1 \wedge \neg\varphi'_2$ is a safe TRC formula for E and its free variables only appear in the non-negated subformula φ_1 .

Case 3: $E = \pi_{A_1, \dots, A_d}(E_1)$: Let φ_1 be a safe TRC formula for E_1 with a single free variable q_1 of arity $k, k > d$. From the induction, we know that φ_1 contains binding predicates of the form $q_1.A_i = x_i$ for $x \in [k]$. Then a formula for E , with free variable q of arity d , is identical to φ_1 where every binding predicate $q_1.A_i = x_i$ for $i \in [d]$ is replaced by $q.A_i = x_i$, and every binding predicate for $i \in \{d+1, \dots, k\}$ is removed.

Case 4: $E = E_1 \times E_2$: Let φ_1 and φ_2 be two TRC formulas for E_1 and E_2 with free variables q_1 and q_2 of arities k_1 and k_2 , respectively. As before, we assume q_1 and q_2 are bound with binding predicates $q_1.A_i = x_{1i}, i \in [k_1]$ and $q_2.A_i = x_{2i}, i \in [k_2]$, respectively. If necessary, we first rename the attributes of q_1 and q_2 in their binding predicates s.t. they are disjoint. WLOG q_1 has then attributes A_1, \dots, A_{k_1} and q_2 has attributes $A_{k_1+1}, \dots, A_{k_1+k_2}$. We then rename the tuple variables themselves in the binding predicates of φ_1 and φ_2 s.t. they use the same variable q (i.e. $q.A_i = x_{1i}, i \in [k_1]$ in φ_1 and $q.A_{i+k_1} = x_{2i}, i \in [k_2]$ in φ_2). The TRC formula for E , with lone free variable q of arity $k_1 + k_2$, is $\varphi_1 \wedge \varphi_2$. Finally, we assume that whenever possible, we reformulate the resulting formula φ to be maximally scoped (i.e. we push the \wedge behind existential quantifiers).

Case 5: $E = \sigma_c(E_1)$: Here, c is a logical condition that combines join and selection predicates defined over attributes from E_1 with an arbitrary nesting of logical operators \wedge, \vee, \neg . Let φ_1 be a

¹⁷Notice that we do not need to treat the renaming operator separately: WLOG we assume that every tuple variable is defined only once in any safe TRC query, and we thus never run into renaming issues in the named perspective of TRC as we do in the named perspective of RA.

safe TRC formula for E_1 with single free variable q , and let c' be c in which references to tables in E_1 are replaced with appropriate tuple variables from φ_1 . Then a formula for E , with free variable q is $\varphi_1 \wedge c'$.

(2) Every safe TRC query is domain-independent: This statement follows immediately from our definition of safety and observing that every occurrence of the single free variable q is possible only via a binding predicate, i.e. a predicate that binds an attributes of q to either column of a table or a constant, and thus to a finite set of domain values. \square

C Details for Section 4

C.1 Proof Lemma 5 (Section 4.1)

PROOF LEMMA 5. The proof follows from a recursive application of standard logical transformations [8, Sections 3.6 & 10.3] and observing that they do not change the atoms of the AST, and thus neither the predicates nor the table signature.

Let $\varphi_1, \dots, \varphi_k$ represent any well-formed formulas. Then the following transformations preserve the atoms:

- (1) DeMorgan's law for universal quantifiers:¹⁸ $(\forall r_1 \in R_1, \dots, \forall r_k \in R_k [\varphi]) = \neg(\exists r_1 \in R_1, \dots, \exists r_k \in R_k [\neg(\varphi)])$. Notice here that the binding atoms ($r_i \in R_i$) are staying the same despite the quantifiers are changing.
- (2) Removing implications: $((\varphi_1) \rightarrow (\varphi_2)) = (\neg(\varphi_1) \vee (\varphi_2))$
- (3) DeMorgan's law for disjunctions: $(\varphi_1 \vee \varphi_2 \vee \dots \vee \varphi_k) = \neg(\neg(\varphi_1) \wedge \neg(\varphi_2) \wedge \dots \wedge \neg(\varphi_k))$
- (4) DeMorgan's law for conjunctions: $(\varphi_1 \wedge \varphi_2 \wedge \dots \wedge \varphi_k) = \neg(\neg(\varphi_1) \vee \neg(\varphi_2) \vee \dots \vee \neg(\varphi_k))$
- (5) Removing double negations: $\neg(\neg(\varphi_1)) = (\varphi_1)$

The transformations can be applied in order (1) \rightarrow (2) \rightarrow (3) \rightarrow (5) from the outside inwards and thus finish in polynomial time. \square

C.2 Comparing the ASTs for $\text{TRC}^{\neg\exists\wedge\vee}$ and $\text{TRC}^{\neg\exists\wedge}$ (Section 4.1.1)

EXAMPLE 10. Consider the following TRC query that is a variation on relational division. It returns values from $R.A$ that co-occur in R with either $S.B$ or $S.C$, for all tuples from S with $S.A > 0$:

$$\{q(A) \mid \exists r \in R[q.A=r.A \wedge (\forall s \in S[s.A > 0 \rightarrow (\exists r_2 \in R[(r_2.B=s.B \vee r_2.C=s.C) \wedge r_2.A=r.A]])]\} \quad (7)$$

Replacing \forall and \rightarrow leads to an expression in $\text{TRC}^{\neg\exists\wedge\vee}$:

$$\{q(A) \mid \exists r \in R[q.A=r.A \wedge \neg(\exists s \in S[s.A > 0 \wedge \neg(\exists r_2 \in R[(r_2.B=s.B \vee r_2.C=s.C) \wedge r_2.A=r.A]])]\} \quad (8)$$

Further replacing \vee leads to a query in $\text{TRC}^{\neg\exists\wedge}$:

$$\{q(A) \mid \exists r \in R[q.A=r.A \wedge \neg(\exists s \in S[s.A > 0 \wedge \neg(\exists r_2 \in R[\neg(\neg(r_2.B=s.B) \wedge \neg(r_2.C=s.C)) \wedge r_2.A=r.A]])]\} \quad (9)$$

Notice that the above three expressions are not only pattern-equivalent (we do not change the signature), but also all the selection predicates (e.g. " $S.A > 0$ ") and the join predicates (e.g. " $r_2.C=s.C$ ") are identical. Only the logical connectives ($\neg, \vee, \wedge, \rightarrow$), quantifiers and parentheses may have changed. In other words, all atoms are identical, and hence all leaves in their ASTs (Fig. 15).

¹⁸DeMorgan's laws are named after Augustus de Morgan who formalized them (though they have been known earlier). We are using the notation of Barker-Plummer et al [8] and write "DeMorgen" without a space between 'De' and 'Morgan'.

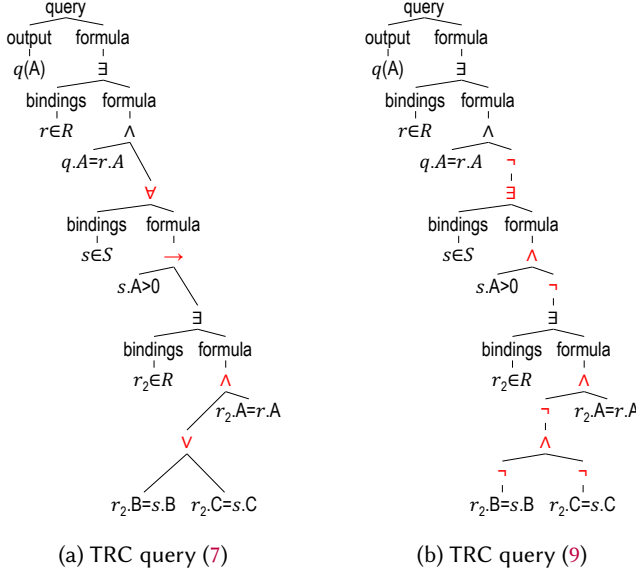

Fig. 15. **Example 10:** ASTs of logically identical queries. Notice how all leaves of the trees are identical despite (b) using a smaller vocabulary for internal nodes than (a).

This is in contrast to the non-disjunctive fragment required by Relational Diagrams. Concretely, [32] suggests to use DeMorgan with quantifiers as to distribute the quantifier over the disjuncts, before transforming to a conjunction: $\neg(\exists r \in R[A \vee B]) = \neg(\exists r \in R[A] \vee \exists r \in R[B]) = \neg\exists r \in R[A] \wedge \neg\exists r \in R[B]$. This leads to a disjunction-free query, yet leads to a different signature (3 occurrences of table “R”) and thus a different relational pattern:

$$\{q(A) \mid \exists r \in R[q.A=r.A \wedge \neg(\exists s \in S[s.A > 0 \wedge \neg(\exists r_2 \in R[r_2.B=s.B \wedge r_2.A=r.A]) \wedge \neg(\exists r_3 \in R[r_3.C=s.C \wedge r_3.A=r.A])]]]\} \quad (10)$$

C.3 Relational Diagrams with built-in relations are pattern-complete for TRC (Section 4.3, Theorem 6)

We next prove **Theorem 6** by giving a constructive translation from $\text{TRC}^{-\exists \wedge}$ and back.

C.3.1 Translation from $\text{TRC}^{-\exists \wedge}$ to Relational Diagrams with built-in relations. We next give the straight-forward 4-step translation from well-formed $\text{TRC}^{-\exists \wedge}$ queries into a variant of Relational Diagrams enhanced with built-in predicates. This translation is heavily inspired by the 5-step translation given in [32] for their version of Relational Diagrams, however it differs in crucial steps. Notably, by showing that our translation preserves the atoms (which includes the binding predicates) for *all* well-formed TRC queries, we also show that our variant can express all relational patterns of TRC. We illustrate the translation with query (9) from **Example 10** displayed in **Fig. 16**.

(1) *Preprocessing:* First, we translate any well-formed TRC into $\text{TRC}^{-\exists \wedge}$ by preserving its atoms as described in **Section 4.1**. Then, we replace every join and selection predicate with the corresponding built-in relation as described in **Section 4.2**. Equijoin predicates ($R.A = S.B$) that occur in the same negation scope as one of their relations R or S do not need to be replaced (e.g. this is the case in

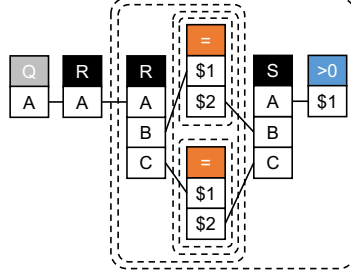

Fig. 16. Appendix C.3.1: Pattern-preserving diagrammatic representation with built-in relations for query (9) from Example 10.

Fig. 4c after replacing the “<” operator with “=”, but not in Fig. 1d and Example 14). As example, query (9) is written as:

$$\{q(A) \mid \exists r \in R[q.A=r.A \wedge \neg(\exists s \in S, c \in \text{“>0”}[s.A=c.\$1 \wedge \neg(\exists r_2 \in R[\neg(\neg(\exists j_1 \in \text{“=”}[r_2.B=j_1.\$1 \wedge j_1.\$2=s.B]) \wedge \neg(\exists j_2 \in \text{“=”}[r_2.C=j_2.\$1 \wedge j_2.\$2=s.C]) \wedge r_2.A=r.A])])]\}] \}$$

Notice that the equijoins “ $q.A=r.A$ ” and “ $r_2.A=r.A$ ” are not replaced with built-in relations

(2) *Creating canvas partitions*: Similar to Relational Diagrams, The scopes of the negations in a TRC are nested by definition. We translate the nested hierarchy of negation scopes (the *negation hierarchy*) into a nested partition of the canvas by dashed boxes with rounded corners.

(3) *Placing input, built-in, and output relations*: Relation names from each binding predicate are placed into the canvas partition that corresponds to the respective negation scope. Notably, built-in relations are treated identically as other relations. In particular, multiple occurrences of the same built-in relation (e.g. <) lead to separate relations being placed in appropriate partitions. For our example, the binding $\exists j_1 \in \text{“=”}$ is represented by a built-in relation $\boxed{=}$ in nesting level 4 of the negation hierarchy. Clearly inspired by Relational Diagrams, the output relation Q for non-Boolean queries and all attributes from its headers are represented with a relation \boxed{Q} outside all nesting scopes, which we refer to as the *base partition* in reference to the AST. Recall that for well-formed TRC queries $\{q(\mathbf{H}) \mid \varphi\}$, φ can contain only one single free variable q .

(4) *Placing equijoin predicates*: In contrast to Relational Diagrams, both join and selection predicates are now treated identically as equijoins with appropriate built-in relations. For each equijoin $R.A=S.B$ in the query, we simply add two attributes, one for each relation R and S and connect them via an unlabeled edge. For table attributes that occur in multiple equijoins, we only draw one attribute and connect it to multiple edges. Notice that by this construction, the attributes of each occurrence of a built-in relation are connected to exactly one edge. For example, “ $r_2.B=j_1.\$1$ ” is represented with an edge between attribute \boxed{B} of the 2nd occurrence of relation \boxed{R} with attribute $\boxed{\$1}$ of the first occurrence of built-in relation $\boxed{=}$.

Completeness. This 4-step translation guarantees the uniqueness of the following aspects: (1) nesting hierarchy (corresponding to the negation hierarchy), (2) where input and built-in relations are placed (canvas partitions corresponding to the negation scope), (3) which relation attributes participate in equijoins with what other relational attributes. Notice that due to our unified treatment of selection and join predicates as equi-joins with appropriate built-in relations, our translation (after preprocessing) is slightly simpler than the one originally proposed by the authors of Relational Diagrams [32] and, more importantly, also more general: *Any well-formed TRC query* can be represented in a way that preserves all atoms and thus also relational patterns.

C.3.2 Translation from Relational Diagrams with built-in relations to $\text{TRC}^{-\exists\wedge}$. We next describe the reverse 5-step translation from any valid Relational Diagrams with built-in predicates to a valid and unique $\text{TRC}^{-\exists\wedge}$ expression.

(1) *Determine the negation hierarchy:* From the nested canvas partitions, create the nested scopes of the negation operators of the later $\text{TRC}^{-\exists\wedge}$ expression, connected via conjunction whenever a partition has multiple children in the negation hierarchy. For Fig. 16, this interpretation leads to $\varphi = \neg(\neg(\neg(\neg(_) \wedge \neg(_))))$. Here and in the following “_” stands for a placeholder.

(2) *Optional output table:* If the diagram contains an output relation Q with non-empty header H in the base partition (which represents the only free variable), then use the set builder notation $\{q(A) \mid \varphi\}$.

(3) *Binding predicates for table variables:* Each input relation in a partition corresponds to an existentially-quantified table variable. WLOG, we use a small letter indexed by the number of occurrences for repeated tables. We add those quantified table variables in the respective scope of the negation hierarchy. Similar to Relational Diagrams, we require that the leaves of the partition are not empty and contain at least one relation (whether input or built-in). For our running example, we now have: $\{q(A) \mid \exists r_1 \in R[\neg(\exists s_1 \in S[\neg(\exists r_2 \in R[\neg(\neg(_) \wedge \neg(_))])])])]\}$

(4) *Join and selection predicates for built-in relations:* For each unary built in relation θc , we place a selection predicate template $_ \theta c$ into the appropriate negation scope (here “_” is a placeholder for table attribute to be added later). For each binary built in relation θ , we place a join predicate template “ $_ \theta _$ ” into the appropriate negation scope. Whenever two table attributes $R.A$ and $S.B$ are directly connected via an edge without any built-in predicate in between, then this because an equijoin predicate “ $r_i.A = s_j.B$ ” occurs in the same negation scope as one of their relations R or S . In this case, we place an equijoin predicate template “ $_ = _$ ” into the negation scope of either R or S , whichever one appears most deeply nested (they may also be equally nested). In our running example, this is the case for the equijoin between the two R tables (“ $r_1.A = r_2.A$ ”) being in the same partition as r_2 . Multiple such join and selection predicates are connected via conjunctions within the same negation scope. At this point, our formula template is:

$$\{q(A) \mid \exists r_1 \in R[_ = _ \wedge \neg(\exists s_1 \in S[_ > 0 \wedge \neg(\exists r_2 \in R[\neg(\neg(_ = _) \wedge \neg(_ = _)) \wedge _ = _])])]\}$$

(5) *Replace edges with table attributes:* For each edge between a table attribute and a built-in predicate, we add the table attribute reference to the appropriate predicate template. For example, “ $_ > 0$ ” gets replaced by “ $s_2 > 0$ ” and the second occurrence of “ $_ = _$ ” gets replaced by “ $r_2.B = s_1.B$ ”. Our final TRC query is then:

$$\{q(A) \mid \exists r_1 \in R[q.A = r_1.A \wedge \neg(\exists s_1 \in S[s_1.A > 0 \wedge \neg(\exists r_2 \in R[\neg(\neg(r_2.B = s_1.B) \wedge \neg(r_2.C = s_1.C)) \wedge r_2.A = r_1.A])])]\}$$

Soundness. Notice that this 5-step translation guarantees that the resulting TRC query is well-formed and uniquely determined up to (1) renaming of the tuple variables; (2) reordering the predicates in conjunctions (commutativity of conjunctions), and (3) flipping the left/right positions of attributes in each predicate. Neither of these possible transformations changes the semantics of the query. It follows that Relational Diagrams with built-in predicates are sound, and their logical interpretation is unambiguous.

C.3.3 Valid Relational Diagrams with built-in relations. The validity conditions for Relational Diagrams with built-in relations are similar to Relational Diagrams and follow from the conditions for each of the 5 steps of the translation to TRC. The differences are: (1) Edges contain no labels and represent equijoins. (2) Built-in predicates can be of two types (unary and

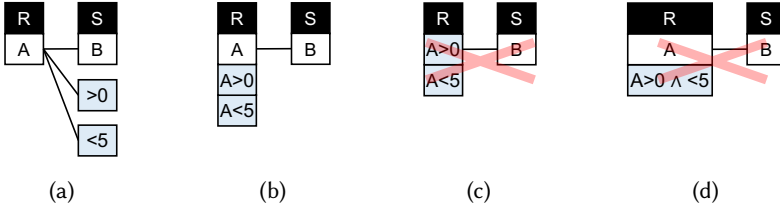

Fig. 17. **Example 11** in **Appendix D.1**: (a) and (b) are two alternative representations for RepresentationB. (a) is “canonical”, defines our formal semantics, and is necessary to represent pattern-equivalent nested disjunctions. (b) is the representation of Relational Diagrams that we use as short-form whenever possible. We do not permit (c) which is non-deterministic (and thus somewhat arbitrary), nor (d) which requires a symbolic interpretation of \wedge and is thus not diagrammatic.

binary) and have one of 6 comparison operators. (3) Edges can only happen between attributes of tables that are descendants of each other, and only between input relations, or between one input relation and one built-in predicate. (4) The optional single output table needs to be outside any negation scope and disjunction box, but each attribute can be connected to an arbitrary number of tables in any partition. The constructive translations from **Appendices C.3.1** and **C.3.2**, which preserves *all atoms* in both directions, constitute the proof.

D Details for Section 5

D.1 Example for Section 5.1.1

EXAMPLE 11 (CANONICAL SELECTIONS). Consider the Boolean query

$$\exists r \in R, \exists s \in S [r.A = s.B \wedge r.A > 0 \wedge r.A < 5]$$

shown in 4 variants in Fig. 17: **Figure 17a** is our canonical representation and is topologically uniquely determined. It defines our formal semantics and is necessary to represent pattern-equivalent nested disjunctions. **Figure 17b** is the canonical representation for Relational Diagrams. It repeats the attribute of a table for every selection predicate and fuses the selections into the attributes. We apply this representation as a visual shortcut whenever possible. **Figure 17c** is a possible further shortcut. The choice of the selection attribute that is fused into the join is non-deterministic, which is why we do not recommend it. **Figure 17d** uses a symbolic representation for conjunction \wedge and is thus not diagrammatic (see also Fig. 2a).

D.2 Modified translation for RepresentationB (Section 5.3, Theorem 8)

We prove **Theorem 8** by giving a translation from $\text{TRC}^{\neg\exists\wedge\vee}$ to RepresentationB. It is a simple adaptation of the translation from **Appendix C.3.1** with only two modifications:

(1) Instead of built-in relations, we use the visual shortcuts from **Section 5.1**. We thus only need to transform TRC into $\text{TRC}^{\neg\exists\wedge\vee}$, which preserves the safety conditions. We can also represent selection and join predicates directly via their shortcuts and do not need to go the full route via built-in relations.

(2) The second step of “Creating canvas partitions” now also includes disjunction boxes in addition to negation scopes: each subtree rooted below a negation \neg gets a negation scope, and each subtree rooted below a disjunction node \vee gets a disjunction box. Sibling boxes are then either connected with a dotted line, or adjacent to each other.

In the reverse direction, we need to modify the first step of “Determine the negation hierarchy”: From the nested canvas negation and disjunction partitions, we now create the nested scopes of the

negation and disjunction operators of the later $\text{TRC}^{\neg\exists\wedge\vee}$ expression For Fig. 24b, this interpretation leads to $\varphi = \neg(\neg(_ \vee _))$.

D.3 RepresentationB is exponentially more succinct than Relational Diagrams (Section 5.3.1)

We give here the proof for Proposition 9 in Section 5.3.1 that RepresentationB is an exponentially more succinct representation than Relational Diagrams. We proceed in two steps: (1) We first show that every Relational Diagram can be immediately interpreted as RepresentationB (with the exception of “union cells” (or union boxes), where RepresentationB replaces multiple outputs relation with only one). (2) We then give a parameterized query that has an exponentially bigger size than Relational Diagram.

D.3.1 RepresentationB has equal or smaller size. From Section 5 and our translation from Appendix C.3.2, it follows that every Relational Diagram without union boxes is immediately also a RepresentationB. For every Relational Diagram with union boxes, all the output relations in the union boxes can be replaced with one single output relation outside the disjunction boxes to give a valid RepresentationB. It follows that for all Relational Diagrams there is a RepresentationB of equal or smaller size. We give an example.

EXAMPLE 12 (EXAMPLE 1 CONTINUED). *Relational Diagrams need to transform query (1) into a union of disjunction-free queries*

$$\{q(A) \mid \exists r \in R[q.A = r.A]\} \cup \{q(A) \mid \exists s \in S[q.A = s.A]\}$$

As a consequence, the output table will be repeated twice, each in a separate union cell and with an identical attribute signature, just like Datalog (see Fig. 18a).

In contrast, RepresentationB has maximally one output relation, just like TRC. Therefore, Fig. 18a is not a valid RepresentationB representation. Instead, RepresentationB represents query (1) with one single output table (see Fig. 18b).

Figures 18c and 18d show their ASTs. Notice how the Relational Diagram has the same atoms, except for repeated output tables.

D.3.2 RepresentationB can be exponentially smaller than Relational Diagrams. We now give the proof for Proposition 9 from Section 5.2.

PROOF PROPOSITION 9. Consider the following parameterized Boolean TRC query:

$$\exists r \in R[(r.A_1 = c_{11} \vee r.A_1 = c_{12}) \wedge \dots \wedge (r.A_k = c_{k1} \vee r.A_k = c_{k2})]$$

It can be represented as RepresentationB with size $O(k)$ in the number of symbols. Concretely, RepresentationB needs $5k + 1$ boxes and $2k$ edges (see Fig. 19a).

Relational Diagrams can represent the disjunction as DNF and thus first need to transform the query into DNF:

$$\begin{aligned} &\exists r \in R[r.A_1 = c_{11} \wedge \dots \wedge r.A_k = c_{k1}] \vee \\ &\exists r \in R[r.A_1 = c_{11} \wedge \dots \wedge r.A_k = c_{k2}] \vee \\ &\dots \\ &\exists r \in R[r.A_1 = c_{12} \wedge \dots \wedge r.A_k = c_{k2}] \end{aligned}$$

The DNF has 2^k clauses and its size and also the size of the *diagrams* representation is thus $O(2^k)$. Concretely, Relational Diagrams requires $(k + 1) \cdot 2^k$ boxes (see Fig. 19b for the use of union cells).

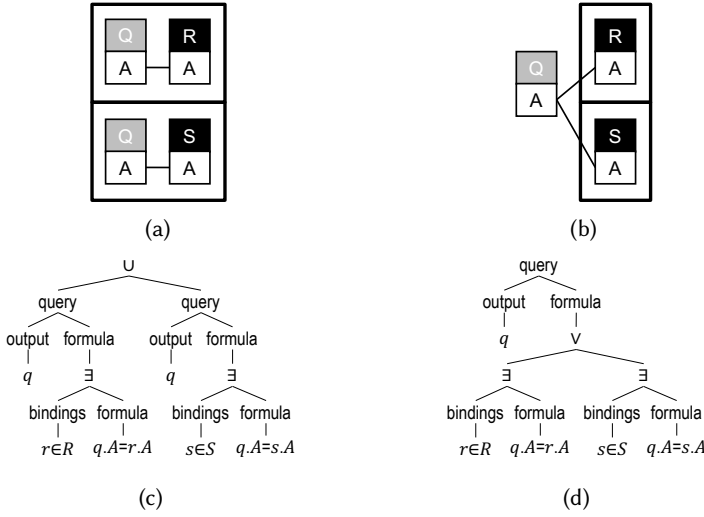

Fig. 18. **Example 12:** Every Relational Diagram can be represented as RepresentationB in equal or smaller size.

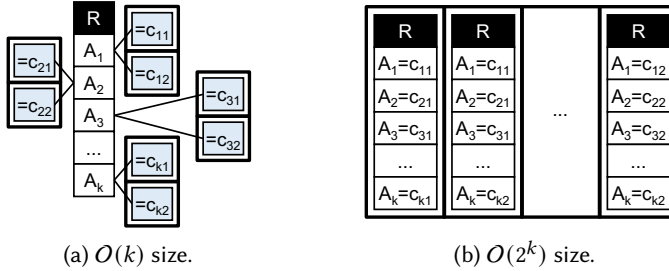

Fig. 19. **Appendix D.3.2:** Illustration for the proof of **Proposition 9**.

Since every Relational Diagram is also a RepresentationB representation (except the union cells from **Appendix D.3.1**), it follows that RepresentationB is an exponentially smaller representation than Relational Diagrams.

To see that TRC and RepresentationB have the same asymptotic size, notice that the translation from TRC succeeds by first translating TRC into $TRC^{-\exists \wedge \vee}$ (which does not change the atoms, and hence the leaves) and then directly mapping the atoms to visual symbols: (1) binding atoms get mapped to relational tables; (2) join predicates get mapped to two attributes and a connecting line with label appropriate placed; (3) selection predicates get mapped to either one or two attribute boxes. The negation scopes and disjunction boxes are in 1-to-1 correspondences with the levels of negation and the appearance of disjunctions in the AST. \square

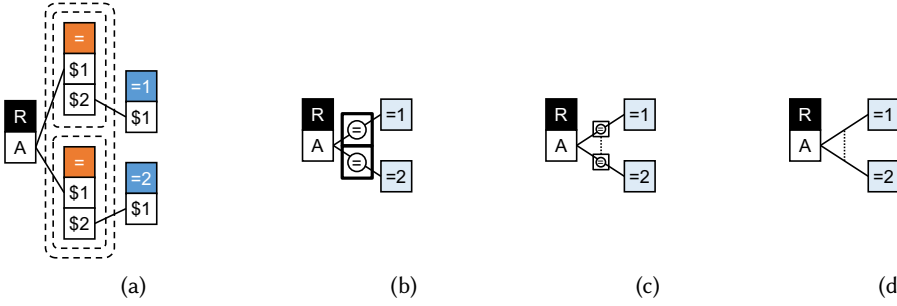

Fig. 20. **Example 13** in **Appendix E.1**: RepresentationB can recover edge-based disjunctions (Fig. 2d) via increasingly small anchors on the equijoins.

E Details for (Section 6)

E.1 An example for recovering edge-based disjunctions (Section 6.1)

EXAMPLE 13 (EXAMPLE 6 CONTINUED). We next show how the disjunction $\exists r \in R[r.A = 1 \vee r.A = 2]$ can be visualized in the spirit of edge-based disjunctions (Fig. 2d). Notice how constants are semantically not bound to particular negation scopes and the query can be expressed with built-in predicates as

$$\begin{aligned} & \exists r \in R, \exists c_1 \in "=1", \exists c_2 \in "=2" [\\ & \quad \neg(\neg(\exists e_1 \in "=" [r.A = e_1.\$1 \wedge e_1.\$2 = c_1.\$1]) \wedge \\ & \quad \neg(\exists e_2 \in "=" [r.A = e_2.\$1 \wedge e_2.\$2 = c_2.\$1]))] \end{aligned}$$

Figure 20a shows the atom-preserving representation as Relational Diagrams with built-in relations, and Figure 20b the corresponding RepresentationB. Figures 20c and 20d shows the process of making the anchors of the equijoins increasingly small, leading in the limit to the edge-based disjunction from Fig. 2d.

E.2 Perceptual justification of our solution and Peirce shading (Section 6.2)

Our main contributions in this paper is a representation system that solves the disjunction and the safety problem with its constitutive features. We discuss here some of the enabling features of our representation which, recall from Section 2.1.1, are those are features that facilitate interpretation but are not essential. Those may thus appear as orthogonal to some readers and we list them only as supplemental information. But they informed us in our design.

Chamberlin in his recent CACM article on SQL [15] states “Our specific goals were to design a query language with the following properties: ... user with no specialized training could, in simple cases, understand the meaning of a query simply by reading it. We called this the ‘walk-up-and-read’ property.” Diehl [23] writes: “If done right, diagrams group relevant information together to make searching more efficient, and use visual cues to make information more explicit.”

Similarly, our goal was to develop an (i) intuitive and (ii) principled diagrammatic representation for (iii) arbitrary nestings of disjunctions, (iv) with minimal additional notations. Our solution RepresentationB is heavily inspired by the design choices of Relational Diagrams and meets the challenge without introducing any fundamentally novel visual symbol to the visual grammar of Relational Diagrams. We merely give a stricter syntactic interpretation of edge labels, allow constants outside table attributes, and allow disjunction boxes used inside the diagrams.

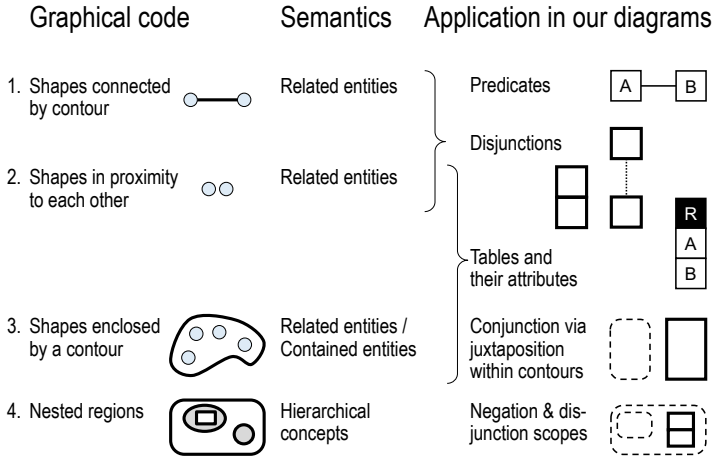

Fig. 21. **Appendix E.2:** Our design choices in the larger context of the visual grammar of node-link diagrams and relationship representations. Figure is heavily inspired from [76] but modified to our context.

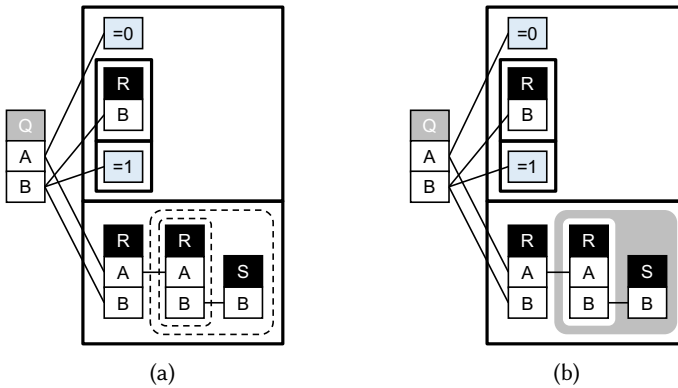

Fig. 22. (a): **Example 7** (**Example 2** continued). (b) shows Peirce shading applied.

Figure 21 shows how we see our conservative extension with disjunctions fit into the overall visual grammar and semantic patterns (sometimes called “codes”) of node-link diagrams and relationship representations [76]. As Ware writes, “a good diagram takes advantage of basic perceptual mechanisms that have evolved to perceive structure in the environment” [76] and we tried to follow that practice. Notice how our choices of disjunctions inherit the “nested regions” code from negation scopes and DeMorgan, while also using the “shapes in proximity” code (widely used and known from UML) and alternatively the “shapes connected by contour” code.

E.2.1 Peirce shading to facilitate reading. We give here an additional enabling feature for RepresentationB that was originally proposed by Peirce [53, Paragraph 4.621] and became more widely known due to Sowa [63, 64]. Call zones in the diagram as either *positive* (if nested in an even number of negation scopes, possibly zero) or *negative* (if nested in an odd number of negations). Then to improve contrast and facilitate reading, shade negative areas in gray and keep positive areas in white. For example, Fig. 22b shows Peirce shading applied to Example 7.

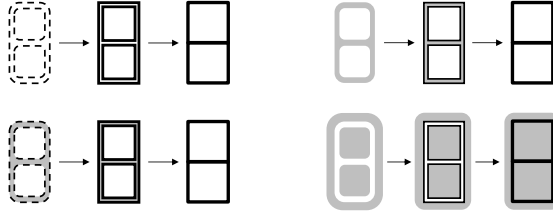

Fig. 23. **Appendix E.2.1:** DeMorgane-fuse boxes do not change the parity of a zone and thus effortlessly interact with Peirce shadings.

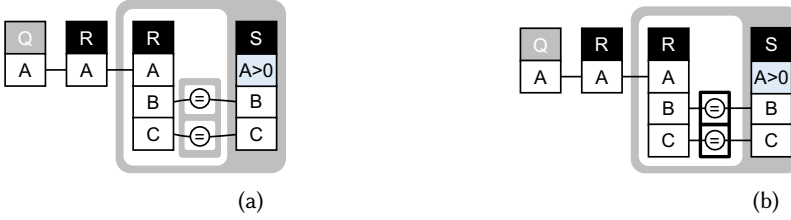

Fig. 24. **Example 14:** RepresentationB by translating from $TRC^{-\exists\wedge}$ (a) or directly from $TRC^{-\exists\wedge\vee}$ with DeMorgane-fuse boxes (b), both with Peirce shading applied.

Since the semantics of DeMorgane-fuse boxes is based on double negation, and they thus *do not change the parity of a zone*, Peirce shadings very naturally complement with disjunction (see Fig. 23). We illustrate by continuing **Example 10**.

EXAMPLE 14 (EXAMPLE 10 CONTINUED). *Figure 16* showed **Example 10** as Relational Diagram with built-in relations. *Figure 24a* now shows the RepresentationB representation by translating from query (9) in $TRC^{-\exists\wedge}$. In contrast, *Fig. 24b* shows RepresentationB by translating directly from the $TRC^{-\exists\wedge\vee}$ query (8) and using disjunctions. Notice how the disjunction boxes do not change the parity of the zones in which they are and can really be interpreted as visual shortcuts (thus providing a post hoc justification for our name “DeMorgane-fuse”).

E.3 RepresentationB representations for 4 prior challenges (Section 6.3, Section 1)

We give here solutions in RepresentationB to 4 challenges listed in the introduction. We use the word “query” also for a statement (i.e. a Boolean query).

Figure 25a shows RepresentationB for **Fig. 1a**, a simplified version of a problem listed in two presentations [68, 69] by Thalheim (the original images are shown in **Figs. 10e** and **10f**). The representation reads as:

$$R.A=1 \vee R.B=2 \vee (R.C=3 \wedge R.D=4) \quad (11)$$

Figures 25b and **25c** shows RepresentationB for the two challenges listed in [32]:

$$\exists r \in R, \exists s \in S [r.A < s.E \wedge (r.B < s.F \vee r.C < s.G)] \quad (12)$$

$$\exists r \in R [(r.A > 0 \wedge r.A < 10) \vee (r.A > 20 \wedge r.A < 30)] \quad (13)$$

Gardner in his 1958 book ‘Logic Machines and Diagrams’ [28] discusses a challenging disjunction and concludes that “there seems to be no simple way in which the statement, as it stands, can be diagrammed” [28, Section 4.3]:

$$(A \vee B) \rightarrow (C \vee D) \quad (14)$$

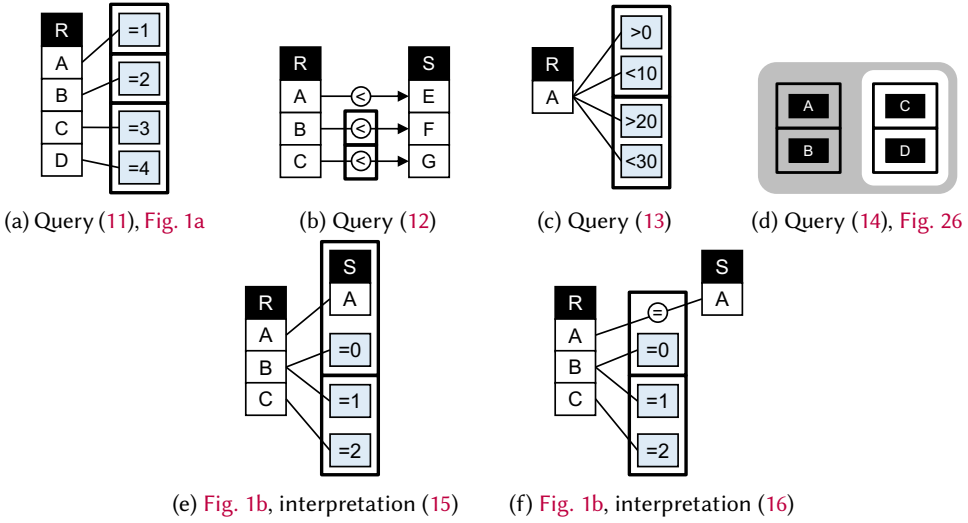

Fig. 25. Appendix E.3: RepresentationB representations for challenging examples raised in prior work.

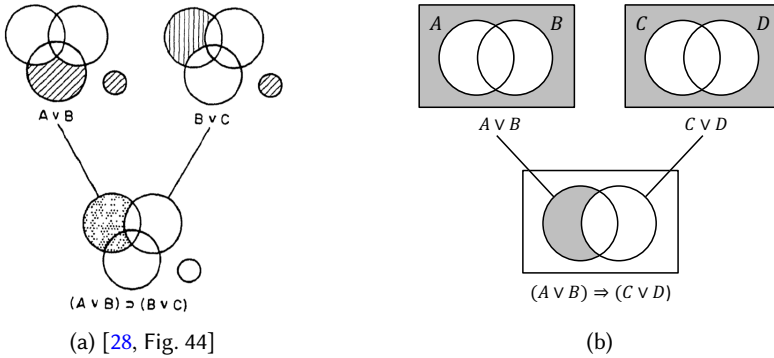

Fig. 26. Garner’s challenging disjunction $(A \vee B) \rightarrow (C \vee D)$ shown in its original form (a) and an equivalent more modern use of Venn diagrams.

He proposes to use what he calls a *diagrammatic compound statement* shown in Fig. 26a, which needs to repeat the individual predicates, i.e. it is thus not pattern-isomorphic to query (14). Figure 25d shows RepresentationB for query (14), which follows from rewriting the statement as:

$$\neg((A \vee B) \wedge \neg(C \vee D))$$

Notice that while TRC is commonly not defined with nullary (0-ary) predicates, atomic propositions like A can be naturally interpreted as nullary relations $A()$ that can be set to true or false. In other words, a symbol “ A ” is true iff “ $\exists a \in A$ ”, i.e. thus table A is not empty.

Most interesting is Fig. 1b, raised as a challenge in the earlier mentioned tutorial [31]. Here we point out an issue that – to the best of our knowledge – has never been raised in the literature on visual representation and diagrammatic reasoning: There are two different ways to interpret the figure shown in Fig. 1b:

$$\exists r \in R, \exists s \in S [(r.A = s.A \wedge r.B = 0) \vee (r.B = 1 \wedge r.C = 2)] \tag{15}$$

$$\exists r \in R [(\exists s \in S [r.A = s.A] \wedge r.B = 0) \vee (r.B = 1 \wedge r.C = 2)] \tag{16}$$

The difference is that query (15) is true on the database $\{R(0, 1, 2)\}$, whereas query (16) is false. The reason is the different scoping of S . Our principled translation into RepresentationB with DeMorgan-fuse boxes creates the two *distinct* diagrams Figs. 25e and 25f and can thus handle the distinction, as expected. We do not know any edge-based approach that could handle and distinguish the cases.

F Details on textbook benchmark (Section 7)

We list here the 3 queries that Relational Diagrams cannot pattern-represent: ① “Find the names of sailors who have reserved a red or a green boat” [56, Query 5, Sect. 5.2]. ② “Make a list of project numbers for projects that involve an employee whose last name is ‘Smith’, either as a worker or as manager of the controlling department for the project” [24, Query 4, Ch. 8.6]. ③ “Get part numbers for parts that either weigh more than 16 pounds or are supplied by supplier S2, or both” [20, Query 9, Ch.8.3]. Figure 27 shows those queries in their original definitions together with their RepresentationB representations.

(Q5) Find the names of sailors who have reserved a red or a green boat.

```
SELECT S.sname
FROM   Sailors S, Reserves R, Boats B
WHERE  S.sid = R.sid AND R.bid = B.bid
       AND (B.color = 'red' OR B.color = 'green')
```

(a) [56, Query 5, Sect. 5.2]

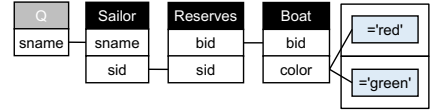

(b)

Query 4. Make a list of project numbers for projects that involve an employee whose last name is ‘Smith’, either as a worker or as manager of the controlling department for the project.

```
Q4: { p.Pnumber | PROJECT(p) AND (((∃e)(∃w)(EMPLOYEE(e)
AND WORKS_ON(w) AND w.Pno=p.Pnumber
AND e.Lname='Smith' AND e.Ssn=w.Essn) )
OR
((∃m)(∃d)(EMPLOYEE(m) AND DEPARTMENT(d)
AND p.Dnum=d.Dnumber AND d.Mgr_ssn=m.Ssn
AND m.Lname='Smith'))}}
```

(c) [24, Query 4, Ch. 8.6]

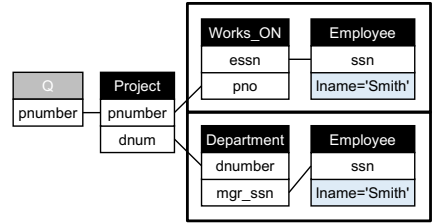

(d)

9. Get part numbers for parts that either weigh more than 16 pounds or are supplied by supplier S2, or both.

```
RANGEVAR PV RANGES OVER ( { PX.PNO } WHERE PX.WEIGHT > 16.0 ,
                          { SPX.PNO } WHERE SPX.SNO = 'S2' );
{ PV.PNO } WHERE TRUE
```

(e) [20, Query 9, Ch.8.3]

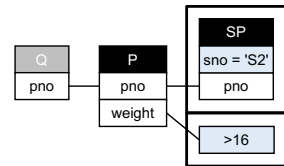

(f)

Fig. 27. Appendix F: RepresentationB representations for 3 relational query patterns that cannot be represented by prior approaches.