

Input-Output Stability of Gradient Descent: A Discrete-Time Passivity-Based Approach

Sepehr Moalemi¹ and James Richard Forbes¹

Abstract—This paper presents a discrete-time passivity-based analysis of the gradient descent method for a class of functions with sector-bounded gradients. Using a loop transformation, it is shown that the gradient descent method can be interpreted as a passive controller in negative feedback with a very strictly passive system. The passivity theorem is then used to guarantee input-output stability, as well as the global convergence, of the gradient descent method. Furthermore, provided that the lower and upper sector bounds are not equal, the input-output stability of the gradient descent method is guaranteed using the weak passivity theorem for a larger choice of step size. Finally, to demonstrate the utility of this passivity-based analysis, a new variation of the gradient descent method with variable step size is proposed by gain-scheduling the input and output of the gradient.

Index Terms—Gradient descent, passivity-based control, input-output stability.

I. INTRODUCTION

Optimization is an indispensable tool used in many branches of engineering. Recently, popular first-order optimization methods such as gradient descent, Polyak’s heavy-ball [1], and Nesterov’s accelerated method [2], have been analyzed through the lens of feedback control in a discrete-time setting.

In particular, in [3], for a function with sector-bounded gradient, the circle criterion is used to derive expressions for the parameters of the heavy ball method that guarantee its global convergence. This result was extended in [4] by incorporating an additional parameter, leading to the new generalized accelerated gradient method. The small gain theorem is used in [5] to relate the input-output gain computations of a defined complementary sensitivity function to the convergence properties of gradient descent (GD) methods. Additionally, [5] demonstrates a connection between the step size selection of the gradient method and \mathcal{H}_∞ state feedback synthesis. For a class of convex constraint-coupled optimization problems, a passivity-based analysis of the alternating direction method of multipliers (ADMM) is provided in [6]. Dissipativity theory and Lyapunov-based approaches for algorithm analysis have also been studied in [7, 8]. Other robust control tools such as integral quadratic constraints (IQCs) have been used in the analysis and synthesis of novel first-order iterative optimization methods. Within the context of optimization, the IQC framework is first used in [9] to derive numerical upper bounds on convergence rates

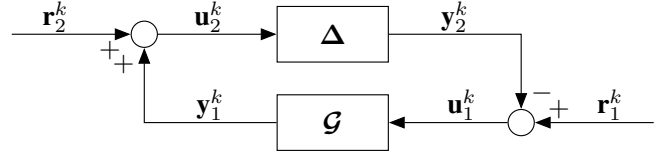

Fig. 1. The negative feedback interconnection of two systems \mathcal{G} and Δ .

of first-order methods. For the class of m -strongly convex and L -smooth functions, a graphical design procedure based on IQCs is used to derive the optimal parameters for the triple momentum method introduced in [10]. The IQC framework is also used in [11] to perform an analysis of GD with varying step sizes, where the algorithm is modeled as a linear parameter-varying (LPV) system.

This paper considers a general class of possibly non-convex functions with a unique global minimizer and a sector-bounded gradient, with lower bound m and upper bound L . Inspired by [5, 9], the GD method is recast as a discrete-time linear time-invariant (LTI) controller \mathcal{G} in negative feedback with a static memoryless nonlinearity Δ , as per Figure 1. It is shown that the GD controller \mathcal{G} , as presented in [9], is strictly proper and, therefore, *not* passive. As such, a loop transformation is performed, adding a positive feedthrough term to \mathcal{G} and a positive feedback term to Δ . It is then shown that the GD method can be interpreted as a passive controller in negative feedback with a very strictly passive (VSP) system, provided the step size, α , satisfies $\alpha \in (0, 2/L)$. The *strong passivity theorem* is then used to guarantee the input-output stability, as well as global convergence, of the GD method. Provided the lower and upper sector bounds are not equal, input-output stability of the GD method can still be guaranteed for $\alpha = 2/L$, using the *weak passivity theorem*. Finally, using a discrete-time adaptation of the gain-scheduling architecture in [12], a new variation of the GD method with varying step size is proposed, where the input and output of the gradient are scaled using the scheduling functions. In summary, the novel contributions of this work are as follows:

- 1) Presenting a discrete-time passivity-based analysis of the GD method for a general class of possibly non-convex functions, having a unique global minimizer and a sector-bounded gradient.
- 2) Demonstrating input-output stability of the GD method for a larger step size using the weak passivity theorem.
- 3) Introducing a variation of the GD method with variable step size, using a passivity-based gain-scheduled control architecture.

¹Sepehr Moalemi sepehr.moalemi@mail.mcgill.ca and James Richard Forbes james.richard.forbes@mcgill.ca are with the Department of Mechanical Engineering, McGill University, 817 Sherbrooke St. W., Montreal, QC H3A 0C3, Canada.

Funding provided by the NSERC Discover Grant program.

The remainder of this paper is as follows. Preliminaries and control interpretation of the GD method are presented in Section II. The loop transformation and passivity-based analysis of the GD method are presented in Section III. A discussion on the connection between the input-output stability of the GD method and the convergence of the algorithm, as well as the extension of the passivity-based analysis to the case of time-varying step sizes is presented in Section IV. Numerical results are shown in Section V, followed by closing remarks in Section VI.

II. PRELIMINARIES

A. Notation

Scalars, column matrices, and matrices are denoted as $\alpha \in \mathbb{R}$, $\mathbf{v} \in \mathbb{R}^n$, and $\mathbf{A} \in \mathbb{R}^{n \times m}$, respectively. Operators are denoted as \mathcal{G} and function classes are denoted as \mathcal{F} . A positive definite matrix is denoted as $\mathbf{A} \succ 0$ and a negative semidefinite matrix is denoted as $\mathbf{A} \preceq 0$. The identity and zero matrices are $\mathbf{1}$ and $\mathbf{0}$, respectively.

B. Spaces and Operators

Definition 1 (Truncation operator [13]): For a function $\mathbf{u} : \mathbb{Z}_{\geq 0} \rightarrow \mathbb{R}^n$ and $T \in \mathbb{Z}_{>0}$, its truncation, \mathbf{u}_T , is defined as $\mathbf{u}_T(k) = \mathbf{u}(k)$ for $k < T$ and $\mathbf{u}_T(k) = \mathbf{0}$ for $t \geq T$.

Definition 2 (Truncated inner product [13]): For functions $\mathbf{u}, \mathbf{y} : \mathbb{Z}_{\geq 0} \rightarrow \mathbb{R}^n$, the truncated inner product over the discrete-time interval $\mathcal{T} = \{0, 1, \dots, T-1\}$ is defined as $\langle \mathbf{u}, \mathbf{y} \rangle_T = \langle \mathbf{u}_T, \mathbf{y}_T \rangle = \sum_{k \in \mathcal{T}} \mathbf{u}^\top(k) \mathbf{y}(k)$, $\forall T \in \mathbb{Z}_{>0}$.

Definition 3 (ℓ_{2e} and ℓ_2 function spaces [13]): Given a function $\mathbf{u} : \mathbb{Z}_{\geq 0} \rightarrow \mathbb{R}^n$, $\mathbf{u} \in \ell_{2e}$ if $\|\mathbf{u}\|_{2T}^2 = \langle \mathbf{u}, \mathbf{u} \rangle_T < \infty$, for all $T \in \mathbb{Z}_{>0}$. Moreover, $\mathbf{u} \in \ell_2$ if $\|\mathbf{u}\|_2^2 = \langle \mathbf{u}, \mathbf{u} \rangle < \infty$.

Definition 4 (ℓ_2 stability [13]): The operator $\mathcal{G} : \ell_{2e} \rightarrow \ell_{2e}$ is ℓ_2 -stable if $\mathcal{G}\mathbf{u} \in \ell_2$ for all $\mathbf{u} \in \ell_{2e}$.

C. Passivity Theorem and Definitions

Definition 5 (Passivity [13]): Consider a square system with input $\mathbf{u} \in \ell_{2e}$ and output $\mathbf{y} \in \ell_{2e}$ mapped through the operator $\mathcal{G} : \ell_{2e} \rightarrow \ell_{2e}$. The system \mathcal{G} is

i) *passive* if $\exists \beta \in \mathbb{R}_{\leq 0}$ such that

$$\langle \mathbf{u}, \mathbf{y} \rangle_T \geq \beta, \quad \forall \mathbf{u} \in \ell_{2e}, \forall T \in \mathbb{Z}_{>0},$$

ii) *input strictly passive (ISP)* if $\exists \beta \in \mathbb{R}_{\leq 0}$ and $\exists \delta \in \mathbb{R}_{>0}$ such that

$$\langle \mathbf{u}, \mathbf{y} \rangle_T \geq \beta + \delta \|\mathbf{u}\|_{2T}^2, \quad \forall \mathbf{u} \in \ell_{2e}, \forall T \in \mathbb{Z}_{>0},$$

iii) *very strictly passive (VSP)* if $\exists \beta \in \mathbb{R}_{\leq 0}$ and $\exists \delta, \varepsilon \in \mathbb{R}_{>0}$ such that

$$\langle \mathbf{u}, \mathbf{y} \rangle_T \geq \beta + \delta \|\mathbf{u}\|_{2T}^2 + \varepsilon \|\mathbf{y}\|_{2T}^2, \quad \forall \mathbf{u} \in \ell_{2e}, \forall T \in \mathbb{Z}_{>0}.$$

Lemma 1 (Positive real [14, Lemma 3]): Let $\mathbf{G}(z)$ be a square matrix of real rational functions of z and let $(\mathbf{A}, \mathbf{B}, \mathbf{C}, \mathbf{D})$ be a minimal realization of $\mathbf{G}(z)$. Then $\mathbf{G}(z)$ is *positive real* if and only if $\exists \mathbf{P} = \mathbf{P}^\top \succ 0$ such that

$$\begin{bmatrix} \mathbf{A}^\top \mathbf{P} \mathbf{A} - \mathbf{P} & \mathbf{A}^\top \mathbf{P} \mathbf{B} - \mathbf{C}^\top \\ (\mathbf{A}^\top \mathbf{P} \mathbf{B} - \mathbf{C}^\top)^\top & \mathbf{B}^\top \mathbf{P} \mathbf{B} - (\mathbf{D} + \mathbf{D}^\top) \end{bmatrix} \preceq 0. \quad (1)$$

Remark 1: In Lemma 1, a necessary and sufficient condition for a positive real transfer matrix is given. However, an LTI system is passive if and only if it has a positive real transfer function [15, Theorem 13.27].

Theorem 1 (Weak passivity theorem [13]): Consider two systems $\mathcal{G} : \ell_{2e} \rightarrow \ell_{2e}$ and $\Delta : \ell_{2e} \rightarrow \ell_{2e}$ in negative feedback as per Figure 1 with $\mathbf{r}_2 = \mathbf{0}$. If \mathcal{G} is passive, Δ is ISP, and $\mathbf{r}_1 \in \ell_2$, then $\mathbf{y}_1 \in \ell_2$.

Theorem 2 (Strong passivity theorem [13]): Consider two systems $\mathcal{G} : \ell_{2e} \rightarrow \ell_{2e}$ and $\Delta : \ell_{2e} \rightarrow \ell_{2e}$ in negative feedback as per Figure 1. If \mathcal{G} is passive, Δ is VSP, and $\mathbf{r}_1, \mathbf{r}_2 \in \ell_2$, then $\mathbf{y}_1, \mathbf{y}_2 \in \ell_2$.

D. Function Classes

Denote the set of continuously differentiable functions $f : \mathbb{R}^n \rightarrow \mathbb{R}$ that are m -strongly convex and L -smooth with $0 < m \leq L$ as $\mathcal{F}_{m,L}$.

Remark 2: Consider a function $f \in \mathcal{F}_{m,L}$ and its unique global minimizer \mathbf{x}^* such that $\nabla f(\mathbf{x}^*) = \mathbf{0}$. The function $g(\mathbf{x}) = f(\mathbf{x}) - \frac{m}{2} \|\mathbf{x}\|_2^2$ is convex and $(L-m)$ -smooth. The co-coercivity of ∇g can be written as

$$\langle \mathbf{x} - \mathbf{x}^*, \nabla f(\mathbf{x}) \rangle \geq \frac{mL}{m+L} \|\mathbf{x} - \mathbf{x}^*\|_2^2 + \frac{1}{m+L} \|\nabla f(\mathbf{x})\|_2^2, \quad (2)$$

for all $\mathbf{x} \in \mathbb{R}^n$ [9, Proposition 5].

The inequality in (2) encloses $\nabla f(\mathbf{x})$ in the sector between two lines with slopes m and L [7]. More generally, the set of continuously differentiable functions with unique global minimizers satisfying (2) is denoted as $\mathcal{S}_{m,L}$. This class of functions has sector-bounded gradients and contains non-convex functions as-well, meaning $\mathcal{F}_{m,L} \subset \mathcal{S}_{m,L}$ [5].

E. Optimization Problem

Consider the unconstrained optimization problem

$$\min_{\mathbf{x} \in \mathbb{R}^n} f(\mathbf{x}), \quad (3)$$

where $f \in \mathcal{S}_{m,L}$. The GD method with the update rule

$$\mathbf{x}(k+1) = \mathbf{x}(k) - \alpha \nabla f(\mathbf{x}(k)) \quad (4)$$

can be used to solve (3) using an initialization $\mathbf{x}(0) \in \mathbb{R}^n$ and a constant step size $\alpha \in \mathbb{R}_{>0}$.

F. Control Interpretation of Gradient Descent

The discrete-time feedback representation of GD is discussed in [9, Section 2]. By modifying the approach in [9], the GD method can be interpreted as a static memoryless nonlinearity $\Delta = \nabla f$ in negative feedback with an LTI dynamical system \mathcal{G} , as shown in Figure 1. Henceforth, the notation $\mathbf{x}(k)$ is abbreviated to \mathbf{x}^k .

Remark 3: Similar to [5], it is assumed that Δ in Figure 1 maps \mathbf{u}_2 to \mathbf{y}_2 as $\mathbf{y}_2^k = \nabla f(\mathbf{u}_2^k + \mathbf{x}^*)$, such that for $\mathbf{u}_2^k = \mathbf{0}$, $\mathbf{y}_2^k = \nabla f(\mathbf{x}^*) = \mathbf{0}$. Using the shifted state $\boldsymbol{\xi}^k = \mathbf{x}^k - \mathbf{x}^*$, the LTI system \mathcal{G} in Figure 1 can be represented as

$$\boldsymbol{\xi}^{k+1} = \mathbf{A} \boldsymbol{\xi}^k + \mathbf{B} \mathbf{u}_1^k, \quad (5a)$$

$$\mathbf{y}_1^k = \mathbf{C} \boldsymbol{\xi}^k + \mathbf{D} \mathbf{u}_1^k. \quad (5b)$$

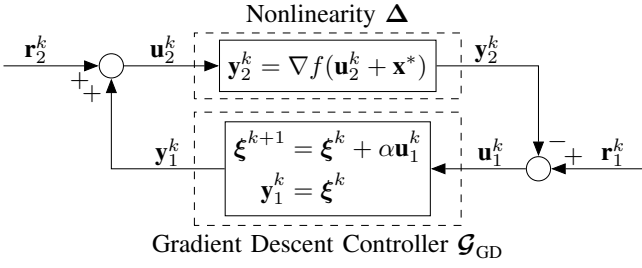

Fig. 2. The negative feedback interconnection of the GD controller, \mathcal{G}_{GD} , and the nonlinearity Δ , being the shifted gradient that maps zero inputs to zero outputs.

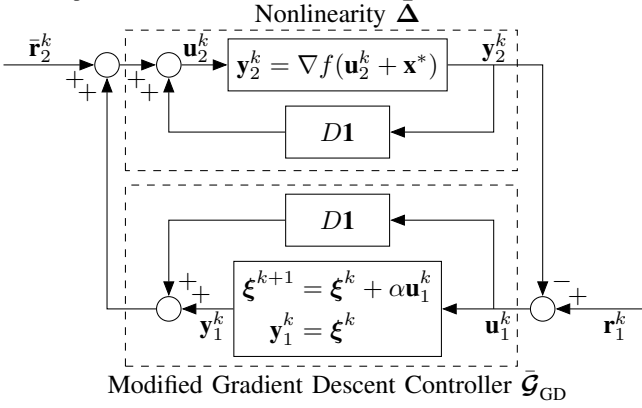

Fig. 3. Loop transformation of the negative feedback interconnection representation of the GD method in Figure 2. The loop transformation introduces a feedthrough term $D\mathbf{1}$, resulting in the modified GD controller $\bar{\mathcal{G}}_{\text{GD}}$, the nonlinearity $\bar{\Delta}$, and $\bar{\mathbf{r}}_2^k = \mathbf{r}_2^k - D\mathbf{r}_1^k$.

The GD update rule in (4) can then be written in the form of (5) with minimal realization $(\mathbf{A}, \mathbf{B}, \mathbf{C}, \mathbf{D}) = (\mathbf{1}, \alpha\mathbf{1}, \mathbf{1}, \mathbf{0})$ as shown in Figure 2. Additionally, the convergence rate of the GD method becomes analogous to the rate at which $\xi^k \rightarrow \mathbf{0}$.

III. MAIN CONTRIBUTION

The GD controller \mathcal{G}_{GD} , shown in Figure 2, is strictly proper, since $\mathbf{D} = \mathbf{0}$. However, a discrete-time system of the form (5) with $\mathbf{D} = \mathbf{0}$ can never be passive [16, Remark 2.7]. Therefore, to analyze the passivity of \mathcal{G}_{GD} , the loop transformation in Figure 3 is performed, effectively introducing a constant feedthrough term $\mathbf{D} = D\mathbf{1}$, where $D \in \mathbb{R}_{>0}$. This feedthrough term results in the modified GD controller $\bar{\mathcal{G}}_{\text{GD}}$ with a minimal realization $(\mathbf{A}, \mathbf{B}, \mathbf{C}, \mathbf{D}) = (\mathbf{1}, \alpha\mathbf{1}, \mathbf{1}, D\mathbf{1})$. This loop transformation does not change the closed-loop dynamics of the system, meaning Figure 3 still represents the GD method with update rule (4). Within the context of convex constrained optimization problems, similar loop transformation techniques have been used in [6, 17] to analyze the stability of discrete-time ADMM and primal-dual algorithms, respectively. Herein, the sufficient amount of the feedthrough term D required to render $\bar{\mathcal{G}}_{\text{GD}}$ passive is shown to be directly related to the step size α .

Lemma 2: The modified GD controller $\bar{\mathcal{G}}_{\text{GD}}$ in Figure 3 is passive if and only if $D \geq \alpha/2 > 0$.

Proof: Substituting the minimal realization of $\bar{\mathcal{G}}_{\text{GD}}$ into (1) yields

$$\mathbf{M} = \begin{bmatrix} \mathbf{0} & \alpha\mathbf{P} - \mathbf{1} \\ \alpha\mathbf{P} - \mathbf{1} & \alpha^2\mathbf{P} - 2D\mathbf{1} \end{bmatrix}. \quad (6)$$

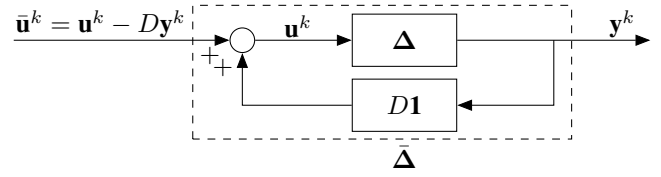

Fig. 4. A discrete-time system $\bar{\Delta}$, composed of the positive feedback interconnection of a VSP system Δ , and the feedthrough term $D\mathbf{1}$.

From the Schur complement lemma, $\mathbf{M} \preceq 0$ if and only if

$$\alpha\mathbf{P} - \mathbf{1} = \mathbf{0}, \quad \alpha^2\mathbf{P} - 2D\mathbf{1} \preceq 0. \quad (7)$$

From (7), it follows that $\mathbf{P} = \frac{1}{\alpha}$ and $D \geq \alpha/2$, for $\alpha \in \mathbb{R}_{>0}$. Finally, Lemma 1 in tandem with Remark 1 concludes that $\bar{\mathcal{G}}_{\text{GD}}$ is passive if and only if $D \geq \alpha/2$, for $\alpha \in \mathbb{R}_{>0}$. ■

Next, it is shown that for $f \in \mathcal{S}_{m,L}$, the sector-bound condition in (2) leads to Δ being VSP.

Lemma 3: Consider a function $f \in \mathcal{S}_{m,L}$ with $m, L \in \mathbb{R}_{>0}$, such that $m \leq L$, and its unique global minimizer \mathbf{x}^* . The operator Δ in Figure 2 mapping \mathbf{u}_2^k to \mathbf{y}_2^k as $\mathbf{y}_2^k = \nabla f(\mathbf{u}_2^k + \mathbf{x}^*)$ is VSP with

$$\varepsilon = \frac{1}{m+L} > 0, \quad \delta = \frac{mL}{m+L} > 0. \quad (8)$$

Proof: For a given discrete time interval $\mathcal{T} = \{0, 1, \dots, T-1\}$, with $T \in \mathbb{Z}_{>0}$, consider the iterates $\{\mathbf{y}_2^k\}$ obtained from the operator Δ , such that $\mathbf{y}_2^k = \nabla f(\mathbf{u}_2^k + \mathbf{x}^*)$. For $f \in \mathcal{S}_{m,L}$, the sector-bound inequality in (2) can be written as

$$\langle \mathbf{u}_2^k, \mathbf{y}_2^k \rangle \geq \frac{mL}{m+L} \|\mathbf{u}_2^k\|_2^2 + \frac{1}{m+L} \|\mathbf{y}_2^k\|_2^2, \quad (9)$$

for all $\mathbf{u}_2^k \in \mathbb{R}^n$ and $k \in \mathcal{T}$. Summing (9) over $k \in \mathcal{T}$ and defining ε and δ as per (8), it follows that

$$\sum_{k \in \mathcal{T}} \langle \mathbf{u}_2^k, \mathbf{y}_2^k \rangle = \langle \mathbf{y}_2, \mathbf{u}_2 \rangle_T \geq \delta \|\mathbf{u}_2\|_{2T}^2 + \varepsilon \|\mathbf{y}_2\|_{2T}^2, \quad (10)$$

for all $\mathbf{u} \in \ell_{2e}$ and $T \in \mathbb{Z}_{>0}$. Therefore, Δ is VSP with $\varepsilon, \delta \in \mathbb{R}_{>0}$ and $\beta = 0$. ■

What remains is to derive an upper bound on D to ensure the positive feedback interconnection of Δ and $D\mathbf{1}$ as per Figure 4 results in a VSP system, $\bar{\Delta}$.

Lemma 4: Consider a VSP system Δ with ε and δ in (8) and $\beta = 0$. Given a feedthrough term $D\mathbf{1}$ with $D \in \mathbb{R}_{>0}$, if $D < 1/L$, the positive feedback interconnection of Δ and $D\mathbf{1}$ results in a VSP system $\bar{\Delta}$.

Proof: From the VSP property of Δ , it follows that

$$\langle \mathbf{u}, \mathbf{y} \rangle_T \geq \delta \|\mathbf{u}\|_{2T}^2 + \varepsilon \|\mathbf{y}\|_{2T}^2, \quad \forall \mathbf{u} \in \ell_{2e}, \forall T \in \mathbb{Z}_{>0}. \quad (11)$$

Adding and subtracting the terms $\delta D^2 \|\mathbf{y}\|_{2T}^2$ and $2\delta D \langle \mathbf{u}, \mathbf{y} \rangle_T$ from (11) and completing the square, it follows that

$$\langle \mathbf{u}, \mathbf{y} \rangle_T \geq \delta \|\bar{\mathbf{u}}\|_{2T}^2 + (\varepsilon - \delta D^2) \|\mathbf{y}\|_{2T}^2 + 2\delta D \langle \mathbf{u}, \mathbf{y} \rangle_T, \quad (12)$$

where $\bar{\mathbf{u}}^k = \mathbf{u}^k - D\mathbf{y}^k$. Rearranging (12) and collecting similar terms yields

$$(1 - 2\delta D) \langle \mathbf{u}, \mathbf{y} \rangle_T \geq \delta \|\bar{\mathbf{u}}\|_{2T}^2 + (\varepsilon - \delta D^2) \|\mathbf{y}\|_{2T}^2. \quad (13)$$

For $1 - 2\delta D > 0$, it follows that

$$\langle \mathbf{u}, \mathbf{y} \rangle_T \geq \frac{\delta}{1 - 2\delta D} \|\bar{\mathbf{u}}\|_{2T}^2 + \frac{(\varepsilon - \delta D^2)}{1 - 2\delta D} \|\mathbf{y}\|_{2T}^2. \quad (14)$$

Subtracting $D\|\mathbf{y}\|_{2T}^2$ from both sides of (14) and combining similar terms results in

$$\langle \bar{\mathbf{u}}, \mathbf{y} \rangle_T \geq \frac{\delta}{1 - 2\delta D} \|\bar{\mathbf{u}}\|_{2T}^2 + \frac{(\varepsilon - D + \delta D^2)}{1 - 2\delta D} \|\mathbf{y}\|_{2T}^2 \quad (15)$$

$$= \bar{\delta} \|\bar{\mathbf{u}}\|_{2T}^2 + \bar{\varepsilon} \|\mathbf{y}\|_{2T}^2, \quad (16)$$

where $\bar{\delta} = \delta/(1 - 2\delta D)$ and $\bar{\varepsilon} = (\varepsilon - D + \delta D^2)/(1 - 2\delta D)$. For $\bar{\Delta}$ to be VSP with $\bar{\varepsilon}, \bar{\delta} \in \mathbb{R}_{>0}$, it is required that

$$D < \frac{1}{2\bar{\delta}}, \quad 0 < \varepsilon - D + \delta D^2. \quad (17)$$

Note, $D^* = 1/(2\bar{\delta})$ is the unique global minimum of the quadratic equation $0 = \varepsilon - D + \delta D^2$. Substituting $\varepsilon = 1/(m + L)$ and $\delta = mL/(m + L)$ into (17), it follows that

$$D < \frac{m + L}{2mL}, \quad 0 < \frac{1}{m + L} - D + \frac{mL}{m + L} D^2. \quad (18)$$

The roots of the quadratic equation (18) are $r_1 = 1/L$ and $r_2 = 1/m$. For $m \leq L$, it follows that $r_1 \leq D^* \leq r_2$, where equality is achieved for $m = L$. For $D < r_1 = 1/L$, both inequalities in (18) are satisfied, and therefore, the positive feedback interconnection of Δ and $D\mathbf{1}$ results in a VSP system $\bar{\Delta}$, with $\bar{\varepsilon}, \bar{\delta} \in \mathbb{R}_{>0}$. ■

Lemma 5: Consider a VSP system Δ with ε and δ in (8) and $\beta = 0$. Given a feedthrough term $D\mathbf{1}$ with $D \in \mathbb{R}_{>0}$, if $D = 1/L$ and $m < L$, the positive feedback interconnection of Δ and $D\mathbf{1}$ results in an ISP system $\bar{\Delta}$.

Proof: The proof follows similar to Lemma 4, with the only difference being that for $\bar{\Delta}$ to be ISP, with $\bar{\delta} \in \mathbb{R}_{>0}$ and $\bar{\varepsilon} = 0$, it is required that

$$D < \frac{m + L}{2mL}, \quad 0 = \frac{1}{m + L} - D + \frac{mL}{m + L} D^2. \quad (19)$$

Therefore, to satisfy both conditions in (19), it is required that $D = 1/L$ and $m < L$. ■

Finally, the passivity theorem is invoked to analyze the input-output stability of the GD method represented as the negative feedback interconnection in Figure 3.

Theorem 3: Consider the negative feedback interconnection representation of the GD method shown in Figure 3, where $f \in \mathcal{S}_{m,L}$ with $0 < m \leq L$, and $D = \alpha/2$.

i) Provided the step size $\alpha \in (0, \frac{2}{L})$ and $\mathbf{r}_1, \bar{\mathbf{r}}_2 \in \ell_2$, then $\mathbf{y}_1 + D\mathbf{u}_1 \in \ell_2$ and $\mathbf{y}_2 \in \ell_2$.

ii) Additionally, for $m < L$, provided the step size $\alpha \in (0, \frac{2}{L}]$, $\bar{\mathbf{r}}_2 = \mathbf{0}$, and $\mathbf{r}_1 \in \ell_2$, then $\mathbf{y}_1 + D\mathbf{u}_1 \in \ell_2$.

Proof: As per Lemma 2, $\bar{\mathcal{G}}_{\text{GD}}$ is passive if and only if $0 < \alpha/2 \leq D$. Moreover, for $f \in \mathcal{S}_{m,L}$, provided $D < 1/L$, $\bar{\Delta}$ is VSP, as per Lemma 4. It follows that for $D = \alpha/2$ with $\alpha \in (0, 2/L)$, $\bar{\mathcal{G}}_{\text{GD}}$ is passive and $\bar{\Delta}$ is VSP. The proof of (i) then follows from Theorem 2. Furthermore, assuming $m < L$ and $D = \alpha/2 = 1/L$, $\bar{\Delta}$ is ISP, as per Lemma 5. Consequently, the proof of (ii) then follows from Theorem 1, where for $\alpha = 2/L$, $\bar{\Delta}$ is ISP and $\bar{\mathcal{G}}_{\text{GD}}$ is passive. ■

IV. DISCUSSION AND EXTENSIONS

The passivity-based analysis presented in Section III decouples the stability analysis of the GD controller from the properties of the objective function. Notice, Lemma 2 provides a lower bound on the feedthrough term D and dictates the necessary and sufficient condition for the controller to be passive. On the other hand, using the sector-bounds of the nonlinearity Δ , Lemmas 3 to 5 provide an upper bound on the feedthrough term D . Therefore, for a function $f \in \mathcal{S}_{m,L}$ with $0 < m \leq L$, the passivity-based analysis of other first-order optimization algorithms can be approached as follows:

- 1) Cast the algorithm as an LTI controller in negative feedback with a static memoryless nonlinearity as per Figure 2.
- 2) Using the minimal realization of the controller, determine the lower bound on the feedthrough term D by solving the linear matrix inequality (LMI) in (1).
- 3) Determine the bounds on the algorithm's step size(s) that guarantee the feedthrough term D is within the bounds provided by Lemmas 4 and 5. Consequently, use the appropriate passivity theorem to guarantee the input-output stability of the algorithm.

A. Interpretation of Input-Output Stability

To draw a connection between the input-output stability of the negative feedback interconnection in Figure 3 and the convergence of the GD method in (4), it is assumed that $\mathbf{r}_1^k = \bar{\mathbf{r}}_2^k = \mathbf{0}$ for all $k \in \mathbb{Z}_{\geq 0}$.

For $f \in \mathcal{S}_{m,L}$ with $0 < m \leq L$, Theorem 3-(i) provides a sufficient condition to ensure the ℓ_2 -stability of $\bar{\mathcal{G}}_{\text{GD}}$ and $\bar{\Delta}$. Firstly, if $\mathbf{y}_2 \in \ell_2$, then $\mathbf{y}_2^k \rightarrow \mathbf{0}$ as $k \rightarrow \infty$ [13]. It follows that

$$\mathbf{y}_2^k = \nabla f(\boldsymbol{\xi}^k + \mathbf{x}^*) = \nabla f(\mathbf{x}^k) \rightarrow \mathbf{0}. \quad (20)$$

Similarly, $\mathbf{y}_1 + D\mathbf{u}_1 \in \ell_2$ implies that

$$\mathbf{x}^k - D\nabla f(\mathbf{x}^k) \rightarrow \mathbf{x}^*. \quad (21)$$

From (20) and (21), it follows that $\mathbf{x}^k \rightarrow \mathbf{x}^*$. Therefore, the GD method is globally convergent for $\alpha \in (0, 2/L)$. This result is consistent with Polyak's convergence analysis of the GD method in [18, Theorem 1], where f is only assumed to be L -smooth and bounded from below. For $f \in \mathcal{F}_{m,L}$, this convergence region is also obtained within the framework of equilibrium-independent dissipativity (EID) with quadratic supply rates in [19, Example 5.4].

As discussed in [18], for $f(x) = Lx^2/2$ with $x \in \mathbb{R}$ and $L \in \mathbb{R}_{>0}$, the choice of $\alpha \geq 2/L$ results in $f(\mathbf{x}^{k+1}) \geq f(\mathbf{x}^k)$, for $k \in \mathbb{Z}_{\geq 0}$. Here, for $f \in \mathcal{S}_{m,L}$ with $m < L$, Theorem 3-(ii) can only guarantee (21), which does not necessarily imply that $\mathbf{x}^k \rightarrow \mathbf{x}^*$. In fact, inspired by [18], consider the objective function $f(\mathbf{x}) = \frac{1}{2}\mathbf{x}^\top \mathbf{A}\mathbf{x}$, where $\mathbf{x} = [x_1 \ x_2]^\top$, $\mathbf{A} = \text{diag}(m, L)$, and $m < L$. It can be shown that for $\alpha = 2/L$, the GD method in (4), initialized using any $\mathbf{x}^0 \in \mathbb{R}^2$ leads to $x_2^{k+1} = (-1)^{k+1}x_2^k$, for $k \in \mathbb{Z}_{\geq 0}$. However, given that $D = \alpha/2 = 1/L$, (21) still holds since $x_2^k - (1/L)(Lx_2^k) = x_2^k - x_2^k = 0$. Therefore, although the series of iterations $\{x_2^k\}$ produced by the GD method does not

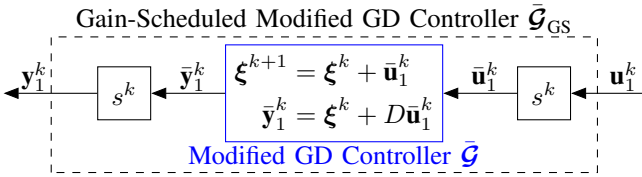

(a) Gain-scheduling a modified GD controller $\bar{\mathcal{G}}$ with step size $\alpha = 1$. The scheduling function s^k is used to scale the input and output of $\bar{\mathcal{G}}$ such that $\bar{\mathbf{u}}_1^k = s^k \mathbf{u}_1^k$ and $\bar{\mathbf{y}}_1^k = s^k \mathbf{y}_1^k$.

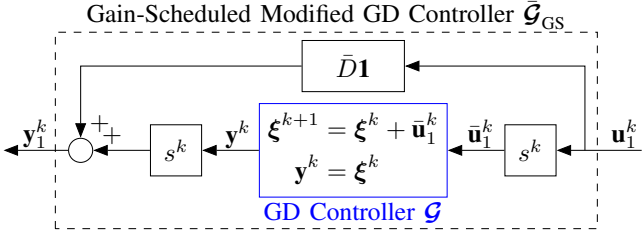

(b) Gain-scheduling a GD controller \mathcal{G} with step size $\alpha = 1$. The scheduling function s^k is used to scale the input and output of \mathcal{G} . A feedthrough term $\bar{D}\mathbf{1} = (s^k)^2 D\mathbf{1}$ is added such that $\mathbf{y}_1^k = \bar{D}\mathbf{u}_1^k + s^k \mathbf{y}^k$.

Fig. 5. Two gain-scheduling architectures resulting in the same gain-scheduled modified GD controller $\bar{\mathcal{G}}_{GS}$ with minimal realization $(\bar{\mathbf{A}}, \bar{\mathbf{B}}, \bar{\mathbf{C}}, \bar{\mathbf{D}}) = (\mathbf{1}, s^k \mathbf{1}, s^k \mathbf{1}, (s^k)^2 D\mathbf{1})$.

converge to x_2^* , (21) still approaches x_2^* . More generally, from (21), it follows that

$$\left(\mathbf{x}^k - D\nabla f(\mathbf{x}^k) \right) - \left(\mathbf{x}^{k-1} - D\nabla f(\mathbf{x}^{k-1}) \right) \rightarrow \mathbf{0}. \quad (22)$$

Since $D = \alpha/2$, substituting the GD update rule (4) into (22) and simplifying yields $\nabla f(\mathbf{x}^k) + \nabla f(\mathbf{x}^{k-1}) \rightarrow \mathbf{0}$. As such, in practice, the stopping criterion

$$\left\| \nabla f(\mathbf{x}^k) + \nabla f(\mathbf{x}^{k-1}) \right\|_2^2 < \epsilon, \quad (23)$$

for an arbitrarily small $\epsilon \in \mathbb{R}_{>0}$, can be used to verify the relation in (21).

B. Extension to Time Varying Step Sizes

This subsection introduces a new variation of the GD method with varying step size. The gain-scheduling architecture presented in [12] is adapted to discrete-time systems and used to schedule the input and output of the modified GD controller.

Consider the modified GD controller $\bar{\mathcal{G}}$ in Figure 5a, with a fixed step size $\alpha = 1$. As per Lemma 2, $\bar{\mathcal{G}}$ is passive if and only if $D \geq 1/2$. From Definition 5, it follows that there exists a $\beta \in \mathbb{R}_{\leq 0}$ such that $\beta \leq \langle \bar{\mathbf{y}}_1, \bar{\mathbf{u}}_1 \rangle_T$ for all $\bar{\mathbf{u}}_1 \in \ell_{2e}$ and $T \in \mathbb{Z}_{>0}$. This controller is gain-scheduled as per [12] using some general scheduling function $s^k \in \mathbb{R} \setminus 0$, for $k \in \mathcal{T} = \{0, 1, \dots, T-1\}$, with $T \in \mathbb{Z}_{>0}$. From the scheduling relation in Figure 5a, it follows that

$$\beta \leq \langle \bar{\mathbf{y}}_1, \bar{\mathbf{u}}_1 \rangle_T = \langle \bar{\mathbf{y}}_1, s\mathbf{u}_1 \rangle_T = \langle s\bar{\mathbf{y}}_1, \mathbf{u}_1 \rangle_T = \langle \mathbf{y}_1, \mathbf{u}_1 \rangle_T.$$

Therefore, the gain-scheduling of a passive discrete-time system as per Figure 5a results in a gain-scheduled passive system. As shown in Figure 5b, $\bar{\mathcal{G}}_{GS}$ can also be constructed by adding a feedthrough term $\bar{D}\mathbf{1} = (s^k)^2 D\mathbf{1}$ to the gain-scheduled GD controller. It follows that $\bar{\mathcal{G}}_{GS}$ is passive if

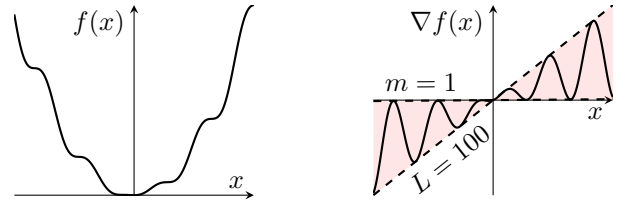

Fig. 6. The function $f \in \mathcal{S}_{m,L}$ defined in (25) for $m = 1$ and $L = 100$. This function is non-convex but has a sector-bounded gradient and a unique global minimizer at $x^* = 0$.

and only if $\bar{D} \geq (s^k)^2/2$. Moreover, the negative feedback interconnection of $\bar{\mathcal{G}}_{GS}$ and $\bar{\Delta}$, as per Figure 3 can then be used to represent a variation on the GD algorithm with the update rule

$$\mathbf{x}^{k+1} = \mathbf{x}^k - s^k \nabla f(s^k \mathbf{x}^k), \quad (24)$$

where the scheduling function $s^k \in \mathbb{R} \setminus 0$ can be used to represent time varying step sizes. For a constant $s^k = s$, using the change of variable $\bar{\mathbf{x}}^k = s\mathbf{x}^k$, the update rule in (24) can be written as $\bar{\mathbf{x}}^{k+1} = \bar{\mathbf{x}}^k - s^2 \nabla f(\bar{\mathbf{x}}^k)$, recovering the original GD algorithm with step size $\alpha = s^2$. For $f \in \mathcal{S}_{m,L}$, $\bar{\Delta}$ is VSP as per Lemma 4, or ISP as per Lemma 5, provided $\bar{D} < 1/L$ or $\bar{D} = 1/L$, respectively. Consequently, using the lower bound $\bar{D} \geq (s^k)^2/2$, a similar analysis as Theorem 3 shows that for $m < L$, provided $\max_{k \in \mathcal{T}} |s^k| \in (0, \sqrt{2/L}]$, then $\mathbf{y}_1^k \in \ell_2$.

V. NUMERICAL RESULTS

In this section, the performance of the GD method in (4) is compared with the proposed gain-scheduled GD method in (24). The objective function of interest is taken from [3], where $f \in \mathcal{S}_{m,L}$ is defined as

$$f(x) = \frac{L-m}{4} \left(\frac{L+m}{L-m} x^2 + 2 \sin(x) - 2x \cos(x) \right), \quad (25)$$

for $m = 1$ and $L = 100$. As shown in Figure 6, the function f is non-convex but has a sector-bounded gradient and a unique global minimizer at $x^* = 0$.

To solve the unconstrained optimization problem in (3) involving the function f , the GD method in (4) and the proposed gain-scheduled GD method in (24) are implemented for various choices of step sizes and scheduling functions. Three choices of step sizes are considered for the GD method. The first choice is a fixed step size of $\alpha = 2/L$, being the largest possible step size to guarantee input-output stability for $m < L$, as per Theorem 3-(ii). The second choice is the optimal fixed step size of $\alpha = 2/(m+L)$ [7]. Finally, a varying step size, α_{btk}^k , is considered by implementing a line search algorithm based on Armijo's condition [20]. Similarly, for the gain-scheduled GD method in (24), two choices of constant scheduling functions, $s = \sqrt{2/L}$ and $s = \sqrt{2/(m+L)}$, are considered. Additionally, a varying scheduling function, s_{btk}^k , is considered by implementing a line search algorithm based on Armijo's condition with the added condition that $\max_{k \in \mathcal{T}} |s^k| \in (0, \sqrt{2/L}]$. A Monte Carlo simulation is conducted with 10^5 uniformly sampled initial conditions $x^0 \in [-10^5, 10^5]$ to compare the number

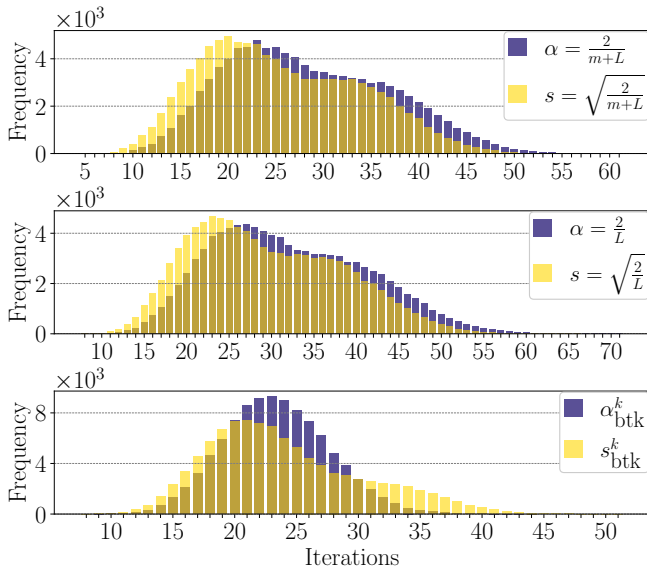

Fig. 7. Comparison of number of iterations needed to achieve $|\nabla f(x^k)| < 10^{-12}$ for the GD method and the gain-scheduled GD method with different step sizes and scheduling functions using 10^5 uniformly sampled initial conditions for $x^0 \in [-10^5, 10^5]$.

TABLE I

CORRESPONDING MEAN, MEDIAN, AND MODE OF FIGURE 7

Parameter	Mean	Median	Mode
$\alpha = 2/(m+L)$	28.36	27	23
$s = \sqrt{2/(m+L)}$	25.68	25	20
$\alpha = 2/L$	32.12	31	27
$s = \sqrt{2/L}$	29.50	28	23
α_{btk}^k	23.38	23	23
s_{btk}^k	24.08	23	21

of iterations needed to achieve $|\nabla f(x^k)| < 10^{-12}$ for the GD method and the gain-scheduled GD method.

As shown in Figure 7 and Table I, for the constant step size and constant scheduling function cases, the distribution of the gain-scheduled GD method has smaller mean, median, and mode values, compared to the standard GD method. For the varying step size and varying scheduling function case, the standard GD method has a lower mean, but a higher mode, compared to the gain-scheduled GD method. The lower mode indicates better performance in terms of fewer iterations. Finally, for both methods, Table I also confirms that time-varying step sizes and scheduling functions can lead to improved performance.

VI. CLOSING REMARKS

A discrete-time passivity-based analysis of the GD method is considered in this paper. For an objective function with sector-bounded gradient and a unique global minimizer, $f \in \mathcal{S}_{m,L}$, it is shown that the shifted gradient Δ is VSP. Using a loop transformation, it is shown that the GD method can be interpreted as a passive controller in negative feedback with a VSP system, provided $\alpha \in (0, 2/L)$. The input-output stability, as well as the global convergence, of the GD method is then guaranteed using the strong version of

the passivity theorem. Furthermore, provided $m < L$, it is shown that for $\alpha = 2/L$, the passive GD controller is now in negative feedback with an ISP system instead. Therefore, the weak passivity theorem is used to guarantee the input-output stability of the GD method. For this larger choice of step size, Polyak's counter example in [18] is revisited, and a new stopping criterion is proposed to ensure the GD method can still be used to obtain the unique global minimizer. Finally, a new variation of the GD method is proposed, where the input and output of the gradient are scaled using a discrete-time adaptation of the gain-scheduling architecture in [12].

REFERENCES

- [1] B. T. Polyak, "Some Methods of Speeding Up the Convergence of Iteration Methods," *USSR Computational Mathematics and Mathematical Physics*, vol. 4, no. 5, pp. 1–17, 1964.
- [2] Y. Nesterov, *Introductory Lectures on Convex Optimization: A Basic Course*. USA: Springer, 2013.
- [3] V. Ugrinovskii, I. R. Petersen, and I. Shames, "Global Convergence and Asymptotic Optimality of the Heavy Ball Method for a Class of Nonconvex Optimization Problems," *IEEE Control Systems Letters*, vol. 6, pp. 2449–2454, 2022.
- [4] A. Wu, I. Petersen, V. Ugrinovskii, and I. Shames, "A Generalized Accelerated Gradient Optimization Method," *American Control Conference*, pp. 1904–1908, 2024.
- [5] B. Hu and L. Lessard, "Control Interpretations for First-Order Optimization Methods," *American Control Conference*, pp. 3114–3119, 2017.
- [6] I. Notarnicola and A. Falsone, "Passivity-based Analysis of the ADMM Algorithm for Constraint-Coupled Optimization," *Automatica*, vol. 146, p. 110552, 2022.
- [7] L. Lessard, "The Analysis of Optimization Algorithms: A Dissipativity Approach," *IEEE Control Systems Magazine*, vol. 42, no. 3, pp. 58–72, 2022.
- [8] B. Van Scoy and L. Lessard, "A Tutorial on a Lyapunov-Based Approach to the Analysis of Iterative Optimization Algorithms," *IEEE Conference on Decision and Control*, pp. 3003–3008, 2023.
- [9] L. Lessard, B. Recht, and A. Packard, "Analysis and Design of Optimization Algorithms via Integral Quadratic Constraints," *SIAM Journal on Optimization*, vol. 26, no. 1, pp. 57–95, 2016.
- [10] B. Van Scoy, R. A. Freeman, and K. M. Lynch, "The Fastest known Globally Convergent First-Order Method for Minimizing Strongly Convex Functions," *IEEE Control Systems Letters*, vol. 2, no. 1, pp. 49–54, 2017.
- [11] R. Padmanabhan and P. Seiler, "Analysis of Gradient Descent with Varying Step Sizes using Integral Quadratic Constraints," *IEEE Transactions on Automatic Control*, 2024, [To Appear].
- [12] C. J. Damaren, "Gain-Scheduled SPR Controllers for Nonlinear Flexible Systems," *Journal of Dynamic Systems, Measurement, and Control*, vol. 118, no. 4, pp. 698–703, 1996.
- [13] C. Desoer and M. Vidyasagar, *Feedback Systems: Input-Output Properties*. USA: Academic Press, 1975.
- [14] L. Hitz and B. Anderson, "Discrete Positive-Real Functions and their Application to System Stability," *Proceedings of the IEE*, vol. 116, no. 1, pp. 153–155, 1969.
- [15] W. M. Haddad and V. Chellaboina, *Nonlinear Dynamical Systems and Control: A Lyapunov-Based Approach*. USA: Princeton University Press, 2008.
- [16] C. I. Byrnes and W. Lin, "Losslessness, Feedback Equivalence, and the Global Stabilization of Discrete-Time Nonlinear Systems," *IEEE Transactions on Automatic Control*, vol. 39, no. 1, pp. 83–98, 1994.
- [17] S. Kelly and J. W. Simpson-Porco, "An Interconnected Systems Approach to Convergence Analysis of Discrete-Time Primal-Dual Algorithms," *American Control Conference*, pp. 662–668, 2024.
- [18] B. Polyak, *Introduction to Optimization*. USA: Optimization Software, Inc., 1987.
- [19] J. W. Simpson-Porco, "Equilibrium-Independent Dissipativity with Quadratic Supply Rates," *IEEE Transactions on Automatic Control*, vol. 64, no. 4, pp. 1440–1455, 2018.
- [20] L. Armijo, "Minimization of Functions having Lipschitz Continuous First Partial Derivatives," *Pacific Journal of Mathematics*, vol. 16, no. 1, pp. 1–3, 1966.