

# S-packing edge-colorings of subcubic outerplanar graphs

Sijin Li\*

Yifan Li†

Xujun Liu‡

## Abstract

For a sequence  $S = (s_1, s_2, \dots, s_k)$  of non-decreasing positive integers, an  $S$ -packing edge-coloring ( $S$ -coloring) of a graph  $G$  is a partition of  $E(G)$  into  $E_1, E_2, \dots, E_k$  such that the distance between each pair of distinct edges  $e_1, e_2 \in E_i$ ,  $1 \leq i \leq k$ , is at least  $s_i + 1$ . In particular, a  $(1^\ell, 2^k)$ -coloring is a partition of  $E(G)$  into  $\ell$  matchings and  $k$  induced matchings, and it can be viewed as intermediate colorings between proper and strong edge-colorings. Hocquard, Lajou, and Lužar conjectured that every subcubic planar graph has a  $(1, 2^6)$ -coloring and a  $(1^2, 2^3)$ -coloring.

In this paper, we confirm the conjecture of Hocquard, Lajou, and Lužar for subcubic outerplanar graphs by showing every subcubic outerplanar graph has a  $(1, 2^5)$ -coloring and a  $(1^2, 2^3)$ -coloring. Our results are best possible since we found subcubic outerplanar graphs with no  $(1, 2^4)$ -coloring and no  $(1^2, 2^2)$ -coloring respectively. Furthermore, we explore the question “What is the largest positive integer  $k_1$  and  $k_2$  such that every subcubic outerplanar graph is  $(1, 2^4, k_1)$ -colorable and  $(1^2, 2^2, k_2)$ -colorable?”. We prove  $3 \leq k_1 \leq 6$  and  $3 \leq k_2 \leq 4$ . We also consider the question “What is the largest positive integer  $k'_1$  and  $k'_2$  such that every 2-connected subcubic outerplanar graph is  $(1, 2^3, k'_1)$ -colorable and  $(1^2, 2^2, k'_2)$ -colorable?”. We prove  $k'_1 = 2$  and  $3 \leq k'_2 \leq 11$ .

*Keywords:*  $S$ -packing edge-coloring; outerplanar graph; subcubic graph; matching; induced matching

## 1 Introduction

For a non-decreasing sequence  $S = (s_1, s_2, \dots, s_k)$  of positive integers, an  $S$ -packing edge-coloring (abbreviated to  $S$ -coloring) of a graph  $G$  is a partition of  $E(G)$  into  $E_1, E_2, \dots, E_k$  such that for each pair of distinct edges  $e_1, e_2 \in E_i$ ,  $1 \leq i \leq k$ , the distance between  $e_1$  and  $e_2$  is at least  $s_i + 1$ . This notion was first introduced in 2019 by Gastineau and Togni [11]. Its vertex counterpart has also received much attention in recent years (e.g. see [2, 3, 8, 10]). To simplify the notation, we use exponents to denote repetitions of the same number, e.g.,  $(1, 1, 2, 2, 2, 3)$  is denoted by  $(1^2, 2^3, 3)$ .

A proper  $k$ -edge coloring of  $G$  is a partition of  $E(G)$  into  $k$  matchings. The chromatic index of a graph  $G$  is the minimum  $k$  such that  $G$  has a proper  $k$ -edge coloring. The famous result of Vizing [22] states that every graph  $G$  with  $\Delta(G) = \Delta$  either has chromatic index  $\Delta$  or  $\Delta + 1$ . The strong chromatic index  $\chi'_s(G)$ , introduced by Fouquet and Jolivet [7] in 1983, is the minimum  $k$  such that  $G$  can be partitioned into  $k$  induced matchings. Erdős and Nešetřil [6] conjectured that  $\chi'_s(G) \leq \frac{5}{4}\Delta(G)^2$  when  $\Delta(G)$  is even and  $\chi'_s(G) \leq \frac{5}{4}\Delta(G)^2 - \frac{1}{2}\Delta(G) + \frac{1}{4}$  when  $\Delta(G)$  is odd. Using

\*School of Mathematics and Physics, Xi'an Jiaotong-Liverpool University, Suzhou, Jiangsu Province, 215123, China, sijin.li21@student.xjtlu.edu.cn

†School of Mathematics and Physics, Xi'an Jiaotong-Liverpool University, Suzhou, Jiangsu Province, 215123, China, yifan.li21@student.xjtlu.edu.cn

‡Department of Foundational Mathematics, School of Mathematics and Physics, Xi'an Jiaotong-Liverpool University, Suzhou, Jiangsu Province, 215123, China, xujun.liu@xjtlu.edu.cn; the research of X. Liu was supported by the National Natural Science Foundation of China under grant No. 12401466 and the Research Development Fund RDF-21-02-066 of Xi'an Jiaotong-Liverpool University.

the language of  $S$ -packing edge-coloring, we know a strong edge-coloring using  $k$  colors is equivalent to a  $(2^k)$ -packing edge-coloring. Many researchers have extended the study of strong edge-coloring (e.g., [1, 4, 5, 9, 13–17, 20, 21]). In particular, Andersen [1] and independently Horák, Qing, and Trotter [14] proved every subcubic graph has a  $(2^{10})$ -packing edge-coloring and thus confirming the conjecture of Erdős and Nešetřil for  $\Delta(G) = 3$ . Kostochka, Li, Ruksasakchai, Santana, Wang, and Yu [17] showed every subcubic planar graph is  $(2^9)$ -packing edge-colorable. For graphs with maximum degree at most four, the current best upper bound (21) was proved by Huang, Santana, and Yu [15], which is only one color away from the conjectured upper bound of Erdős and Nešetřil when  $\Delta(G) = 4$ . For large  $\Delta(G)$ , the current best upper bound,  $1.772\Delta(G)^2$ , was proved by Hurley, de Joannis de Verclos, and Kang [16].

The  $(1^\ell, 2^k)$ -packing edge-colorings (abbreviated to  $(1^\ell, 2^k)$ -colorings) can be viewed as intermediate colorings between proper edge-colorings and strong edge-colorings. Gastineau and Togni [11] asked whether every subcubic graph has a  $(1, 2^7)$ -coloring. Hocquard, Lajou, and Lužar [12] proved every subcubic graph has a  $(1, 2^8)$ -coloring and conjectured the question of Gastineau and Togni is true. For colorings with two 1-colors, Hocquard, Lajou, and Lužar [12] showed every subcubic graph has a  $(1^2, 2^5)$ -coloring. Furthermore, Hocquard, Lajou, and Lužar [12], as well as Gastineau and Togni [11], conjectured that every subcubic graph is  $(1^2, 2^4)$ -colorable. The former conjecture was recently confirmed by Liu, Santana, and Short [18], who showed every subcubic multigraph is  $(1, 2^7)$ -colorable. The latter conjecture (for connected subcubic graphs with more than 70 vertices) was proved by Liu and Yu [19]. Both results are best possible since the graph obtained by subdividing exactly one edge of  $K_{3,3}$  is neither  $(1, 2^6)$ -colorable nor  $(1^2, 2^3)$ -colorable. For subcubic planar graphs, Hocquard, Lajou, and Lužar [12] posted the following conjecture.

**Conjecture 1.1** (Hocquard, Lajou, and Lužar [12]). *Every subcubic planar graph is  $(1, 2^6)$ -packing edge-colorable and  $(1^2, 2^3)$ -packing edge-colorable.*

In this paper, we confirm Conjecture 1.1 for subcubic outerplanar graphs by showing every subcubic outerplanar graph is  $(1, 2^5)$ -colorable and  $(1^2, 2^3)$ -colorable. Our results are best possible since we found subcubic outerplanar graphs with no  $(1, 2^4)$ -coloring and no  $(1^2, 2^2)$ -coloring respectively. Furthermore, we are interested in how tight our results can be in a different sense. We explore the question “What is the largest positive integer  $k_1$  and  $k_2$  such that every subcubic outerplanar graph is  $(1, 2^4, k_1)$ -colorable and  $(1^2, 2^2, k_2)$ -colorable?”. We prove  $3 \leq k_1 \leq 6$  and  $3 \leq k_2 \leq 4$ . We also consider the question “What is the largest positive integer  $k'_1$  and  $k'_2$  such that every 2-connected subcubic outerplanar graph is  $(1, 2^3, k'_1)$ -colorable and  $(1^2, 2^2, k'_2)$ -colorable?”. We prove  $k'_1 = 2$  and  $3 \leq k'_2 \leq 11$ .

We work with outerplane graphs (outerplanar graphs with a fixed drawing where all vertices are on the outer face). A block in a graph is an inclusion maximal subgraph with no cut vertices. By definition, each block is either 2-connected (non-trivial) or a  $K_2$  (trivial). Given an outerplane graph  $G$ , the weak dual graph,  $\tau(G)$ , is the graph that has a vertex for every bounded face of the embedding, and an edge for every pair of bounded faces sharing at least one edge. It is well-known that a plane graph is outerplane if and only if its weak dual is a forest. We say a vertex  $u$  sees color  $c$  if color  $c$  is used in an edge incident to  $u$ . A pattern  $[a, b, c]$  is used to denote the use of colors  $a, b, c, a, b, c, \dots$ . In our proof, we assume  $G$  is connected since otherwise we apply the same argument to each connected component.

We first show in Section 2.1 that  $k'_1 = 2$ . Then we show in Section 2.2 that  $3 \leq k_1 \leq 6$  and hence the conjecture of Hocquard et al (one 1-color) for subcubic outerplanar graphs is confirmed as a corollary. In Section 3.1, we prove that  $3 \leq k_2 \leq 4$ . This result implies the conjecture of Hocquard et al (two 1-colors) is true for subcubic outerplanar graphs. At last, we show in Section 3.2 that  $3 \leq k'_2 \leq 11$  and propose three open problems in Section 4.

## 2 $(1^1, 2^k)$ -packing edge-colorings of subcubic outerplanar graphs

In this section, we focus on  $(1^1, 2^k)$ -packing edge-colorings of subcubic outerplanar graphs. We first show in Section 2.1 that every 2-connected subcubic outerplanar graph has a  $(1, 2^4)$ -packing edge-coloring.

**Theorem 2.1.** *Every 2-connected subcubic outerplanar graph has a  $(1, 2^4)$ -packing edge-coloring.*

Our result is the best possible since there are 2-connected subcubic outerplanar graphs with no  $(2^5)$ -packing edge-coloring and no  $(1, 2^3, 3)$ -packing edge-coloring respectively (Examples 2.1 and 2.3). Furthermore, we provide in Example 2.6 a subcubic outerplanar graph that has no  $(1, 2^4)$ -packing edge-coloring, showing the “2-connected” condition in Theorem 2.1 also cannot be dropped.

**Example 2.1.** *The graph  $G_1$  is obtained from a five cycle  $u_1u_2u_3u_4u_5$  plus an edge  $u_2u_5$  (See Fig. 1 left picture). The graph  $G_1$  is 2-connected, subcubic, outerplanar, and has 6 edges. Since every pair of edges in  $G_1$  has distance at most two,  $G_1$  is not  $(2^5)$ -packing edge-colorable.*

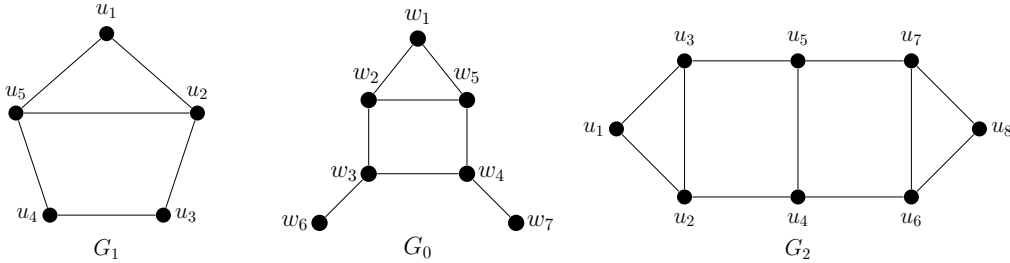

Figure 1: 2-connected subcubic outerplanar graphs with no  $(2^5)$ -coloring and no  $(1, 2^3, 3)$ -coloring.

**Definition 2.2.** *Let  $G_0$  in Fig. 1 be called the **house** graph and  $G_0 - \{w_6, w_7\}$  be called the **house-without-base** graph.*

**Example 2.3.** *The graph  $G_2$  in Fig. 1 is 2-connected, subcubic, and outerplanar, but not  $(1, 2^3, 3)$ -colorable.*

**Proof.** We first show  $G_2$  has a unique  $(1, 2^4)$ -coloring up to symmetry.

**Claim 2.4.** *The gadget  $G_0$  has two  $(1, 2^4)$ -colorings and  $G_2$  has a unique  $(1, 2^4)$ -coloring up to symmetry.*

**Proof.** Suppose  $G_0$  has a  $(1, 2^4)$ -coloring  $f$ . We first show  $f(w_1w_2) \neq 1$ . If not, i.e.,  $f(w_1w_2) = 1$ , then it implies  $f(w_1w_5), f(w_2w_5), f(w_2w_3) \in \{2_a, 2_b, 2_c, 2_d\}$ , say  $f(w_1w_5) = 2_a, f(w_2w_5) = 2_b, f(w_2w_3) = 2_c$ . Since each of  $w_3w_4, w_4w_5, w_4w_7$  is at distance at most two from each of  $w_1w_5, w_2w_5, w_2w_3$ , the only available colors for  $w_3w_4, w_4w_5, w_4w_7$  are  $\{1, 2_d\}$ , which is impossible. By symmetry,  $f(w_1w_5) \neq 1$  as well.

Let  $G'_0$  be the subgraph induced by vertices  $\{w_1, w_2, w_3, w_4, w_5\}$ . Since each pair of edges in  $G'_0$  has distance at most two,  $f$  needs to use 1 at least twice. Since  $f(w_1w_2) \neq 1$  and  $f(w_1w_5) \neq 1$ , the only two  $(1, 2^4)$ -colorings of  $G_0$ , up to symmetry, are Type I coloring:  $f_1(w_2w_5) = f_1(w_3w_4) = 1, f_1(w_1w_2) = f_1(w_4w_7) = 2_a, f_1(w_1w_5) = f_1(w_3w_6) = 2_b, f_1(w_2w_3) = 2_c, f_1(w_4w_5) = 2_d$ , and Type II coloring:  $f_2(w_2w_3) = f_2(w_4w_5) = 1, f_2(w_1w_2) = f_2(w_4w_7) = 2_a, f_2(w_1w_5) = f_2(w_3w_6) = 2_b, f_2(w_2w_5) = 2_c, f_2(w_3w_4) = 2_d$  (see Fig. 2).

Since  $G_2$  contains two copies of gadget  $G_0$ , they must be both of Type I. Therefore, the unique  $(1, 2^4)$ -coloring  $g$  of  $G_2$ , up to symmetry, must satisfy  $g(u_2u_3) = g(u_4u_5) = g(u_6u_7) = 1, g(u_1u_2) = g(u_5u_7) = 2_a, g(u_1u_3) = g(u_4u_6) = 2_b, g(u_2u_4) = g(u_7u_8) = 2_c$ , and  $g(u_3u_5) = g(u_6u_8) = 2_d$ .  $\square$

Suppose  $G_2$  has a  $(1, 2^3, 3)$ -coloring  $h$ . The  $(1, 2^4)$ -coloring  $h'$  obtained by changing color 3 of  $h$  to  $2_d$  is a valid  $(1, 2^4)$ -coloring of  $G_2$ . By Claim 2.4,  $h'$  must be isomorphic to  $g$ . However, the two edges colored with  $2_d$  are at distance exactly three, and it contradicts the fact that  $h$  is a  $(1, 2^3, 3)$ -coloring.  $\square$

**Remark 2.5.** The graph  $G_2$  (Fig. 2) has a unique  $(1, 2^4)$ -coloring, showed in the proof of Claim 2.4. Let the graph  $G'_2$  be obtained from  $G_2$  by adding a vertex  $u$  and an edge  $uu_1$ . Then  $uu_1$  is colored with 1 in every  $(1, 2^4)$ -coloring of  $G'_2$ .

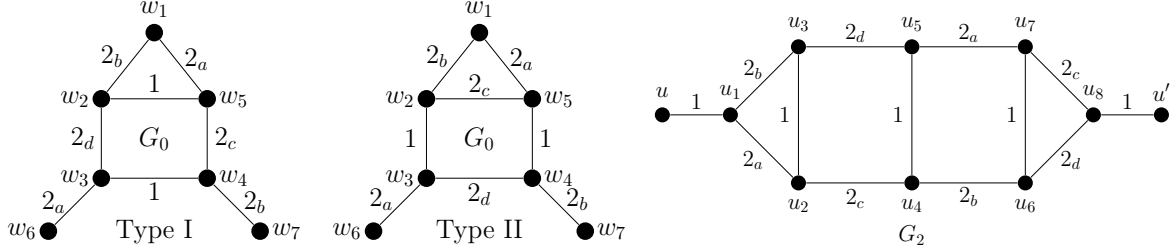

Figure 2: Determined  $(1, 2^4)$ -colorings for  $G_0$  and  $G_2$ .

**Example 2.6.** The graph  $G_3$  (Fig. 3) is obtained by taking a copy of  $G_0$ , a copy of  $G_2$ , and then identifying the vertex  $w_6$  of  $G_0$  with the vertex  $u_1$  of  $G_2$ . We show that  $G_3$  is subcubic, outerplanar, and has no  $(1, 2^4)$ -coloring.

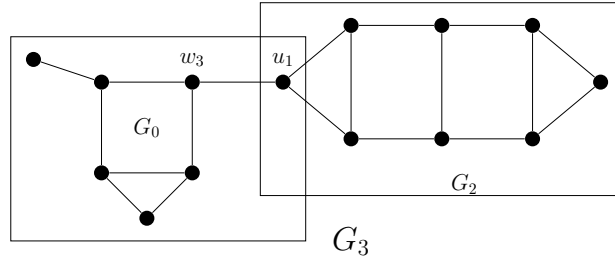

Figure 3: A subcubic outerplanar graph with no  $(1, 2^4)$ -coloring.

**Proof.** By Claim 2.4, the edge  $w_3u_1$  of  $G_0$  must use a color from  $\{2_a, 2_b, 2_c, 2_d\}$ . However, by Remark 2.5, the edge  $w_3u_1$  must use color 1. This is a contradiction.  $\square$

Inspired by Conjecture 1.1, we explore the question “what is the largest positive integer  $k_1$  such that every subcubic outerplanar graph is  $(1, 2^4, k_1)$ -colorable?”. We prove in Section 2.2 that  $k_1 \geq 3$  and  $k_1 \leq 6$ .

**Theorem 2.2.** Every subcubic outerplanar graph is  $(1, 2^4, 3)$ -packing edge-colorable.

As a corollary of our result, every subcubic outerplanar graph is  $(1, 2^5)$ -colorable, and thus we confirmed the conjecture (one 1-color) of Hocquard et al [12] for subcubic outerplanar graphs.

**Corollary 2.7.** Every subcubic outerplanar graph is  $(1, 2^5)$ -packing edge-colorable.

Corollary 2.7 is also sharp in the sense that there are subcubic outerplanar graphs with no  $(1, 2^4)$ -coloring (Example 2.6). Note that Corollary 2.7 can also be implied by a result of Hocquard, Ochem, and Valicov [13], who showed every subcubic outerplanar graph is  $(2^6)$ -colorable.

## 2.1 $(1, 2^4)$ -packing edge-coloring of 2-connected subcubic outerplanar graphs

In this subsection, we prove Theorem 2.3, where we require all the “house graph” must be using Type I coloring (shown in Fig. 2). Theorem 2.1 is true as a corollary of Theorem 2.3.

**Theorem 2.3.** *Every 2-connected subcubic outerplanar graph has a  $(1, 2^4)$ -packing edge-coloring such that all the “house graph” is colored with Type I coloring (we call such a coloring good coloring in this subsection).*

**Proof of Theorem 2.3:** Suppose not, i.e., there exist 2-connected subcubic outerplanar graphs that have no good coloring. We take the graph  $G$  with minimum  $|V(G)| + |E(G)|$ . We may assume the weak dual of  $G$  has diameter at least two, since otherwise  $G$  itself is a cycle and we color the edges with the pattern  $[1, 2_a, 2_b]$  (we can use colors  $2_c, 2_d$  at the end to avoid conflicts between  $2_a$ s and  $2_b$ s).

**Lemma 2.8.** *Every pendant face of  $G$  is a triangle.*

**Proof.** Suppose  $F_1$  is a pendant face with the two 3-vertices  $v_1$  and  $v_k$ . Let the cycle  $C = v_1v_2 \cdots v_k$  be the boundary of  $F_1$ . Let  $N(v_1) = \{u_1, v_2, v_k\}$  and  $N(v_k) = \{u_k, v_1, v_{k-1}\}$ . If  $k \geq 4$ , then we delete  $v_2, \dots, v_{k-1}$  and add a vertex  $v$  with edges  $vv_1$  and  $vv_k$  to obtain a new graph  $G'$ . The graph  $G'$  is a 2-connected subcubic outerplanar graph with  $|V(G')| + |E(G')| < |V(G)| + |E(G)|$ . By the minimality of  $G$ ,  $G'$  has a good coloring  $f$ . We split the cases according to the number of 1-color used on  $u_1v_1, v_1v_k, v_ku_k$ . We extend  $f$  to  $G$ .

**Case 1:** The edges  $u_1v_1, v_1v_k, v_ku_k$  have two 1-colors. By symmetry, we may assume  $f(u_1v_1) = f(u_ku_k) = 1, f(v_1v_k) = 2_a, f(vv_1) = 2_b$ , and  $f(vv_k) = 2_c$ . Then for the pendant face  $F_1$  of  $G$ , we use  $2_b$  to color  $v_1v_2$  and  $2_c$  to color  $v_{k-1}v_k$ , and the pattern  $[1, 2_d, 1, 2_b]$  to color the edges from  $v_2v_3$  to  $v_{k-2}v_{k-1}$ .

**Case 2:** The edges  $u_1v_1, v_1v_k, v_ku_k$  have one 1-color. By symmetry, there are two subcases to consider.

**Case 2.1:**  $f(v_1v_k) = 1$ . We may assume  $f(u_1v_1) = 2_a, f(u_ku_k) = 2_b, f(vv_1) = 2_c, f(vv_k) = 2_d$ . We use  $2_c$  to color  $v_1v_2$  and  $2_d$  to color  $v_{k-1}v_k$ , the pattern  $[1, 2_a, 1, 2_c]$  to color the edges from  $v_2v_3$  to  $v_{k-2}v_{k-1}$ .

**Case 2.2:**  $f(u_1v_1) = 1$ . We may assume  $f(v_1v_k) = 2_a, f(v_ku_k) = 2_b$ , and  $f(vv_1) = 2_c$ . We use  $2_c$  to color  $v_1v_2$  and 1 to color  $v_{k-1}v_k$ . We use the pattern  $[2_d, 1, 2_b, 1]$  to color the edges from  $v_{k-2}v_{k-1}$  to  $v_2v_3$ .

**Case 3:** The edges  $u_1v_1, v_1v_k, v_ku_k$  have no 1-color. We may assume  $f(u_1v_1) = 2_a, f(v_1v_k) = 2_b, f(u_ku_k) = 2_c, f(vv_k) = 2_d, f(vv_1) = 1$ . We can switch the colors of  $vv_1$  and  $v_1v_k$ , which was already solved in **Case 2.1**.  $\square$

We may assume  $G$  has at least three faces since otherwise, by Lemma 2.8, it must be two triangles sharing an edge. In this case, we have five colors to color five edges. We show next a lemma about the “most outside two layers” of  $G$ .

**Lemma 2.9.** *Let  $F_1$  be a pendant face which is corresponding to a leaf in a longest path  $P$  in the weak dual of  $G$ . Let  $F_2$  be the unique face adjacent to  $F_1$ . Then  $F_2$  must be a 4-face.*

**Proof.** Suppose not, i.e.,  $F_2$  is a  $k$ -face with  $k \geq 5$ . Since  $G$  has at least three faces,  $P$  has at least 3 vertices. Let  $F_3$  be the face which corresponds to the other neighbour of  $F_2$  in  $P$ . Let the boundary cycle of  $F_2$  be  $v_1v_2 \cdots v_k$ , where  $v_1, v_k \in V(F_2) \cap V(F_3)$ . We delete  $v_2, \dots, v_{k-1}$  and all pendant faces adjacent to it (which must be triangles). Then we add  $w, w_2, w_3$  with edges  $v_1w_2, w_2w_3, w_3v_k, ww_2, ww_3$  to obtain  $G'$ , which is a 2-connected subcubic outerplanar graph with  $|V(G')| + |E(G')| < |V(G)| + |E(G)|$ . By the minimality of  $G$ ,  $G'$  has a good coloring  $f$ . We extend  $f$  to  $G$ .

Let  $N_G(v_1) = \{u_1, v_2, v_k\}$  and  $N_G(v_k) = \{v_1, v_{k-1}, u_k\}$ . Then we know  $f(u_1v_1) = f(w_1w_3) = 2_a$ ,  $f(u_kv_k) = f(w_1w_2) = 2_b$ ,  $f(w_3v_k) = 2_c$ ,  $f(v_1w_2) = 2_d$ , and  $f(v_1v_k) = f(w_2w_3) = 1$ . We first color  $v_1v_2, v_{k-1}v_k$  with  $2_d, 2_c$ , then use the pattern  $[1, 2_a, 1, 2_d]$  to color the edges  $v_2v_3$  through  $v_{k-2}v_{k-1}$  in the boundary of  $F_2$ . If there is a 3-face on top of  $v_i v_{i+1}$ , then we call the third vertex  $v'_i$ , where  $2 \leq i \leq k-2$ . We split the proof into two cases based on the largest subscript  $j$  of  $v'_j$ .

**Case 1:**  $j \leq k-3$ . We color  $v_j v'_j, v'_j v_{j+1}$  with  $2_c, 2_b$ , and the other uncolored edges of 3-faces  $v_i v'_i, v'_i v_{i+1}$  with  $2_c, 2_b$ .

**Case 2:**  $j = k-2$ . If  $f(v_{k-2}v_{k-1}) = 1$ , then color  $v_{k-2}v'_{k-2}, v'_{k-2}v_{k-1}$  with  $2_b, x$ ,  $x \in \{2_a, 2_d\} - f(v_{k-3}v_{k-2})$ . Otherwise, we color  $v_{k-2}v'_{k-2}, v'_{k-2}v_{k-1}$  with  $2_b, 1$ . The other uncolored edges of 3-faces  $v_i v'_i, v'_i v_{i+1}$  are colored with  $2_b, 2_c$ .  $\square$

Now, we complete the proof of Theorem 2.3. By Lemma 2.9, if  $P$  only has three vertices, then  $G$  is a special house with  $w_6 = w_7$  in Fig. 2. Then we can color  $G$  with the Type I coloring. Therefore, we may assume  $P$  has at least 4 vertices. Let  $F_1$  be a leaf of  $P$ , and  $P = F_1 F_2 F_3 F_4 \dots$ . Let the boundary cycle of  $F_3$  be  $v_1 \dots v_k$ ,  $k \geq 4$ , with  $v_1, v_k \in V(F_3) \cap V(F_4)$ . We delete  $\{v_2, \dots, v_{k-1}\}$  together with all the ‘‘houses’’ and 3-faces attached to  $F_3$  (except  $F_4$ ), and add vertices  $w, w_1, w_2$  with edges  $v_1 w_1, w_1 w_2, w_2 v_k, w w_1, w w_2$  to obtain a graph  $G'$  with  $|V(G')| + |E(G')| < |V(G)| + |E(G)|$ . By the minimality of  $G$ ,  $G'$  has a good coloring  $f$ . We extend  $f$  to  $G$ .

In our proof, we may assume only houses can be attached to  $F_3$  (except  $F_4$ ), since type I coloring guarantees that the two edges  $w_2 w_3$  and  $w_4 w_5$  in  $G_0$  (of Fig. 2) are colored with different colors in  $\{2_a, 2_b, 2_c, 2_d\}$ . We also assume there are no adjacent 2-vertices on the boundary cycle of  $F_3$ , since otherwise we add a house on top of them. If there is a house attached to  $F_3$ , where the house and  $F_3$  share vertices  $v_i, v_{i+1}$ , then the three vertices of the house not in  $F_3$  are named  $\{v'_i, v'_{i+1}, v''_i\}$  with  $v_i v'_i, v_{i+1} v'_{i+1}, v'_i v''_i, v'_i v'_{i+1}, v''_i v'_{i+1} \in E(G)$ . We split the proof into three cases depending on  $k$ .

**Case 1:**  $k \equiv 2 \pmod{3}$ . We color the boundary face of  $F_3$  starting from  $v_1 v_2$  using the pattern  $[2_d, 2_b, 2_a]$  until the edge  $v_{k-2} v_{k-1}$  and color  $v_{k-1} v_k$  with  $2_c$ . Since  $k \equiv 2 \pmod{3}$ ,  $v_{k-2} v_{k-1}$  is colored with  $2_a$ . For the houses attached to  $F_3$  on  $v_i, v_{i+1}$ , where  $2 \leq i \leq k-3$ , we color  $v_{i+1} v'_{i+1}$  with  $f(v_i v_{i+1})$  and recolor  $v_i v_{i+1}$  with 1, then we color  $v_i v'_i, v'_i v'_{i+1}, v'_i v''_i, v''_i v'_{i+1}$  with  $2_c, 1, f(v_{i+1} v_{i+2}), f(v_{i-1} v_i)$ . In case  $v_{k-1}$  is a 3-vertex, then we recolor  $v_{k-2} v_{k-1}$  with 1, and color  $v_{k-1} v'_{k-1}, v_{k-2} v'_{k-2}, v'_{k-2} v'_{k-1}, v'_{k-2} v''_{k-2}, v''_{k-2} v'_{k-1}$  with  $2_d, 2_a, 1, 2_c, 2_b$ .

**Case 2:**  $k \equiv 1 \pmod{3}$ . We color the boundary face of  $F_3$  starting from  $v_1 v_2$  using the pattern  $[2_d, 2_b, 2_a]$  until the edge  $v_{k-2} v_{k-1}$  and color  $v_{k-1} v_k$  with  $2_c$ . Since  $k \equiv 1 \pmod{3}$ ,  $v_{k-2} v_{k-1}$  is colored with  $2_b$ . If  $v_{k-1}$  is a 3-vertex, we recolor  $v_{k-2} v_{k-1}$  with 1 and color  $v_{k-2} v'_{k-2}, v_{k-1} v'_{k-1}, v'_{k-1} v'_{k-2}, v'_{k-2} v''_{k-2}, v''_{k-2} v'_{k-1}$  with  $2_b, 2_a, 1, 2_c, 2_d$ . If  $v_{k-1}$  is a 2-vertex, then  $v_{k-2}$  is a 3-vertex, we recolor  $v_{k-3} v_{k-2}, v_{k-2} v_{k-1}$  with 1,  $2_d$  and color  $v_{k-3} v'_{k-3}, v_{k-2} v'_{k-2}, v'_{k-2} v'_{k-3}, v'_{k-3} v''_{k-3}, v''_{k-3} v'_{k-2}$  with  $2_c, 2_b, 1, 2_d, 2_a$ . For the other houses attached to  $F_3$  on  $v_i, v_{i+1}$ , where  $2 \leq i \leq k-4$ , we color  $v_{i+1} v'_{i+1}$  with  $f(v_i v_{i+1})$  and recolor  $v_i v_{i+1}$  with 1, then we color  $v_i v'_i, v'_i v'_{i+1}, v'_i v''_i, v''_i v'_{i+1}$  with  $2_c, 1, f(v_{i+1} v_{i+2}), f(v_{i-1} v_i)$ .

**Case 3:**  $k \equiv 0 \pmod{3}$ . We color the boundary face of  $F_3$  starting from  $v_1 v_2$  using the pattern  $[2_d, 2_b, 2_a]$  until the edge  $v_{k-2} v_{k-1}$  and color  $v_{k-1} v_k$  with  $2_c$ . If  $v_{k-1}$  is a 2-vertex, then for the houses attached to  $F_3$  on  $v_i, v_{i+1}$ , where  $2 \leq i \leq k-3$ , we color  $v_{i+1} v'_{i+1}$  with  $f(v_i v_{i+1})$  and recolor  $v_i v_{i+1}$  with 1, then we color  $v_i v'_i, v'_i v'_{i+1}, v'_i v''_i, v''_i v'_{i+1}$  with  $2_c, 1, f(v_{i+1} v_{i+2}), f(v_{i-1} v_i)$ . Thus, we may assume  $v_{k-1}$  is a 3-vertex. We define  $j$  as the largest index  $2 \leq i \leq k-3$  such that  $v_j$  is a 2-vertex (if such a vertex does not exist, then  $j = 1$ ). If  $j = k-3$ , then  $k \geq 9$  and  $v_{k-4}$  is a 3-vertex. We recolor  $v_{k-2} v_{k-1}, v_{k-5} v_{k-4}, v_{k-4} v_{k-3}$  with 1,  $1, 2_d$ , and color  $v_{k-5} v'_{k-5}, v_{k-4} v'_{k-4}, v'_{k-5} v'_{k-4}, v'_{k-5} v''_{k-5}, v''_{k-5} v'_{k-4}$  with  $2_c, 2_b, 1, 2_d, 2_a$ , and color  $v_{k-2} v'_{k-2}, v_{k-1} v'_{k-1}, v'_{k-2} v'_{k-1}, v'_{k-2} v''_{k-2}, v''_{k-2} v'_{k-1}$  with  $2_b, 2_d, 1, 2_c, 2_a$ . If  $j \leq k-4$ , then it implies  $j \leq k-5$ , we color  $v_{j+1} v'_{j+1}, v_{j+2} v'_{j+2}, v'_{j+1} v'_{j+2}, v'_{j+1} v''_{j+1}, v''_{j+1} v'_{j+2}$  with  $2_c, f(v_{j+2} v_{j+3}), 1, f(v_{j+1} v_{j+2}), f(v_j v_{j+1})$ , recolor the edges  $v_{j+2} v_{j+3}, \dots, v_{k-2} v_{k-1}$  with the colors  $f(v_{j+1} v_{j+2}), \dots, f(v_{k-3} v_{k-2})$ , and recolor  $v_{j+1} v_{j+2}$  with 1. Let the recolored

coloring be called  $f_1$ . For all the other houses attached to  $F_3$  on  $v_i, v_{i+1}$ , where  $2 \leq i \leq k-3$  ( $i \neq j+1$  when  $j \leq k-5$ ;  $i \neq j+1$  and  $i \neq j-2$  when  $j = k-3$ ), we color  $v_{i+1}v'_{i+1}$  with  $f_1(v_i v_{i+1})$  and recolor  $v_i v_{i+1}$  with 1, then we color  $v_i v'_i, v'_i v'_{i+1}, v'_i v''_i, v'_i v'_{i+1}$  with  $2_c, 1, f_1(v_{i+1} v_{i+2}), f_1(v_{i-1} v_i)$ .  $\square$

## 2.2 $(1, 2^4, k_1)$ -packing edge-coloring of subcubic outerplanar graphs

**Example 2.10.** The gadget  $G_0$  and graph  $G$  are shown in Fig. 4. Each of  $G'_0$  and  $G''_0$  is isomorphic to  $G_0$ . The vertices  $v', v''$  in  $G'_0, G''_0$  correspond to  $v$  in  $G_0$ . We show  $G$  has no  $(1, 2^4, 7)$ -packing edge-coloring.

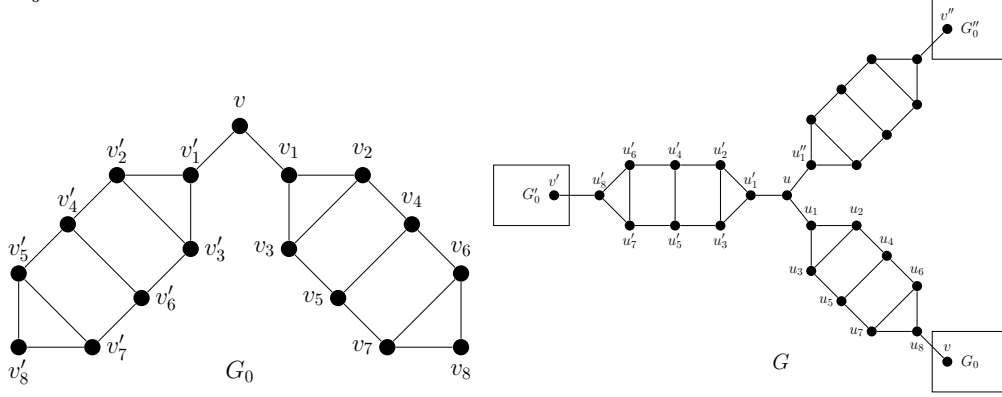

Figure 4: A subcubic outerplanar graph that is not  $(1, 2^4, 7)$ -packing edge-colorable.

**Proof.** Suppose  $G$  has a  $(1, 2^4, 7)$ -packing edge-coloring  $f$ . We first consider the case when one of  $uu_1, uu'_1, uu''_1$  is colored with 7, say  $f(uu'_1) = 7$ . Then none of the edges in the graph  $G_1$  induced by  $\{u_1, \dots, u_8\}$  and the graph  $G'_1$  induced by  $\{u'_1, \dots, u'_8\}$  can be colored with 7. By Remark 2.5, both  $uu_1$  and  $uu'_1$  must be colored with 1, which is a contradiction. Thus, we know color 7 is not used on  $uu_1, uu'_1, uu''_1$ .

Since  $uu_1, uu'_1, uu''_1$  have the same endpoint  $u$ , at least two of them must use a color in  $\{2_a, 2_b, 2_c, 2_d\}$ , say  $f(uu_1) = 2_a$  and  $f(uu'_1) = 2_b$ . By Remark 2.5, color 7 must be used on both  $G_1$  and  $G'_1$ . Due to the distance restriction, color 7 is used on either the triangle  $u_6 u_7 u_8$  or  $u'_6 u'_7 u'_8$ , say color 7 is used on the triangle  $u_6 u_7 u_8$ . Then none of  $vu_8, vv_1, vv'_1$ , and the edges of  $G_0$  can be colored with 7. However, at least one of  $vv_1$  and  $vv'_1$  must be colored with a color in  $\{2_a, 2_b, 2_c, 2_d\}$ . This is a contradiction with Remark 2.5.  $\square$

Since every subcubic outerplanar graph  $G$  is a subgraph of another subgraph  $\hat{G}$  such that  $\hat{G}$  has no 2-vertices (by adding leaf edges to each 2-vertices in  $G$ ). We prove the following theorem on  $(1, 2^4, 3)$ -coloring of subcubic outerplanar graphs with no 2-vertices. Let the graph in Fig. 5 be called the “house-with-chimney” graph (HC graph). We define three types of coloring for the HC graph (See Fig. 5 for Types I, II, and III). If every HC graph is colored using Types I, II, and III unless the “house-without-base” graph is itself a block, and the only neighbor of each vertex of degree one does not see color 3, then we call such a coloring *good coloring* in this subsection.

**Theorem 2.4.** Every subcubic outerplanar graph with no 2-vertices has a good coloring.

**Proof of Theorem 2.4:** Suppose not, i.e., there is a subcubic outerplanar graph with no 2-vertices and it has no good coloring. We take the graph  $G$  with minimum  $|V(G)| + |E(G)|$ . We may assume there is no tree of at least two edges hanging on a cycle in  $G$ , i.e., if there is a tree hanging on a cycle, then it must be an edge. To see this, let  $T$  be a tree hanging on a cycle  $C$  in  $G$ , where  $u \in V(C) \cap V(T)$ , and we assume  $T$  has at least two edges (in fact, at least three

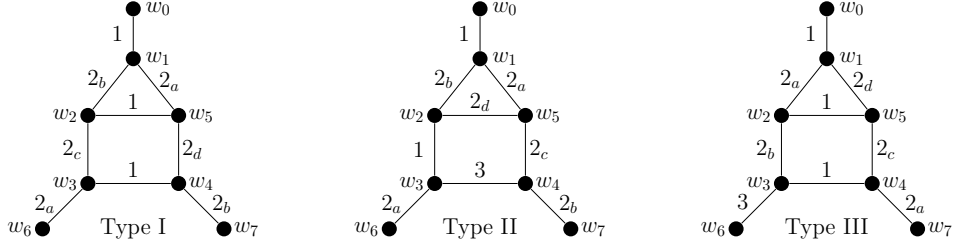

Figure 5: Type I, II, III colorings of the “house-with-chimney” graph.

edges). Let  $P_1$  be a longest path in  $T$  ended at  $u$ , say  $P = u \dots u_1$ . Let the only neighbour of  $u_1$  be  $u_2$ . Since there are no 2-vertices,  $u_2$  has another leaf neighbour  $u'_1$ . Since  $P_1$  has length at least 2,  $u_2 \neq u$ . We delete  $u_1, u'_1$  from  $G$  to obtain a graph  $G'$ , which is a subcubic outerplanar graph with no 2-vertices and satisfies  $|V(G')| + |E(G')| < |V(G)| + |E(G)|$ . By the minimality of  $G$ ,  $G'$  has a good coloring  $f$ . Since there are at most 3 edges within distance two of  $u_1u_2, u'_1u_2$  in  $G$  and we have 5 non-restricted colors  $1, 2_a, 2_b, 2_c, 2_d$  to use at  $u_1u_2, u'_1u_2$ , we can extend  $f$  to  $G$ . By the same proof, we may assume that  $G$  has at least one cycle. In other words,  $G$  has at least one non-trivial block.

We pick a non-trivial leaf block  $B_1$ . Let  $u_0$  be the vertex of  $B_1$  connecting the other blocks in  $G$  and the face containing  $u_0$  be  $F_0$  (if there is only one non-trivial block  $B_1$ , then we pick any leaf edge  $v_0u_0$  in a cycle of  $B_1$ , where  $v_0$  is the 1-vertex). We may assume  $B_1$  has at least two faces. Otherwise, let  $u_0u_1 \dots u_k$  be the boundary cycle of  $F_0$ , where  $k \geq 2$ , and  $N(u_0) = \{u_1, u_k, v_0\}$  and  $N(v_0) = \{u_0, v'_0, v''_0\}$ . Since  $G$  has no 2-vertices, there is a leaf edge  $u_iu'_i$  hanging on each of  $u_i$ , where  $1 \leq i \leq k$ . We delete all  $u_i, u'_i$ ,  $1 \leq i \leq k$ , to obtain  $G'$ . By the minimality of  $G$ ,  $G'$  has a good coloring  $f$ . Then  $|\{f(v_0u_0), f(v_0v'_0), f(v_0v''_0)\} \cap \{2_a, 2_b, 2_c, 2_d\}| \leq 2$ , since if it is 3 then we recolor  $u_0v_0$  to 1.

**Case 1:**  $f(u_0v_0) = 1$ . We color  $u_0u_1, u_0u_k$  with two colors in  $\{2_a, 2_b, 2_c, 2_d\}$ , say  $2_a, 2_b$ . Color  $u_iu'_i$  with 1,  $1 \leq i \leq k$ . If  $k \equiv 0$  or  $2 \pmod{3}$ , then use the pattern  $[2_c, 2_d, 2_a]$  to color the edges  $u_1u_2$  until  $u_{k-1}u_k$ . If  $k = 4$ , then color  $u_1u_2, u_2u_3, u_3u_4$  with  $2_c, 1, 2_d$  and recolor  $u_1u'_1, u_2u'_2, u_3u'_3, u_4u'_4$  with  $1, 2_b, 2_a, 1$ . If  $k \equiv 1 \pmod{3}$  and  $k \neq 4$ , then color  $u_1u_2, u_2u_3$  with  $2_c, 2_b$  and use the pattern  $[2_a, 2_c, 2_d]$  to color the edges  $u_3u_4$  until  $u_{k-1}u_k$ .

**Case 2:**  $f(u_0v_0) \in \{2_a, 2_b, 2_c, 2_d\}$ , say  $f(u_0v_0) = 2_c$  and we can color  $u_0u_k$  with  $2_b$ . Color  $u_iu'_i$  with 1,  $2 \leq i \leq k$ ,  $u_0u_1$  with 1, and  $u_1u'_1$  with  $2_d$ . If  $k \equiv 1$  or  $2 \pmod{3}$ , then use the pattern  $[2_a, 2_c, 2_d]$  to color the edges  $u_1u_2$  until  $u_{k-1}u_k$ . If  $k = 3$ , then color  $u_1u_2, u_2u_3$  with  $2_a, 1$  and recolor  $u_2u'_2, u_3u'_3$  with  $2_c, 2_d$ . If  $k \equiv 0 \pmod{3}$  and  $k \neq 3$ , then color  $u_1u_2, u_2u_3$  with  $2_a, 2_b$  and use the pattern  $[2_c, 2_d, 2_a]$  to color the edges  $u_3u_4$  until  $u_{k-1}u_k$ .

We first show every pendant face (except  $F_0$ ) in  $B_1$  is a 3-face or a 4-face.

**Lemma 2.11.** *Let  $F_1$  be a pendant face in  $B_1$  and  $F_1 \neq F_0$ . Then  $F_1$  is a 3-face or a 4-face.*

**Proof.** Suppose  $F_1$  is a  $k$ -face, where  $k \geq 5$ . Let the only face adjacent to  $F_1$  be  $F_2$  and the boundary cycle of  $F_1$  be  $v_1 \dots v_k$  with  $V(F_1) \cap V(F_2) = \{v_1, v_k\}$ . Since there are no 2-vertices, each  $v_i$  has a leaf neighbour  $v'_i$ ,  $2 \leq i \leq k-1$ . Let  $N(v_1) = \{u_1, v_2, v_k\}$  and  $N(v_k) = \{u_k, v_1, v_{k-1}\}$ . We delete all  $v_i, v'_i$ ,  $2 \leq i \leq k-1$ , and add a vertex  $v, v'$  with edges  $vv_1, vv_k, vv'$  to obtain a graph  $G'$ . By the minimality of  $G$ ,  $G'$  has a good coloring  $f$ .

**Case 1:** Color 3 is not used on  $u_1v_1, v_1v_k, v_kv_k$ .

**Case 1.1:** Color 1 is used twice on  $u_1v_1, v_1v_k, v_kv_k$ . By the definition of good coloring, we may assume  $f(u_1v_1) = f(v_kv_k) = 1$ ,  $f(v_1v_k) = 2_a$ ,  $f(vv_1) = 2_b$ ,  $f(vv_k) = 2_c$ ,  $f(vv') = 1$ . Then we color  $v_1v_2, v_{k-1}v_k$  with  $2_b, 2_c$ . If  $k \equiv 2 \pmod{3}$ , then we color  $v_{k-2}v_{k-1}$  with 1 and  $v_2v_3$  until  $v_{k-3}v_{k-2}$  using the pattern  $[2_d, 2_a, 2_b]$ . Furthermore, we color  $v_{k-1}v'_{k-1}, v_{k-2}v'_{k-2}$  with  $2_b, 2_a$  and all  $v_iv'_i$  with 1,  $2 \leq i \leq k-3$ . If  $k \equiv 0$  or  $1 \pmod{3}$ , then we color the edges  $v_2v_3$  until



$v_{k-2}v_{k-1}$  using the pattern  $[2_d, 2_a, 2_b]$  and all  $v_i v'_i$  with  $1, 2 \leq i \leq k-1$ .

**Case 1.2:** Color 1 is used once on  $u_1 v_1, v_1 v_k, v_k u_k$ . There are two subcases.

**Case 1.2.1:**  $f(u_1 v_1) = f(v v_k) = 1, f(v_1 v_k) = 2_a, f(v_k u_k) = 2_b, f(v v_1) = 2_c, f(v v') = 2_d$ . Then we color  $v_1 v_2, v_{k-1} v_k, v_{k-1} v'_{k-1}$  with  $2_c, 1, 2_c$  and  $v_i v'_i$  with 1, where  $2 \leq i \leq k-2$ . If  $k \equiv 0 \pmod{3}$ , then we color  $v_{k-2} v_{k-1}$  until  $v_2 v_3$  using the pattern  $[2_d, 2_a, 2_b]$ . Otherwise, we color  $v_{k-2} v_{k-1}$  until  $v_2 v_3$  using the pattern  $[2_d, 2_b, 2_a]$ .

**Case 1.2.2:**  $f(v_1 v_k) = f(v v') = 1, f(u_1 v_1) = 2_a, f(v_k u_k) = 2_b, f(v v_1) = 2_c, f(v v_k) = 2_d$ . Then we color  $v_1 v_2, v_{k-1} v_k$  with  $2_c, 2_d$ . If  $k \equiv 1 \pmod{3}$ , then we color  $v_{k-2} v_{k-1}$  with 1 and  $v_2 v_3$  until  $v_{k-3} v_{k-2}$  using the pattern  $[2_b, 2_a, 2_c]$ . Furthermore, we color  $v_{k-1} v'_{k-1}, v_{k-2} v'_{k-2}$  with  $2_a, 2_b$  and all  $v_i v'_i$  with 1,  $2 \leq i \leq k-3$ . If  $k \equiv 0$  or  $2 \pmod{3}$ , then we color the edges  $v_2 v_3$  until  $v_{k-2} v_{k-1}$  using the pattern  $[2_b, 2_a, 2_c]$  and all  $v_i v'_i$  with  $1, 2 \leq i \leq k-1$ .

**Case 1.3:** Color 1 is not used on  $u_1 v_1, v_1 v_k, v_k u_k$ . By the definition of good coloring, We may assume  $f(u_1 v_1) = 2_a, f(v_1 v_k) = 2_b, f(v_k u_k) = 2_c$ . However,  $v v', v v_1, v v_k$  can only be colored by  $\{1, 2_d\}$ , which is impossible.

**Case 2:** Color 3 is used on  $u_1 v_1, v_1 v_k, v_k u_k$ .

**Case 2.1:** Color 1 is used twice on  $u_1 v_1, v_1 v_k, v_k u_k$ . By the definition of good coloring, we may assume  $f(u_1 v_1) = f(v_k u_k) = 1, f(v_1 v_k) = 3, f(v v_1) = 2_a, f(v v_k) = 2_b$ . Then we color  $v_1 v_2, v_{k-1} v_k$  with  $2_a, 2_b$  and the edges  $v_2 v_3$  until  $v_{k-2} v_{k-1}$  using the pattern  $[2_c, 2_d, 2_a]$ . Furthermore, we color  $v_i v'_i$  with 1, where  $2 \leq i \leq k-1$ .

**Case 2.2:** Color 1 is used once on  $u_1 v_1, v_1 v_k, v_k u_k$ . There are three subcases.

**Case 2.2.1:**  $f(u_1 v_1) = f(v v_k) = 1, f(v_1 v_k) = 3, f(v_k u_k) = 2_a, f(v v_1) = 2_b, f(v v') = 2_c$ . We color  $v_1 v_2, v_{k-1} v_k$  with  $2_b, 1$  and  $v_{k-2} v_{k-1}$  until  $v_2 v_3$  using the pattern  $[2_d, 2_a, 2_c]$ . We color  $v_{k-1} v'_{k-1}$  with  $2_b$  and all  $v_i v'_i$  with 1,  $2 \leq i \leq k-2$ .

**Case 2.2.2:**  $f(v_1 v_k) = f(v v') = 1, f(u_1 v_1) = 3, f(v_k u_k) = 2_a, f(v v_1) = 2_b, f(v_1 v_k) = 2_c$ . Then we color  $v_1 v_2, v_{k-1} v_k$  with  $2_b, 2_c$  and  $v_{k-2} v_{k-1}$  until  $v_2 v_3$  using the pattern  $[2_d, 2_a, 2_c]$ . Furthermore, we color all  $v_i v'_i$  with 1,  $2 \leq i \leq k-1$ .

**Case 2.2.3:**  $f(v_k u_k) = f(v v_1) = 1, f(v_1 v_k) = 2_a, f(u_1 v_1) = 3, f(v v_k) = 2_b$ . Then we color  $v_1 v_2, v_{k-1} v_k$  with  $1, 2_b$  and  $v_{k-2} v_{k-1}$  until  $v_2 v_3$  together with  $v_2 v'_2$  using the pattern  $[2_d, 2_c, 2_b]$ . Furthermore, we color  $v_i v'_i$  with 1 for  $3 \leq i \leq k-1$ .

**Case 2.3:** Color 1 is not used on  $u_1 v_1, v_1 v_k, v_k u_k$ . There are two subcases.

**Case 2.3.1:**  $f(u_1 v_1) = 2_a, f(v_1 v_k) = 2_b, f(v_k u_k) = 3, \{f(v v_1), f(v_1 v_k), f(v v')\} = \{1, 2_c, 2_d\}$ . Then we can always exchange colors so that  $v_1 v_k$  is colored with 1, which is already solved in **Case 2.2**.

**Case 2.3.2:**  $f(u_1 v_1) = 2_a, f(v_1 v_k) = 3, f(v_k u_k) = 2_b, \{f(v v_1), f(v_1 v_k), f(v v')\} = \{1, 2_c, 2_d\}$ . We color  $v_1 v_2, v_{k-1} v_k$  with 1 and  $v_{k-2} v_{k-1}, \dots, v_2 v_3$  together with  $v_2 v'_2$  using the pattern  $[2_c, 2_b, 2_d]$ . Furthermore, we color  $v_{k-1} v'_{k-1}$  with  $2_a$  and all  $v_i v'_i$  with 1,  $3 \leq i \leq k-2$ .  $\square$

Let  $P = F_0 F_\ell \dots F_2 F_1$  be a longest path in the weak dual of  $B_1$  starting at  $F_0$ . We first show  $\ell \geq 2$ .

**Lemma 2.12.**  $\ell \geq 2$ .

**Proof.** We first show it is impossible that  $\ell = 1$  and  $F_2$  (now also  $F_0$ ) is a 3-face. Suppose not, i.e.,  $F_2 = F_0$  and  $F_2$  has boundary cycle  $u_0 u_1 u_2$ , where  $u_1, u_2 \in V(F_1) \cap V(F_2)$ . In this case,  $F_1$  is a 3-face or a 4-face by Lemma 2.11. We delete  $V(F_1)$  with all its leaf edges from  $G$  to obtain a graph  $G'$ . By the minimality of  $G$ ,  $G'$  has a good coloring  $f$ . By the definition of good coloring, we may assume  $f(v_0 u_0)$  is either 1 or  $2_a$ . In case  $F_1$  is a 3-face, let the boundary cycle of  $F_1$  be  $u_1 u_2 u_3$  and  $u_3 u'_3$  be the leaf edge. If  $f(v_0 u_0) = 1$ , then we can always color  $u_0 u_1$  and  $u_0 u_2$  with colors from  $\{2_a, 2_b, 2_c, 2_d\}$ , say  $u_0 u_1$  with  $2_c$  and  $u_0 u_2$  with  $2_d$ . Then we color  $u_1 u_3, u_2 u_3, u_3 u'_3$  with  $2_a, 2_b, 1$ . If  $f(v_0 u_0) = 2_a$ , then we can always color  $u_0 u_2$  with a color in  $\{2_b, 2_c, 2_d\}$ , say  $2_b$ , and color  $u_0 u_1, u_1 u_2, u_1 u_3, u_2 u_3, u_3 u'_3$  with  $1, 2_d, 2_c, 1, 2_a$ .

This is a contradiction. In case  $F_1$  is a 4-face, let the boundary cycle of  $F_1$  be  $u_1u_2u_3u_4$  with two leaf edges  $u_3u'_3$  and  $u_4u'_4$ . If  $f(v_0u_0) = 1$ , then we can always color  $u_0u_1, u_0u_2$  with two colors from  $\{2_a, 2_b, 2_c, 2_d\}$ , say  $2_c, 2_d$ , and color  $u_1u_2, u_1u_4, u_2u_3, u_3u_4, u_3u'_3, u_4u'_4$  with  $1, 2_a, 2_b, 1, 2_c, 2_d$ . If  $f(v_0u_0) = 2_a$ , then we can always color  $u_0u_2$  with a color in  $\{2_b, 2_c, 2_d\}$ , say  $2_b$ , and color  $u_0u_1, u_1u_2, u_1u_4, u_2u_3, u_3u_4, u_3u'_3, u_4u'_4$  with  $1, 3, 2_c, 1, 2_d, 2_a, 2_b$ . This is a contradiction.

Then we complete the proof that  $\ell \neq 1$ . Suppose not, let the boundary cycle of  $F_2$  be  $u_0u_1 \dots u_k, k \geq 3$ . We delete  $u_1, \dots, u_k$ , all pendant faces adjacent to  $F_2$ , and their leaf edges, to obtain a graph  $G'$ . By the minimality of  $G$ ,  $G'$  has a good coloring  $f$ . Let  $F$  be a pendant face adjacent to  $F_2$  with  $V(F) \cap V(F_2) = \{u_i, u_{i+1}\}, 1 \leq i \leq k-1$ . We may treat  $F$  as a 4-face  $u_iu'_iu'_{i+1}u_{i+1}u_i$  with an additional pendant face  $u'_iu'_{i+1}u''_i$  plus a leaf edge  $u''_iw_i$  (neither a 3-face  $u_iu'_iu_{i+1}u_i$  with leaf edge  $u'_iu''_i$  nor a 4-face  $u_iu'_iu'_{i+1}u_{i+1}u_i$  with leaf edges  $u'_iu''_i, u'_{i+1}u''_{i+1}$ ) when we extend the coloring  $f$  to  $G$ , since we can always use the coloring of the HC graph (induced by  $w_i, u_{i-1}, u_i, u'_i, u''_i, u_{i+1}, u'_{i+1}, u''_{i+1}, u_{i+2}$ ) on  $F$  and its leaf edges. Note that we always color  $u_iu'_i, u_{i+1}u'_{i+1}$  with different colors and can use the color used on  $u'_iu'_{i+1}$  (of the HC graph) to color the leaf edge  $u'_iu''_i$  of a 3-face. Let  $F'_1$  be the pendant face adjacent to  $F_2$  such that  $V(F'_1) \cap V(F_2)$  has the largest indices, say  $V(F'_1) \cap V(F_2) = \{u_j, u_{j+1}\}$ , where  $1 \leq j \leq k-1$ . We know  $k \geq 3$  and  $f(u_0v_0) = 1$  or  $f(u_0v_0) \in \{2_a, 2_b, 2_c, 2_d\}$ , say  $f(u_0v_0) = 2_c$ . We can first color every leaf edge hang on  $F_2$  with 1.

**Case A:**  $f(u_0v_0) = 1$ . We can always color  $u_0u_1, u_0u_k$  with two colors from  $\{2_a, 2_b, 2_c, 2_d\}$ , say  $2_a, 2_b$ . If  $k \equiv 0$  (or 2) (mod 3), then we use the pattern  $[2_c, 2_d, 2_a]$  to color the edges from  $u_1u_2$  to  $u_{k-1}u_k$ . We color  $u_ju'_j$  with  $f(u_ju_{j+1})$ , recolor  $u_ju_{j+1}$  to 3, and color  $u_{j+1}u'_{j+1}, u'_ju'_{j+1}, u'_ju''_j, u'_{j+1}u''_{j+1}, u'_jw_j$  with  $1, 2_a(2_d), 1, f(u_{j-1}u_j), 2_b$  when  $j = k-1$  and with  $1, 2_b, 1, f(u_{j-1}u_j), f(u_{j+1}u_{j+2})$  when  $j \leq k-2$ . If  $k \equiv 1$  (mod 3), then we use the pattern  $[2_c, 2_d, 2_a]$  to color the edges from  $u_1u_2$  to  $u_{k-1}u_k$  except  $u_ju_{j+1}$ , and color  $u_ju_{j+1}, u_ju'_j, u_{j+1}u'_{j+1}, u'_ju'_{j+1}, u'_ju''_j, u'_{j+1}u''_{j+1}, u'_jw_j$  with  $3, 2_a, 1, 2_c, 1, 2_d, 2_b$  when  $j = k-1$  and color  $u_ju_{j+1}, u_ju'_j, u_{j+1}u'_{j+1}, u'_ju'_{j+1}, u'_ju''_j, u'_{j+1}u''_{j+1}, u'_jw_j$  with  $3, 1, x, f(u_{j+2}u_{j+3}), f(u_{j+1}u_{j+2}), 1, y$  when  $j \leq k-2$ , where  $x \notin \{f(u_{j-1}u_j), f(u_{j+1}u_{j+2}), f(u_{j+2}u_{j+3}), 1, 3\}$  and  $y \notin \{f(u'_ju'_{j+1}), f(u'_ju''_j), x, 1, 3\}$ . For other HC graphs on  $u_i, u_{i+1}$ , where  $1 \leq i \leq k-3$  and  $i \neq j$ , we color  $u_iu'_i$  with  $f(u_iu_{i+1})$ , recolor  $u_iu_{i+1}$  to 1, and color  $u_{i+1}u'_{i+1}, u'_iu'_{i+1}, u'_iu''_i, u'_{i+1}u''_{i+1}, u'_iw_i$  with  $2_b, 1, f(u_{i+1}u_{i+2}), f(u_{i-1}u_i), 1$ .

**Case B:**  $f(u_0v_0) = 2_c$ . We may assume  $1 \in \{f(v_0v'_0), f(v_0v''_0)\}$  and thus can color  $u_0u_1, u_0u_k$  with two colors from  $\{2_a, 2_b, 2_c, 2_d\}$ , say  $2_a, 2_b$ . If  $k \equiv 2$  (mod 3), then we use the same argument in **Case A**. If  $k \equiv 0$  (mod 3), then we use the pattern  $[2_d, 2_c, 2_a]$  to color the edges from  $u_1u_2$  to  $u_{k-1}u_k$  except  $u_ju_{j+1}$ , color  $u_ju_{j+1}, u_ju'_j, u_{j+1}u'_{j+1}, u'_ju'_{j+1}, u'_ju''_j, u'_{j+1}u''_{j+1}, u'_jw_j$  with  $3, 2_c, 1, 2_a, 1, 2_d, 2_b$  when  $j = k-1$ , with  $3, 1, 2_c, 2_b, 2_d, 1, 2_a$  when  $j = k-2$ , and with  $3, 2_b, 1, f(u_{j+2}u_{j+3}), 1, f(u_{j-1}u_j), f(u_{j+1}u_{j+2})$  when  $j \leq k-3$ . If  $k \equiv 1$  (mod 3), then we use the pattern  $[2_d, 2_c, 2_a]$  to color the edges  $u_1u_2$  until  $u_{k-2}u_{k-1}$ , and color  $u_ju_{j+1}, u_ju'_j, u_{j+1}u'_{j+1}, u'_ju'_{j+1}, u'_ju''_j, u'_{j+1}u''_{j+1}, u'_jw_j$  with  $3, 2_a, 1, 2_d, 1, 2_c, 2_b$  when  $j = k-1$  and color  $u_ju'_j$  with  $f(u_ju_{j+1})$ , recolor  $u_{k-1}u_k, u_0u_k, u_ku'_k$  with  $2_b, 1, 2_d$ , color  $u_{j+1}u'_{j+1}, u'_ju'_{j+1}, u'_ju''_j, u'_{j+1}u''_{j+1}, u'_jw_j$  with  $1, x, 1, f(u_{j-1}u_j), y$  when  $j \leq k-2$ , where  $x \notin \{1, 3, f(u_{j-1}u_j), f(u_ju_{j+1}), f(u_{j+1}u_{j+2})\}$  and  $y \notin \{f(u_ju'_j), f(u'_{j+1}u''_j), x, 1, 3\}$ , and recolor  $u_ju_{j+1}$  with 3. For other HC graphs on  $u_i, u_{i+1}$ , where  $1 \leq i \leq k-3$  and  $i \neq j$ , we color  $u_iu'_i$  with  $f(u_iu_{i+1})$ , recolor  $u_iu_{i+1}$  to 1, and color  $u_{i+1}u'_{i+1}, u'_iu'_{i+1}, u'_iu''_i, u'_{i+1}u''_{i+1}, u'_iw_i$  with  $2_b, 1, f(u_{i+1}u_{i+2}), f(u_{i-1}u_i), 1$ .  $\square$

Then we show  $F_2$  must be a 4-face when  $\ell \geq 2$ .

**Lemma 2.13.**  $F_2$  is a 4-face.

**Proof.** By Lemma 2.12,  $\ell \geq 2$ . Suppose  $F_2$  is a  $k$ -face, where  $k \geq 5$ . Let the boundary cycle of  $F_2$  be  $v_1 \dots v_k$  with  $V(F_3) \cap V(F_2) = \{v_1, v_k\}$ . We delete  $v_2, \dots, v_{k-1}$  and all pendant faces hang on  $F_2$  with all their leaf edges, and add

vertices  $z, z_1, z_2, z_k$  with edges  $z_1v_1, z_kv_k, z_1z_k, z_1z_2, z_2z_k, z_2z$  (HC graph) to obtain a graph  $G'$ . By the minimality of  $G, G'$  has a good coloring  $f$ . We aim to extend  $f$  to  $G'$ . Let  $F$  be a pendant face adjacent to  $F_2$  with  $V(F) \cap V(F_2) = \{v_i, v_{i+1}\}$ ,  $2 \leq i \leq k-1$ . We may assume  $F$  is a 4-face  $v_iv'_i v'_{i+1} v_{i+1}$  with leaf edges  $v'_i v''_i, v'_{i+1} v''_{i+1}$  for the same reason as we discussed in the second paragraph of the proof of Lemma 2.12. Furthermore, we may assume  $v''_i = v''_{i+1}$  and add a new vertex  $w_i$  with the edge  $w_i v''_i$ . In this way, we are coloring a larger graph than  $G'$  and can use the proof in the future. Let  $F'_1$  be the pendant face adjacent to  $F_2$  such that  $V(F'_1) \cap V(F_2)$  has the largest indices, say  $V(F'_1) \cap V(F_2) = \{v_j, v_{j+1}\}$ , where  $2 \leq j \leq k-2$ . Since there are no 2-vertices, each  $v_i$  with no pendant faces on top has a leaf neighbour  $v'_i$ ,  $2 \leq i \leq k-1$ . Let  $N(v_1) = \{u_1, v_2, v_k\}$  and  $N(v_k) = \{u_k, v_1, v_{k-1}\}$ .

**Case 1:** The HC graph uses type I coloring, i.e.,  $u_1v_1, v_1v_k, v_kv_k, v_1z_1, v_kz_k, z_1z_k, z_1z_2, z_2z_k, z_2z$  are colored with  $2_a, 1, 2_b, 2_c, 2_d, 1, 2_b, 2_a, 1$ . We color  $v_1v_2, v_{k-1}v_k$  with  $2_c, 2_d$  and all leaf edges  $v_iv'_i$  with 1.

**Case 1.1:**  $k \equiv 2 \pmod{3}$ . Then we use the pattern  $[2_b, 2_a, 2_c]$  to color the edge  $v_2v_3$  until the edge  $v_{k-2}v_{k-1}$ . If there is an HC graph on  $v_{k-2}, v_{k-1}$ , then we color  $v_{k-2}v_{k-1}, v_{k-2}v'_{k-2}, v_{k-1}v'_{k-1}, v'_{k-2}v'_{k-1}, v'_{k-2}v''_{k-2}, v'_{k-1}v''_{k-2}, v''_{k-2}w_{k-2}$  with  $1, 2_a, 2_c, 1, 2_d, 2_b, 1$ . For other HC graphs on  $v_i, v_{i+1}$ , where  $2 \leq i \leq k-3$ , we color  $v_{i+1}v'_{i+1}$  with  $f(v_iv_{i+1})$ , recolor  $v_iv_{i+1}$  with 1, color  $v_iv'_i, v'_i v'_{i+1}, v'_i v''_i, v'_{i+1} v''_{i+1}, v''_i w_i$  with  $2_d, 1, f(v_{i+1}v_{i+2}), f(v_{i-1}v_i), 1$ .

**Case 1.2:**  $k \equiv 1 \pmod{3}$ . Since  $k \geq 5, k \geq 7$ . Then we use the pattern  $[2_b, 2_a, 2_c]$  to color the edge  $v_2v_3$  until the edge  $v_{k-2}v_{k-1}$  except  $v_jv_{j+1}$ . If  $j = k-2$ , then we color  $v_{k-2}v_{k-1}, v_{k-2}v'_{k-2}, v_{k-1}v'_{k-1}, v'_{k-2}v'_{k-1}, v'_{k-2}v''_{k-2}, v'_{k-1}v''_{k-2}, v''_{k-2}w_{k-2}$  with  $1, 2_b, 2_a, 1, 2_d, 2_c, 1$ . If  $3 \leq j \leq k-3$ , then we color  $v_iv_{i+1}, v_iv'_i, v_{i+1}v'_{i+1}, v'_i v'_{i+1}, v'_i v''_i, v'_{i+1} v''_{i+1}, v''_i w_i$  with  $3, 2_d, 1, f(v_{j-2}v_{j-1}), 1, f(v_{j-1}v_j), f(v_{j+1}v_{j+2})$ . If  $j = 2$ , then we use the pattern  $[2_a, 2_b, 2_d]$  to color the edge  $v_{k-2}v_{k-1}$  until the edge  $v_3v_4$ , and color  $v_2v_3, v_2v'_2, v_3v'_3, v'_2v'_3, v'_2v''_2, v'_3v''_3, v''_2w_2$  with  $1, 2_b, 2_a, 1, 2_d, 2_c, 1$ . For other HC graphs on  $v_i, v_{i+1}$ , where  $2 \leq i \leq k-3$  and  $i \neq j$ , we color  $v_{i+1}v'_{i+1}$  with  $f(v_iv_{i+1})$ , recolor  $v_iv_{i+1}$  with 1, color  $v_iv'_i, v'_i v'_{i+1}, v'_i v''_i, v'_{i+1} v''_{i+1}, v''_i w_i$  with  $2_d, 1, f(v_{i+1}v_{i+2}), f(v_{i-1}v_i), 1$ .

**Case 1.3:**  $k \equiv 0 \pmod{3}$ . Since  $k \geq 5, k \geq 6$ . We use the pattern  $[2_d, 2_a, 2_c]$  to color the edge  $v_2v_3$  until  $v_{k-2}v_{k-1}$ . If there is a HC on  $v_i, v_{i+1}$ , where  $2 \leq i \leq k-2$ , we color  $v_{i+1}v'_{i+1}$  with  $f(v_iv_{i+1})$ , recolor  $v_iv_{i+1}$  with 1, color  $v_iv'_i, v'_i v'_{i+1}, v'_i v''_i, v'_{i+1} v''_{i+1}, v''_i w_i$  with  $2_b, 1, f(v_{i+1}v_{i+2}), f(v_{i-1}v_i), 1$ .

**Case 2:** The HC graph uses type II coloring, i.e.,  $u_1v_1, v_1v_k, v_kv_k, v_1z_1, v_kz_k, z_1z_k, z_1z_2, z_2z_k, z_2z$  are colored with  $2_a, 3, 2_b, 2_c, 1, 2_d, 2_b, 2_a, 1$ . We color  $v_1v_2, v_{k-1}v_k$  with  $2_c, 1$ , all leaf edges  $v_iv'_i$  with 1 except  $v_{k-1}v'_{k-1}$  (if it is a leaf), and use the pattern  $[2_d, 2_a, 2_c]$  to color the edge  $v_2v_3$  until  $v_{k-2}v_{k-1}$  together with  $v_{k-1}v'_{k-1}$  (if it is a leaf). Since  $k \geq 5$ , if there is an HC graph on  $v_{k-2}, v_{k-1}$ , then we color  $v_{k-1}v'_{k-1}$  with  $f(v_{k-2}v_{k-1})$ , recolor  $v_kv_k, v_{k-1}v_k, v_{k-2}v_{k-1}$  with  $1, 3, 1$ , and color  $v_{k-2}v'_{k-2}, v'_{k-2}v'_{k-1}, v'_{k-2}v''_{k-2}, v'_{k-1}v''_{k-2}, v''_{k-2}w_{k-2}$  with  $2_b, 1, f(v_{k-4}v_{k-3}), f(v_{k-3}v_{k-2}), 1$ . For other HC graphs on  $v_i, v_{i+1}$ ,  $2 \leq i \leq k-3$ , we color  $v_{i+1}v'_{i+1}$  with  $f(v_iv_{i+1})$ , recolor  $v_iv_{i+1}$  with 1, color  $v_iv'_i, v'_i v'_{i+1}, v'_i v''_i, v'_{i+1} v''_{i+1}, v''_i w_i$  with  $2_b, 1, f(v_{i+1}v_{i+2}), f(v_{i-1}v_i), 1$ .

**Case 3:** The HC graph uses type III coloring, i.e.,  $u_1v_1, v_1v_k, v_kv_k, v_1z_1, v_kz_k, z_1z_k, z_1z_2, z_2z_k, z_2z$  are colored with  $2_c, 1, 3, 2_a, 2_b, 1, 2_d, 2_c, 1$ . We color  $v_1v_2, v_{k-1}v_k$  with  $2_a, 2_b$ , all leaf edges  $v_iv'_i$  with 1, and use the pattern  $[2_d, 2_c, 2_a]$  to color the edge  $v_2v_3$  until  $v_{k-2}v_{k-1}$ . Since  $k \geq 5$ , if there is an HC graph on  $v_{k-2}, v_{k-1}$ , then we color  $v_{k-2}v'_{k-2}$  with  $f(v_{k-2}v_{k-1})$ , recolor  $v_{k-2}v_{k-1}$  with 1, and color  $v_{k-1}v'_{k-1}, v'_{k-2}v'_{k-1}, v'_{k-2}v''_{k-2}, v'_{k-1}v''_{k-2}, v''_{k-2}w_{k-2}$  with  $f(v_{k-4}v_{k-3}), 1, 2_b, f(v_{k-3}v_{k-2}), 1$ . For other HC graphs on  $v_i, v_{i+1}$ ,  $2 \leq i \leq k-3$ , we color  $v_{i+1}v'_{i+1}$  with  $f(v_iv_{i+1})$ , recolor  $v_iv_{i+1}$  with 1, color  $v_iv'_i, v'_i v'_{i+1}, v'_i v''_i, v'_{i+1} v''_{i+1}, v''_i w_i$  with  $2_b, 1, f(v_{i+1}v_{i+2}), f(v_{i-1}v_i), 1$ .  $\square$

**Remark 2.14.** Additionally, in Lemma 2.13, if  $F_2$  is a 4-face, then  $F_1$  must be a 3-face. Suppose not, i.e.,  $F_1$  is a 4-face  $v_1v_2v_3v_4v_1$  with leaf edges  $v_2v'_2, v_3v'_3$ , where  $v(F_1) \cap V(F_2) = \{v_1, v_4\}$ . Let the boundary cycle of  $F_2$  be  $v'_1v_1v_4v'_4v'_1$ ,  $N(v'_1) = \{v_1, v'_1, v_4\}$ , and  $N(v'_4) = \{v'_1, v_4, v'_4\}$ . We delete  $v_2, v'_2, v_3, v'_3$  and add a vertex  $v, v'$  with edges  $vv_1, vv_4, vv'$  to obtain a graph  $G'$ . By the minimality of  $G$ ,  $G'$  has a good coloring  $f$ . If the HC graph (induced by  $v, v', v_1, v'_1, v'_4, v_4, v'_4, v'_1$ ) uses type I coloring (type III coloring), say  $v'_1v'_1, v'_1v'_4, v'_4v'_4, v_1v'_1, v_4v'_4, v_1v_4, vv_1, vv_4, vv_1$  uses  $2_a(3), 1, 2_b, 2_c, 2_d, 1, 2_b, 2_a, 1$ , then we color  $v_1v_2, v_3v_4, v_2v_3, v_2v'_2, v_3v'_3$  with  $2_b, 2_a, 1, 2_d, 2_c$ . If the HC graph uses type II coloring, say  $v'_1v'_1, v'_1v'_4, v'_4v'_4, v_1v'_1, v_4v'_4, v_1v_4, vv_1, vv_4, vv_1$  uses  $2_a, 3, 2_b, 1, 2_c, 2_d, 2_b, 1, 2_a$ , then we recolor  $v'_1v'_4, v_1v'_1, v_1v_4$  with  $1, 3, 1$ , and color  $v_1v_2, v_3v_4, v_2v_3, v_2v'_2, v_3v'_3$  with  $2_b, 2_a, 1, 2_c, 2_d$ .

Now, we complete the proof. By Lemma 2.12,  $\ell \geq 2$ . We split the proof into two cases.

**Case i:**  $\ell = 2$ . By Lemma 2.13 together with Remark 2.14,  $B_1$  can be described as  $F_0$  with a few leaf edges, 3-faces with a leaf edge, 4-faces with two leaf edges, and HC graphs attached on it. We can use the same argument used in the proof of Lemma 2.12, since we treated every 3-face with a leaf edge and every 4-face with two leaf edges as an HC graph in the coloring procedure.

**Case ii:**  $\ell \geq 3$ . Let  $V(F_3) \cap V(F_4) = \{v_1, v_k\}$ . We delete  $V(F_3) - \{v_1, v_k\}$ , all leaf edges, all 3-faces with a leaf edge, all 4-faces with two leaf edges, all HC graphs attached on  $F_3$ , and add vertices  $z, z_1, z_2, z_k$  with edges  $z_1v_1, z_kv_k, z_1z_k, z_1z_2, z_2z_k, z_2z$  (HC graph) to obtain a graph  $G'$ . By the minimality of  $G$ ,  $G'$  has a good coloring  $f$ . We can use the argument used in the proof of Lemma 2.13, since we treated every 3-face with a leaf edge and every 4-face with two leaf edges as an HC graph in the color-extending procedure.  $\square$

### 3 $(1^2, 2^k)$ -packing edge-colorings of subcubic outerplanar graphs

In this section, we focus on  $(1^2, 2^k)$ -colorings of subcubic outerplanar graphs. We first show in Example 3.1 that there are subcubic outerplanar graphs that are not  $(1^2, 2^2)$ -colorable. Note that our example is also 2-connected.

**Example 3.1.** Let the graphs  $G_0$  and  $G_1$  be the graphs shown in Fig. 6. The graph  $G_1$  is subcubic, outerplanar, and even 2-connected. We show  $G_1$  has no  $(1^2, 2^2)$ -packing edge-coloring.

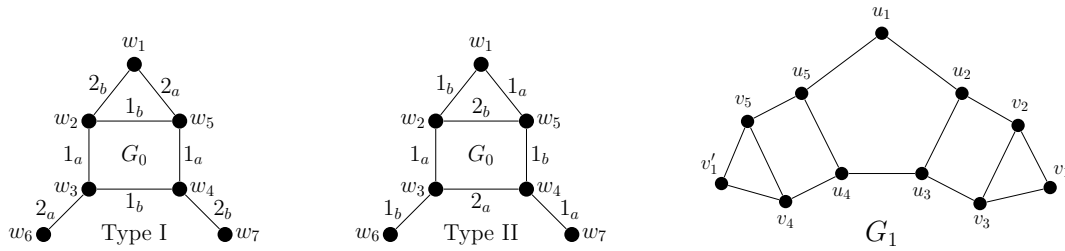

Figure 6: A subcubic outerplanar graph that is not  $(1^2, 2^2)$ -packing edge-colorable.

**Proof.** We first show graph  $G_0$  has exactly two different  $(1^2, 2^2)$ -packing edge-coloring up to symmetry.

**Claim 3.2.** Graph  $G_0$  has exactly two different  $(1^2, 2^2)$ -packing edge-coloring up to symmetry.

**Proof.** Let  $f$  be a  $(1^2, 2^2)$ -packing edge-coloring of  $G_0$ . Since the triangle  $w_1w_2w_5$  needs three distinct colors,  $\{2_a, 2_b\} \not\subseteq \{f(w_2w_3), f(w_3w_4), f(w_4w_5)\}$ . Therefore, the colors of  $w_2w_3, w_3w_4, w_4w_5$  can be  $1_a, 1_b, 1_a$  or  $1_a, 2_a, 1_a$  or  $1_a, 1_b, 2_a$  or  $1_a, 2_a, 1_b$  up to symmetry. If it is  $1_a, 1_b, 2_a$ , then  $f(w_3w_6)$  must be  $2_b$  and we cannot color  $w_1w_2w_5$ , which

is a contradiction. If it is  $1_a, 2_a, 1_a$ , then there are only two available colors ( $\{1_b, 2_b\}$ ) for  $w_1w_2w_5$ , which is again a contradiction. Therefore, the colors used on  $w_2w_3, w_3w_4, w_4w_5$  must be  $1_a, 1_b, 1_a$  or  $1_a, 2_a, 1_b$ . Furthermore, if the colors are  $1_a, 1_b, 1_a$ , then  $f(w_3w_6) = 2_a$  and  $f(w_4w_7) = 2_b$ , and  $f(w_2w_5) = 1_b, f(w_1w_5) = 2_a$ , and  $f(w_1w_2) = 2_b$ . We call this the **Type I** coloring of  $G_0$ . If the colors are  $1_a, 2_a, 1_b$ , then  $w_2w_5$  must use  $2_b$  and thus  $w_1w_2, w_1w_5$  must use  $1_b, 1_a$ . Hence,  $w_3w_6, w_4w_7$  must use  $1_b, 1_a$ . We call this the **Type II** coloring of  $G_0$ .  $\square$

We are now ready to show  $G_1$  has no  $(1^2, 2^2)$ -packing edge-coloring. Suppose not, i.e.,  $G_1$  has a  $(1^2, 2^2)$ -packing edge-coloring  $f$ . Since  $G_1$  contains two copies of  $G_0$  and they share the edge  $u_3u_4$ , they must be the same type. If both copies are of Type I, then there are three edges in the 5-cycle that are colored with a color in  $\{2_a, 2_b\}$ . This is a contradiction. If both copies are of Type II, say  $f(u_2u_3) = 2_a, f(u_1u_2) = 1_a, f(u_3u_4) = 1_b$ , then it implies  $f(u_4u_5) = 2_b$  and  $f(u_1u_5) = 1_a$ . This is again a contradiction.  $\square$

Inspired by Conjecture 1.1, we explore the question ‘‘What is the largest  $k_2$  such that every subcubic outerplanar graph is  $(1^2, 2^2, k_2)$ -packing edge-colorable?’’. We prove in Section 3.1 that  $k_2 \geq 3$  and  $k_2 \leq 4$ .

**Theorem 3.1.** *Every subcubic outerplanar graph is  $(1^2, 2^2, 3)$ -packing edge-colorable.*

As a corollary of our result, every subcubic outerplanar graph is  $(1^2, 2^3)$ -packing edge-colorable, and thus we confirmed the conjecture (two 1-colors) of Hocquard et al [12] for subcubic outerplanar graphs.

**Corollary 3.3.** *Every subcubic outerplanar graph is  $(1^2, 2^3)$ -packing edge-colorable.*

Corollary 3.3 is also sharp since there are subcubic outerplanar graphs that are not  $(1^2, 2^2)$ -colorable (Example 3.1).

### 3.1 $(1^2, 2^2, k_2)$ -packing edge-coloring of subcubic outerplanar graphs

We provide a subcubic outerplanar graph that is not  $(1^2, 2^2, 5)$ -colorable, showing  $k_2 \leq 4$ .

**Example 3.4.** *The graph  $G_3$  is shown in the right picture of Fig. 7. Each of the gadget  $G_{2a}, \dots, G_{2e}$  is isomorphic to  $G_2$ , which is shown in the left picture of Fig. 7. Each vertex  $u_{1a}, \dots, u_{1e}$  of  $G_{2a}, \dots, G_{2e}$  corresponds to  $u_1$  of  $G_2$ . In  $G_2$ , each gadget  $G_{1a}, \dots, G_{1g}$  is isomorphic to the graph  $G_1$  in Example 3.1. We show  $G_3$  is a subcubic outerplanar graph with no  $(1^2, 2^2, 5)$ -coloring.*

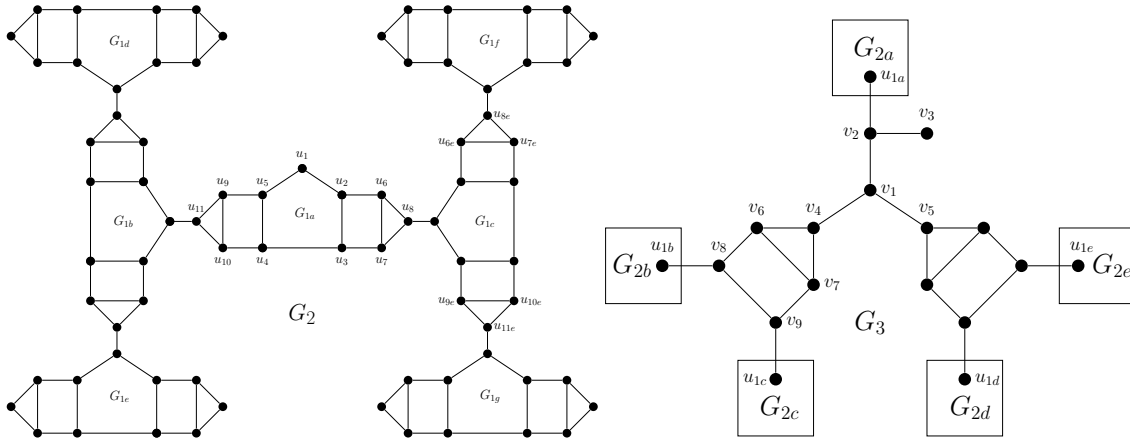

Figure 7: A subcubic outerplanar graph that is not  $(1^2, 2^2, 5)$ -packing edge-colorable.

**Proof.** We claim only edges  $u_1u_2, u_2u_3, u_3u_4, u_4u_5, u_1u_5$  in  $G_2$  can use color 5 in each  $(1^2, 2^2, 5)$ -coloring.

**Claim 3.5.** Only edges  $u_1u_2, u_2u_3, u_3u_4, u_4u_5, u_1u_5$  in  $G_2$  can use color 5 in each  $(1^2, 2^2, 5)$ -coloring.

**Proof.** By Example 3.1, each of  $G_{1a}, \dots, G_{1g}$  must use color 5 exactly once. We first notice that  $u_6u_8, u_7u_8$  cannot be colored with 5. Otherwise, no vertices of  $G_{1e}$  can be colored with 5. This is a contradiction. Similarly,  $u_9u_{11}, u_{10}u_{11}$  cannot be colored with 5. Suppose one of  $u_2u_6, u_6u_7, u_3u_7$  is colored with 5. Then the only two edges of  $G_{1e}$  that can be colored with 5 are  $u_7e u_{8e}$  and  $u_{10e}u_{11e}$ , say  $u_7e u_{8e}$  is colored with 5. However, no vertices of  $G_{1f}$  can be colored with 5, which is a contradiction. Similarly,  $u_5u_9, u_9u_{10}, u_4u_{10}$  cannot be colored with 5.  $\square$

Suppose  $G_3$  has a  $(1^2, 2^2, 5)$ -coloring. By Claim 3.5, none of  $u_{1a}v_2, v_2v_3, v_1v_2, v_1v_5, v_1v_4$  can be colored with 5. Furthermore,  $v_1v_4$  and  $v_1v_5$  cannot both be colored with a color in  $\{2_a, 2_b\}$ , since otherwise, say  $v_1v_4, v_1v_5$  is colored with  $2_a, 2_b$ ,  $v_1v_2$  must be colored with a color in  $\{1_a, 1_b\}$  and we only have one available color for  $v_2u_{1a}$  and  $v_2v_3$ . This is a contradiction. We may assume  $v_1v_4$  is colored with  $1_a$ . Applying Claim 3.5 to  $G_{2b}$  and  $G_{2c}$ , we know none of the edges  $v_4v_6, v_4v_7, v_6v_7, v_6v_8, v_7v_9, v_8v_9, v_8u_{1b}, v_9u_{1c}$  can be colored with 5. However, by Claim 3.2,  $v_4v_6, v_4v_7$  must be colored with  $2_a, 2_b$ . This is a contradiction since we only have one available color for edges  $v_1v_2$  and  $v_1v_5$ .  $\square$

Then we show every subcubic outerplanar graph is  $(1^2, 2^2, 3)$ -packing edge-colorable and thus  $3 \leq k_2 \leq 4$ . In this subsection, a *good coloring* is a  $(1^2, 2^2, 3)$ -packing edge-coloring such that every HC graph can only be colored with type I, II, III, IV, V colorings, unless there are at least two non-trivial block and the vertex  $w_0$  of the HC graph is a degree three vertex in  $G$  (see Fig. 8).

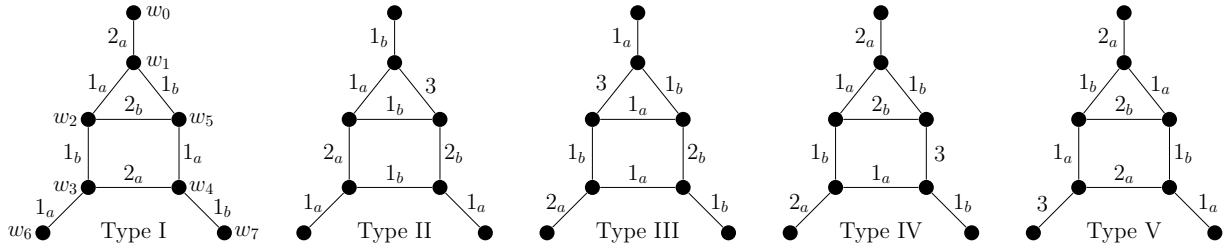

Figure 8: Type I, II, III, IV, V colorings of the “house-with-chimney” graph.

**Theorem 3.2.** Every subcubic outerplanar graph with no 2-vertices has a good coloring.

**Proof of Theorem 3.2:** The proof strategy is similar to the proof of Theorem 2.4. Suppose not, i.e., there is a subcubic outerplanar graph with no 2-vertices and it has no good coloring. We take the graph  $G$  with minimum  $|V(G)| + |E(G)|$ . We first show if there is a tree hanging on a cycle, then it must be an edge. To see this, let  $T$  be a tree hanging on a cycle  $C$  in  $G$ , where  $u \in V(C) \cap V(T)$ , and we assume  $T$  has at least three edges. Let  $P_1$  be a longest path in  $T$  ended at  $u$ , say  $P = uu_s \dots u_1$ ,  $s \geq 2$ . Let the only neighbour of  $u_1$  be  $u_2$ . Since there are no 2-vertices,  $u_2$  has another leaf neighbour  $u'_1$ . Since  $s \geq 2$ ,  $u_2 \neq u$ . We delete  $u_1, u'_1$  from  $G$  to obtain a graph  $G'$ , which is a subcubic outerplanar graph with no 2-vertices and satisfies  $|V(G')| + |E(G')| < |V(G)| + |E(G)|$ . By the minimality of  $G$ ,  $G'$  has a good coloring  $f$ . Let  $N(u) = \{u_s, u', u''\}$ . If  $s = 2$ , then  $f(uu_2) \in \{1_a, 1_b\}$ , say  $f(uu_2) = 1_a$ , since otherwise we can color  $u_2u_1, u_2u'_1$  with  $1_a, 1_b$ . Furthermore, we may assume  $\{f(uu'), f(uu'')\} = \{2_a, 2_b\}$ , since otherwise we can color  $u_2u'_1$  with  $1_b$  and  $u_2u_1$  with a color from  $\{2_a, 2_b\}$ . We also know  $u', u''$  must be 3-vertices and adjacent to two edges colored with  $1_a, 1_b$ , since otherwise we can recolor  $uu'$  or  $uu''$  with a color in  $\{1_a, 1_b\}$  and complete the extension. Therefore,

we can color  $u_2u'_1, u_2u_1$  with  $1_b, 3$ . If  $s \geq 3$ , then similarly we know 3 is not used within distance three from  $u_1u_2$  and thus we can color  $u_2u'_1, u_2u_1$  with  $1_b, 3$ . This is a contradiction. By the same proof, we may assume that  $G$  has at least one cycle. In other words,  $G$  has at least one non-trivial block.

We pick a non-trivial leaf block  $B_1$ . Let  $u_0$  be the vertex of  $B_1$  connecting the other blocks in  $G$  and the face containing  $u_0$  be  $F_0$  (if there is only one non-trivial block  $B_1$ , then we pick any leaf edge  $v_0u_0$  in a cycle of  $B_1$ , where  $v_0$  is the 1-vertex). We may assume  $B_1$  has at least two faces. Otherwise, let  $u_0u_1 \dots u_k$  be the boundary cycle of  $F_0$ , where  $k \geq 2$ , and  $N(u_0) = \{u_1, u_k, v_0\}$  and  $N(v_0) = \{u_0, v'_0, v''_0\}$ . Since  $G$  has no 2-vertices, there is a leaf edge  $u_iu'_i$  hanging on each of  $u_i$ , where  $1 \leq i \leq k$ . We delete all  $u_i, u'_i$ ,  $1 \leq i \leq k$ , to obtain  $G'$ . By the minimality of  $G$ ,  $G'$  has a good coloring  $f$ . **Case (i):**  $f(u_0v_0) \in \{2_a, 2_b\}$ , say  $f(u_0v_0) = 2_a$ . If  $k$  is odd, then we color  $u_0u_1, \dots, u_ku_0$  with  $1_a, 1_b, 1_a, \dots, 1_b$ , and the leaf edges  $u_1u'_1, \dots, u_ku'_k$  with  $2_b, 2_a, \dots, 2_b$ . If  $k = 2$ , then we color  $u_0u_1, u_1u_2, u_2u_0, u_1u'_1, u_2u'_2$  with  $1_a, 2_b, 1_b, 1_b, 1_a$ . If  $k$  is even and  $k \geq 4$ , then color  $u_0u_1, u_1u'_1, u_1u_2$  with  $1_a, 1_b, 2_b, u_0u_k, \dots, u_3u_2$  together with  $u_2u'_2$  with  $1_a, 1_b, \dots, 1_a$ , and  $u_3u'_3, \dots, u_ku'_k$  with  $2_a, 2_b, \dots, 2_b$ . **Case (ii):**  $f(u_0v_0) \in \{1_a, 1_b\}$ , say  $f(u_0v_0) = 1_a$ . Then we can color  $u_0u_1$  with  $1_b$  and  $u_0u_k$  with one of  $\{2_a, 2_b, 3\}$ . To see this, if  $\{f(v_0v'_0), f(v_0v''_0)\} \neq \{2_a, 2_b\}$ , then we are done. If  $\{f(v_0v'_0), f(v_0v''_0)\} = \{2_a, 2_b\}$ , then each of  $v'_0, v''_0$  sees  $1_a, 1_b$  and thus we can color  $u_0u_k$  with 3. In case  $k$  is even, we color the edges  $u_1u_2$  until  $u_{k-1}u_k$  together with  $u_ku'_k$  with  $1_a, 1_b, \dots, 1_a, 1_b$ , and  $u_1u'_1, \dots, u_{k-1}u'_{k-1}$  with  $x, y, \dots, x$ , where  $x \in \{2_a, 2_b\} - f(u_0u_k)$  and  $y \in \{2_a, 2_b\} - x$ . In case  $k = 3$ , we color  $u_2u'_2, u_2u_3, u_3u'_3, u_3u_4, u_4u'_4$  with  $1_a, x, 1_a, 1_b, 1_a$ , where  $x \in \{2_a, 2_b\} - f(u_0u_k)$ . In case  $k$  is odd and  $k \geq 5$ , we color  $u_1u'_1, u_1u_2, u_2u'_2$  with  $1_a, x, 1_a$ , where  $x \in \{2_a, 2_b\} - f(u_0u_k)$ ,  $u_2u_3$  until  $u_{k-1}u_k$  together with  $u_ku'_k$  with  $1_b, 1_a, \dots, 1_b, 1_a$ , and  $u_3u'_3, \dots, u_{k-1}u'_{k-1}$  with  $y, x, \dots, x$ . **Case (iii):**  $f(u_0v_0) = 3$ . We color  $u_0u_1, u_1u'_1, u_ku_0$  with  $1_a, 1_b, 1_b$ . In case  $k = 2$ , we color  $u_1u_2, u_2u'_2$  with  $2_a, 1_a$ . In case  $k \geq 3$ , we color  $u_1u_2$  with  $2_a, u_{k-1}u_k$  until  $u_2u_3$  together with  $u_2u'_2$  with  $1_a, 1_b, \dots$ , and  $u_3u'_3$  until  $u_ku'_k$  with  $2_b, 2_a, \dots$ . This is a contradiction.

We first show every pendant face (except  $F_0$ ) in  $B_1$  is a triangle.

**Lemma 3.6.** *Let  $F_1$  be a pendant face in  $B_1$  and  $F_1 \neq F_0$ . Then  $F_1$  is a 3-face.*

**Proof.** Suppose  $F_1$  is a  $k$ -face, where  $k \geq 4$ . Let the only face adjacent to  $F_1$  be  $F_2$  and the boundary cycle of  $F_1$  be  $v_1 \dots v_k$  with  $V(F_1) \cap V(F_2) = \{v_1, v_k\}$ . Since there are no 2-vertices, each  $v_i$  has a leaf neighbour  $v'_i$ ,  $2 \leq i \leq k-1$ . Let  $N(v_1) = \{u_1, v_2, v_k\}$  and  $N(v_k) = \{u_k, v_1, v_{k-1}\}$ . We delete all  $v_i, v'_i$ ,  $2 \leq i \leq k-1$ , and add a vertex  $v, v'$  with edges  $vv_1, vv_k, vv'$  to obtain a graph  $G'$ . By the minimality of  $G$ ,  $G'$  has a good coloring  $f$ .

**Case 1:** Color 3 is not used on  $u_1v_1, v_1v_k, v_ku_k$ .

**Case 1.1:** Colors  $2_a, 2_b$  are not used on  $u_1v_1, v_1v_k, v_ku_k$ . Say  $f(u_1v_1), f(v_1v_k), f(v_ku_k) = \{1_a, 1_b, 1_a\}$ . By symmetry, we may assume either  $f(vv_1), f(vv_k) = 2_a, 2_b$  or  $2_a, 3$ . In case  $f(vv_1), f(vv_k) = 2_a, 2_b$ , then we color  $v_2v'_2, v_1v_2, v_{k-1}v_k$  with  $1_b, 2_a, 2_b, v_2v_3$  until  $v_{k-2}v_{k-1}$  together with  $v_{k-1}v'_{k-1}$  with  $1_a, 1_b, \dots$ . Note that if  $k = 4$  then we already completed the extension. If  $k$  is even and  $k \geq 6$ , then we color  $v_3v'_3$  until  $v_{k-2}v'_{k-2}$  with  $2_b, 2_a, \dots, 2_b, 2_a$ . If  $k$  is odd, then we know  $k \geq 5$  and color  $v_3v'_3$  with 3, and (if  $k \geq 7$ )  $v_{k-2}v'_{k-2}$  until  $v_4v'_4$  with  $2_a, 2_b, \dots, 2_a, 2_b$ .

**Case 1.2:** Colors  $2_a, 2_b$  are used on  $u_1v_1, v_1v_k, v_ku_k$ . Then  $2_a, 2_b$  can be used either once or twice on  $u_1v_1, v_1v_k, v_ku_k$ .

**Case 1.2.1:** Colors  $2_a, 2_b$  are used once on  $u_1v_1, v_1v_k, v_ku_k$ . By symmetry,  $u_1v_1, v_1v_k, v_ku_k$  are colored with either  $1_a, 2_a, 1_a$ , or  $1_a, 2_a, 1_b$ , or  $1_a, 1_b, 2_a$ . In the former case, we can always recolor  $v_1v_k$  with  $1_b$  (for all possibilities of  $f(vv_1), f(vv_k), f(vv')$ ), which was solved in **Case 1.1**. In the middle case, we can assume  $f(vv_1), f(vv_k), f(vv')$  are colored with  $1_b, 1_a, 2_b$  (if not, then recolor it to this coloring). We color  $v_1v_2, v_{k-1}v_k$  with  $1_b, 1_a$ . If  $k$  is odd, then

$k \geq 5$  and color  $v_2v_3$  until  $v_{k-2}v_{k-1}$  with  $1_a, 1_b, \dots, 1_a, 1_b$ , and  $v_2v'_2$  until  $v_{k-1}v'_{k-1}$  with  $2_b, 2_a, \dots, 2_a, 2_b$ . If  $k$  is even, then color  $v_2v'_2, v_2v_3, v_3v'_3$  with  $1_a, 2_b, 1_b$ , and (if  $k \geq 6$ )  $v_3v_4$  until  $v_{k-2}v_{k-1}$  with  $1_a, 1_b, \dots, 1_a, 1_b$  and  $v_4v'_4$  until  $v_{k-1}v'_{k-1}$  with  $2_a, 2_b, \dots, 2_a, 2_b$ . In the latter case, we know by symmetry that  $f(vv_1), f(vv_k), f(vv')$  are colored with  $2_b, 1_a, 1_b$  or  $3, 1_a, 1_b$ . We claim  $3, 1_a, 1_b$  is impossible, since otherwise we color  $v_{k-1}v_k$  until  $v_2v_3$  together with  $v_2v'_2$  with  $1_a, 1_b, \dots$  and color  $v_{k-1}v'_{k-1}$  until  $v_3v'_3$  with  $2_b, 2_a, \dots$ . Thus,  $f(vv_1), f(vv_k), f(vv') = 2_b, 1_a, 1_b$ . We color  $v_1v_2, v_{k-1}v_k$  with  $2_b, 1_a$ . If  $k = 4$ , then we know  $u_k$  must see 3, since otherwise we color  $v_2v'_2, v_2v_3, v_3v'_3$  with  $1_a, 1_b, 3$ . We also know  $u_k$  must see  $1_a$  since otherwise we switch the colors of  $v_{k-1}v_k$  and  $v_ku_k$  and color  $v_2v'_2, v_2v_3, v_3v'_3$  with  $1_a, 1_b, 1_a$ . Therefore, we switch the colors of  $v_1v_2$  and  $v_1v_k$ , recolor  $v_ku_k$  with  $1_b$ , and color  $v_2v'_2, v_2v_3, v_3v'_3$  with  $1_a, 2_a, 1_b$ . If  $k \geq 5$ , then color  $v_3v'_3$  with 3,  $v_{k-1}v_k$  until  $v_2v_3$  together with  $v_2v'_2$  with  $1_a, 1_b, \dots$ , and  $v_{k-1}v'_{k-1}$  until  $v_4v'_4$  with  $2_b, 2_a, \dots$ .

**Case 1.2.2:** Colors  $2_a, 2_b$  are used twice on  $u_1v_1, v_1v_k, v_ku_k$ . By symmetry,  $u_1v_1, v_1v_k, v_ku_k$  are colored with either  $1_a, 2_a, 2_b$  or  $2_a, 1_a, 2_b$ . In the former case, we can always recolor  $v_1v_k$  to  $1_b$  (for all possibilities of  $f(vv_1), f(vv_k), f(vv')$ ), which was solved in **Case 1.2.1**. In the latter case, we can assume  $f(vv_1), f(vv_k), f(vv') = 1_b, 3, 1_a$  by symmetry. We color  $v_{k-1}v_k$  with 3,  $v_1v_2$  until  $v_{k-2}v_{k-1}$  together with  $v_{k-1}v'_{k-1}$  with  $1_b, 1_a, \dots$ , and  $v_2v'_2$  until  $v_{k-2}v'_{k-2}$  with  $2_b, 2_a, \dots$ .

**Case 2:** Color 3 is used on  $u_1v_1, v_1v_k, v_ku_k$ . Then colors  $2_a, 2_b$  can be used twice, once, or zero times on  $u_1v_1, v_1v_k$ , and  $v_ku_k$ . Note that if colors  $2_a, 2_b$  are used twice, then by symmetry  $u_1v_1, v_1v_k, v_ku_k$  are colored with  $2_a, 3, 2_b$  or  $2_a, 2_b, 3$ , both of which are impossible since we only have two available colors  $1_a, 1_b$  for  $vv_1, vv_k, vv'$ .

**Case 2.1:** Colors  $2_a, 2_b$  are not used on  $u_1v_1, v_1v_k, v_ku_k$ . Then  $f(u_1v_1), f(v_1v_k), f(v_ku_k)$  can be  $1_a, 3, 1_a$ , or  $1_a, 3, 1_b$ , or  $3, 1_a, 1_b$  up to symmetry. If it is  $1_a, 3, 1_a$ , then we can always recolor  $v_1v_k$  with  $1_b$  (for all possibilities of  $f(vv_1), f(vv_k), f(vv')$ ), which was solved in **Case 1**. Therefore,  $f(u_1v_1), f(v_1v_k), f(v_ku_k)$  is  $1_a, 3, 1_b$ , or  $3, 1_a, 1_b$ . In the former case, we can always recolor  $f(vv_1), f(vv_k), f(vv')$  to  $1_b, 1_a, 2_a$ . We color  $v_{k-1}v_k, v_{k-1}v'_{k-1}, v_{k-2}v_{k-1}$  with  $1_a, 1_b, 2_a$ ,  $v_1v_2$  until  $v_{k-3}v_{k-2}$  together with  $v_{k-2}v'_{k-2}$  with  $1_b, 1_a, \dots$ , and (if  $k \geq 5$ )  $v_{k-3}v'_{k-3}$  until  $v_1v'_1$  with  $2_b, 2_a, \dots$ . In the latter case, we color  $v_{k-1}v_k$  with  $2_a$ ,  $v_1v_2$  until  $v_{k-2}v_{k-1}$  together with  $v_{k-1}v'_{k-1}$  with  $1_b, 1_a, \dots$ , and  $v_{k-2}v'_{k-2}$  until  $v_1v'_1$  with  $2_b, 2_a, \dots$ .

**Case 2.2:** Colors  $2_a, 2_b$  are used once on  $u_1v_1, v_1v_k, v_ku_k$ . Then  $f(u_1v_1), f(v_1v_k), f(v_ku_k)$  can be  $1_a, 3, 2_a$ , or  $1_a, 2_a, 3$ , or  $2_a, 1_a, 3$  up to symmetry. If it is  $1_a, 3, 2_a$  or  $1_a, 2_a, 3$ , then we can always recolor  $v_1v_k$  with  $1_b$  (for all possibilities of  $f(vv_1), f(vv_k), f(vv')$ ), which was solved in **Case 1** or **Case 2.1**. Therefore,  $f(u_1v_1), f(v_1v_k), f(v_ku_k)$  are colored with  $2_a, 1_a, 3$  and  $f(vv_1), f(vv_k), f(vv')$  can only be colored with  $1_b, 2_b, 1_a$  or  $2_b, 1_b, 1_a$ . In the former case, we color  $v_1v_2, v_1v'_1, v_2v_3$  with  $1_b, 1_a, 2_b$ ,  $v_{k-1}v_k$  until  $v_3v_4$  together with  $v_3v'_3$  with  $1_b, 1_a, \dots$ , and (if  $k \geq 5$ )  $v_4v'_4$  until  $v_{k-1}v'_{k-1}$  with  $2_a, 2_b, \dots$ . In the latter case, we color  $v_1v_2$  with  $2_b$ ,  $v_{k-1}v_k$  until  $v_2v_3$  together with  $v_2v'_2$  with  $1_b, 1_a, \dots$ , and  $v_3v'_3$  until  $v_{k-1}v'_{k-1}$  with  $2_a, 2_b, \dots$ .  $\square$

Let  $P = F_0F_\ell \dots F_2F_1$  be a longest path in the weak dual of  $B_1$  starting at  $F_0$ . We first show  $\ell \geq 2$ .

**Lemma 3.7.**  $\ell \geq 2$ .

**Proof.** Suppose not, i.e.,  $\ell = 1$  ( $F_2 = F_0$ ) and  $F_2$  has boundary cycle  $u_0u_1 \dots u_k$ ,  $k \geq 2$ . By Lemma 3.6, every pendant face except  $F_2$  is a 3-face. Since each of  $u_i$  is a 3-vertex, let the other neighbour not in  $F_2$  to be  $u'_i$ ,  $1 \leq i \leq k$ . If there is a 3-face sitting on top of  $u_i, u_{i+1}$ , then  $u'_i = u'_{i+1}$  and let the leaf attached on it be called  $u''_i$ . We delete  $u_1, u'_1, \dots, u_k, u'_k$  and all  $u''_i$  (if exists) to obtain a graph  $G'$ . By the minimality of  $G$ ,  $G'$  has a good coloring  $f$ . By symmetry, we may assume  $f(v_0u_0)$  is either  $1_a, 2_a$ , or 3. Note that when  $k = 3$  we may assume the only pendant face is on top of  $u_1, u_2$ .



Let  $F$  be a pendant face adjacent to  $F_2$  with  $V(F) \cap V(F_2) = \{u_i, u_{i+1}\}$ ,  $1 \leq i \leq k-1$ . We may now replace  $F$  with a 4-face  $u_i u'_i u'_{i+1} u_{i+1} u_i$ . Furthermore, we may add vertices  $u'_i, w_i$  with edges  $u'_i u'_i, u'_i u'_{i+1}, u'_i w_i$  to form an HC graph  $H_i$ . In this way, we are coloring a larger graph than  $G'$  and can use the proof in the future. At the same time, we can always use the colors of  $u_i u'_i, u_{i+1} u'_{i+1}, u'_i u'_{i+1}$  of  $H_i$  to color the edges  $u_i u'_i, u_{i+1} u'_{i+1}, u'_i u'_{i+1}$  of  $G$ .

**Case 1:**  $f(v_0 u_0) = 1_a$ . We can always color  $u_0 u_1$  with  $1_b$ . We can color  $u_0 u_k$  with  $2_a$  or  $2_b$  unless  $\{f(v_0 v'_0), f(v_0 v''_0)\} = \{2_a, 2_b\}$ . In this case, each of  $v'_0$  and  $v''_0$  must see  $1_a$  and  $1_b$ , and hence we can color  $u_0 u_k$  with 3.

**Case 1.1:** We can color  $u_0 u_k$  with  $2_a$ . In case  $k = 3$ , we may assume there is an HC graph  $H_1$  on top of  $u_1, u_2$ . We color  $u_1 u_2, u_2 u_3, u_3 u'_3$  with  $2_b, 1_a, 1_b$ , and  $H_1$  with Type I coloring. Otherwise,  $k \neq 3$ . We color  $u_1 u_2, \dots, u_{k-1} u_k$  together with  $u_k u'_k$  with  $1_a, 1_b, \dots$ , (if  $k \geq 4$ )  $u_1 u'_1, \dots, u_{k-2} u'_{k-2}$  with  $2_b, 2_a, \dots$ . If there is an HC graph  $H_{k-2}$  on top of  $u_{k-2}, u_{k-1}$ , then we recolor  $u_{k-1} u_k$  with  $2_b$ ,  $H_{k-2}$  with Type IV coloring, and other HC graphs with Type II coloring. If there is no HC graph on top of  $u_{k-2}, u_{k-1}$ , color  $u_{k-1} u'_{k-1}$  with 3, and all HC graphs with Type II coloring (except use Type IV coloring on the HC graph on top of  $u_{k-1}, u_k$  if it exists).

**Case 1.2:** We can color  $u_0 u_k$  with 3. We color  $u_1 u_2, \dots, u_{k-1} u_k$  together with  $u_k u'_k$  with  $1_a, 1_b, \dots, u_1 u'_1, \dots, u_{k-1} u'_{k-1}$  with  $2_a, 2_b, \dots$ . If there is an HC graph  $H_{k-1}$  on top of  $u_{k-1}, u_k$ , then we switch the colors of  $u_{k-1} u_k$  and  $u_{k-1} u'_{k-1}$  and can color  $H_{k-1}$  with Type V coloring. We use type II coloring for other HC graphs. Note that if  $k = 3$  we assume by symmetry that the HC graph is on top of  $u_2, u_3$  and can use the aforementioned coloring procedure.

**Case 2:**  $f(v_0 u_0) = 2_a$  or 3. We color  $u_0 u_1, u_0 u_k$  with  $1_a, 1_b$ . If  $k$  is odd, color  $u_1 u_2, \dots, u_{k-1} u_k$  with  $1_b, 1_a, \dots, 1_a, u_1 u'_1, \dots, u_k u'_k$  with  $2_b, 2_a, \dots, 2_b$ , all HC graphs with Type II coloring. If  $k$  is even, then color  $u_1 u'_1, u_1 u_2, u_2 u'_2$  with  $1_b, 2_b, 1_a$ , and (if  $k \geq 4$ )  $u_2 u_3, \dots, u_{k-1} u_k$  with  $1_b, 1_a, \dots, 1_a, u_3 u'_3, \dots, u_k u'_k$  with  $2_a, 2_b, \dots, 2_b$ . If there is an HC graph  $H_1$  ( $H_2$ ) on top of  $u_1, u_2$  ( $u_2, u_3$ ), then use Type I (Type III) coloring. We use type II coloring for other HC graphs.  $\square$

Then we show  $F_2$  must be a 4-face when  $\ell \geq 2$ .

**Lemma 3.8.**  $F_2$  is a 4-face.

**Proof.** By Lemma 3.7,  $\ell \geq 2$ . Suppose  $F_2$  is a  $k$ -face, where  $k \geq 5$ . Let the boundary cycle of  $F_2$  be  $v_1 \dots v_k$  with  $V(F_3) \cap V(F_2) = \{v_1, v_k\}$ . We delete  $v_2, \dots, v_{k-1}$  and all pendant faces hang on  $F_2$  with all their leaves, and add vertices  $z, z_1, z_2, z_k$  with edges  $z_1 v_1, z_k v_k, z_1 z_k, z_1 z_2, z_2 z_k, z_2 z$  (HC graph  $H$ ) to obtain a graph  $G'$ . By the minimality of  $G$ ,  $G'$  has a good coloring  $f$ . We extend  $f$  to  $G'$ . Note that each  $v_i$  with no pendant faces on top has a leaf neighbour  $v'_i$ ,  $2 \leq i \leq k-1$ . Let  $F$  be a pendant face adjacent to  $F_2$  with  $V(F) \cap V(F_2) = \{v_i, v_{i+1}\}$ ,  $2 \leq i \leq k-1$ . We may now replace  $F$  with a 4-face  $v_i v'_i v'_{i+1} v_{i+1} v_i$  and add vertices  $v''_i, w_i$  with edges  $v''_i v'_i, v''_i v'_{i+1}, v''_i w_i$  to form an HC graph  $H_i$ . In this way, we are coloring a larger graph than  $G'$  and can use the proof in the future. At the same time, we can always use the colors of  $v_i v'_i, v_{i+1} v'_{i+1}, v''_i v'_{i+1}$  of  $H_i$  to color the edges  $v_i v'_i, v_{i+1} v'_{i+1}, v''_i v'_{i+1}$  of  $G$ . Let  $N(v_1) = \{u_1, v_2, v_k\}$  and  $N(v_k) = \{u_k, v_1, v_{k-1}\}$ .

**Case 1:** The HC graph  $H$  uses type I coloring, i.e.,  $u_1 v_1, v_1 v_k, v_k u_k, v_1 z_1, v_k z_k, z_1 z_k, z_1 z_2, z_2 z_k, z_2 z$  are colored with  $1_a, 2_a, 1_b, 1_b, 1_a, 2_b, 1_a, 1_b, 2_a$ . If  $k$  is odd, then we color  $v_1 v_2$  until  $v_{k-1} v_k$  with  $1_b, 1_a, \dots, 1_b, 1_a, v_2 v'_2$  until  $v_{k-1} v'_{k-1}$  with  $2_b, 2_a, \dots, 2_b$ . If there is an HC graph on top of  $v_i, v_{i+1}$ ,  $2 \leq i \leq k-2$ , then we use Type II coloring to complete the extension. Let  $j$ ,  $2 \leq j \leq k-2$ , be the smallest index such that there is an HC graph  $H_j$  on top of  $v_j v_{j+1}$ . If  $k$  is even, then  $k \geq 6$ , we color  $v_1 v_2, \dots, v_{j-1} v_j, v_{j+1} v_{j+2}, \dots, v_{k-1} v_k$  with  $1_b, 1_a, \dots, 1_b, 1_a, v_2 v_3, v_4 v'_4, \dots, v_{k-1} v'_{k-1}$  with  $2_b, 2_a, \dots, 2_b$  when  $j = 2$  and  $v_2 v'_2, \dots, v_{j-1} v'_{j-1}, v_j v_{j+1}, v_{j+2} v'_{j+2}, \dots, v_{k-1} v'_{k-1}$  with  $2_b, 2_a, \dots, 2_b$  when  $3 \leq j \leq k-3$  and

$v_2v'_2, \dots, v_{j-1}v'_{j-1}, v_jv_{j+1}$  with  $2_b, 2_a, \dots, 2_b$  when  $j = k - 2$ , and color  $H_j$  with Type I coloring, and the remaining HC graphs with Type II coloring.

**Case 2:**  $H$  uses type II coloring, i.e.,  $u_1v_1, v_1v_k, v_kv_k, v_1z_1, v_kz_k, z_1z_k, z_1z_2, z_2z_k, z_2z$  are colored with  $1_a, 1_b, 1_a, 2_a, 2_b, 1_b, 1_a, 3, 1_b$ . We color  $v_1v_2, v_{k-1}v_k$  with  $2_a, 2_b$ . If  $k = 5$ , then we may assume there is an HC graph  $H_2$  on top of  $v_2, v_3$ , color  $v_2v_3, v_3v_4, v_4v'_4$  with  $1_b, 1_a, 1_b$ , and  $H_2$  with type IV coloring. If  $k \geq 6$  and we color  $v_2v'_2, v_2v_3, \dots, v_{k-2}v_{k-1}$  together with  $v_{k-1}v'_{k-1}$  with  $1_a, 1_b, \dots$ . When there is no HC graph on top of  $v_3, v_4$ , we color  $v_3v'_3$  with 3 and  $v_{k-2}v'_{k-2}, \dots, v_4v'_4$  with  $2_a, 2_b, \dots$ . We use type IV coloring if there is an HC graph on  $v_2, v_3$ . When there is an HC graph  $H_3$  on top of  $v_3, v_4$ , we color  $v_3v'_3, v_4v'_4$  with  $1_b, 3$ , recolor  $v_2v_3$  with  $2_b$ , and (if  $k \geq 7$ ) color  $v_{k-2}v'_{k-2}, \dots, v_5v'_5$  with  $2_a, 2_b, \dots$ , and use type IV coloring on  $H_3$ . We use Type III coloring if there is an HC graph on  $v_{k-2}, v_{k-1}$ . Since at most one of  $v_i v'_i$  uses color 3, we use Type II coloring for other HC graphs in the way that all pairs of color 3s are at distance at least 4.

**Case 3:**  $H$  uses type III coloring, i.e.,  $u_1v_1, v_1v_k, v_kv_k, v_1z_1, v_kz_k, z_1z_k, z_1z_2, z_2z_k, z_2z$  are colored with  $2_a, 1_a, 1_b, 1_b, 2_b, 1_a, 3, 1_b, 1_a$ . We color  $v_1v_2, v_{k-1}v_k$  with  $1_b, 2_b$ . If  $k$  is odd, we color  $v_2v_3, \dots, v_{k-2}v_{k-1}$  together with  $v_{k-1}v'_{k-1}$  with  $1_a, 1_b, \dots, 1_a, v_2v'_2, \dots, v_{k-2}v'_{k-2}$  with  $2_b, 2_a, \dots, 2_a$ . We use Type III coloring for the HC graph on  $v_{k-2}, v_{k-1}$  (if there is one) and Type II coloring on other HC graphs. If  $k$  is even, then  $k \geq 6$ , we color  $v_2v'_2, v_2v_3, v_3v'_3$  with  $1_a, 2_b, 1_b, v_3v_4, \dots, v_{k-2}v_{k-1}$  together with  $v_{k-1}v'_{k-1}$  with  $1_a, 1_b, \dots, 1_a, v_4v'_4, \dots, v_{k-2}v'_{k-2}$  with  $2_a, 2_b, \dots, 2_a$ . We use Type I coloring for the HC graph on  $v_2, v_3$  (if there is one), Type III coloring for the HC graph on  $v_{k-2}, v_{k-1}$  (if there is one), and Type II coloring for other HC graphs.

**Case 4:**  $H$  uses type IV coloring, i.e.,  $u_1v_1, v_1v_k, v_kv_k, v_1z_1, v_kz_k, z_1z_k, z_1z_2, z_2z_k, z_2z$  are colored with  $2_a, 1_a, 1_b, 1_b, 3, 2_b, 1_a, 1_b, 2_a$ . We color  $v_1v_2, v_{k-1}v_k$  with  $1_b, 3$ . We color  $v_2v_3, \dots, v_{k-2}v_{k-1}$  together with  $v_{k-1}v'_{k-1}$  with  $1_a, 1_b, \dots, v_2v'_2, \dots, v_{k-2}v'_{k-2}$  with  $2_b, 2_a, \dots$ . If there is an HC graph  $H_{k-2}$  on top of  $v_{k-2}, v_{k-1}$ , we switch the colors of  $v_{k-2}v_{k-1}$  and  $v_{k-2}v'_{k-2}$ , and use Type V coloring on  $H_{k-2}$ . We use Type II coloring for other HC graphs in the way that all pairs of color 3s are at distance at least 4.

**Case 5:**  $H$  uses type V coloring, i.e.,  $u_1v_1, v_1v_k, v_kv_k, v_1z_1, v_kz_k, z_1z_k, z_1z_2, z_2z_k, z_2z$  are colored with  $3, 2_a, 1_a, 1_a, 1_b, 2_b, 1_b, 1_a, 2_a$ . We color  $v_{k-1}v_k$  with  $1_b$ . If  $k$  is odd, we color  $v_{k-2}v_{k-1}, \dots, v_1v_2$  with  $1_a, 1_b, \dots, 1_a, v_2v'_2, \dots, v_{k-1}v'_{k-1}$  with  $2_b, 2_a, \dots, 2_b$ . We color all HC graphs with Type II coloring. If  $k$  is even, we color  $v_{k-1}v'_{k-1}, v_{k-2}v_{k-1}, v_{k-2}v'_{k-2}$  with  $1_a, 2_b, 1_b, v_{k-3}v_{k-2}, \dots, v_1v_2$  with  $1_a, 1_b, \dots, 1_a, v_2v'_2, \dots, v_{k-3}v'_{k-3}$  with  $2_b, 2_a, \dots, 2_a$ . If there is an HC graph  $H_{k-2}$  ( $H_{k-3}$ ) on top of  $v_{k-2}, v_{k-1}$  ( $v_{k-3}, v_{k-2}$ ), then we color  $H_{k-2}$  ( $H_{k-3}$ ) with Type I (Type III) coloring. We use Type II coloring for other HC graphs.  $\square$

Now, we complete the proof. By Lemma 3.7,  $\ell \geq 2$ . We split the proof into two cases.

**Case i:**  $\ell = 2$ . By Lemma 3.8,  $B_1$  can be described as  $F_0$  with a few leaf edges, 3-faces with a leaf edge, and HC graphs attached on it. We can use the same argument used in the proof of Lemma 3.7, since we treated every 3-face with a leaf edge as an HC graph in the coloring procedure. In case  $B_1$  is the only non-trivial block and  $F_0$  is a 3-face, by Lemma 3.6 and 3.8,  $F_2$  is a 4-face and  $F_1$  is a 3-face. We color both HC graphs with Type I coloring.

**Case ii:**  $\ell \geq 3$ . Let  $V(F_3) \cap V(F_4) = \{v_1, v_k\}$ . We delete  $V(F_3) - \{v_1, v_k\}$ , all leaf edges, all 3-faces with a leaf edge, all HC graphs attached on  $F_3$ , and add vertices  $z, z_1, z_2, z_k$  with edges  $z_1v_1, z_kv_k, z_1z_k, z_1z_2, z_2z_k, z_2z$  (HC graph) to obtain a graph  $G'$ . By the minimality of  $G$ ,  $G'$  has a good coloring  $f$ . We can use the argument used in the proof of Lemma 3.8, since we treated every 3-face with a leaf edge as an HC graph in the color-extending procedure.  $\square$

### 3.2 $(1^2, 2^2, k'_2)$ -packing edge-coloring of 2-connected subcubic outerplanar graphs

We provide a 2-connected subcubic outerplanar graph that is not  $(1^2, 2^2, 12)$ -colorable, showing  $k'_2 \leq 11$ .

**Example 3.9.** Let  $G_2$  and  $G_3$  be the graph shown in Fig. 9. We show  $G_3$  is a 2-connected subcubic outerplanar graph that is not  $(1^2, 2^2, 12)$ -packing edge-colorable.

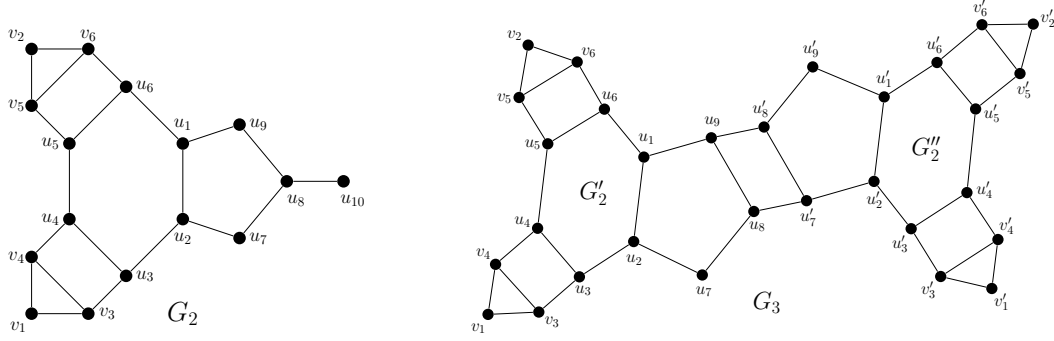

Figure 9: A 2-connected subcubic outerplanar graph that is not  $(1^2, 2^2, 12)$ -packing edge-colorable.

**Proof.** We first show  $G_2$  has no  $(1^2, 2^2)$ -coloring. Suppose  $G_2$  has a  $(1^2, 2^2)$ -coloring  $f$ . By Claim 3.2,  $G_0$  in Example 3.1 has only two  $(1^2, 2^2)$ -coloring up to symmetry and the two copies of  $G_0$  in  $G_2$  must both be of Type II. We may assume  $f(u_2u_3) = 1_a, f(u_3u_4) = 2_a, f(u_4u_5) = 1_b, f(u_5u_6) = 2_b, f(u_1u_6) = 1_a$ . Therefore,  $f(u_1u_2) = 1_b, f(u_1u_9) = 2_a, f(u_2u_7) = 2_b$  and  $\{f(u_8u_9), f(u_7u_8)\} = \{1_a, 1_b\}$ . However, we cannot color  $u_8u_{10}$ , which is a contradiction.

Suppose  $G_3$  has a  $(1^2, 2^2, 12)$ -coloring. Note that  $G_3$  has two disjoint copies of  $G_2$ , i.e.,  $G'_2$  and  $G''_2$  in Fig. 9. Therefore, each of  $G'_2$  and  $G''_2$  must use color 12 at least once. However, the longest possible distance from an edge in  $G'_2$  to  $G''_2$  is 12 (realized by  $v_1v_4$  and  $v'_2v'_5$ ), which is a contradiction.  $\square$

## 4 Open Problems

We have shown in this paper that  $3 \leq k_1 \leq 6, k'_1 = 2, 3 \leq k_2 \leq 4$ , and  $3 \leq k'_2 \leq 11$ . We have a proof showing  $k'_2 \geq 4$ . However, we decided to not include it in this paper since the argument is similar to the proof of Theorem 3.2. We tend to believe that  $k_2 = 4$  and applying stronger conditions to the  $(1^2, 2^2, 4)$ -coloring may lead to a proof. It would be nice if the remaining three numbers  $k_1, k_2, k'_2$  can be determined exactly. We post those questions as open problems.

- What is the largest  $k_1$  such that every subcubic outerplanar graph is  $(1, 2^4, k_1)$ -colorable?
- What is the largest  $k_2$  such that every subcubic outerplanar graph is  $(1^2, 2^2, k_2)$ -colorable?
- What is the largest  $k'_2$  such that every 2-connected subcubic outerplanar graph is  $(1, 2^4, k'_2)$ -colorable?

## References

- [1] L.D. Andersen, The strong chromatic index of a cubic graph is at most 10. *Discrete Math.* 108 (1992), 231–252.
- [2] J. Balogh, A. Kostochka, X. Liu, Packing chromatic number of cubic graphs, *Discrete Math.* 341 (2018), 474–483.

- [3] B. Brešar, S. Klavžar, D.F. Rall, K. Wash, Packing chromatic number under local changes in a graph, *Discrete Math.* 340 (2017), 1110–1115.
- [4] L. Chen, K. Deng, G. Yu, X. Zhou, Strong edge-coloring for planar graphs with large girth, *Discrete Math.*, 342 (2) (2019), 339–343.
- [5] I. Choi, J. Kim, A. Kostochka, A. Raspaud, Strong edge-coloring of sparse graphs with large maximum degree, *Eur. J. Comb.* 67 (2016), 21–39.
- [6] P. Erdős and J. Nešetřil, Irregularities of partitions, Ed. G. Halász and VT Sós (1989), 162–163.
- [7] J. L. Fouquet and J. L. Jolivet, Strong edge-colorings of graphs and applications to multi-k-gons, *Ars Combin.* 16A (1983), 141–150.
- [8] J. Fiala, S. Klavžar, B. Lidický, The packing chromatic number of infinite product graphs, *European J. Combin.* 30 (2009), 1101–1113.
- [9] A. Frieze, M. Krivelevich, B. Sudakov, The strong chromatic index of random graphs, *SIAM J. Discrete Math.* 19 (2005), 719–727.
- [10] N. Gastineau and O. Togni, S-packing colorings of cubic graphs, *Discrete Math.* 339 (2016), 2461–2470.
- [11] N. Gastineau and O. Togni, On S-packing edge-colorings of cubic graphs, *Discrete Appl. Math.* 259 (2019), 63–75.
- [12] H. Hocquard, D. Lajou, B. Lužar, Between proper and strong edge-colorings of subcubic graphs, *J. Graph Theory* 101 (4) (2022), 686–716.
- [13] H. Hocquard, P. Ochem, P. Valicov, Strong edge-colouring and induced matchings, *Information Processing Letters*, 113 (2013), 836–843.
- [14] P. Horák, H. Qing, W.T. Trotter, Induced matchings in cubic graphs, *J. Graph Theory*, 17 (2) (1993), 151–160.
- [15] M. Huang, M. Santana, G. Yu, Strong chromatic index of graphs with maximum degree four, *Electron. J. Combin.* 25 (2018), no. 3, #P3.31.
- [16] E. Hurley, R. de Joannis de Verclos, and R. Kang, An improved procedure for colouring graphs of bounded local density, *Advances in Combinatorics* (2022), <https://doi.org/10.19086/aic.2022.7>.
- [17] A. Kostochka, X. Li, W. Ruksasakchai, M. Santana, T. Wang, G. Yu, Strong chromatic index of subcubic planar multigraphs, *Eur. J. Comb.* 51 (2016), 380–397.
- [18] X. Liu, M. Santana, and T. Short, Every subcubic multigraph is  $(1, 2^7)$ -packing edge-colorable, *J. Graph Theory* 104 (4) (2023), 851–885.
- [19] X. Liu and G. Yu, On the  $(1^2, 2^4)$ -packing edge-coloring of subcubic graphs, arXiv:2402.18353.
- [20] B. Lužar, E. Mačajová, M. Škoviera, R. Soták, Strong edge colorings of graphs and the covers of Kneser graphs, *J. Graph Theory* 100 (2022), 686–697.
- [21] M. Molloy and R. Reed, A bound on the strong chromatic index of a graph, *J. Combin. Theory B*, 69 (1997), 103–109.
- [22] V.G. Vizing, On an estimate of the chromatic class of a  $p$ -graph, *Metody Diskret Analiz*, 3 (1964), 25–30.