

Intel[®] SHMEM: GPU-initiated OpenSHMEM using SYCL

Alex Brooks, Philip Marshall, David Ozog, Md. Wasi-ur- Rahman, Lawrence Stewart, Rithwik Tom[§]
Intel Corporation

{alex.brooks, philip.marshall, david.m.ozog, md.rahman, lawrence.stewart, rithwik.tom}@intel.com

Abstract—Modern high-end systems are increasingly becoming heterogeneous, providing users options to use general purpose Graphics Processing Units (GPU) and other accelerators for additional performance. High Performance Computing (HPC) and Artificial Intelligence (AI) applications are often carefully arranged to overlap communications and computation for increased efficiency on such platforms. This has led to efforts to extend popular communication libraries to support GPU awareness and more recently, GPU-initiated operations. In this paper, we present Intel SHMEM, a library that enables users to write programs that are GPU aware, in that API calls support GPU memory, and also support GPU-initiated communication operations by embedding OpenSHMEM style calls within GPU kernels. We also propose thread-collaborative extensions to the OpenSHMEM standard that can enable users to better exploit the strengths of GPUs. Our implementation adapts to choose between direct load/store from GPU and the GPU copy engine based transfer to optimize performance on different configurations.

Index Terms—Distributed Communications, Partitioned Global Address Space (PGAS), GPU, OpenSHMEM

I. INTRODUCTION

OpenSHMEM [27], an open standard first released in 2010, builds on a legacy of distributed "SHared MEMory" (SHMEM) programming, originally introduced in 1993 by Cray Research to transfer data across the Cray T3D machines [2]. OpenSHMEM specifies a portable library-based API for Partitioned Global Address Space (PGAS) programming, which enables low-latency one-sided reads and writes (*get* and *put*), *atomic* operations, and *collective* operations that act on remotely accessible data objects. Version 1.5 of the OpenSHMEM API enables transferring application data and synchronizing across any, all, or a subset (i.e., a *team*) of the application's distributed processing elements (PEs) [28].

While OpenSHMEM has proven itself as an efficient and scalable programming model for CPU-driven HPC; at the time of this writing, OpenSHMEM does not yet include any standardized support for GPUs. However, according to the June 2024 Top500 list [14], nine of the top ten HPC systems include GPU accelerators, that are manufactured by various vendors like Advanced Micro Devices (AMD), Intel Corporation, and

NVIDIA. The total number of GPUs within the top three systems alone surpasses 115,000: Frontier has 37,608 GPUs (4 per node), Aurora has 63,744 (6 per node), and Eagle has 14,400 (8 per node). Furthermore, each GPU device on both the Aurora and Eagle systems actually contains 2 graphics compute tiles (or dies), so the total number of independently usable GPU compute tiles in the top 3 systems approaches 200,000. These advanced and disparate architectures necessitate changes in both OpenSHMEM applications and libraries to support and optimize the execution path involving GPUs.

Since 2020, NVIDIA has supported NVSHMEM [22], [34], which enables OpenSHMEM-like APIs to be called within CUDA kernels to support data transfer across clusters of NVIDIA GPUs [12]. CUDA provides a general purpose parallel computing platform and programming model that exploits the compute engines in NVIDIA GPUs to execute user applications and libraries. Recently, AMD has announced ROCm OpenSHMEM (ROC_SHMEM) [9], [20] for AMD GPUs leveraging a programming model similar to CUDA, known as the Heterogeneous-computing Interface for Portability (HIP) [15]. These solutions have been utilized for several state-of-the-art computational science use-cases; including PETSc's star-forest graph communication layer [35], QUDA's lattice quantum chromodynamics [16], SV-Sim's quantum computer circuit simulation [24], cuFFTMp's large-scale fast Fourier Transforms [7], and Kokkos Remote Spaces [25].

In this paper, we present Intel SHMEM, which supports Intel GPU programming in the System wide Compute Language (SYCL) environment [13]. SYCL is a C++ based portable programming model that enables hardware accelerators from different vendors. The NVSHMEM and ROC_SHMEM solutions similarly enable SHMEM operations on their respective vendor GPUs, but at present they restrict users to their vendor-specific programming environments.

It seems clear that GPUs should support the existing OpenSHMEM APIs, but at present, the three efforts offer slightly divergent extension APIs for the particular needs of massively parallel GPUs. It is not immediately clear which of the extension concepts are inter-operable. We feel that Intel SHMEM, designed to be consistent with a portable programming environment, makes a useful contribution to the expected standardization effort for GPU extensions to OpenSHMEM.

Intel SHMEM is a C++ software library that enables applications to use OpenSHMEM communication APIs with

[§]All authors contributed equally

© 2024 IEEE. Personal use of this material is permitted. Permission from IEEE must be obtained for all other uses, in any current or future media, including reprinting/republishing this material for advertising or promotional purposes, creating new collective works, for resale or redistribution to servers or lists, or reuse of any copyrighted component of this work in other works.

device kernels implemented in SYCL. At the time of this writing, the implementation specifically supports only the Intel® Data Center GPU Max Series. However, because SYCL is a cross-platform abstraction layer supporting multiple vendors’ GPUs [11], the design of Intel SHMEM is well-positioned to target cross-vendor GPU execution in the near future.

Intel SHMEM implements a Partitioned Global Address Space (PGAS) programming model and includes most host-initiated operations in the current OpenSHMEM standard. It also includes new device-initiated operations callable directly from GPU kernels. The core set of features that Intel SHMEM provides are:

- Device and host API support for OpenSHMEM 1.5 compliant point-to-point Remote Memory Access (RMA), Atomic Memory Operations (AMO), signaling, memory ordering, and synchronization operations
- Device and host API support for collective operations aligned with the OpenSHMEM 1.5 teams API
- Device API support for SYCL work-group and sub-group level extensions for RMA, signaling, collective, memory ordering, and synchronization operations
- A complete set of C++ function templates that supersede the C11 Generic routines in the current OpenSHMEM specification

In the sections below, we describe implementation details and trade-offs regarding these features and how they optimize for runtime performance. The design and implementation of Intel SHMEM are described in the context of the Aurora supercomputer [1] architecture including changes needed for efficient interactions between CPU and GPU components. We finally present performance evaluations using RMA and collective operation micro-benchmarks that quantify throughput and latency versus critical parameters such as the message size, the work-group size, and the total number of PEs.

II. BACKGROUND

A. SYCL Programming

SYCL provides a modern generic programming abstraction to enable applications on heterogeneous platforms. In SYCL, application functions are offloaded to the GPU as parallel compute kernels. A parallel kernel which operates on thousands or millions of work-items will be automatically parallelized and vectorized by the SYCL compiler before being deployed to the GPU. The collection of work items are broken into work-groups, that run in parallel, and sub-groups, that are essentially vector lanes within a particular compute thread. A work group, depending on hardware, may consist of 1024 or so parallel work-items, and the overall kernel will be decomposed into multiple work groups that may run in parallel or sequentially depending on the GPU compute resources available.

B. oneAPI Level Zero

oneAPI Level Zero (L0) provides lower layer interfaces for applications and libraries to enable programming on accelerators. The API provided by L0 is intended for explicit controls in accelerator programming that is often desired by higher

level runtime APIs and libraries. It provides the back-end support for many oneAPI libraries and middleware, such as, oneAPI Threading Building Blocks (oneTBB), Intel® oneAPI Collective Communications Library (oneCCL), and so on.

C. OpenSHMEM Memory and Execution Model

OpenSHMEM [27] is a community specification that defines a Partitioned Global Address Space (PGAS) parallel programming model. An OpenSHMEM application is comprised of multiple Processing Elements (PEs) that execute the same program. Each PE is represented by a unique integer value for identification within the range of $0 \dots n_{pes} - 1$, where n_{pes} denotes the total number of PEs. PEs utilize a symmetric data segment and a symmetric heap that can be used for data transfers to and from remote PEs. Each PE may contain different values locally in the memory objects allocated on symmetric memory locations, however, the layout of the symmetric segments is identical at all PEs. This simplifies usage and provides opportunities for optimization in access performance. OpenSHMEM defines a library API that enables asynchronous, one-sided access to symmetric data at all PEs by put and get data transfers, atomic operations, and collective communication primitives.

The current OpenSHMEM memory model is specified with respect to the host memory being used by a C application. This limits the usage of GPU or other accelerator memories as symmetric segments without changes or amendments to the specification. The execution model also needs to be adapted to allow all PEs executing at the same time with a functional mapping of GPU memories being used as symmetric heap by each PE. In SYCL programming model, Unified Shared Memory (USM) allows memory from host, device, and shared - that may necessitate different communication and completion semantics based on the memory type being used by the runtime.

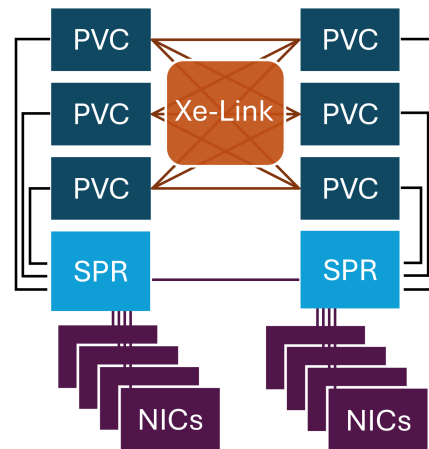

Fig. 1. The Aurora compute node architecture.

III. DESIGN AND IMPLEMENTATION OF INTEL SHMEM

A. Architectural Overview

Intel SHMEM is designed to deliver low latency and high throughput communications for the compute node architecture of the Aurora supercomputer system and other tightly coupled GPU systems like it. A diagram of the Aurora compute node is shown in Figure 1, where 6 Intel® Data Center GPU Max Series devices (code named Ponte Vecchio, or PVC) are fully connected by an Intel® Xe-Link fabric. Figure 1 shows a 6-way GPU topology, but Xe-Link can also be configured with 2-way, 4-way, 6-way, and 8-way topologies, where each GPU links directly to every other GPU. The Aurora compute node also features 2 sockets of Intel® Xeon® CPU Max (formerly Sapphire Rapids, or SPR) CPUs with optional High Bandwidth Memory (HBM) attached, PCIe Gen5 CPU-GPU interfaces, and 8 independent Slingshot 11 Network Interface Card (NIC) devices.

A critical challenge with the distributed programming of such a tightly coupled GPU system is in simultaneously exploiting the high-speed unified fabric among the GPUs, while also supporting off-node data communication. Additionally, SHMEM applications transfer messages with a wide variety of sizes, so the library must make quick and efficient decisions regarding which path among the GPU-GPU fabric, shared host memory, or the network is best for extracting the most performance possible given the message and the network sizes. Also, if the data to be transferred is resident in GPU memory, it is advantageous to use a zero copy design rather than to copy the data to host memory and then synchronize the GPU and host memory upon data arrival. GPU-initiated communication is especially important with the advent of GPU remote direct memory access (RDMA) capabilities, that enable registration of GPU device memory for zero-copy transfers by the NIC, but present a software engineering challenge when the feature is unavailable.

With these considerations in mind we present the software architecture for Intel SHMEM in Figure 2. The top of the figure indicates the application layer, which consists of Intel SHMEM calls within an OpenSHMEM program (or an MPI program if interoperability with the host proxy backend is supported, as defined in OpenSHMEM v1.5 Annex D [27]). Intel SHMEM APIs fall into the two broad categories: (1) device-initiated or (2) host-initiated (as demarcated by the light blue or green boxes in Figure 2, respectively). For internode (scale-out) communication, a host-side proxy thread leverages a standard OpenSHMEM library to hand-off certain GPU-initiated operations, shown in circle (3) within Figure 2. This proxy backend need not be pure OpenSHMEM; for compatibility with MPI, the (4) OSHMPI solution [21] would suffice while offering competitive performance [30]. As expected, all the (5) host-initiated OpenSHMEM routines are available in Intel SHMEM, with the only caveat being the routines are prefixed with `ishmem` as opposed to `shmem`. (Similarly, NVSHMEM prefixes with `nvshmem` and ROC_SHMEM with `roc_shmem`.) While this naming scheme may not be strictly necessary, it at least has the advantage of distinguishing between the various OpenSHMEM-based runtimes that support GPU abstractions (see Section III-F).

B. Xe-Link Capabilities

Within a local group of GPUs, Xe-Links permit individual GPU threads to issue loads, stores, and atomic operations to memory located on other GPUs. Individual loads and stores can provide very low latency. Many threads executing loads and stores simultaneously can greatly increase bandwidth, but at the expense of using compute resources (threads) for communications. To overlap computation and communications, the available hardware copy engines can be utilized, that can run Xe-Links at full speed while the GPU compute cores are busy with computation, but at the cost of incurring a startup latency.

Intel SHMEM, in different operating regimes, uses all these techniques to optimize performance, doing load-store directly, load sharing among GPU threads, and using a cutover strategy to use the hardware copy engines for large transfers and non-blocking operations. The performance effects of these techniques are presented below in Section IV.

C. Inter-node and Intra-node Communication

Much of Intel SHMEM’s implementation work has been to support high-performance GPU-initiated operations for both inter-node (scale-out) and intra-node (scale-up) communication paths, represented by the dark blue boxes at the bottom of Figure 2. For inter-node cases, a host-side proxy thread leverages a standard OpenSHMEM library to hand-off GPU-initiated operations. Intel SHMEM currently depends on the Sandia OpenSHMEM (SOS) [10] for this host proxy thread backend for two core reasons. First, SOS provides robust and portable support for all OpenSHMEM v1.5 host-initiated operations by leveraging the Open Fabrics Interface (OFI) as implemented by `libfabric` [19], [29]. Additionally, SOS has experimental support for a separate symmetric heap residing

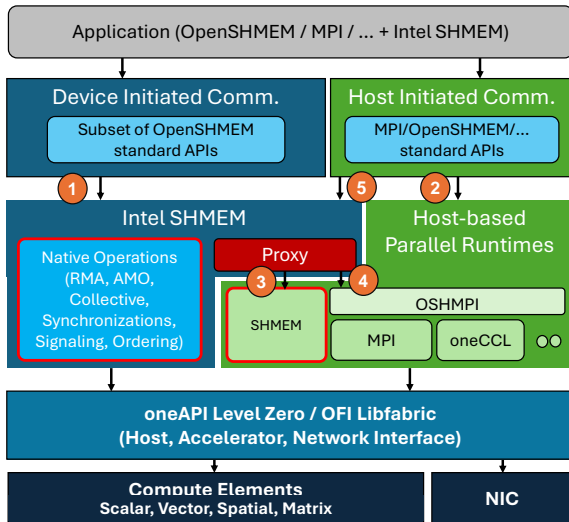

Fig. 2. Overview of Intel SHMEM software architecture

in GPU device memory (see Section III-E). To support RDMA operations on GPU memory, SOS relies on the heterogeneous memory (FI_HMEM) capabilities of suitable `libfabric` providers to support device memory registration across various high performance networking interfaces [23]. For flexibility of usage, Intel SHMEM also provides a choice to use either GPU memory (default) or host-resident Unified Shared Memory (USM) as the OpenSHMEM Symmetric Heap.

For intra-node use-cases, Intel SHMEM can directly leverage the Level Zero inter-process communication (IPC) interfaces without invoking a host proxy operation [6]. The core routine for intra-node transfers is `zeCommandListAppendMemoryCopy`, and Intel SHMEM supports both standard Level Zero command lists and immediate command lists for low latency copy operations. Every Intel SHMEM GPU RMA operation first loads from a stashed array to determine whether the target PE is local. If this value is non-zero, the target PE is local and the loaded value contains an appropriate index into an array of *offsets* between the local symmetric heap base and the destination symmetric heap base.

D. Synchronization with Host

When a GPU thread encounters an Intel SHMEM operation which requires host assistance, it composes a request message and transmits it to the host CPU. If a reply is required, the thread then waits for a completion message. This reverse offload queue uses a novel lock-free ring buffer design. The salient features are:

- Messages are fixed size (64 bytes)
- Allocation of transmit slots requires a single atomic fetch and increment, providing fast arbitration among thousands of GPU threads
- Message transmission can use a single bus operation
- Reverse channel flow control is not in the critical path and has less than 1% overhead
- Completions are independently allocated to permit out of order replies
- The GPU end does not require a progress thread
- GPU and CPU communications use only store instructions, that can be both fire-and-forget and pipelined

The message ring is fast, with about 5 us round trip time from GPU to host to GPU, which is close to the required PCIe bus and arbitration times. Multiple GPU threads can achieve more than 20 million requests per second, even with only a single thread processing requests at the CPU end.

E. Device-resident Symmetric Heap

By design, Intel SHMEM requires a one-to-one mapping of PEs to SYCL devices. For Intel Data Center GPU Max Series, each GPU consists of two tiles, both of which are considered as a single SYCL device. This 1:1 mapping of PE to a GPU tile ensures a separate GPU memory space as symmetric heap for the corresponding PE. In order for the proxy thread to support host-sided OpenSHMEM operations on a symmetric heap residing in GPU memory, the buffer must be registered

with the `FI_MR_HMEM` mode bit set [23]. For Intel SHMEM to indicate which region to register, SOS provides extension APIs for registering a device memory region as an *external* symmetric heap, which is supported alongside the standard OpenSHMEM symmetric heap residing in host memory [10]. These interfaces are:

- `shmemx_heap_create(base_ptr, size, ...)`
- `shmemx_heap_preinit()`
- `shmemx_heap_preinit_thread(requested, &provided)`
- `shmemx_heap_postinit()`

These APIs should be considered experimental, as they are well-suited to SOS's dual-phase initialization strategy. In the preinit phase, all PEs allocate their host symmetric heap regions (and determine the starting address of the static symmetric data segment) and initialize a process management interface (PMI) [18] to enable a key-value store for publishing and retrieving all relevant addresses and information. After this point, the application can optionally register the external device region using `shmemx_heap_create`, passing the desired base address, the region size, and constants indicating the memory kind (`SHMEMX_EXTERNAL_HEAP_ZE` and `SHMEMX_EXTERNAL_HEAP_CUDA` are currently supported) and device index. The postinit phase then takes care of registration of all the symmetric memory regions with the NIC and also completes other required initialization steps.

The PGAS community is actively considering alternative APIs for supporting external memory regions. OpenSHMEM researchers and specification committee members had studied memory kinds and spaces [26], [33]. UPC++ supports a memory kinds interface leveraging specific GPU allocator objects [17], which has proven to be a suitable replacement for MPI in a Kokkos application [32]. Intel SHMEM plans to eventually embrace a standardized OpenSHMEM interface, and the extensions described above provide a proof-of-concept for such a capability.

F. Proposed Device APIs

Intel SHMEM strives to support all the OpenSHMEM APIs, which at the time of this writing is OpenSHMEM version 1.5. Some interfaces must be called from the host only, such as the initialization and finalization APIs and all memory management APIs, because only the host is well-suited to setup the data structures that handle CPU/GPU proxy interactions and to perform dynamic allocation of device memory. On the other hand, most OpenSHMEM communication interfaces including RMA, AMO, signaling, collective, memory ordering, and point-to-point synchronization routines are callable from *both* the host and device with identical semantics.

However, much like NVSHMEM and ROC_SHMEM, the nature of GPU programming necessitates *new* device-only APIs that account for the massively multi-threaded architecture [9], [22]. For example, GPUs schedule *groups* of threads to better exploit the underlying SIMD (same instruction multiple data) or SIMT (same instruction multiple thread) architecture. If, for example, all threads within a group initiate RDMA operations simultaneously, there can be substantial contention on NIC resources leading to drastic performance

degradation. In this case it is more performant for the library to restrict RDMA operations to only occur on a designated leader thread of the thread group. On the other hand, device-specific APIs could enable threads within a group to collectively and collaboratively participate in communication operations, for instance by having each thread copy a given chunk of the source data to the destination across a unified memory space.

For these reasons, Intel SHMEM includes device-only extensions called the `work_group` interfaces, that are prefixed with `ishmemx_` as opposed to `ishmem_`. Examples of the `work_group` routines for RMA include:

- `ishmemx_put_work_group`
- `ishmemx_get_work_group`
- `ishmemx_put_nbi_work_group`
- `ishmemx_get_nbi_work_group`.

The collective operations also have `work_group` variants, e.g.:

- `ishmemx_broadcast_work_group`
- `ishmemx_reduce_work_group`
- `ishmemx_barrier_all_work_group`
- `ishmemx_sync_all_work_group`.

The AMOs do not have `work_group` variants because they are scalar operations that would not benefit from group optimizations. All device APIs are listed in “The `work_group` APIs Overview” section and documented throughout the “Intel® SHMEM API” section of the online specification [5].

G. Implementation Choices

1) *Remote Memory Access*: The implementation of Intel SHMEM requires careful attention to the presence of independent memory systems for the host CPU and for the attached GPU. The SYCL memory model and Level Zero GPU runtime system permit mapping of host memory into the GPU address space, and mapping of GPU memory into the host address space. However, individual loads and stores over PCIe depend on the PCIe bus bandwidth whereas, the host-initiated copy engines suffer from the startup cost needed for each transfer. Because of this, Intel SHMEM maintains separate data structures in host memory for initialization and host-initiated operations, and in GPU memory for GPU-initiated operations. The GPU data structures are accessible via a SYCL global variable.

Within a node (or potentially within a supernode), GPUs can directly talk to each other via Intel Xe-Link. These links permit load-store, copy engine, and atomic operations. During initialization, Intel SHMEM sets up memory mapping from every GPU to the symmetric heaps of every other GPU on the local node. Each OpenSHMEM operation then is translated to a direct data transfer from one GPU memory to the other.

As an example, for `ishmem_long_p(long *dest, long value, int] pe)`, which is a blocking store of a scalar value to a symmetric address on another processing element, the implementation works as follows:

- Base address of GPU resident data structures are loaded
- A table lookup determines whether the target PE’s heap is accessible via store
- Local address of the symmetric heap on the target PE in loaded for PEs within the node

- Pointer to `dest` is calculated given the target PE: $(dest - local_heap_base + remote_heap_base)$
- Value stored to the `dest` buffer on the target PE

In case of inter-node when the target PE is not directly accessible, a reverse offload message is created capturing the parameters of the call and then passed to the host via the ring buffer. A host thread receives the message and executes it as though it had been a host-initiated operation.

For remote memory access (*put* and *get*) that are blocked or strided, the intra-node version of the operations uses special `memcpy` functions that are based on SYCL vector operations for efficiency.

For the device extension operations mentioned in Section III-F, the intra-node versions use a multi-threaded vectorized `memcpy` while the inter-node versions perform a SYCL group barrier to assure the input buffers are valid, and the group leader thread is selected to make the reverse offload call to the host.

2) *Collective Operations*: Collective operations are often implemented by dynamic switching among different algorithms depending on interconnect topology, number of ranks, and operation size for efficiency reasons. `MPI_Allreduce`, and `shmem_reduce` are good examples. A small data reduction is usually latency limited, but a large reduction is usually bandwidth limited and different algorithms are appropriate for different data size and configuration choices.

Algorithm selection is particularly relevant to Intel SHMEM, which supports interconnect aware algorithms for intra-node collectives, and relies on OpenSHMEM for inter-node operations.

Sync and Broadcast: In OpenSHMEM, *sync* is a collective synchronization operation (similar to *barrier* but without a *quiet*). `ishmem_team_sync (ISHMEM_TEAM_SHARED)` is the idiom for synchronizing all the processing elements within the same shared memory domain. In the case of a system like Aurora, there are 12 GPU tiles per node, and all of the GPU tiles can be directly accessed for load-store from each other. After experimenting with different atomic operations, we choose to implement *sync* by having each PE to send an atomic increment to other PEs on a pre-allocated device memory region, and then waiting locally for the local variable to reach the correct total. The reason this works is that the Xe-Links can handle a large number of pipelined remote atomics, that are fire-and-forget, and then the local wait (implemented by an atomic compare exchange) can use the local GPU caches effectively.

We use the same “push” idea for smaller *broadcast* and *collect* (which is like `MPI_allgather`) operations, because generally stores are faster than loads, and by having the inner loop of a broadcast across different destinations, with the outer loop across addresses we can effectively load share across all the Xe-Links available.

Reduction: Some of the more interesting OpenSHMEM collectives are the various *reduction* operations. OpenSHMEM includes *min*, *max*, *sum*, *product*, *and*, *or*, and *xor* operations for

fixed-point datatypes from 8 to 64 bits and *min*, *max*, *sum*, and *product* for floating-point datatypes. Since hardware supported atomic operations do not cover all of these datatypes, we could not adopt the “push” strategy as discussed above. Instead, we exploit the enormous parallelism available on the GPU to split the reduction by address across threads, and have each thread use vector load operations, one local and one remote, to assemble the data followed by vector binary operations to do the reduction, and then vector based stores to update the destination buffer. Each PE duplicates the computation, which avoids extra synchronization among PEs.

For very large reductions, it is a better approach to split the work by address across PEs and then exchange results, that is the approach taken by the usual dissemination and ring reduction algorithms.

IV. PERFORMANCE EVALUATION

In this section, we present performance data for Intel SHMEM operations using micro-benchmarks implemented to measure minimum latency and maximum bandwidth achieved on systems with Intel Data Center Max GPUs. To collect these performance data, an internal system called Borealis [31] is used with a very similar configuration to that of Aurora [1]. Each compute node contains two Intel® Xeon® CPU Max 9470C (Sapphire Rapids) CPUs at 2.0 GHz, each with 52 cores and 2 threads per core. Each node has 1.1 TB of memory, six Intel® Data Center Max 1500 (Ponte Vecchio) GPUs and are connected using a HPE* Slingshot fabric 2.0.2. Nodes are running SUSE Linux* Enterprise Server 15 SP4 with Cray Shasta kernel 5.14.21-150400.24.55. The six GPUs on each node are fully connected by an Intel® Xe-Link network.

As performance measurement methodology, we have used the SYCL profiling utility [8] by adding the `sycl::property::queue::enable_profiling()` property to the SYCL queue that launches the operations. To reduce performance noise as much as possible, we warm-up the execution by running a variable number of iterations at the beginning bounded by the total execution time. We double the number of iterations until the execution time reaches more than 2 ms, at which point we stop the warm-up iterations. Then, we execute 10 trial iterations and take the best execution time from these.

In the first set of experiments, we measure the Put and Get operation bandwidth using the single threaded Intel SHMEM operations, `ishmem_put` and `ishmem_get`. Figure 3 presents these results. To compare and contrast the Intel SHMEM performance, we also measure the read and write operation throughput using a oneAPI Level Zero (L0) benchmark, `ze_peer` [3]. `ze_peer` is a performance benchmark to measure communication bandwidth and latency between two L0 devices in a system.

As shown in Figure 3(a) and Figure 3(b), performance varies depending on the message size of the operation. For small to medium message sizes of up to 4 KB, Intel SHMEM outperforms the L0 benchmark `ze_peer` because the GPU-resident Intel SHMEM code directly execute loads or stores

to the target PE, which avoids the startup latency of the GPU copy engines. Beyond 4 KB message size, the copy engine based transfer performs better. Above a tuned cutover value set internally in Intel SHMEM, the host proxy is used to start the copy engines to do the data transfer. For the mid-size messages above the cutover, Intel SHMEM performs slightly worse than L0 due to the extra latency of the reverse offload. As message size grows beyond 1 MB, Intel SHMEM performs similar to that of L0.

The graphs also demonstrate performance for three hardware interconnections. With a single PE execution, the Intel SHMEM performance benchmarks use the `src` and `dest` locations on the same GPU tile. With two PEs, the target PE is on the other tile of the same GPU, and with three PEs, the target PE is on a different GPU. Thus, the three different executions of Intel SHMEM benchmarks on Figure 3(a) and Figure 3(b) exhibit the performance characteristics across different hardware components.

In the second set of experiments, we measure the bandwidth for the device extension APIs of RMA, as discussed in Section III-F. We use the same performance methodology as the default Put experiment but vary the number of work-items within the work-group that we use during kernel launch. With these experiments, we show the usefulness of the device extension APIs and how more number of work-items can parallelize and extract better performance. Figure 4 presents these results. In Figure 4(a), we execute kernel-driven store operations for all message sizes and in Figure 4(b), we measure the bandwidth for copy engine driven transfers. Both of these figures have identical Y-axis bounds to facilitate a direct comparison. These tests are for the case where source and destination are on different GPUs connected by the Xe-link fabric.

As shown in Figure 4(a), with increasing work-group size (threads), for the same data size, performance can be improved as more resources are utilized. We run this experiment with 1, 16, 128, and 1024 work-items per work-group and observe higher bandwidth for 1024 work-items compared to others. On the other hand, in Figure 4(b), we observe the same performance for different number of work-items. This is because for reverse offload, Intel SHMEM chooses only a single GPU work-item to communicate with the host proxy, thereby minimizing contention. These graphs also demonstrate that for small to medium message sizes, store operations within kernels perform better. As message size increases, choosing the copy engine is more performant even for these device extension APIs. However, unlike the cutover value for standard APIs, the cutover value for the device extension APIs depend on both the message size and the number of work-items launched in the work-group as Figure 4(a) shows variability in performance with respect to the work-group size.

We, therefore, have implemented cutover logic to switch from the use of organic load-store for smaller operations, to, for larger operations, making an up-call to the host in order to start the copy engines. Cutover tuning is dependent on the data size and on the number of active GPU work-

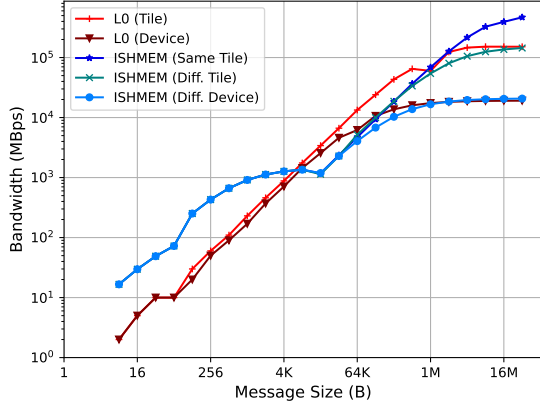

(a) Intel SHMEM Put Bandwidth

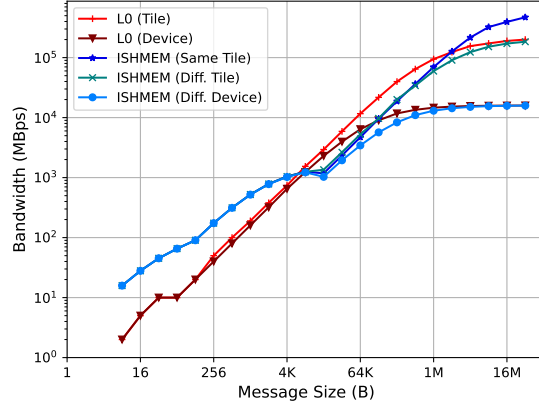

(b) Intel SHMEM Get Bandwidth

Fig. 3. Intra-node single-threaded Put and Get operation bandwidth within the same device, across tile, and different device

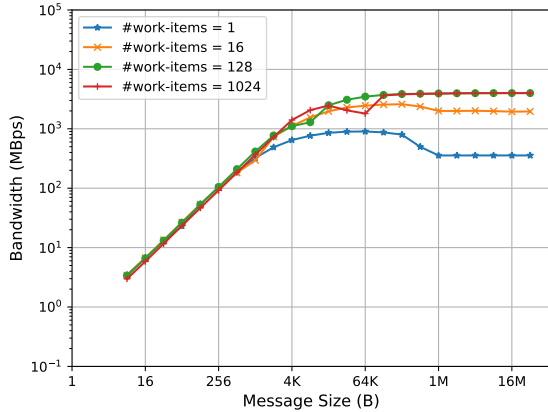

(a) Store from kernel work-items

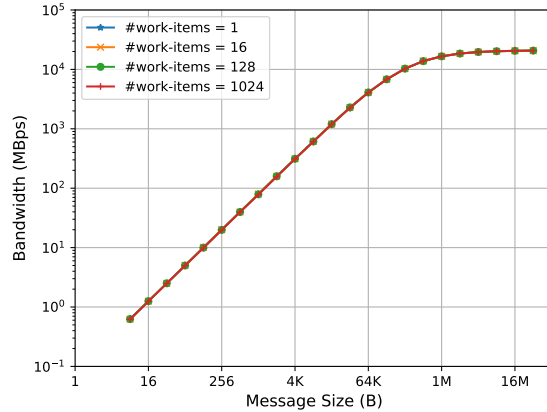

(b) Copy engine

Fig. 4. Performance characteristics of work-group Put operation with varying number of work-items

items. Figure 5 presents these results in terms of operation bandwidth (Figure 5(a)) and latency (Figure 5(b)) for `ishmemx_put_work_group`.

With cutover value set, `ishmemx_put_work_group` obtains better performance for small to medium message sizes by using direct store using all work-items in the work-group. For larger message sizes, after the cutover, it matches the performance as obtained by the hardware copy engines.

We performed similar experiments for the collective operations and Figure 6 presents the findings for the device extension of `fcollect_work_group`. In this set of experiments, we vary both the number of work-items per work-group and number of PEs that execute the collective operation. In these graphs, we present the *host-initiated copy engine* scenario as the black dashed line to compare with the other device-initiated store operations.

As shown in Figure 6(a), Figure 6(b), and Figure 6(c), the kernel-initiated direct store operation by the parallel work-items performs better compared to the host-driven copy engine based transfer for small to medium number of elements `nelems` (around up to 1K). For larger numbers of `nelems`, it is better to choose the reverse offload for a copy engine transfer. However, both the number of work-items and the total number of PEs involved in the collective impact the cutover point. For example, with 4 PEs and 256 work-items (Figure 6(a)), the cutover point is at 4K number of elements in the collective. However, with 12 PEs and 256 work-items (Figure 6(c)), for the same 4K number of elements, it is still better to utilize the parallel work-items over the host-initiated copy engine transfer.

Based on the above findings, we choose the cutover points appropriately for each collective operation so that the runtime

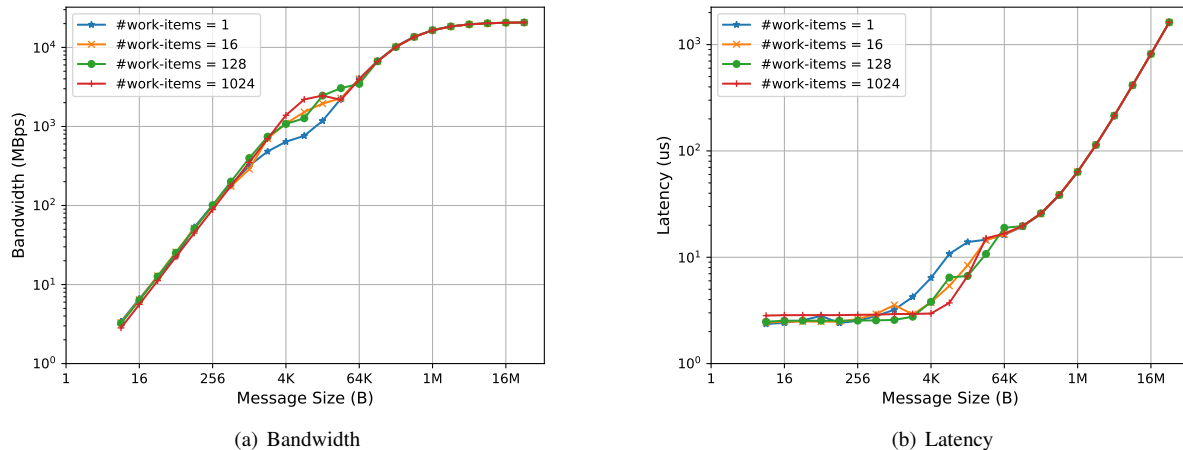

Fig. 5. Performance characteristics of work-group level Put operation with varying number of work-items

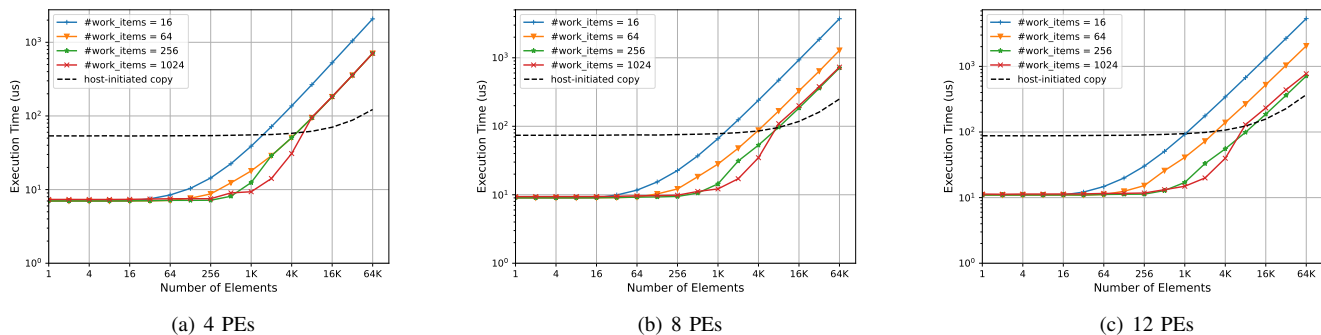

Fig. 6. Performance characteristics of `fcollect_work_group` with varying number of work-items

adapts based on the application execution settings. We present two collective operations performance in Figure 7. Figure 7(a) shows performance results for `fcollect_work_group` run with 12 PEs and varying number of work-items, where it appropriately chooses the cutover to provide optimal performance across different number of elements. Figure 7(b) presents performance results for `broadcast_work_group`, where we vary the number of PEs from 2 to 12, keeping the number of work-items fixed at 128. Here, we see uniform strong scaling performance as we increase the number of PEs. The performance for 2 PE broadcast stands out as the two PEs in this experiment are using two tiles within the same GPU, avoiding any across Xe-Link transfer.

A. Comparison with Existing Runtimes

Because of unavailability of systems that contain GPUs from different vendors and also the lack of back-end support for enabling different GPU drivers, we could not conduct any experiment comparing performance of Intel SHMEM with that of NVSHMEM [22], [34] and ROC_SHMEM [9]. As we envision Intel SHMEM providing the non-proprietary solution

for GPU-initiated communication, we would continue working on enabling our library on other platforms.

V. CONCLUSION

Intel SHMEM is an implementation of the OpenSHMEM standard for the C/C++ programming environment with SYCL, initially supporting Intel CPUs and GPUs. The current open-source version [4] supports remote memory access, remote atomic operations, signaling, synchronization, collective operations, and ordering from OpenSHMEM 1.5 callable from either host or device using SYCL kernels, providing coverage to most SHMEM operations from the entire application.

Extensions to the OpenSHMEM standard are also provided callable from device, in order to permit heavily multithreaded GPU kernels to collaboratively implement data transfer operations. Intel SHMEM optimizes by tuning these operations appropriately to choose either the kernel-driven load/store or the host driven copy depending on the application configurations.

As of next steps, we plan to investigate further on other extensions that enable further control for application pro-

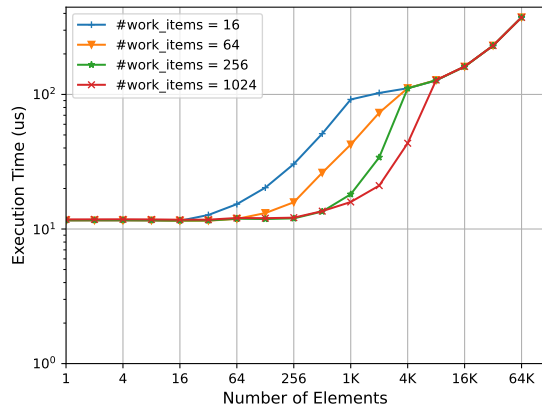

(a) 12 PEs fcollect performance with tuned cutover

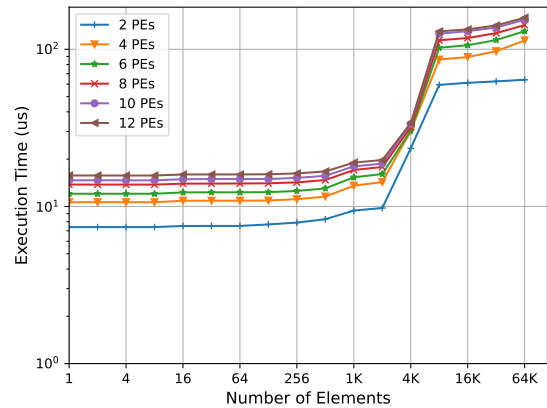

(b) broadcast performance with varying number of PEs

Fig. 7. Performance characteristics of collective operations

grammers to define dependencies between host and device executions. We also plan to enable Intel SHMEM for different application use-cases.

REFERENCES

- [1] “Aurora Supercomputer,” <https://www.intel.com/content/www/us/en/high-performance-computing/supercomputing/exascale-computing.html>.
- [2] “Cray T3D,” <https://cray-history.net/cray-history-front/fom-home/cray-t3d/>.
- [3] “Intel[®] oneAPI Level Zero Tests,” https://github.com/oneapi-src/level-zero-tests/tree/master/perf_tests/ze_peer.
- [4] “Intel[®] SHMEM,” <https://github.com/oneapi-src/ishmem>.
- [5] “Intel[®] SHMEM documentation,” <https://oneapi-src.github.io/ishmem>.
- [6] “Level Zero,” <https://dgpu-docs.intel.com/technologies/level-zero.html>.
- [7] “Multinode Multi-GPU: Using NVIDIA cuFFTMp FFTs at Scale,” <https://developer.nvidia.com/blog/multinode-multi-gpu-using-nvidia-cufftm-ffts-at-scale/>.
- [8] “Profiling SYCL Applications,” <https://developer.codeplay.com/products/computecpp/ce/2.11.0/guides/profiling-computecpp-applications/profiling-sycl-applications>.
- [9] “ROC_SHMEM,” https://github.com/ROCm-Developer-Tools/ROC_SHMEM.
- [10] “Sandia OpenSHMEM,” <https://github.com/Sandia-OpenSHMEM/SOS.git>.
- [11] “SYCL Interoperability: A Deep Dive into Bridging CUDA and oneAPI,” <https://www.oneapi.io/blog/sycl-interoperability-a-deep-dive-into-bridging-cuda-and-oneapi/>, 2023.
- [12] “CUDA toolkit,” <https://developer.nvidia.com/cuda-toolkit>, 2024.
- [13] “SYCL,” <https://www.khronos.org/sycl/>, 2024.
- [14] “The TOP500 List,” <https://top500.org/>, 2024.
- [15] “What is ROCm?” <https://rocm.docs.amd.com/en/docs-5.7.0/rocm.html>, 2024.
- [16] R. Babich, G. Shi, M. A. Clark, R. C. Brower, B. Joó, and S. Gottlieb, “Scaling lattice QCD beyond 100 GPUs,” in *SC '11: Proceedings of 2011 International Conference for High Performance Computing, Networking, Storage and Analysis*, 2011, pp. 1–11.
- [17] J. Bachan, S. B. Baden, D. Bonachea, J. Corbino, J. Grossman, P. H. Hargrove, S. Hofmeyr, M. Jacquelin, A. Kamil, B. Van Straalen, and D. Waters, “UPC++ v1.0 Programmer’s Guide (Rev. 2023.9.0),” 12 2023. [Online]. Available: <https://www.osti.gov/biblio/2229871>
- [18] P. Balaji, D. Buntinas, D. Goodell, W. Gropp, J. Krishna, E. Lusk, and R. Thakur, “PMI: A Scalable Parallel Process-Management Interface for Extreme-Scale Systems,” in *Recent Advances in the Message Passing Interface*, R. Keller, E. Gabriel, M. Resch, and J. Dongarra, Eds. Berlin, Heidelberg: Springer Berlin Heidelberg, 2010, pp. 31–41.
- [19] M. Grossman, J. Doyle, J. Dinan, H. Pritchard, K. Seager, and V. Sarkar, “Implementation and Evaluation of OpenSHMEM Contexts Using OFI Libfabric,” in *OpenSHMEM and Related Technologies. Big Compute and Big Data Convergence*, M. Gorentla Venkata, N. Imam, and S. Pophale, Eds. Cham: Springer International Publishing, 2018, pp. 19–34.
- [20] K. Hamidouche and M. LeBeane, “GPU initiated OpenSHMEM: correct and efficient intra-kernel networking for dGPUs,” in *25th ACM SIGPLAN Symposium on Principles and Practice of Parallel Programming (PPoPP ’20)*. New York, USA: Association for Computing Machinery, 2020, pp. 336–347.
- [21] J. R. Hammond, S. Ghosh, and B. M. Chapman, “Implementing OpenSHMEM Using MPI-3 One-Sided Communication,” in *OpenSHMEM and Related Technologies. Experiences, Implementations, and Tools*, S. Poole, O. Hernandez, and P. Shamsi, Eds. Cham: Springer International Publishing, 2014, pp. 44–58.
- [22] C. H. Hsu, N. Imam, A. Langer, S. Potluri, and C. J. Newburn, “An Initial Assessment of NVSHMEM for High Performance Computing,” in *2020 IEEE International Parallel and Distributed Processing Symposium Workshops (IPDPSW)*, New Orleans, LA, USA, 2020, pp. 1–10.
- [23] A. Ingerson, “Libfabric Intranode Device Support,” in *2020 OpenFabrics Alliance Virtual Workshop*, 2020.
- [24] A. Li, B. Fang, C. Granade, G. Prawiroatmodjo, B. Heim, M. Roetteler, and S. Krishnamoorthy, “SV-sim: scalable PGAS-based state vector simulation of quantum circuits,” in *Proceedings of the International Conference for High Performance Computing, Networking, Storage and Analysis*, ser. SC ’21. New York, NY, USA: Association for Computing Machinery, 2021. [Online]. Available: <https://doi.org/10.1145/3458817.3476169>
- [25] D. Mishler, J. Ciesko, S. Olivier, and G. Bosilca, “Performance Insights into Device-initiated RMA Using Kokkos Remote Spaces,” in *2023 IEEE International Conference on Cluster Computing Workshops (CLUSTER Workshops)*, 2023, pp. 66–67.
- [26] N. Namashivayam, B. Cernohous, K. Kandalla, D. Pou, J. Robichaux, J. Dinan, and M. Pagel, “Symmetric Memory Partitions in OpenSHMEM: A Case Study with Intel KNL,” in *OpenSHMEM and Related Technologies. Big Compute and Big Data Convergence*, M. Gorentla Venkata, N. Imam, and S. Pophale, Eds. Cham: Springer International Publishing, 2018, pp. 3–18.
- [27] “OpenSHMEM Application Programming Interface, Version 1.5,” <http://www.openshmem.org>, 2020.
- [28] D. Ozog, M. Rahman, G. Taylor, and J. Dinan, “Designing, Implementing, and Evaluating the Upcoming OpenSHMEM Teams API,” in *2019 IEEE/ACM Parallel Applications Workshop, Alternatives To MPI (PAW-ATM)*, 2019, pp. 37–46.
- [29] K. Seager, S.-E. Choi, J. Dinan, H. Pritchard, and S. Sur, “Design and

- Implementation of OpenSHMEM Using OFI on the Aries Interconnect,” in *OpenSHMEM and Related Technologies. Enhancing OpenSHMEM for Hybrid Environments*, M. Gorentla Venkata, N. Imam, S. Pophale, and T. M. Mintz, Eds. Cham: Springer International Publishing, 2016, pp. 97–113.
- [30] M. Si, H. Fu, J. R. Hammond, and P. Balaji, “OpenSHMEM over MPI as a Performance Contender: Thorough Analysis and Optimizations,” in *OpenSHMEM and Related Technologies. OpenSHMEM in the Era of Exascale and Smart Networks*, S. Poole, O. Hernandez, M. Baker, and T. Curtis, Eds. Cham: Springer International Publishing, 2022, pp. 39–60.
- [31] T. Trader, “Intel’s ‘Borealis’ Testbed Targets Exascale Readiness for Aurora Supercomputer,” <https://www.hpcwire.com/2021/12/16/intels-borealis-targets-exascale-readiness-for-aurora-supercomputer/>.
- [32] D. Waters, C. A. MacLean, D. Bonachea, and P. Hargrove, “Demonstrating UPC++/Kokkos Interoperability in a Heat Conduction Simulation,” 2021.
- [33] A. Welch, S. Pophale, P. Shamis, O. Hernandez, S. Poole, and B. Chapman, “Extending the OpenSHMEM Memory Model to Support User-Defined Spaces,” in *Proceedings of the 8th International Conference on Partitioned Global Address Space Programming Models*, ser. PGAS ’14. New York, NY, USA: Association for Computing Machinery, 2014. [Online]. Available: <https://doi.org/10.1145/2676870.2676884>
- [34] C. Xie, J. Chen, J. Firoz, J. Li, S. L. Song, K. Barker, M. Raugas, and A. Li, “Fast and Scalable Sparse Triangular Solver for Multi-GPU Based HPC Architectures,” in *50th International Conference on Parallel Processing (ICPP ’21)*. New York, USA: Association for Computing Machinery, 2021, pp. Articl 53, 1–11.
- [35] J. Zhang, J. Brown, S. Balay, J. Faibussowitsch, M. Knepley, O. Marin, R. T. Mills, T. Munson, B. F. Smith, and S. Zampini, “The PetscSF Scalable Communication Layer,” *IEEE Transactions on Parallel and Distributed Systems*, vol. 33, no. 4, pp. 842–853, 2022.

Intel and Xeon are trademarks of Intel Corporation in the U.S. and/or other countries.

Benchmark results were obtained prior to implementation of recent software patches and firmware updates intended to address exploits referred to as “Spectre” and “Meltdown”. Implementation of these updates may make these results inapplicable to your device or system.

Software and workloads used in performance tests may have been optimized for performance only on Intel® microprocessors. Performance tests, such as SYSmark* and MobileMark*, are measured using specific computer systems, components, software, operations and functions. Any change to any of those factors may cause the results to vary. You should consult other information and performance tests to assist you in fully evaluating your contemplated purchases, including the performance of that product when combined with other products.

For more information go to <http://www.intel.com/benchmarks>.

*Other names and brands may be claimed as the property of others.

Appendix: Artifact Description/Artifact Evaluation

Artifact Description (AD)

I. OVERVIEW OF CONTRIBUTIONS AND ARTIFACTS

A. Paper's Main Contributions

- C_1 Intra-node single-threaded OpenSHMEM RMA operation bandwidth within different topology
- C_2 Performance characteristics of OpenSHMEM RMA extensions on GPUs
- C_3 Performance characteristics of OpenSHMEM collective extensions on GPUs

B. Computational Artifacts

- A_1 <https://doi.org/10.5281/zenodo.13749597>

Artifact ID	Contributions Supported	Related Paper Elements
A_1	C_1	Figure 3
A_1	C_2	Figures 4,5
A_1	C_3	Figures 6,7

II. ARTIFACT IDENTIFICATION

A. Computational Artifact A_1

Relation To Contributions

The artifact A_1 includes the necessary scripts to generate all three major contributions of the paper as listed above. To make it simple to use, separate scripts are provided for generating the dataset and graphs. Also, some dataset generation requires the software to be re-built with provided patches in A_1 . For each such dataset, separate script is provided.

Expected Results

Each experiment generates a dataset or graph which will show performance characteristics of different Intel® operations. For C_1 , the dataset should show better performance for *Same Tile* or *Diff. Tile* topology compared to *Diff. Device*. For C_2 , the experiments were run with different number of work items where larger number of work-items are expected to perform better compared to the smaller number of work-items. For C_3 , along with varying work-items the total number of processes run are also varied and these should exhibit better scaled performance with more number of processes.

Expected Reproduction Time (in Minutes)

The artifact setup would require an estimated time of 5 - 10 minutes approximately, whereas for execution of each of the scripts would take 3 - 5 minutes.

Artifact Setup (incl. Inputs)

Hardware: To run the experiments, the following hardware setup is required.

- Intel® Data Center Max 1500 (Ponte Vecchio) GPU
- Intel® Xeon® CPU Max 9470C (Sapphire Rapids) CPU
- HPE* Slingshot interconnect
- Intel® Xe-Link fabric

Software: To run the experiments, the following software are required.

- Linux OS with dmabuf support (e.g., SUSE Linux Enterprise Server 15 SP4)
- Intel® oneAPI DPC++/C++ Compiler 2024.0 or higher
- oneAPI Level Zero
- Libfabric (with CXI provider support for HPE Slingshot)
- Sandia OpenSHMEM
- Intel® SHMEM
- Python3 with matplotlib
- System utility tools: *grep*, *awk*, *paste*

Datasets / Inputs: The datasets are generated using the `generate_ci` scripts provided in A_1 .

Installation and Deployment: For Intel® SHMEM installation along with all the dependencies, please follow the instructions provided in <https://github.com/oneapi-src/ishmem/blob/main/README.md>. As part of the installation, Intel SHMEM requires Level Zero and Sandia OpenSHMEM to be installed. To build and install Sandia OpenSHMEM on HPE Slingshot fabric, please follow the instructions provided in [https://github.com/Sandia-OpenSHMEM/SOS/wiki/Slingshot-\(CXI\)-Build-Instructions](https://github.com/Sandia-OpenSHMEM/SOS/wiki/Slingshot-(CXI)-Build-Instructions). Installation instructions for Libfabric can be found in <https://github.com/ofiwg/libfabric/blob/main/README.md>.

To install matplotlib on Python, please follow the instructions provided in <https://matplotlib.org/stable/install/index.html>.

Artifact Execution

The artifact follows a workflow of three steps to generate the contributions that are mentioned in the paper. Before executing the following workflow, all the required software must be installed and ready to use.

The first step on the workflow is to apply one or more patches on the Intel SHMEM source code and rebuild Intel SHMEM along with all the tests. This will ensure some of the performance enhancements mentioned in the paper to be enabled.

The second step on the workflow is to generate the dataset using the `generate_ci` scripts. For C_2 and C_3 , the generate scripts are subdivided to ensure ease-of-use and simplicity. All of these scripts must be provided with the Intel SHMEM build directory for correct execution.

The third step on the workflow is to use the plot files in A_1 to generate graphs. For ease-of-use, A_1 includes a `generate_graphs.sh` script which reads all the plot files and generates corresponding graphs. To ensure for these scripts to work properly, all generated data files should be kept in the same directory as the plot script files.

Artifact Analysis (incl. Outputs)

After the graphs are generated, those can be analyzed by comparing with the corresponding figures as mentioned in Section I-B.

Artifact Evaluation (AE)

A. Computational Artifact A_1

Artifact Setup (incl. Inputs)

The following commands are used to download, build, and install Sandia OpenSHMEM (SOS) and Intel SHMEM. These instructions are specific to the Sunspot cluster at the Argonne Leadership Computing Facility (ALCF). Changes specific to Sunspot@ALCF are highlighted below, so that the commands can be more easily modified to run on other systems. At the time of this writing, these are the (default) loaded modules on Sunspot@ALCF, seen with the module list command:

```
Currently Loaded Modules:
 1) spack-pe-gcc/0.7.0-24.086.0
 2) gmp/6.2.1-pcxzkau
 3) mpfr/4.2.0-w7v7yjv
 4) mpc/1.3.1-dfagrna
 5) gcc/12.2.0
 6) mpich/icc-all-pmix-gpu/20231026
 7) mpich-config/collective-tuning/1024
 8) intel_compute_runtime/release/821.36
 9) oneapi/eng-compiler/2024.04.15.002
10) libfabric/1.15.2.0
11) cray-pals/1.3.3
12) cray-libpals/1.3.3
```

Also on Sunspot@ALCF, please load the default CMake module, at the time of this writing module load cmake/3.27.7.

Please note that the mpicc compiler is used for SOS build because of the usage of an MPI based PMI interface in our execution environment. Also, OFI Libfabric is a dependency of SOS, which is already installed on Sunspot@ALCF. If building libfabric from source, please note that the provider must have the FI_HMEM feature available to support Intel SHMEM. At the time of this writing, these providers include cxi, psm3, and verbs;ofi_rxm, which are set via the FI_PROVIDER environment variable. Level Zero (L0) is a dependency of Intel SHMEM, which is also already installed on Sunspot@ALCF, as noted below.

Before downloading the artifact A_1 repository, the following needs to be executed to enable proper HTTP proxy configurations.

```
export HTTP_PROXY=http://proxy.alcf.anl.gov:3128
export HTTPS_PROXY=http://proxy.alcf.anl.gov:3128
export http_proxy=http://proxy.alcf.anl.gov:3128
export https_proxy=http://proxy.alcf.anl.gov:3128
git config --global http.proxy http://proxy.alcf.anl.gov:3128
```

The following steps assume that artifact A_1 is cloned into a directory named artifacts.

```
git clone --recurse-submodules \
  https://github.com/Sandia-OpenSHMEM/SOS.git sos
cd sos
./autogen.sh
mkdir build
mkdir install

# Set an SOS installation directory:
export SOS_INSTALL=$PWD/install

# If needed, set OFI and L0 installation directories:
# on Sunspot@ALCF with the modules noted above, please use:
export OFI_INSTALL=/opt/cray/libfabric/1.15.2.0
export L0_PREFIX=/opt/aurora/24.086.0/intel-gpu-umd/821.36
```

```
cd build
../configure --prefix=${SOS_INSTALL} \
  --with-ofi=${OFI_INSTALL} \
  --enable-pmi-mpi --disable-fortran \
  --enable-ofi-mr=basic \
  --enable-ofi-manual-progress \
  --disable-libtool-wrapper \
  --disable-bounce-buffers \
  --enable-mr-endpoint --enable-ofi-hmem \
  --disable-ofi-inject --disable-nonfetch-amo \
  --enable-manual-progress CC=mpicc CXX=mpicxx

make -j
make install
cd ../..

# Download artifacts including Intel SHMEM v1.1.0:
git clone \
  git@github.com:wrrobin/ws_pawatm114_reprod.git artifacts

cd artifacts
tar -xvf ishmem-v1.1.0.tar.gz
cd ishmem-1.1.0
mkdir build
cd build
cmake .. -DCMAKE_BUILD_TYPE=Release -DENABLE_OPENSHPMEM=ON \
  -DSHMEM_INSTALL_PREFIX=${SOS_INSTALL} \
  -DL0_INSTALL_PREFIX=${L0_PREFIX}

make -j
cd ../..
cp scripts/*.sh ishmem-1.1.0/build
cp scripts/*.py ishmem-1.1.0/build
```

To generate the figure plots, Python3 with Matplotlib is required and can be installed on Sunspot@ALCF like this:

```
python3 -m pip install -U matplotlib
```

Artifact Execution

After the installation of Intel SHMEM, the generate scripts are used to generate the dataset as follows.

The following executions assume a single-node job with the hardware and software requirements in *Artifact Setup* section. On Sunspot@ALCF, such a node can be reserved for 30 minutes like this:

```
qsub -l select=1 -l walltime=30:00 -A <your_project_name> \
  -q workqq -I
```

When executing the following scripts on Sunspot@ALCF, the FI_PROVIDER should be set to:

```
export FI_PROVIDER="cxi,tcp;ofi_rxm"
```

If FI_PROVIDER is left unset, the scripts will set it to cxi by default.

To execute a script that generates the C_1 contributions, run:

```
cd ishmem-1.1.0/build
ISHMEM_BUILD_DIR=$PWD ./generate_c1.sh
```

For C_2 contributions, there are additional performance enhancing features investigated and implemented on top of the current released version Intel SHMEM library. These changes are provided as separate patches to be merged before generating the datasets.

```
cd .. # ishmem-1.1.0
git apply ../ishmem_common.patch
git apply ../ishmem_cutover_never.patch
cd build
make -j
ISHMEM_BUILD_DIR=$PWD ./generate_c2_1.sh

cd ..
git apply ../ishmem_cutover_always.patch
```

```

cd build
make -j
ISHMEM_BUILD_DIR=$PWD ./generate_c2_2.sh

cd ..
git apply ../ishmem_cutover_current.patch
cd build
make -j
ISHMEM_BUILD_DIR=$PWD ./generate_c2_3.sh

```

For C_3 also, the patches need to be applied first before generating the dataset. One thing to note is that, the patches need to be applied in the same order as shown here to ensure successful update to the code and generation of the correct results. Also, at the time of this writing, the environment variable `ZE_FLAT_DEVICE_HIERARCHY` might need to be unset before executing the following commands.

```

cd .. # ishmem-1.1.0
git reset origin/main --hard
git apply ../ishmem_common.patch
git apply ../ishmem_cutover_never.patch
cd build
make -j
ISHMEM_BUILD_DIR=$PWD ./generate_c3_1.sh

cd ..
git apply ../ishmem_cutover_always.patch
git apply ../ishmem_cutover_current.patch
cd build
make -j
ISHMEM_BUILD_DIR=$PWD ./generate_c3_2.sh

```

Artifact Analysis (incl. Outputs)

After all the data is generated through the generate scripts, the generated data files are copied to the artifact A_1 repository, where the plot files exist. Alternatively, the Python scripts (*.py files) for generating the plots can be copied to the Intel SHMEM build directory. The `generate_graphs.sh` script is then used to generate all the graphs.

Figure 1 presents the reproduced data for Put and Get operation bandwidth with Intel SHMEM. Similar to Figure 3 in the paper, the data shows similar trend on different topology and also perform best within the same GPU tile.

We also reproduce the collective operation performance with `fcollect` and `broadcast` and present the obtained results in Figure 2. Similar to Figure 7 in the paper, the data show good performance trend with tuned cutover point selected for switching from kernel initiated EU driven copy to host initiated copy engine transfer.

Intel and Xeon are trademarks of Intel Corporation in the U.S. and/or other countries.

Benchmark results were obtained prior to implementation of recent software patches and firmware updates intended to address exploits referred to as “Spectre” and “Meltdown”. Implementation of these updates may make these results inapplicable to your device or system.

Software and workloads used in performance tests may have been optimized for performance only on Intel® microprocessors. Performance tests, such as SYSmark* and MobileMark*, are measured using specific computer systems, components, software, operations and functions. Any change to any of those factors may cause the results to vary. You should consult other information and performance tests to assist you in fully evaluating your contemplated purchases, including the performance of that product when combined with other products.

For more information go to <http://www.intel.com/benchmarks>.

*Other names and brands may be claimed as the property of others.

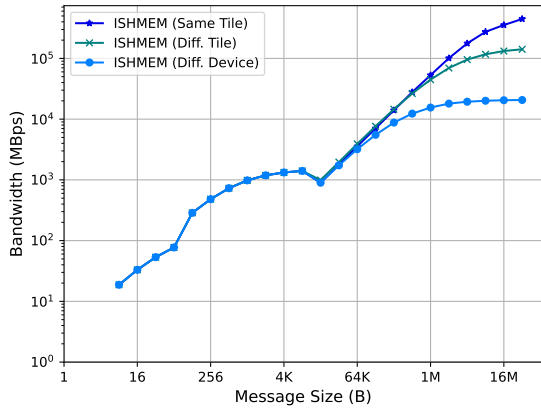

(a) Put Bandwidth

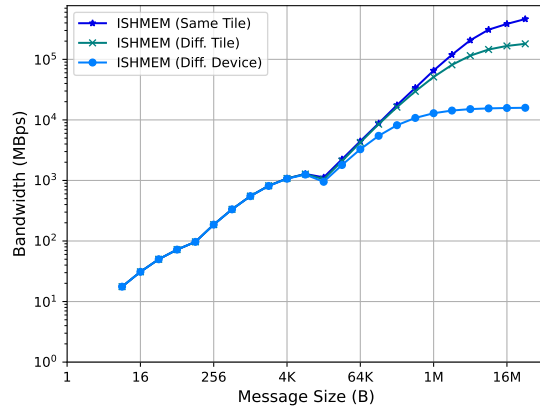

(b) Get Bandwidth

Fig. 1. Intra-node single-threaded Put and Get operation bandwidth within the same device, across tile, and different device

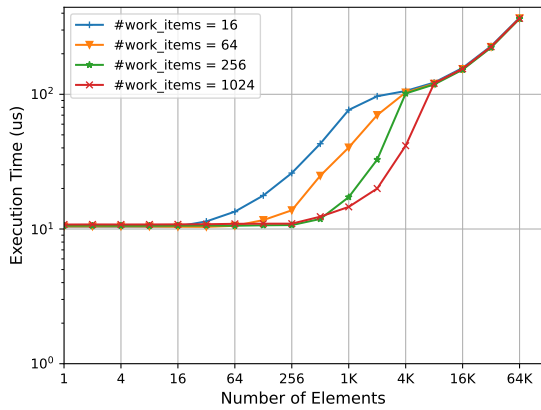

(a) 12 PEs fcollect performance with tuned cutover

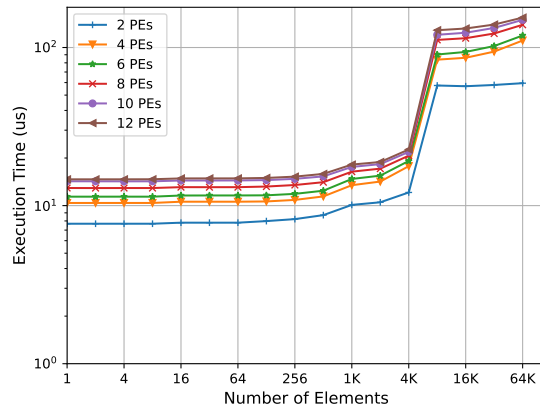

(b) broadcast performance with varying number of PEs

Fig. 2. Performance characteristics of collective operations