

Delay-Optimum Adder Circuits with Linear Size

Ulrich Brenner*, Benjamin David Görg

Research Institute for Discrete Mathematics, University of Bonn, Lennéstr. 2, 53113 Bonn, Germany

Abstract

We present efficient circuits for the addition of binary numbers. We assume that we are given arrival times for all input bits and optimize the delay of the circuits, i.e. the time when the last output bit is computed. This contains the classical optimization of depth as a special case where all arrival times are 0. In this model, we present, among other results, the fastest adder circuits of sub-quadratic size and the fastest adder circuits of linear size. In particular, for adding two n -numbers we get a circuits with linear size and delay $\log_2 W + 3 \log_2 \log_2 n + 4 \log_2 \log_2 \log_2 n + \text{const}$ where $\log_2 W$ is a lower bound for the delay of any adder circuit (no matter what size it has).

1 Introduction

We consider the well-studied problem of constructing fast and small circuits for binary addition. The standard method for addition binary numbers includes the computation of carry bits. Given two numbers $a = \sum_{i=0}^{n-1} a_i 2^i$ and $b = \sum_{i=0}^{n-1} b_i 2^i$ in binary representation, the carry bits are defined recursively by

$$\begin{aligned} c_0 &= 0 \\ c_{i+1} &= (a_i \wedge b_i) \vee ((a_i \oplus b_i) \wedge c_i) \end{aligned}$$

for $i \in \{0, \dots, n-1\}$, where $a_i \oplus b_i$ is true if and only if exactly one of a_i and b_i is true. Hence, the carry bit c_{i+1} is true if and only if $g_i := a_i \wedge b_i$ is true (i.e., c_{i+1} is *generated* at position i), or $p_i := a_i \oplus b_i$ is true and c_i is true (i.e., c_{i+1} is *propagated* from position i). By definition, each carry bit can be computed via the formula

$$c_{i+1} = g_i \vee (p_i \wedge (g_{i-1} \vee (p_{i-1} \wedge (\dots \vee (p_1 \wedge g_0) \dots))). \quad (1)$$

Given all carry bits c_0, \dots, c_n , the sum $a + b$ is now easily computed via

$$(a + b)_i = \begin{cases} c_i \oplus p_i & \text{if } i \in \{0, \dots, n-1\}, \\ c_n & \text{if } i = n. \end{cases}$$

Hence, the binary addition is reduced to computing all the carry bits c_1, \dots, c_n which are realized by AND-OR paths on the input pairs $g_i, p_i, \dots, g_1, p_1, g_0$ for all $i \in \{1, \dots, n\}$. A circuit solving this problem is called adder circuit.

We propose a new set of circuits computing the carry bits c_0, \dots, c_{n+1} , thus also proposing a circuit for binary addition. In our model, we assume that not all input signals are necessarily available at the same time but that we are given arrival times $a(a_0), \dots, a(a_{n-1})$ and $a(b_0), \dots, a(b_{n-1})$ which directly lead to arrival times $a(g_0), \dots, a(g_{n-1})$ and $a(p_0), \dots, a(p_{n-1})$. We assume a delay of one for all AND- and OR-gates, which is reasonable since in practice the delay of both gates different only slightly on real chips. Our goal is to construct circuits such that the last arrival time on a carry bit is minimized. This model generalizes the optimization of circuit depth (where all arrival times are assumed to be 0) and has been studied e.g. in [Ok194], [Zim98], [Cho04], [HS17], and [BH19].

Apart from the delay of a circuit, also its size (i.e. the number of gates) is an important measurement of quality. One could compute each carry bit separately but this would necessarily lead to an at least quadratic size, which is unacceptable for large adder units. The main task is to find a good tradeoff between the delay (depth) and the size of the circuit.

1.1 Our contributions

We present the first circuits computing all carry bits with sub-quadratic size and delay $\log_2 W + \mathcal{O}(\log_2 \log_2 n)$ where $W = \sum_{i=0}^{n-1} (2^{a(p_i)} + 2^{a(g_i)})$. Note that $\log_2 W$ is a lower bound on the delay of *any* circuit depending on all input bits (g_0, \dots, g_{n-1}) and (p_0, \dots, p_{n-1})

*brenner@or.uni-bonn.de, corresponding author

Delay	Size	Result
$\log_2 W + 3 \log_2 \log_2 n + 5.007$	$2.422n \log_2^2 n$	Theorem 4.5
$\log_2 W + 3 \log_2 \log_2 n + 3 \log_2 \log_2 \log_2 n + \begin{cases} 8.461, & \text{if } n \leq 2^{21} \\ 9.067 & \text{otherwise} \end{cases}$	$\begin{matrix} 6.2n \log_2 n & \text{if } n \leq 2^{21}, \\ 4.442n \log_2 n & \text{otherwise} \end{matrix}$	Theorem 5.8
$\log_2 W + 3 \log_2 \log_2 n + 3 \log_2 \log_2 \log_2 n + 11.085$	$24.436n \log_2 \log_2 n$	Theorem 5.13
$\log_2 W + 3 \log_2 \log_2 n + 4 \log_2 \log_2 \log_2 n + 18.596$	$53.877n$	Theorem 5.20
$\log_2 W + \sum_{i=2}^{j+1} 3 \log_2^{(i)} n + \mathcal{O}(1)$	$\mathcal{O}(n \log_2^{(j)} n)$	Corollary 5.14
$\log_2 W + \sum_{i=2}^j 3 \log_2^{(i)} n + 4 \log_2^{(j+1)} n + \mathcal{O}(1)$	$\mathcal{O}(n)$	Corollary 5.15

Table 1: Summary of the constructed adder circuits.

Table 1 gives a detailed overview of the adder circuits presented in this paper. These include

- the fastest adder circuits with subquadratic size,
- the fastest adder circuits with size $\mathcal{O}(n \log_2^2 n)$, $\mathcal{O}(n \log_2 n)$ and $\mathcal{O}(n \log_2 \log_2 n)$ each, and
- the fastest adder circuits with linear size.

Note that our delay bounds are in the range of the best known delay guarantees for any circuit computing only the last carry bit, which is also $\log_2 W + \Theta(\log_2 \log_2 n)$ (see [BH19]). The previously best known delay guarantee of an adder with a sub-quadratic size was provided by Spirkel [Spi14] who claimed a delay bound of order $\lceil \log_2 W \rceil + \mathcal{O}(\sqrt{\log_2 n})$ and a linear size.

The rest of the paper is organized as follows. In Section 2, the basic mathematical objects used here are introduced. Moreover, we present the main problems that we consider and give an overview of relevant previous results. Section 3 contains a detailed analysis of a group of circuits proposed in [RSW07]. In particular, we specify some constants in the bounds on the delay and size. These constants have not been computed by the authors of [RSW07] but they are important to us since we use these circuits in our construction. In Section 4, we show (using the results by [RSW07] and [BH19]) how to construct adder circuits with delay at most $\log_2 W + 3 \log_2 \log_2 n + 5.007$ and size $\mathcal{O}(n \log_2^2 n)$. In Section 5, we describe an adder construction framework, presented in [BS24], which was used to linearize depth-optimizing adders with sub-quadratic size while increasing the depth only by a small amount. We will see that this framework is also suitable for the size reduction of delay-optimizing adders. We apply the framework to our previously constructed adder to compute three more adder circuits, each having a larger delay bound and a smaller size bound than the last, asymptotically. These results include adder circuits of linear size. Finally, Section 6 contains some concluding remarks.

2 Preliminaries

In this section, we introduce the basic mathematical vocabulary, basic results, and the main problems considered in this paper.

2.1 Boolean Functions and Boolean Formulae

A **Boolean variable** is a variable with values in $\{0, 1\}$. Given $n \in \mathbb{N}$, a **Boolean function** with n **Boolean input variables** (short, **inputs**) is a function $f : \{0, 1\}^n \rightarrow \{0, 1\}$. We call n the **arity** of f and f an n -**ary** Boolean function. Often, 0 and 1 are not viewed as integers but rather as symbols representing truth values where 0 means **false** and 1 stands for **true**. The inputs of a Boolean function $f : \{0, 1\}^n \rightarrow \{0, 1\}$ are usually denoted by x_0, \dots, x_{n-1} or shorter as a vector $x = (x_0, \dots, x_{n-1})$.

Definition 2.1. Let a Boolean function $f : \{0, 1\}^n \rightarrow \{0, 1\}$, an input x_i with $i \in \{0, \dots, n-1\}$ and $\alpha \in \{0, 1\}$ be given. The function $f|_{x_i=\alpha} : \{0, 1\}^{n-1} \rightarrow \{0, 1\}$ defined by

$$f|_{x_i=\alpha}((x_0, \dots, x_{i-1}, x_{x+1}, \dots, x_{n-1})) = f((x_0, \dots, x_{i-1}, \alpha, x_{x+1}, \dots, x_{n-1}))$$

is called the **restriction** of f to $x_i = \alpha$. We say that f **depends essentially** on x_i if $f|_{x_i=0}$ and $f|_{x_i=1}$ differ.

There is another way to derive an equivalent definition of a Boolean function with the help of some elemental building blocks which will be defined next. To this end, we consider the following three operations on $\{0, 1\}$. The binary **And** operation $\cdot \wedge \cdot : \{0, 1\} \times \{0, 1\} \rightarrow \{0, 1\}$ is defined by $x \wedge y = 1$ if and only if $x = y = 1$. The binary **Or** operation $\cdot \vee \cdot : \{0, 1\} \times \{0, 1\} \rightarrow \{0, 1\}$ is defined by $x \vee y = 1$ if and only if $x = 1$ or $y = 1$. The unary **Not** operation $\bar{\cdot} : \{0, 1\} \rightarrow \{0, 1\}$, also called **Boolean negation**, is defined by $\bar{x} = 1$ if and only if $x = 0$.

These building blocks can be seen as Boolean functions by themselves.

Definition 2.2. Given $n \in \mathbb{N}$ and Boolean variables x_0, \dots, x_{n-1} , a **Boolean formula** on the input variables x_0, \dots, x_{n-1} is defined as follows:

- (i) The constants 0,1 and the variables x_0, \dots, x_{n-1} are Boolean formulae on x_0, \dots, x_{n-1} .
- (ii) If ϕ and ψ are Boolean formulae on x_0, \dots, x_{n-1} , then $(\phi \wedge \psi)$, $(\phi \vee \psi)$ and $\bar{\phi}$ are Boolean formulae on x_0, \dots, x_{n-1} .
- (iii) Any Boolean formula ϕ on x_0, \dots, x_{n-1} arises from finitely many applications of the rules (i) and (ii).

We also write $\phi((x_0, \dots, x_{n-1}))$ or $\phi(x)$ to denote a Boolean formula on input variables $x = (x_0, \dots, x_{n-1})$. We call n the **arity** of ϕ .

The parentheses in part (ii) of the definition may be omitted if the formula is clear from the context.

Definition 2.3. Given Boolean input variables $x = (x_0, \dots, x_{n-1})$ and a Boolean formula $\phi(x)$, the Boolean function $f_\phi : \{0, 1\}^n \rightarrow \{0, 1\}$ **realized by** $\phi(x)$ is defined as follows: Given a point $(\alpha_0, \dots, \alpha_{n-1}) \in \{0, 1\}^n$, the value $f_\phi((\alpha_0, \dots, \alpha_{n-1}))$ is obtained by replacing x_i with α_i for all $i \in \{0, \dots, n-1\}$ in the formula ϕ and then recursively evaluating the intermediate formulas (starting at the inputs) to compute the value of ϕ . If a Boolean function f is realized by a Boolean formula ϕ , we say that ϕ is a **realization** of f .

A Boolean formula realizes a unique Boolean function, but a Boolean function might have different realizations. Two Boolean formulae ϕ and ψ are called **equivalent** if ϕ and ψ realize the same Boolean function. In this case, we write $\phi = \psi$. Since a Boolean formula ϕ realizes a unique Boolean function f , we may also view ϕ as a Boolean function and write $\phi = f$. The symbol $=$ now is an equivalence relation on the union of the set of Boolean functions and the set of Boolean formulae with the same arity.

Let Boolean functions $f, g, h : \{0, 1\}^n \rightarrow \{0, 1\}$ be given. If $h(x) = f(x) \wedge g(x)$ for all $x \in \{0, 1\}^n$, then any realizations ϕ_f and ϕ_g of f and g yield a realization $\phi_h = \phi_f \wedge \phi_g$ of h (analogously for $h(x) = f(x) \vee g(x)$). If $f(x) = \overline{g(x)}$ for all $x \in \{0, 1\}^n$, then any realization ϕ_g of g yields a realization $\phi_f = \overline{\phi_g}$ of f .

Definition 2.4. A Boolean function $f : \{0, 1\}^n \rightarrow \{0, 1\}$ is called **monotone** if for all $\alpha, \beta \in \{0, 1\}^n$ with $\alpha \leq \beta$ (i.e. $\alpha_i \leq \beta_i$ for all $i \in \{0, \dots, n-1\}$), we have $f(\alpha) \leq f(\beta)$. A Boolean formula ϕ is called **monotone** if it does not contain any negations.

The majority of Boolean functions and Boolean formulae that we consider are monotone. We denote (without proofs) two easy results on Boolean functions and formulas in the following lemma.

Lemma 2.5. *Any Boolean function can be realized by a Boolean formula. Any monotone Boolean function can be realized by a monotone Boolean formula.* \square

The first statement of this lemma follows e.g. from Theorem 2.1.23 from Hermann [Her20]. A proof of the second statement can be found in Crama and Hammer [CH11].

Note that there are non-monotone Boolean formulae realizing a monotone Boolean function.

In the following, we summarize some notation and results on the important concept of Boolean duality.

Definition 2.6. Let ϕ be a Boolean formula. The **dual Boolean formula** ϕ^* of ϕ is obtained from ϕ by interchanging all \wedge and \vee operations and all 0 and 1 symbols.

Definition 2.7. Let $f : \{0, 1\}^n \rightarrow \{0, 1\}$ be a Boolean function. The **dual Boolean function** $f^* : \{0, 1\}^n \rightarrow \{0, 1\}$ of f is defined by

$$f^*((x_0, \dots, x_{n-1})) = \overline{f(\overline{(x_0, \dots, x_{n-1})})}.$$

To shorten notation, we write $\bar{x} = (\overline{x_0}, \dots, \overline{x_{n-1}})$ and, thus, $f^*(x) = f(\bar{x})$.

These two definitions imply that for a Boolean formula ϕ we have $(\phi^*)^* = \phi$ and for a Boolean function f we have $(f^*)^* = f$. The following well-known theorem shows that the dual of Boolean formulae and Boolean functions fit together. We omit the easy proof by induction here, it can be found e.g. in [Her20] (Thm. 2.1.31).

Theorem 2.8. *For some $n \in \mathbb{N}$, let ϕ be an n -ary Boolean formula and f_ϕ its realized Boolean function. Then, ϕ^* is a realization of f_ϕ^* , i.e., $f_{\phi^*} = f_\phi^*$.* \square

We can conclude from this theorem that if ϕ and ψ are equivalent Boolean formulae then the dual formulae ϕ^* and ψ^* are also equivalent. To see this note that if ϕ and ψ realize a function f then by Theorem 2.8 both ϕ^* and ψ^* realize f^* . Hence, they are equivalent.

2.2 Circuits

Circuits model the physical implementation of Boolean functions on a computer chip, where devices computing elementary Boolean functions are combined in order to realize more complex functions.

Definition 2.9. A **basis** is a set Ω of Boolean formulae. Each element $\phi \in \Omega$ is called **gate**.

Definition 2.10. A **circuit** $C = (\mathcal{V}, \mathcal{E})$ over the basis Ω is an acyclic directed graph with labeled vertices $\mathcal{V} = \mathcal{I} \cup \mathcal{G}$ such that the following conditions hold:

- Each vertex $v \in \mathcal{I}$ fulfills $\delta^-(v) = \emptyset$ and $\delta^+(v) \neq \emptyset$ and is labeled either with a distinct Boolean variable x_v or with a symbol 0 or 1. The vertices in \mathcal{I} are called **inputs** of C .
- Each vertex $v \in \mathcal{G}$ fulfills $k := |\delta^-(v)| \geq 1$ and is labeled with a k -ary gate $\phi \in \Omega$ together with a fixed ordering v_0, \dots, v_{k-1} of the predecessors of v . The vertices in \mathcal{G} are called **gates** of C . The **gate type** $\phi \in \Omega$ of v is denoted by $\text{gt}(v) := \phi$.
- There is a non-empty subset $\mathcal{O} \subseteq \mathcal{V}$ whose elements are called **outputs** of C . Every vertex $v \in \mathcal{V}$ with $\delta^+(v) = \emptyset$ is an output, but there may also be other outputs.

Given a circuit C , we write $\mathcal{V}(C), \mathcal{E}(C), \mathcal{I}(C), \mathcal{G}(C), \mathcal{O}(C)$ for its vertices, edges, inputs, gates, and outputs, respectively. If the circuit is clear from the context, we may omit the specifying appendage (C) .

Definition 2.11. Given a circuit C over a basis Ω and a vertex $v \in \mathcal{V}$, we call ϕ_v the **Boolean formula corresponding to v** and define it recursively as follows:

- If $v \in \mathcal{I}$, then $\phi_v = x_v$.
- If $v \in \mathcal{G}$, let $\phi = \text{gt}(v)$ and let v_0, \dots, v_{k-1} be the ordered predecessors of v . Then $\phi_v = \phi(\phi_{v_0}, \dots, \phi_{v_{k-1}})$.

Note that ϕ_v is a Boolean formula on the input variables $(x_v)_{v \in \mathcal{I}}$. If $|\mathcal{O}(C)| = 1$, then $\text{out}(C)$ denotes the unique output of C and $\phi_C := \phi_{\text{out}(C)}$ is called the **Boolean formula corresponding to the circuit C** . We then call $f_C := f_{\phi_C}$ the **Boolean function realized (or, computed) by C** .

The bases considered in this paper consist only of the elementary Boolean formulae AND, OR, and NOT.

Definition 2.12. The basis $\Omega_{\text{mon}} := \{\wedge, \vee\}$ is called the **standard monotone basis**. The basis $\Omega_{\text{nmon}} := \{\wedge, \vee, \neg\}$ is called the **standard non-monotone basis**. A circuit is called **monotone** if each gate is labeled with a monotone Boolean formula. A circuit is called **binary** if each gate has an arity of at most 2.

Since every (monotone) Boolean function has a realizing (monotone) Boolean formula (Lemma 2.5) and every (monotone) Boolean formula can be represented by a (monotone) circuit over Ω_{nmon} (Ω_{mon}), we can conclude that for every (monotone) Boolean function $f : \{0, 1\}^n \rightarrow \{0, 1\}$, there is a (monotone) circuit over Ω_{nmon} (Ω_{mon}) realizing f . Each circuit with exactly one output corresponds to a unique Boolean function. However, there might be several circuits corresponding to the same Boolean function. Two circuits realizing the same Boolean function are called **equivalent**.

There is a canonical way to represent a Boolean formula by a unique circuit such that each gate realizes exactly one of the symbols “ \wedge ”, “ \vee ” and “ \neg ” of the formula. Such a circuit is called a **formula circuit**. It is easy to see that a circuit is a formula circuit if and only if each gate has out-degree at most 1.

We say that a circuit C **depends essentially** on an input x_i , if f_{C_v} depends essentially on x_i for some output vertex $v \in \mathcal{O}(C)$.

We can also consider duality in the context of circuits. Given a circuit C , the dual circuit C^* arises from C by interchanging all AND- and OR-gates and all 0 and 1 symbols. This is compatible to duality in the context of Boolean functions and formulae, i.e. for any circuit C , we have $\phi_{C^*} = \phi_C^*$ and $f_{C^*} = f_C^*$. Moreover, for any Boolean function ϕ , we have $C_{\phi^*} = C_\phi^*$ (see e.g. Thm. 2.2.11 in [Her20] for the easy proof of this statement).

2.3 Optimization Problems

In this section, we will introduce a number of quality measures of circuits.

A natural measure for the ‘speed’ of a circuit in a computer chip is the maximum number of gates which an input has to travel through until an output is reached, i.e., the depth of the circuit.

Definition 2.13. Consider the circuit C . The **depth** of a vertex $v \in \mathcal{V}$ is defined by

$$d(v) := \max\{|\mathcal{E}(P)| : P \text{ directed path in } C \text{ ending in } v\}.$$

The **depth** of C is the maximum depth of any vertex in C and is denoted by $d(C)$.

However, it can not be assumed that all input signals of a circuit in a chip are accessible simultaneously. Some may have to be waited for, while others may already traverse through the circuit. This is, in particular, the case when circuits are embedded into other, more-complex circuits. For example, adder circuits, which we will define precisely in Section 2.4, are often used inside of multipliers which multiply binary numbers. The most common techniques involve the computation of partial products which are then summed up by adder circuits to produce the final product (see, e.g., [Ok194] and [Zim98]).

The problem of non-simultaneous accessibility of the inputs motivates the introduction of arrival times.

Definition 2.14. Consider a circuit with inputs x_0, \dots, x_{n-1} . For each input x_i let a number $a(x_i) \in \mathbb{R}$ be given for $i \in \{0, \dots, n-1\}$. The numbers $a(x_0), \dots, a(x_{n-1})$ are the **arrival times** of x_0, \dots, x_{n-1} . We define the **arrival time** of any gate $v \in \mathcal{G}$ recursively by

$$a(v) := \max_{w \in \delta^-(v)} \{a(w)\} + 1.$$

Then the **delay** of C with respect to the arrival times $a : \mathcal{I} \rightarrow \mathbb{R}$ is defined as the maximum arrival time of any output of C , i.e.

$$\text{del}(C; a) := \max_{v \in \mathcal{O}} a(v).$$

When the arrival times are clear from the context, we also write $\text{del}(C) := \text{del}(C; a)$.

Note that the depth is a special case of the delay where the arrival times of the inputs are all 0.

Since signals in a computer chip slow down when they are distributed too often, there is another measuring unit that has to be considered in order to predict the speed of a circuit.

Definition 2.15. Given a circuit C and a vertex $v \in \mathcal{V}$, the **fanout** of v is defined by $\text{fanout}(v) := |\delta^+(v)|$. The **fanout** of C is the maximum fanout of any vertex in C and is denoted by $\text{fanout}(C)$.

Besides of the speed, the size of a circuit is also a very important factor in chip design. It controls not only the actual size of the circuit in the chip but also the power consumption and the production cost of the chip.

Definition 2.16. Given a circuit C , the **size** of C is the number of gates in C and is denoted by $s(C)$.

Example 2.17. Figure 1 shows three circuits realizing the Boolean function given by the Boolean formula $\phi((x_0, x_1, x_2, x_3)) = ((x_0 \wedge x_1) \wedge x_2) \vee ((x_1 \wedge x_2) \vee x_3)$. In pictures of circuits, we always draw a circuit from top to bottom omitting the edge directions of the directed graph. Inputs are drawn at the top. In this figure, the AND gates are shown in red and the OR gates in green. In further figures, the color of the gates types might vary but the shapes are fixed. We assume that we are given arrival times (shown in blue). All three circuits have the same depth and the same fanout (though C_3 is the only one with a fanout of 2 for a gate). With respect to the delay, we see that circuits C_2 and C_3 are faster with a delay of 7, compared to C_1 , which has a delay of 8. In terms of size, C_3 outperforms the other two circuits with a size of 4, compared to 5 for C_1 and C_2 .

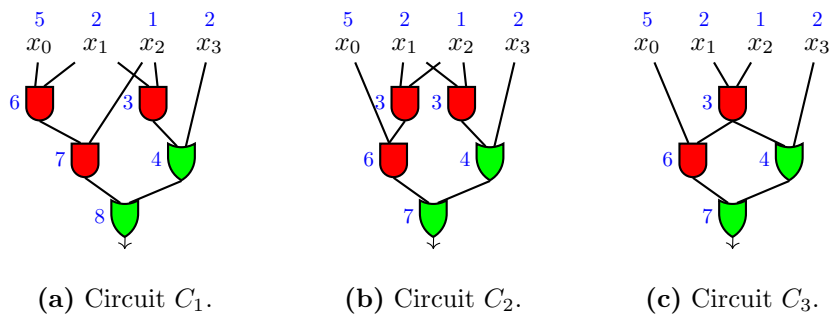

Figure 1: Circuits realizing $((x_0 \wedge x_1) \wedge x_2) \vee ((x_1 \wedge x_2) \vee x_3)$ from Example 2.17 with arrival times in blue.

It is easy to see that all introduced quality measures are invariant under dualization, i.e., for a circuit C with arrival times $a : \mathcal{I} \rightarrow \mathbb{R}$, we have $d(C^*) = d(C)$, $\text{del}(C^*) = \text{del}(C)$, $\text{fanout}(C^*) = \text{fanout}(C)$ and $s(C^*) = s(C)$.

Our main focus is minimizing the delay of a circuit, i.e., solving the following problem.

CIRCUIT DELAY OPTIMIZATION PROBLEM

Instance: A Boolean function $f : \{0,1\}^n \rightarrow \{0,1\}$ on inputs $x = (x_0, \dots, x_{n-1})$, arrival times $a(x_0), \dots, a(x_{n-1}) \in \mathbb{R}$, and a basis Ω .

Task: Compute a circuit over Ω realizing $f(x)$ with minimum possible delay.

Proposition 2.18. *The CIRCUIT DELAY OPTIMIZATION PROBLEM is NP-hard.*

Proof. We reduce the NP-hard SATISFIABILITY PROBLEM to the CIRCUIT DELAY OPTIMIZATION PROBLEM. Let a Boolean formula $\phi(x)$ on the input variables $x = (x_0, \dots, x_{n-1})$ be given and set $a(x_0) = \dots = a(x_{n-1}) = 0$. Then ϕ is not satisfiable if and only if $f_\phi(\alpha) = 0$ for all $\alpha \in \{0, 1\}^n$. Hence, ϕ is satisfiable if and only if a delay minimum circuit C realizing f_ϕ fulfills $C \neq 0$, i.e., the circuit whose only output vertex is the constant 0. \square

Note that we have proven NP-hardness of the problem even for the special case of depth optimization.

In order to check the quality of a circuit, we need lower bounds for the delay of an optimal solution for the problem. The next theorem provides such a lower bound. It is a specialization of a result by Golubic [Gol76] who gave a lower bound for the delay of any circuit whose basis contains only Boolean formulae constant arity.

Theorem 2.19 (Cf. Golubic [Gol76]). *Consider a monotone Boolean function $f : \{0, 1\}^n \rightarrow \{0, 1\}$ on inputs x_0, \dots, x_{n-1} with arrival times $a(x_0), \dots, a(x_{n-1}) \in \mathbb{N}$. Assume that f depends essentially on all its inputs. Then for any circuit C over Ω_{mon} computing f , we have*

$$\text{del}(C) \geq \left\lceil \log_2 \left(\sum_{i=0}^{n-1} 2^{a(x_i)} \right) \right\rceil. \quad \square$$

For a proof of this theorem, we refer to Golubic [Gol76].

Note that if we do not assume natural numbers as arrival times, we get the slightly weaker result $\text{del}(C) \geq \log_2 \left(\sum_{i=0}^{n-1} 2^{a(x_i)} \right)$. For the special case of depth optimization, Theorem 2.19 implies $d(C) \geq \lceil \log_2 n \rceil$. The theorem motivates the following definition that will be used often for delay bounds of a circuit.

Definition 2.20. The **weight** of inputs $x = (x_0, \dots, x_{n-1})$ with arrival times $a(x_0), \dots, a(x_{n-1}) \in \mathbb{R}$ is defined by

$$W(x; a) := \sum_{i=0}^{n-1} 2^{a(x_i)}.$$

When the inputs and their arrival times are clear from the context, we may write $W := W(x; a)$. Given a subset $P \subseteq \{x_0, \dots, x_{n-1}\}$ of the inputs, we write $W_P := W_P(x, a) := \sum_{x_i \in P} 2^{a(x_i)}$.

2.4 Adder Circuits

In this section, we finally introduce binary addition formally and reduce it to solving special kinds of circuits. We want to construct circuits for computing the **summation function** $s_n : \{0, 1\}^{2n} \rightarrow \{0, 1\}^{n+1}$ for adding two n -bit binary numbers (with $n \in \mathbb{N}$). This means for $a = (a_0, \dots, a_{n-1})$ and $b = (b_0, \dots, b_{n-1})$ we want to compute an $(n+1)$ -bit binary number $s_n((a, b))$ encoding $\sum_{i=0}^{n-1} (a_i + b_i)2^i$. The sum of two given binary numbers can be easily computed via carry bits.

Definition 2.21. Let $n \in \mathbb{N}$ and let $a = (a_0, \dots, a_{n-1})$ and $b = (b_0, \dots, b_{n-1})$ be two binary numbers with most significant bit $n-1$. For $i \in \{0, \dots, n-1\}$, we define the i -th **generate signal** for a and b as $g_i := a_i \wedge b_i$ and the i -th **propagate signal** for a and b as $p_i := a_i \oplus b_i$, where $\oplus : \{0, 1\}^2 \rightarrow \{0, 1\}$ is the **Xor function**, i.e. $x_0 \oplus x_1$ is 1 if and only if exactly one of x_0 and x_1 is 1. The **carry bits** c_0, \dots, c_n are defined recursively

$$\begin{aligned} c_0 &= 0, \\ c_{i+1} &= g_i \vee (p_i \wedge c_i) \end{aligned}$$

for $i \in \{0, \dots, n-1\}$.

Hence, we have a $c_{i+1} = 1$ for some $i \in \{0, \dots, n-1\}$ if and only if one of the following statements hold:

- g_i is true, i.e., both a_i and b_i are 1 (c_{i+1} is *generated* at position i),
- $p_i \wedge c_i$ is true, i.e., exactly one of a_i and b_i is 1 and we have a carry bit at position i (c_{i+1} is *propagated* from position $i-1$).

Given the carry bits c_0, \dots, c_n corresponding to some binary numbers $a = (a_0, \dots, a_{n-1})$ and $b = (b_0, \dots, b_{n-1})$, the summation function on a and b can now be computed easily via

$$(s_n((a, b)))_i = \begin{cases} c_i \oplus (a_i \oplus b_i) = c_i \oplus p_i & \text{if } i \in \{0, \dots, n-1\}, \\ c_n & \text{if } i = n. \end{cases}$$

The computation of the generate and propagate signals of two given binary numbers as well as the computation of the summation function for given carry bits and propagate signals can be done by circuits of linear size and constant depth. Hence, computing the summation function can be reduced to solving the following problem.

ADDER OPTIMIZATION PROBLEM

Instance: $n \in \mathbb{N}$.
 Task: Construct a circuit over $\Omega_{\text{mon}} = \{\wedge, \vee\}$ on n input pairs $p_0, g_0, \dots, p_{n-1}, g_{n-1}$ computing all the carry bits c_1, \dots, c_n .

Definition 2.22. A circuit solving the ADDER OPTIMIZATION PROBLEM for a given $n \in \mathbb{N}$ is called an **adder circuit** (or, **adder**). A **family of adder circuits** is a family of circuits $(A_n)_{n \in \mathbb{N}}$ where each A_n is an adder circuit on n input pairs. Given an adder circuit A_n in n input pairs and $i \in \{1, \dots, n\}$, we denote the output of A_n computing the carry bit c_i by $\text{out}_i(A_n)$.

Note that Definition 2.21 implies that $c_1 = g_0$. Thus, an adder on input pairs $p_0, g_0, \dots, p_{n-1}, g_{n-1}$ does not depend essentially on p_0 . However, to simplify notation, we keep p_0 as part of the input. Whenever arrival times $a(p_0), a(g_0), \dots, a(p_{n-1}), a(g_{n-1}) \in \mathbb{N}$ are given, we may assume $a(p_0) = 0$.

Remark. By Definition 2.21, the carry bits can be computed via monotone Boolean formulae and implemented by circuits over $\Omega_{\text{mon}} = \{\wedge, \vee\}$. It is an open question whether the Boolean negation can help to find better adders regarding the quality measures compared to using only monotone circuits.

Each carry bit c_{i+1} can be computed by a path-like formula on the inputs $g_i, p_i, \dots, g_1, p_1, g_0$ with alternating OR and AND gates (see (1)). The problem of finding good circuits for these kinds of formulae plays a crucial role in finding good adder circuits. Our main goal is to find an adder which is almost as fast as a single AND-OR path circuit but still has (nearly) linear size. We formally define and analyze AND-OR paths in the next section.

We conclude this section by giving an example of two very basic approaches for constructing an adder circuit.

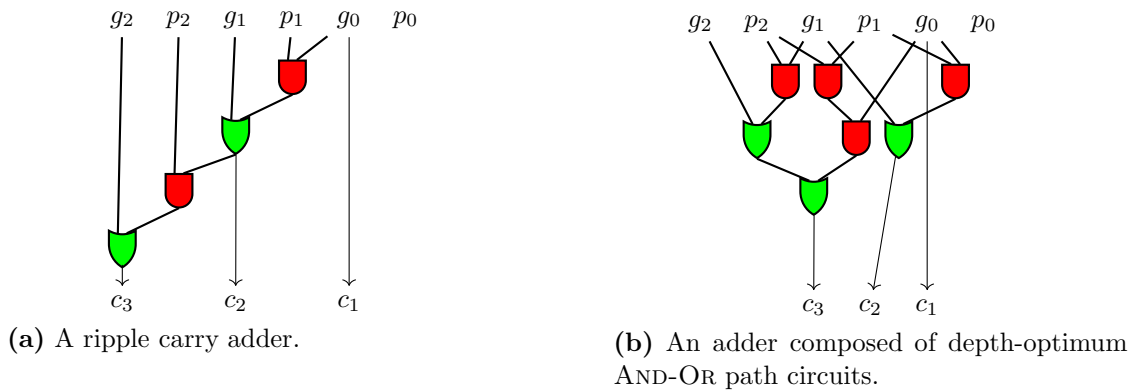

Figure 2: Two adder circuits on $n = 3$ input pairs, see Example 2.23.

Example 2.23. Figure 2 shows two different adder circuits for the inputs $p_0, g_0, p_1, g_1, p_2, g_2$. In (a), we see the so-called **ripple carry adder** which has for n input pairs a depth and a size of $2n - 2$. While the size is best possible, the linear depth is undesirable in most cases. Instead, one could use a depth-optimizing (or delay-optimizing) AND-OR path circuit AOP_i realizing Equation (1) for each carry c_i separately, and then combine the circuits AOP_1, \dots, AOP_n to receive an adder circuit. An example for such an adder circuit (optimizing depth) is given in Figure 2 (b). The depth (delay) of such an adder on n inputs would be equal to the depth (delay) of AOP_n . However, its size would be $\sum_{i=1}^n s(AOP_i)$ and, thus, at least quadratic in n since the size of a single AND-OR path circuit is at least linear in n .

2.5 And-Or Path Circuits

Definition 2.24. For Boolean input variables $x = (x_0, \dots, x_{m-1})$, we define the Boolean function $g(t)$ by

$$g(x) = \begin{cases} x_0 & m = 1, \\ x_0 \wedge x_1 & m = 2, \\ x_0 \wedge x_1 \vee (g((x_2, \dots, x_{m-1}))) & m \geq 3. \end{cases}$$

Then $g(x)$ and its dual Boolean function $g^*(x)$ are called **And-Or paths** on m inputs. We call m the **length** of the AND-OR paths $g(x)$ and $g^*(x)$.

By Theorem 2.8, we can describe $g^*(x)$ by

$$g^*(x) = \begin{cases} x_0 & m = 1, \\ x_0 \vee x_1 & m = 2, \\ x_0 \vee x_1 \wedge (g^*((x_2, \dots, x_{m-1}))) & m \geq 3 \end{cases} \quad (2)$$

for $m \in \mathbb{N}_{>0}$. Moreover, we have $g(x) = x_0 \wedge g^*((x_1, \dots, x_{m-1}))$ and $g^*(x) = x_0 \vee g((x_1, \dots, x_{m-1}))$ for $m \in \mathbb{N}_{>1}$.

Definition 2.25. A circuit realizing an AND-OR path function is called **And-Or path circuit**. A **family of And-Or path circuits** is a family of circuits $(AOP_m)_{m \in \mathbb{N}}$ where each AOP_m is an AND-OR path circuit on m inputs. Given an AND-OR path $h(x)$ (either $g(x)$, or $g^*(x)$), the Boolean formula for $h(x)$ emerging from Definition 2.24 or Equation (2) is called a **standard And-Or path realization**. The corresponding circuit is called a **standard And-Or path circuit** for $h(x)$.

In Figure 3 (a), we see a standard AND-OR path circuit.

By dualization circuits, we see that any circuit over Ω_{mon} realizing $g(x)$ for given inputs x including arrival times can be transformed into a circuit over Ω_{mon} realizing $g^*(x)$ with the same delay and size by interchanging all AND and OR gates and vice versa. Thus, the following naturally arising problem is well defined.

AND-OR PATH CIRCUIT OPTIMIZATION PROBLEM

Instance: $m \in \mathbb{N}$, Boolean input variables $x = (x_0, \dots, x_{m-1})$, arrival times $a(x_0), \dots, a(x_{m-1}) \in \mathbb{N}$.

Task: Compute a circuit over Ω_{mon} realizing $g(x)$ or $g^*(x)$ with minimum possible delay.

Remark. The AND-OR PATH CIRCUIT OPTIMIZATION PROBLEM is equivalent to finding an adder circuit with minimum delay as every adder circuit yields an AND-OR path circuit with the same delay and vice versa (see Equation (1) and Figure 2 (b)).

In Figure 2 (b), we have already seen (as a sub-circuit) a non-trivial AND-OR path circuit on 5 inputs g_0, p_1, g_1, p_2, g_2 computing the output c_3 . It is indeed an AND-OR path circuit which is verified via

$$(g_2 \vee (p_2 \wedge g_1)) \vee ((p_2 \wedge p_1) \wedge g_0) = g_2 \vee ((p_2 \wedge g_1) \vee (p_2 \wedge (p_1 \wedge g_0))) = g_2 \vee ((p_2 \wedge (g_1 \vee (p_1 \wedge g_0))).$$

Moreover, it is depth-optimum since any circuit for $g^*(x)$ on 5 inputs has a depth of at least $\lceil \log_2 5 \rceil = 3$ by Theorem 2.19 (since, obviously, an AND-OR path depends essentially on all its inputs).

We can adapt Definition 2.21 to AND-OR paths.

Definition 2.26. Let $h(x)$ be an AND-OR path ($g(x)$ or $g^*(x)$) on $m \in \mathbb{N}_{>1}$ inputs $x = (x_0, \dots, x_{m-1})$. We call an input x_i a **generate signal** (respectively, **propagate signal**) if the unique successor of x_i in the standard AND-OR path circuit for $h(x)$ is an OR gate (respectively, AND gate).

Note that the inputs of an AND-OR path, except for the last input, are alternating generate and propagate signals. The last two inputs are both generate or both propagate signals.

Notation: We define the n -ary AND function as $\bigwedge(x) = \bigwedge_{i=0}^{n-1} x_i = x_0 \wedge x_1 \wedge \dots \wedge x_{n-2} \wedge x_{n-1}$. Similarly, we define the n -ary OR function as $\bigvee(x) = \bigvee_{i=0}^{n-1} x_i = x_0 \vee x_1 \vee \dots \vee x_{n-2} \vee x_{n-1}$.

Now we can state a result that turns out to be very useful for AND-OR path optimization. Any AND-OR path can be realized by computing two shorter AND-OR paths on disjoint subsets of the inputs. We call this kind of realization an **alternating split**. This gives rise to a recursive strategy used in several different variants in the past (see, e.g., Grinchuk [Gri09]) to optimize AND-OR path circuits as well as adder circuits. The alternating split is also the basis of every adder construction described in this paper. We omit the proof of the following theorem which can be found in [Gri09], Lemma 3, or in [BH19], Lemma 2.5.

Theorem 2.27 (Alternating split. Cf. Grinchuk [Gri09]). *Let $m \in \mathbb{N}_{>1}$, input variables $x = (x_0, \dots, x_{m-1})$ and an odd integer k with $1 \leq k < m$ be given. Then, we have*

$$g^*(x) = g^*((x_0, \dots, x_{k-1})) \vee \left(\bigwedge((x_1, x_3, \dots, x_k)) \wedge g^*((x_{k+1}, \dots, x_{m-1})) \right)$$

and

$$g(x) = g((x_0, \dots, x_{k-1})) \wedge \left(\bigvee((x_1, x_3, \dots, x_k)) \vee g((x_{k+1}, \dots, x_{m-1})) \right). \quad \square$$

Though we do not give a full proof here, we sketch the idea how to prove it. Consider as an example Figure 3 which shows a circuit realizing $g^*((x_0, \dots, x_{11}))$ via the alternating split described in Theorem 2.27 for $k = 7$. The red and green gates form the sub-circuits realizing the two functions $g^*((x_0, \dots, x_6))$ and $g^*((x_8, \dots, x_{11}))$ and the sub-circuit consisting of the yellow gates realizes the function $\bigwedge((x_1, x_3, x_5, x_7))$. The two blue gates are the extra gates needed to combine these sub-circuits. To see that both circuits are equivalent check that the output of the circuit in (b) is 1 if and only if

- $g^*((x_0, \dots, x_6))$ computes 1 or
- $g^*((x_8, \dots, x_{11}))$ computes 1 and the propagating inputs $x_1, x_3, x_5,$ and x_7 are all 1.

However, it is not too difficult to see that in this case, and only in this case, the output of $g^*((x_0, \dots, x_{11}))$ is 1. This is due to the fact that the output of $g^*((x_0, \dots, x_{11}))$ is one if and only if there is a generate input x_i with value 1 for which all propagate inputs x_j with $j < i$ have value 1.

Note that the sub-circuit in Figure 2 (b) is also an example for the alternating split applied to $g^*(g_2, p_2, g_1, p_1, g_0)$ with $k = 3$.

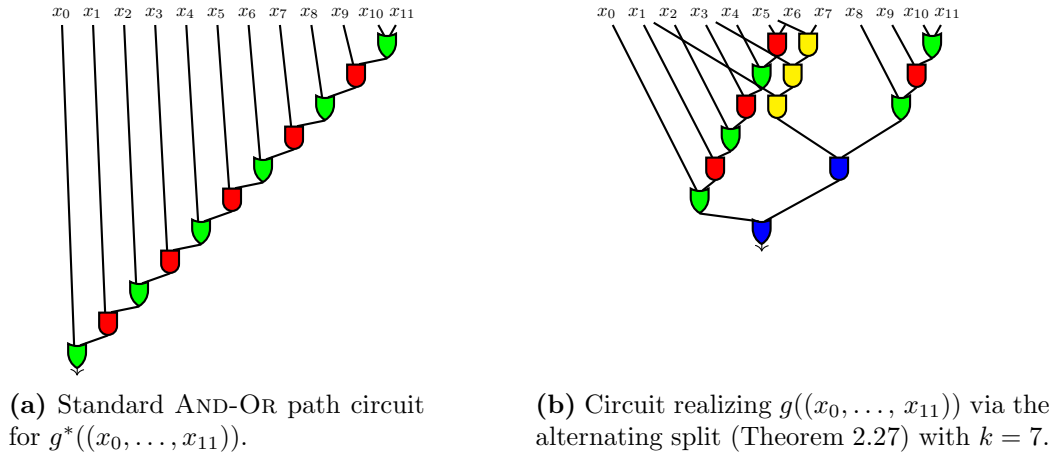

Figure 3: Visualization of the alternating split (Theorem 2.27).

We now state well-known lower bounds on the delay of AND-OR path circuits and adder circuits. The first result is implied by Theorem 2.19 and the fact that AND-OR paths depend essentially on all their inputs.

Proposition 2.28. *The delay of any AND-OR path circuit over Ω_{mon} on inputs $x = (x_0, \dots, x_{m-1})$ with arrival times $a(x_0), \dots, a(x_{m-1}) \in \mathbb{N}$ is at least $\lceil \log_2 W \rceil$, where $W := \sum_{i=0}^{m-1} 2^{a(x_i)}$. \square*

This is the best known lower bound for the delay of AND-OR path circuits and, hence, also of adder circuits.

Proposition 2.29. *The delay of any adder circuit over Ω_{mon} on the input pairs $p_0, g_0, \dots, p_{n-1}, g_{n-1}$ with arrival times $a(p_i), a(g_i) \in \mathbb{N}$ for $i \in \{0, \dots, n-1\}$ is at least $\lceil \log_2(W - 1) \rceil$, where $W := \sum_{i=0}^{n-1} (2^{p_i} + 2^{g_i})$. \square*

Proof. The delay of an adder circuit is at least the delay of an AND-OR path circuit on $(g_{n-1}, p_{n-1}, \dots, g_1, p_1, g_0)$ (see Eq. (1)), which has a delay of at least $\lceil \log_2(\sum_{i=0}^{n-1} (2^{p_i} + 2^{g_i}) - 2^0) \rceil = \lceil \log_2(W - 1) \rceil$ by Proposition 2.28. \square

2.6 Previous Work

In this section, we present some previous work on depth- and delay-optimizing adder circuits, AND-OR path circuits and AND-prefix circuits. All results presented in this section are adapted to our notation.

2.6.1 Depth-Optimizing Algorithms

Going back to the 1960s, there is a vast literature on depth-optimization of adder circuits. Here, we restrict ourselves on some more recent approaches that will be useful for our delay-optimizing adder circuits. For an overview of the historic development of adder circuits, we refer to [Spi14] and [BS24].

Hermann [Her20] constructed an adder circuit based on the recursive strategy implied by the alternating split, presented in Theorem 2.27, as follows. Given some $n \in \mathbb{N}$ and input pairs $p_0, g_0, \dots, p_{n-1}, g_{n-1}$, the inputs are split in two (almost) equal consecutive parts $P_r := (p_0, g_0, \dots, p_{s-1}, g_{s-1})$ and $P_l := (p_s, g_s, \dots, p_{n-1}, g_{n-1})$ for $s := \lceil \frac{n}{2} \rceil$. Recursively, an adder A_r (respectively, A_l) is then computed on the two halves P_r (respectively,

P_i). Then, all the carry bits c_i for $i \leq s$ are computed directly by A_r , i.e., $c_i = \text{out}_i(A_r)$. The other carry bits are now computed as follows. Equation (1) implies that any carry bit c_{i+1} is given by $c_{i+1} = g^*((g_i, p_i, \dots, g_1, p_1, g_0))$. Theorem 2.27 with $k = 2(i - s) + 1$ implies that

$$c_{i+1} = g^*((g_i, p_i, \dots, g_{s+1}, p_{s+1}, g_s)) \vee \left(\bigwedge((p_s, \dots, p_i)) \wedge g^*((g_{s-1}, p_{s-1}, \dots, g_1, p_1, g_0)) \right) \quad (3)$$

for all $s \leq i \leq n$. The term $g^*((g_i, p_i, \dots, g_{s+1}, p_{s+1}, g_s))$ in (3) is given by the adder A_i for each $s \leq i \leq n$, i.e., $g^*((g_i, p_i, \dots, g_{s+1}, p_{s+1}, g_s)) = \text{out}_{i-s+1}(A_i)$. Hence, the addition is reduced to computing the single AND-OR path $g^*((g_{s-1}, p_{s-1}, \dots, g_1, p_1, g_0))$ as well as the $(i - s + 1)$ -ary AND function $\bigwedge((p_s, \dots, p_i))$ for all $s \leq i \leq n$.

We formalize the latter problem in a more general way.

PARALLEL AND-PREFIX PROBLEM

Instance: $n \in \mathbb{N}$.

Task: Construct a circuit over $\Omega = \{\wedge\}$ on inputs x_0, \dots, x_{n-1} computing the AND-prefixes $x_i \wedge x_{i-1} \wedge \dots \wedge x_0$ for all $i = 0, \dots, n - 1$.

Definition 2.30. A circuit solving the PARALLEL AND-PREFIX PROBLEM is called **And-prefix circuit**. A **family of And-prefix circuits** is a family of circuits $(S_n)_{n \in \mathbb{N}}$ where each S_n is an AND-prefix circuit on n inputs. Given an AND-prefix circuit S_n on n inputs and $i \in \{1, \dots, n\}$, we denote the output of $x_{i-1} \wedge \dots \wedge x_0$ by $\text{out}_i(S_n)$.

There have been several works dedicated to the PARALLEL AND-PREFIX PROBLEM. The first construction combining an optimal depth and a linear size was made by Ladner and Fischer [LF80].

Theorem 2.31 (Ladner and Fischer [LF80]). *For any $n \in \mathbb{N}_{>0}$ and any constant $0 \leq f \leq \lceil \log_2 n \rceil$, one can construct in polynomial time an AND-prefix circuit S_n^f on n inputs with depth*

$$d(S_n^f) \leq \lceil \log_2 n \rceil + f$$

and size

$$s(S_n^f) \leq 2(1 + 2^{-f})n.$$

Note that the depth of this construction is optimal for $f = 0$ due to Theorem 2.19.

The circuit from Theorem 2.31 was used to compute the terms $\bigwedge((p_s, \dots, p_i))$ in (3) for all $s \leq i \leq n$, and a circuit for the AND-OR path $g^*((g_{s-1}, p_{s-1}, \dots, g_1, p_1, g_0))$ in (3) was provided in [BS24].

Theorem 2.32 (Brenner and Silvanus [BS24]). *For any $m \in \mathbb{N}_{\geq 2}$, one can construct in running time $\mathcal{O}(m \log_2 m)$ an AND-OR path circuit AOP_m on m inputs with depth*

$$d(AOP_m) \leq \log_2 m + \log_2 \log_2 m + 0.65$$

and size

$$s(AOP_m) \leq 3.67m - 2.$$

These AND-OR path circuits are the best known regarding the depth. The following result of Commentz-Walter [CW79] even shows that the circuits from Theorem 2.32 are optimal in depth up to an additive constant.

Theorem 2.33 (Cf. Commentz-Walter [CW79]). *There is some $\alpha \in \mathbb{R}$ and some $N_\alpha \in \mathbb{N}$ such that for all $n \geq N_\alpha$, any circuit C over Ω_{mon} for $g((x_0, \dots, x_{2n-1}))$ fulfills*

$$d(C) \geq \log_2 n + \log_2 \log_2 n + \alpha.$$

Remark. Hitschke [Hit18] showed that the constant α in the previous theorem can be chosen arbitrarily close to -4 , asymptotically. For example, a lower bound of $\log_2 n + \log_2 \log_2 n - 4.01$ was shown for all $n \geq N_{-4.01} = 2^{2^{18}}$.

Using the AND-OR path circuit from Theorem 2.32 and the AND-prefix circuit by Ladner and Fischer (Theorem 2.31) as sub-circuits in Formula (3), Brenner and Silvanus [BS24] achieved an adder with a sub-quadratic size whose depth is only by 2 larger than the depth of the AND-OR path circuit from Theorem 2.32.

Theorem 2.34 (Brenner and Silvanus [BS24]). *For any $n \in \mathbb{N}_{\geq 3}$, one can construct in running time $\mathcal{O}(n \log_2^2 n)$ an adder circuit A_n on n input pairs with depth*

$$d(A_n) \leq \log_2 n + \log_2 \log_2 n + 2.65$$

and size

$$s(A_n) \leq 6.2n \log_2 n.$$

Figure 4 illustrates the adder construction of Theorem 2.34 for 6 input pairs. The recursively constructed adders on P_l and P_r as well as the AND-OR path circuit from Theorem 2.32 on P_r are indicated with red (AND) and green (OR) gates. The yellow gates represent the AND-prefix circuit by Ladner and Fischer (Theorem 2.31). Each of these sub-circuits are indicated by a trivial implementation. The blue gates are the extra gates introduced in Equation (3) (two gates for each carry bit c_4, c_5, c_6).

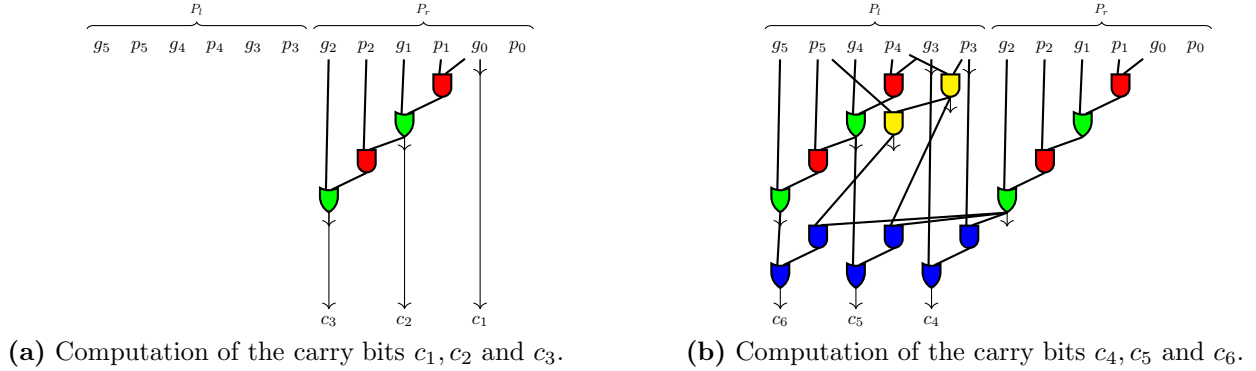

Figure 4: Visualization of the adder construction of Theorem 2.34 on 6 input pairs.

The depth of the adder from Theorem 2.32 is optimal up to a constant by Theorem 2.33 and it has a sub-quadratic size. To achieve linear size, Brenner and Silvanus [BS24] developed a framework that linearizes given adders with a sub-quadratic size such that the depth does not increase much. Since we use this framework in our approach to linearize delay-optimizing adders, we will present it in more detail in Section 5.1. Using their linearization framework, Brenner and Silvanus [BS24] constructed the following two linear size adder circuits, for which the depth increased only by an additive term of size $\log_2 \log_2 \log_2 n + \text{const}$.

Theorem 2.35 (Brenner and Silvanus [BS24]). *For any $n \in \mathbb{N}_{\geq 4}$, one can construct in running time $\mathcal{O}(n \log_2 \log_2 n)$ an adder circuit A_n on n input pairs with depth*

$$d(A_n) \leq \log_2 n + \log_2 \log_2 n + \log_2 \log_2 \log_2 n + 6.6$$

and size

$$s(A_n) \leq 21.6n.$$

Theorem 2.36 (Brenner and Silvanus [BS24]). *For any $n \in \mathbb{N}_{\geq 4}$, one can construct in running time $\mathcal{O}(n \log_2 \log_2 n)$ an adder circuit A_n on n input pairs with depth*

$$d(A_n) \leq \log_2 n + \log_2 \log_2 n + \log_2 \log_2 \log_2 n + 7.6$$

and size

$$s(A_n) \leq 16.7n.$$

2.6.2 Delay-Optimizing Algorithms

The asymptotically best delay bound of a linear size adder circuit was provided by Spirkel [Spi14] (Corollary 3.38) who claimed a delay bound of order $\lceil \log_2 W \rceil + \mathcal{O}(\sqrt{\log_2 n})$ and a linear size.

Using a similar adder construction as described in the previous section, we hope to achieve a significantly better delay bound and a sub-quadratic size making use of fast AND-OR path circuits and AND-prefix circuits. Brenner and Hermann [BH19] constructed the AND-OR path circuit with the best known delay. The size of their circuit was proven by Hermann [Her20] to be in $\mathcal{O}(n \log_2 n)$.

Theorem 2.37 ([BH19] and [Her20] (Thm. 4.3.4)). *Let $m \in \mathbb{N}$ with $m \geq 3$, Boolean variables $x = (x_0, \dots, x_{m-1})$ and arrival times $a(x_0), \dots, a(x_{m-1}) \in \mathbb{N}$ be given. Let $W = \sum_{i=0}^{m-1} 2^{a(x_i)}$. One can construct in running time $\mathcal{O}(m \log_2^2 m)$ an AND-OR-path circuit AOP on x with delay*

$$\text{del}(AOP) \leq \log_2 W + \log_2 \log_2 m + \log_2 \log_2 \log_2 m + 4.3,$$

size

$$s(AOP) \leq m(\log_2 m + \log_2 \log_2 m + \log_2 \log_2 \log_2 m + 3.3) - 1$$

and fanout

$$\text{fanout}(AOP) \leq \log_2 m + \log_2 \log_2 m + \log_2 \log_2 \log_2 m + 3.3.$$

Remark. Computing each carry bit separately with these AND-OR path circuits as in Figure 2 (b) yields the best delay guarantee known of $\log_2 W + \log_2 \log_2(2n - 1) + \log_2 \log_2 \log_2(2n - 1) + 4.3$ for an adder on n input pairs with weight W . However, its size would be at least quadratic and, thus, it would be unsuitable in practice.

The best AND-OR path circuit regarding delay with a linear size was provided by Spirkel [Spi14]. For given input pairs $p_0, g_0, \dots, p_{n-1}, g_{n-1}$ with arrival times $a(p_0), a(g_0), \dots, a(p_{n-1}), a(g_{n-1}) \in \mathbb{N}$ such that $a(p_i) = a(g_i)$ for all $i \in \{0, \dots, n\}$, Spirkel claimed that the carry bit c_n can be computed by a circuit with delay at most $\log_2 V + 2\sqrt{2\log_2 n} + 6$, size at most $6n - 6$ and fanout at most $2\sqrt{2\log_2 n} + 1$, where $V = \sum_{i=0}^{n-1} 2^{a(p_i)}$. Hence, the circuit computes an AND-OR path of length $2n - 1$. For arbitrary inputs x_0, \dots, x_{m-1} with arbitrary arrival times $a(x_0), \dots, a(x_{m-1})$ and weight $W = \sum_{i=0}^{m-1} 2^{a(x_i)}$, we can use Spirkel's result with $V = W$, $n = \frac{m+1}{2}$ for odd m and $n = \frac{m}{2} + 1$ for even m using an artificial input. We get the following result.

Theorem 2.38 (Spirkel [Spi14] (Thm. 2.26)). *Let $m \in \mathbb{N}$ with $m \geq 3$, Boolean variables $x = (x_0, \dots, x_{m-1})$ and arrival times $a(x_0), \dots, a(x_{m-1}) \in \mathbb{N}$ be given. Let $W = \sum_{i=0}^{m-1} 2^{a(x_i)}$ be the weight of the inputs. We can construct in polynomial time an AND-OR-path circuit AOP on x with delay*

$$\text{del}(AOP) \leq \log_2 W + 2\sqrt{2\log_2 m} + 6,$$

size

$$s(AOP) \leq 3m$$

and fanout

$$\text{fanout}(AOP) \leq 2\sqrt{2\log_2 m} + 1.$$

We still need an AND-prefix circuit guaranteeing a good delay in order to attempt an adder construction. The best known AND-prefix circuit regarding the delay is given by Rautenbach, Szegedy and Werber [RSW07]. They addressed the PARALLEL PREFIX PROBLEM, which is the PARALLEL AND-PREFIX PROBLEM for an arbitrary, associative, binary operator $\circ : \{0, 1\} \times \{0, 1\} \rightarrow \{0, 1\}$.

Theorem 2.39 (Rautenbach, Szegedy, Werber [RSW07] (Thm. 2)). *Let $\circ : \{0, 1\} \times \{0, 1\} \rightarrow \{0, 1\}$ be an associative operator. Let $m \in \mathbb{N}$ with $m \geq 3$, Boolean variables x_0, \dots, x_{m-1} and arrival times $a(x_0), \dots, a(x_{m-1}) \in \mathbb{N}$ be given and let $W = \sum_{i=0}^{m-1} 2^{a(x_i)}$. The PARALLEL PREFIX PROBLEM can be solved in polynomial runtime by a circuit S_n over the basis $\{\circ\}$ with delay*

$$\text{del}(S_n) \leq \log_2(W) + 3\log_2 \log_2 m + \mathcal{O}(1)$$

and size

$$s(S_n) \in \mathcal{O}(m \log_2 \log_2 m).$$

Thus, there are constants $c_d, c_s \in \mathbb{R}$ such that the circuits from the theorem above have a delay of at most $\log_2(W) + 3\log_2 \log_2 m + c_d$ and a size of at most $c_s m \log_2 \log_2 m$. However, these constants were not specified in [RSW07]. Without concrete values for these constants we would not be able to compute concrete delay and size bounds for our adders. Hence, we will compute upper bounds for c_d and c_s in Section 3.

For some sub-circuits used during our adder constructions, we do not need the best possible asymptotic delay bounds but rather rely on smaller sizes. This may be the case for small instances or for our construction of a linear size adder in Section 5.3. For these cases, we capture some delay bounds of depth-minimizing circuits presented in Section 2.6.1.

Corollary 2.40. *Assume that we are given arrival times $a(p_0), a(g_0), \dots, a(p_{n-1}), a(g_{n-1}) \in \mathbb{N}$ to our inputs. Let $W = \sum_{i=0}^{n-1} (2^{a(p_i)} + 2^{a(g_i)})$. Then, the following statements hold.*

- (a) *The circuit A_n from Theorem 2.34 has delay of at most $\log_2 W + \log_2 n + \log_2 \log_2 n + 2.65$.*
- (b) *The circuit A_n from Theorem 2.35 has delay of at most $\log_2 W + \log_2 n + \log_2 \log_2 n + \log_2 \log_2 \log_2 n + 6.6$.*
- (c) *The circuit A_n from Theorem 2.36 has delay of at most $\log_2 W + \log_2 n + \log_2 \log_2 n + \log_2 \log_2 \log_2 n + 7.6$.*

Proof. In all cases, we can observe that

$$\text{del}(A_n) \leq \max\{a(p_i), a(g_i); 0 \leq i \leq n-1\} + d(A_n).$$

The results follow from the depth bound of A_n , stated in Theorem 2.34, Theorem 2.35, and Theorem 2.36, and the fact that

$$\max\{a(p_i), a(g_i); 0 \leq i \leq n-1\} \leq \log_2 W. \quad \square$$

The results of the next corollary can be proven analogously.

Corollary 2.41. *Assume that we are given arrival times $a(x_0), \dots, a(x_{n-1}) \in \mathbb{N}$ to our inputs. Let $W = \sum_{i=0}^{n-1} 2^{a(x_i)}$. Then, the following statements hold.*

- (a) *The circuit S_n from Theorem 2.31 has delay at most $\log_2 W + \lceil \log_2 n \rceil + f$.*
- (b) *The circuit AOP_m from Theorem 2.32 has delay at most $\log_2 W + \log_2 m + \log_2 \log_2 m + 0.65$.*

3 Analysis of an And-Prefix Circuit

In this section, we compute concrete constants for the delay and size bounds of the circuit constructed by Rautenbach, Szegedy and Werber [RSW07] for the PARALLEL PREFIX PROBLEM (see Theorem 2.39). For this we need to take a closer look at their circuit construction which we describe in our own notation in the following.

Let $S(t_0, \dots, t_{n-1})$ denote a circuit over the basis $\{\circ\}$ that solves the prefix problem on n inputs $x = (x_0, x_1, \dots, x_{n-1})$ with arrival times $t_0, \dots, t_{n-1} \in \mathbb{N}$ for some associative operator $\circ : \{0, 1\} \times \{0, 1\} \rightarrow \{0, 1\}$. The construction of $S(t_0, \dots, t_{n-1})$ is then done as follows:

For $n = 1$ the circuit $S(t_0)$ consists of the input vertex x_0 .

For $n \geq 2$ we apply the following steps.

1. Partition the set $\{0, 1, \dots, n-1\}$ into $l := \lceil \sqrt{n} \rceil$ sets

$$\begin{aligned} P^{(1)} &= \{0, 1, \dots, n_1 - 1\}, \\ P^{(2)} &= \{(n_1), (n_1 + 1), \dots, (n_1 + n_2 - 1)\}, \\ &\dots, \\ P^{(l)} &= \{(n_1 + n_2 + \dots + n_{l-1}), (n_1 + n_2 + \dots + n_{l-1} + 1), \dots, (n_1 + n_2 + \dots + n_l - 1)\} \end{aligned}$$

such that $n_1 \geq n_2 \geq \dots \geq n_l$ and $n_1 - n_l \leq 1$.

2. For $1 \leq i \leq l$ we use the following dynamic programming approach to construct a circuit C_i over the basis $\{\circ\}$ calculating $y_i := \circ_{j \in P^{(i)}} x_j$: In what follows, C_{j_1, j_2} will denote a circuit calculating

$$\circ_{j=j_1}^{j_2} x_{(n_1+n_2+\dots+n_{i-1}+j)}$$

for $0 \leq j_1 \leq j_2 \leq n_i - 1$. If $j_1 = j_2$, then C_{j_1, j_2} consists only of the corresponding input vertex.

If $j_1 < j_2$, we recursively construct C_{j_1, j_2} using one \circ -gate joining the outputs of two circuits $C_{j_1, k}$ and C_{k+1, j_2} such that $\max\{\text{del}(C_{j_1, k}), \text{del}(C_{k+1, j_2})\}$ is minimized.

Let $C_i = C_{0, n_i - 1}$.

3. For $1 \leq i \leq l$, we recursively construct

$$S(t_{(n_1+n_2+\dots+n_{i-1})}, \dots, t_{(n_1+n_2+\dots+n_{i-2})})$$

and use these circuits to calculate all $n_i - 1$ prefixes on the inputs x_j for $j \in P^{(i)} \setminus \{n_1 + n_2 + \dots + n_i - 1\}$.

4. We construct $S(t(y_1), t(y_2), \dots, t(y_{l-1}))$ to calculate all $(l-1)$ prefixes on the inputs y_j with their arrival times $t(y_j)$ for $1 \leq j \leq l-1$ calculated by the circuits constructed in Step 2.

5. For $2 \leq i \leq l$ and $j \in P^{(i)} \setminus \{n_1 + n_2 + \dots + n_i - 1\}$ we join the output $(y_1 \circ y_2 \circ \dots \circ y_{i-1})$ of the circuit constructed in Step 4 with the output $\circ_{\substack{k \in P^{(i)} \\ k \leq j}} x_k$ of the circuit constructed in Step 3 using one \circ -gate calculating

$$\circ_{k=0}^{j-1} x_k = (y_1 \circ y_2 \circ \dots \circ y_{i-1}) \circ \left(\circ_{\substack{k \in P^{(i)} \\ k < j}} x_k \right).$$

6. Finally, we join the output $(y_1 \circ y_2 \circ \dots \circ y_{l-1})$ of the circuit constructed in Step 4 with the output y_l of the circuit constructed in Step 2 using one \circ -gate which calculates $\circ_{i=0}^{n-1} x_i$.

Rautenbach, Szegedy and Werber derived recursion formulas for the delay and size of the circuits resulting from this algorithm. For $n \in \mathbb{N}_{\geq 1}$ let $s(n)$ denote the maximum size and $\text{del}(W, n)$ denote the maximum delay of a circuit $S(t_0, \dots, t_{n-1})$ for arrival times $t_0, \dots, t_{n-1} \in \mathbb{N}$ and $W = \sum_{i=0}^{n-1} 2^{t_i}$.

Lemma 3.1 (Rautenbach, Szegedy, Werber [RSW07] (Lem. 2)). *For $n \in \mathbb{N}_{\geq 3}$ we have the recursions*

$$s(n) \leq (\lceil \sqrt{n} \rceil + 1) s(\lceil \sqrt{n} \rceil - 1) + 2(n - \lceil \sqrt{n} \rceil)$$

and

$$\text{del}(W, n) \leq \text{del}(4W, \lceil \sqrt{n} \rceil - 1) + 1. \quad \square$$

Using these recursion formulas, Rautenbach, Szegedy and Werber showed that there are constants $c_d, c_s \in \mathbb{R}$ such that $\text{del}(W, n) \leq \log_2 W + 3 \log_2 \log_2 n + c_d$ and $s(n) \leq c_s n \log_2 \log_2 n$.

Note that the fanout of the constructed circuit, in particular of the nodes $y_1 \circ \dots \circ y_i$ for $1 \leq i \leq l-1$, is in $\mathcal{O}(\sqrt{n})$ due to Step 5 of the construction. Rautenbach, Szegedy and Werber [RSW07] also developed a modified circuit with a fanout of 2 and a delay of at most $\log_2 W + \log_2 n + 7 \log_2 \log_2 n + \mathcal{O}(1)$. Since our main objective is the delay-optimization combined with the size reduction of adders, we only focus on the delay-optimizing construction given above and disregard the high fanout.

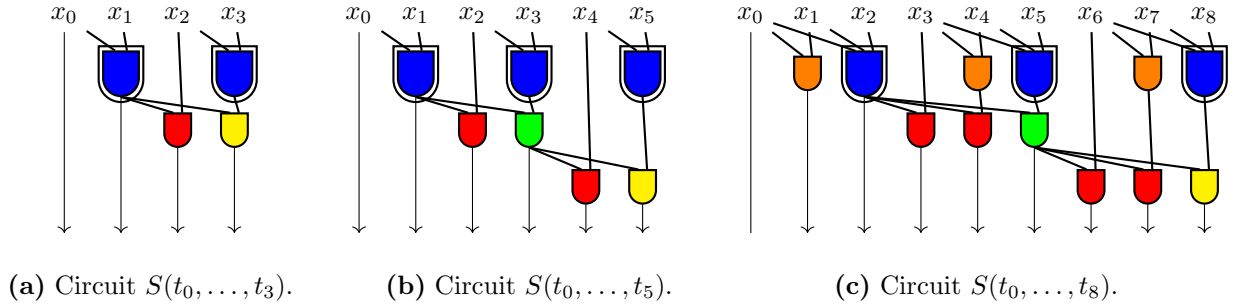

Figure 5: $S(t_0, \dots, t_{n-1})$ for $n = 4, 6$ and 9 .

In order to derive concrete bounds for the constants c_d and c_s , we first need to analyse the algorithm on small instances. Figure 5 shows the prefix circuits $S(t_0, \dots, t_{n-1})$ computed via the construction by Rautenbach, Szegedy and Werber for $n = 4, 6$ and 9 . The blue symbols represent the circuits C_i computed in Step 2 of the construction. In the cases $n = 4$ and $n = 6$ they just consist of one \circ -gate. In the case $n = 9$ they are circuits of size and depth 2. The orange symbols represent the gates constructed during the recursive calls at Step 3 of the algorithm. The green symbols are the gates introduced during Step 4 and the red symbols are the gates coming from Step 5. Lastly, the yellow symbols represent the one gate added in Step 6 of the construction.

Lemma 3.2. *For $n \in \{3, \dots, 9\}$, inputs $x = (x_0, \dots, x_{n-1})$ with arrival times t_0, \dots, t_{n-1} and weight $W = \sum_{i=0}^{n-1} 2^{t_i}$, we have*

$$\text{del}(W, n) \leq \log_2 W + 3 \log_2 \log_2 n + 0.007$$

and

$$s(n) \leq 3.114n \log_2 \log_2 n.$$

Proof. First, assume that $n \in \{3, 4\}$. In Figure 5 we see that $S(t_0, \dots, t_3)$ has depth 2 and size 4. Since $S(t_0, \dots, t_2)$ is smaller or equal to $S(t_0, \dots, t_3)$ in depth and size, we have

$$\text{del}(W, n) \leq \log_2 W + 2 \leq \log_2 W + 3 \log_2 \log_2 3 + 0.007 \leq \log_2 W + 3 \log_2 \log_2 n + 0.007$$

and

$$s(n) \leq 4 \leq 3.114 * 3 \log_2 \log_2 3 \leq 3.114n \log_2 \log_2 n.$$

Next, assume that $n \in \{5, 6\}$. $S(t_0, \dots, t_5)$ has depth 3 and size 7 as seen in Figure 5. As before, $S(t_0, \dots, t_4)$ is smaller than $S(t_0, \dots, t_5)$ in depth and size due to the construction of these circuits. We get

$$\text{del}(W, n) \leq \log_2 W + 3 \leq \log_2 W + 3 \log_2 \log_2 5 + 0.007 \leq \log_2 W + 3 \log_2 \log_2 n + 0.007$$

and

$$s(n) \leq 7 \leq 3.114 * 5 \log_2 \log_2 5 \leq 3.114n \log_2 \log_2 n.$$

Finally, assume that $n \in \{7, 8, 9\}$. Figure 5 implies a depth of 4 and a size of 15 for $S(t_0, \dots, t_8)$. Again, the circuits for $n = 7$ and $n = 8$ are by construction smaller than $S(t_0, \dots, t_8)$ in depth and size. Therefore, we have

$$\text{del}(W, n) \leq \log_2 W + 4 \leq \log_2 W + 3 \log_2 \log_2 7 + 0.007 \leq \log_2 W + 3 \log_2 \log_2 n + 0.007$$

and

$$s(n) \leq 15 \leq 3.114 * 7 \log_2 \log_2 7 \leq 3.114n \log_2 \log_2 n. \quad \square$$

Before we formulate and prove the main result of this section, we need a numerical lemma.

Lemma 3.3. *Assume $n \in \mathbb{N}$ with $n \geq 2$. Then*

$$6.228 \log_2 \log_2 n - 1.114\sqrt{n} - 8.228 \leq 0.$$

Proof. Consider the function $f : \mathbb{R}_{\geq 2} \rightarrow \mathbb{R}$ with

$$f(x) = 6.228 \log_2 \log_2 x - 1.114\sqrt{x} - 8.228.$$

Its derivative is

$$f'(x) = \frac{6.228}{(\ln(2))^2 x \log_2(x)} - \frac{0.557}{\sqrt{x}},$$

which is positive for $x \leq 25$ (as $\frac{6.228}{(\ln(2))^2 \sqrt{25} \log_2(25)} - 0.557 > 0$) and negative for $x \geq 26$ (as $\frac{6.228}{(\ln(2))^2 \sqrt{26} \log_2(26)} - 0.557 < 0$). Since $f(25) < 0$ and $f(26) < 0$, this proves the lemma. \square

Theorem 3.4. *Let $n \in \mathbb{N}$ with $n \geq 3$. The prefix problem for an associative operator $\circ : \{0, 1\} \times \{0, 1\} \rightarrow \{0, 1\}$ on inputs x_0, \dots, x_{n-1} with arrival times $a(x_0), \dots, a(x_{n-1}) \in \mathbb{N}$ and weight $W = \sum_{i=0}^{n-1} 2^{a(x_i)}$ can be solved in polynomial time by a circuit S_n over the basis $\{\circ\}$ with delay*

$$\text{del}(S_n) \leq \log_2 W + 3 \log_2 \log_2 n + 0.007$$

and size

$$s(S_n) \leq 3.114n \log_2 \log_2 n.$$

Proof. We use the construction by Rautenbach, Szegedy and Werber described above. The polynomial runtime is already implied by Theorem 2.39. We prove the delay and size bounds by induction on n .

For $n \in \{3, \dots, 9\}$ the statement follows due to Lemma 3.2.

Assume now that $n \geq 10$ and the statement holds true for all $n' < n$. In this case, we use the recursion formulas from Lemma 3.1. We note that $\lceil \sqrt{n} \rceil - 1 \geq 3$ for $n \geq 10$. Therefore, we can apply the induction hypothesis in the following calculations. For the delay we get

$$\begin{aligned} \text{del}(W, n) &\stackrel{\text{Lem. 3.1}}{\leq} \text{del}(4W, \lceil \sqrt{n} \rceil - 1) + 1 \stackrel{(IH)}{=} \log_2(4W) + 3 \log_2 \log_2(\lceil \sqrt{n} \rceil - 1) + 1.007 \\ &\leq \log_2(W) + 3 \log_2 \log_2(\sqrt{n}) + 3.007 = \log_2(W) + 3 \log_2 \log_2 n + 0.007. \end{aligned}$$

For the size we calculate

$$\begin{aligned} s(n) &\stackrel{\text{Lem. 3.1}}{\leq} (\lceil \sqrt{n} \rceil + 1) s(\lceil \sqrt{n} \rceil - 1) + 2(n - \lceil \sqrt{n} \rceil) \\ &\stackrel{(IH)}{\leq} 3.114(\lceil \sqrt{n} \rceil + 1)(\lceil \sqrt{n} \rceil - 1) \log_2 \log_2(\lceil \sqrt{n} \rceil - 1) + 2(n - \lceil \sqrt{n} \rceil) \\ &\leq 3.114(\sqrt{n} + 2)\sqrt{n} \log_2 \log_2 \sqrt{n} + 2(n - \sqrt{n}) \\ &= 3.114(n + 2\sqrt{n})(\log_2 \log_2 n - 1) + 2(n - \sqrt{n}) \\ &= 3.114n \log_2 \log_2 n + 6.228\sqrt{n} \log_2 \log_2 n - 1.114n - 8.228\sqrt{n} \\ &= 3.114n \log_2 \log_2 n + \sqrt{n}(6.228 \log_2 \log_2 n - 1.114\sqrt{n} - 8.228) \\ &\stackrel{\text{Lem. 3.3}}{\leq} 3.114n \log_2 \log_2 n. \quad \square \end{aligned}$$

4 Delay-Optimizing Adder Circuit

In this section, we will construct an adder circuit whose delay is close to the best known delay bound from Theorem 2.37, while maintaining a sub-quadratic size. In Section 4.1, we will describe our general algorithm, and in Section 4.2, we will apply it to compute an adder with a delay of at most $\log_2 W + 3 \log_2 \log_2 n + \text{const}$ and a size of $\mathcal{O}(n \log_2^2 n)$ on n input pairs with weight W .

4.1 Algorithm

Our idea is to adapt the depth-optimizing construction that was used in [BS24] to prove Theorem 2.34 to the case of delay-optimization. Hence, we want to use the alternating split (Theorem 2.27) to recursively construct an adder with the help of a given family of AND-OR path circuits and a given family of AND-prefix circuits. In contrast to the setting of Theorem 2.34, we have to work with different arrival times, so we have to be careful with the choice of our sub-instances and cannot apply the approach from [BS24] directly.

Assume, a partition of an instance $p_0, g_0, \dots, p_{n-1}, g_{n-1}$ with arrival times $a(p_i), a(g_i) \in \mathbb{N}$ and weight W into two consecutive parts P_l and P_r is given. Assume that we constructed an adder as seen in Figure 4 with recursively computed adders A_r (respectively, A_l) on P_r (respectively, P_l), a given And-Or path circuit AOP on P_r , and a given AND-prefix circuit S on the propagate signals of P_l . This adder would then have a delay of at most

$$\max\{\text{del}(A_r), \text{del}(A_l) + 1, \text{del}(AOP) + 2, \text{del}(S) + 2\} \quad (4)$$

as seen in Figure 4. In order to prove a delay bound inductively, we have to make sure that the quantity (4) is smaller than our claimed delay bound. Therefore, the delay $\text{del}(A_l)$ of the recursively computed adder on P_l needs to be at least by 1 smaller than our claimed total delay bound. This is the case if the weight W_{P_l} of the inputs in P_l is at most half the weight of the whole instance (since then $\log_2 W_{P_l} \leq \log_2 \left(\frac{W}{2}\right) = \log_2 W - \frac{1}{2}$). For the size computation we also have to make sure that our sub-instances are not too large.

Combining these two considerations, our adder construction, given by Algorithm 1, works as follows. We define the sub-instance P_l to contain the leftmost k_l input pairs, where

$$k_l = \min \left\{ \max \left\{ m \in \mathbb{N} : \sum_{i=1}^m (2^{a(p_{n-i})} + 2^{a(g_{n-i})}) \leq \frac{W}{2} \right\}, \left\lfloor \frac{n}{2} \right\rfloor \right\}.$$

Then we make a case distinction. If $k_l = \lfloor \frac{n}{2} \rfloor$, we can define P_r to contain the rest of the instance and construct our adder just like described above and depicted in Figure 4.

However, if $k_l < \lfloor \frac{n}{2} \rfloor$ (i.e., if more than half of the total weight lies in the left half of the instance), we divide the instance into four parts as seen in Figure 6. We define P_r to contain the rightmost $k_r = \lfloor \frac{n}{2} \rfloor$ input pairs and P_m to contain the remaining k_m input pairs, except for the pair to the right of P_l which we will consider separately. Hence, $n = k_l + k_m + k_r + 1$. Note that P_l or P_m may contain no input pairs if $k_l = 0$, or if $k_l = \frac{n}{2} - 1$ and n is even, respectively. By the definition of k_l we know that P_l and the pair to the right of P_l combine more than half of the total weight of the instance. Consequently, both P_r and P_m contain less weight than $\frac{W}{2}$. Moreover, each sub-instance contains at most $\lfloor \frac{n}{2} \rfloor$ input pairs.

Then, we compute adders $A_{k_l}^l, A_{k_m}^m$ and $A_{k_r}^r$ on P_l, P_m and P_r , AND-prefix circuits S_{k_l} and S_{k_m} on the propagate signals of P_l and P_m as well as AND-OR path circuits AOP_{k_m} and AOP_{k_r} on P_m and P_r , as seen in Figure 6.

The carry bits are then computed in four steps:

- The first k_r carry bits are given directly by $A_{k_r}^r$.
- The next k_m carry bits are given by the expression

$$\text{out}_i(A_{k_m}^m) \vee (\text{out}_i(S_{k_m}^m) \wedge \text{out}(AOP_{k_r}^r))$$

for $1 \leq i \leq k_m$ via the alternating split (Theorem 2.27).

- The $(k_r + k_m + 1)$ th carry bit is computed via

$$g_{k_r+k_m} \vee \left(p_{k_r+k_m} \wedge \left(\text{out}(AOP_{k_m}^m) \vee (\text{out}_{k_m}(S_{k_m}^m) \wedge \text{out}(AOP_{k_r}^r)) \right) \right).$$

- The last k_l carry bits are given by

$$\text{out}_i(A_{k_l}^l) \vee \left(\text{out}_i(S_{k_l}^l) \wedge \left(g_{k_r+k_m} \vee \left(p_{k_r+k_m} \wedge \left(\text{out}(AOP_{k_m}^m) \vee (\text{out}_{k_m}(S_{k_m}^m) \wedge \text{out}(AOP_{k_r}^r)) \right) \right) \right) \right)$$

for $1 \leq i \leq k_m$ again via the alternating split.

Algorithm 1 Delay-optimizing adder construction framework

Input: $n \in \mathbb{N}, n \geq 3$, n input pairs $p_0, g_0, \dots, p_{n-1}, g_{n-1}$ with arrival times $a(p_i), a(g_i) \in \mathbb{N}$ for $i \in \{0, \dots, n-1\}$, adder circuits $(A_k)_{k < n}$, AND-OR-path circuits $(AOP_k)_{k < n}$, AND-prefix circuits $(S_k)_{k < n}$.

Output: An adder circuit C_n on $p_0, g_0, \dots, p_{n-1}, g_{n-1}$.

```
1:  $k_l \leftarrow \min\{\max\{m \in \mathbb{N} : \sum_{i=1}^m (2^{a(p_{n-i})} + 2^{a(g_{n-i})}) \leq \frac{W}{2}\}, \lfloor \frac{n}{2} \rfloor\}$ .
2: if  $k_l = \lfloor \frac{n}{2} \rfloor$  then
3:    $k_r \leftarrow n - k_l$ .
4:    $P_r \leftarrow (p_0, g_0, \dots, p_{k_r-1}, g_{k_r-1})$ .
5:    $P_l \leftarrow (p_{k_r}, g_{k_r}, \dots, p_{n-1}, g_{n-1})$ .
6:   Compute adder circuits  $A_{k_r}^r, A_{k_l}^l$  on  $P_r, P_l$ , respectively.
7:   Compute AND-OR-path circuit  $AOP_{k_r}^r$  on  $P_r$ .
8:   Compute AND-prefix circuit  $S_{k_l}^l$  on inputs  $p_i$  of  $P_{k_l}$  ( $p_{k_r}, \dots, p_{n-1}$ ).
9:   for  $i = 1$  to  $k_r$  do
10:     $\text{out}_i(C_n) := \text{out}_i(A_{k_r}^r)$ .
11:   for  $i = 1$  to  $k_l$  do
12:     $\text{out}_{k_r+i}(C_n) := \text{out}_i(A_{k_l}^l) \vee (\text{out}_i(S_{k_l}^l) \wedge \text{out}(AOP_{k_r}^r))$ .
13:   return  $C_n$ .
14: else
15:    $k_r \leftarrow \lfloor \frac{n}{2} \rfloor$ .
16:    $k_m \leftarrow n - k_l - k_r - 1 = \lceil \frac{n}{2} \rceil - k_l - 1$ .
17:    $P_r \leftarrow (p_0, g_0, \dots, p_{k_r-1}, g_{k_r-1})$ .
18:    $P_m \leftarrow (p_{k_r}, g_{k_r}, \dots, p_{k_r+k_m-1}, g_{k_r+k_m-1})$ .
19:    $P_l \leftarrow (p_{k_r+k_m+1}, g_{k_r+k_m+1}, \dots, p_{n-1}, g_{n-1})$ .
20:   Compute adder circuits  $A_{k_r}^r, A_{k_m}^m, A_{k_l}^l$  on  $P_r, P_m, P_l$ , respectively.
21:   Compute AND-OR-path circuits  $AOP_{k_m}^m, AOP_{k_r}^r$  on  $P_m, P_r$ , respectively.
22:   Compute AND-prefix circuits  $S_{k_l}^l, S_{k_m}^m$  on inputs  $p_i$  of  $P_{k_l}, P_{k_m}$ , respectively.
23:   for  $i = 1$  to  $k_r$  do
24:     $\text{out}_i(C_n) := \text{out}_i(A_{k_r}^r)$ .
25:   for  $i = 1$  to  $k_m$  do
26:     $\text{out}_{k_r+i}(C_n) := \text{out}_i(A_{k_m}^m) \vee (\text{out}_i(S_{k_m}^m) \wedge \text{out}(AOP_{k_r}^r))$ .
27:    $\text{out}_{k_r+k_m+1}(C_n) := g_{k_r+k_m} \vee \left( p_{k_r+k_m} \wedge \left( \text{out}(AOP_{k_m}^m) \vee (\text{out}_{k_m}(S_{k_m}^m) \wedge \text{out}(AOP_{k_r}^r)) \right) \right)$ .
28:   for  $i = 1$  to  $k_l$  do
29:     $\text{out}_{k_r+k_m+1+i}(C_n) :=$ 
30:     $\text{out}_i(A_{k_l}^l) \vee \left( \text{out}_i(S_{k_l}^l) \wedge \left( g_{k_r+k_m} \vee \left( p_{k_r+k_m} \wedge \left( \text{out}(AOP_{k_m}^m) \vee (\text{out}_{k_m}(S_{k_m}^m) \wedge \text{out}(AOP_{k_r}^r)) \right) \right) \right) \right)$ .
31:   return  $C_n$ .
```

Note that the formula

$$g_{k_r+k_m} \vee \left(p_{k_r+k_m} \wedge \left(\text{out}(AOP_{k_m}^m) \vee (\text{out}_{k_m}(S_{k_m}^m) \wedge \text{out}(AOP_{k_r}^r)) \right) \right)$$

indeed computes the $(k_r + k_m + 1)$ th carry bit, i.e., the function $g^*((g_{k_r+k_m}, p_{k_r+k_m}, \dots, g_1, p_1, g_0))$, because of the definition of g^* and the alternating split (Theorem 2.27).

The next lemma bounds the delay and the size of the adder constructed in Algorithm 1 in terms of the delay and size of the computed sub-circuits.

Lemma 4.1. *Let $n \in \mathbb{N}$ with $n \geq 3$, input pairs $p_0, g_0, \dots, p_{n-1}, g_{n-1}$ with arrival times $a(p_i), a(g_i)$ for $i \in \{0, \dots, n-1\}$, adder circuits $(A_k)_{k < n}$, AND-OR-path circuits $(AOP_k)_{k < n}$ and AND-prefix circuits $(S_k)_{k < n}$ be given and let*

$$k_l = \min \left\{ \max \left\{ m \in \mathbb{N} : \sum_{i=1}^m (2^{a(p_{n-i})} + 2^{a(g_{n-i})}) \leq \frac{W}{2} \right\}, \left\lfloor \frac{n}{2} \right\rfloor \right\}.$$

Algorithm 1 computes an adder circuit C_n with

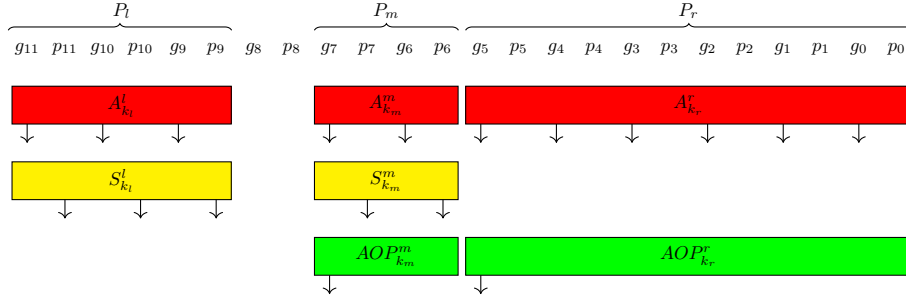

Figure 6: Visualization of the computed sub-circuits during Algorithm 1 for $n = 12$ and $k_l = 3$.

- $\text{del}(C_n) \leq \max\{\text{del}(A_{k_r}^r), \text{del}(A_{k_l}^l) + 1, \text{del}(AOP_{k_r}^r) + 2, \text{del}(S_{k_l}^l) + 2\}$

and

$$s(C_n) \leq s(A_{k_r}^r) + s(A_{k_l}^l) + s(AOP_{k_r}^r) + s(S_{k_l}^l) + 2k_l,$$

if $k_l = \lfloor \frac{n}{2} \rfloor$.

- $\text{del}(C_n) \leq \max\{\text{del}(A_{k_r}^r), \text{del}(A_{k_m}^m) + 1, \text{del}(A_{k_l}^l) + 1, a(g_{k_r+k_m}) + 3, a(p_{k_r+k_m}) + 4, \text{del}(AOP_{k_m}^m) + 5, \text{del}(AOP_{k_r}^r) + 6, \text{del}(S_{k_l}^l) + 2, \text{del}(S_{k_m}^m) + 6\}$

and

$$s(C_n) \leq s(A_{k_r}^r) + s(A_{k_m}^m) + s(A_{k_l}^l) + s(AOP_{k_r}^r) + s(AOP_{k_m}^m) + s(S_{k_m}^m) + s(S_{k_l}^l) + 2k_m + 2k_l + 3,$$

if $k_l < \lfloor \frac{n}{2} \rfloor$.

Proof. First, assume that $k_l = \lfloor \frac{n}{2} \rfloor$. The delay of C_n is the maximum delay of any of the carry bits computed by C_n . The first k_r carry bits (computed in line 10 of Algorithm 1) have a delay of at most $\text{del}(A_{k_r}^r)$. The last k_l carry bits (computed in line 12) have a delay of at most

$$\max\{\text{del}(A_{k_l}^l) + 1, \text{del}(AOP_{k_r}^r) + 2, \text{del}(S_{k_l}^l) + 2\}.$$

Thus, the total delay bound follows as claimed.

The size bound arises from adding up the sizes of the sub-circuits computed in lines 6 to 8 of the algorithm together with some additional gates which are needed to compute all of the carry bits. In this case, we need two additional gates to compute each of the k_l carry bits $c_{k_r+1}, \dots, c_{n+1}$ resulting in $2k_l$ additional gates.

Now, assume that $k_l < \lfloor \frac{n}{2} \rfloor$. Again, we look at the delay of the individual carry bits. The first ones (computed in line 24) have a delay of at most $\text{del}(A_{k_r}^r)$. The carry bits computed in line 26 have a delay of at most

$$\max\{\text{del}(A_{k_m}^m) + 1, \text{del}(AOP_{k_r}^r) + 2, \text{del}(S_{k_m}^m) + 2\}.$$

The $(k_r + k_m + 1)$ th carry bit (computed in line 27) has a delay of at most

$$\max\{a(g_{k_r+k_m}) + 1, a(p_{k_r+k_m}) + 2, \text{del}(AOP_{k_m}^m) + 3, \text{del}(AOP_{k_r}^r) + 4, \text{del}(S_{k_m}^m) + 4\}.$$

The last k_r carry bits (computed in line 29) have a delay of at most

$$\max\{\text{del}(A_{k_l}^l) + 1, \text{del}(S_{k_l}^l) + 2, a(g_{k_r+k_m}) + 3, a(p_{k_r+k_m}) + 4, \text{del}(AOP_{k_m}^m) + 5, \text{del}(AOP_{k_r}^r) + 6, \text{del}(S_{k_m}^m) + 6\}.$$

Altogether, the delay bound follows.

For the size bound we add the sizes of all sub-circuits computed in lines 20 to 22 of the algorithm. In this case, we have to add two gates for each carry bit computed in line 26, three gates for the carry bit computed in line 27 and two gates for each carry bit computed in line 29. Note that in line 27 we can reuse the gate between $\text{out}_{k_m}(S_{k_m}^m)$ and $\text{out}(AOP_{k_r}^r)$ which is already constructed in line 26. In line 29 we only need to add the first two gates and can reuse the remaining ones. Hence, we need $2k_m + 2k_l + 3$ additional gates. \square

4.2 Adder Construction

We will apply Algorithm 1 using the fastest known AND-OR path circuits (Theorem 2.37), and the fastest known AND-prefix circuits (Theorem 2.39, with the specific bounds from in Theorem 3.4), as sub-circuits. We receive an adder with a sub-quadratic size whose delay exceeds the delay of the AND-prefix circuits only by a constant.

Before we can show this, we need a series of numerical lemmas.

Lemma 4.2. *The function*

$$f(x) = \frac{\log_2 \log_2 x}{\log_2 x}$$

has its maximum at $x = 2^e$ with $f(2^e) \leq 0.531$ and is decreasing for $x \geq 2^e$.

Proof. We rewrite f as

$$f(x) = \frac{\ln(\ln x) - \ln(\ln 2)}{\ln x}$$

and calculate its derivative

$$f'(x) = \frac{1 - \ln(\ln x) + \ln(\ln 2)}{x \ln^2 x} = \frac{1 - \ln(\log_2 x)}{x \ln^2 x}.$$

Note that $f'(x) = 0$ if and only if $x = 2^e$ and $f'(x)$ is negative for all $x > 2^e$ which implies the lemma. \square

Lemma 4.3. *Assume $n \in \mathbb{N}$ with $6 \leq n \leq 374$. Then*

$$(i) \log_2 n \leq 2 \log_2 \log_2 n + 2.357,$$

$$(ii) 6.2 \leq 2.399 \log_2 n.$$

Proof. The first statement is verified easily for $n = 6$, so assume $n \geq 7$. Then, we have $n > 2^e$, so by Lemma 4.2 $n \mapsto \frac{\log_2 \log_2 n}{\log_2 n}$ is decreasing. Therefore, we get

$$2 \log_2 \log_2 n + 2.357 \geq \left(2 \cdot \frac{\log_2 \log_2(374)}{\log_2(374)} + \frac{2.357}{\log_2(374)} \right) \log_2 n \geq (0.7243 + 0.2757) \log_2 n = \log_2 n$$

The second statement holds since the logarithm is increasing and $\log_2 6 \geq \frac{6.2}{2.399}$. \square

Lemma 4.4. *Assume $n \in \mathbb{N}$ with $n \geq 375$. Then we have the following inequalities:*

$$(i) \log_2 \left\lceil \frac{n}{2} \right\rceil \leq \log_2 n - 0.99,$$

$$(ii) \log_2 \log_2 \log_2 n \leq 2 \log_2 \log_2 n - 4.561,$$

$$(iii) \log_2 \log_2 n + \log_2 \log_2 \log_2 n + 3.3 \leq 0.939 \log_2 n,$$

$$(iv) 3.114 \log_2 \log_2 n \leq 1.128 \log_2 n,$$

$$(v) 2 \log_2 n - 1 \geq 1.883 \log_2 n.$$

Proof. For $x \geq 375$, we have $x > \log_2(x) > 7 > 2^e$. Thus, by Lemma 4.2, both $x \mapsto \frac{\log 2 \log 2x}{\log_2 x}$ and $x \mapsto \frac{\log_2 \log_2 \log_2 x}{\log_2 \log_2 x}$ are then decreasing. Since $n \geq 375$, we can apply Lemma 4.2 several times in the following proofs.

(i) For the first statement we calculate

$$\log_2 \left\lceil \frac{n}{2} \right\rceil \leq \log_2 \left(\frac{n+1}{2} \right) = \log_2 \left(n \frac{n+1}{2n} \right) = \log_2 n - 1 + \log_2 \left(1 + \frac{1}{n} \right) \stackrel{n \geq 375}{\leq} \log_2 n - 0.99.$$

(ii) We apply Lemma 4.2 and get

$$\begin{aligned} \log_2 \log_2 \log_2 n + 4.561 &\leq \left(\frac{\log_2 \log_2 \log_2(375)}{\log_2 \log_2(375)} + \frac{4.561}{\log_2 \log_2(375)} \right) \log_2 \log_2 n \\ &\leq (0.52662 + 1.4732) \log_2 \log_2 n \leq 2 \log_2 \log_2 n \end{aligned}$$

(iii) Using Lemma 4.2, we calculate

$$\begin{aligned} \log_2 \log_2 n + \log_2 \log_2 \log_2 n + 3.3 &\leq \frac{\log_2 \log_2(375)}{\log_2(375)} \log n + \frac{\log_2 \log_2 \log_2(375)}{\log_2 \log_2(375)} \log_2 \log_2 n + \frac{3.3}{\log(375)} \log n \\ &\leq \frac{\log_2 \log_2(375)}{\log_2(375)} \log_2 n + \frac{\log_2 \log_2 \log_2(375)}{\log_2(375)} \log_2 n + \frac{3.3}{\log(375)} \log n \\ &\leq (0.3621 + 0.1907 + 0.386) \log_2 n \leq 0.939 \log_2 n \end{aligned}$$

(iv) For the fourth statement, we use Lemma 4.2 and calculate

$$3.114 \log_2 \log_2 n \stackrel{\text{Lem. 4.2, } n \geq 375}{\leq} 3.114 \frac{\log_2 \log_2 375}{\log_2 375} \log_2 n \leq 1.128 \log_2 n.$$

(v) The last statement holds true since $0.117 \log_2(375) \geq 1$ and the logarithm is monotonely increasing. \square

Now, we can finally state and prove the main theorem of this section.

Theorem 4.5. *Let $n \in \mathbb{N}$ with $n \geq 3$ and input pairs $p_0, g_0, \dots, p_{n-1}, g_{n-1}$ with arrival times $a : \{p_0, g_0, \dots, p_{n-1}, g_{n-1}\} \rightarrow \mathbb{N}$ be given and let $W = \sum_{i=0}^{n-1} (2^{a(p_i)} + 2^{a(g_i)})$ be the weight of the input pairs. We can construct an adder circuit C_n on these input pairs with delay*

$$\text{del}(C_n) \leq \log_2 W + 3 \log_2 \log_2 n + c_1$$

and size

$$s(C_n) \leq c_2 n \log_2^2 n$$

in polynomial time for $c_1 = 5.007$ and $c_2 = 2.422$.

Proof. We prove the delay and size bounds by induction on n .

Case 1: Assume that $3 \leq n \leq 5$. In this case we use the ripple carry adder circuit which has depth and size $2n - 2$ (see Example 2.23). This circuit fulfills our desired delay and size bounds for $c_1 \geq 5$ and $c_2 \geq 1$ since

$$2n - 2 \leq 3 \log_2 \log_2 n + 5$$

and

$$2n - 2 \leq n \log_2^2 n$$

for $n \in \{3, 4, 5\}$.

Case 2: Assume that $6 \leq n \leq 374$. Here, we use the adder circuit constructed by Brenner and Silvanus [BS24] from Theorem 2.34, which we gave a delay bound for in Corollary 2.40 (a), and call it C_n . It has delay

$$\text{del}(C_n) \stackrel{\text{Cor. 2.40 (a)}}{\leq} \log_2 W + \log_2 n + \log_2 \log_2 n + 2.65 \stackrel{\text{Lem. 4.3 (i)}}{\leq} \log_2 W + 3 \log_2 \log_2 n + c_1$$

and size

$$s(C_n) \stackrel{\text{Thm. 2.34}}{\leq} 6.2n \log_2 n \stackrel{\text{Lem. 4.3 (ii)}}{\leq} c_2 n \log_2^2 n$$

for $c_1 \geq 5.007$ and $c_2 \geq 2.399$.

Case 3: Assume that $n \geq 375$. Here, we apply our adder construction framework (Algorithm 1). Inductively, we can assume that adder circuits C_i on i input pairs with the claimed delay and size bounds can be constructed for all $3 \leq i < n$.

Case 3.1: Assume that $k_l = \lfloor \frac{n}{2} \rfloor$. Then $k_r = \lceil \frac{n}{2} \rceil$ and $W_{P_{k_l}} \leq \frac{W}{2}$. The following sub-circuits are used in our algorithm:

- We recursively compute adders $A_{k_r}^r$ and $A_{k_l}^l$ on P_r and P_l , respectively. By induction, they fulfill

$$\begin{aligned} \text{del}(A_{k_r}^r) &\stackrel{\text{(IH)}}{\leq} \log_2 W_{P_r} + 3 \log_2 \log_2 k_r + c_1 \\ &\stackrel{W_{P_r} \leq W, k_r \leq n}{\leq} \log_2 W + 3 \log_2 \log_2 n + c_1, \end{aligned} \tag{5}$$

$$\begin{aligned} \text{del}(A_{k_l}^l) &\stackrel{\text{(IH)}}{\leq} \log_2 W_{P_l} + 3 \log_2 \log_2 k_l + c_1 \\ &\stackrel{W_{P_l} \leq \frac{W}{2}, k_l \leq n}{\leq} \log_2 W + 3 \log_2 \log_2 n + c_1 - 1, \end{aligned} \tag{6}$$

$$s(A_{k_r}^r) \stackrel{\text{(IH)}}{\leq} c_2 k_r \log_2^2 k_r, \tag{7}$$

$$s(A_{k_l}^l) \stackrel{\text{(IH)}}{\leq} c_2 k_l \log_2^2 k_l. \tag{8}$$

- For the AND-OR-path circuit AOP_{k_r} , we use the circuit from Theorem 2.37. AOP_{k_r} has $2k_r - 1 \leq n$ inputs since $k_r \leq \frac{n+1}{2}$. Therefore, we have

$$\begin{aligned} \text{del}(AOP_{k_r}^r) &\leq \log_2 W_{P_{k_r}} + \log_2 \log_2 n + \log_2 \log_2 \log_2 n + 4.3 \\ &\stackrel{W_{P_{k_r}} \leq W}{\leq} \log_2 W + \log_2 \log_2 n + \log_2 \log_2 \log_2 n + 4.3 \\ &\stackrel{\text{Lem. 4.4 (ii)}}{\leq} \log_2 W + 3 \log_2 \log_2 n - 0.261, \end{aligned} \quad (9)$$

$$\begin{aligned} \text{s}(AOP_{k_r}^r) &\leq n \log_2 n + n \log_2 \log_2 n + n \log_2 \log_2 \log_2 n + 3.3n - 1 \\ &\stackrel{\text{Lem. 4.4 (iii)}}{\leq} 1.939n \log_2 n. \end{aligned} \quad (10)$$

- For the AND-prefix circuit S_{k_l} on the propagate signals of P_{k_l} , we use the circuit of Rautenbach, Szegedy and Werber, which we proved specific delay and size bounds for in Theorem 3.4, guaranteeing the bounds

$$\begin{aligned} \text{del}(S_{k_l}) &\leq \log_2 \left(\sum_{i=0}^{k_l-1} 2^{a(p_{k_r+i})} \right) + 3 \log_2 \log_2 k_l + 0.007 \\ &\stackrel{\sum_{i=0}^{k_l-1} 2^{a(p_{k_r+i})} \leq \frac{W}{2}, \quad k_l \leq n}{\leq} \log_2 W + 3 \log_2 \log_2 n - 0.993, \end{aligned} \quad (11)$$

$$\begin{aligned} \text{s}(S_{k_l}) &\leq 3.114k_l \log_2 \log_2 k_l \\ &\stackrel{k_l \leq \frac{n}{2}}{\leq} 1.557n \log_2 \log_2 n \\ &\stackrel{\text{Lem. 4.4 (iv)}}{\leq} 0.564n \log_2 n. \end{aligned} \quad (12)$$

Altogether, these bounds combined with Lemma 4.1 imply the delay bound

$$\begin{aligned} \text{del}(C_n) &\leq \max\{\text{del}(A_{k_r}), \text{del}(A_{k_l}) + 1, \text{del}(AOP_{k_r}) + 2, \text{del}(S_{k_l}) + 2\} \\ &\stackrel{(5),(6), (9),(11)}{\leq} \max\{\log_2 W + 3 \log_2 \log_2 n + c_1, \log_2 W + 3 \log_2 \log_2 n + 1.739, \\ &\quad \log_2 W + 3 \log_2 \log_2 n + 1.007\} \\ &\leq \log_2 W + 3 \log_2 \log_2 n + c_1 \end{aligned}$$

for $c_1 \geq 1.739$.

For the size bound we calculate

$$\begin{aligned} \text{s}(A_{k_r}) + \text{s}(A_{k_l}) &\stackrel{(7),(8)}{\leq} c_2 k_r \log_2^2 k_r + c_2 k_l \log_2^2 k_l \\ &\stackrel{\text{Lem. 4.4 (i)}, \quad k_l \leq \frac{n}{2}}{\leq} c_2 (k_r (\log_2 n - 0.99)^2 + k_l (\log_2 n - 1)^2) \\ &\leq c_2 (k_r (\log_2^2 n - 1.98 \log_2 n + 0.981) + k_l (\log_2^2 n - 2 \log_2 n + 1)) \\ &\stackrel{k_r + k_l = n}{=} c_2 (n \log_2^2 n - \log_2 n (1.98k_r + 2k_l) + 0.981k_r + k_l). \end{aligned} \quad (13)$$

Furthermore, we have

$$1.98k_r + 2k_l \geq 1.98 \frac{n+1}{2} + 2 \frac{n-1}{2} = 1.99n - 0.01$$

and

$$0.981k_r + k_l \leq 0.981 \frac{n}{2} + \frac{n}{2} \leq 0.991n.$$

Now, Equation (13) can be simplified to

$$\text{s}(A_{k_r}) + \text{s}(A_{k_l}) \leq c_2 (n \log_2^2 n - 1.99n \log_2 n + 0.01 \log_2 n + 0.991n). \quad (14)$$

With these calculations we can now use Lemma 4.1 to calculate the total size bound

$$\begin{aligned} \text{s}(C_n) &\leq \text{s}(A_{k_r}) + \text{s}(A_{k_l}) + \text{s}(AOP_{k_r}) + \text{s}(S_{k_l}) + 2k_l \\ &\stackrel{(14),(10), (12), 2k_l \leq n}{\leq} c_2 (n \log_2^2 n - 1.99n \log_2 n + 0.01 \log_2 n + 0.991n) + 1.939n \log_2 n + 0.564n \log_2 n + n \end{aligned}$$

$$\begin{aligned}
& 1.99 = \underline{0.116} + 1.874 c_2 n \log_2^2 n - c_2(0.116n \log_2 n - 0.991n - 0.01 \log_2 n) - n \log_2 n \left(1.874c_2 - 2.503 - \frac{1}{\log_2 n}\right) \\
& = c_2 n \log_2^2 n - c_2 n \log_2 n \left(0.116 - \frac{0.991}{\log_2 n} - \frac{0.01}{n}\right) - n \log_2 n \left(1.874c_2 - 2.503 - \frac{1}{\log_2 n}\right) \\
& \stackrel{n \geq 375}{\leq} c_2 n \log_2^2 n - c_2 n \log_2 n \left(0.116 - \frac{0.991}{\log_2 375} - \frac{0.01}{375}\right) - n \log_2 n \left(1.874c_2 - 2.503 - \frac{1}{\log_2 n}\right) \\
& \leq c_2 n \log_2^2 n - c_2 n \log_2 n (0.116 - 0.1159 - 0.00003) - n \log_2 n \left(1.874c_2 - 2.503 - \frac{1}{\log_2 n}\right) \\
& \leq c_2 n \log_2^2 n - n \log_2 n \left(1.874c_2 - 2.503 - \frac{1}{\log_2 375}\right) \\
& \leq c_2 n \log_2^2 n,
\end{aligned}$$

where the last inequality holds if

$$c_2 \geq \frac{2.503 + \frac{1}{\log_2 375}}{1.874},$$

which is satisfied if $c_2 \geq 1.399$.

Case 3.2: Assume that $k_l < \lfloor \frac{n}{2} \rfloor$. Then $k_r = \lfloor \frac{n}{2} \rfloor$ and $k_m = \lceil \frac{n}{2} \rceil - k_l - 1$. In this case, we have $k_r, k_m, k_l \leq \frac{n}{2}$ and $W_{P_r}, W_{P_m}, W_{P_l} \leq \frac{W}{2}$. Note that k_l or k_m may be 0. We use the same type of sub-circuits in this part of our algorithm:

- If $k_l, k_m \geq 3$, we recursively compute adders $A_{k_r}^r, A_{k_m}^m$ and $A_{k_l}^l$ on P_r, P_m and P_l , respectively. By induction, they fulfill

$$\begin{aligned}
\text{del}(A_{k_r}^r) & \stackrel{\text{(IH)}}{\leq} \log_2 W_{P_r} + 3 \log_2 \log_2 k_r + c_1 \\
& \stackrel{W_{P_r} \leq \frac{W}{2},}{k_r \leq \frac{n}{2}}{\leq} \log_2 W + 3 \log_2 \log_2 n + c_1 - 1,
\end{aligned} \tag{15}$$

$$\begin{aligned}
\text{del}(A_{k_m}^m) & \stackrel{\text{(IH)}}{\leq} \log_2 W_{P_m} + 3 \log_2 \log_2 k_m + c_1 \\
& \stackrel{W_{P_m} \leq \frac{W}{2},}{k_l \leq \frac{n}{2}}{\leq} \log_2 W + 3 \log_2 \log_2 n + c_1 - 1,
\end{aligned} \tag{16}$$

$$\begin{aligned}
\text{del}(A_{k_l}^l) & \stackrel{\text{(IH)}}{\leq} \log_2 W_{P_l} + 3 \log_2 \log_2 k_l + c_1 \\
& \stackrel{W_{P_l} \leq \frac{W}{2},}{k_l \leq \frac{n}{2}}{\leq} \log_2 W + 3 \log_2 \log_2 n + c_1 - 1,
\end{aligned} \tag{17}$$

$$\begin{aligned}
s(A_{k_r}^r) & \stackrel{\text{(IH)}}{\leq} c_2 k_r \log_2^2 k_r \\
& \stackrel{k_r \leq \frac{n}{2}}{\leq} c_2 k_r (\log_2 n - 1)^2,
\end{aligned} \tag{18}$$

$$\begin{aligned}
s(A_{k_m}^m) & \stackrel{\text{(IH)}}{\leq} c_2 k_m \log_2^2 k_m \\
& \stackrel{k_m \leq \frac{n}{2}}{\leq} c_2 k_m (\log_2 n - 1)^2,
\end{aligned} \tag{19}$$

$$\begin{aligned}
s(A_{k_l}^l) & \stackrel{\text{(IH)}}{\leq} c_2 k_l \log_2^2 k_l \\
& \stackrel{k_l \leq \frac{n}{2}}{\leq} c_2 k_l (\log_2 n - 1)^2.
\end{aligned} \tag{20}$$

If $k_l \leq 2$ or $k_m \leq 2$, we just use the trivial adder circuit on P_l or P_m . In this case, the inequalities above are still satisfied for $c_1 \geq 0$ and $c_2 \geq 1$.

- For the AND-OR-path circuits $AOP_{k_r}^r$ and $AOP_{k_m}^m$, assuming that $k_m \geq 3$, we again use the circuit from Theorem 2.37. Since $k_r, k_m \leq \frac{n}{2}$, $AOP_{k_r}^r$ and $AOP_{k_m}^m$ have less than n inputs. Therefore, we have

$$\begin{aligned}
\text{del}(AOP_{k_r}^r) & \leq \log_2 W_{P_r} + \log_2 \log_2 n + \log_2 \log_2 \log_2 n + 4.3 \\
& \stackrel{W_{P_r} \leq \frac{W}{2}}{\leq} \log_2 W + \log_2 \log_2 n + \log_2 \log_2 \log_2 n + 3.3 \\
& \stackrel{\text{Lem. 4.4 (ii)}}{\leq} \log_2 W + 3 \log_2 \log_2 n - 1.261,
\end{aligned} \tag{21}$$

$$\begin{aligned}
\text{del}(AOP_{k_m}^m) &\leq \log_2 W_{P_m} + \log_2 \log_2 n + \log_2 \log_2 \log_2 n + 4.3 \\
&\stackrel{W_{P_m} \leq \frac{W}{2}}{\leq} \log_2 W + \log_2 \log_2 n + \log_2 \log_2 \log_2 n + 3.3 \\
&\stackrel{\text{Lem. 4.4 (ii)}}{\leq} \log_2 W + 3 \log_2 \log_2 n - 1.261, \tag{22}
\end{aligned}$$

$$\begin{aligned}
s(AOP_{k_r}^r) &\leq n \log_2 n + n \log_2 \log_2 n + n \log_2 \log_2 \log_2 n + 3.3n - 1 \\
&\stackrel{\text{Lem. 4.4 (iii)}}{\leq} 1.939n \log_2 n, \tag{23}
\end{aligned}$$

$$\begin{aligned}
s(AOP_{k_m}^m) &\leq n \log_2 n + n \log_2 \log_2 n + n \log_2 \log_2 \log_2 n + 3.3n - 1 \\
&\stackrel{\text{Lem. 4.4 (iii)}}{\leq} 1.939n \log_2 n. \tag{24}
\end{aligned}$$

If $k_m \leq 2$, we use the trivial AND-OR-path circuit as $AOP_{k_m}^m$ which also satisfies the above inequalities.

- For the AND-prefix circuits $S_{k_m}^m$ and $S_{k_l}^l$ on the propagate signals of P_m and P_l , respectively, we again use the circuit of Rautenbach, Szegedy and Werber (Theorem 3.4). Here, we have

$$\begin{aligned}
\text{del}(S_{k_m}^m) &\leq \log_2 \left(\sum_{i=0}^{k_m-1} 2^{a(p_{k_r+i})} \right) + 3 \log_2 \log_2 k_m + 0.007 \\
&\stackrel{\sum_{i=0}^{k_m-1} 2^{a(p_{k_r+i})} \leq \frac{W}{2},}{\leq} \log_2 W + 3 \log_2 \log_2 n - 0.993, \tag{25}
\end{aligned}$$

$$\begin{aligned}
\text{del}(S_{k_l}^l) &\leq \log_2 \left(\sum_{i=1}^{k_l} 2^{a(p_{k_r+k_m+i})} \right) + 3 \log_2 \log_2 k_l + 0.007 \\
&\stackrel{\sum_{i=1}^{k_l} 2^{a(p_{k_r+k_m+i})} \leq \frac{W}{2},}{\leq} \log_2 W + 3 \log_2 \log_2 n - 0.993, \tag{26}
\end{aligned}$$

$$\begin{aligned}
s(S_{k_m}^m) &\leq 3.114k_m \log_2 \log_2 k_m \\
&\stackrel{k_m \leq n}{\leq} 3.114k_m \log_2 \log_2 n \\
&\stackrel{\text{Lem. 4.4 (iv)}}{\leq} 1.128k_m \log_2 n, \tag{27}
\end{aligned}$$

$$\begin{aligned}
s(S_{k_l}^l) &\leq 3.114k_l \log_2 \log_2 k_l \\
&\stackrel{k_l \leq n}{\leq} 3.114k_l \log_2 \log_2 n \\
&\stackrel{\text{Lem. 4.4 (iv)}}{\leq} 1.128k_l \log_2 n. \tag{28}
\end{aligned}$$

Now, we again use Lemma 4.1 to prove the desired delay and size bounds. For the delay, we have

$$\begin{aligned}
\text{del}(C_n) &\leq \max \{ \text{del}(A_{k_r}^r), \text{del}(A_{k_m}^m) + 1, \text{del}(A_{k_l}^l) + 1, a(g_{k_r+k_m}) + 3, a(p_{k_r+k_m}) + 4, \\
&\quad \text{del}(AOP_{k_m}^m) + 5, \text{del}(AOP_{k_r}^r) + 6, \text{del}(S_{k_l}^l) + 2, \text{del}(S_{k_m}^m) + 6 \} \\
&\stackrel{\substack{(15),(16),(17), \\ (21),(22), \\ (25),(26)}}{\leq} \max \{ \log_2 W + 3 \log_2 \log_2 n + c_1, \log_2 W + 3 \log_2 \log_2 n + 4.739, \\
&\quad \log_2 W + 3 \log_2 \log_2 n + 5.007 \} \\
&\leq \log_2 W + 3 \log_2 \log_2 n + c_1
\end{aligned}$$

for $c_1 \geq 5.007$. Here we used that $a(g_{k_r+k_m})$ and $a(p_{k_r+k_m})$ are less than $\log_2 W$.

For the size bound, we calculate

$$\begin{aligned}
s(A_{k_r}^r) + s(A_{k_m}^m) + s(A_{k_l}^l) &\stackrel{(18),(19),(20)}{\leq} c_2(k_r + k_m + k_l)(\log_2 n - 1)^2 \\
&\stackrel{k_r+k_m+k_l = n-1}{\leq} c_2n(\log_2^2 n - 2 \log_2 n + 1) \\
&\stackrel{\text{Lem. 4.4 (v)}}{\leq} c_2n(\log_2^2 n - 1.883 \log_2 n). \tag{29}
\end{aligned}$$

Moreover, inequalities (27) and (28) and the fact that $k_m + k_l = \left\lceil \frac{n}{2} \right\rceil - 1 \leq \frac{n-1}{2} \leq \frac{n}{2}$ give us

$$s(S_{k_m}^m) + s(S_{k_l}^l) \leq 1.128 \log_2 n (k_m + k_l) \leq 0.564n \log_2 n. \quad (30)$$

Lemma 4.1 together with our size bounds for the computed sub-circuits results in the total size bound

$$\begin{aligned} s(C_n) &\leq s(A_{k_r}^r) + s(A_{k_m}^m) + s(A_{k_l}^l) + s(AOP_{k_r}^r) + s(AOP_{k_m}^m) + s(S_{k_m}^m) + s(S_{k_l}^l) + 2k_m + 2k_l + 3 \\ &\stackrel{(29),(23), (24),(30)}{\leq} c_2 n (\log_2^2 n - 1.883 \log_2 n) + 3.878n \log_2 n + 0.564n \log_2 n + 2k_m + 2k_l + 3 \\ &\stackrel{k_m + k_l \leq \frac{n-1}{2}}{\leq} c_2 n \log_2^2 n - n \log_2 n (1.883c_2 - 4.442) + n + 2 \\ &= c_2 n \log_2^2 n - n \log_2 n \left(1.883c_2 - 4.442 - \frac{1}{\log_2 n} - \frac{2}{n \log_2 n} \right) \\ &\stackrel{n \geq 375}{\leq} c_2 n \log_2^2 n - n \log_2 n \left(1.883c_2 - 4.442 - \frac{1}{\log_2 375} - \frac{2}{375 \log_2 375} \right) \\ &\leq c_2 n \log_2^2 n - n \log_2 n (1.883c_2 - 4.56) \\ &\leq c_2 n \log_2^2 n \end{aligned}$$

for $c_2 \geq \frac{4.56}{1.883}$, which is the case if $c_2 \geq 2.422$.

Thus, we get the delay and size bounds for C_n with constants $c_1 \geq 5.007$ and $c_2 \geq 2.422$.

For proving the runtime, we show by induction on n that there exists a constant α such that the total number of steps needed for computing C_n is bounded by n^α . It suffices to consider the case where $n \geq 151$.

Case 1: Assume that $k_l = \lfloor \frac{n}{2} \rfloor$. Then $k_r \leq \frac{n+1}{2} \leq \frac{76}{151}n$ since $n \geq 151$. By the induction hypothesis we can construct the sub-circuits $A_{k_r}^r$ and $A_{k_l}^l$ in at most k_r^α and k_l^α steps, respectively. The rest of the algorithm, including the computation of the AND-OR-path circuit $AOP_{k_r}^r$ and the AND-prefix circuit $S_{k_l}^l$ (see Theorem 2.37 and Theorem 3.4), can be performed in polynomial time. For this part, we assume that we need at most n^β steps for some fixed $\beta > 0$. Then, the total number of computation steps is at most

$$k_r^\alpha + k_l^\alpha + n^\beta \leq \left(\frac{76}{151}n \right)^\alpha + \left(\frac{n}{2} \right)^\alpha + n^\beta \leq \left(\left(\frac{76}{151} \right)^\alpha + \frac{1}{2^\alpha} + n^{\beta-\alpha} \right) n^\alpha \leq n^\alpha$$

for a sufficiently large α .

Case 2: Assume that $k_l < \lfloor \frac{n}{2} \rfloor$. Then $k_r \leq \frac{n}{2}$ and $k_l \leq \frac{n}{2}$. Again, by the induction hypothesis we can construct the sub-circuits $A_{k_r}^r$, $A_{k_m}^m$ and $A_{k_l}^l$ in at most k_r^α , k_m^α and k_l^α steps, respectively. The rest of the algorithm can again be performed in a total amount of at most n^γ computation steps for some fixed $\gamma > 0$. Combined, the number of steps does not exceed

$$k_r^\alpha + k_m^\alpha + k_l^\alpha + n^\gamma \leq 3 \left(\frac{n}{2} \right)^\alpha + n^\gamma \leq \left(\frac{3}{2^\alpha} + n^{\gamma-\alpha} \right) n^\alpha \leq n^\alpha$$

for a sufficiently large α . This finishes the proof of the polynomial runtime and also the proof of the theorem. \square

Remark. The fanout of the adder from Theorem 4.5 is in $\mathcal{O}(\sqrt{n})$ since the fanout of the AND-prefix circuit by Rautenbach, Szegedy and Werber from Theorem 3.4, which we used as sub-circuits in Algorithm 1, is also in $\mathcal{O}(\sqrt{n})$ (see the remark in Section 3).

5 Size Reduction of Adder Circuits

In this section, we are going to use another adder construction framework, presented in [BS24], in order to reduce the size of our adder circuit from Theorem 4.5, at the cost of a relatively small delay increase. In Section 5.1, we will present the adder construction framework from [BS24] which we will then use to compute three additional adder circuits. The first adder, shown in Section 5.2, has a size in $\mathcal{O}(n \log_2 n)$, whereas the second and the third adder, both presented in Section 5.3, have a size in $\mathcal{O}(n \log_2 \log_2 n)$ and $\mathcal{O}(n)$, respectively. The delay of each of these circuits exceeds the delay of the circuit from Theorem 4.5 by a summand of order $\mathcal{O}(\log_2 \log_2 \log_2 n)$.

5.1 l -Part Adder Construction Framework

Algorithm 2 provides a procedure to construct an adder circuit on n input pairs given another family of adder circuits $(A_k)_{k \in \mathbb{N}}$, a family of AND-OR-path circuits $(AOP_k)_{k \in \mathbb{N}}$ and a family of AND-prefix circuits $(S_k)_{k \in \mathbb{N}}$. For

Algorithm 2 l -part adder construction framework [BS24] (Alg. 4.2)

Input: $n \in \mathbb{N}, n \geq 2$, n input pairs $p_0, g_0, \dots, p_{n-1}, g_{n-1}$, a family of adder circuits $(A_k)_{k \in \mathbb{N}}$, a family of AND-OR-path circuits $(AOP_k)_{k \in \mathbb{N}}$, a family of AND-prefix circuits $(S_k)_{k \in \mathbb{N}}$.

Output: An adder circuit C_n on $p_0, g_0, \dots, p_{n-1}, g_{n-1}$.

```
1: Choose  $k \in \mathbb{N}_{>0}$  and  $l := \lceil n/k \rceil$ .
2: for  $j = 0$  to  $l - 2$  do
3:    $P^{(j)} := (p_j k, g_j k, \dots, p_{(j+1)k-1}, g_{(j+1)k-1})$ .
4:  $P^{(l-1)} := (p_{(l-1)k}, g_{(l-1)k}, \dots, p_{n-1}, g_{n-1})$ .
5: for  $j = 0$  to  $l - 1$  do
6:    $n_j \leftarrow |P^{(j)}|, N_j \leftarrow n_0 + \dots + n_{j-1}$ .
7: Construct an adder circuit  $A_{n_0}^0$  on  $P^{(0)}$ .
8: for  $i = 1$  to  $n_0$  do
9:    $out_i(C_n) := out_i(A_{n_0}^0)$ .
10: for  $j = 1$  to  $l - 1$  do
11:   Construct an adder circuit  $A_{n_j}^j$  on  $P^{(j)}$ .
12:   Construct an AND-prefix circuit  $S_{n_j}^j$  on the inputs  $p_i$  of  $P^{(j)}$ .
13:   Construct an AND-OR-path circuit  $AOP_{N_j}^j$  on the  $N_j$  input pairs  $P^{(j-1)} \uplus \dots \uplus P^{(0)}$ .
14:   for  $i = 1$  to  $n_j$  do
15:      $out_{N_j+i}(C_n) := out_i(A_{n_j}^j) \vee (out_i(S_{n_j}^j) \wedge out(AOP_{N_j}^j))$ .
16: return  $C_n$ .
```

a given $k \in \mathbb{N}$, the instance is partitioned into $l := \lceil \frac{n}{k} \rceil$ consecutive parts $P^{(0)}, \dots, P^{(l-1)}$ of $n_j \leq k$ input pairs for each $0 \leq j \leq l-1$. The carry bits are again computed using the alternating split (Theorem 2.27). Hence, we compute an adder circuit $A_{n_j}^j$ on $P^{(j)}$ for all $0 \leq j \leq l-1$, an AND-prefix circuit $S_{n_j}^j$ on the propagate signals of $P^{(j)}$ and an AND-OR path circuit $AOP_{N_j}^j$ on the $N_j := n_0 + \dots + n_{j-1}$ input pairs $P^{(j-1)} \uplus \dots \uplus P^{(0)}$ for all $1 \leq j \leq l-1$, where $P^{(j-1)} \uplus \dots \uplus P^{(0)}$ is the concatenation of the input parts $P^{(j-1)}, \dots, P^{(0)}$.

The first n_0 carry bits can be directly computed by $A_{n_0}^0$. The $(N_j + i)$ th carry bit is given by $out_i(A_{n_j}^j) \vee (out_i(S_{n_j}^j) \wedge out(AOP_{N_j}^j))$ for all $1 \leq i \leq n_j$ and $1 \leq j \leq l-1$ due to Theorem 2.27. Hence, Algorithm 2 computes all carry bits correctly.

The main difficulty in constructing a fast and small adder using this l -part adder construction framework is the construction of the AND-OR path circuits $AOP_{N_j}^j$ for $1 \leq j \leq l-1$ in line 13 of Algorithm 2. If each of these $l-1$ circuits is computed separately with a linear size each, their total size would be in $\Theta(l * n) = \Theta(n^2/k)$, which would be undesirable. The next lemma allows to compute the circuits $AOP_{N_j}^j$ more efficiently.

Lemma 5.1 ([BS24] (Cor. 4.5)). *Let n input pairs $p_0, g_0, \dots, p_{n-1}, g_{n-1}$ and a partition $P^{(0)}, \dots, P^{(l-1)}$ of the inputs pairs in $l \in \mathbb{N}$ consecutive parts be given, where each part $P^{(j)}$ contains n_j input pairs for $0 \leq j \leq l-1$. Then, we have*

$$g^*(g_{n-1}, p_{n-1}, \dots, g_1, p_1, g_0) = g^*(h^*(P^{(l-1)}), a(P^{(l-1)}), \dots, h^*(P^{(1)}), a(P^{(1)}), h^*(P^{(0)})),$$

where

$$h^*(P^{(j)}) := g^*(g_{n_0+\dots+n_{j-1}}, p_{n_0+\dots+n_{j-1}}, \dots, g_{n_0+\dots+n_{j-1}})$$

and

$$a(P^{(j)}) := \bigwedge ((p_{n_0+\dots+n_{j-1}}, \dots, p_{n_0+\dots+n_{j-1}}))$$

for all $0 \leq j \leq l-1$.

Proof. Iteratively applying the alternating split (Theorem 2.27) gives us the desired equation

$$\begin{aligned} & g^*(g_{n-1}, p_{n-1}, \dots, g_1, p_1, g_0) \\ &= h^*(P^{(l-1)}) \vee \left(a(P^{(l-1)}) \wedge g^*(P^{(l-2)} \uplus \dots \uplus P^{(0)}) \right) \\ &= h^*(P^{(l-1)}) \vee \left(a(P^{(l-1)}) \wedge \left(h^*(P^{(l-2)}) \vee \left(a(P^{(l-2)}) \wedge \left(\dots \vee \left(a(P^{(1)}) \wedge h^*(P^{(0)}) \right) \dots \right) \right) \right) \right) \end{aligned}$$

$$= g^*(h^*(P^{(l-1)}), a(P^{(l-1)}), \dots, h^*(P^{(1)}), a(P^{(1)}), h^*(P^{(0)})),$$

where $P^{(l-2)} \uplus \dots \uplus P^{(0)}$ is the concatenation of $P^{(l-2)}, \dots, P^{(0)}$. \square

Figure 7 shows a circuit resulting from Lemma 5.1 for $l = 4$ input parts of 3 input pairs each. The red and green gates represent the AND-OR path circuits computed on each input part. The yellow gates depict the AND function on the propagate signals computed on the parts $P^{(1)}, \dots, P^{(l-1)}$. The blue gates represent the AND-OR path circuit whose inputs are the outputs of the other sub-circuits.

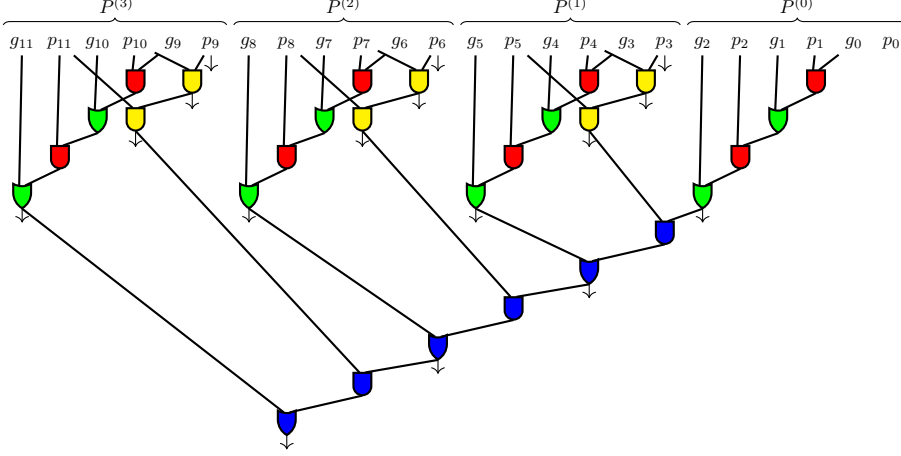

Figure 7: Illustration of Lemma 5.2 for 4 input parts with 3 input pairs each.

We can see that each AND-OR path on the input pairs $P^{(j-1)} \uplus \dots \uplus P^{(0)}$ for $1 \leq j \leq l$ can be computed by taking the output after each blue OR gate. Hence, the AND-OR path circuits AOP_{N_j} from Algorithm 2 can be realized by computing an adder circuit on the input pairs

$$\text{out}(AOP_{n_0}^0), \text{out}_{n_1}(S_{n_1}^1), \text{out}(AOP_{n_1}^1), \dots, \text{out}_{n_{l-2}}(S_{n_{l-2}}^{l-2}), \text{out}(AOP_{n_{l-2}}^{l-2}),$$

where $AOP_{n_j}^j$ is an AND-OR path circuit computed on the input part $P^{(j)}$ for $0 \leq j \leq l-1$. This idea is summarized in the next lemma.

Lemma 5.2 ([BS24] (Cor 4.6)). *In addition to the input of Algorithm 2, let a family $(B_k)_{k \in \mathbb{N}}$ of adder circuits be given. For each $j \in \{0, \dots, l-1\}$, compute an AND-OR-path circuit $AOP_{n_j}^j$ on the input part $P^{(j)}$. Compute an adder circuit B_l on the l input pairs*

$$\text{out}(AOP_{n_0}^0), \text{out}_{n_1}(S_{n_1}^1), \text{out}(AOP_{n_1}^1), \dots, \text{out}_{n_{l-1}}(S_{n_{l-1}}^{l-1}), \text{out}(AOP_{n_{l-1}}^{l-1}).$$

Then, we have $\text{out}(AOP_{N_j}^j) = \text{out}_j(B_l)$ for all $j \in \{1, \dots, l-1\}$.

Proof. This follows directly from Lemma 5.1. \square

From now on, we will always realize the And-Or path circuits AOP_{N_j} from line 13 of Algorithm 2 as indicated by Lemma 5.2 which proves to be way more efficient than computing them separately. Hence, instead of computing sub-circuits $AOP_{N_j}^j$ for all $1 \leq j \leq l-1$, we will compute sub-circuits $AOP_{n_j}^j$ on each input part $P^{(j)}$ as well as an additional adder B_l . This is the adder whose size we are going to reduce. Figure 8 shows all sub-circuits computed during Algorithm 2 using this subroutine.

Remark. We actually do not need to compute the circuit $AOP_{n_{l-1}}^{(l-1)}$ in this procedure. In order to realize the circuits $AOP_{N_j}^j$ for $1 \leq j \leq l-1$, it would suffice to compute an adder circuit B_{l-1} on the $l-1$ input pairs

$$\text{out}(AOP_{n_0}^0), \text{out}_{n_1}(S_{n_1}^1), \text{out}(AOP_{n_1}^1), \dots, \text{out}_{n_{l-2}}(S_{n_{l-2}}^{l-2}), \text{out}(AOP_{n_{l-2}}^{l-2}).$$

We include the sub-circuit $AOP_{n_{l-1}}^{(l-1)}$ since it does not harm our analysis and simplifies notation.

The next theorem formulates the delay and size bounds for the circuit resulting from Algorithm 2 combined with Lemma 5.2 in terms of the delay and size of the computed sub-circuits.

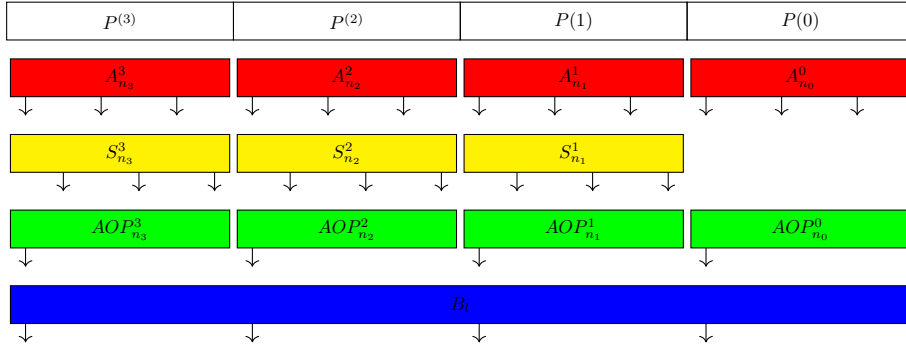

Figure 8: Visualization of the computed sub-circuits during Algorithm 2 combined with Lemma 5.2 for 4 input parts.

Theorem 5.3. *Let $n \in \mathbb{N}$ with $n \geq 2$, two families of adder circuits $(A_k)_{k \in \mathbb{N}}$ and $(B_l)_{l \in \mathbb{N}}$, a family of AND-OR-path circuits $(AOP_k)_{k \in \mathbb{N}}$ and a family of AND-prefix circuits $(S_k)_{k \in \mathbb{N}}$ be given. Using Lemma 5.2 for the computation of the AND-OR-paths in line 13, Algorithm 2 computes an adder circuit C_n on n input pairs with given arrival times with delay*

$$\text{del}(C_n) \leq \max \left\{ \text{del}(A_{n_0}^0), \widetilde{\text{del}}(B_l) + 2, \max_{j \in \{1, \dots, l-1\}} \{ \text{del}(A_{n_j}^j) + 1, \text{del}(S_{n_j}^j) + 2 \} \right\}$$

and size

$$s(C_n) \leq s(A_{n_0}^0) + s(AOP_{n_0}^0) + \sum_{j=1}^{l-1} (s(A_{n_j}^j) + s(AOP_{n_j}^j) + s(S_{n_j}^j)) + s(B_l) + 2n,$$

where $\widetilde{\text{del}}(B_l)$ is the delay of B_l computed on the input pairs

$$\text{out}(AOP_{n_0}^0), \text{out}_{n_1}(S_{n_1}^1), \text{out}(AOP_{n_1}^1), \dots, \text{out}_{n_{l-1}}(S_{n_{l-1}}^{l-1}), \text{out}(AOP_{n_{l-1}}^{l-1}).$$

Proof. The delay of C_n can be bounded by the maximum delay of any of the output signals. Therefore, we have

$$\text{del}(C_n) \leq \max \left\{ \text{del}(A_{n_0}^0), \max_{j \in \{1, \dots, l-1\}} \left\{ \text{del}(A_{n_j}^j) + 1, \text{del}(S_{n_j}^j) + 2, \text{del}(AOP_{N_j}^j) + 2 \right\} \right\}.$$

Since we use Lemma 5.2 for the computation of the output of the circuits $AOP_{N_j}^j$, we can substitute the quantities $\text{del}(AOP_{N_j}^j)$ with $\widetilde{\text{del}}(B_l)$ for all $j \in \{1, \dots, l-1\}$ and achieve the desired delay bound.

For the size bound, we add the sizes of all sub-circuits needed in our algorithm, including the circuits $AOP_{n_j}^j$ and B_l introduced in Lemma 5.2. Moreover, we need $\sum_{j=1}^{l-1} 2n_j \leq 2n$ additional gates arising from line 15 of Algorithm 2. Combined we achieve the desired size bound. \square

In the following, we explain why this construction can help to reduce the size of any adder circuit, in particular the circuit from Theorem 4.5, while increasing the delay only by a small amount. As hinted at before, the circuit B_l , introduced in Lemma 5.2, is the adder whose size is going to be reduced. Note that B_l gets $l = \lceil \frac{n}{k} \rceil$ input pairs whereas the other sub-circuits get k inputs or input pairs. If the size of B_l is bounded by $l\sigma(l)$ for some sub-linear, increasing function σ , then it would be linear in n if we chose $k = \lceil \sigma(n) \rceil$ because in this case we would have $l\sigma(l) \in \mathcal{O}(\frac{n}{k}\sigma(l)) = \mathcal{O}(n)$. If we chose the other sub-circuits to be linear as well, then Theorem 5.3 implies that we would get a linear size circuit in the end. Hence, we get a general linearization framework for any adder circuit with sub-quadratic size, which we will describe more precisely in Section 5.3. But first, we will reduce the size of our circuit from Theorem 4.5 by a factor of $\log_2 n$ to a size in $\mathcal{O}(n \log_2 n)$ in the next section.

5.2 Smaller Adder Circuits

In this section, we are going to construct an adder circuit with a delay of at most $\log_2 W + 3 \log_2 \log_2 n + 3 \log_2 \log_2 \log_2 n + \text{const}$ and a size of $\mathcal{O}(n \log_2 n)$ on n input pairs with weight W . This is done by using the l -part adder construction framework described in the previous section with the adder from Theorem 4.5 as the adder B_l from Lemma 5.2. In order to reduce the size of this adder by a factor of $\log_2 n$, we choose $k = \lceil \log_2 \rceil$ as the size of the input parts. Before we specifically compute the smaller adder in Section 5.2.2, we provide a general construction which reduces the size of any circuit with size $n \log_2 n \sigma(n)$ by the factor $\sigma(n)$ while increasing its delay by a summand of order $\mathcal{O}(\log_2 \log_2 \sigma(n))$ for some sub-linear, increasing function σ .

5.2.1 General Construction

Theorem 5.4. *Let $l \in \mathbb{N}$ with $l \geq 2$. Assume that for any given input pairs $p_0, g_0, \dots, p_{l-1}, g_{l-1}$ with arrival times $a : \{p_0, g_0 \dots p_{l-1}, g_{l-1}\} \rightarrow \mathbb{N}$ and weight W_l , we can construct an adder circuit B_l with delay*

$$\text{del}(B_l) \in [\log_2 W_l + \delta(l) - 1, \log_2 W_l + \delta(l)]$$

and size

$$s(B_l) \leq l \log_2(l) \sigma(l)$$

for all $l \in \mathbb{N}$, where $\delta, \sigma : \mathbb{N} \rightarrow \mathbb{R}_{\geq 0}$ are monotonely increasing functions. Then, for any $n \in \mathbb{N}$ and input pairs $p_0, g_0, \dots, p_{n-1}, g_{n-1}$ with arrival times $a : \{p_0, g_0 \dots p_{n-1}, g_{n-1}\} \rightarrow \mathbb{N}$ and weight W , there is an adder circuit C_n with a size in $\mathcal{O}(n \log_2 n)$ and delay

$$\text{del}(C_n) \leq \max\{\log_2 W + \log_2 \sigma(n) + \log_2 \log_2 \sigma(n), \text{del}(B_n) + 3 \log_2 \log_2 \sigma(n)\} + \text{const.}$$

Remark. It is reasonable to assume that there is a non-negative and monotonely increasing function δ such that $\text{del}(B_l) \in [\log_2 W_l + \delta(l) - 1, \log_2 W_l + \delta(l)]$ since $\text{del}(B_l) \geq \log_2 W_l - 1$ for any given arrival times due to Proposition 2.29. Furthermore, the delay of a circuit can artificially be increased by adding unnecessary gates.

Proof. We apply Algorithm 2 combined with Lemma 5.2 to our inputs with the given adder family $(B_l)_{l \in \mathbb{N}}$ and the following other families of sub-circuits:

- For the family of adder circuits $(A_k)_{k \in \mathbb{N}}$, we use the depth-optimizing circuits from Theorem 2.34, with bounds

$$\begin{aligned} \text{del}(A_k) &\stackrel{\text{Cor. 2.40 (a)}}{\leq} \log_2 W + \log_2 k + \log_2 \log_2 k + 2.65, \\ s(A_k) &\leq 6.2k \log_2 k. \end{aligned} \quad (31)$$

- We use the AND-OR-path circuits $(AOP_k)_{k \in \mathbb{N}}$ from Theorem 2.37. On k input pairs the circuit has less than $2k$ inputs which leads to the delay and size bounds

$$\begin{aligned} \text{del}(AOP_k) &\leq \log_2 W + \log_2 \log_2(2k) + \log_2 \log_2 \log_2(2k) + 4.3, \\ s(AOP_k) &\leq 2k \log_2(2k) + 2k \log_2 \log_2(2k) + 2k \log_2 \log_2 \log_2(2k) + 6.6k - 1. \end{aligned} \quad (32)$$

- For the family of AND-prefix circuits $(S_k)_{k \in \mathbb{N}}$ we use the circuits by Rautenbach, Szegedy and Werber (Theorem 3.4) which guarantee the delay and size bounds

$$\begin{aligned} \text{del}(S_k) &\leq \log_2 W + 3 \log_2 \log_2 k + 0.007, \\ s(S_k) &\leq 3.114k \log_2 \log_2 k. \end{aligned} \quad (33)$$

We choose $k := \lceil \sigma(n) \rceil$. Then, $l = \lceil \frac{n}{k} \rceil \leq \lceil \frac{n}{\sigma(n)} \rceil$ which implies that

$$s(B_l) \leq l \log_2(l) \sigma(l) \leq \left\lceil \frac{n}{\sigma(n)} \right\rceil \log_2(n) \sigma(n) \in \mathcal{O}(n \log_2 n).$$

Since the sizes of the sub-circuits A_k, AOP_k and S_k are in $\mathcal{O}(k \log_2 k)$, we have

$$\begin{aligned} s(C_n) &\stackrel{\text{Thm. 5.3}}{\leq} s(A_{n_0}^0) + s(AOP_{n_0}^0) + \sum_{j=1}^{l-1} (s(A_{n_j}^j) + s(AOP_{n_j}^j) + s(S_{n_j}^j)) + s(B_l) + 2n \\ &\stackrel{n_j \leq k}{\in} \mathcal{O}(l * k \log_2 k + n \log_2 n + n) \\ &= \mathcal{O}(n \log_2 n). \end{aligned}$$

In order to bound the delay of C_n , we first have to examine the weight \widetilde{W} of the input pairs

$$\text{out}(AOP_{n_0}^0), \text{out}_{n_1}(S_{n_1}^1), \text{out}(AOP_{n_1}^1), \dots, \text{out}_{n_{l-2}}(S_{n_{l-2}}^{l-2}), \text{out}(AOP_{n_{l-2}}^{l-2})$$

which are the inputs of our given circuit B_l . Their arrival times are bounded by the delay of the corresponding circuits. For the propagate signal with index 0 we can implicitly assume an arrival time of 0.

We calculate

$$\begin{aligned}
\widetilde{W} &\leq \sum_{j=1}^{l-1} \left(2^{\text{del}(AOP_{n_j}^j)} + 2^{\text{del}(S_{n_j}^j)} \right) + 2^{\text{del}(AOP_{n_0}^0)} + 2^0 \\
&\stackrel{(32),(33)}{\leq} \sum_{j=0}^{l-1} \left(2^{\log_2 W_{P^{(j)}} + \log_2 \log_2(2n_j) + \log_2 \log_2 \log_2(2n_j) + 4.3} \right) + \sum_{j=1}^{l-1} \left(2^{\log_2 W_{P^{(j)}} + 3 \log_2 \log_2 n_j + 0.007} \right) + 1 \\
&\stackrel{n_j \leq k}{\leq} \sum_{j=0}^{l-1} \left(W_{P^{(j)}} \log_2(2k) \log_2 \log_2(2k) * 2^{4.3} \right) + \sum_{j=1}^{l-1} \left(W_{P^{(j)}} \log_2^3 k * 2^{0.007} \right) + 1 \\
&\leq \sum_{j=0}^{l-1} \left(W_{P^{(j)}} \log_2(2k) \log_2 \log_2(2k) * 2^{4.3} + W_{P^{(j)}} \log_2^3 k * 2^{0.007} \right) \\
&\stackrel{(*)}{\leq} \sum_{j=0}^{l-1} \text{const} * W_{P^{(j)}} \log_2^3 k \\
&\stackrel{k = \lceil \sigma(n) \rceil}{\leq} \text{const} * W \log_2^3 \sigma(n),
\end{aligned}$$

where we used at (*) that $\log_2^3 k$ grows faster in k than $\log_2(2k) \log_2 \log_2(2k)$. For the delay of B_l we now get

$$\begin{aligned}
\widetilde{\text{del}}(B_l) &\leq \log_2 \widetilde{W} + \delta(l) \\
&\leq \text{const} + \log_2 W + 3 \log_2 \log_2 \sigma(n) + \delta(l) \\
&\stackrel{l \leq n}{\leq} \log_2 W + \delta(n) + 3 \log_2 \log_2 \sigma(n) + \text{const} \\
&\leq \text{del}(B_n) + 3 \log_2 \log_2 \sigma(n) + \text{const}.
\end{aligned} \tag{34}$$

Finally, we can combine our delay bounds for the sub-circuits to get the overall delay bound

$$\begin{aligned}
\text{del}(C_n) &\stackrel{\text{Thm. 5.3}}{\leq} \max \left\{ \text{del}(A_{n_0}^0), \widetilde{\text{del}}(B_l) + 2, \max_{j \in \{1, \dots, l-1\}} \{ \text{del}(A_{n_j}^j) + 1, \text{del}(S_{n_j}^j) + 2 \} \right\} \\
&\stackrel{(31), (33), (34)}{\leq} \max \left\{ \log_2 W_{P^{(0)}} + \log_2 n_0 + \log_2 \log_2 n_0 + 2.65, \right. \\
&\quad \text{del}(B_n) + 3 \log_2 \log_2 \sigma(n) + \text{const} + 2, \\
&\quad \max_{j \in \{1, \dots, l-1\}} \{ \log_2 W_{P^{(j)}} + \log_2 n_j + \log_2 \log_2 n_j + 3.65, \\
&\quad \left. \log_2 W_{P^{(j)}} + 3 \log_2 \log_2 n_j + 2.007 \} \right\} \\
&\stackrel{\substack{n_j \leq k, \\ W_{P^{(j)}} \leq W}}{\leq} \max \{ \log_2 W + \log_2 k + \log_2 \log_2 k, \text{del}(B_n) + 3 \log_2 \log_2 \sigma(n), \\
&\quad \log_2 W + 3 \log_2 \log_2 k \} + \text{const} \\
&\stackrel{\substack{k = \lceil \sigma(n) \rceil, \\ \text{del}(B_n) \geq \log_2 W}}{\leq} \max \{ \log_2 W + \log_2 \sigma(n) + \log_2 \log_2 \sigma(n), \text{del}(B_n) + 3 \log_2 \log_2 \sigma(n) \} + \text{const}.
\end{aligned}$$

This concludes the proof of the theorem. \square

5.2.2 Size $\mathcal{O}(n \log_2 n)$ Adder Construction

In this section, we will construct a new adder using Theorem 5.4 and the adder from Theorem 4.5 as B_l . Hence, we have $\sigma(n) = 2.422 \log_2 n$ and $\delta(n) = 3 \log_2 \log_2 n + 5.007$ in Theorem 5.4. Thus, we expect a delay increase of $3 \log_2 \log_2 \log_2 n$ plus some constant, compared to the adder from Theorem 4.5, and a size of $\mathcal{O}(n \log_2 n)$.

Before we can prove the specific delay and size bounds, we first need some numerical lemmas. The first lemma is required for smaller instances for which we will not use the l -part adder construction framework.

Lemma 5.5. *Assume that $n \in \mathbb{N}$ with $3 \leq n \leq 2^{21}$. Then*

$$\log_2 n \leq 2 \log_2 \log_2 n + 3 \log_2 \log_2 \log_2 n + 5.811.$$

Proof. The statement can be easily verified for $n = 3$. If $n \geq 4$ then both $\log_2 \log_2 n$ and $\log_2 \log_2 \log_2 n$ are non-negative, so the statement is clear for $\log_2 n \leq 5.811$. If $5.811 < \log_2 n \leq 2^e \leq 6.6$ then the statement follows from $2 \log_2 \log_2(n) > 2 \log_2(5.811) > 2$. Hence, assume $\log_2 n \geq 2^e$. Then, by Lemma 4.2, both $n \mapsto \frac{\log_2 \log_2 n}{\log_2 n}$ and $n \mapsto \frac{\log_2 \log_2 \log_2 n}{\log_2 \log_2 n}$ are decreasing. Thus, we can conclude:

$$\begin{aligned} 2 \log_2 \log_2 n + 3 \log_2 \log_2 \log_2 n &\geq 2 \frac{\log_2 \log_2(2^{21})}{\log_2(2^{21})} \log_2 n + 3 \frac{\log_2 \log_2 \log_2(2^{21})}{\log_2 \log_2(2^{21})} \frac{\log_2 \log_2(2^{21})}{\log_2(2^{21})} \log_2 n \\ &= 2 \frac{\log_2 \log_2(2^{21})}{\log_2(2^{21})} \log_2 n + 3 \frac{\log_2 \log_2 \log_2(2^{21})}{\log_2(2^{21})} \log_2 n \\ &\geq (2 \cdot 0.20915 + 3 \cdot 0.101666) \log_2 n \geq 0.72329 \log_2 n \\ &= \log_2 n - 0.27671 \log_2 n \geq \log_2 n - 0.27671 \cdot 21 \geq \log_2 n - 5.811 \quad \square \end{aligned}$$

Lemma 5.6. *Assume that $n, k \in \mathbb{N}$ with $n > 2^{21}$ and $k = \lceil \log_2 n \rceil$. Then, the following inequalities hold:*

- (i) $2^{4.3} \log_2(2k) \log_2 \log_2(2k) \leq 2.97 \log_2^3 k$,
- (ii) $\log_2 k \leq 1.016 \log_2 \log_2 n$,
- (iii) $\log_2 \log_2 k \leq \log_2 \log_2 \log_2 n + 0.023$,
- (iv) $\log_2 \log_2 k \leq 0.492 \log_2 \log_2 n$,
- (v) $\log_2(2k) + \log_2 \log_2(2k) + \log_2 \log_2 \log_2(2k) + 3.3 \leq 2.851 \log_2 \log_2 n$.

Proof. First, note that $k \geq 22$.

- (i) Using $k \geq 22$, we get

$$\begin{aligned} \log_2(2k) \log_2 \log_2(2k) &\stackrel{\text{Lem. 4.2}}{\leq} \log_2(2k) \frac{\log_2 \log_2(2 \cdot 22)}{\log_2(2 \cdot 22)} \log_2(2k) = \frac{\log_2 \log_2(2 \cdot 22)}{\log_2(2 \cdot 22)} (\log_2(k) + 1)^2 \\ &\leq \frac{\log_2 \log_2(2 \cdot 22)}{\log_2(2 \cdot 22)} \left(1 + \frac{1}{\log_2(22)}\right)^2 \log_2^2(k) \\ &\leq \frac{\log_2 \log_2(2 \cdot 22)}{\log_2(2 \cdot 22) \log_2(22)} \left(1 + \frac{1}{\log_2(22)}\right)^2 \log_2^3(k) \leq 0.15075 \log_2^3(k), \end{aligned}$$

and therefore $2^{4.3} \log_2(2k) \log_2 \log_2(2k) \leq 2^{4.3} 0.15075 \log_2^3(k) \leq 2.97 \log_2^3(k)$

- (ii) For the second statement, we calculate

$$\begin{aligned} \log_2 k &\leq \log_2(\log_2 n + 1) \stackrel{\log_2 n \geq 21}{\leq} \log_2 \left(\left(1 + \frac{1}{21}\right) \log_2 n \right) \leq 0.068 + \log_2 \log_2 n \\ &\leq \left(1 + \frac{0.068}{\log_2 21}\right) \log_2 \log_2 n \leq 1.016 \log_2 \log_2 n. \end{aligned}$$

- (iii) We use statement (ii) to prove the third statement. We have

$$\log_2 \log_2 k \stackrel{(ii)}{\leq} \log_2(1.016 \log_2 \log_2 n) \leq \log_2 \log_2 \log_2 n + 0.023.$$

- (iv) For the next statement, it suffices to show that $\log_2 \log_2 k \leq 0.484 \log_2 k$. The statement then follows from (ii). Indeed, we have

$$\log_2 \log_2 k \stackrel{\text{Lem. 4.2, } k \geq 22}{\leq} \frac{\log_2 \log_2 22}{\log_2 22} \log_2 k \leq 0.484 \log_2 k.$$

- (v) We prove the last statement by examining the expression term by term. We get

$$\log_2(2k) \stackrel{(ii)}{\leq} 1.016 \log_2 \log_2 n + 1, \quad (35)$$

$$\log_2 \log_2(2k) \stackrel{\text{Lem. 4.2, } k \geq 22}{\leq} \frac{\log_2 \log_2 44}{\log_2 44} \log_2(2k) \stackrel{(35)}{\leq} 0.456 \log_2 \log_2 n + 0.449, \quad (36)$$

$$\log_2 \log_2 \log_2(2k) \stackrel{\text{Lem. 4.2}}{\leq} 0.531 \log_2 \log_2(2k) \stackrel{(36)}{\leq} 0.243 \log_2 \log_2 n + 0.239$$

Summing up the above inequalities results in the desired bound

$$\begin{aligned} \log_2(2k) + \log_2 \log_2(2k) + \log_2 \log_2 \log_2(2k) + 3.3 &\leq 1.715 \log_2 \log_2 n + 4.988 \\ &\stackrel{n \geq 2^{21}}{\leq} \left(1.715 + \frac{4.988}{\log_2 21}\right) \log_2 \log_2 n \\ &\leq 2.851 \log_2 \log_2 n. \end{aligned} \quad \square$$

Lemma 5.7. *Assume that $n, k, l \in \mathbb{N}$ with $n > 2^{21}$, $k = \lceil \log_2 n \rceil$ and $l = \lceil \frac{n}{k} \rceil$. Then, we have*

$$2.422l \log_2^2 l \leq 2.422n \log_2 n - 4.336n \log_2 \log_2 n.$$

Proof. We start this proof by bounding l and $\log_2 l$ in terms of n . We calculate

$$\begin{aligned} l &\leq \frac{n}{k} + 1 \leq \frac{n}{\log_2 n} + 1 \stackrel{n \geq 2^{21}}{\leq} \left(1 + \frac{21}{2^{21}}\right) \frac{n}{\log_2 n} \leq 1.0001 \frac{n}{\log_2 n}, \\ \log_2 l &\leq \log_2 n - \log_2 \log_2 n + \log_2 1.0001 \leq \log_2 n - \log_2 \log_2 n + 0.0002 \\ &\stackrel{n \geq 2^{21}}{\leq} \log_2 n - \left(1 - \frac{0.0002}{\log_2 21}\right) \log_2 \log_2 n \leq \log_2 n - 0.9999 \log_2 \log_2 n. \end{aligned}$$

Now, we use these inequalities to calculate

$$\begin{aligned} 2.422l \log_2^2 l &\leq 2.422 \frac{n}{\log_2 n} (\log_2 n - 0.9999 \log_2 \log_2 n)^2 \\ &\leq 2.422 \frac{n}{\log_2 n} (\log_2^2 n - 1.9998 \log_2 n \log_2 \log_2 n + 0.9999 \log_2^2 \log_2 n) \\ &\stackrel{\text{Lem. 4.2, } n \geq 2^{21}}{\leq} 2.422 \frac{n}{\log_2 n} \left(\log_2^2 n - \log_2 n \log_2 \log_2 n \left(1.9998 - \frac{0.9999 \log_2 21}{21}\right) \right) \\ &\leq 2.422 \frac{n}{\log_2 n} (\log_2^2 n - 1.7906 \log_2 n \log_2 \log_2 n) \\ &\leq 2.422n \log_2 n - 4.336n \log_2 \log_2 n. \end{aligned} \quad \square$$

Now, we are ready to prove specific delay and size bounds for our second adder construction.

Theorem 5.8. *Let $n \in \mathbb{N}$ with $n \geq 3$ and input pairs $p_0, g_0, \dots, p_{n-1}, g_{n-1}$ with arrival times $a : \{p_0, g_0, \dots, p_{n-1}, g_{n-1}\} \rightarrow \mathbb{N}$ be given and let $W = \left(\sum_{i=0}^{n-1} 2^{a(p_i)} + 2^{a(g_i)}\right)$ be the weight of the input pairs. We can construct an adder circuit C_n on these input pairs with delay*

$$\text{del}(C_n) \leq \log_2 W + 3 \log_2 \log_2 n + 3 \log_2 \log_2 \log_2 n + d_1$$

and size

$$s(C_n) \leq d_2 n \log_2 n$$

in polynomial time where $d_1 = \begin{cases} 8.461 & \text{if } n \leq 2^{21}, \\ 9.067 & \text{otherwise,} \end{cases}$ and $d_2 = \begin{cases} 6.2 & \text{if } n \leq 2^{21}, \\ 4.442 & \text{otherwise.} \end{cases}$

Proof. First, assume that $3 \leq n \leq 2097152 = 2^{21}$. In this case we use the depth-optimizing adder circuit from Theorem 2.34 as C_n . It fulfills the desired bounds

$$\text{del}(C_n) \stackrel{\text{Cor. 2.40 (a)}}{\leq} \log_2 W + \log_2 n + \log_2 \log_2 n + 2.65 \stackrel{\text{Lem. 5.5}}{\leq} \log_2 W + 3 \log_2 \log_2 n + 3 \log_2 \log_2 \log_2 n + d_1$$

and

$$s(C_n) \leq d_2 n \log_2 n$$

for $d_1 \geq 8.461$ and $d_2 \geq 6.2$.

Hence, assume that $n > 2^{21}$. Here, we apply Algorithm 2 combined with Lemma 5.2 with the same families of sub-circuits used in the proof of Theorem 5.4:

- For the family of adder circuits $(A_k)_{k \in \mathbb{N}}$ we again use the depth-optimizing circuits from Theorem 2.34, with the delay and size bounds

$$\text{del}(A_k) \stackrel{\text{Cor. 2.40 (a)}}{\leq} \log_2 W + \log_2 k + \log_2 \log_2 k + 2.65, \quad (37)$$

$$s(A_k) \leq 6.2k \log_2 k. \quad (38)$$

- The AND-OR-path circuits from Theorem 2.37 are again used as the circuits $(AOP_k)_{k \in \mathbb{N}}$ which gives us the delay and size bounds

$$\text{del}(AOP_k) \leq \log_2 W + \log_2 \log_2(2k) + \log_2 \log_2 \log_2(2k) + 4.3, \quad (39)$$

$$s(AOP_k) \leq 2k \log_2(2k) + 2k \log_2 \log_2(2k) + 2k \log_2 \log_2 \log_2(2k) + 6.6k - 1. \quad (40)$$

- For the family of AND-prefix circuits $(S_k)_{k \in \mathbb{N}}$ we again use the circuits by Rautenbach, Szegedy and Werber (Theorem 3.4) which guarantee the delay and size bounds

$$\text{del}(S_k) \leq \log_2 W + 3 \log_2 \log_2 k + 0.007, \quad (41)$$

$$s(S_k) \leq 3.114k \log_2 \log_2 k. \quad (42)$$

- For the family of adder circuits $(B_l)_{l \in \mathbb{N}}$, introduced in Lemma 5.2, we now use the adder circuits constructed in Theorem 4.5 with the respective constants given in Theorem 4.5. We have the delay and size bounds

$$\text{del}(B_l) \leq \log_2 W + 3 \log_2 \log_2 l + 5.007, \quad (43)$$

$$s(B_l) \leq 2.422l \log_2^2 l. \quad (44)$$

We choose $k := \lceil \log_2 n \rceil$. Then $k \geq 22$ and $l = \lceil \frac{n}{k} \rceil \leq \lceil \frac{n}{\log_2 n} \rceil$.

First, we bound the delay of C_n . We start by bounding the weight \widetilde{W} of the input pairs

$$\text{out}(AOP_{n_0}^0), \text{out}_{n_1}(S_{n_1}^1), \text{out}(AOP_{n_1}^1), \dots, \text{out}_{n_{l-2}}(S_{n_{l-2}}^{l-2}), \text{out}(AOP_{n_{l-2}}^{l-2})$$

via a similar calculation as in the proof of Theorem 5.4. We have

$$\begin{aligned} \widetilde{W} &\leq \sum_{j=1}^{l-1} \left(2^{\text{del}(AOP_{n_j}^j)} + 2^{\text{del}(S_{n_j}^j)} \right) + 2^{\text{del}(AOP_{n_0}^0)} + 2^0 \\ &\stackrel{(39),(41)}{\leq} \sum_{j=0}^{l-1} \left(2^{\log_2 W_{P(j)} + \log_2 \log_2(2n_j) + \log_2 \log_2 \log_2(2n_j) + 4.3} \right) + \sum_{j=1}^{l-1} \left(2^{\log_2 W_{P(j)} + 3 \log_2 \log_2 n_j + 0.007} \right) + 1 \\ &\stackrel{n_j \leq k}{\leq} \sum_{j=0}^{l-1} \left(W_{P(j)} \log_2(2k) \log_2 \log_2(2k) * 2^{4.3} + W_{P(j)} \log_2^3 k * 2^{0.007} \right) \\ &\stackrel{\text{Lem. 5.6 (i)}}{\leq} \sum_{j=0}^{l-1} \left(W_{P(j)} \log_2^3 k * 2.97 + W_{P(j)} \log_2^3 k * 2^{0.007} \right) \\ &\leq \sum_{j=0}^{l-1} 3.975 * W_{P(j)} \log_2^3 k \\ &\leq 3.975W \log_2^3 k. \end{aligned} \quad (45)$$

For the delay of B_l on the inputs with weight \widetilde{W} we get

$$\begin{aligned} \widetilde{\text{del}}(B_l) &\stackrel{(43)}{\leq} \log_2 \widetilde{W} + 3 \log_2 \log_2 l + 5.007 \\ &\stackrel{l \leq n, (45)}{\leq} \log_2 W + 3 \log_2 \log_2 n + 3 \log_2 \log_2 k + 6.998. \end{aligned} \quad (46)$$

Now, we note that

$$\begin{aligned} \text{del}(A_{n_j}^j) &\stackrel{(37)}{\leq} \log_2 W_{P(j)} + \log_2 n_j + \log_2 \log_2 n_j + 2.65 \\ &\stackrel{n_j \leq k, W_{P(j)} \leq W}{\leq} \log_2 W + \log_2 k + \log_2 \log_2 k + 2.65 \\ &\leq \log_2 W + 3 \log_2 \log_2 n + 3 \log_2 \log_2 k + 6.998 \end{aligned} \quad (47)$$

for $j \in \{0, \dots, l-1\}$ and

$$\begin{aligned}
\text{del}(S_{n_j}^j) &\stackrel{(41)}{\leq} \log_2 W_{P^{(j)}} + 3 \log_2 \log_2 n_j + 0.007 \\
&\stackrel{\substack{n_j \leq k, \\ W_{P^{(j)}} \leq W}}{\leq} \log_2 W + 3 \log_2 \log_2 k + 0.007 \\
&\leq \log_2 W + 3 \log_2 \log_2 n + 3 \log_2 \log_2 k + 6.998
\end{aligned} \tag{48}$$

for $j \in \{1, \dots, l-1\}$. Finally, we use Theorem 5.3 to derive the total delay bound

$$\begin{aligned}
\text{del}(C_n) &\leq \max \left\{ \text{del}(A_{n_0}^0), \widetilde{\text{del}}(B_l) + 2, \max_{j \in \{1, \dots, l-1\}} \{ \text{del}(A_{n_j}^j) + 1, \text{del}(S_{n_j}^j) + 2 \} \right\} \\
&\stackrel{(46), (47), (48)}{\leq} \log_2 W + 3 \log_2 \log_2 n + 3 \log_2 \log_2 k + 8.998 \\
&\stackrel{\text{Lem. 5.6 (iii)}}{\leq} \log_2 W + 3 \log_2 \log_2 n + 3 \log_2 \log_2 \log_2 n + d_1
\end{aligned}$$

for $d_1 \geq 9.067$.

Next, we compute the size of the circuit C_n by first adding the sizes of our constructed sub-circuits separately, starting with the adder circuits $A_{n_j}^{(j)}$. We get

$$\sum_{j=0}^{l-1} s(A_{n_j}^j) \stackrel{(38)}{\leq} \sum_{j=0}^{l-1} 6.2n_j \log_2 n_j \stackrel{n_j \leq k}{\leq} \sum_{j=0}^{l-1} 6.2n_j \log_2 k = 6.2n \log_2 k \stackrel{\text{Lem. 5.6 (ii)}}{\leq} 6.3n \log_2 \log_2 n. \tag{49}$$

Summing up the sizes of the AND-prefix circuits $S_{n_j}^{(j)}$ results in

$$\begin{aligned}
\sum_{j=1}^{l-1} s(S_{n_j}^j) &\stackrel{(42)}{\leq} \sum_{j=1}^{l-1} 3.114n_j \log_2 \log_2 n_j \stackrel{n_j \leq k}{\leq} \sum_{j=1}^{l-1} 3.114n_j \log_2 \log_2 k \\
&= 3.114n \log_2 \log_2 k \stackrel{\text{Lem. 5.6 (iv)}}{\leq} 1.533n \log_2 \log_2 n.
\end{aligned} \tag{50}$$

The combined sizes of the AND-OR-path circuits $AOP_{n_j}^{(j)}$ are bounded by

$$\begin{aligned}
\sum_{j=0}^{l-1} s(AOP_{n_j}^j) &\stackrel{(40)}{\leq} \sum_{j=0}^{l-1} \left(2n_j \log_2(2n_j) + 2n_j \log_2 \log_2(2n_j) + 2n_j \log_2 \log_2 \log_2(2n_j) + 6.6n_j - 1 \right) \\
&\stackrel{n_j \leq k}{\leq} \sum_{j=0}^{l-1} 2n_j \left(\log_2(2k) + \log_2 \log_2(2k) + \log_2 \log_2 \log_2(2k) + 3.3 \right) \\
&= 2n \left(\log_2(2k) + \log_2 \log_2(2k) + \log_2 \log_2 \log_2(2k) + 3.3 \right) \\
&\stackrel{\text{Lem. 5.6 (v)}}{\leq} 5.702n \log_2 \log_2 n.
\end{aligned} \tag{51}$$

Finally, the size of the adder circuit B_l is bounded by

$$s(B_l) \stackrel{(44)}{\leq} 2.422l \log_2^2 l \stackrel{\text{Lem. 5.7}}{\leq} 2.422n \log_2 n - 4.336n \log_2 \log_2 n. \tag{52}$$

Now, Theorem 5.3 implies the total size bound

$$\begin{aligned}
s(C_n) &\leq s(A_{n_0}^0) + s(AOP_{n_0}^0) + \sum_{j=1}^{l-1} (s(A_{n_j}^j) + s(AOP_{n_j}^j) + s(S_{n_j}^j)) + s(B_l) + 2n \\
&\stackrel{(49), (50), (51), (52)}{\leq} 2.422n \log_2 n + 9.199n \log_2 \log_2 n + 2n \\
&\stackrel{\text{Lem. 4.2, } n \geq 2^{21}}{\leq} n \log_2 n \left(2.422 + \frac{9.199 \log_2 21}{21} + \frac{2}{21} \right) \\
&\leq d_2 n \log_2 n
\end{aligned}$$

for $d_2 \geq 4.442$.

In summary this leads to the delay and size bounds for the circuit C_n stated in the Theorem.

The only thing left to prove is the runtime. It suffices to consider the case where $n > 2^{21}$. Here, we use Algorithm 2 complemented with Lemma 5.2 where we compute a polynomial amount of sub-circuits which all have a polynomial runtime (see Theorem 2.34, Theorem 2.37, Theorem 3.4, Theorem 4.5). The rest of the algorithm is also done in polynomial runtime which leads to a polynomial runtime overall. \square

Remark. Remember that the circuit which we used as B_l in this construction has a fanout in $\mathcal{O}(\sqrt{l})$ (see the remark at the end of Section 4). Since we chose $k = \lceil \log_2 n \rceil$ in Algorithm 2, the newly constructed adder has a fanout in $\mathcal{O}\left(\sqrt{\frac{n}{\log_2 n}}\right)$.

5.3 Linear Size Adder Circuits

Now, we further reduce the size of our circuits and finally achieve a linear size adder. Note that Theorem 5.4 holds analogously if we drop the factor of $\log_2 l$ in the size of the circuit B_l . In this case, the size of the resulting circuit would be in $\mathcal{O}(n \log_2 \sigma(n))$ instead of $\mathcal{O}(n \log_2 n)$ and its delay bound would only differ in the additive constant. Hence, we can expect to construct a circuit with a similar delay bound as the circuit in Theorem 5.8 but with a size in $\mathcal{O}(n \log_2 \log_2 n)$. This is done by using the same construction as in Theorem 5.8 but with $k \in \mathcal{O}(\log_2^2 n)$ instead of $k \in \mathcal{O}(\log_2 n)$. We elaborate this idea in Section 5.3.1. Then, we will construct a circuit on n input pairs with weight W with a delay of at most $\log_2 W + 3 \log_2 \log_2 n + 3 \log_2 \log_2 \log_2 n + \text{const}$ and a size of $\mathcal{O}(n \log_2 \log_2 n)$ in Section 5.3.2. In Section 5.3.3, we apply the linearization framework to the new adder with size in $\mathcal{O}(n \log_2 \log_2 n)$ to achieve a linear size adder with a delay of at most $\log_2 W + 3 \log_2 \log_2 n + 4 \log_2 \log_2 \log_2 n + \text{const}$.

5.3.1 General Construction

Theorem 5.9. *Let $l \in \mathbb{N}$ with $l \geq 2$. Assume that for any given input pairs $p_0, g_0, \dots, p_{l-1}, g_{l-1}$ with arrival times $a : \{p_0, g_0 \dots p_{l-1}, g_{l-1}\} \rightarrow \mathbb{N}$ and weight W_l , we can construct an adder circuit B_l with delay*

$$\text{del}(B_l) \in [\log_2 W_l + \delta(l) - 1, \log_2 W_l + \delta(l)]$$

and size

$$s(B_l) \leq l\sigma(l)$$

for all $l \in \mathbb{N}$, where $\delta, \sigma : \mathbb{N} \rightarrow \mathbb{R}_{\geq 0}$ are monotonely increasing functions. Then, for any $n \in \mathbb{N}$ and input pairs $p_0, g_0, \dots, p_{n-1}, g_{n-1}$ with arrival times $a : \{p_0, g_0 \dots p_{n-1}, g_{n-1}\} \rightarrow \mathbb{N}$ and weight W , we can construct the following two circuits:

1. There is an adder circuit $C_n^{(1)}$ with size in $\mathcal{O}(n \log_2 \sigma(n))$ and delay

$$\text{del}(C_n^{(1)}) \leq \max\{\log_2 W + \log_2 \sigma(n) + \log_2 \log_2 \sigma(n), \text{del}(B_n) + 3 \log_2 \log_2 \sigma(n)\} + \text{const}.$$

2. There is an adder circuit $C_n^{(2)}$ with size in $\mathcal{O}(n)$ and delay

$$\begin{aligned} \text{del}(C_n^{(2)}) &\leq \max\{\log_2 W + \log_2 \sigma(n) + \log_2 \log_2 \sigma(n) + \log_2 \log_2 \log_2 \sigma(n), \\ &\quad \text{del}(B_n) + \log_2 \sigma(n)\} + \text{const}. \end{aligned}$$

Proof. The proof is similar to the proof of Theorem 5.4. In both cases, we apply Algorithm 2 combined with Lemma 5.2 to our inputs with the given adder family $(B_l)_{l \in \mathbb{N}}$ and we choose $k = \lceil \sigma(n) \rceil$ in Algorithm 2. For $C_n^{(1)}$ we even choose the same other sub-circuits as in the proof of Theorem 5.4. The proof of the size and delay bounds then work analogously to Theorem 5.4. The only difference is that the size of B_l is now bounded by

$$s(B_l) \leq l\sigma(l) \stackrel{l = \lceil \frac{n}{\sigma(n)} \rceil}{\leq} \left\lceil \frac{n}{\sigma(n)} \right\rceil \sigma(n) \in \mathcal{O}(n).$$

Consequently, the overall size of $C_n^{(1)}$ is in $\mathcal{O}(n \log_2 \sigma(n))$.

We now focus on the second statement. In order to achieve a linear size for the circuit $C_n^{(2)}$, we need to choose linear sub-circuits in our construction:

- For the family of adder circuits $(A_k)_{k \in \mathbb{N}}$, we use the linear size, depth-optimizing circuits from Theorem 2.36, with the delay and size bounds

$$\begin{aligned} \text{del}(A_k) &\stackrel{\text{Cor. 2.40 (c)}}{\leq} \log_2 W + \log_2 k + \log_2 \log_2 k + \log_2 \log_2 \log_2 k + 7.6, \\ s(A_k) &\leq 16.7k. \end{aligned} \quad (53)$$

- For the AND-OR-path circuits $(AOP_k)_{k \in \mathbb{N}}$, we use the construction by Spirkl from Theorem 2.38. Since the circuit AOP_k has $2k - 1$ inputs, we get the delay and size bounds

$$\begin{aligned} \text{del}(AOP_k) &\leq \log_2 W + 2\sqrt{2\log_2(2k)} + 6, \\ s(AOP_k) &\leq 6k. \end{aligned} \quad (54)$$

- For the family of AND-prefix circuits $(S_k)_{k \in \mathbb{N}}$ we use the linear size, depth-optimizing circuits by Ladner and Fischer from Theorem 2.31 with $f = 0$. They guarantee the delay and size bounds

$$\begin{aligned} \text{del}(S_k) &\stackrel{\text{Cor. 2.41 (a)}}{\leq} \log_2 W + \lceil \log_2 k \rceil, \\ s(S_k) &\leq 4k. \end{aligned} \quad (55)$$

As in the first statement, the size of B_l is linear. Since the other sub-circuits are also linear, we get the linear overall size bound

$$s(C_n^{(2)}) \stackrel{\text{Thm. 5.3}}{\leq} s(A_{n_0}^0) + s(AOP_{n_0}^0) + \sum_{j=1}^{l-1} (s(A_{n_j}^j) + s(AOP_{n_j}^j) + s(S_{n_j}^j)) + s(B_l) + 2n \stackrel{n_j \leq k}{\in} \mathcal{O}(l * k + n) = \mathcal{O}(n).$$

Next, we again have to compute the weight \widetilde{W} of the input pairs

$$\text{out}(AOP_{n_0}^0), \text{out}_{n_1}(S_{n_1}^1), \text{out}(AOP_{n_1}^1), \dots, \text{out}_{n_{l-2}}(S_{n_{l-2}}^{l-2}), \text{out}(AOP_{n_{l-2}}^{l-2})$$

of the circuit B_l in order to compute the delay of B_l . We have

$$\begin{aligned} \widetilde{W} &\leq \sum_{j=1}^{l-1} \left(2^{\text{del}(AOP_{n_j}^j)} + 2^{\text{del}(S_{n_j}^j)} \right) + 2^{\text{del}(AOP_{n_0}^0)} + 2^0 \\ &\stackrel{(54),(55)}{\leq} \sum_{j=0}^{l-1} \left(2^{\log_2 W_{P^{(j)}} + 2\sqrt{2\log_2(2n_j)} + 6} \right) + \sum_{j=1}^{l-1} \left(2^{\log_2 W_{P^{(j)}} + \lceil \log_2 n_j \rceil} \right) + 1 \\ &\stackrel{n_j \leq k}{\leq} \sum_{j=0}^{l-1} \left(2^{\log_2 W_{P^{(j)}} + 2\sqrt{2\log_2(2k)} + 6} + 2^{\log_2 W_{P^{(j)}} + \log_2 k + 1} \right) \\ &\stackrel{(*)}{\leq} \sum_{j=0}^{l-1} (W_{P^{(j)}} (2^{\log_2 k + \text{const}} + 2^{\log_2 k + 1})) \\ &\leq \text{const} * Wk \\ &\stackrel{k = \lceil \sigma(n) \rceil}{\leq} \text{const} * W\sigma(n), \end{aligned}$$

where we used at (*) that $\log_2 k$ grows faster in k than $2\sqrt{2\log_2(2k)}$. For the delay of B_l we get

$$\begin{aligned} \widetilde{\text{del}}(B_l) &\leq \log_2 \widetilde{W} + \delta(l) \\ &\leq \text{const} + \log_2 W + \log_2 \sigma(n) + \delta(l) \\ &\stackrel{l \leq n}{\leq} \log_2 W + \delta(n) + \log_2 \sigma(n) + \text{const} \\ &\leq \text{del}(B_n) + \log_2 \sigma(n) + \text{const}. \end{aligned} \quad (56)$$

Again, we can use Theorem 5.3 to compute the overall delay bound

$$\text{del}(C_n^{(2)}) \leq \max \left\{ \text{del}(A_{n_0}^0), \widetilde{\text{del}}(B_l) + 2, \max_{j \in \{1, \dots, l-1\}} \{ \text{del}(A_{n_j}^j) + 1, \text{del}(S_{n_j}^j) + 2 \} \right\}$$

$$\begin{aligned}
& \stackrel{(53), (55), (56)}{\leq} \max \left\{ \log_2 W_{P^{(0)}} + \log_2 n_0 + \log_2 \log_2 n_0 + \log_2 \log_2 \log_2 n_0 + 7.6, \right. \\
& \quad \left. \text{del}(B_n) + \log_2 \sigma(n) + \text{const} + 2, \right. \\
& \quad \left. \max_{j \in \{1, \dots, l-1\}} \left\{ \log_2 W_{P^{(j)}} + \log_2 n_j + \log_2 \log_2 n_j \right. \right. \\
& \quad \quad \left. \left. + \log_2 \log_2 \log_2 n_j + 8.6, \log_2 W_{P^{(j)}} + \lceil \log_2 n_j \rceil \right\} \right\} \\
& \stackrel{\substack{n_j \leq k, \\ W_{P^{(j)}} \leq W}}{\leq} \max \{ \log_2 W + \log_2 k + \log_2 \log_2 k + \log_2 \log_2 \log_2 k, \\
& \quad \text{del}(B_n) + \log_2 \sigma(n), \log_2 W + \log_2 k \} + \text{const} \\
& \stackrel{k = \lceil \sigma(n) \rceil}{\leq} \max \{ \log_2 W + \log_2 \sigma(n) + \log_2 \log_2 \sigma(n) + \\
& \quad \log_2 \log_2 \log_2 \sigma(n), \text{del}(B_n) + \log_2 \sigma(n) \} + \text{const}. \quad \square
\end{aligned}$$

Now, we could already use this linearization framework (Theorem 5.9, part 2.) on one of our previously constructed adders. Assume for example that we built an adder like $C_n^{(2)}$ in the previous theorem using our adder with the delay bound $\log_2 W + 3 \log_2 \log_2 n + 5.007$ and size $\mathcal{O}(n \log_2^2 n)$ (Theorem 4.5) as B_l . Then, we would get a linear size adder circuit with a delay bound of $\log_2 W + 5 \log_2 \log_2 n + \text{const}$ since $\sigma(n) \in \mathcal{O}(\log_2^2 n)$. If we used the adder from Theorem 5.8 as B_l , we would get a linear size adder with a delay bound of $\log_2 W + 4 \log_2 \log_2 n + 3 \log_2 \log_2 \log_2 n + \text{const}$ because, in this case, $\sigma(n) \in \mathcal{O}(\log_2 n)$. Both of these circuits asymptotically improve on the previously best known delay bound for linear size adder circuits. However, we can even get a linear size and a delay of at most $\log_2 W + 3 \log_2 \log_2 n + 4 \log_2 \log_2 \log_2 n + \text{const}$ (see Section 5.3.3).

5.3.2 Size $\mathcal{O}(n \log_2 \log_2 n)$ Adder Construction

Now, we want to compute the adder $C_n^{(1)}$ as described in Theorem 5.9 with the adder from Theorem 4.5 as B_l . Because the construction is very similar to the one executed in Section 5.2.2, the delay and size computations are also similar. Hence, some of the upcoming numerical lemmas may look familiar.

Lemma 5.10. *Assume that $n \in \mathbb{N}$ with $3 \leq n \leq 2^{16}$. Then*

$$\log_2 n \leq 2 \log_2 \log_2 n + 2 \log_2 \log_2 \log_2 n + 4.$$

Proof. This lemma is proven similarly to Lemma 5.5. The statement can be easily verified for $n = 3$. If $n \geq 4$ then both $\log_2 \log_2 n$ and $\log_2 \log_2 \log_2 n$ are non-negative, so the statement is clear for $\log_2 n \leq 4$. If $4 < \log_2 n \leq 2^e \leq 6.6$ then the statement follows from $2 \log_2 \log_2(n) > 2 \log_2(4) = 4$. Hence, assume $\log_2 n \geq 2^e$. Then, by Lemma 4.2, both $n \mapsto \frac{\log_2 \log_2 n}{\log_2 n}$ and $n \mapsto \frac{\log_2 \log_2 \log_2 n}{\log_2 \log_2 n}$ are decreasing. Thus, we can conclude:

$$\begin{aligned}
2 \log_2 \log_2 n + 3 \log_2 \log_2 \log_2 n &\geq 2 \frac{\log_2 \log_2(2^{16})}{\log_2(2^{16})} \log_2 n + 2 \frac{\log_2 \log_2 \log_2(2^{16})}{\log_2(2^{16})} \log_2 n = \left(\frac{1}{2} + \frac{1}{4} \right) \log_2 n \\
&= \log_2 n - 0.25 \log_2 n \geq \log_2 n - 0.25 \cdot 16 = \log_2 n - 4 \quad \square
\end{aligned}$$

Lemma 5.11. *Assume that $n, k \in \mathbb{N}$ with $n > 2^{16}$ and $k = \lceil \log_2^2 n \rceil$. Then, the following inequalities hold:*

- (i) $2^{4.3} \log_2(2k) \log_2 \log_2(2k) \leq 1.097 \log_2^3 k$,
- (ii) $\log_2 k \leq 2.002 \log_2 \log_2 n$,
- (iii) $\log_2 \log_2 k \leq \log_2 \log_2 \log_2 n + 1.002$,
- (iv) $\log_2 \log_2 k \leq 0.751 \log_2 \log_2 n$,
- (v) $\log_2(2k) + \log_2 \log_2(2k) + \log_2 \log_2 \log_2(2k) + 3.3 \leq 4.288 \log_2 \log_2 n$.

Proof. These statements look similar to the ones from Lemma 5.6 and are proven in a similar way. First, we note that $k \geq 257$.

- (i) We can simply replace 22 by 257 in the proof of Lemma 5.6 (i) and get

$$2^{4.3} \log_2(2k) \log_2 \log_2(2k) \leq 2^{4.3} \frac{\log_2 \log_2(2 \cdot 257)}{\log_2(2 \cdot 257) \log_2(257)} \left(1 + \frac{1}{\log_2(257)} \right)^2 \log_2^3(k) \leq 1.097 \log_2^3(k)$$

(ii) For the next statement, we calculate

$$\begin{aligned} \log_2 k &\leq \log_2(\log_2^2 n + 1) \stackrel{\log_2^2 n \geq 256}{\leq} \log_2 \left(\left(1 + \frac{1}{256}\right) \log_2^2 n \right) \leq 0.006 + 2 \log_2 \log_2 n \\ &\leq \left(1 + \frac{0.006}{2 \log_2 16}\right) 2 \log_2 \log_2 n \leq 2.002 \log_2 \log_2 n. \end{aligned}$$

(iii) Via statement (ii) we can now easily prove the third statement. We have

$$\log_2 \log_2 k \stackrel{(ii)}{\leq} \log_2(2.002 \log_2 \log_2 n) \leq \log_2 \log_2 \log_2 n + 1.002.$$

(iv) The next statement is again easily proven with the help of statement (ii) and Lemma 4.2. We have

$$\log_2 \log_2 k \stackrel{\text{Lem. 4.2, } k \geq 257}{\leq} \frac{\log_2 \log_2 257}{\log_2 257} \log_2 k \stackrel{(ii)}{\leq} 0.751 \log_2 \log_2 n.$$

(v) The last statement is proven by examining the expression term by term. We get

$$\log_2(2k) \stackrel{(ii)}{\leq} 2.002 \log_2 \log_2 n + 1, \quad (57)$$

$$\log_2 \log_2(2k) \stackrel{\text{Lem. 4.2, } k \geq 257}{\leq} \frac{\log_2 \log_2 514}{\log_2 514} \log_2(2k) \stackrel{(57)}{\leq} 0.705 \log_2 \log_2 n + 0.353, \quad (58)$$

$$\log_2 \log_2 \log_2(2k) \stackrel{\text{Lem. 4.2, } k \geq 257}{\leq} \frac{\log_2 \log_2 \log_2 514}{\log_2 \log_2 514} \log_2 \log_2(2k) \stackrel{(58)}{\leq} 0.371 \log_2 \log_2 n + 0.186.$$

Finally, we can sum up the above inequalities to achieve the desired bound

$$\begin{aligned} \log_2(2k) + \log_2 \log_2(2k) + \log_2 \log_2 \log_2(2k) + 3.3 &\leq 3.078 \log_2 \log_2 n + 4.839 \\ &\stackrel{n \geq 2^{16}}{\leq} \left(3.078 + \frac{4.839}{\log_2 16}\right) \log_2 \log_2 n \\ &\leq 4.288 \log_2 \log_2 n. \quad \square \end{aligned}$$

Lemma 5.12. Assume that $n, k, l \in \mathbb{N}$ with $n > 2^{16}$, $k = \lceil \log_2^2 n \rceil$ and $l = \lceil \frac{n}{k} \rceil$. Then, we have

$$2.422l \log_2^2 l \leq 2.432n.$$

Proof. We first bound l in terms of n . We have

$$l \leq \frac{n}{k} + 1 \leq \frac{n}{\log_2^2 n} + 1 \stackrel{n \geq 2^{16}}{\leq} \left(1 + \frac{256}{2^{16}}\right) \frac{n}{\log_2^2 n} \leq 1.004 \frac{n}{\log_2^2 n}.$$

Now, we use this bound to calculate

$$2.422l \log_2^2 l \leq 2.432 \frac{n}{\log_2^2 n} \log_2^2 l \stackrel{l \leq n}{\leq} 2.432n. \quad \square$$

Next we can move on to our third specific adder construction.

Theorem 5.13. Let $n \in \mathbb{N}$ with $n \geq 3$ and input pairs $p_0, g_0, \dots, p_{n-1}, g_{n-1}$ with arrival times $a : \{p_0, g_0, \dots, p_{n-1}, g_{n-1}\} \rightarrow \mathbb{N}$ be given and let $W = \left(\sum_{i=0}^{n-1} 2^{a(p_i)} + 2^{a(g_i)}\right)$ be the weight of the input pairs. We can construct an adder circuit C_n on these input pairs with delay

$$\text{del}(C_n) \leq \log_2 W + 3 \log_2 \log_2 n + 3 \log_2 \log_2 \log_2 n + e_1$$

and size

$$s(C_n) \leq e_2 n \log_2 \log_2 n$$

in polynomial time for $e_1 = 11.085$ and $e_2 = 24.436$.

Proof. First, we assume that $3 \leq n \leq 65536 = 2^{16}$. In this case, we use the linear size, depth-optimizing adder circuit from Theorem 2.35, as C_n . We get the desired bounds

$$\begin{aligned} \text{del}(C_n) &\stackrel{\text{Cor. 2.40 (b)}}{\leq} \log_2 W + \log_2 n + \log_2 \log_2 n + \log_2 \log_2 \log_2 n + 6.6 \\ &\stackrel{\text{Lem. 5.10}}{\leq} \log_2 W + 3 \log_2 \log_2 n + 3 \log_2 \log_2 \log_2 n + e_1 \end{aligned}$$

and

$$s(C_n) \leq e_2 n \log_2 \log_2 n$$

for $e_1 \geq 10.6$ and $e_2 \geq 21.6$.

Now, assume that $n > 2^{16}$. Here, we apply Algorithm 2 combined with Lemma 5.2 with the same families of sub-circuits used in the proof of Theorem 5.8. Hence, the bounds (37) to (44) from the proof of Theorem 5.8 are again valid for the subcircuits.

As hinted at before, we now choose $k := \lceil \log_2^2 n \rceil$ which implies $k \stackrel{n > 2^{15}}{\geq} 257$ and $l = \lceil \frac{n}{k} \rceil \leq \lceil \frac{n}{\log_2^2 n} \rceil$.

We proceed similarly to the proof of Theorem 5.8 by first bounding the weight \widetilde{W} of the input pairs

$$\text{out}(AOP_{n_0}^0), \text{out}_{n_1}(S_{n_1}^1), \text{out}(AOP_{n_1}^1), \dots, \text{out}_{n_{l-2}}(S_{n_{l-2}}^{l-2}), \text{out}(AOP_{n_{l-2}}^{l-2})$$

of B_l . We get

$$\begin{aligned} \widetilde{W} &\leq \sum_{j=1}^{l-1} \left(2^{\text{del}(AOP_{n_j}^j)} + 2^{\text{del}(S_{n_j}^j)} \right) + 2^{\text{del}(AOP_{n_0}^0)} + 2^0 \\ &\stackrel{(39),(41)}{\leq} \sum_{j=0}^{l-1} \left(2^{\log_2 W_{P^{(j)}} + \log_2 \log_2(2n_j) + \log_2 \log_2 \log_2(2n_j) + 4.3} \right) + \sum_{j=1}^{l-1} \left(2^{\log_2 W_{P^{(j)}} + 3 \log_2 \log_2 n_j + 0.007} \right) + 1 \\ &\stackrel{n_j \leq k}{\leq} \sum_{j=0}^{l-1} \left(W_{P^{(j)}} \log_2(2k) \log_2 \log_2(2k) * 2^{4.3} + W_{P^{(j)}} \log_2^3 k * 2^{0.007} \right) \\ &\stackrel{\text{Lem. 5.11 (i)}}{\leq} \sum_{j=0}^{l-1} \left(W_{P^{(j)}} \log_2^3 k * 1.097 + W_{P^{(j)}} \log_2^3 k * 2^{0.007} \right) \\ &\leq 2.102W \log_2^3 k. \end{aligned} \tag{59}$$

The circuit B_l then has delay

$$\begin{aligned} \widetilde{\text{del}}(B_l) &\stackrel{(43)}{\leq} \log_2 \widetilde{W} + 3 \log_2 \log_2 l + 5.007 \\ &\stackrel{l \leq n, (59)}{\leq} \log_2 W + 3 \log_2 \log_2 n + 3 \log_2 \log_2 k + 6.079. \end{aligned} \tag{60}$$

This delay again dominates the delay of the other sub-circuits since

$$\begin{aligned} \text{del}(A_{n_j}^j) &\stackrel{(37)}{\leq} \log_2 W_{P^{(j)}} + \log_2 n_j + \log_2 \log_2 n_j + 2.65 \\ &\stackrel{n_j \leq k, W_{P^{(j)}} \leq W}{\leq} \log_2 W + \log_2 k + \log_2 \log_2 k + 2.65 \\ &\stackrel{k \leq \log_2^2 n + 1}{\leq} \log_2 W + 2 \log_2 \log_2 n + \log_2 \log_2 k + 3.65 \\ &\leq \log_2 W + 3 \log_2 \log_2 n + 3 \log_2 \log_2 k + 7.079 \end{aligned} \tag{61}$$

for $j \in \{0, \dots, l-1\}$ and

$$\begin{aligned} \text{del}(S_{n_j}^j) &\stackrel{(41)}{\leq} \log_2 W_{P^{(j)}} + 3 \log_2 \log_2 n_j + 0.007 \\ &\stackrel{n_j \leq k, W_{P^{(j)}} \leq W}{\leq} \log_2 W + 3 \log_2 \log_2 k + 0.007 \\ &\leq \log_2 W + 3 \log_2 \log_2 n + 3 \log_2 \log_2 k + 6.079 \end{aligned} \tag{62}$$

for $j \in \{1, \dots, l-1\}$. Hence, Theorem 5.3 again implies the total delay bound

$$\begin{aligned} \text{del}(C_n) &\leq \max \left\{ \text{del}(A_{n_0}^0), \widetilde{\text{del}}(B_l) + 2, \max_{j \in \{1, \dots, l-1\}} \{ \text{del}(A_{n_j}^j) + 1, \text{del}(S_{n_j}^j) + 2 \} \right\} \\ &\stackrel{(60), (61), (62)}{\leq} \log_2 W + 3 \log_2 \log_2 n + 3 \log_2 \log_2 k + 8.079 \\ &\stackrel{\text{Lem. 5.11 (iii)}}{\leq} \log_2 W + 3 \log_2 \log_2 n + 3 \log_2 \log_2 \log_2 n + e_1 \end{aligned}$$

for $e_1 \geq 11.085$.

For the size bound, we again add the sizes of our computed sub-circuits separately. For the adder circuits $A_{n_j}^j$ we get

$$\sum_{j=0}^{l-1} s(A_{n_j}^j) \stackrel{(38)}{\leq} \sum_{j=0}^{l-1} 6.2n_j \log_2 n_j \stackrel{n_j \leq k}{\leq} \sum_{j=0}^{l-1} 6.2n_j \log_2 k = 6.2n \log_2 k \stackrel{\text{Lem. 5.11 (ii)}}{\leq} 12.413n \log_2 \log_2 n. \quad (63)$$

Summing up the sizes of the AND-prefix circuits $S_{n_j}^j$ results in

$$\begin{aligned} \sum_{j=1}^{l-1} s(S_{n_j}^j) &\stackrel{(42)}{\leq} \sum_{j=1}^{l-1} 3.114n_j \log_2 \log_2 n_j \stackrel{n_j \leq k}{\leq} \sum_{j=1}^{l-1} 3.114n_j \log_2 \log_2 k \\ &= 3.114n \log_2 \log_2 k \stackrel{\text{Lem. 5.11 (iv)}}{\leq} 2.339n \log_2 \log_2 n. \end{aligned} \quad (64)$$

The sizes of the AND-OR-path circuits $AOP_{n_j}^j$ are summed to at most

$$\begin{aligned} \sum_{j=0}^{l-1} s(AOP_{n_j}^j) &\stackrel{(40)}{\leq} \sum_{j=0}^{l-1} \left(2n_j \log_2(2n_j) + 2n_j \log_2 \log_2(2n_j) + 2n_j \log_2 \log_2 \log_2(2n_j) + 6.6n_j - 1 \right) \\ &\stackrel{n_j \leq k}{\leq} \sum_{j=0}^{l-1} 2n_j \left(\log_2(2k) + \log_2 \log_2(2k) + \log_2 \log_2 \log_2(2k) + 3.3 \right) \\ &= 2n \left(\log_2(2k) + \log_2 \log_2(2k) + \log_2 \log_2 \log_2(2k) + 3.3 \right) \\ &\stackrel{\text{Lem. 5.11 (v)}}{\leq} 8.576n \log_2 \log_2 n. \end{aligned} \quad (65)$$

The size of the adder circuit B_l is bounded by

$$s(B_l) \stackrel{(44)}{\leq} 2.422l \log_2^2 l \stackrel{\text{Lem. 5.12}}{\leq} 2.432n. \quad (66)$$

Combining all these inequalities, Theorem 5.3 implies the total size bound

$$\begin{aligned} s(C_n) &\leq s(A_{n_0}^0) + s(AOP_{n_0}^0) + \sum_{j=1}^{l-1} \left(s(A_{n_j}^j) + s(AOP_{n_j}^j) + s(S_{n_j}^j) \right) + s(B_l) + 2n \\ &\stackrel{(63), (64), (65), (66)}{\leq} 23.328n \log_2 \log_2 n + 4.432n \stackrel{n \geq 2^{16}}{\leq} n \log_2 \log_2 n \left(23.328 + \frac{4.432}{\log_2 16} \right) \\ &\leq e_2 n \log_2 \log_2 n \end{aligned}$$

for $e_2 \geq 24.436$.

Summarized, we can guarantee the delay and size bounds for the circuit C_n for constants $e_1 \geq 11.085$ and $e_2 \geq 24.436$.

For the runtime, It suffices to consider the case $n > 2^{16}$. Here, we have a polynomial runtime analogously to Theorem 5.8 because we use the same algorithm with the same sub-circuits. The only difference is that here we choose $k = \lceil \log_2^2 n \rceil$ instead of $k = \lceil \log_2 n \rceil$ which does not prevent a polynomial runtime. \square

Remark. Figure 9 depicts the size bounds of the circuits from Theorem 5.8 (blue curves) and Theorem 5.13 (red curve) without the factor n in each bound. We use a logarithmic scale for the number of inputs (x-axis) such that the blue curve is linear. Note that our adder with size in $\mathcal{O}(n \log_2 \log_2 n)$ only improves on our adder with size in $\mathcal{O}(n \log_2 n)$ for $50829 \leq n \leq 2097152 = 2^{21}$ and for $n \geq 58212864$, so only for large instances.

Remark. The fanout of this circuit is in $\mathcal{O}\left(\frac{\sqrt{n}}{\log_2 n}\right)$ due to the same reason as for the adder from Theorem 5.8 (see the last remark in Section 5.2) with the difference that, in this case, we have $k = \lceil \log_2^2 n \rceil$.

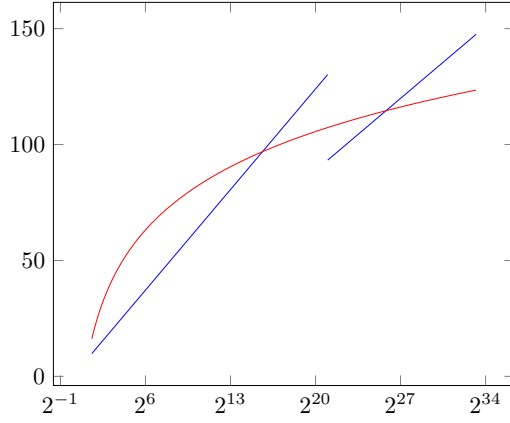

Figure 9: Comparison of the sizes of the adders from Theorem 5.8 (blue) and Theorem 5.13 (red).

5.3.3 Linear Size Adder Construction

Finally, we apply the linearization framework to our circuit from Theorem 5.13. This gives us a further delay increase of $\log_2 \log_2 \log_2 n$ plus some constant, according to Theorem 5.9, because $\sigma(n) \in \mathcal{O}(\log_2 \log_2 n)$.

But first, we examine what happens if we iteratively apply construction 1 of Theorem 5.9 to the respective next resulting circuit, starting with the adder from Theorem 5.13. In the following, we write, for any $k \in \mathbb{N}$,

$$\log_2^{(k)} x = \begin{cases} x & \text{for } k = 0, \\ \log_2(\log_2^{(k-1)} x) & \text{otherwise.} \end{cases}$$

For the first iteration, we have $\sigma(n) \in \mathcal{O}(\log_2 \log_2 n)$ and Theorem 5.9 implies an adder circuit with size in $\mathcal{O}(n \log_2 \log_2 \log_2 n)$ and a delay of at most $\log_2 W + 3 \log_2 \log_2 n + 3 \log_2 \log_2 \log_2 n + 3 \log_2 \log_2 \log_2 \log_2 n + \text{const}$. For the next iteration, we would have $\sigma(n) \in \mathcal{O}(\log_2 \log_2 \log_2 n)$, a size in $\mathcal{O}(n \log_2 \log_2 \log_2 \log_2 n)$ and a delay increase of $3 \log_2^{(5)} n$, disregarding the constants. Hence, we get the following result.

Corollary 5.14. *For any $j \in \mathbb{N}_{>2}$, we can construct a circuit with size in $\mathcal{O}(n \log_2^{(j)} n)$ and a delay of at most*

$$\log_2 W + \sum_{i=2}^{j+1} 3 \log_2^{(i)} n + \text{const}$$

on n input pairs with weight W . □

If we apply the linearization framework (part 2 of Theorem 5.9) to these circuits, we get the following result.

Corollary 5.15. *For any $j \in \mathbb{N}_{>2}$, we can construct a linear size adder circuit with a delay of at most*

$$\log_2 W + \sum_{i=2}^j 3 \log_2^{(i)} n + 4 \log_2^{(j+1)} n + \text{const}$$

on n input pairs with weight W . □

The next corollary is another immediate consequence.

Corollary 5.16. *An asymptotic upper bound on the minimum delay of a linear size adder circuit is given by*

$$\log_2 W + \sum_{i=2}^{\infty} 3 \log_2^{(i)} n. \quad \square$$

A concrete computation of the corresponding constants of these circuits would quickly become unfeasible. Therefore, we only compute specific delay and size bounds for the direct linearization of our circuit from Theorem 5.13. For this, we again need some numerical lemmas.

Lemma 5.17. *Assume that $n \in \mathbb{N}$ with $3 \leq n \leq 2^{28}$. Then*

$$\log_2 n \leq 2 \log_2 \log_2 n + 3 \log_2 \log_2 \log_2 n + 11.59.$$

Proof. This lemma is proven analogously to Lemma 5.5 by simply exchanging 2^{21} with 2^{28} . \square

Lemma 5.18. *Assume that $n, k \in \mathbb{N}$ with $n > 2^{28}$ and $k = \lceil \log_2 \log_2 n \rceil$. Then, the following inequalities hold:*

(i) *if $k \leq 1336$, then $\log_2(2k) + \log_2 \log_2(2k) \leq \log_2 k + 4.509$,*

(ii) *if $k \geq 1337$, then $2\sqrt{2\log_2(2k)} \leq \log_2 k - 0.841$,*

(iii) $\log_2 k \leq \log_2 \log_2 \log_2 n + 0.279$.

Proof. For the first statement, it suffices to verify that $\log_2 \log_2(2k) \leq 3.509$ for $k = 1336$ and, hence, for $k \leq 1336$.

We prove the second statement by verifying it for $k = 1337$ and showing that the function

$$f(x) = \log_2 x - 2\sqrt{2\log_2(2x)} - 0.841$$

is increasing for $x \geq 1337$. This is the case since the derivative of f is given by

$$f'(x) = \frac{1}{x \ln 2} - \frac{1}{\sqrt{2\log_2(2x)}} * \frac{2}{x \ln 2} = \frac{1}{x \ln 2} \left(1 - \frac{2}{\sqrt{2\log_2(2x)}} \right)$$

which is positive for $x \geq 1337$.

For the last statement, we calculate

$$\log_2 k \leq \log_2(\log_2 \log_2 n + 1) \stackrel{\log_2 n \geq 28}{\leq} \log_2 \left(\left(1 + \frac{1}{\log_2 28} \right) \log_2 \log_2 n \right) \leq \log_2 \log_2 \log_2 n + 0.273. \quad \square$$

Lemma 5.19. *Assume that $n, k, l \in \mathbb{N}$ with $n > 2^{28}$, $k = \lceil \log_2 \log_2 n \rceil$ and $l = \lceil \frac{n}{k} \rceil$. Then, we have*

$$24.436l \log_2 \log_2 l \leq 24.437n.$$

Proof. We first calculate

$$l \leq \frac{n}{k} + 1 \leq \frac{n}{\log_2 \log_2 n} + 1 \stackrel{n \geq 2^{28}}{\leq} \left(1 + \frac{\log_2 28}{2^{28}} \right) \frac{n}{\log_2 \log_2 n} \leq 1.00001 \frac{n}{\log_2 \log_2 n}.$$

Hence, we get

$$24.436l \log_2 \log_2 l \leq 24.437 \frac{n}{\log_2 \log_2 n} \log_2 \log_2 l \stackrel{l \leq n}{\leq} 24.437n. \quad \square$$

Now, we can explicitly construct our fourth and final adder circuit.

Theorem 5.20. *Let $n \in \mathbb{N}$ with $n \geq 3$ and input pairs $p_0, g_0, \dots, p_{n-1}, g_{n-1}$ with arrival times $a : \{p_0, g_0, \dots, p_{n-1}, g_{n-1}\} \rightarrow \mathbb{N}$ be given and let $W = \left(\sum_{i=0}^{n-1} 2^{a(p_i)} + 2^{a(g_i)} \right)$ be the weight of the input pairs. We can construct an adder circuit C_n on these input pairs with delay*

$$\text{del}(C_n) \leq \log_2 W + 3 \log_2 \log_2 n + 4 \log_2 \log_2 \log_2 n + f_1$$

and size

$$s(C_n) \leq f_2 n$$

in polynomial time for $f_1 = 18.596$ and $f_2 = 53.877$.

Proof. We first assume that $3 \leq n \leq 268435456 = 2^{28}$. We again use the linear size, depth-optimizing adder from Theorem 2.36 as C_n . Due to Lemma 5.17, we get our desired bounds

$$\begin{aligned} \text{del}(C_n) &\stackrel{\text{Thm. 2.40 (b)}}{\leq} \log_2 W + \log_2 n + \log_2 \log_2 n + \log_2 \log_2 \log_2 n + 6.6 \\ &\stackrel{\text{Lem. 5.17}}{\leq} \log_2 W + 3 \log_2 \log_2 n + 4 \log_2 \log_2 \log_2 n + f_1 \end{aligned}$$

and

$$s(C_n) \leq f_2 n$$

for $f_1 \geq 18.19$ and $f_2 \geq 21.6$.

Hence, assume that $n > 2^{28}$. We again apply Algorithm 2 together with Lemma 5.2. In order to achieve a linear size, we use the same sub-circuits as in the proof of Theorem 5.9:

- For the family of adder circuits $(A_k)_{k \in \mathbb{N}}$, we use the circuits from Theorem 2.36 yielding the bounds

$$\text{del}(A_k) \stackrel{\text{Cor. 2.40 (c)}}{\leq} \log_2 W + \log_2 k + \log_2 \log_2 k + \log_2 \log_2 \log_2 k + 7.6, \quad (67)$$

$$s(A_k) \leq 16.7k. \quad (68)$$

- For the AND-OR-path circuits $(AOP_k)_{k \in \mathbb{N}}$, we make a case distinction. If $k \leq 1336$, we use the depth-optimizing circuits from Theorem 2.32. Because the circuit AOP_k has $2k - 1$ inputs, we get the delay and size bounds

$$\text{del}(AOP_k) \stackrel{\text{Cor. 2.41 (b)}}{\leq} \log_2 W + \log_2(2k) + \log_2 \log_2(2k) + 0.65,$$

$$s(AOP_k) \leq 7.34k - 2.$$

If $k \geq 1337$, we use the construction by Spirkl from Theorem 2.38 guaranteeing the delay and size bounds

$$\text{del}(AOP_k) \leq \log_2 W + 2\sqrt{2 \log_2(2k)} + 6,$$

$$s(AOP_k) \leq 6k.$$

Due to Lemma 5.18 (i) and (ii), we get in both cases that

$$\text{del}(AOP_k) \leq \log_2 W + \log_2 k + 5.159, \quad (69)$$

$$s(AOP_k) \leq 7.34k - 2. \quad (70)$$

- For the family of AND-prefix circuits $(S_k)_{k \in \mathbb{N}}$, we use the construction by Ladner and Fischer from Theorem 2.31 with $f = 0$ which gives us the delay and size bounds

$$\text{del}(S_k) \stackrel{\text{Cor. 2.41 (a)}}{\leq} \log_2 W + \lceil \log_2 k \rceil, \quad (71)$$

$$s(S_k) \leq 4k. \quad (72)$$

- For the family of adder circuits $(B_l)_{l \in \mathbb{N}}$, introduced in Lemma 5.2, we use our latest constructed adder from Theorem 5.13 resulting in the delay and size bounds

$$\text{del}(B_l) \leq \log_2 W + 3 \log_2 \log_2 l + 3 \log_2 \log_2 \log_2 l + 11.085 \quad (73)$$

$$s(B_l) \leq 24.436l \log_2 \log_2 l. \quad (74)$$

In order to achieve a linear size for the sub-circuit B_l , it suffices to choose $k := \lceil \log_2 \log_2 n \rceil$.

We again compute the delay by first bounding the weight \widetilde{W} of the input pairs

$$\text{out}(AOP_{n_0}^0), \text{out}_{n_1}(S_{n_1}^1), \text{out}(AOP_{n_1}^1), \dots, \text{out}_{n_{l-2}}(S_{n_{l-2}}^{l-2}), \text{out}(AOP_{n_{l-2}}^{l-2})$$

of B_l . We have

$$\begin{aligned} \widetilde{W} &\leq \sum_{j=1}^{l-1} \left(2^{\text{del}(AOP_{n_j}^j)} + 2^{\text{del}(S_{n_j}^j)} \right) + 2^{\text{del}(AOP_{n_0}^0)} + 2^0 \\ &\stackrel{(69),(71)}{\leq} \sum_{j=0}^{l-1} \left(2^{\log_2 W_{P^{(j)}} + \log_2 n_j + 5.159} \right) + \sum_{j=1}^{l-1} \left(2^{\log_2 W_{P^{(j)}} + \lceil \log_2 n_j \rceil} \right) + 1 \\ &\stackrel{n_j \leq k}{\leq} \sum_{j=0}^{l-1} \left(2^{\log_2 W_{P^{(j)}} + \log_2 k + 5.159} + 2^{\log_2 W_{P^{(j)}} + \log_2 k + 1} \right) \\ &\leq (2^{5.159} + 2) * Wk \\ &\leq 37.729Wk. \end{aligned}$$

Then, the delay of B_l is bounded by

$$\begin{aligned} \widetilde{\text{del}}(B_l) &\stackrel{(73)}{\leq} \log_2 \widetilde{W} + 3 \log_2 \log_2 l + 3 \log_2 \log_2 \log_2 l + 11.085 \\ &\stackrel{l \leq n}{\leq} \log_2 W + 3 \log_2 \log_2 n + 3 \log_2 \log_2 \log_2 n + \log_2 k + 16.323. \end{aligned} \quad (75)$$

This delay again dominates the delay of the other sub-circuits, since

$$\begin{aligned}
\text{del}(A_{n_j}^j) &\stackrel{(67)}{\leq} \log_2 W_{P^{(j)}} + \log_2 n_j + \log_2 \log_2 n_j + \log_2 \log_2 \log_2 n_j + 7.6 \\
&\stackrel{\substack{n_j \leq k, \\ W_{P^{(j)}} \leq W}}{\leq} \log_2 W + \log_2 k + \log_2 \log_2 k + \log_2 \log_2 \log_2 k + 7.6 \\
&\stackrel{k \leq \log_2 \log_2 n + 1}{\leq} \log_2 W + 3 \log_2 \log_2 n + 3 \log_2 \log_2 \log_2 n + \log_2 k + 17.323
\end{aligned} \tag{76}$$

for $j \in \{0, \dots, l-1\}$ and

$$\begin{aligned}
\text{del}(S_{n_j}^j) &\stackrel{(71)}{\leq} \log_2 W_{P^{(j)}} + \lceil \log_2 n_j \rceil \\
&\stackrel{\substack{n_j \leq k, \\ W_{P^{(j)}} \leq W}}{\leq} \log_2 W + \log_2 k + 1 \\
&\leq \log_2 W + 3 \log_2 \log_2 n + 3 \log_2 \log_2 \log_2 n + \log_2 k + 16.323
\end{aligned} \tag{77}$$

for $j \in \{1, \dots, l-1\}$. Hence, we get the total delay bound

$$\begin{aligned}
\text{del}(C_n) &\stackrel{\text{Thm. 5.3}}{\leq} \max \left\{ \text{del}(A_{n_0}^0), \widetilde{\text{del}}(B_l) + 2, \max_{j \in \{1, \dots, l-1\}} \{ \text{del}(A_{n_j}^j) + 1, \text{del}(S_{n_j}^j) + 2 \} \right\} \\
&\stackrel{(75), (76), (77)}{\leq} \log_2 W + 3 \log_2 \log_2 n + 3 \log_2 \log_2 \log_2 n + \log_2 k + 18.323 \\
&\stackrel{\text{Lem. 5.18 (iii)}}{\leq} \log_2 W + 3 \log_2 \log_2 n + 4 \log_2 \log_2 \log_2 n + f_1
\end{aligned}$$

for $f_1 \geq 18.596$.

For the size, we can directly calculate

$$\begin{aligned}
s(C_n) &\stackrel{\text{Thm. 5.3}}{\leq} s(A_{n_0}^0) + s(AOP_{n_0}^0) + \sum_{j=1}^{l-1} \left(s(A_{n_j}^j) + s(AOP_{n_j}^j) + s(S_{n_j}^j) \right) + s(B_l) + 2n \\
&\stackrel{\substack{(68), (70), \\ (72), (74)}}{\leq} \sum_{j=0}^{l-1} (16.1n_j + 7.34n_j - 2 + 4n_j) + 24.436l \log_2 \log_2 l + 2n \\
&\leq 29.44n + 24.436l \log_2 \log_2 l \\
&\stackrel{\text{Lem. 5.19}}{\leq} 29.44n + 24.437n \\
&\leq f_2 n
\end{aligned}$$

for $f_2 \geq 53.877$.

Hence, we get the delay and size bounds for the circuit C_n for constants $f_1 \geq 18.596$ and $f_2 \geq 53.877$.

For the runtime, we again note that we use Algorithm 2 combined with Lemma 5.2 with a polynomial amount of sub-circuits which all have polynomial runtime (see Theorem 2.36, Theorem 2.32, Theorem 2.38, Theorem 2.31, Theorem 5.13). Analogously to the proof of Theorem 5.8, we get a polynomial runtime overall. \square

Remark. As for the fanout, we chose the circuit from Theorem 5.13 with a fanout in $\mathcal{O}\left(\frac{\sqrt{l}}{\log_2 l}\right)$ (see the last remark in Section 5.3.2) as B_l , and we chose $k = \lceil \log_2 \log_2 n \rceil$ in Algorithm 2. Therefore, the circuit from Theorem 5.20 has a fanout in $\mathcal{O}\left(\frac{\sqrt{n}}{\sqrt{\log_2 \log_2 n (\log_2 n - \log_2 \log_2 \log_2 n)}}\right)$.

6 Conclusions

We have constructed several fast and small adder circuits.

Using the AND-prefix circuits by Rautenbach, Szegedy and Werber [RSW07] and the AND-OR path circuits by Brenner and Hermann [BH19], we constructed an adder circuit in polynomial runtime with a delay of at most

$$\log_2 W + 3 \log_2 \log_2 n + \text{const}$$

and a size in $\mathcal{O}(n \log_2^2 n)$ in Section 4. This is the best delay bound known for adders with a sub-quadratic size and exceeds the delay bound of the fastest known AND-OR path circuit (and thus, adder circuit), provided in [BH19] (Theorem 2.37), only by $2 \log_2 \log_2 n - \log_2 \log_2 \log_2 n + \text{const}$.

We developed two size reduction frameworks for delay-optimizing adder circuits, based on a linearization framework from [BS24] for depth-optimizing adders. Applying them to our previously constructed adder gave us several smaller adders with a slightly larger delay guarantee. In particular, we achieved two adder circuits with a delay bound of

$$\log_2 W + 3 \log_2 \log_2 n + 3 \log_2 \log_2 \log_2 n + \text{const}$$

and sizes in $\mathcal{O}(n \log_2 n)$ and $\mathcal{O}(n \log_2 \log_2 n)$, respectively. Finally, we constructed a linear size adder with a delay bound of

$$\log_2 W + 3 \log_2 \log_2 n + 4 \log_2 \log_2 \log_2 n + \text{const}.$$

Hence, we were able to linearize our first constructed adder by the cost of a delay increase of order $\mathcal{O}(\log_2 \log_2 \log_2 n)$ and improve on the previously best known delay bound of $\log_2 W + \mathcal{O}(\sqrt{\log_2 n})$ for linear size adders, provided by Spirkl [Spi14]. In particular, the distance to the lower bound of $\log_2 W$ could be reduced significantly from $\Theta(\sqrt{\log_2 n})$ to $\Theta(\log_2 \log_2 \log_2 n)$

Lastly, we also presented a method to construct circuits with a delay of at most $\log_2 W + \sum_{i=2}^{j+1} 3 \log_2^{(i)} n + \text{const}$ and a size in $\mathcal{O}(n \log_2^{(j)} n)$, as well as linear size circuits with a delay of at most

$$\log_2 W + \sum_{i=2}^j 3 \log_2^{(i)} n + 4 \log_2^{(j+1)} n + \text{const}$$

for all $j \in \mathbb{N}_{>2}$. This implies an asymptotic upper bound on the minimum delay of linear size adder circuits of $\log_2 W + \sum_{i=2}^{\infty} 3 \log_2^{(i)} n$.

References

- [BH19] Ulrich Brenner and Anna Hermann. Faster carry bit computation for adder circuits with prescribed arrival times. *ACM Trans. Algorithms*, 15(4), July 2019.
- [BS24] Ulrich Brenner and Anna Silvanus. Faster linear-size AND-OR path and adder circuits. <https://arxiv.org/abs/2405.12765>, 2024.
- [Cho04] Youngmoon Choi. Parallel Prefix Adder Design. Dissertation, University of Texas at Austin, 2004.
- [CH11] Y. Crama and P.L. Hammer. *Boolean Functions: Theory, Algorithms, and Applications*. Encyclopedia of Mathematics and its Applications. Cambridge University Press, 2011.
- [CW79] Beate Commentz-Walter. Size-depth tradeoff in monotone Boolean formulae. *Acta Informatica*, 12:227–243, 1979.
- [Gol76] Martin C. Golumbic. Combinatorial merging. *IEEE Transactions on Computers*, C-25(11):1164–1167, 1976.
- [Gri09] Mikhael I. Grinchuk. Sharpening an upper bound on the adder and comparator depths. *Journal of Applied and Industrial Mathematics*, 3(1):61–67, 2009.
- [HS17] Stephan Held, Sophie Spirkl. Fast prefix adders for non-uniform input arrival times. *Algorithmica*, 77, pages 287–308, 2017.
- [Her20] Anna Hermann. *Faster Circuits for And-Or Paths and Binary Addition*. PhD thesis, University of Bonn, July 2020.
- [Hit18] Jan Maik Hitzschke. Untere Schranken für Tiefe und Delay von AND-OR-Pfaden, July 2018. Bachelor’s thesis, University of Bonn.
- [LF80] Richard E. Ladner and Michael J. Fischer. Parallel prefix computation. *J. ACM*, 27(4):831–838, October 1980.
- [Ok194] Vojin G. Oklobdzija. Design and analysis of fast carry-propagate adder under non-equal input signal arrival profiles. In *Proceedings of 1994 28th Asilomar Conference on Signals, Systems and Computers*, volume 2, pages 1398–1401, 1994.
- [RSW07] Dieter Rautenbach, Christian Szegedy, and Jürgen Werber. The delay of circuits whose inputs have specified arrival times. *Discrete Applied Mathematics*, 155(10):1233–1243, 2007.
- [Spi14] Sophie Theresa Spirkl. Boolean circuit optimization. MA thesis, University of Bonn, July 2014. Available at <https://sites.google.com/site/sophiespirkl/research>.
- [Zim98] Reto Zimmermann. Binary Adder Architectures for Cell-Based VLSI and Their Synthesis. PhD thesis, Swiss Federal Institute of Technology, Zurich (ETH), 1998.