

High-order observers and high-order state-estimation-based properties of discrete-event systems

Kuize Zhang

Department of Electrical and Electronic Engineering

University of Cagliari, 09123 Cagliari, Italy

kuize.zhang@unica.it

Xiaoguang Han

College of Electronic Information and Automation

Tianjin University of Science and Technology, Tianjin 300222, China

hxg-allen@163.com

Alessandro Giua

Department of Electrical and Electronic Engineering

University of Cagliari, 09123 Cagliari, Italy

giua@unica.it

Carla Seatzu

Department of Electrical and Electronic Engineering

University of Cagliari, 09123 Cagliari, Italy

carla.seatzu@unica.it

Abstract State-estimation-based properties are central properties in discrete-event systems modeled by labeled finite-state automata studied over the past 3 decades. Most existing results are based on a single agent who knows the structure of a system and can observe a subset of events and estimate the system's state based on the system's structure and the agent's observation to the system. The main tool used to do state estimation and verify state-estimation-based properties is called *observer* which is the powerset construction originally proposed by Rabin and Scott in 1959, used to determinize a nondeterministic finite automaton with ε -transitions.

In this paper, we consider labeled finite-state automata, extend the state-estimation-based properties from a single agent to a finite ordered set of agents and also extend the original observer to *high-order observer* based on the original observer and our *concurrent composition*. As a result, a general framework on high-order state-estimation-based properties have been built and a basic tool

has also been built to verify such properties. This general framework contains many basic properties as its members such as state-based opacity, critical observability, determinism, high-order opacity, etc. Special cases for which verification can be done more efficiently are also discussed.

In our general framework, the system’s structure is publicly known to all agents A_1, \dots, A_n , each agent A_i has its own observable event set E_i , and additionally knows all its preceding agents’ observable events but can only observe its own observable events. The intuitive meaning of our high-order observer is what agent A_n knows about what A_{n-1} knows about ... what A_2 knows about A_1 ’s state estimate of the system.

Keywords discrete-event system, finite-state automaton, high-order state-estimation-based property, high-order observer, concurrent composition

Contents

1	Introduction	3
2	Preliminaries	3
3	Overview of the general framework of state-estimation-based properties	6
4	Formulation of order-1 state-estimation-based problems	6
4.1	The general framework	6
4.2	Case study 1: Current-state opacity	7
4.3	Case study 1’: Strong current-state opacity	8
4.4	Case study 2: Critical observability	10
4.5	Case study 3: Determinism	10
5	Formulation of order-2 state-estimation-based problems	10
5.1	The general framework	10
5.2	Several special cases verifiable in exponential time	13
5.2.1	Special case 1	14
5.2.2	Special case 2	15
5.2.3	Special case 3	16
5.3	Case study 1: Order-2 current-state opacity	18
5.3.1	A scenario — The high-order opacity studied in [2]	19
5.3.2	Another scenario of high-order opacity	24
6	Formulation of order-n state-estimation-based problems	25
6.1	The general framework	25
6.2	Special cases	27
6.2.1	Special case 1	28
6.2.2	Special case 2	28
6.3	Case study 1: Order-3 current-state opacity	29

1 Introduction

In this paper, we formulate a *general framework of state-estimation-based properties for discrete-event systems* (DESS) modeled as *labeled finite-state automata* (LFSAs), derive a unified *high-order observer* method for verifying such properties based on two basic tools — *observer* [9, 12] and *concurrent composition* [17]. We then show many properties published in the literature in this area can be classified into our general framework as special cases.

2 Preliminaries

Notation Symbols \mathbb{N} and \mathbb{Z}_+ denote the set of nonnegative integers and the set of positive integers, respectively. Let Σ denote an *alphabet*, i.e., a nonempty finite set for which every sequence of elements of Σ is a unique sequence of elements of Σ . Elements of Σ are called *letters*. As usual, we use Σ^* to denote the set of *words* or *strings* (i.e., finite-length sequences of letters) over Σ including the empty word ϵ . $\Sigma^+ := \Sigma^* \setminus \{\epsilon\}$. A *(formal) language* is a subset of Σ^* . In the paper, we use two alphabets E and Σ , where the former denotes the set of *events* and the latter denotes the set of events' *labels*. For two nonnegative integers $i \leq j$, $\llbracket i, j \rrbracket$ denotes the set of all integers no less than i and no greater than j . For a set S , $|S|$ denotes its cardinality and 2^S its power set. Symbols \subset and \subsetneq denote the subset and strict subset relations, respectively.

Definition 1 A finite-state automaton (FSA) is a quadruple

$$G = (Q, E, \delta, Q_0), \quad (1)$$

where

1. Q is a finite set of states,
2. E is an alphabet of events,
3. $\delta : Q \times E \rightarrow 2^Q$ is the transition function (equivalently described as $\delta \subset Q \times E \times Q$ such that $(q, e, q') \in \delta$ if and only if $q' \in \delta(q, e)$),
4. $Q_0 \subset Q$ is a set of initial states.

Transition function δ is recursively extended to $Q \times E^* \rightarrow 2^Q$: for all $q \in Q$, $u \in E^*$, and $e \in E$, $\delta(q, \epsilon) = \{q\}$, $\delta(q, ue) = \bigcup_{p \in \delta(q, u)} \delta(p, e)$. Automaton G is called *deterministic* if $Q_0 = \{q_0\}$ for some $q_0 \in Q$, for all $q \in Q$ and $e \in E$, $|\delta(q, e)| \leq 1$. A deterministic G is also written as $G = (Q, E, \delta, q_0)$.

A transition $q \xrightarrow{e} q'$ with $q' \in \delta(q, e)$ means that when G is in state q and event e occurs, G transitions to state q' . A sequence $q_0 \xrightarrow{e_1} \dots \xrightarrow{e_n} q_n$ of consecutive transitions with $n \in \mathbb{N}$ is called a *run*¹, in which the event sequence $e_1 \dots e_n$ is called a *trace* if $q_0 \in Q_0$. A state $q \in Q$ is *reachable* if

¹When $n = 0$, the run degenerates to a single state q_0 .

there is a run from some initial state to q . The *reachable part* of G consist of all reachable states and transitions between them. When showing an automaton, we usually only show its reachable part. The *language* $L(G)$ generated by G is the set of traces generated by G .

Occurrences of events of an FSA G may be observable or not. Let alphabet Σ denote the set of *labels/outputs*. The *labeling function* is defined as $\ell : E \rightarrow \Sigma \cup \{\epsilon\}$, and is recursively extended to $\ell : E^* \rightarrow \Sigma^*$. Denote $E_o = \{e \in E | \ell(e) \in \Sigma\}$, $E_{uo} = \{e \in E | \ell(e) = \epsilon\}$, where the former denotes the set of *observable events* and the latter denotes the set of *unobservable events*. When an observable e occurs, its label $\ell(e)$ is observed, when an unobservable event occurs, nothing is observed.

A *labeled finite-state automaton* (LFSA) is denoted as

$$\mathcal{S} = (G, \Sigma, \ell).$$

The following definition on state estimate is critical to define all kinds of properties in DESs. The *current-state estimate* $\mathcal{M}(\mathcal{S}, \alpha)$ with respect to $\alpha \in \ell(L(G))$ is defined as

$$\mathcal{M}(\mathcal{S}, \alpha) = \mathcal{M}_\ell(G, \alpha) = \{q \in Q | (\exists \text{ run } q_0 \xrightarrow{s} q)[q_0 \in Q_0 \wedge \ell(s) = \alpha]\},$$

which means the set of states G can be in when α is observed.

For a subset $E' \subset E$, the projection $P_{E'} : E \rightarrow E'$ is defined as follows: $P_{E'}(e) = e$ if $e \in E'$, $P_{E'}(e) = \epsilon$ otherwise. $P_{E'}$ is recursively extended to $E^* \rightarrow (E')^*$. By definition, a projection is a special labeling function.

In the sequel, we sometimes say an LFSA \mathcal{S} , or, an FSA G with respect to a labeling function/projection.

Definition 2 ([17]) *Consider two LFSAs $\mathcal{S}^i = (Q_i, E_i, \delta_i, Q_{0i}, \Sigma, \ell_i)$, $i = 1, 2$, the concurrent composition $\text{CC}(\mathcal{S}^1, \mathcal{S}^2)$, also denoted as $\mathcal{S}^1 \parallel \mathcal{S}^2$, of \mathcal{S}^1 and \mathcal{S}^2 is defined by LFSA*

$$\text{CC}(\mathcal{S}^1, \mathcal{S}^2) = \mathcal{S}^1 \parallel \mathcal{S}^2 = (Q', E', \delta', Q'_0, \Sigma', \ell'), \quad (2)$$

where

1. $Q' = Q_1 \times Q_2$;
2. $E' = E'_o \cup E'_{uo}$, where $E'_o = \{(e_1, e_2) | e_1 \in E_{1o}, e_2 \in E_{2o}, \ell_1(e_1) = \ell_2(e_2)\}$, $E'_{uo} = \{(e_1, \epsilon) | e_1 \in E_{1uo}\} \cup \{(\epsilon, e_2) | e_2 \in E_{2uo}\}$, E_{io} and E_{iuo} denote the set of observable events of \mathcal{S}^i and the set of unobservable events of \mathcal{S}^i , respectively, $i = 1, 2$;
3. for all $(q_1, q_2), (q_3, q_4) \in Q'$, $(e_{1o}, e_{2o}) \in E'_o$, $(e_{1uo}, \epsilon), (\epsilon, e_{2uo}) \in E'_{uo}$
 - $((q_1, q_2), (e_{1o}, e_{2o}), (q_3, q_4)) \in \delta'$ if and only if $(q_1, e_{1o}, q_3) \in \delta_1$, $(q_2, e_{2o}, q_4) \in \delta_2$,
 - $((q_1, q_2), (e_{1uo}, \epsilon), (q_3, q_4)) \in \delta'$ if and only if $(q_1, e_{1uo}, q_3) \in \delta_1$, $q_2 = q_4$,
 - $((q_1, q_2), (\epsilon, e_{2uo}), (q_3, q_4)) \in \delta'$ if and only if $q_1 = q_3$, $(q_2, e_{2uo}, q_4) \in \delta_2$;
4. $Q'_0 = Q_{01} \times Q_{02}$;
5. for all $(e_{1o}, e_{2o}) \in E'_o$, $(e_{1uo}, \epsilon) \in E'_{uo}$, and $(\epsilon, e_{2uo}) \in E'_{uo}$, $\ell'((e_{1o}, e_{2o})) := \ell_1(e_{1o}) = \ell_2(e_{2o})$, $\ell'((e_{1uo}, \epsilon)) := \ell_1(e_{1uo}) = \epsilon$, $\ell'((\epsilon, e_{2uo})) := \ell_2(e_{2uo}) = \epsilon$.

Particularly, if $\mathcal{S}^1 = \mathcal{S}^2$, then $\text{CC}(\mathcal{S}^1, \mathcal{S}^2) =: \text{CC}(\mathcal{S}^1) =: \text{CC}_{\ell_1}(G^1)$ is called the self-composition of \mathcal{S}^1 , where $G^1 = (Q_1, E_1, \delta_1, Q_{01})$.

The concurrent composition provides a unified method for verifying a number of fundamental properties in LFSAs without any assumption [16, 17, 15], e.g., strong detectability, diagnosability, predictability. While the classical tools — the detector for verifying strong detectability [11], the twin-plant [6] and the verifier [13] for verifying diagnosability, and the verifier [3] for verifying predictability all depend on two assumptions of deadlock-freeness and divergence-freeness [15]. These three properties not only depend on state-estimate but also depend on runs, so cannot be fully classified into the state-estimation-based property framework studied in the current paper.

Definition 3 ([9, 12]) Consider an LFA $\mathcal{S} = (G, \Sigma, \ell)$. Its observer $\text{Obs}(\mathcal{S}) = \text{Obs}_{\ell}(G)$ ² is defined by a deterministic finite automaton

$$(Q_{\text{obs}}, \ell(E_o), \delta_{\text{obs}}, q_{0 \text{ obs}}), \quad (3)$$

where

1. $Q_{\text{obs}} = 2^Q$,
2. $\ell(E_o) = \ell(E) \setminus \{\epsilon\}$,
3. for all $X \in Q_{\text{obs}}$ and $a \in \ell(E_o)$, $\delta_{\text{obs}}(X, a) = \bigcup_{q \in X} \bigcup_{\substack{e \in E_o \\ \ell(e)=a}} \bigcup_{s \in (E_{uo})^*} \delta(q, es)$,
4. $q_{0 \text{ obs}} = \bigcup_{q_0 \in Q_0} \bigcup_{s \in (E_{uo})^*} \delta(q_0, s)$.

The observer $\text{Obs}(\mathcal{S})$, actually the powerset construction, can be computed in time exponential in the size of \mathcal{S} , and has been widely used for many years in both the computer science community and the control community.

Definition 4 ([11]) Consider an LFA $\mathcal{S} = (G, \Sigma, \ell)$ and its observer $\text{Obs}(\mathcal{S})$. The detector $\text{Det}(\mathcal{S})$, also denoted as $\text{Det}_{\ell}(G)$, of \mathcal{S} is defined as a nondeterministic finite automaton $(Q_{\text{det}}, \ell(E_o), \delta_{\text{det}}, q_{0 \text{ det}})$, where

1. $q_{0 \text{ det}} = q_{0 \text{ obs}}$,
2. $Q_{\text{det}} = \{q_{0 \text{ det}}\} \cup \{X \subset Q \mid 1 \leq |X| \leq 2\}$,
3. for each state X in Q_{det} and each label $\sigma \in \ell(E_o)$,

$$\delta_{\text{det}}(X, \sigma) = \begin{cases} \{X' \mid X' \subset \delta_{\text{obs}}(X, \sigma), |X'| = 2\} & \text{if } |\delta_{\text{obs}}(X, \sigma)| \geq 2, \\ \{\delta_{\text{obs}}(X, \sigma)\} & \text{if } |\delta_{\text{obs}}(X, \sigma)| = 1, \\ \emptyset & \text{otherwise.} \end{cases}$$

$\text{Det}(\mathcal{S})$ can be computed in time polynomial in the size of \mathcal{S} . A critical relation between $\text{Det}(\mathcal{S})$ and $\text{Obs}(\mathcal{S})$ is as follows.

²The term “observer” dates back to [7, 12].

Lemma 2.1 ([14, Proposition 3]). *Consider an LFSA (G, Σ, ℓ) . Consider a run $q_{0\text{obs}} \xrightarrow{e_1} X_1 \xrightarrow{e_2} \dots \xrightarrow{e_n} X_n$ in its observer $\text{Obs}(G, \Sigma, \ell)$ with $q_{0\text{obs}}$ the initial state, where $e_1, \dots, e_n \in \Sigma$, $X_n \neq \emptyset$. Choose $X'_n \subset X_n$ satisfying $|X'_n| = 2$ if $|X_n| \geq 2$, and $|X'_n| = 1$ otherwise. Then there is a run $q_{0\text{obs}} \xrightarrow{e_1} X'_1 \xrightarrow{e_2} \dots \xrightarrow{e_n} X'_n$ in its detector $\text{Det}(G, \Sigma, \ell)$ (note that $q_{0\text{obs}}$ is also the initial state of $\text{Det}(G, \Sigma, \ell)$), where $|X'_i| = 2$ if $|X_i| \geq 2$, $i \in \llbracket 1, n-1 \rrbracket$.*

Lemma 2.1 implies that along a run of the observer of an LFSA from the initial state to some state which is not equal to \emptyset , one can construct a run of its detector from end to head under the same label sequence such that the cardinality of each state can be maximal.

3 Overview of the general framework of state-estimation-based properties

In this section, we give an overview of the general framework of state-estimation-based properties for an FSA G as in (1). Assume the structure of G is publicly known to all agents. This will be done in three steps. The first step will be based on a single agent A_1 who can observe a subset E_1 of events of G , and the properties to be formulated are based on A_1 's state estimate of G . In this step, the properties are called *of order-1*. A number of properties in the literature are order-1 properties, e.g., current-state opacity [1, 10], strong current-state opacity [4], and critical observability [8]. The second step will be based on two agents A_1 and A_2 , where A_i can observe a subset E_i of events of G , $i = 1, 2$, and additionally based on that A_2 knows E_1 but cannot observe events of $E_1 \setminus E_2$. The properties to be formulated are based on A_2 's inference of A_1 's state estimate of G , that is, what A_2 knows about A_1 's state estimate of G . In this step, the properties are called *of order-2*. For example, the high-order opacity studied in [2] is an order-2 property. The third step will be based on a finite number of ordered agents A_1, \dots, A_n , where A_i can observe a subset E_i of events of G , $i \in \llbracket 1, n \rrbracket$, and additionally based on that A_j knows E_{k_j} but cannot observe events of $E_{k_j} \setminus E_j$, $j \in \llbracket 2, n \rrbracket$, $k_j \in \llbracket 1, j-1 \rrbracket$. The properties to be formulated are based on what A_n knows about what A_{n-1} knows about ... what A_2 knows about A_1 's state estimate of G . In this step, the properties are called *of order- n* .

4 Formulation of order-1 state-estimation-based problems

4.1 The general framework

Consider an FSA $G = (Q, E, \delta, Q_0)$, an agent A_1 , and its set $E_1 \subset E$ of observable events. As a usual setting in the state-estimation-based problems, agent A_1 knows the structure of G .

Denote

$$P_{E_1} =: P_1, \quad \text{Obs}_{P_{E_1}}(G) =: \text{Obs}_1(G), \quad (4a)$$

$$\text{Det}_{P_{E_1}}(G) =: \text{Det}_1(G), \quad \mathcal{M}_{P_{E_1}}(G, \alpha) =: \mathcal{M}_1(G, \alpha), \quad (4b)$$

for short.

Recall that with respect to an observation sequence $\alpha \in P_1(L(G))$, A_1 's current-state estimate of G is $\mathcal{M}_1(G, \alpha)$. Define *predicate of order-1* as

$$\text{PRED}_1 \subset 2^Q. \quad (5)$$

Note that the subscript 1 in (5) means there is a unique agent. While the subscript 1 in (4) means the first agent. Then an order-1 state-estimation-based property is defined as follows.

Definition 5 *An FSA G satisfies the order-1 state-estimation-based property PRED_1 with respect to agent A_1 if*

$$\{\mathcal{M}_1(G, \alpha) \mid \alpha \in P_1(L(G))\} \subset \text{PRED}_1. \quad (6)$$

One can see that the basic tool — observer can be used to verify whether an FSA G satisfies this property with respect to agent A_1 .

Theorem 4.1 *An FSA G satisfies the order-1 state-estimation-based property PRED_1 with respect to agent A_1 if and only if in the observer $\text{Obs}_1(G)$, every reachable state X belongs to PRED_1 .*

One can see that [Theorem 4.1](#) provides an exponential-time algorithm for verifying the order-1 state-estimation-based property PRED_1 , because it takes exponential time to compute the observer $\text{Obs}_1(G)$. Particularly, one can see that if except for the initial state of $\text{Obs}_1(G)$, all states have cardinalities no greater than 2, then $\text{Obs}_1(G)$ can be computed in polynomial time. In this particular case, we can get polynomial-time verification algorithms. Consider a special type $\text{PRED}_1 \subset 2^Q$ of predicates satisfying that for every $X \subset Q$, if $|X| > 2$ then $X \notin \text{PRED}_1$, the satisfiability of the order-1 state-estimation-based property PRED_1 of FSA G with respect to agent A_1 can be verified in polynomial time.

Until now, we have not endowed any physical meaning to the order-1 state-estimation-based property, because it is too general. However, if we restrict the general property, then we can obtain a number of special scenarios with particular physical meanings. Next, we recall a number of properties published in the literature that can be classified into the order-1 state-estimation-based property.

4.2 Case study 1: Current-state opacity

Specify a subset $Q_S \subset Q$ of secret states. State-based opacity means whenever a secret state is visited in a run, there is another run in which at the same time no secret state is visited such that the two runs look the same to an intruder. When the time instant of visiting secret states is specified as the current time, the notion of *current-state opacity* (CSO) was formulated [1, 10]. To be consistent, agent A_1 is regarded as the intruder Intr .

Definition 6 ([10]) *Consider an LFSA (G, E_1, P_1) and a subset $Q_S \subset Q$ of secret states. FSA G is called current-state opaque with respect to P_1 and Q_S if for every run $q_0 \xrightarrow{s} q$ with $q_0 \in Q_0$ and $q \in Q_S$, there exists a run $q'_0 \xrightarrow{s'} q'$ such that $q'_0 \in Q_0$, $q' \in Q \setminus Q_S$, and $P_1(s) = P_1(s')$.*

Next, we classify current-state opacity into the order-1 state-estimation-based property. To this end, we define a special type $\text{PRED}_1(G, Q_S)$ of predicates as

$$\text{PRED}_1(G, Q_S) := \{X \subset Q \mid X \not\subset Q_S\} \subset 2^Q. \quad (7)$$

Then, the notion of current-state opacity is reformulated as follows.

Definition 7 ([1]) *An FSA G is current-state opaque with respect to P_1 and Q_S if*

$$\{\mathcal{M}_1(G, \alpha) \mid \alpha \in P_1(L(G))\} \subset \text{PRED}_1(G, Q_S).$$

From [Definition 6](#) and [Definition 7](#) one can see, although the definitions of CSO given in [1, 10] are equivalent, they were given in different forms.

[Theorem 4.1](#) provides an exponential-time algorithm for verifying CSO of LFSAs. Furthermore, the CSO verification problem is PSPACE-complete in LFSAs [1].

4.3 Case study 1': Strong current-state opacity

In some cases, the current-state opacity is not strong enough to protect secret states. For example, consider the LFSA \mathcal{S}_I as in [Figure 1](#). Obviously, \mathcal{S}_I is current-state opaque with respect to $\{q_2, q_3\}$. When observing a , one can be sure that at least one secret state has been visited. In detail, if $q_1 \xrightarrow{a} q_2$ was generated then q_2 was visited, if $q_3 \xrightarrow{a} q_4$ was generated then q_3 was visited. This leads to a “strong version” of current-state opacity which guarantees that an intruder cannot be sure whether the current state is secret, and can also guarantee that the intruder cannot be sure whether some secret state has been visited. A *non-secret run* is a run that contains no secret states.



Figure 1: LFSA \mathcal{S}_I [15], where $\ell(a) = a$, q_2 and q_3 are secret, q_1 and q_4 are not secret.

Definition 8 ([4]) *Consider an LFSA $(G, E_1, P_1) =: \mathcal{S}$ and a subset $Q_S \subset Q$ of secret states. FSA G is called strongly current-state opaque with respect to P_1 and Q_S , or say, LFSA \mathcal{S} is called strongly current-state opaque with respect to Q_S , if for every run $q_0 \xrightarrow{s} q$ with $q_0 \in Q_0$ and $q \in Q_S$, there exists a non-secret run $q'_0 \xrightarrow{s'} q'$ such that $q'_0 \in Q_0$ and $\ell(s) = \ell(s')$.*

Unlike current-state opacity, one cannot directly use the observer to verify strong current-state opacity. The verification method for strong current-state opacity proposed in [4] is first compute the non-secret sub-automaton \mathcal{S}_{NS} that is obtained from \mathcal{S} by removing all secret states and the corresponding transitions, second compute the observer $\text{Obs}(\mathcal{S}_{NS})$ of \mathcal{S}_{NS} , and third compute the concurrent composition $\text{CC}(\mathcal{S}, \text{Obs}(\mathcal{S}_{NS}))$. Then G is strongly current-state opaque with respect to P_1 and Q_S if and only if for every reachable state (q, X) of $\text{CC}(\mathcal{S}, \text{Obs}(\mathcal{S}_{NS}))$, if q is secret then $X \neq \emptyset$. Details are referred to [4].

Next we show another verification method for strong current-state opacity. Although the new method is less efficient than the above method, it can classify strong current-state opacity into the order-1 state-estimation-based property.

Consider the non-secret sub-automaton \mathcal{S}_{NS} . For every state q and event $e \in E$ such that there is no transition starting at q with event e , add a transition $q \xrightarrow{e} \diamond$. Also add a transition $\diamond \xrightarrow{e} \diamond$ for every $e \in E$. Denote the current modification of \mathcal{S}_{NS} by $\mathcal{S}_{NS}^\diamond$. Compute the concurrent composition $\text{CC}(\mathcal{S}, \mathcal{S}_{NS}^\diamond)$, and then compute its observer $\text{Obs}(\text{CC}(\mathcal{S}, \mathcal{S}_{NS}^\diamond))$. Note that \diamond is neither secret nor non-secret. Then the following result holds.

Theorem 4.2 G is strongly current-state opaque with respect to P_1 and Q_S if and only if in each reachable state X of $\text{Obs}(\text{CC}(\mathcal{S}, \mathcal{S}_{\text{NS}}^\diamond))$, if there is a secret state q such that (q, \diamond) belongs to X , then there is a non-secret state q' such that (q, q') also belongs to X .

Example 4.3. Consider the LFSA \mathcal{S}_{II} in Figure 2. The reachable part of $\text{CC}(\mathcal{S}_{II}, \text{Obs}(\mathcal{S}_{II\text{NS}}))$ is

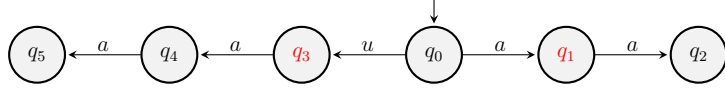

Figure 2: LFSA \mathcal{S}_{II} [15], where $\ell(u) = \epsilon$, $\ell(a) = a$, q_1 and q_3 are secret, the other states are not secret.

shown in Figure 3, in which there is a reachable state (q_1, \emptyset) of which the left component is secret and the right component is empty. Then by the verification method shown in [4], \mathcal{S}_{II} is not strongly current-state opaque with respect to $\{q_1, q_3\}$.

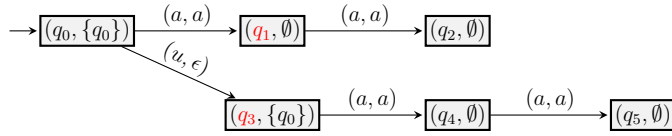

Figure 3: The reachable part of $\text{CC}(\mathcal{S}_{II}, \text{Obs}(\mathcal{S}_{II\text{NS}}))$ corresponding to the LFSA \mathcal{S}_{II} in Figure 2.

The reachable part of observer $\text{Obs}(\text{CC}(\mathcal{S}_{II}, \mathcal{S}_{II\text{NS}}^\diamond))$ is shown in Figure 4, where in the reachable state $\{(q_1, \diamond), (q_4, \diamond)\}$, there is a state pair (q_1, \diamond) whose left component is the secret state q_1 and right component is \diamond , but there is no other state pair whose left component is also q_1 and right component is a non-secret state. Then \mathcal{S}_{II} is not strongly current-state opaque with respect to $\{q_1, q_3\}$.

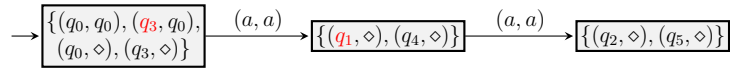

Figure 4: The reachable part of $\text{Obs}(\text{CC}(\mathcal{S}_{II}, \mathcal{S}_{II\text{NS}}^\diamond))$ corresponding to the LFSA \mathcal{S}_{II} in Figure 2.

Next, we classify strong current-state opacity into the order-1 state-estimation-based property. Define $Q_{\text{NS}} := Q \setminus Q_S$, $Q_{\text{NS}}^\diamond := Q_{\text{NS}} \cup \{\diamond\}$. To this end, we define a special type $\text{PRED}_{1'}(G, Q_S)$ of predicates as

$$\text{PRED}_{1'}(G, Q_S) := \{X \subset Q \times Q_{\text{NS}}^\diamond \mid (\exists q \in Q_S)[(q, \diamond) \in X] \implies (\exists q' \in Q_{\text{NS}})[(q, q') \in X]\} \quad (8)$$

$$\subset 2^{Q \times Q_{\text{NS}}^\diamond}. \quad (9)$$

Then, the notion of strong current-state opacity is reformulated as follows.

Definition 9 An FSA G is strongly current-state opaque with respect to P_1 and Q_S if

$$(Q \times Q_{\text{NS}}^\diamond)_{\text{Obs}} \subset \text{PRED}_{1'}(G, Q_S), \quad (10)$$

where $(Q \times Q_{\text{NS}}^\diamond)_{\text{Obs}}$ denotes the set of reachable states of observer $\text{Obs}(\text{CC}(\mathcal{S}, \mathcal{S}_{\text{NS}}^\diamond))$.

4.4 Case study 2: Critical observability

Critical observability means observability with respect to every generated label sequence α , the current-state estimate is either a subset of a subset $Q_{\text{CriDet}} \subset Q$ of states or is a subset of the complement of Q_{CriDet} .

Definition 10 ([8]) *Consider an FSA G , an agent A_1 with a set $E_1 \subset E$ of observable events, and a subset $Q_{\text{CriDet}} \subset Q$ of states. FSA G is called critically observable with respect to P_1 and Q_{CriDet} if for every $\alpha \in P_1(L(G))$, either $\mathcal{M}_1(G, \alpha) \subset Q_{\text{CriDet}}$ or $\mathcal{M}_1(G, \alpha) \subset Q \setminus Q_{\text{CriDet}}$.*

Define a special type

$$\text{PRED}_{1\text{CriDet}} = \{X \subset Q \mid X \subset Q_{\text{CriDet}} \vee X \subset Q \setminus Q_{\text{CriDet}}\} \subset 2^Q \quad (11)$$

of predicates. Then critical observability can be reformulated as follows.

Definition 11 *Consider an FSA G , an agent A_1 with a set $E_1 \subset E$ of observable events, and a subset $Q_{\text{CriDet}} \subset Q$ of states. FSA G is called critically observable with respect to P_1 and Q_{CriDet} if*

$$\{\mathcal{M}_1(G, \alpha) \mid \alpha \in P_1(L(G))\} \subset \text{PRED}_{1\text{CriDet}}.$$

4.5 Case study 3: Determinism

The definition of determinism was studied for labeled Petri nets [5]. A labeled Petri net is deterministic if no reachable marking enables two different firing sequences with the same label sequence. In the same paper, it was proven that the determinism verification problem is as hard as the coverability problem in Petri nets, hence EXPSPACE-complete. The automaton version of determinism can be classified into the order-1 state-estimation-based property.

Choose a special predicate

$$\text{PRED}_{1\text{det}} = \{X \subset Q \mid |X| = 1\} \subset 2^Q. \quad (12)$$

Definition 12 *FSA G satisfies the determinism property with respect to P_1 if*

$$\{\mathcal{M}_1(G, \alpha) \mid \alpha \in P_1(L(G))\} \subset \text{PRED}_{1\text{det}}.$$

Based on previous argument, the negation of determinism of FSAs can be verified in polynomial time because one only needs to check whether the observer $\text{Obs}_1(G)$ has a reachable non-singleton state, but does not need to compute the whole observer.

5 Formulation of order-2 state-estimation-based problems

5.1 The general framework

Consider an FSA $G = (Q, E, \delta, Q_0)$, two agents A_1 and A_2 with their observable event sets $E_1 \subset E$ and $E_2 \subset E$. As mentioned before, assume both agents know the structure of G , also assume A_2

knows E_1 but cannot observe events of $E_1 \setminus E_2$. Denote

$$P_{E_i} =: P_i, \quad \text{Obs}_{P_{E_i}}(G) =: \text{Obs}_i(G), \quad (13a)$$

$$\text{Det}_{P_{E_i}}(G) =: \text{Det}_i(G), \quad \mathcal{M}_{P_{E_i}}(G, \alpha) =: \mathcal{M}_i(G, \alpha), \quad (13b)$$

for short, $i = 1, 2$. We formulate the order-2 state-estimation-based property as follows. Recall with respect to a label sequence $\alpha \in P_1(L(G))$ generated by G observed by agent A_1 , A_1 's current-state estimate of G is $\mathcal{M}_1(G, \alpha)$. Agent A_2 knows E_1 , so A_2 can infer A_1 's current-state estimate of G from A_2 's own observations to G .

For a label sequence α observed by A_2 , the real generated event sequence can be any one $s \in P_2^{-1}(\alpha) \cap L(G)$, so the observation of A_1 can be any $P_1(s)$, and then the inference of A_1 's current-state estimate from A_2 can be any $\mathcal{M}_1(G, P_1(s))$. Formally, with respect to $\alpha \in P_2(L(G))$, all possible inferences of A_1 's current-state estimate of G by A_2 are formulated as the set

$$\mathcal{M}_{A_1 \leftarrow A_2}(G, \alpha) \quad (14a)$$

$$:= \{\mathcal{M}_1(G, P_1(s)) \mid s \in P_2^{-1}(\alpha) \cap L(G)\} \subset 2^Q. \quad (14b)$$

Because A_2 computes all possible strings $s \in L(G)$ with $P_2(s) = \alpha$ which must contain the real generated string, $\mathcal{M}_{A_1 \leftarrow A_2}(G, \alpha)$ must contain A_1 's real current-state estimate of G .

An order-2 state-estimation-based property is used to describe A_2 's inference of A_1 's current-state estimate of G . Define *predicate of order-2 as*

$$\text{PRED}_2 \subset 2^{2^Q}. \quad (15)$$

Then an order-2 state-estimation-based property is defined as follows.

Definition 13 *An FSA G satisfies the order-2 state-estimation-based property PRED_2 with respect to agents A_1 and A_2 if*

$$\{\mathcal{M}_{A_1 \leftarrow A_2}(G, \alpha) \mid \alpha \in P_2(L(G))\} \subset \text{PRED}_2. \quad (16)$$

In order to derive an algorithm to verify [Definition 13](#), we use two basic tools — concurrent composition (as in [Definition 2](#)) and observer (as in [Definition 3](#)) to define a new tool — *order-2 observer*. Note that the definition itself is also a procedure to compute an order-2 observer.

Definition 14 *Consider FSA G as in (1), agents A_1 and A_2 with their observable event sets E_1 and E_2 , where $E_1, E_2 \subset E$. Denote LFSAs (G, E_i, P_i) by G_{A_i} , $i = 1, 2$.*

1. *Compute the observer $\text{Obs}_1(G)$ of G_{A_1} , and denote $\text{Obs}_1(G)$ as Obs_{A_1} for short.*
2. *Compute the concurrent composition $\text{CC}(G_{A_1}, \text{Obs}_{A_1})$ of LFSAs G_{A_1} and its observer Obs_{A_1} , replace each event (e_1, e_2) by e_1 , replace the labeling function of $\text{CC}(G_{A_1}, \text{Obs}_{A_1})$ by P_2 , and denote the modification of $\text{CC}(G_{A_1}, \text{Obs}_{A_1})$ by $\text{CC}_{A_1 \rightarrow A_2}^{G, \text{Obs}}$ which is an LFSAs.*
3. *Compute the observer $\text{Obs}(\text{CC}_{A_1 \rightarrow A_2}^{G, \text{Obs}})$ of $\text{CC}_{A_1 \rightarrow A_2}^{G, \text{Obs}}$, and call $\text{Obs}(\text{CC}_{A_1 \rightarrow A_2}^{G, \text{Obs}})$ order-2 observer and denote it as $\text{Obs}_{A_1 \leftarrow A_2}(G)$.*

See [Figure 5](#) for an illustration. It takes doubly exponential time to compute an order-2 observer $\text{Obs}_{A_1 \leftarrow A_2}(G)$.

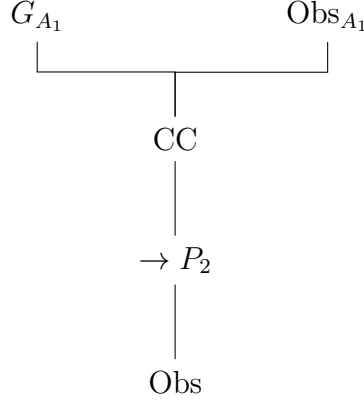

Figure 5: Sketch of the order-2 observer and 2-EXPTIME verification structure for the order-2 state-estimation-based property.

The next [Lemma 5.1](#) shows several fundamental properties of the order-2 observer $\text{Obs}_{A_1 \leftarrow A_2}(G)$, and plays a fundamental role in verifying the order-2 state-estimation-based property.

Lemma 5.1. *Consider an FSA G as in (1), agents A_1 and A_2 with their observable event sets E_1 and E_2 , and the order-2 observer $\text{Obs}_{A_1 \leftarrow A_2}(G)$.*

- (i) *The initial state of $\text{Obs}_{A_1 \leftarrow A_2}(G)$ is of the form $\{(q_{0,1}, X_0), \dots, (q_{0,m}, X_0)\}$, where $\{q_{0,1}, \dots, q_{0,m}\} = X_0$, X_0 is the initial state of Obs_{A_1} .*
- (ii) *$L(G) = L(\text{CC}(\text{CC}_{A_1 \rightarrow A_2}^{G, \text{Obs}}, \text{Obs}_{A_1 \leftarrow A_2}(G)))$.*
- (iii) *For every reachable state $\{(q_1, X_1), \dots, (q_n, X_n)\}$ of $\text{Obs}_{A_1 \leftarrow A_2}(G)$, $q_j \in X_j$, $1 \leq j \leq n$.*
- (iv) *For every run $C_0 \xrightarrow{\alpha} \{(q_1, X_1), \dots, (q_n, X_n)\}$ of $\text{Obs}_{A_1 \leftarrow A_2}(G)$, where C_0 is the initial state, $\{X_1, \dots, X_n\} = \mathcal{M}_{A_1 \leftarrow A_2}(G, \alpha)$.*

By [Lemma 5.1](#), the following [Theorem 5.2](#) holds.

Theorem 5.2 *An FSA G satisfies the order-2 state-estimation-based property PRED_2 (15) with respect to agents A_1 and A_2 if and only if for every reachable state $\{(q_1, X_1), \dots, (q_n, X_n)\}$ of order-2 observer $\text{Obs}_{A_1 \leftarrow A_2}(G)$, $\{X_1, \dots, X_n\} \in \text{PRED}_2$.*

[Theorem 5.2](#) provides an algorithm for verifying the order-2 state-estimation-based property in doubly exponential time.

Example 5.3. *Consider FSA G_{III} as in [Figure 6](#). We consider $E_1^{\text{III}} = \{b, c, d\}$ and $E_2^{\text{III}} = \{a, b\}$. We use [Theorem 5.2](#) and follow the sketch shown in [Figure 5](#) to verify the order-2 state-estimation-based property $\{\emptyset \notin Y \subset 2^{\{0,1,2,3,4,5\}} \mid (\exists X \in Y) [|X| > 1]\} \subset 2^{2^{\{0,1,2,3,4,5\}}}$ of G_{III} with respect to agents A_1^{III} , A_2^{III} . The FSA G_{III} with respect to agents A_1^{III} and A_2^{III} are denoted by $G_{A_1^{\text{III}}}^{\text{III}}$ and $G_{A_2^{\text{III}}}^{\text{III}}$, respectively. The observer $\text{Obs}_{A_1^{\text{III}}}$ of $G_{A_1^{\text{III}}}^{\text{III}}$ is shown in [Figure 7](#). The concurrent composition $\text{CC}_{A_1^{\text{III}} \rightarrow A_2^{\text{III}}}^{G_{\text{III}}, \text{Obs}}$ is shown in [Figure 8](#). The order-2 observer $\text{Obs}(\text{CC}_{A_1^{\text{III}} \rightarrow A_2^{\text{III}}}^{G_{\text{III}}, \text{Obs}}) = \text{Obs}_{A_1^{\text{III}} \leftarrow A_2^{\text{III}}}(G_{\text{III}})$ is shown in [Figure 9](#). In [Figure 9](#), there is a reachable state $\{(2, B)\}$ in which B is a singleton and there is no state of the form (q, X) with $|X| > 1$. By [Theorem 5.2](#), G_{III} does not satisfy the order-2 state-estimation-based property.*

Directly by definition, for the run $0 \xrightarrow{a} 1 \xrightarrow{b} 2$, one has $P_2^{\text{III}}(ab) = ab$, $(P_2^{\text{III}})^{-1}(ab) = \{ab\}$, $P_1^{\text{III}}(ab) = b$, $\mathcal{M}_1^{\text{III}}(G_{\text{III}}, b) = \{2\}$. Hence A_2^{III} knows that A_1^{III} uniquely determines the current state when observing ab . Then we conclude that G_{III} does not satisfy the order-2 state-estimation-based property.

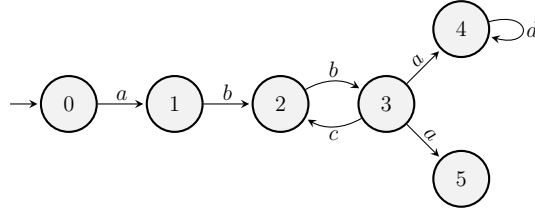

Figure 6: Automaton G_{III} considered in Example 5.3, where $E_1^{\text{III}} = \{b, c, d\}$, $E_2^{\text{III}} = \{a, b\}$.

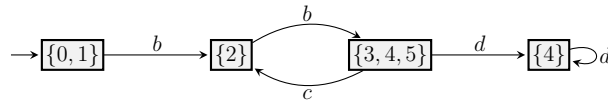

Figure 7: The observer $\text{Obs}_{A_1^{\text{III}}}$ of automaton $G_{A_1^{\text{III}}}^{\text{III}}$ (shown in Figure 6).

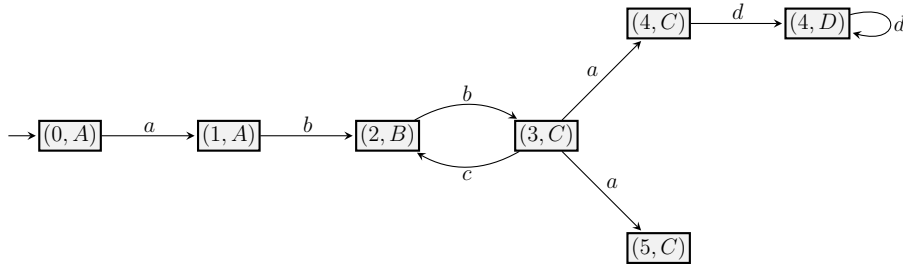

Figure 8: The concurrent composition $\text{CC}_{A_1^{\text{III}}, \text{Obs}_{A_1^{\text{III}}}^{\text{III}}}^{G_{\text{III}}, \text{Obs}_{A_1^{\text{III}}}^{\text{III}}}$, where $A = \{0, 1\}$, $B = \{2\}$, $C = \{3, 4, 5\}$, $D = \{4\}$.

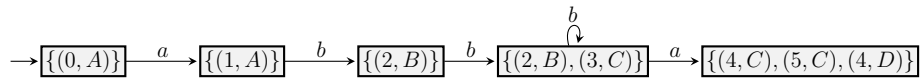

Figure 9: The order-2 observer $\text{Obs}_{A_1^{\text{III}} \leftarrow A_2^{\text{III}}}(G_{\text{III}})$, where $A = \{0, 1\}$, $B = \{2\}$, $C = \{3, 4, 5\}$, $D = \{4\}$.

5.2 Several special cases verifiable in exponential time

For several special cases, the verification of the order-2 state-estimation-based property can be done in exponential time.

5.2.1 Special case 1

Consider $E_1 \subset E_2$. Then agent A_2 knows more on G than agent A_1 , and can know exactly A_1 's current-state estimate of G . Formally, in this case, for all $\alpha \in P_2(L(G))$,

$$\mathcal{M}_{A_1 \leftarrow A_2}(G, \alpha) = \{\mathcal{M}_1(G, P_1(\alpha))\}, \quad (17a)$$

$$\mathcal{M}_2(G, \alpha) \subset \mathcal{M}_1(G, P_1(\alpha)). \quad (17b)$$

This implies the following [Theorem 5.4](#).

Theorem 5.4 *Assume $E_1 \subset E_2$. Then each state of order-2 observer $\text{Obs}_{A_1 \leftarrow A_2}(G)$ is of the form $\{(q_1, X), \dots, (q_n, X)\}$ with $q_1, \dots, q_n \in X \subset Q$, $\text{Obs}_{A_1 \leftarrow A_2}(G)$ and Obs_{A_2} have the same number of reachable states. For every run $Y_0 \xrightarrow{\alpha} \{(q_1, X), \dots, (q_n, X)\}$ of $\text{Obs}_{A_1 \leftarrow A_2}(G)$ and every run $X_0 \xrightarrow{\alpha} X'$ of Obs_{A_2} , where Y_0 and X_0 are the initial states of the two observers, $X' \subset X$.*

Furthermore, $\text{Obs}_{A_1 \leftarrow A_2}(G)$ can be computed in exponential time, and then the order-2 state-estimation-based property can be verified in exponential time.

Example 5.5. *Reconsider FSA G_{III} studied in [Example 5.3](#) (in [Figure 6](#)). We consider agents $A_1^{\text{III}'}$ and A_2^{III} whose observable event sets are $E_1^{\text{III}'} = \{a\}$ and $E_2^{\text{III}} = \{a, b\}$, respectively. Then we have $E_1^{\text{III}'} \subset E_2^{\text{III}}$. The observer $\text{Obs}_{A_1^{\text{III}'}}$, the concurrent composition $\text{CC}_{A_1^{\text{III}'} \rightarrow A_2^{\text{III}}}^{G_{\text{III}}, \text{Obs}}$, the order-2 observer $\text{Obs}_{A_1^{\text{III}'} \leftarrow A_2^{\text{III}}}(G_{\text{III}})$, and the observer $\text{Obs}_{A_2^{\text{III}}}$ are shown in [Figure 10](#), [Figure 11](#), [Figure 12](#), [Figure 13](#) respectively. [Figure 12](#) and [Figure 13](#) illustrate [Theorem 5.4](#).*

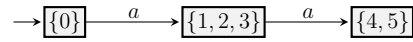

Figure 10: The observer $\text{Obs}_{A_1^{\text{III}'}}$ of automaton $G_{A_1^{\text{III}'}}$.

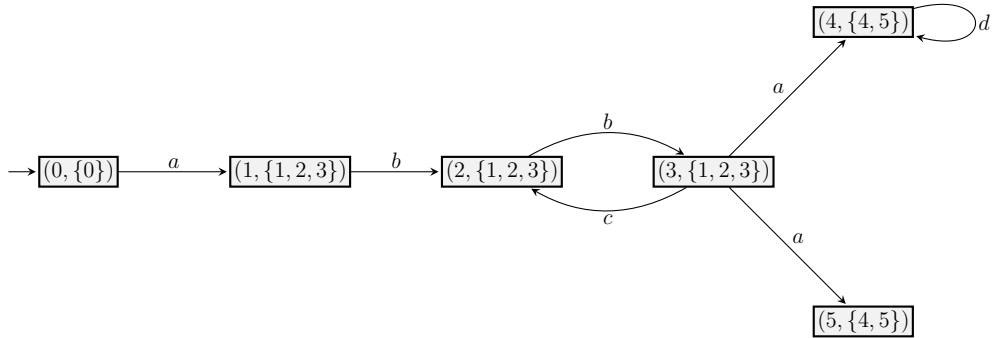

Figure 11: The concurrent composition $\text{CC}_{A_1^{\text{III}' \rightarrow A_2^{\text{III}}}^{G_{\text{III}}, \text{Obs}}$.

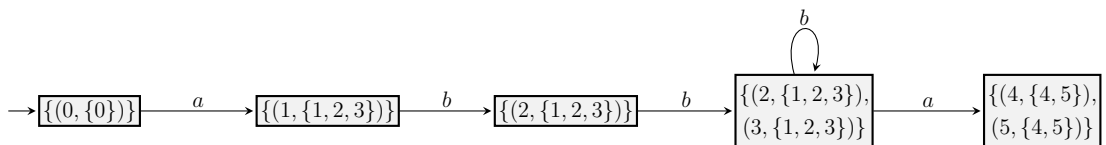

Figure 12: The order-2 observer $\text{Obs}_{A_1^{\text{III}' \leftarrow A_2^{\text{III}}}(G_{\text{III}})$.

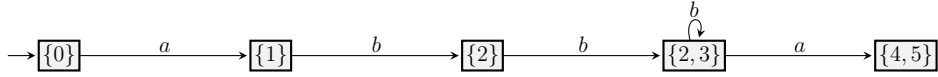

Figure 13: The observer $\text{Obs}_{A_2}^{\text{III}}$ of automaton $G_{A_2}^{\text{III}}$.

5.2.2 Special case 2

Consider $E_2 \subset E_1$. In this case, although agent A_2 knows less on G than agent A_1 , all inferences of A_1 's current-state estimate done by A_2 are contained in A_2 's own current-state estimate. Formally, for all $\alpha \in P_2(L(G))$, for all $s \in P_2^{-1}(\alpha) \cap L(G)$, one has

$$\mathcal{M}_1(G, P_1(s)) \subset \mathcal{M}_2(G, \alpha),$$

because $P_2(P_1^{-1}(P_1(s))) = \{\alpha\}$. This implies the following [Theorem 5.6](#).

Theorem 5.6 Assume $E_2 \subset E_1$. $\text{Obs}_{A_1 \leftarrow A_2}(G)$ and Obs_{A_2} have the same number of reachable states. Consider a run $Y_0 \xrightarrow{\alpha} Y_1$ in observer $\text{Obs}_{A_1 \leftarrow A_2}(G)$ and a run $X_0 \xrightarrow{\alpha} X_1$ in observer Obs_{A_2} , where Y_0 and X_0 are the corresponding initial states, $\alpha \in (E_2)^*$. Then for every element (q, X) of Y_1 , $X \subset X_1$.

By [Theorem 5.6](#), order-2 observer $\text{Obs}_{A_1 \leftarrow A_2}(G)$ can be computed in exponential time, and then the order-2 state-estimation-based property can also be verified in exponential time.

Example 5.7. Reconsider FSA G^{III} studied in [Example 5.3](#) (in [Figure 6](#)). We consider agents $A_1^{\text{III}'}$ and A_2^{III} whose observable event sets are $E_1^{\text{III}'} = \{a, b, d\}$ and $E_2^{\text{III}} = \{a, b\}$, respectively. Then we have $E_2^{\text{III}} \subset E_1^{\text{III}'}$. The observer $\text{Obs}_{A_1^{\text{III}'}}^{\text{III}'}$, the concurrent composition $\text{CC}_{A_1^{\text{III}' \rightarrow A_2^{\text{III}}}}^{G^{\text{III}}, \text{Obs}}$, the order-2 observer $\text{Obs}_{A_1^{\text{III}' \leftarrow A_2^{\text{III}}}}^{\text{III}' \leftarrow \text{III}}(G^{\text{III}})$, and the observer $\text{Obs}_{A_2^{\text{III}}}^{\text{III}}$ are shown in [Figure 14](#), [Figure 15](#), [Figure 16](#), [Figure 13](#), respectively. [Figure 16](#) and [Figure 13](#) illustrate [Theorem 5.6](#).

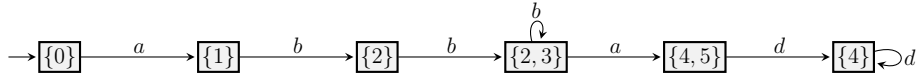

Figure 14: The observer $\text{Obs}_{A_1^{\text{III}'}}^{\text{III}'}$ of automaton $G_{A_1^{\text{III}'}}^{\text{III}'}$.

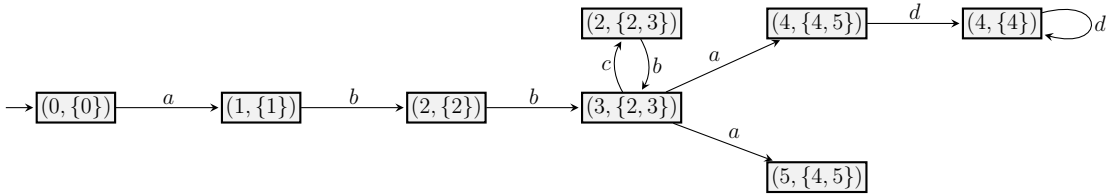

Figure 15: The concurrent composition $\text{CC}_{A_1^{\text{III}' \rightarrow A_2^{\text{III}}}}^{G^{\text{III}}, \text{Obs}}$.

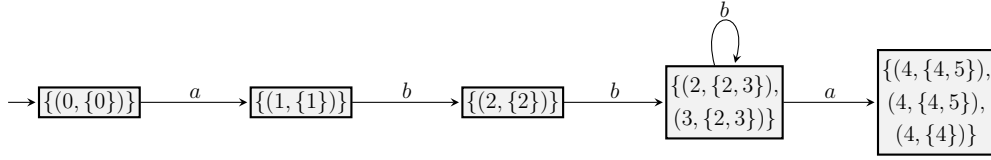

Figure 16: The order-2 observer $\text{Obs}_{A_1 \leftarrow A_2}^{\text{III}'}(G^{\text{III}})$.

5.2.3 Special case 3

Consider

$$T_{\text{Det}} = \{X_1, \dots, X_m\}, \quad (18)$$

where $X_i \subset Q$, $1 \leq |X_i| \leq 2$, $i = 1, \dots, m$. By T_{Det} , we define a special type

$$\text{PRED}_{2T_{\text{Det}}} = \{\emptyset \notin Y \subset 2^Q \mid (\exists X \in Y)(\exists X' \in T_{\text{Det}})[X' \subset X]\} \subset 2^{2^Q} \quad (19)$$

of predicates.

In order to give an exponential-time verification algorithm, for this special case, one possibility is to change the observer Obs_{A_1} in Figure 5 to detector Det_{A_1} .

1. Compute the detector Det_{A_1} of G_{A_1} .
2. Compute the concurrent composition $\text{CC}(G_{A_1}, \text{Det}_{A_1})$ of LFSA G_{A_1} and its detector Det_{A_1} , replace each event (e_1, e_2) by e_1 , replace the labeling function by P_2 , and denote the modification of $\text{CC}(G_{A_1}, \text{Det}_{A_1})$ by $\text{CC}_{A_1 \rightarrow A_2}^{G, \text{Det}}$ which is an LFSA.
3. Compute the observer $\text{Obs}(\text{CC}_{A_1 \rightarrow A_2}^{G, \text{Det}})$ of $\text{CC}_{A_1 \rightarrow A_2}^{G, \text{Det}}$.

See Figure 17 for an illustration.

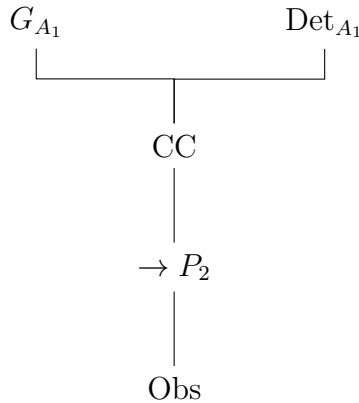

Figure 17: Sketch of the EXPTIME verification structure for the special type of order-2 state-estimation-based property with respect to (19).

The observer $\text{Obs}(\text{CC}_{A_1 \rightarrow A_2}^{G, \text{Det}})$ can be computed in exponential time. Note a fundamental difference between $\text{CC}_{A_1 \rightarrow A_2}^{G, \text{Det}}$ and $\text{CC}_{A_1 \rightarrow A_2}^{G, \text{Obs}}$: in $\text{CC}_{A_1 \rightarrow A_2}^{G, \text{Obs}}$, for every reachable state (q, X) , if there is an

observable transition starting at q with event a in G_{A_1} , then there must exist an observable transition starting at (q, X) with event a in $CC_{A_1 \rightarrow A_2}^{G, \text{Obs}}$. However, this may not hold for $CC_{A_1 \rightarrow A_2}^{G, \text{Det}}$, see Figure 19.

Lemma 5.8. Consider an FSA G as in (1), agents A_1 and A_2 with their observable event sets E_1 and E_2 , and the observer $\text{Obs}(CC_{A_1 \rightarrow A_2}^{G, \text{Det}})$. Then Each initial state of observer $\text{Obs}(CC_{A_1 \rightarrow A_2}^{G, \text{Det}})$ is of the form $\{(q_{0,1}, X_0), \dots, (q_{0,m}, X_0)\}$, where $\{q_{0,1}, \dots, q_{0,m}\} = X_0$, X_0 is the initial state of Det_{A_1} .

Theorem 5.9 An FSA G satisfies the order-2 state-estimation-based property $\text{PRED}_{2T_{\text{Det}}}$ (19) with respect to agents A_1 and A_2 , if and only if, for every reachable state $\{(q_1, X_1), \dots, (q_n, X_n)\}$ of $\text{Obs}(CC_{A_1 \rightarrow A_2}^{G, \text{Det}})$, $\{X_1, \dots, X_n\} \in \text{PRED}_{2T_{\text{Det}}}$.

Proof By Lemma 2.1, Theorem 5.2, and Lemma 5.8. \square

Theorem 5.9 provides an exponential-time algorithm for verifying this special type of order-2 state-estimation-based property.

Example 5.10. Reconsider FSA G_{III} studied in Example 5.3 (in Figure 6). We use Theorem 5.9 and follow the sketch shown in Figure 17 to verify if G_{III} satisfies the order-2 state-estimation-based property $\{\emptyset \notin Y \subset 2^{\{0,1,2,3,4,5\}} \mid (\exists X \in Y) [|X| > 1]\} \subset 2^{2^{\{0,1,2,3,4,5\}}}$ with respect to agents A_1^{III} , A_2^{III} , where the corresponding T_{Det} as in (18) is equal to $\{X \subset Q \mid |X| = 2\}$. The detector $\text{Det}_{A_1^{\text{III}}}$ of $G_{A_1^{\text{III}}}$ is shown in Figure 18. The concurrent composition $CC_{A_1^{\text{III}} \rightarrow A_2^{\text{III}}}^{G_{\text{III}}, \text{Det}}$ is shown in Figure 19. The observer $\text{Obs}(CC_{A_1^{\text{III}} \rightarrow A_2^{\text{III}}}^{G_{\text{III}}, \text{Det}})$ is shown in Figure 20.

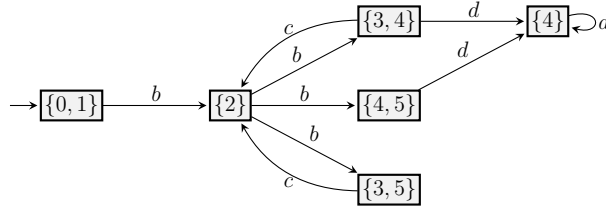

Figure 18: The detector $\text{Det}_{A_1^{\text{III}}}$ of automaton $G_{A_1^{\text{III}}}$ (shown in Figure 6).

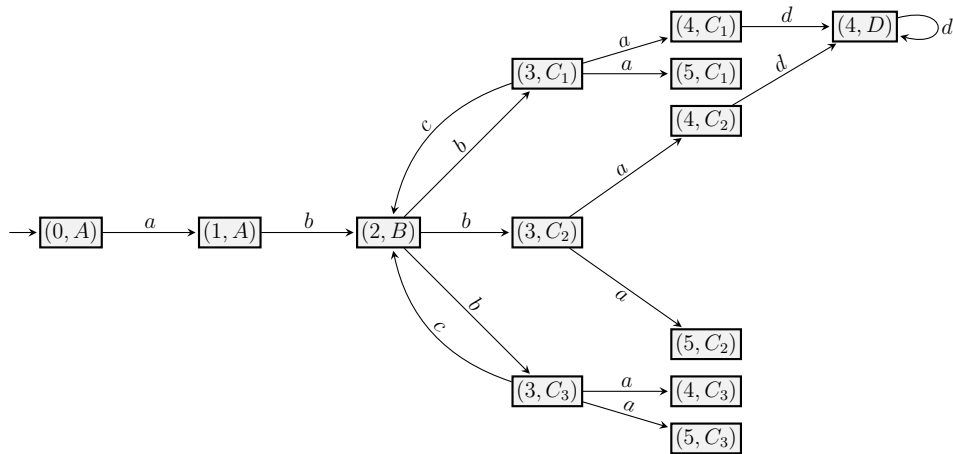

Figure 19: The concurrent composition $CC_{A_1^{\text{III}} \rightarrow A_2^{\text{III}}}^{G_{\text{III}}, \text{Det}}$, where $A = \{0, 1\}$, $B = \{2\}$, $C_1 = \{3, 4\}$, $C_2 = \{4, 5\}$, $C_3 = \{3, 5\}$, $D = \{4\}$. Note that at state $(4, C_3)$ there is no transition with event d , although there is an observable transition $4 \xrightarrow{d} 4$ in $G_{A_1^{\text{III}}}$.

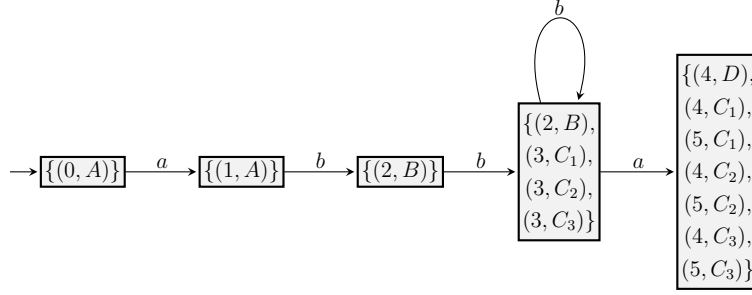

Figure 20: The observer $\text{Obs}(\text{CC}_{A_1 \rightarrow A_2}^{G_{\text{III}}, \text{Det}})$.

In [Figure 20](#), there is a reachable state $\{(2, B)\}$ in which B is a singleton, and there is no state of the form (q, X) with $|X| = 2$. By [Theorem 5.9](#), G_{III} does not satisfy the order-2 state-estimation-based property, which is consistent with the result derived in [Example 5.3](#).

Remark 1 Based on the above argument, whether an FSA G satisfies the order-2 state-estimation-based property $2^{2^Q} \setminus \text{PRED}_{2T_{\text{Det}}}$ with respect to agents A_1 and A_2 can also be verified in exponential time, where $\text{PRED}_{2T_{\text{Det}}}$ is defined in [\(19\)](#).

5.3 Case study 1: Order-2 current-state opacity

In this subsection, we study a special type of order-2 state-estimation-based property — high-order opacity.

Let us first review current-state opacity studied in [subsection 4.2](#) in a high level. A fictitious “user” Usr (i) knows the structure of an automaton G , also (ii) knows the state G is in at every instant, and (iii) wants to forbid the behavior of G visiting a secret state from being leaked to an “intruder” Intr who also knows the structure of G but can only see the occurrences of observable events E_{Intr} of G . If G is sufficiently safe in that sense, then Usr can operate on G . This can be regarded as order-1 state-estimation-based property. From a generalization point of view, it is acceptable if Usr knows enough knowledge of G (although less than before) but still can do (iii), then G can also be regarded to be sufficiently safe, which can be formulated as *high-order state-based opacity*. In this more general case, we assume the user still can do (i) but cannot always do (ii). Instead, we assume that Usr can observe a subset E_{Usr} of events of G , so can do state estimation according to his/her observations to G . We also assume that Intr knows E_{Usr} although cannot observe $E_{\text{Usr}} \setminus E_{\text{Intr}}$, so can infer what Usr observes according to Intr ’s own observations. It turns out that Intr ’s inference of Usr ’s state estimate of G is a set of subsets of G . Hence in this more general case, the secrets corresponding to Intr are a set of subsets of states of G instead of a subset Q_S of states of G as in the order-1 case. To be general enough, we define *order-2 secrets* as

$$Q_S^{\text{ord}-2} := \{Y_1, \dots, Y_m\} \subset 2^{2^Q}, \quad (20)$$

where $\emptyset \notin Y_i \subset 2^Q, 1 \leq i \leq m$. *Secret constraints* are defined recursively as

$$\psi(Q_S^{\text{ord}-2}) := \cdot \not\subset Y_i \mid \psi_1 \wedge \psi_2 \mid \psi_1 \vee \psi_2, \quad (21)$$

that is, $\cdot \not\subseteq Y_i$ is a secret constraint, $\psi_1 \wedge \psi_2$ is a secret constraint if both ψ_1 and ψ_2 are, $\psi_1 \vee \psi_2$ is a secret constraint if both ψ_1 and ψ_2 are.

For example, $\bigvee_{i=1}^m \cdot \not\subseteq Y_i$ and $\bigwedge_{i=1}^m \cdot \not\subseteq Y_i$ are both secret constraints.

A subset $\emptyset \not\subseteq Y \subset 2^Q$ satisfies a secret constraint $\psi(Q_S^{\text{ord}-2})$, is defined as, $Y \models \psi(Q_S^{\text{ord}-2})$.

For example, $Y \models \bigvee_{i=1}^m \cdot \not\subseteq Y_i$ is defined as $\bigvee_{i=1}^m Y \not\subseteq Y_i$, $Y \models \bigwedge_{i=1}^m \cdot \not\subseteq Y_i$ is defined as $\bigwedge_{i=1}^m Y \not\subseteq Y_i$, i.e., obtained by substituting Y for \cdot .

A predicate is defined as

$$\text{PRED}(G, Q_S^{\text{ord}-2}, \psi(Q_S^{\text{ord}-2})) := \{\emptyset \not\subseteq Y \subset 2^Q \mid Y \models \psi(Q_S^{\text{ord}-2})\} \subset 2^{2^Q}. \quad (22)$$

For $\alpha \in P_{\text{Intr}}(L(G))$, Intr's inference of Usr's current-state estimate of G can be any $\mathcal{M}_{\text{Usr}}(G, P_{\text{Usr}}(s))$, where $s \in P_{\text{Intr}}^{-1}(\alpha) \cap L(G)$, formulated as

$$\mathcal{M}_{\text{Usr} \leftarrow \text{Intr}}(G, \alpha) \quad (23a)$$

$$:= \{\mathcal{M}_{\text{Usr}}(G, P_{\text{Usr}}(s)) \mid s \in P_{\text{Intr}}^{-1}(\alpha) \cap L(G)\} \subset 2^Q. \quad (23b)$$

Note that (23) actually coincides with (14) if agents A_1 and A_2 are specified as the user Usr and the intruder Intr, respectively.

Because Intr computes all possible strings $s \in L(G)$ with $P_{\text{Intr}}(s) = \alpha$ which must contain the real generated string, $\mathcal{M}_{\text{Usr} \leftarrow \text{Intr}}(G, \alpha)$ must contain the real current-state estimate of Usr.

Definition 15 (Ord2CSO) *An FSA G is called order-2 current-state opaque with respect to Usr, Intr, $Q_S^{\text{ord}-2}$, and $\psi(Q_S^{\text{ord}-2})$ if*

$$\{\mathcal{M}_{\text{Usr} \leftarrow \text{Intr}}(G, \alpha) \mid \alpha \in P_{\text{Intr}}(L(G))\} \subset \text{PRED}(G, Q_S^{\text{ord}-2}, \psi(Q_S^{\text{ord}-2})). \quad (24)$$

Definition 15 means that if FSA G is order-2 current-state opaque with respect to P_{Usr} , P_{Intr} , $Q_S^{\text{ord}-2}$, and $\psi(Q_S^{\text{ord}-2})$, then corresponding to every observation $\alpha \in P_{\text{Intr}}(L(G))$ of intruder Intr to G , the inference $\mathcal{M}_{\text{Usr} \leftarrow \text{Intr}}(G, \alpha)$ of the current-state estimate of user Usr by Intr belongs to the predicate $\text{PRED}(G, Q_S^{\text{ord}-2}, \psi(Q_S^{\text{ord}-2}))$, then $\mathcal{M}_{\text{Usr} \leftarrow \text{Intr}}(G, \alpha) \models \psi(Q_S^{\text{ord}-2})$.

Remark 2 *By definition, one sees that the order-2 current-state opacity of FSA G with respect to Usr, Intr, $Q_S^{\text{ord}-2}$, and $\psi(Q_S^{\text{ord}-2})$ is a special case of the order-2 state-estimation-based property PRED_2 of G with respect to agents A_1 and A_2 as in Definition 13 because Usr and Intr can be regarded as agents A_1 and A_2 , respectively. For this special case, the order-2 state-estimation-based property is used to describe a practical scenario.*

Next, we show two special subclasses of order-2 current-state opacity.

5.3.1 A scenario — The high-order opacity studied in [2]

The high-order opacity proposed in [2], used to describe a scenario “You don’t know what I know”, is interesting and a strict subclass of the order-2 current-state opacity as in Definition 15.

The high-order opacity studied in [2] is as follows. Consider a set $T_{\text{spec}} \subset \{\{q, q'\} \mid q, q' \in Q\}$ of distinguishability state pairs. A deterministic FSA G is called *high-order opaque with respect to user*

Usr, intruder Intr, and T_{spec} if

for every run $q_0 \xrightarrow{s} q$ with $q_0 \in Q_0$ and $(\mathcal{M}_{\text{Usr}}(G, P_{\text{Usr}}(s)) \times \mathcal{M}_{\text{Usr}}(G, P_{\text{Usr}}(s))) \cap T_{\text{spec}} = \emptyset$, there is another run $q'_0 \xrightarrow{t} q'$ with $q'_0 \in Q_0$ such that $(\mathcal{M}_{\text{Usr}}(G, P_{\text{Usr}}(t)) \times \mathcal{M}_{\text{Usr}}(G, P_{\text{Usr}}(t))) \cap T_{\text{spec}} \neq \emptyset$ and $P_{\text{Intr}}(s) = P_{\text{Intr}}(t)$. (A)

If a deterministic FSA G is high-order opaque with respect to Usr, Intr, and T_{spec} , then Intr cannot be sure whether Usr can distinguish between the states of each state pair of T_{spec} according to Usr's current-state estimate of G .

By definition, high-order opacity of G with respect to Usr, Intr, and T_{spec} , is equivalent to, order-2 current-state opacity with respect to Usr, Intr, $Q_S^{\text{ord}-2}$, and $\psi(Q_S^{\text{ord}-2})$ as in Definition 15, where $Q_S^{\text{ord}-2} = \{X_{\{q,q'\}} \mid \{q, q'\} \in T_{\text{spec}}\}$, $X_{\{q,q'\}} = 2^Q \setminus \{X \subset Q \mid \{q, q'\} \subset X\}$, $\psi(Q_S^{\text{ord}-2}) = \bigvee_{\{q,q'\} \in T_{\text{spec}}} \cdot \not\subset X_{\{q,q'\}}$, is also equivalent to, order-2 state-estimation-based property

$$\text{PRED}_2(G, Q_S^{\text{ord}-2}, \psi(Q_S^{\text{ord}-2})) = \{\emptyset \notin Y \subset 2^Q \mid (\exists X \in Y)(\exists X' \in T_{\text{spec}})[X' \subset X]\}.$$

Theorem 5.2 provides a 2-EXPTIME algorithm for verifying high-order opacity of G with respect to Usr, Intr, and T_{spec} . Theorem 5.9 provides an EXPTIME algorithm for verifying the high-order opacity.

In [2], an interesting special case of the high-order opacity was also studied:

for every run $q_0 \xrightarrow{s} q$ with $q_0 \in Q_0$ and $|\mathcal{M}_{\text{Usr}}(G, P_{\text{Usr}}(s))| = 1$, there is another run $q'_0 \xrightarrow{t} q'$ with $q'_0 \in Q_0$ such that $|\mathcal{M}_{\text{Usr}}(G, P_{\text{Usr}}(t))| > 1$ and $P_{\text{Intr}}(s) = P_{\text{Intr}}(t)$, (B)

that is, the high-order opacity of deterministic G with respect to Usr, Intr, and $T_{\text{spec}} = \{\{q, q'\} \mid q, q' \in Q, q \neq q'\}$.

In case of (B), whenever the current-state estimate of Usr is a singleton, Intr cannot be sure whether the current-state estimate of Usr is a singleton or not.

This special case, is equivalent to, order-2 current-state opacity with respect to Usr, Intr, $Q_S^{\text{ord}-2} = \{\{\{q\} \mid q \in Q\}\}$, and $\psi(Q_S^{\text{ord}-2}) = \cdot \not\subset \{\{q\} \mid q \in Q\}$, is also equivalent to, order-2 state-estimation-based property

$$\text{PRED}_2(G, Q_S^{\text{ord}-2}, \psi(Q_S^{\text{ord}-2})) = \{\emptyset \notin Y \subset 2^Q \mid (\exists X \in Y)[|X| > 1]\}.$$

In [2], in order to verify high-order opacity, two methods — *double-observer* and *state-pair-observer*, were proposed, where the former runs in doubly exponential time and the latter runs in exponential time. Next, we give counterexamples to show that neither of these two methods works correctly generally, even with respect to $T_{\text{spec}} = \{\{q, q'\} \mid q, q' \in Q, q \neq q'\}$.

The following example shows that both the *double-observer* method and the *state-pair-observer* method sometimes fail to verify high-order opacity defined in (B), that is, the main results obtained in [2] are not correct. This example also shows the double-observer generally cannot correctly compute the inference of the current-state estimate of Usr by Intr defined as $\mathcal{M}_{\text{Usr} \leftarrow \text{Intr}}(G, \alpha)$, where $\alpha \in P_{\text{Intr}}(L(G))$.

Example 5.11. Consider FSA G_{IV} as in Figure 21, where $E_{Usr_{IV}} = \{b, c\}$, $E_{Intr_{IV}} = \{a, b\}$. We choose $T_{IV\text{ spec}} = \{\{0, 1\}, \{4, 5\}\}$, and show that neither the double-observer nor the state-pair-observer can correctly verify the high-order opacity of G_{IV} with respect to Usr_{IV} , $Intr_{IV}$, and $T_{IV\text{ spec}}$. The variant of observer $Obs_{Usr_{IV}}$ defined in [2], denoted as $\overline{Obs_{Usr_{IV}}}$, is shown in Figure 22. Compared with the standard observer $Obs_{Usr_{IV}}$ as in Figure 25, in $\overline{Obs_{Usr_{IV}}}$, there is an additional self-loop on state $\{0, 1\}$ with event a because starting from state 0 there is an unobservable transition with event a in $G_{Usr_{IV}}^{IV}$. The observer $Obs_{Intr_{IV}}(\overline{Obs_{Usr_{IV}}})$ (i.e., the so-called double-observer defined in [2]) of $\overline{Obs_{Usr_{IV}}}$ is shown in Figure 23. In state $\{\{0, 1\}, \{2\}\}$ of $Obs_{Intr_{IV}}(\overline{Obs_{Usr_{IV}}})$, $(\{0, 1\} \times \{0, 1\}) \cap T_{IV\text{ spec}} \neq \emptyset$, in state $\{\{3\}, \{4, 5\}\}$, $(\{4, 5\} \times \{4, 5\}) \cap T_{IV\text{ spec}} \neq \emptyset$, then by [2, Theorem 1], G_{IV} is high-order opaque with respect to Usr_{IV} , $Intr_{IV}$, and $T_{IV\text{ spec}}$.

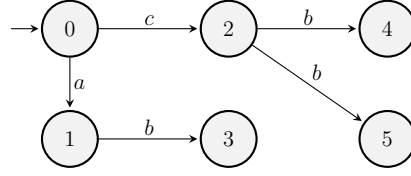

Figure 21: FSA G_{IV} , where $E_{Usr_{IV}} = \{b, c\}$, $E_{Intr_{IV}} = \{a, b\}$.

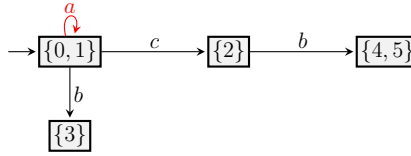

Figure 22: The variant observer $\overline{Obs_{Usr_{IV}}}$ of automaton $G_{Usr_{IV}}^{IV}$ (as in Figure 21).

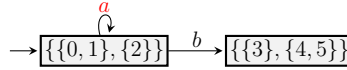

Figure 23: The observer $Obs_{Intr_{IV}}(\overline{Obs_{Usr_{IV}}})$ of $\overline{Obs_{Usr_{IV}}}$ (in Figure 22).

The state-pair-observer of G_{IV} with respect to Usr_{IV} and $Intr_{IV}$ is shown in Figure 24 and satisfies that no state has empty intersection with $T_{IV\text{ spec}}$. Then by [2, Theorem 2], one also has G_{IV} is high-order opaque with respect to Usr_{IV} , $Intr_{IV}$, and $T_{IV\text{ spec}}$.

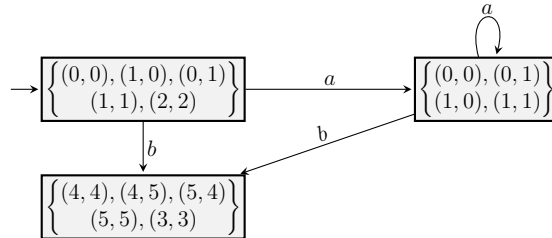

Figure 24: The state-pair-observer of G_{IV} with respect to Usr_{IV} and $Intr_{IV}$ (in Figure 21).

Directly by definition, from $ab \in P_{Intr_{IV}}(L(G_{IV}))$, we have $\mathcal{M}_{Usr_{IV} \leftarrow Intr_{IV}}(G_{IV}, ab) = \{\{3\}\}$. We have $(\{3\} \times \{3\}) \cap T_{IV\text{ spec}} = \emptyset$, then G_{IV} is not high-order opaque with respect to Usr_{IV} , $Intr_{IV}$, and

$T_{IV\text{ spec}}$. However, in double-observer $\text{Obs}_{\text{Intr}_{IV}}(\overline{\text{Obs}_{\text{Usr}_{IV}}})$, $\mathcal{M}_{\text{Usr}_{IV} \leftarrow \text{Intr}_{IV}}(G_{IV}, ab)$ is wrongly computed as $\{\{3\}, \{4, 5\}\}$.

Next, we use our method to show that G_{IV} is not high-order opaque (with respect to Usr_{IV} , Intr_{IV} , and $T_{IV\text{ spec}}$). The observer $\text{Obs}_{\text{Usr}_{IV}}$ is shown in Figure 25. The concurrent composition $\text{CC}_{\text{Usr}_{IV} \rightarrow \text{Intr}_{IV}}^{G_{IV}, \text{Obs}}$ is shown in Figure 26. The order-2 observer $\text{Obs}_{\text{Usr}_{IV} \leftarrow \text{Intr}_{IV}}(G_{IV})$ is shown in Figure 27. Consider state $\{\{3, \{3\}\}\}$ of $\text{Obs}_{\text{Usr}_{IV} \leftarrow \text{Intr}_{IV}}(G_{IV})$, $(\{3\} \times \{3\}) \cap T_{IV\text{ spec}} = \emptyset$, by Theorem 5.2, G_{IV} is not high-order opaque.

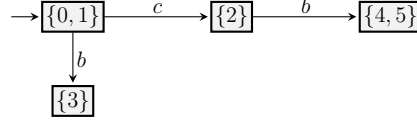

Figure 25: The observer $\text{Obs}_{\text{Usr}_{IV}}$ of automaton G_{IV}^{IV} (shown in Figure 21).

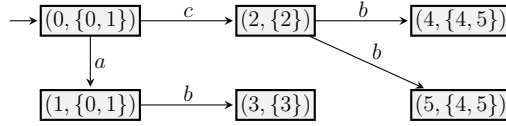

Figure 26: The concurrent composition $\text{CC}_{\text{Usr}_{IV} \rightarrow \text{Intr}_{IV}}^{G_{IV}, \text{Obs}}$.

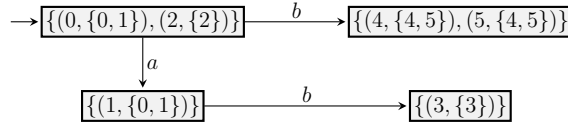

Figure 27: The order-2 observer $\text{Obs}_{\text{Usr}_{IV} \leftarrow \text{Intr}_{IV}}(G_{IV})$.

The next example shows that even when T_{spec} only contains state pairs consisting of the same state, the double-observer and the state-pair-observer still cannot work correctly.

Example 5.12. Reconsider the FSA G_{IV} studied in Example 5.11 (in Figure 21), where $E_{\text{Usr}_{IV}} = \{b, c\}$, $E_{\text{Intr}_{IV}} = \{a, b\}$. Consider $T'_{IV\text{ spec}} = \{\{1, 1\}, \{2, 2\}, \{3, 3\}\}$. In its double-observer $\text{Obs}_{\text{Intr}_{IV}}(\overline{\text{Obs}_{\text{Usr}_{IV}}})$ (in Figure 23), in state $\{\{0, 1\}, \{2\}\}$, $(\{0, 1\} \times \{0, 1\}) \cap T'_{IV\text{ spec}} \neq \emptyset$, in state $\{\{3\}, \{4, 5\}\}$, $(\{3\} \times \{3\}) \cap T'_{IV\text{ spec}} \neq \emptyset$, then by [2, Theorem 1], G_{IV} is high-order opaque with respect to Usr_{IV} , Intr_{IV} , and $T'_{IV\text{ spec}}$.

The state-pair-observer of G_{IV} with respect to Usr_{IV} and Intr_{IV} shown in Figure 24 satisfies that no state has empty intersection with $T'_{IV\text{ spec}}$. Then by [2, Theorem 2], one also has G_{IV} is high-order opaque with respect to Usr_{IV} , Intr_{IV} , and $T'_{IV\text{ spec}}$.

Directly by definition, from $b \in P_{\text{Intr}_{IV}}(L(G_{IV}))$, we have $\mathcal{M}_{\text{Usr}_{IV} \leftarrow \text{Intr}_{IV}}(G_{IV}, b) = \{\{4, 5\}\}$. We have $(\{4, 5\} \times \{4, 5\}) \cap T'_{IV\text{ spec}} = \emptyset$, then G_{IV} is not high-order opaque with respect to Usr_{IV} , Intr_{IV} , and $T'_{IV\text{ spec}}$.

In the order-2 observer $\text{Obs}(\text{CC}_{\text{Usr}_{IV} \rightarrow \text{Intr}_{IV}}^{G_{IV}, \text{Obs}})$ shown in Figure 27, in state $\{(4, \{4, 5\}), (5, \{4, 5\})\}$, $(\{4, 5\} \times \{4, 5\}) \cap T'_{IV\text{ spec}} = \emptyset$. By Theorem 5.2, G_{IV} is not high-order opaque with respect to Usr_{IV} , Intr_{IV} , and $T'_{IV\text{ spec}}$.

It was claimed in [2] that for a deterministic G , when $E_{\text{Usr}} = E$, G is current-state opaque with respect to P_{Intr} and secret state set $Q_S \subset Q$ if and only if G is high-order opaque with respect to Usr , Intr , $T_{\text{spec}} = \{\{q, q\} | q \in Q \setminus Q_S\}$. This is true because in this case, the observer of G_{Usr} is the same as G_{Usr} , and for every $\alpha \in P_{\text{Intr}}(L(G))$, $\mathcal{M}_{\text{Usr} \leftarrow \text{Intr}}(G, \alpha)$ only contains singletons, and $\{q | \{q\} \in \mathcal{M}_{\text{Usr} \leftarrow \text{Intr}}(G, \alpha)\} = \mathcal{M}_{\text{Intr}}(G, \alpha)$. However, this only applies to deterministic automata, because for a nondeterministic G , the observer of G_{Usr} is not necessarily the same as G_{Usr} itself.

Next, we show that even for indistinguishability state pairs, the double-observer method and the state-pair-observer method still do not work correctly. Consider an FSA $G = (Q, E, \delta, Q_0)$, user Usr , and intruder Intr . Consider a set $T_{\text{spec}} \subset \{\{q, q'\} | q, q' \in Q, q \neq q'\}$ of indistinguishability state pairs. Intr aims at being sure whether Usr is confused, i.e., Usr cannot distinguish between the two states of at least one state pair of T_{spec} .

Next, we give a concrete example to illustrate this scenario.

Example 5.13. Consider FSA G_V as in Figure 28, where $E_{\text{Usr}_V} = \{a, b\}$, $E_{\text{Intr}_V} = \{a, c\}$. We choose $T_{V_{\text{spec}}} = \{\{0, 1\}\}$, and study whether intruder Intr_V , with observable event set E_{Intr_V} , can be sure whether user Usr_V , with observable event set E_{Usr_V} , is confused with states 0 and 1. We show that neither the double-observer method nor the state-pair-observer method can do this correctly.

The variant observer $\overline{\text{Obs}}_{\text{Usr}_V}$ is shown in Figure 29. The double-observer $\text{Obs}_{\text{Intr}_V}(\overline{\text{Obs}}_{\text{Usr}_V})$ is shown in Figure 30. State $\{\{0, 1\}, \{0\}\}$ of $\text{Obs}_{\text{Intr}_V}(\overline{\text{Obs}}_{\text{Usr}_V})$ shows that Intr_V cannot be sure whether Usr_V is confused with states 0 and 1. State $\{\{0\}\}$ shows the same.

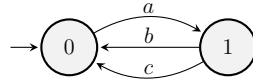

Figure 28: FSA G_V , where $E_{\text{Usr}_V} = \{a, b\}$, $E_{\text{Intr}_V} = \{a, c\}$.

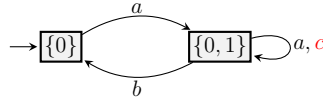

Figure 29: The variant observer $\overline{\text{Obs}}_{\text{Usr}_V}$ of automaton $G_{\text{Usr}_V}^V$.

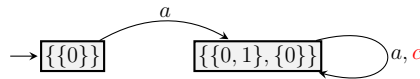

Figure 30: The double-observer $\text{Obs}_{\text{Intr}_V}(\overline{\text{Obs}}_{\text{Usr}_V})$.

The state-pair-observer of G_V with respect to Usr_V and Intr_V is shown in Figure 31 and satisfies that no state only contains state pair $(0, 1)$ and $(1, 0)$. This tells us that Intr_V is not sure whether Usr_V is confused with states 0 and 1.

Directly by definition, from $ac \in P_{\text{Intr}_V}(L(G_V))$, we have $\mathcal{M}_{\text{Usr}_V \leftarrow \text{Intr}_V}(G_V, ac) = \{\{0, 1\}\}$, showing that Intr_V is sure that Usr_V is confused with 0 and 1. Hence neither the above double-observer method nor the state-pair-observer method returns the correct answer.

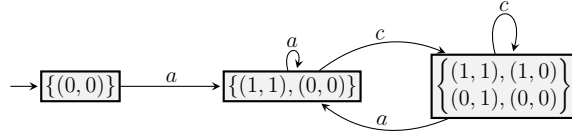

Figure 31: The state-pair-observer of G_V with respect to Usr_V and Intr_V (in Figure 28).

Next, we use our method to study this problem. The observer $\text{Obs}_{\text{Usr}_V}$ is shown in Figure 32. The concurrent composition $\text{CC}_{\text{Usr}_V \rightarrow \text{Intr}_V}^{G_V, \text{Obs}}$ is shown in Figure 33. The order-2 observer $\text{Obs}_{\text{Usr}_V \leftarrow \text{Intr}_V}(G_V)$ is shown in Figure 34. At state $\{(0, \{0, 1\})\}$, Intr_V is sure that Usr_V is confused with 0 and 1.

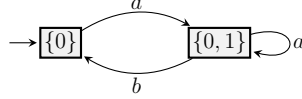

Figure 32: The observer $\text{Obs}_{\text{Usr}_V}$ of automaton $G_{\text{Usr}_V}^V$ (shown in Figure 28).

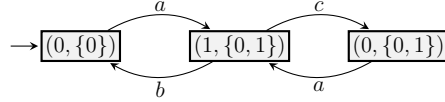

Figure 33: The concurrent composition $\text{CC}_{\text{Usr}_V \rightarrow \text{Intr}_V}^{G_V, \text{Obs}}$.

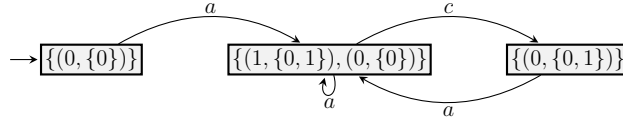

Figure 34: The order-2 observer $\text{Obs}_{\text{Usr}_V \leftarrow \text{Intr}_V}(G_V)$.

5.3.2 Another scenario of high-order opacity

In this subsection, we give a new definition of high-order opacity which was not studied in [2].

The new property is as follows: Consider an FSA $G = (Q, E, \delta, Q_0)$, user Usr and intruder Intr with observable event sets E_{Usr} and E_{Intr} , respectively,

for every run $q_0 \xrightarrow{s} q$ with $q_0 \in Q_0$ and $|\mathcal{M}_{\text{Usr}}(G, P_{\text{Usr}}(s))| = 1$, there exists a run $q'_0 \xrightarrow{t} q'$ with $q'_0 \in Q_0$ such that $P_{\text{Intr}}(t) = P_{\text{Intr}}(s)$ and $\mathcal{M}_{\text{Usr}}(G, P_{\text{Usr}}(t)) \neq \mathcal{M}_{\text{Usr}}(G, P_{\text{Usr}}(s))$. (C)

This property, is equivalent to, order-2 current-state opacity with respect to Usr , Intr , $Q_S^{\text{ord}-2} = \{\{\{q\}\} | q \in Q\}$, and $\psi(Q_S^{\text{ord}-2}) = \bigwedge_{q \in Q} \cdot \not\subseteq \{\{q\}\}$, is also equivalent to, order-2 state-estimation-based property

$$\text{PRED}_2(G, Q_S^{\text{ord}-2}, \psi(Q_S^{\text{ord}-2})) = \{\emptyset \notin Y \subset 2^Q \mid \bigwedge_{q \in Q} Y \not\subseteq \{\{q\}\}\}.$$

In case of (C), whenever the current-state estimate of Usr is a singleton, Intr cannot know what the current-state estimate of Usr exactly is, but sometimes can know that the current-state estimate of

Usr is a singleton. This case can describe the following scenario: Usr wants to communicate with the state of FSA G . To this end, Usr should be able to uniquely determine the current state of G . While Intr wants to forbid the communication between Usr and G and attack the current state of G if Intr knows that Usr can uniquely determine the current state of G and also knows the current state. Case (C) describes when Intr cannot achieve its goal.

By definition, one sees (C) is strictly weaker than (B).

For property (C), [Theorem 5.2](#) provides a 2-EXPTIME verification algorithm, [Theorem 5.9](#) provides an EXPTIME verification algorithm.

6 Formulation of order- n state-estimation-based problems

In this section, we formulate order- n state-estimation-based problems. Consider an FSA G as in (1) and agents A_i with observable event sets $E_i \subset E$, $i \in \llbracket 1, n \rrbracket$. Assume all agents know the structure of G . Assume A_i knows E_{k_i} but cannot observe events of $E_{k_i} \setminus E_i$, $2 \leq i \leq n$, $1 \leq k_i < i$. We characterize what A_n knows about what A_{n-1} knows about ... what A_2 knows about A_1 's state estimate of G .

For state set Q , denote $\text{Pow}(Q) = \text{Pow}_1(Q) = 2^Q$. This is recursively extended as follows: for $n \in \mathbb{Z}_+$, define $\text{Pow}_{n+1}(Q) = \text{Pow}(\text{Pow}_n(Q))$. For example, $\text{Pow}_2(Q) = 2^{2^Q}$.

6.1 The general framework

Denote

$$P_{E_i} =: P_i, \quad \text{Obs}_{P_{E_i}}(G) =: \text{Obs}_i(G), \quad (25a)$$

$$\text{Det}_{P_{E_i}}(G) =: \text{Det}_i(G), \quad \mathcal{M}_{P_{E_i}}(G, \alpha) =: \mathcal{M}_i(G, \alpha), \quad (25b)$$

for short, $i \in \llbracket 1, n \rrbracket$.

Given a label sequence $\alpha \in P_n(L(G))$ observed by agent A_n , the consistent event sequence can be any $s_{n-1} \in P_n^{-1}(\alpha) \cap L(G)$, and the label sequence observed by agent A_{n-1} can be any $P_{n-1}(s_{n-1})$; the consistent event sequence can be any $s_{n-2} \in P_{n-2}^{-1}(P_{n-1}(s_{n-1})) \cap L(G)$, and the label sequence observed by agent A_{n-2} can be any $P_{n-2}(s_{n-2})$; ...; the consistent event sequence can be any $s_1 \in P_1^{-1}(P_2(s_2)) \cap L(G)$, and the label sequence observed by agent A_1 can be any $P_1(s_1)$, and the current-state estimate of A_1 can be any $\mathcal{M}_1(G, P_1(s_1))$. See [Figure 35](#) as an illustration. Based on the label sequence $\alpha \in P_n(L(G))$ observed by agent A_n , the order- n current-state estimate of G is formulated as

$$\begin{aligned} \mathcal{M}_{A_1 \leftarrow A_2 \leftarrow \dots \leftarrow A_n}(G, \alpha) &:= \overbrace{\{\dots \{\mathcal{M}_1(G, P_1(s_1)) \mid s_1 \in P_1^{-1}(P_2(s_2)) \cap L(G)\} \dots} \\ &\quad \dots \\ &\quad s_{n-2} \in P_{n-2}^{-1}(P_{n-1}(s_{n-1})) \cap L(G)\} \\ &\quad s_{n-1} \in P_n^{-1}(\alpha) \cap L(G)\} \\ &\subset \text{Pow}_{n-1}(Q). \end{aligned} \quad (26)$$

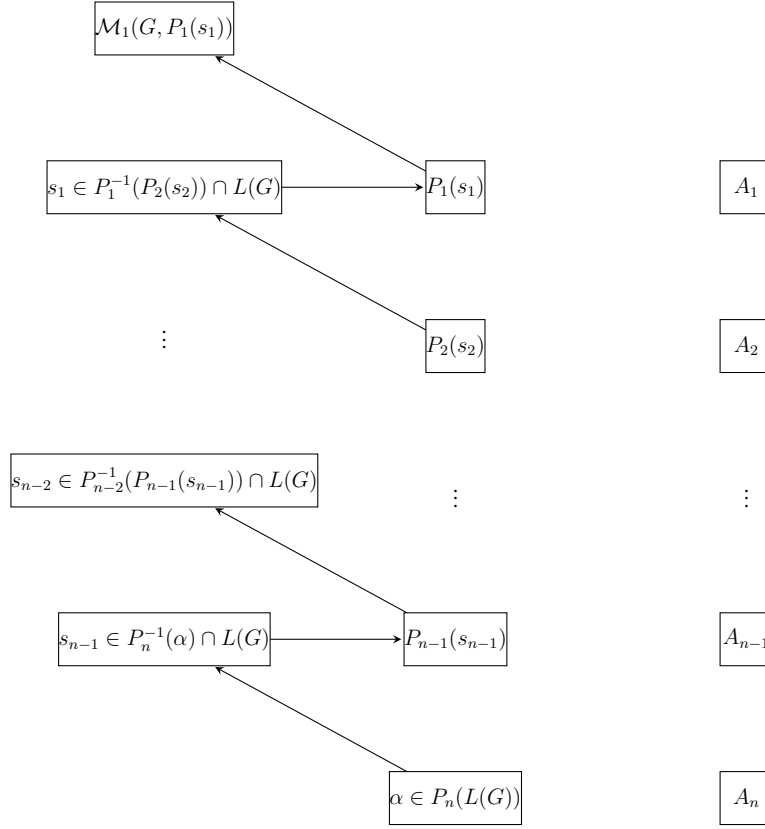

Figure 35: Illustration of order- n current-state estimate $\mathcal{M}_{A_1 \leftarrow A_2 \leftarrow \dots \leftarrow A_n}(G, \alpha)$ of G with respect to $\alpha \in P_n(L(G))$.

Then (14) is the order-2 current-state estimate of G with respect to $\alpha \in P_2(L(G))$. Similarly, the order-3 current-state estimate of G with respect to $\alpha \in P_3(L(G))$ is

$$\begin{aligned} \mathcal{M}_{A_1 \leftarrow A_2 \leftarrow A_3}(G, \alpha) &= \{ \{ \mathcal{M}_1(G, P_1(s_1)) \mid s_1 \in P_1^{-1}(P_2(s_2)) \cap L(G) \} \mid \\ &\quad s_2 \in P_3^{-1}(\alpha) \cap L(G) \} \\ &\subset 2^{2^Q}. \end{aligned} \quad (27)$$

Define predicate of order- n as

$$\text{PRED}_n \subset \text{Pow}_n(Q). \quad (28)$$

Then an order- n state-estimation-based property is defined as follows.

Definition 16 An FSA G satisfies the order- n state-estimation-based property PRED_n (28) with respect to agents A_1, \dots, A_n if

$$\{ \mathcal{M}_{A_1 \leftarrow A_2 \leftarrow \dots \leftarrow A_n}(G, \alpha) \mid \alpha \in P_n(L(G)) \} \subset \text{PRED}_n. \quad (29)$$

The next is to define a notion of *order- n observer* to verify Definition 16. Apparently, the classical observer Obs_{A_1} as in Definition 3 is the order-1 observer, $\text{Obs}(\text{CC}_{A_1 \rightarrow A_2}^{G, \text{Obs}})$ as in Definition 14, which is the observer of concurrent composition $\text{CC}_{A_1 \rightarrow A_2}^{G, \text{Obs}}$, is the order-2 observer.

The following sequence of concurrent compositions provide foundation for the order- n observer to be defined.

- (1) Define $CC_{A_1 \rightarrow A_2}^{G, \text{Obs}}$ as before.
- (2) Compute concurrent composition $CC(G_{A_2}, \text{Obs}(CC_{A_1 \rightarrow A_2}^{G, \text{Obs}}))$, replace each event (e_1, e_2) by e_1 , replace the labeling function of $CC(G_{A_2}, \text{Obs}(CC_{A_1 \rightarrow A_2}^{G, \text{Obs}}))$ by P_3 , and denote the modification of $CC(G_{A_2}, \text{Obs}(CC_{A_1 \rightarrow A_2}^{G, \text{Obs}}))$ by $CC_{A_1 \rightarrow A_2 \rightarrow A_3}^{G, \text{Obs}(G, \text{Obs})}$.
- ⋮
- (n-1) Compute concurrent composition $CC(G_{A_{n-1}}, \text{Obs}(CC_{A_1 \rightarrow A_2 \rightarrow \dots \rightarrow A_{n-2} \rightarrow A_{n-1}}^{G, \text{Obs}(G, \text{Obs}(\dots(G, \text{Obs}) \dots)})))$, replace each event (e_1, e_2) by e_1 , replace the labeling function of $CC(G_{A_{n-1}}, \text{Obs}(CC_{A_1 \rightarrow A_2 \rightarrow \dots \rightarrow A_{n-2} \rightarrow A_{n-1}}^{G, \text{Obs}(G, \text{Obs}(\dots(G, \text{Obs}) \dots)})))$ by P_n , and denote the modification of $CC(G_{A_{n-1}}, \text{Obs}(CC_{A_1 \rightarrow A_2 \rightarrow \dots \rightarrow A_{n-2} \rightarrow A_{n-1}}^{G, \text{Obs}(G, \text{Obs}(\dots(G, \text{Obs}) \dots)})))$ by $CC_{A_1 \rightarrow A_2 \rightarrow \dots \rightarrow A_{n-1} \rightarrow A_n}^{G, \text{Obs}(G, \text{Obs}(\dots(G, \text{Obs}) \dots))}$.
- ⋮

Then define the order- n observer as follows.

Definition 17 Consider an FSA G as in (1) and agents A_i with observable event sets $E_i \subset E$, $i \in \llbracket 1, n \rrbracket$. The order-1 observer is defined as Obs_{A_1} . For each $n > 1$, the order- n observer

$\text{Obs}_{A_1 \leftarrow A_2 \leftarrow \dots \leftarrow A_n}(G)$ is defined as $\text{Obs}(CC_{A_1 \rightarrow A_2 \rightarrow \dots \rightarrow A_{n-1} \rightarrow A_n}^{G, \text{Obs}(G, \text{Obs}(\dots(G, \text{Obs}) \dots))})$.

The order- n observer $\text{Obs}_{A_1 \leftarrow A_2 \leftarrow \dots \leftarrow A_n}(G)$ can be computed in n -EXPTIME.

Similar to Lemma 5.1, the following result holds and can be proven by mathematical induction easily.

Lemma 6.1. Consider an FSA G as in (1), agents A_i with observable event sets $E_i \subset E$, $i \in \llbracket 1, n \rrbracket$, and the order- n observer $\text{Obs}_{A_1 \leftarrow A_2 \leftarrow \dots \leftarrow A_n}(G)$.

(i) $L(G) = L(CC(G_{A_n}, \text{Obs}_{A_1 \leftarrow A_2 \leftarrow \dots \leftarrow A_n}(G)))$.

(ii) For every $\alpha \in P_n(L(G))$ and every run $\mathcal{X}_0 \xrightarrow{\alpha} \mathcal{X}$ of order- n observer $\text{Obs}_{A_1 \leftarrow A_2 \leftarrow \dots \leftarrow A_n}(G)$, where \mathcal{X}_0 is the initial state, for \mathcal{X} , replace each ordered pair $(\#, \$)$ by $\$$, where $\#$ is some state of G , denote the most updated \mathcal{X} by $\bar{\mathcal{X}}$, then $\bar{\mathcal{X}} = \mathcal{M}_{A_1 \leftarrow A_2 \leftarrow \dots \leftarrow A_n}(G, \alpha) \in \text{Pow}_n(Q)$.

Similar to Theorem 5.2, the following Theorem 6.2 holds.

Theorem 6.2 An FSA G satisfies the order- n state-estimation-based property PRED_n (28) with respect to agents A_1, \dots, A_n , if and only if, for every reachable state \mathcal{X} of the order- n observer $\text{Obs}_{A_1 \leftarrow A_2 \leftarrow \dots \leftarrow A_n}(G)$, $\bar{\mathcal{X}} \in \text{PRED}_n$, where $\bar{\mathcal{X}}$ is as in Lemma 6.1.

Theorem 6.2 provides an n -EXPTIME algorithm for verifying Definition 16.

6.2 Special cases

Similar to subsection 5.2, in this subsection, we give special cases for which the complexity of verifying the order- n state-estimation-based property can be reduced a lot. To this end, we define level- i

elements of PRED_n (28). The level-1 elements of PRED_n are defined as elements of PRED_n , the level-2 elements of PRED_n are defined as elements of level-1 elements of PRED_n , ..., the level- $(i + 1)$ elements of PRED_n are defined as elements of level- i elements of PRED_n , ..., the level- n elements of PRED_n are defined as elements of level- $(n - 1)$ elements of PRED_n . Then by definition, each level- i element of PRED_n is a subset of $\text{Pow}_{n-i}(Q)$, $i \in \llbracket 1, n \rrbracket$. Particularly, each level- n element of PRED_n is a subset of Q .

6.2.1 Special case 1

Reconsider T_{Det} as in (18). By this T_{Det} , we define a special type

$$\text{PRED}_{nT_{\text{Det}}} \subset \text{Pow}_n(Q) \quad (30)$$

of predicates, where each level- $(n - 1)$ element Y of $\text{PRED}_{nT_{\text{Det}}}$ satisfies $\emptyset \notin Y$ and there is $X \in Y$ and $X' \in T_{\text{Det}}$ such that $X' \subset X$.

Change the order- n observer $\text{Obs}(\text{CC}_{A_1 \rightarrow A_2 \rightarrow \dots \rightarrow A_{n-1} \rightarrow A_n}^{G, \text{Obs}(G, \text{Obs}(\dots(G, \text{Obs})\dots))})$ to $\text{Obs}(\text{CC}_{A_1 \rightarrow A_2 \rightarrow \dots \rightarrow A_{n-1} \rightarrow A_n}^{G, \text{Obs}(G, \text{Obs}(\dots(G, \text{Det})\dots))})$, that is, replace the concurrent composition $\text{CC}_{A_1 \rightarrow A_2}^{G, \text{Obs}}$ in (1) by $\text{CC}_{A_1 \rightarrow A_2}^{G, \text{Det}}$, and keep the remaining steps in computing the order- n observer the same.

The variant order- n observer $\text{Obs}(\text{CC}_{A_1 \rightarrow A_2 \rightarrow \dots \rightarrow A_{n-1} \rightarrow A_n}^{G, \text{Obs}(G, \text{Obs}(\dots(G, \text{Det})\dots))})$ can be computed in $(n - 1)$ -EXPTIME.

Similar to Theorem 5.9, the following result holds.

Theorem 6.3 *An FSA G satisfies the order- n state-estimation-based property $\text{PRED}_{nT_{\text{Det}}}$ (30) with respect to agents A_1, \dots, A_n if and only if in every reachable state \mathcal{X} of $\text{Obs}(\text{CC}_{A_1 \rightarrow A_2 \rightarrow \dots \rightarrow A_{n-1} \rightarrow A_n}^{G, \text{Obs}(G, \text{Obs}(\dots(G, \text{Det})\dots))})$, replace each ordered pair $(\#, \$)$ by $\$,$ where $\#$ is some state of G , denote the most updated \mathcal{X} by $\bar{\mathcal{X}}$, $\bar{\mathcal{X}}$ belongs to $\text{PRED}_{nT_{\text{Det}}}$.*

Theorem 6.3 provides an $(n - 1)$ -EXPTIME algorithm for verifying the order- n state-estimation-based property $\text{PRED}_{nT_{\text{Det}}}$ (30).

6.2.2 Special case 2

Assume for each $i \in \llbracket 1, n - 1 \rrbracket$, either $E_i \subset E_{i+1}$ or $E_{i+1} \subset E_i$.

As mentioned before, the order-1 observer Obs_{A_1} can be computed in exponential time. By Theorem 5.4 and Theorem 5.6, the order-2 observer $\text{Obs}_{A_1 \leftarrow A_2}(G)$ can be computed in time polynomial in the size of Obs_{A_1} , furthermore, the order-3 observer $\text{Obs}_{A_1 \leftarrow A_2 \leftarrow A_3}(G)$ can be computed in time polynomial in the size of $\text{Obs}_{A_1 \leftarrow A_2}(G)$, ..., finally, the order- n observer $\text{Obs}_{A_1 \leftarrow A_2 \leftarrow \dots \leftarrow A_n}(G)$ can be computed in time polynomial in the size of the order- $(n - 1)$ observer $\text{Obs}_{A_1 \leftarrow A_2 \leftarrow \dots \leftarrow A_{n-1}}(G)$. As a summary, the order- n observer can be computed in exponential time.

Theorem 6.4 *Assume for each $i \in \llbracket 1, n - 1 \rrbracket$, either $E_i \subset E_{i+1}$ or $E_{i+1} \subset E_i$. Then the order- n observer $\text{Obs}_{A_1 \leftarrow A_2 \leftarrow \dots \leftarrow A_n}(G)$ can be computed in exponential time, resulting in whether an FSA G satisfies the order- n state-estimation-based property PRED_n (28) with respect to agents A_1, \dots, A_n can also be verified in exponential time.*

6.3 Case study 1: Order-3 current-state opacity

In this subsection, we study a special case of the order-3 state-estimation-based property — *order-3 current-state opacity*. Recall that the order-2 current-state opacity studied in [subsection 5.3](#) can be used to describe a scenario “You don’t know what I know” [2]. This is particularly useful when a user Usr wants to operate on a system but an intruder Intr wants to attack the system if Intr knows that Usr can uniquely determine the current state of the system. If Intr cannot know that, then the system is considered to be sufficiently safe and then Usr will operate on the system. However, actually the order-2 current-state opacity did not give a complete characterization for this scenario, because it has not been guaranteed that Usr knows Intr really does not know if Usr can uniquely determine the current state. In order to describe this scenario, the order-3 current-state opacity is necessary: Usr wants to be sure that Intr cannot be sure whether Usr can uniquely determine the current state — roughly speaking, “I know you don’t know what I know”.

Definition 18 Consider an FSA G as in (1), user Usr and intruder Intr with observable event sets $E_{\text{Usr}} \subset E$ and $E_{\text{Intr}} \subset E$, respectively. G satisfies the order-3 current-state opacity with respect to Usr , Intr , and Usr if for all $\alpha \in P_{\text{Usr}}(L(G))$, for all $Y \in \mathcal{M}_{\text{Usr} \leftarrow \text{Intr} \leftarrow \text{Usr}}(G, \alpha) \subset 2^{2^Q}$, $Y \not\subseteq \{\{q\} | q \in Q\}$.

Note that [Definition 18](#) is a special case of [Definition 16](#), hence we implicitly assume that Usr knows E_{Intr} and Intr knows E_{Usr} . Note also that [Definition 18](#) is a special case of $\text{PRED}_{3T_{\text{Det}}}$ as in (30), hence can be verified in 2-EXPTIME by [Theorem 6.3](#).

Example 6.5. Reconsider FSA G_{IV} as in [Figure 21](#) studied in [Example 5.11](#), and two agents Usr_{IV} and Intr_{IV} with their observable event sets $E_{\text{Usr}_{\text{IV}}} = \{b, c\}$ and $E_{\text{Intr}_{\text{IV}}} = \{a, b\}$, respectively. The order-2 observer $\text{Obs}_{\text{Usr}_{\text{IV}} \leftarrow \text{Intr}_{\text{IV}}}(G_{\text{IV}})$ is shown in [Figure 27](#). The concurrent composition $\text{CC}_{\text{Usr}_{\text{IV}} \rightarrow \text{Intr}_{\text{IV}} \rightarrow \text{Usr}_{\text{IV}}}^{G_{\text{IV}}, \text{Obs}(G_{\text{IV}}, \text{Obs})}$ is shown in [Figure 36](#). The order-3 observer $\text{Obs}_{\text{Usr}_{\text{IV}} \leftarrow \text{Intr}_{\text{IV}} \leftarrow \text{Usr}_{\text{IV}}}(G_{\text{IV}}) = \text{Obs}(\text{CC}_{\text{Usr}_{\text{IV}} \rightarrow \text{Intr}_{\text{IV}} \rightarrow \text{Usr}_{\text{IV}}}^{G_{\text{IV}}, \text{Obs}(G_{\text{IV}}, \text{Obs})}) = \text{Obs}(\text{CC}_{\text{Usr}_{\text{IV}} \rightarrow \text{Intr}_{\text{IV}} \rightarrow \text{Usr}_{\text{IV}}}^{G_{\text{IV}}, \text{Obs}(G_{\text{IV}}, \text{Det})})$ is shown in [Figure 37](#). [Figure 38](#) is obtained from [Figure 37](#) by replacing each ordered pair $(\#, \$)$ by $\$,$ where $\#$ is some state of G as in [Theorem 6.3](#).

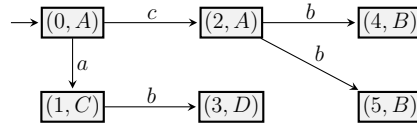

Figure 36: The concurrent composition $\text{CC}_{\text{Usr}_{\text{IV}} \rightarrow \text{Intr}_{\text{IV}} \rightarrow \text{Usr}_{\text{IV}}}^{G_{\text{IV}}, \text{Obs}(G_{\text{IV}}, \text{Obs})}$, where G_{IV} is in [Figure 21](#), $A = \{(0, \{0, 1\}), (2, \{2\})\}$, $B = \{(4, \{4, 5\}), (5, \{4, 5\})\}$, $C = \{(1, \{0, 1\})\}$, $D = \{(3, \{3\})\}$.

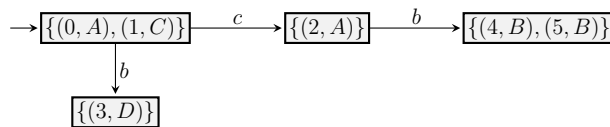

Figure 37: Order-3 observer $\text{Obs}_{\text{Usr}_{\text{IV}} \leftarrow \text{Intr}_{\text{IV}} \leftarrow \text{Usr}_{\text{IV}}}(G_{\text{IV}})$.

By $\text{Obs}_{\text{Usr}_{\text{IV}} \leftarrow \text{Intr}_{\text{IV}} \leftarrow \text{Usr}_{\text{IV}}}(G_{\text{IV}})$ (in [Figure 37](#)) and [Figure 38](#) we have

$$\mathcal{M}_{\text{Usr}_{\text{IV}} \leftarrow \text{Intr}_{\text{IV}} \leftarrow \text{Usr}_{\text{IV}}}(G_{\text{IV}}, \epsilon) = \{\{\{0, 1\}, \{2\}\}, \{\{0, 1\}\}\}, \quad (31a)$$

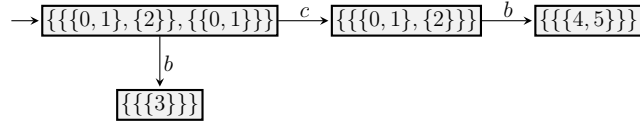

Figure 38: Obtained from order-3 observer $\text{Obs}_{\text{Usr}_{\text{IV}} \leftarrow \text{Intr}_{\text{IV}} \leftarrow \text{Usr}_{\text{IV}}}(G_{\text{IV}})$ by changing each state \mathcal{X} to $\bar{\mathcal{X}}$ as in [Theorem 6.3](#).

$$\mathcal{M}_{\text{Usr}_{\text{IV}} \leftarrow \text{Intr}_{\text{IV}} \leftarrow \text{Usr}_{\text{IV}}}(G_{\text{IV}}, c) = \{\{\{0, 1\}, \{2\}\}\}, \quad (31b)$$

$$\mathcal{M}_{\text{Usr}_{\text{IV}} \leftarrow \text{Intr}_{\text{IV}} \leftarrow \text{Usr}_{\text{IV}}}(G_{\text{IV}}, cb) = \{\{\{4, 5\}\}\}, \quad (31c)$$

$$\mathcal{M}_{\text{Usr}_{\text{IV}} \leftarrow \text{Intr}_{\text{IV}} \leftarrow \text{Usr}_{\text{IV}}}(G_{\text{IV}}, b) = \{\{\{3\}\}\}. \quad (31d)$$

Recall the observer $\text{Obs}_{\text{Usr}_{\text{IV}}}$ of automaton $G_{\text{Usr}_{\text{IV}}}^{\text{IV}}$ shown in [Figure 25](#). With respect to label sequence ϵ , Usr_{IV} 's current-state estimate $\mathcal{M}_{\text{Usr}_{\text{IV}}}(G_{\text{IV}}, \epsilon)$ is equal to $\{0, 1\}$. By (31a), Usr_{IV} knows that Intr_{IV} 's inference of $\mathcal{M}_{\text{Usr}_{\text{IV}}}(G_{\text{IV}}, \epsilon)$ is either $\{\{0, 1\}, \{2\}\}$ or $\{\{0, 1\}\}$. (31a) is computed as follows: When Usr_{IV} observes nothing, the only possible traces are ϵ and a , then Intr_{IV} observes nothing or a . By the order-2 observer $\text{Obs}_{\text{Usr}_{\text{IV}} \leftarrow \text{Intr}_{\text{IV}}}(G_{\text{IV}})$ (shown in [Figure 27](#)), when observing nothing, Intr_{IV} 's inference of $\mathcal{M}_{\text{Usr}_{\text{IV}}}(G_{\text{IV}}, \epsilon)$ is either $\{0, 1\}$ or $\{2\}$; when observing a , Intr_{IV} 's inference of $\mathcal{M}_{\text{Usr}_{\text{IV}}}(G_{\text{IV}}, \epsilon)$ is $\{0, 1\}$.

Also by $\text{Obs}_{\text{Usr}_{\text{IV}}}$, $\mathcal{M}_{\text{Usr}_{\text{IV}}}(G_{\text{IV}}, b) = \{3\}$, that is, by observing b , Usr_{IV} uniquely determines the current state of G_{IV} . Then by the order-3 observer and (31d), Usr_{IV} knows that Intr_{IV} exactly knows $\mathcal{M}_{\text{Usr}_{\text{IV}}}(G_{\text{IV}}, b)$. Hence system G_{IV} is not sufficiently safe for Usr_{IV} to operate on.

7 Conclusion

Given a discrete-event system publicly known to a finite ordered set of agents A_1, \dots, A_n , assuming that each agent has its own observable event set of the system and knows all its preceding agents' observable events, a notion of high-order observer was formulated to characterize what agent A_n knows about what A_{n-1} knows about ... what A_2 knows about A_1 's state estimate of the system. Based on the high-order observer, the state-based properties studied in discrete-event systems have been extended to their high-order versions. Based on the high-order observer, a lot of further extensions can be done. For example, in the current paper, only current-state-based properties were considered, further extensions include for example initial-state versions, infinite-step versions, etc. More importantly, based on the high-order observer, a framework of networked discrete-event systems can be built in which an agent can infer its upstream agents' state estimates, so that all agents can finish a common task based on the network structure and the agents' inferences to their upstream agents' state estimates.

References

- [1] F. Cassez, J. Dubreil, and H. Marchand. Dynamic observers for the synthesis of opaque systems. In *Automated Technology for Verification and Analysis*, pages 352–367, Berlin, Heidelberg,

2009. Springer Berlin Heidelberg.

- [2] B. Cui, X. Yin, S. Li, and A. Giua. You don't know what I know: On notion of high-order opacity in discrete-event systems. *IFAC-PapersOnLine*, 55(28):135–141, 2022. 16th IFAC Workshop on Discrete Event Systems WODES 2022.
- [3] S. Genc and S. Lafortune. Predictability of event occurrences in partially-observed discrete-event systems. *Automatica*, 45(2):301–311, 2009.
- [4] X. Han, K. Zhang, J. Zhang, Z. Li, and Z. Chen. Strong current-state and initial-state opacity of discrete-event systems. *Automatica*, 148:110756(1–8), 2023.
- [5] P. Jančar. Decidability questions for bisimilarity of Petri nets and some related problems. In Patrice Enjalbert, Ernst W. Mayr, and Klaus W. Wagner, editors, *STACS 94*, pages 581–592, Berlin, Heidelberg, 1994. Springer Berlin Heidelberg.
- [6] S. Jiang, Z. Huang, V. Chandra, and R. Kumar. A polynomial algorithm for testing diagnosability of discrete-event systems. *IEEE Transactions on Automatic Control*, 46(8):1318–1321, Aug 2001.
- [7] C. M. Özveren and A. S. Willsky. Observability of discrete event dynamic systems. *IEEE Transactions on Automatic Control*, 35(7):797–806, Jul 1990.
- [8] G. Pola, E. De Santis, M.D. Di Benedetto, and D. Pezzuti. Design of decentralized critical observers for networks of finite state machines: A formal method approach. *Automatica*, 86:174–182, 2017.
- [9] M.O. Rabin and D. Scott. Finite automata and their decision problems. *IBM Journal of Research and Development*, 3(2):114–125, 1959.
- [10] A. Saboori and C.N. Hadjicostis. Notions of security and opacity in discrete event systems. In *2007 46th IEEE Conference on Decision and Control*, pages 5056–5061, Dec 2007.
- [11] S. Shu and F. Lin. Generalized detectability for discrete event systems. *Systems & Control Letters*, 60(5):310–317, 2011.
- [12] S. Shu, F. Lin, and H. Ying. Detectability of discrete event systems. *IEEE Transactions on Automatic Control*, 52(12):2356–2359, Dec 2007.
- [13] T.-S. Yoo and S. Lafortune. Polynomial-time verification of diagnosability of partially observed discrete-event systems. *IEEE Transactions on Automatic Control*, 47(9):1491–1495, Sep. 2002.
- [14] K. Zhang. Removing two fundamental assumptions in verifying strong periodic (D-)detectability of discrete-dvent systems. *IEEE Control Systems Letters*, 7:1518–1523, 2023.
- [15] K. Zhang. A unified concurrent-composition method to state/event inference and concealment in labeled finite-state automata as discrete-event systems. *Annual Reviews in Control*, 56:100902(1–21), 2023.

- [16] K. Zhang and A. Giua. K -delayed strong detectability of discrete-event systems. In *Proceedings of the 58th IEEE Conference on Decision and Control (CDC)*, pages 7647–7652, Dec 2019.
- [17] K. Zhang and A. Giua. On detectability of labeled Petri nets and finite automata. *Discrete Event Dynamic Systems*, 30(3):465–497, 2020.