

Nonlinear Noise Mechanisms in Active Devices: Additive Amplitude Noise and Phase Noise

Meysam Bahmanian

System and Circuit Technology Group, Heinz Nixdorf Institute, Paderborn University, 33102 Paderborn, Germany
(e-mail: meysam.bahmanian@uni-paderborn.de)

Abstract—In this report, we lay the foundation for amplitude noise and phase noise analysis in nonlinear devices. We build a theoretical framework that helps us to analyze extremely difficult problems which include both nonlinearity and noise of semiconductors. Using our proposed framework, we analytically calculate the amplitude noise and phase noise of nonlinear RC circuits in the presence of nonlinear capacitance and conductance. As a more practical example, we analyze the amplitude noise and phase noise of a common-emitter stage bipolar transistor.

Index Terms—noise, phase noise, amplitude noise, AM noise, PM noise, in-phase, quadrature, nonlinear, amplifier

I. INTRODUCTION

Many advanced technological achievements are closely related to our ability to precisely measure time. The application range is wide: from our scientific experiments in a large scale aiming for observing the universe [1] to experiments that look into intermolecular forces [2]. In fundamental research facilities, a sample is exposed to a short pulse of high energy particles, and the particles generated by this interaction are monitored via detectors. The overall accuracy of the experiment depends upon the precision of timing the high energy particles that hit the sample. In engineering field specifically, the effective number of bits (ENOB) of high speed analog-to-digital converters (ADC) and digital-to-analog converters (DAC) has entered a regime that is limited by the jitter of the clock signal [3]. In heterodyne receivers, the phase noise of clock oscillators (which is timing jitter normalized to the carrier period) might get frequency-mixed with a strong interference and entirely mask the desired signal. All these RF systems and subsystems point to the importance of timing precision. [4]

It is well known that both phase noise and amplitude noise are closely related to nonlinear mechanisms in active devices. One of the first notable works in phase noise analysis was done by Walls et al. [5] (also reported in [6]) using perturbation theory, which assumes the noise processes are slow and perturb the amplitude and phase of the nonlinear device. This consequently leads to generation of amplitude and phase noise. This approach was later generalized by Tomlin et al. [7] to a nonlinear system with multiple noise sources. Ferre-Pikal and Savage [8] suggested a more practical approach for amplitude and phase noise estimation. They modeled the gain and phase of a common-emitter stage amplifier as a function of the bias current. Since the flicker noise of bipolar transistor is directly proportional to the base current, the sensitivity of

the amplitude and phase of the response to the base current can be used to estimate the amplitude and phase noise of the transistor. Although this approach provided an accurate estimation, but cannot give an insight about the dynamics of amplitude and phase noise generation in the device, which is necessary for optimizing the design for low phase noise. Boudot and Rubiola [9] tried to relate the phase noise of the amplifier to simple memoryless 2nd order nonlinearity, but in the absence of memory elements (like capacitor), this only leads to amplitude noise. Although this approach can lead to optimization techniques for lower phase noise, but, as we will show in this report, is fundamentally unable to show the origin of phase noise in active devices. Ferre-Pikal [10] used an active feedback technique that senses the noise at the collector of the transistor and feeds a fraction of the the sensed current back to the base to reduce the phase noise. The results show an improvement in the phase noise by approximately 10 dB, however, the mechanism that leads to phase noise is not analyzed. Unfortunately, due to complexity of this problem, phase noise in active devices, which deals with both nonlinearity and random processes, there are not many analytical works in the literature.

In this paper, we demonstrate that amplitude and phase noise are closely related to second-order nonlinearities of the devices. We propose a systematic approach for amplitude/phase noise analysis to incorporate the nonlinear coefficients responsible for amplitude/phase noise generation. We then analyze the response of several simple nonlinear elements in presence of noise. We adapt this approach to nonlinear circuits that do not have a closed-form response, but rather, only a nonlinear governing differential equation of the circuit is available which does not have a closed-form response. It is shown that, with some reasonable approximations, such nonlinear equations can be reduced to a set of coupled homogeneous differential equations which have an analytic solution. Although the analysis is complex, the results are simple and easy to understand. This approach can then be adapted for amplitude/phase noise analysis of a wide range of nonlinear circuits.

This paper is organized as follows: in section II we provide basic mathematical model for phase noise and amplitude noise. In section III we extend the linear model of an active device to include its additive phase noise and amplitude noise. We then calculate the amplitude/phase noise of simple nonlinear elements. In section IV we analyze three nonlinear RC-circuits that are closely related to practical applications and find the expressions for their amplitude and phase noise. As a practical

example, in Section V, we apply the results from our analysis to a common-emitter stage bipolar transistor and the analytical results are compared with the simulation results.

II. PHASE NOISE AND AMPLITUDE NOISE

In this section we look at the mathematical model of phase noise and amplitude noise. This mathematical model is the basis of our analysis of additive amplitude and phase noise in nonlinear devices.

Phase noise (or PM noise) is defined as the random variations of the phase of a sinusoidal signal $x(t)$ as

$$x(t) = X_1 \cos(\omega_0 t + \phi_n(t)), \quad (1)$$

where X_1 is the amplitude, ω_0 is the angular frequency, ϕ_0 is the offset phase and $\phi_n(t)$ is phase noise.

Like any other random process, it is meaningful to talk about the statistical properties of phase noise rather than its instantaneous value. Assuming phase noise is ergodic (that its temporal averages are equal to ensemble averages), the autocorrelation function of the phase noise can be written as

$$R_{\phi_n}(\tau) = \mathbb{E}[\phi_n(t)\phi_n(t + \tau)], \quad (2)$$

where $\mathbb{E}[\cdot]$ denotes the expectation value. The power spectral density of the phase noise according to Wiener–Khinchin theorem is the Fourier transform of its autocorrelation function

$$S_{\phi_n}(f) = \int_{-\infty}^{+\infty} d\tau R_{\phi_n}(\tau) e^{-j2\pi f\tau}. \quad (3)$$

The PSD of phase noise has units of Rad^2/Hz . In the literature, usually what is referred to as phase noise is the power spectral density of the phase noise.

Phase noise can also be described as a noise term modulated by a term that has 90-degree phase difference relative to the carrier, the so-called quadrature carrier. This can be shown by expansion of the sinusoidal term in (1) and assuming the variance of phase noise is small, $|\phi_n(t)| \ll \pi/2$, as

$$x(t) \approx X_1 \cos(\omega_0 t) - X_1 \phi_n(t) \sin(\omega_0 t), \quad (4)$$

where we approximated $\cos(\phi_n(t)) \approx 1$ and $\sin(\phi_n(t)) \approx \phi_n(t)$. Therefore, the carrier quadrature component carries the information about the phase noise.

Amplitude noise (or AM noise) of a signal is random variations of its amplitude with respect to time. In a similar fashion the phase noise was included in a noiseless tone, the amplitude noise can also be added to a sinusoidal signal as

$$x(t) = X_1(1 + a_n(t)) \cos(\omega_0 t), \quad (5)$$

where $a_n(t)$ is the amplitude noise. In contrast to phase noise that manifests itself as a noise term modulated by the quadrature carrier, amplitude noise is modulated by the carrier itself. Similar to what has been done for the phase noise, the autocorrelation function and the PSD of the amplitude noise can be derived

$$R_{a_n}(\tau) = \mathbb{E}[a_n(t)a_n(t + \tau)], \quad (6)$$

and

$$S_{a_n}(f) = \int_{-\infty}^{+\infty} d\tau R_{a_n}(\tau) e^{-j2\pi f\tau}. \quad (7)$$

Now let's consider a general signal that has both in phase and quadrature noise components

$$x(t) = X_1 \cos(\omega_0 t) + n_{\mathbf{I}}(t) \cos(\omega_0 t) + n_{\mathbf{Q}}(t) \sin(\omega_0 t), \quad (8)$$

where $n_{\mathbf{I}}(t)$ and $n_{\mathbf{Q}}(t)$ represent the in-phase- and quadrature-modulated noise terms, respectively. We want to determine the amplitude noise and phase noise of $x(t)$. Assuming $|n_{\mathbf{I}}(t)| \ll X_1$, (8) can be rewritten as

$$\begin{aligned} x(t) &\approx X_1 \left(1 + \frac{n_{\mathbf{I}}(t)}{X_1}\right) \left(\cos(\omega_0 t) + \frac{n_{\mathbf{Q}}(t)}{X_1} \sin(\omega_0 t)\right) \\ &\approx X_1 \left(1 + \frac{n_{\mathbf{I}}(t)}{X_1}\right) \cos\left(\omega_0 t - \frac{n_{\mathbf{Q}}(t)}{X_1}\right). \end{aligned} \quad (9)$$

Therefore, the ratio of the in-phase noise term to carrier amplitude defines the amplitude noise and the ratio of the quadrature noise term to carrier amplitude defines the phase noise, or mathematically

$$x(t) = X_1(1 + a_n(t)) \cos(\omega_0 t + \phi_n(t)) \quad (10)$$

where

$$a_n(t) = \frac{n_{\mathbf{I}}(t)}{X_1} \quad \text{and} \quad \phi_n(t) = -\frac{n_{\mathbf{Q}}(t)}{X_1}. \quad (11)$$

III. NOISE IN NONLINEAR DEVICES

What is the source of amplitude or phase noise in active devices? We already know that the additive noise at the output of the active devices has both in-phase and quadrature carrier components and can be written as

$$\begin{aligned} x(t) &= X_1 \cos(\omega_0 t) + n(t) \\ &= X_1 \cos(\omega_0 t) + n_{\mathbf{I}}(t) \cos(\omega_0 t) + n_{\mathbf{Q}}(t) \sin(\omega_0 t), \end{aligned} \quad (12)$$

where $n(t)$ is the output noise and $n_{\mathbf{I}}(t)$ & $n_{\mathbf{Q}}(t)$ are its carrier in-phase and quadrature components. These components have similar statistical properties and therefore equal PSDs.

$$S_{n_{\mathbf{I}}}(\omega) = S_{n_{\mathbf{Q}}}(\omega) = \frac{1}{2} S_n(\omega). \quad (13)$$

The in-phase component of the output noise floor then contributes to the amplitude noise and the quadrature component to the phase noise. These are well known linear mechanisms that contribute to the active device amplitude and phase noise. But are there other sources of noise that their contribution is higher than that of the linear mechanism? We know that flicker noise has higher levels than the thermal noise or shot noise at low offset frequencies. The flicker noise can be both in-phase- or quadrature-modulated by the carrier to higher frequencies. These nonlinear processes then contribute to the active-device overall noise which exceeds the output additive noise of the device.

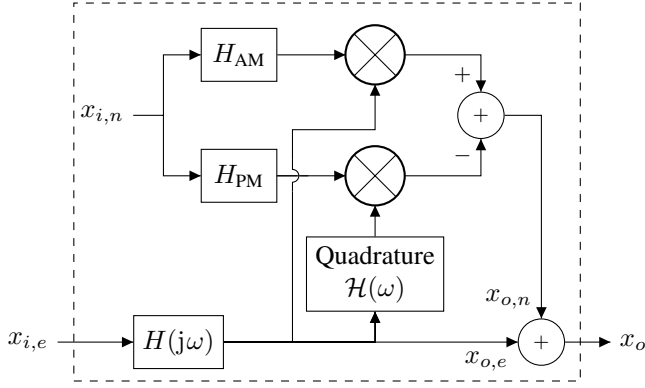

Fig. 1. Model of active device incorporating AM and PM noise mechanisms.

A. Basic definitions

In order to provide a foundation for analysis of nonlinear noise processes in active devices, we use the block diagram shown in Fig. 1. Later on, we will see that the active devices we deal with follow the behavior modeled in this figure. The nonlinear device has two inputs, the *excitation* input $x_{i,e}$ and the *noise* input $x_{i,n}$. (the noise input is inside the device). The block shown as $H(j\omega)$ models the linear part of the system. It gets an input and linearly transforms it with a transfer function of $H(j\omega)$. Let's assume a single tone input of

$$x_{i,e}(t) = X_1 \cos(\omega_0 t), \quad (14)$$

Where A_1 and ω_0 are the amplitude and angular frequency of the excitation. The output of this linear block is

$$x_{o,e}(t) = X_{o,1} \cos(\omega_0 t + \phi_1), \quad (15)$$

where

$$\begin{cases} X_{o,1} = X_1 |H(j\omega)| \\ \phi_1 = \arg(H(j\omega)) \end{cases}. \quad (16)$$

Now let's look at the nonlinear part of the device modeling the AM and PM noise mechanisms. The nonlinear AM part of the device gets a noise input, $x_{i,n}$. This noise input passes through a linear block with a transfer function of H_{AM} and is modulated by the *output* of the linear part of the system, $x_{o,e}$. The nonlinear PM part of the device does something similar. The noise first passes through a linear block, H_{PM} , and then is modulated by the quadrature-transformed output of the $H(j\omega)$. The quadrature signal of $x_{o,e}$ is generated via the Hilbert transform block with a transfer function of

$$\mathcal{H}(\omega) = -j \operatorname{sign}(\omega) = \begin{cases} -j & \text{for } \omega > 0 \\ +j & \text{for } \omega < 0 \end{cases}, \quad (17)$$

where $\mathcal{H}(\omega)$ denotes the Hilbert transform. When the input of this block is an ideal monotone $X_{o,1} \cos(\omega_0 t + \phi_1)$, the output is $X_{o,1} \sin(\omega_0 t + \phi_1)$, without affecting the amplitude of the signal. The output of the nonlinear noisy part of the device, $x_{o,n}(t)$, can therefore be written as

$$x_{o,n}(t) = X_{o,1} [h_{AM}(t) * x_{i,n}(t)] \cos(\omega_0 t + \phi_1) - X_{o,1} [h_{PM}(t) * x_{i,n}(t)] \sin(\omega_0 t + \phi_1) \quad (18)$$

where $*$ denotes convolution and h_{AM} & h_{PM} are the inverse Fourier transform of H_{AM} & H_{PM} , respectively. The lower i , o , e and n indices denote the *input*, *output*, *excitation* and *noise*, respectively. We use this naming convention throughout this paper repeatedly. The AM and PM noise of the output signal can consequently be found using the relation given in (11) as

$$a_n(t) = h_{AM} * x_{i,n}(t) \quad \text{and} \quad \phi_n(t) = h_{PM} * x_{i,n}(t), \quad (19)$$

Our convention to define H_{AM} and H_{PM} significantly simplifies the nonlinear noise analysis. By deriving H_{AM} and H_{PM} and having the PSD of the input noise process, The amplitude and phase noise of the output signal can be found, or mathematically

$$S_{a_n}(\omega) = |H_{AM}|^2 S_{x_{i,n}}(\omega) \quad \text{and} \quad S_{\phi_n}(\omega) = |H_{PM}|^2 S_{x_{i,n}}(\omega). \quad (20)$$

In this paper, we mainly deal with nonlinear behaviors that both H_{AM} and H_{PM} are real numbers and they have negligible variations with respect to frequency. In this type of nonlinear elements we can write

$$a_n(t) = H_{AM} x_{i,n}(t) \quad \text{and} \quad \phi_n(t) = H_{PM} x_{i,n}(t). \quad (21)$$

Now that we have modeled a nonlinear device, we investigate some simple nonlinear elements. We derive H_{AM} and H_{PM} for these elements. Our main objective in this report to derive AM and PM transfer functions. In Section IV we derive these transfer functions for a more complicated nonlinear device.

B. Noise in memoryless nonlinear devices

In this section, we look at the nonlinear behavior of elements whose output is a function of instantaneous value of their inputs. We call this class of devices as memoryless, as their output does not store any information about the input at any time earlier, hence the naming.

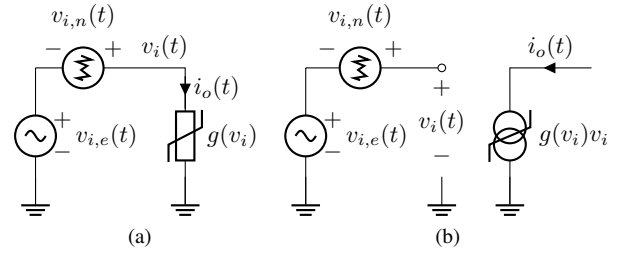

Fig. 2. Sinusoidal stimulation of (a) nonlinear conductance and (b) nonlinear transconductance in presence of noise.

1) *Nonlinear conductance and transconductance*: Let's assume the nonlinear conductance or transconductance illustrated in Fig. 2, whose output current is a function of the instantaneous value of the input voltage

$$i_o = f(v_i) \quad (22)$$

$$i_o = \sum_{k=0}^{\infty} \frac{1}{k!} f^{(k)}(0) v_i^k, \quad (23)$$

where $f^{(k)}(v_i)$ denotes the k 'th derivative of $f(v_i)$. It is well known that coefficients f_k are responsible for k 'th order nonlinearity mechanism. Now let's assume the dc current passing through the conductance and transconductance in the absence of any excitation is zero, $f(0) = 0$, and only consider the first and second order coefficients. We define these terms as

$$g_1 = f'(0), \quad \text{and} \quad g_2 = \frac{1}{2}f''(0). \quad (24)$$

The coefficient g_1 corresponds to a perfectly linear conductance and g_2 is the first nonlinear coefficient and causes the current passing through the element to be proportional to the square of the excitation voltage, causing a second harmonic. Assuming only g_1 and g_2 , the output current passing through the nonlinear conductance can be written as

$$i_o \approx g_1 v_i + g_2 v_i^2. \quad (25)$$

Now we investigate the effect of second order nonlinearity on the output current of the element in presence of input noise. The input voltage of the element, $v_i(t)$, has an excitation part, $v_{i,e}(t)$, and an undesired noise part, $v_{i,n}(t)$, as

$$v_i(t) = v_{i,e}(t) + v_{i,n}(t). \quad (26)$$

We assume a single-tone excitation waveform of

$$v_{i,e}(t) = V_1 \cos(\omega_0 t) \quad (27)$$

where V_1 is the amplitude of the signal and ω_0 is its angular frequency. The device output current can then be written as

$$i_o(t) = g_1 V_1 \cos(\omega_0 t) + g_1 v_{i,n}(t) + g_2 V_1^2 \cos^2(\omega_0 t) + 2g_2 V_1 v_n(t) \cos(\omega_0 t) + g_2 v_n^2(t) \quad (28)$$

Now let's have a look at different terms of (28). The first and second terms are linear transformation of the excitation and noise part of the input to output current, respectively. The 3rd term contains the second harmonic of the signal and a dc terms caused by the second order nonlinearity. The 4th term is the input noise modulated by the input sinusoidal excitation and contributes to amplitude noise. Finally, the 5th term is the noise self modulation term and therefore negligible. Among these terms, we are only interested in the bandpass terms around ω_0 . Throughout this paper, we only focus on nonlinear noise processes and neglect the linear additive noise terms that are well modeled in the reference books [11]. With these assumptions, the output terms around ω_0 can be written as

$$i_o(t) \Big|_{\text{at } \omega_0} = g_1 V_1 \left[1 + 2 \frac{g_2}{g_1} v_n(t) \right] \cos(\omega_0 t) \quad (29)$$

The noise term generated by the nonlinear device is in-phase with the carrier which corresponds to amplitude noise. Therefore, we can write

$$H_{\text{AM}} = 2 \frac{g_2}{g_1}, \quad (30)$$

The AM noise PSD can consequently be found using the basic relations in (20). Equation (29) does not contain any quadrature carrier and shows that a memoryless nonlinear

device is fundamentally unable to generate phase noise. This is independent of degree of approximation in considering the Taylor expansion coefficients in (23). Even if we consider higher order terms $g_k v^k$ (where $g_k = f^{(k)}(0)/k!$) in the Taylor expansion series, these terms cannot generate any quadrature component. For instance, applying the input voltage in (26) gives an output current of

$$g_k v_i^k = g_k \sum_{p=0}^k \binom{k}{p} V_1^p \cos^p(\omega_0 t) v_{i,n}^{k-p}(t). \quad (31)$$

None of the terms in the polynomial expansion of $g_k v_i^k$ can generate a quadrature component since $\sin(\omega_0 t)$ is an odd function and $\cos(\omega_0 t)$ is an even function

$$\int_{-\pi/\omega_0}^{\pi/\omega_0} dt [\cos(\omega_0 t)]^p \sin(\omega_0 t) = 0. \quad (32)$$

It is noteworthy that there are additional signal and noise bandpass terms around ω_0 . For instance the 3rd and 5th order nonlinearity terms generate signal terms that are proportional to $V_1^3 \cos(\omega_0 t)$ and $V_1^5 \cos(\omega_0 t)$ that are responsible for gain compression. Similarly, the 4th and 6th order nonlinearity terms generate AM noise terms that are proportional to $V_1^3 v_{i,n}(t) \cos(\omega_0 t)$ and $V_1^5 v_{i,n}(t) \cos(\omega_0 t)$ that depending on the sign of g_4 and g_6 lead to AM noise compression or expansion. Throughout this paper, we assume moderate excitation levels such that these higher order terms are well below the linear and 2nd order nonlinear terms, or equivalently

$$|g_{2m+1} V_1^{2m+1}| \ll |g_1 V_1|, \quad (33)$$

and for the AM noise terms around ω_0

$$|g_{2m+2} V_1^{2m+1}| \ll |g_2 V_1|, \quad (34)$$

where m is a positive non-zero integer. It is noteworthy that the analysis provided here is also true for any memoryless nonlinear system. This can be a system composed of *only* nonlinear conductances. Both the excitation and the desired output can also be a voltage or a current. If we have an output-input relation of

$$x_o = \alpha_1 x_i + \alpha_2 x_i^2, \quad (35)$$

the AM noise transfer function will be

$$H_{\text{AM}} = 2 \frac{\alpha_2}{\alpha_1}. \quad (36)$$

C. Noise in nonlinear devices with memory

In the previous section, we saw that a nonlinear memoryless element is fundamentally unable to generate PM noise. For phase noise generation, modulation of the baseband noise by the quadrature carrier, rather than in-phase carrier in memoryless element, is necessary. In this section we introduce two simple element that cause quadrature carrier modulation: linear capacitance in parallel with nonlinear conductance, shown in Fig. 3a, and linear conductance in parallel with nonlinear capacitance shown in Fig. 3b. Here we just present the principle of quadrature-carrier noise modulation. Later on in section IV we demonstrate more sophisticated circuits that we face in practice.

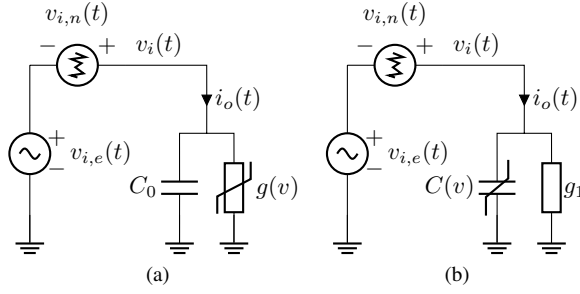

Fig. 3. Sinusoidal stimulation of (a) nonlinear conductance in parallel with capacitance and (b) nonlinear capacitance in parallel with conductance in presence of noise.

1) *Linear capacitance and nonlinear conductance*: Now let's have a look at the simple circuit shown in Fig. 3a composed of a nonlinear conductance and a linear capacitance. The circuit is excited by an external monotone voltage source and a baseband noise is added to the excitation. We look at the behaviors of the current passing through the circuit and find the properties of modulated noise caused by the nonlinearity of the conductance. The conductance has just a 2nd order nonlinearity with the governing equation as $g(v) = g_2 v^2$. The governing equation of the circuit can be written as

$$i_o(t) = C_0 \dot{v}_i(t) + g_2 v_i^2(t), \quad (37)$$

We also used the dot convention for the time derivative operation

$$\dot{v}(t) := \frac{d}{dt} v(t). \quad (38)$$

Assuming the excitation waveform and input noise to be same as (26) and (27), the output current passing through the circuit can be written as

$$i_o(t) = -C_0 \omega_0 V_1 \sin(\omega_0 t) + C_0 \dot{v}_{i,n}(t) + g_2 V_1^2 \cos^2(\omega_0 t) + 2g_2 V_1 v_{i,n}(t) \cos(\omega_0 t) + g_2 v_{i,n}^2(t), \quad (39)$$

Now we look at the bandpass current and the modulated noise terms caused by the nonlinearity.

$$\begin{aligned} i_o(t) \Big|_{\text{at } \omega_0} &= -C_0 \omega_0 V_1 \sin(\omega_0 t) + 2g_2 V_1 v_{i,n}(t) \cos(\omega_0 t) \\ &= C_0 \omega_0 V_1 \cos(\omega_0 t + \pi/2) \\ &\quad + 2g_2 V_1 v_{i,n}(t) \sin(\omega_0 t + \pi/2) \end{aligned} \quad (40)$$

The modulated noise and the signal are in quadrature. Although the noise is, with respect to input, in-phase modulated by the nonlinear conductance, the carrier signal itself is quadrature-transformed by time derivation at the linear capacitance. The PM noise transfer function can be written as

$$H_{\text{PM}} = -\frac{2g_2}{C_0 \omega_0} \quad (41)$$

2) *Linear conductance and nonlinear capacitance*: Another circuit that causes phase noise generation is interaction between a linear conductance and a first order nonlinear capacitance, illustrated in Fig. 3(b). In order to analyze a circuit with nonlinear capacitor, we need to derive its governing

equation first. Let's assume a nonlinear capacitor with a Taylor expansion series of

$$C(v) = \sum_{k=0}^{\infty} \frac{1}{k!} C^{(k)}(0) v_i^k, \quad (42)$$

The current passing through the capacitor terminals can be written as

$$\begin{aligned} i_C &= \frac{dQ}{dt} = \frac{d(C(v) \times v)}{dt} \\ &= [C(v) + C'(v) \times v] \frac{dv}{dt} \end{aligned} \quad (43)$$

Where we used the chain and product derivative rules. Substituting $C(v)$ and its derivative into (42), the governing equation of the capacitor can be written as

$$i_C = \left[\sum_{k=0}^{\infty} \frac{k+1}{k!} C^{(k)}(0) v_i^k \right] \frac{dv}{dt}. \quad (44)$$

Now we define the linear and 2nd-order nonlinear capacitance coefficients as

$$C_0 = C(0) \quad \text{and} \quad C_1 = 2C'(0). \quad (45)$$

The governing equation of the capacitor considering only the linear coefficient and 2nd-order nonlinearity can be written as

$$i_C(t) = (C_0 + C_1 v) \dot{v}(t). \quad (46)$$

Now let's consider the circuit shown in Fig. 3b and assume the capacitance to be purely nonlinear of second order, $C_0 = 0$. The output current of the circuit can then be formulated as

$$i_o(t) = g_1 v + C_1 v_i(t) \dot{v}_i(t). \quad (47)$$

Assuming the excitation waveform and input noise to be same as (26) and (27), the output current passing through the circuit can be written as

$$\begin{aligned} i_o(t) &= g_1 V_1 \cos(\omega_0 t) + g_1 v_{n,i}(t) - C_1 \omega_0 V_1^2 \sin(\omega_0 t) \cos(\omega_0 t) \\ &\quad - C_1 \omega_0 V_1 v_{i,n}(t) \sin(\omega_0 t) + C_1 \omega_0 V_1 \dot{v}_{i,n}(t) \cos(\omega_0 t) \\ &\quad + v_{i,n}(t) \dot{v}_{i,n}(t). \end{aligned} \quad (48)$$

Once again, we only look at the signal and modulated noise terms around ω_0 .

$$\begin{aligned} i_o(t) \Big|_{\text{at } \omega_0} &= g_1 V_1 \cos(\omega_0 t) - C_1 \omega_0 V_1 v_{i,n}(t) \sin(\omega_0 t) \\ &\quad + C_1 \omega_0 V_1 \dot{v}_{i,n}(t) \cos(\omega_0 t). \end{aligned} \quad (49)$$

The first term on the right-hand side of this equation is the desired current that passes through the linear conductance. The second term is the baseband noise modulated by the quadrature carrier and leads to phase noise generation. The last term is the derivative of the baseband noise modulated by the in-phase carrier. It is noteworthy that the derivative of the baseband noise leads to small AM noise power spectral densities at close-in carrier offset frequencies. It is a legitimate concern that this derivative operation leads to a high noise PSD at high frequencies, but in practical circuits a series resistance prevents a purely derivative operation on the input noise. Therefore,

the output current mainly contains PM noise with a transfer function of

$$H_{\text{PM}} = \frac{C_1 \omega_0}{g_1} \quad (50)$$

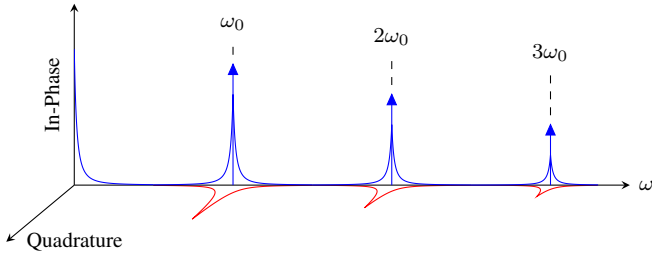

Fig. 4. Output spectrum of a nonlinear circuit showing both in-phase and quadrature noise.

IV. NOISE IN NONLINEAR RC CIRCUITS

So far we have seen how nonlinear conductance leads to AM noise generation and a combination of nonlinearity of conductance and capacitance causes PM noise generation. While these principles are simple and easy to understand, unfortunately, real examples of AM and PM noise require solving more complicated nonlinear differential equations. The nonlinear nature of these circuits causes many harmonics to be generated, illustrated in Fig. 4 as Dirac delta pulse arrows in frequency domain. The harmonics at various nodes of the circuit are also mixed with the baseband noise processes in the circuit. Depending on the nature of the mixing process, as described in the previous section, the generated modulated noise can be in-phase or in quadrature (or both) with a given harmonic. Therefore, the noise has two components, shown in Fig. 4 with two separate axes. These noise side-bands at different frequencies are in balance via the nonlinear governing equation of the circuit. The linear mechanisms, existing in linear resistor, capacitor and inductor, cannot change the frequency of these noise side-bands, but can leak the in-phase component of a noise sideband to the quadrature component at the same frequency or vice versa. The nonlinear components of the circuit, however, change the frequency of a noise sideband. This change in frequency can also be within quadrature or in-phase transformation of the noise sideband. The balance between these noise side-bands are also determined by the governing nonlinear differential equation (or set of equations) of the circuit. This type of differential equations usually does not have a closed-form solution. It could be argued that the only way to find a response is through the use of computer aided design (CAD) tools. The downside of this approach to find the optimum point is that we close our eyes to the dynamics of the system. An alternative approach is to find an approximate solution to these equations that model the behavior of the system parametrically. This approach helps the designer to both understand which parameter to vary and move in the right direction for the optimization.

In this section, we analyze three circuits with nonlinear conductance and capacitance. We show that with some reasonable assumptions their response can be found with very good

precision. Later on, in section V we directly apply the results of this discussion to bipolar transistor and find an expression for the output AM and PM noise.

A. Noise in RC circuit with nonlinear conductance

Let's consider the nonlinear series RC circuit shown in Fig. 5 composed of a linear resistor and a capacitor in parallel with a purely 2nd-order nonlinear conductance. The conductance has just a 2nd order nonlinearity as $g(v) = g_2 v^2$.

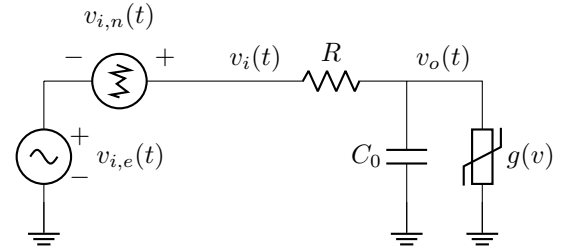

Fig. 5. Nonlinear RC circuit with a nonlinear conductance.

We assume the excitation waveform and input noise to be same as (26) and (27). The governing equation of the circuit can be written as

$$v_o(t) = v_i(t) - RC_0 \dot{v}_o(t) - g_2 R v_o^2(t), \quad (51)$$

Equation (51) has a $g_2 R v_o^2(t)$ term which makes it a nonlinear first order differential equation. In order to find an expression for the output voltage $v_o(t)$, we decompose the response of the circuit to the *excitation* term $v_{o,e}(t)$ and the *noise* $v_{o,n}(t)$ term as

$$v_o(t) = v_{o,e}(t) + v_{o,n}(t). \quad (52)$$

Note that the governing equation of the circuit in (51) is nonlinear and we cannot simply use the superposition principle that is widely used in linear circuits. We expect the noise response $v_{o,n}(t)$ to be dependent upon the excitation voltage. First we assume $v_{i,n}(t) = 0$ and estimate the excitation part of the response. The differential equation in this case can simply be written as

$$v_{o,e}(t) = v_{i,e}(t) - RC_0 \dot{v}_{o,e}(t) - g_2 R v_{o,e}^2(t). \quad (53)$$

The nonlinear nature of this differential equation leads to generation of harmonics of the excitation waveform. Therefore, the steady-state response has a form of

$$v_{o,e}(t) = \sum_{k=0}^{\infty} v_{o,k}(t) = \sum_{k=0}^{\infty} V_{o,k} \cos(k\omega_0 t + \phi_k) \quad (54)$$

where $V_{o,k}$ and ϕ_k are the amplitude and the offset phase of the k 'th harmonic. Now we try to find an approximate solution for the response in presence of single tone stimulation of the circuit. Considering only $k = 0, 1$, and substituting (27) and (54) in (53) and neglecting the second and higher order harmonics, a first order approximation of the response can found as

$$v_{o,e}(t) \Big|_{1\text{st harm.}} \approx V_{o,1} \cos(\omega_0 t + \phi_1), \quad (55)$$

where

$$\begin{cases} H(j\omega) = \frac{1}{1 + jRC_0\omega_0} \\ V_{o,1} = |H(j\omega_0)|V_1 \\ \phi_1 = \arg(H(j\omega_0)) \end{cases} \quad (56)$$

This is indeed the response of the circuit in the absence of any nonlinearity, $g(v) = 0$. A second order approximation considering $k = 0, 1, 2$ can be performed to find the second harmonic. Since $v_{i,e}(t)$ does not contain any harmonics, the term $g_2RV_{o,1}^2 \cos\omega_0 t$ acts as a *source term* for the second harmonic response. This new source term has a dc component and a second harmonic as

$$-g_2R \left[v_{o,e}(t) \Big|_{\text{1st harm.}} \right]^2 = -\frac{1}{2}g_2RV_{o,1}^2 [1 + \cos(2\omega_0 t + 2\phi_1)] \quad (57)$$

Therefore the new output voltage approximation contains a dc term and a second harmonic as

$$\begin{cases} V_{o,0} = -\frac{1}{2}g_2RV_{o,1}^2 \\ V_{o,2} = \frac{1}{2}g_2R|H(j2\omega_0)|V_{o,1}^2 \\ \phi_2 = 2\phi_1 + \arg(H(j2\omega_0)) + \pi \end{cases} \quad (58)$$

In every step to find a better approximate response, new mixing terms appear. These mixing terms caused by nonlinearity are proportional to $g_2RV_{o,1}$. The magnitude of the k 'th harmonic therefore is proportional to $(g_2RV_{o,1})^k$ and higher order terms. The convergence of the response depends upon both the excitation amplitude and its frequency and requires further analysis. For the rest of our analysis we assume moderate excitation levels $|g_2RV_{o,1}| \ll 1$ and approximate the output with its first harmonic given in (55).

Now we derive the governing differential equation of the output noise voltage by substituting (26) and (52) into governing differential equation of the circuit in (51). This gives output noise voltage differential equation as

$$\begin{aligned} v_{o,n}(t) = v_{i,n}(t) - RC_0\dot{v}_{o,n}(t) - 2g_2Rv_{o,e}(t)v_{o,n}(t) \\ - g_2RV_{o,n}^2(t). \end{aligned} \quad (59)$$

The first 2 terms on the right-hand side of (59) are responsible for noise shaping in linear systems. The 3rd term is caused by the nonlinearity of conductance and in-phase-modulates the noise around the carrier. The 4th term is noise self modulation and negligible, as the input and — consequently — output noise voltages are small. There is another effect that is obscure in the 2nd term of (59). Having the output noise in-phase modulated by the nonlinear conductance, the derivative of this AM noise causes PM noise generation. Linear and nonlinear transformation between different noise components are illustrated graphically in Fig. 6

Now we derive different components of the output noise voltage. By neglecting the noise-self-modulation term in (59), the output noise differential equation can be rewritten as

$$v_{o,n}(t) \approx v_{i,n}(t) - RC_0\dot{v}_{o,n}(t) - 2g_2Rv_{o,e}(t)v_{o,n}(t). \quad (60)$$

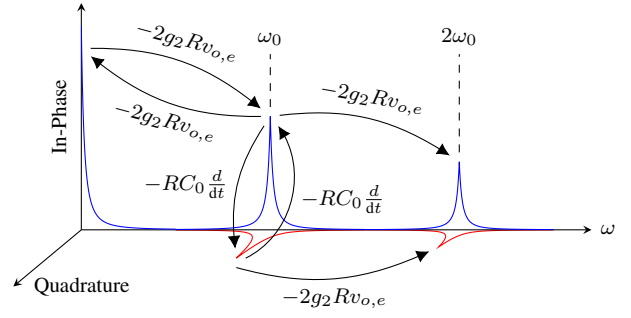

Fig. 6. Formation of noise side-bands in RC circuit with nonlinear conductance.

This equation is linear ordinary differential equation and has an exact solution. However, since $v_{o,n}(t)$ has a time-dependent coefficient, $v_{o,e}(t)$, the general form of the response is complicated. Therefore, we try to estimate its response directly from the (60). The output noise $v_{o,n}(t)$ has both in-phase and quadrature sidebands at the harmonics of the excitation frequency. These terms are tightly coupled via various terms on the right-hand side of (60). The second term $RC_0\dot{v}_{o,n}(t)$ contains time derivative of the noise. This time-derivative does not affect the baseband noise shaping, as the bandwidth of the input noise is in the megahertz range and the linear cut-off frequency of the circuit is in the gigahertz range that is approximately 3 orders of magnitude higher than the input noise frequencies. The time derivative operation, however, couples the in-phase component of noise into the quadrature component and vice versa. The 4th term modulates the baseband noise by the carrier and is the source of AM noise generation in the first place.

Now we estimate different noise components. We neglect the modulated noise around the harmonics and approximate $v_{o,n}(t)$ to have three terms: the baseband noise $v_{n,\mathbf{BB}}(t)$, the modulated in-phase component $v_{n,\mathbf{I}}(t)$, and the modulated quadrature component $v_{n,\mathbf{Q}}(t)$. The output noise can then be formulated as

$$\begin{aligned} v_{o,n}(t) \approx v_{n,\mathbf{BB}}(t) + v_{n,\mathbf{I}}(t) \cos(\omega_0 t + \phi_1) \\ + v_{n,\mathbf{Q}}(t) \sin(\omega_0 t + \phi_1) \end{aligned} \quad (61)$$

Substituting this equation in (60) and neglecting the terms at the second harmonic, the relation between these terms and input noise can be found. The result of this substitution for each term of (60) is shown in Table I. Neglecting the noise terms modulated around the 2nd harmonic, caused by the nonlinearity of the system, we get a set of three *linear and homogeneous* differential equations describing the relation between different noise components: the baseband noise, the in-phase-modulated noise and the quadrature-modulated noise. For the quadrature PM noise we have

$$v_{n,\mathbf{Q}}(t) + RC_0\dot{v}_{n,\mathbf{Q}}(t) = RC_0\omega_0 v_{n,\mathbf{I}}(t). \quad (62)$$

This equation shows that the source of quadrature PM noise in the circuit is the in-phase AM noise. This process has also been explained before, that this happens by the linear time-

TABLE I
DETAILED TERMS IN DECOMPOSITION OF THE OUTPUT NOISE OF RC CIRCUIT WITH NONLINEAR CONDUCTANCE INTO BASEBAND, IN-PHASE AND QUADRATURE COMPONENTS

term in (60)	baseband part	in-phase part	quadrature part
$v_{o,n}(t)$	$v_{n,\mathbf{BB}}(t)$	$v_{n,\mathbf{I}}(t) \cos(\omega_0 t + \phi_1)$	$v_{n,\mathbf{Q}}(t) \sin(\omega_0 t + \phi_1)$
$v_{i,n}(t)$	$v_{i,n}(t)$	–	–
$-RC_0 \dot{v}_{o,n}(t)$	$-RC_0 \dot{v}_{n,\mathbf{BB}}(t)$	$-RC_0 \dot{v}_{n,\mathbf{I}}(t) \cos(\omega_0 t + \phi_1)$ $-RC_0 \omega_0 v_{n,\mathbf{Q}}(t) \cos(\omega_0 t + \phi_1)$	$-RC_0 \dot{v}_{n,\mathbf{Q}}(t) \sin(\omega_0 t + \phi_1)$ $+RC_0 \omega_0 v_{n,\mathbf{I}}(t) \sin(\omega_0 t + \phi_1)$
$-2g_2 R v_{o,e}(t) v_{o,n}(t)$	$-g_2 R V_{o,1} v_{n,\mathbf{I}}(t)$	$-2g_2 R V_{o,1} v_{n,\mathbf{BB}} \cos(\omega_0 t + \phi_1)$	–

derivative operation via the capacitor. For the in-phase AM noise we have

$$v_{n,\mathbf{I}}(t) + RC_0 \dot{v}_{n,\mathbf{I}}(t) = -2g_2 R V_{o,1} v_{n,\mathbf{BB}}(t) - RC_0 \omega_0 v_{n,\mathbf{Q}}(t). \quad (63)$$

The first term in the right-hand side of (63) once again shows the source of AM noise is the nonlinear conductance present in the circuit. The second term in the right-hand side of (63) shows that the PM noise caused by the AM noise in the first place, couples into AM noise by the time derivative operation at the capacitor.

Finally, for the baseband noise we have

$$v_{n,\mathbf{BB}}(t) + RC_0 \dot{v}_{n,\mathbf{BB}}(t) = v_{i,n}(t) - g_2 R V_{o,1} v_{n,\mathbf{I}}(t). \quad (64)$$

The first term on the right hand side of this equation shows the main source of output baseband noise is the input baseband noise. The second term is the AM noise folded back to baseband due to nonlinear conductance. Although this set of equations, (62) to (64), are linear with a closed form analytical solution, we make two additional approximations to simplify the result:

- 1) We assume $g_2 R V_{o,1} \ll 1$ and neglect the folding of the AM noise to baseband.
- 2) We assume the high frequency dynamics of the RC circuit, namely its linear time constant, does not shape the baseband, in-phase-modulated and quadrature-modulated noise. This assumption is equivalent to neglecting all time-derivatives in (62) to (64). Among all our approximations so far, this is the least important one and has almost *no* effect on the solution. For instance, a lowpass filter with a bandwidth of 1 GHz has a close-to-zero effect on the magnitude and phase of a low frequency noise with a maximum frequency of 1 MHz.

With these assumptions, we can write

$$v_{n,\mathbf{BB}}(t) \approx v_{i,n}(t), \quad (65a)$$

$$v_{n,\mathbf{I}}(t) \approx \frac{-2g_2 R}{1 + (RC_0 \omega_0)^2} V_{o,1} v_{i,n}(t), \quad (65b)$$

$$v_{n,\mathbf{Q}}(t) \approx \frac{-2g_2 R^2 C_0 \omega_0}{1 + (RC_0 \omega_0)^2} V_{o,1} v_{i,n}(t) \quad (65c)$$

Although our analysis has been complicated, we ended up with elegant and simple results. As the final step, we write the AM and PM noise transfer functions as

$$H_{\text{AM}} = \frac{-2g_2 R}{1 + (RC_0 \omega_0)^2} \quad \text{and} \quad H_{\text{PM}} = \frac{2g_2 R^2 C_0 \omega_0}{1 + (RC_0 \omega_0)^2}. \quad (66)$$

Fig. 7 shows the simulation results of an RC circuit with nonlinear conductance in comparison with theory. The simulation was performed using Virtuoso analog design environment commercial software from Cadence Design Systems, Inc. At the excitation level of $V_1 = 100 \text{ mV}$, the simulation results have a good matching with theory. As the excitation level increases, higher order harmonics grow and their contribution to AM/PM noise leads to deviation of simulation results from our analysis.

B. Noise in RC circuit with nonlinear capacitance

A well known nonlinear storage element is a nonlinear capacitor. This nonlinearity arises in active devices by the charge dependent length of depletion region in bipolar transistors or dependence of gate-channel capacitance to the gate voltage in MOS devices. In this section, we analyze a simple RC network with a nonlinear capacitance, illustrated in Fig. 8. We assume a second-order nonlinear capacitance as

$$C(v) = C_0 + C_1 v. \quad (67)$$

The governing equation of the circuit in Fig. 8 can be written as

$$v_o(t) = v_i(t) - RC_0 \dot{v}_o(t) - RC_1 v_o(t) \dot{v}_o(t), \quad (68)$$

This equation has a $RC_1 v_o(t) \dot{v}_o(t)$ term which makes it a nonlinear first order differential equation. Once again, this equation does not have an analytical closed form solution and we need to make some approximations to find a reasonable form for the response.

In order to find an expression for the output voltage $v_o(t)$, once again, we divide the response to two parts, the excitation part $v_{o,e}(t)$ and the noise part $v_{o,n}(t)$. First we assume $v_{i,n}(t) = 0$ and find the excitation part of the response. This gives us the differential equation of

$$v_{o,e}(t) = v_{i,e}(t) - RC_0 \dot{v}_{o,e}(t) - RC_1 v_{o,e}(t) \dot{v}_{o,e}(t). \quad (69)$$

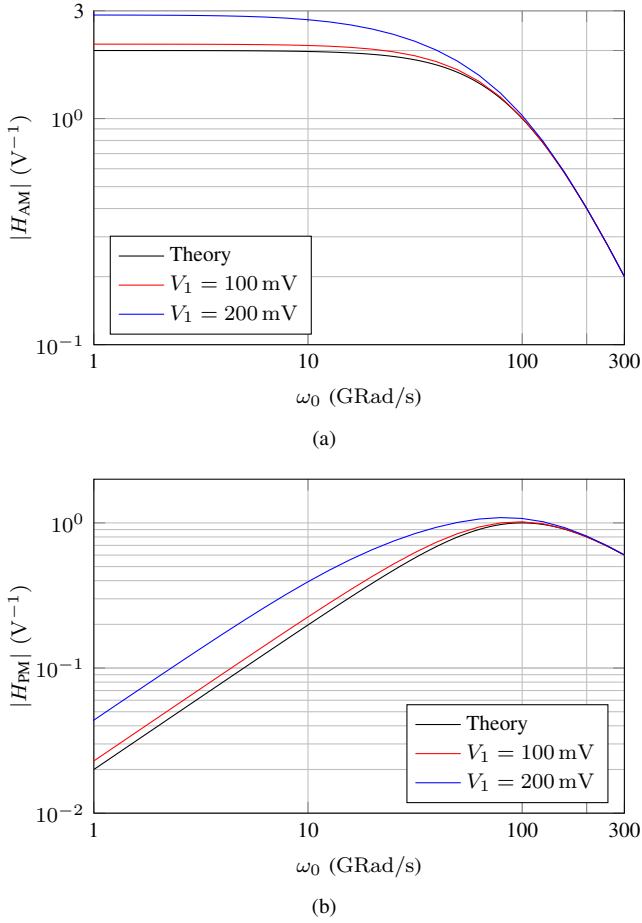

Fig. 7. AM and PM noise transfer functions in RC circuit with nonlinear transconductance; $R = 100 \Omega$, $C_0 = 100$ fF, $g_2 = 10$ mS/V,

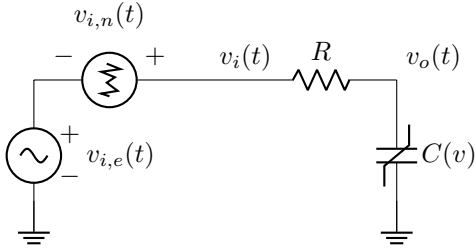

Fig. 8. Nonlinear RC circuit with a nonlinear capacitance.

Once again, the nonlinear nature of this differential equation leads to generation of harmonics of the excitation waveform. Therefore, the steady-state response has the form given in previous section in (54). Considering only $k = 0, 1$, the response has the form of linear RC circuit given (55) and (56). A second order approximation and taking into account $k = 2$ can be performed by substituting the linear response in (55) in the right-hand side of (69). This substitution generates in new *source term* for the second harmonic as

$$-RC_1 \left[v_{o,e}(t) \dot{v}_{o,e}(t) \right]_{\text{1st harm.}} = \frac{1}{2} RC_1 \omega_0 V_{o,1}^2 \sin(2\omega_0 t + 2\phi_1). \quad (70)$$

Therefore, the magnitude and phase of the 2nd harmonic can

be approximated as

$$\begin{cases} V_{o,2} = \frac{1}{2} RC_1 \omega_0 |H(j2\omega_0)| V_{o,1}^2 \\ \phi_2 = 2\phi_1 + \arg(H(j2\omega_0)) - \frac{1}{2}\pi \end{cases}. \quad (71)$$

This process can be done recursively to find the exact form of the steady state solution. Substituting the k th order approximation of the response to the right-hand side of (69) generates new sinusoidal terms that are one order more proportional to $RC_1 V_{o,1} \omega_0$. The harmonics of the output signal are therefore directly proportional to excitation frequency. As the excitation frequency increases, the harmonics, on the one hand, grow stronger because of the term $RC_1 v_{o,e}(t) \dot{v}_{o,e}(t)$ in the governing equation, and on the other hand, are shaped by the linear transfer function of the system. Here we avoid further discussion of convergence criteria and, similar to previous discussion in analysis of RC circuit with nonlinear conductance, assume $RC_1 V_{o,1} \omega_0 \ll 1$ and approximate the response with the first order approximation given (55) and (56).

Now we derive the governing differential equation of the output noise voltage by substituting (27) and (52) into governing differential equation of the circuit in (68).

$$\begin{aligned} v_{o,n}(t) = & v_{i,n}(t) - RC_0 \dot{v}_{o,n}(t) - RC_1 v_{o,e}(t) \dot{v}_{o,n}(t) \\ & - RC_1 \dot{v}_{o,e}(t) v_{o,n}(t) - RC_1 v_{o,n}(t) \dot{v}_{o,n}(t). \end{aligned} \quad (72)$$

The last term in the right-hand side of (72) is the noise self modulation term and can be neglected. This approximation gives the noise linear ordinary differential equation of

$$\begin{aligned} v_{o,n}(t) = & v_{i,n}(t) - RC_0 \dot{v}_{o,n}(t) - RC_1 v_{o,e}(t) \dot{v}_{o,n}(t) \\ & - RC_1 \dot{v}_{o,e}(t) v_{o,n}(t). \end{aligned} \quad (73)$$

Now we look at the behavior of different terms of this equation. The first two terms are responsible for the noise shaping in linear systems. Once again, the second term has also another effect: it transforms the quadrature noise into in-phase noise and vice versa. The third term modulates the derivative of the output noise by the carrier in-phase component. The derivatives of baseband noise are negligible at low offset frequencies (relative to carrier frequency). Therefore, with respect to the modulation of baseband noise, the third term is not expected to be the main contributor to noise modulation. The 4th term, however, quadrature-modulates the baseband noise and acts as a source term for the quadrature noise. These mechanisms are also illustrated graphically in Fig. 9.

Once again, by decomposing the noise into baseband, in-phase and quadrature components as in (61) and neglecting the noise terms around the second harmonics, three linear and homogeneous differential equations for these noise terms are obtained. The details of derivation for each term of (73) are shown in Table II. The baseband noise equation is

$$v_{n,\mathbf{BB}}(t) + RC_0 \dot{v}_{n,\mathbf{BB}}(t) = v_{i,n}(t) - \frac{1}{2} RC_1 V_{o,1} \dot{v}_{n,\mathbf{I}}(t). \quad (74)$$

Unlike the nonlinear conductance case discussed before, we don't have any noise folding from the first harmonic proportional to the noise component itself, but we see the derivative

TABLE II
DETAILED TERMS IN DECOMPOSITION OF THE OUTPUT NOISE OF RC CIRCUIT WITH NONLINEAR CAPACITANCE INTO BASEBAND, IN-PHASE AND QUADRATURE COMPONENTS

term in (73)	baseband part	in-phase part	quadrature part
$v_{o,n}(t)$	$v_{n,\mathbf{BB}}(t)$	$v_{n,\mathbf{I}}(t) \cos(\omega_0 t + \phi_1)$	$v_{n,\mathbf{Q}}(t) \sin(\omega_0 t + \phi_1)$
$v_{i,n}(t)$	$v_{i,n}(t)$	–	–
$-RC_0 \dot{v}_{o,n}(t)$	$-RC_0 \dot{v}_{n,\mathbf{BB}}(t)$	$-RC_0 \dot{v}_{n,\mathbf{I}}(t) \cos(\omega_0 t + \phi_1)$ $-RC_0 \omega_0 v_{n,\mathbf{Q}}(t) \cos(\omega_0 t + \phi_1)$	$-RC_0 \dot{v}_{n,\mathbf{Q}}(t) \sin(\omega_0 t + \phi_1)$ $+RC_0 \omega_0 v_{n,\mathbf{I}}(t) \sin(\omega_0 t + \phi_1)$
$-RC_1 \frac{d}{dt} (v_{o,e}(t)v_{o,n}(t))$	$-\frac{1}{2} RC_1 V_{o,1} \dot{v}_{n,\mathbf{I}}(t)$	$-RC_1 V_{o,1} \dot{v}_{n,\mathbf{BB}}(t) \cos(\omega_0 t + \phi_1)$	$RC_1 \omega_0 V_{o,1} v_{n,\mathbf{BB}}(t) \sin(\omega_0 t + \phi_1)$

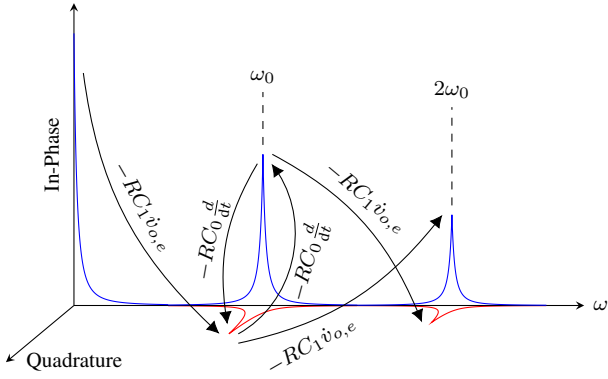

Fig. 9. Formation of noise side-bands in RC circuit with nonlinear capacitance.

of the quadrature component of the noise is folded back to baseband noise. For the in-phase component we have

$$v_{n,\mathbf{I}}(t) + RC_0 \dot{v}_{n,\mathbf{I}}(t) = -RC_0 \omega_0 v_{n,\mathbf{Q}}(t) - RC_1 V_{o,1} \dot{v}_{n,\mathbf{BB}}(t) \quad (75)$$

The in-phase noise has two source terms: The derivative of the baseband noise and the quadrature noise. Neglecting the derivative of baseband noise and assuming the linear time constants of RF circuit does not influence modulated noise terms, the in-phase noise is a secondary effect and is caused by generation of quadrature noise in the nonlinear element in the first place.

Finally, for the quadrature noise we have

$$v_{n,\mathbf{Q}}(t) + RC_0 \dot{v}_{n,\mathbf{Q}}(t) = RC_0 \omega_0 v_{n,\mathbf{I}}(t) + RC_1 \omega_0 V_{o,1} v_{n,\mathbf{BB}}(t). \quad (76)$$

The quadrature noise has two source terms: the in-phase noise that is quadrature-transformed at the linear part of the capacitor and the baseband noise that is quadrature-modulated by the nonlinear part of the capacitor.

By neglecting all the time derivatives of the baseband and modulated noise terms, these equations have a simple solution

$$v_{n,\mathbf{BB}}(t) \approx v_{i,n}(t), \quad (77a)$$

$$v_{n,\mathbf{I}}(t) \approx \frac{-R^2 C_0 C_1 \omega_0^2}{1 + (RC_0 \omega_0)^2} V_{o,1} v_{i,n}(t), \quad (77b)$$

$$v_{n,\mathbf{Q}}(t) \approx \frac{RC_1 \omega_0}{1 + (RC_0 \omega_0)^2} V_{o,1} v_{i,n}(t). \quad (77c)$$

Therefore, the AM and PM noise transfer functions can be written as

$$H_{\text{AM}} = \frac{-R^2 C_0 C_1 \omega_0^2}{1 + (RC_0 \omega_0)^2} \quad \text{and} \quad H_{\text{PM}} = \frac{-RC_1 \omega_0}{1 + (RC_0 \omega_0)^2} \quad (78)$$

Fig. 10 shows the simulation results of an RC circuit with nonlinear capacitance in comparison with theory. The simulation results show that the AM/PM noise transfer functions can be estimated with a good precision at moderate excitation levels.

C. Noise in RC circuit with nonlinear conductance and nonlinear capacitance

After previous discussions, we are now ready to discuss the simultaneous effect of nonlinear conductance and capacitance of a nonlinear RC circuit on the output noise of the circuit, shown in Fig. 11. Although the problem seems complicated, most of the steps to find the noise response have already been performed. This will be done in a step by step approach similar to previous sections. It is also a good practice to review what needs to be done for more sophisticated nonlinear circuits.

- Deriving the governing equation of the circuit

$$v_o(t) = v_i(t) - RC_0 \dot{v}_o(t) - g_2 R v_o^2(t) - RC_1 v_o(t) \dot{v}_o(t). \quad (79)$$

- Finding the linear response of the circuit. The fundamental tone response at moderate input levels once again is similar to linear response given in (55) and (56).

- Deriving the noise nonlinear differential equation

$$v_{o,n}(t) = v_{i,n}(t) - RC_0 \dot{v}_{o,n}(t) - 2g_2 R v_{o,e}(t) v_{o,n}(t) - RC_1 v_{o,e}(t) \dot{v}_{o,n}(t) - RC_1 \dot{v}_{o,e}(t) v_{o,n}(t) - g_2 R v_{o,n}^2(t) - RC_1 v_{o,n}(t) \dot{v}_{o,n}(t). \quad (80)$$

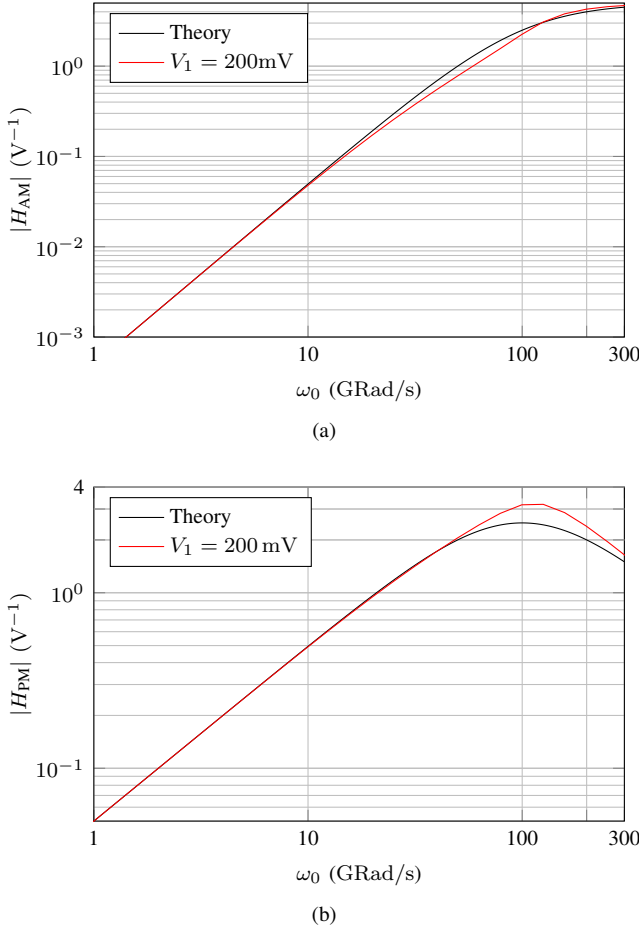

Fig. 10. AM and PM noise transfer functions in RC circuit with nonlinear transconductance; $R = 100 \Omega$, $C_0 = 100 \text{ fF}$, $C_1 = 500 \text{ fF/V}$,

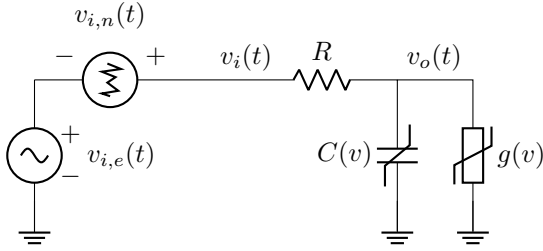

Fig. 11. Nonlinear RC circuit with a nonlinear capacitance and a nonlinear conductance.

- Neglecting the noise self modulation terms

$$v_{o,n}(t) = v_{i,n}(t) - RC_0 \dot{v}_{o,n}(t) - 2g_2 R v_{o,e}(t) v_{o,n}(t) - RC_1 v_{o,e}(t) \dot{v}_{o,n}(t) - RC_1 \dot{v}_{o,e}(t) v_{o,n}(t). \quad (81)$$

- Decompose the noise response to baseband, in-phase and quadrature noise around the carrier given in (61) and neglecting the noise terms modulated around higher order harmonics.

- Substituting the assumed noise response given in (61) into the noise differential equation (81) and neglecting the noise terms modulated around the second harmonic.

- Equating the based noise, in-phase- and quadrature-modulated noise terms on both sides of the equation and

obtaining a new set of linear and homogeneous differential equations

$$v_{n,\mathbf{BB}}(t) + RC_0 \dot{v}_{n,\mathbf{BB}}(t) = v_{i,n}(t) - g_2 R V_{o,1} v_{n,\mathbf{I}}(t) - \frac{1}{2} RC_1 V_{o,1} \dot{v}_{n,\mathbf{I}}(t). \quad (82a)$$

$$v_{n,\mathbf{I}}(t) + RC_0 \dot{v}_{n,\mathbf{I}}(t) = -RC_0 \omega_0 v_{n,\mathbf{Q}}(t) - 2g_2 R V_{o,1} v_{n,\mathbf{BB}}(t) - RC_1 V_{o,1} \dot{v}_{n,\mathbf{BB}}(t) \quad (82b)$$

$$v_{n,\mathbf{Q}}(t) + RC_0 \dot{v}_{n,\mathbf{Q}}(t) = RC_1 \omega_0 V_{o,1} v_{n,\mathbf{BB}}(t) - RC_0 \omega_0 v_{n,\mathbf{I}}(t). \quad (82c)$$

- Neglecting the effect of short time constants of the RF circuit on low-frequency noise terms. This means all time derivatives of the noise terms can be neglected. Also neglecting the in-phase modulated noise that is folded back to baseband frequencies (the term $g_2 R V_{o,1} v_{n,\mathbf{I}}(t)$ in (82b)). The solution of this set of equation will be

$$v_{n,\mathbf{BB}}(t) = v_{i,n}(t) \quad (83a)$$

$$v_{n,\mathbf{I}}(t) = -\frac{2g_2 R + R^2 C_0 C_1 \omega_0^2}{1 + (RC_0 \omega_0)^2} V_{o,1} v_{i,n}(t) \quad (83b)$$

$$v_{n,\mathbf{Q}}(t) = \frac{RC_1 \omega_0 - 2g_2 R^2 C_0 \omega_0}{1 + (RC_0 \omega_0)^2} V_{o,1} v_{i,n}(t) \quad (83c)$$

- Extracting the AM and PM noise transfer function from the solution

$$H_{\text{AM}} = -\frac{2g_2 R + R^2 C_0 C_1 \omega_0^2}{1 + (RC_0 \omega_0)^2} \quad (84a)$$

$$H_{\text{PM}} = \frac{-RC_1 \omega_0 + 2g_2 R^2 C_0 \omega_0}{1 + (RC_0 \omega_0)^2} \quad (84b)$$

Equation (84) shows that the additive phase noise of nonlinear RC circuit depends on the sign of 2nd order nonlinear coefficients g_2 and C_1 . This behavior can potentially be used to reduce the overall PM noise of active circuits.

V. APPLYING THE THEORY TO BIPOLAR TRANSISTOR

Now that we discussed the AM and PM noise in a relatively simple nonlinear circuit, we are ready to apply our theory to a more practical case. We choose a common-emitter bipolar transistor for this purpose, shown in Fig. 12(a). The problem description seems simple: what is the additive AM and PM noise at the output collector current? However, without the mathematical calculations we did in the previous sections, it would have been a very complex problem.

For our simulation, we use a SiGe bipolar transistor offered from 130nm technology node from IHP. The transistor is modeled according to Vertical Bipolar Intercompany Model (VBIC). In order to simplify the complex model parameters, we neglect the effect of parasitic pnp transistor as well as external base-emitter junction. We also neglect the effect of feedback base-collector capacitance and Early effect. The simplified model of transistor is illustrated in Fig. 12(b). In order to further simplify our analysis, we employ a simulation-assisted parameter extraction with Virtuoso analog design

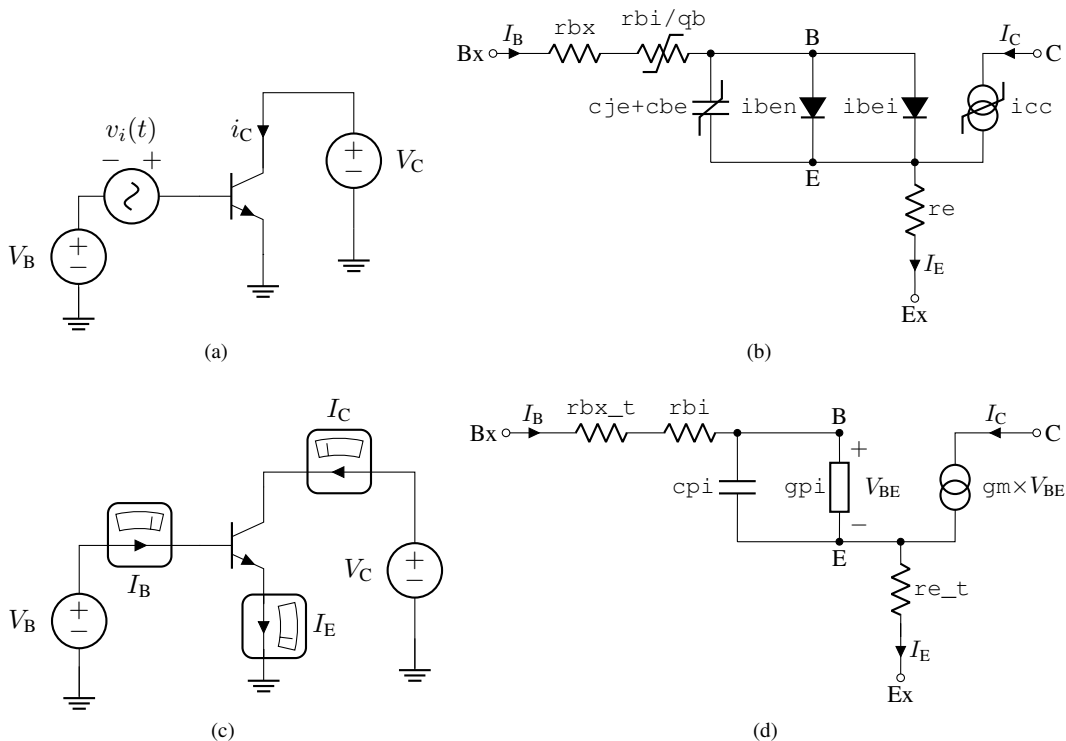

Fig. 12. (a) Test setup for simulation of AM/PM noise in bipolar transistor, (b) nonlinear model of bipolar transistor, (c) curve tracer setup for extraction of bipolar transistor parameters and (d) small signal model of bipolar transistor.

environment commercial software from Cadence Design Systems, Inc. In the next section, we explain how the second order nonlinearity coefficients are extracted with a curve tracer setup. For an enthusiastic reader that is interested in regeneration of the results, we used two different notations. For instance, when we refer to our design parameters such as the base-collector transconductance, we use g_m . When we refer to a standard parameter that is provided by the model or the simulation software, we use the same exact notation used in the software, such as g_m for base-collector transconductance. The relation between our model parameters and the simulation software parameters are given via equations.

A. Curve tracer for large signal parameter extraction

In order to extract the 2nd order nonlinear coefficients necessary for our analysis, we perform a simulation-assisted parameter extraction, rather than trying to solve the nonlinear equations of bipolar transistor at the desired operating point. This approach significantly simplifies the raw material required for our nonlinear analysis. We set up a curve tracer, shown in Fig. 12(c) and use the software-extracted small signal parameters shown in Fig. 12(d). For instance, instead of finding c_{je} and c_{be} at the desired operating point, we directly use the small signal capacitance value c_{pi} provided by the simulation software. The value of this capacitance is a function of the device operating point. The derivative of this capacitance with respect to base-emitter voltage then gives the first nonlinear coefficient of the capacitance. Therefore, by sweeping the base-emitter voltage, this nonlinear coefficient can be extracted. However, we need to perform the derivative

operation with respect to base-emitter voltage of the *inner* transistor, not the voltage applied to the external junctions of the base and the emitter. Therefore, the effect of base and emitter parasitic should be de-embedded. The base resistor is composed of two terms, the internal base resistor r_{bi} which is the linearized version of the nonlinear r_{bi}/q_b resistor, and external ohmic and linear resistor r_{bx_t} . For the emitter resistor we have just an ohmic resistor r_{e_t} . The base and emitter resistances therefore are

$$R_B = r_{bx_t} + r_{bi} \quad \text{and} \quad R_E = r_{e_t}. \quad (85)$$

The inner base-emitter voltage can consequently be written as

$$V_{BE} = V_{BxEx} - R_B I_B - R_E I_E \quad (86)$$

For extraction of nonlinear coefficient of base conductance $g_{\pi}(V_{BE})$ we start from the first derivative of base current (with respect to V_{BE}) provided by dc analysis, g_{pi} .

$$\begin{cases} g_{\pi 1} = g_{pi} \\ g_{\pi 2} = \frac{1}{2} \frac{dg_{pi}}{dV_{BE}} \end{cases} \quad (87)$$

The normalized conductance coefficients, $g_{\pi 1}$ and $g_{\pi 2}$, are plotted in Fig. 13(a). Similarly, the linear and 2nd order nonlinear coefficients of the base-collector transconductance and base-emitter capacitance can be found as

$$\begin{cases} g_{m 1} = g_m \\ g_{m 2} = \frac{1}{2} \frac{dg_m}{dV_{BE}} \end{cases} \quad (88)$$

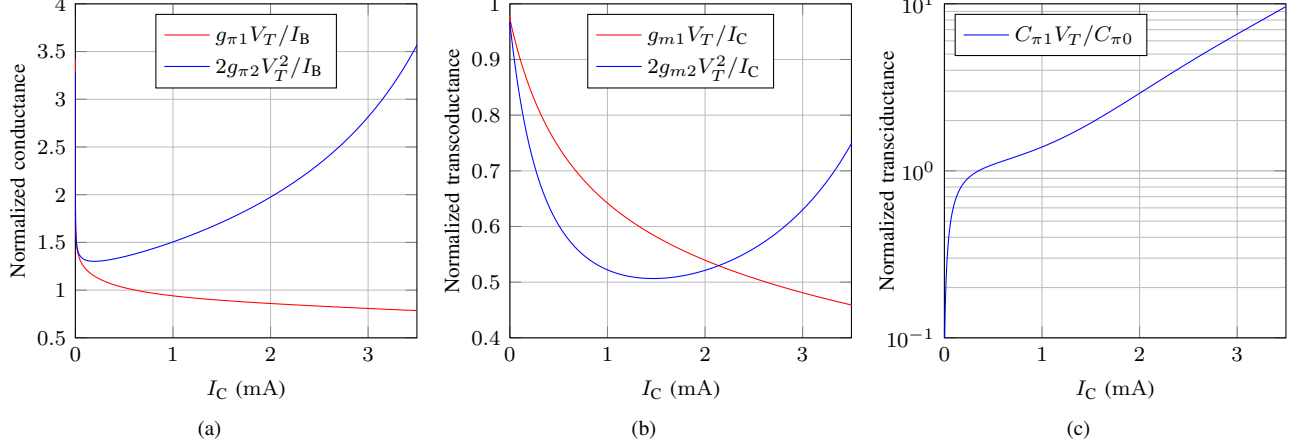

Fig. 13. Normalized linear and 2nd order nonlinear coefficients extracted from curve tracer setup; (a) base-emitter conductance, (b) base-collector transconductance, and (c) base-emitter capacitance.

$$\begin{cases} C_{\pi 0} = c_{\pi 0} \\ C_{\pi 1} = 2 \frac{dc_{\pi 1}}{dV_{BE}} \end{cases} \quad (89)$$

The normalized transconductance and capacitance coefficients are plotted in Fig. 13(b) and Fig. 13(c) for a transistor in IHP 130 nm technology with an emitter length of $0.48 \mu\text{m}$.

B. AM and PM noise transfer functions of bipolar transistor

Figure 14(a) shows the large-signal model of our simple test setup, which was presented in Fig. 12(a), including its 2nd order nonlinear coefficients and the flicker noise source of base-emitter junction $i_{n,B}$. The transistor is biased at 1 mA collector current. The governing equation for v_{BE} can be found using the following set of equations

$$v_{BE}(t) = v_i(t) - R_B i_B(t) - R_E i_E(t) \quad (90a)$$

$$i_C(t) = g_m(v_{BE}(t)) \times v_{BE}(t) \quad (90b)$$

$$i_E(t) = i_B(t) + i_C(t) \quad (90c)$$

$$i_B(t) = g_{\pi}(v_{BE}(t)) \times v_{BE}(t) + C_{\pi}(v_{BE}(t)) \dot{v}_{BE}(t) + i_{n,B}(t) \quad (90d)$$

The dependence of the transistor parameters to time are clear in the equations above. From this point on, for notation simplicity, we avoid writing this time-dependence and, for instance, write v_{BE} instead of $v_{BE}(t)$ or g_m instead of $g_m(v_{BE}(t))$. First we substitute the collector current from (90b) to the right-hand side emitter current equation in (90c) and eliminate i_C . From our equations. Then we substitute the base current and emitter currents in (90c) and (90d) to the base-emitter voltage equation in (90a). This may sound trivial, but we emphasize on this step-by-step approach to remind that our system is nonlinear and most of the equations from linear system analysis are not applicable here. The substitution explained above results in the differential equation of v_{BE} as

$$v_{BE} = v_i - (R_B + R_E) i_{n,B} - g_{\pi}(R_B + R_E) v_{BE} - g_m R_E v_{BE} - (R_B + R_E) C_{\pi} \dot{v}_{BE} \quad (91)$$

Depending on our degree of approximation for g_m , g_{π} and C_{π} , this equation could be linear or nonlinear. Now we use the 2nd order nonlinear coefficient extracted by the curve tracer setup in the previous section

$$g_m(v_{BE}) = g_{m1} + g_{m2} v_{BE}, \quad (92a)$$

$$g_{\pi}(v_{BE}) = g_{\pi 1} + g_{\pi 2} v_{BE}, \quad (92b)$$

$$C_{\pi}(v_{BE}) = C_{\pi 0} + C_{\pi 1} v_{BE}. \quad (92c)$$

Substituting these nonlinear coefficients into (91) leads to nonlinear differential equation of

$$\begin{aligned} (1 + g_{\pi 1}(R_B + R_E) + g_{m1} R_E) v_{BE} &= v_i \\ - (R_B + R_E) i_{n,B} - (R_B + R_E) C_{\pi 0} \dot{v}_{BE} & \\ - (g_{\pi 2}(R_B + R_E) + g_{m2} R_E) v_{BE}^2 & \\ - (R_B + R_E) C_{\pi 1} v_{BE} \dot{v}_{BE} & \end{aligned} \quad (93)$$

This equation is similar to the governing equation of the RC circuit with nonlinear conductance and nonlinear capacitance in (79). On the left-hand side of both equations, we have just the term of unknown variable. On the right-hand side, we have the input signal term, input noise terms, linear derivative of the output voltage caused by the linear part of the capacitance, a nonlinear term caused by the overall nonlinear conductance and transconductance terms in transistor, and, a nonlinear term proportional to the output voltage and its derivative caused by the nonlinear part of the capacitance. In order to make these equations exactly identical, we define the following set of parameters.

$$v_{i,e} := \frac{1}{k} v_i \quad (94a)$$

$$v_{i,n} := -\frac{1}{k} (R_B + R_E) i_{n,B} \quad (94b)$$

$$k := 1 + g_{\pi 1}(R_B + R_E) + g_{m1} R_E \quad (94c)$$

$$C_0 := C_{\pi 0} \quad (94d)$$

$$C_1 := C_{\pi 1} \quad (94e)$$

$$R := \frac{1}{k} (R_B + R_E) \quad (94f)$$

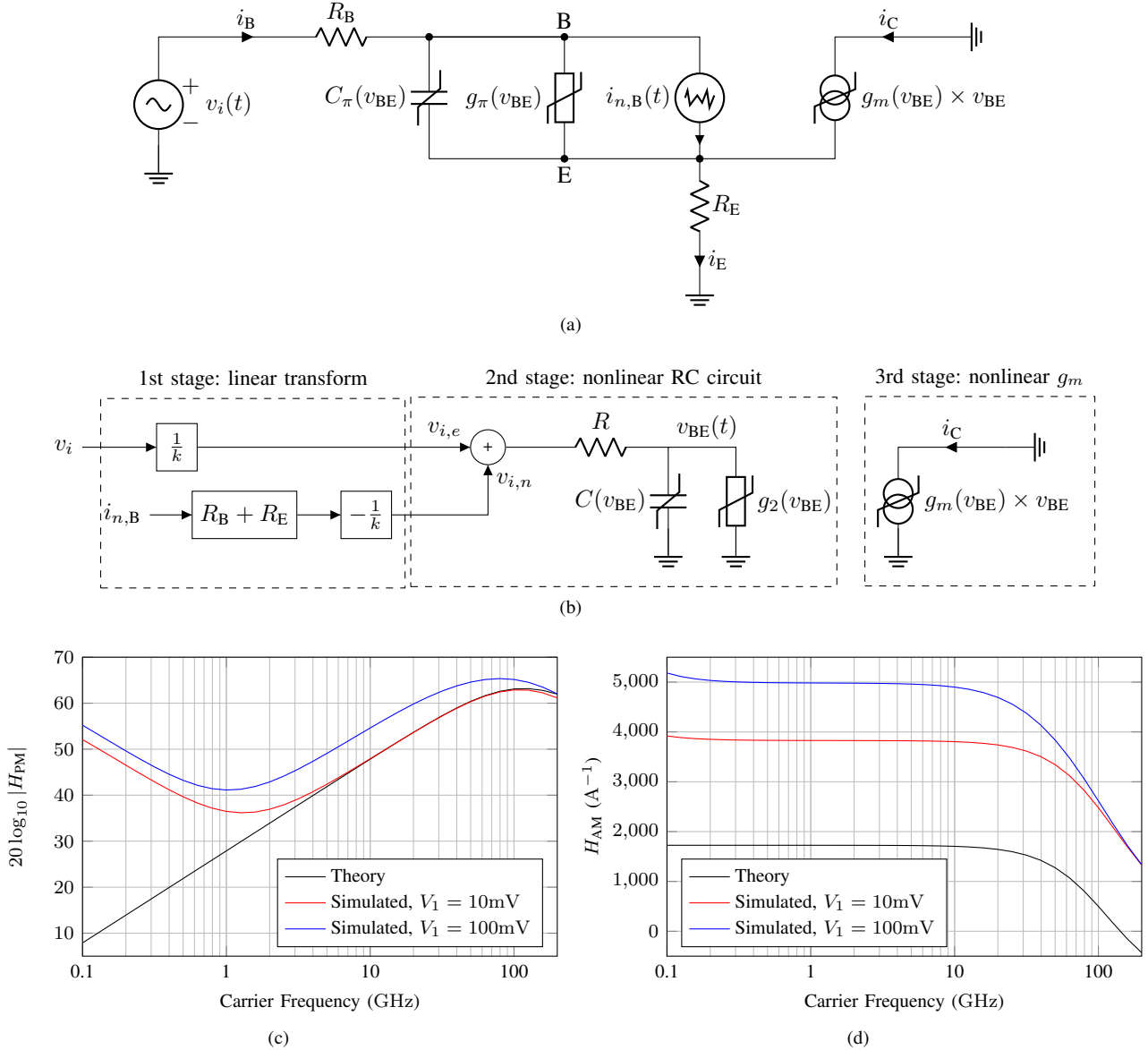

Fig. 14. (a) Simplified nonlinear model of bipolar transistor, (b) its equivalent circuit for our nonlinear analysis, (c) PM noise transfer function and (d) AM noise transfer function.

$$g_2 := \frac{g_{\pi 2}(R_B + R_E) + g_{m 2}R_E}{R_B + R_E} \quad (94g)$$

With this set of parameters, we can find the AM and PM noise transfer functions for the voltage across the inner base-emitter diode terminals. But we want to find the AM and PM noise transfer functions with respect to the collector current. Besides, the input signal is scaled by $1/k$ and the base-emitter noise current is scaled with $(R_B + R_E)/k$. So we have to take into account the effect of linear scaling of the inputs. These linear and nonlinear transformation are shown in Fig. 14(b) as different stages. Now we find the overall AM and PM noise transfer functions. We start with H_{PM} . The last stage is a memoryless element, so it does not have any effect on the phase noise. Therefore, we can write the output PM noise at the v_{BE} node as

$$v_{n,Q,BE}(t) = -H_{PM,2} \times v_{BE}(t) \times v_{i,n}(t). \quad (95)$$

Substituting $v_{i,n}$ from (94b) in (95), gives

$$v_{n,Q,BE}(t) = -H_{PM,2} \times v_{BE}(t) \times \left[-\frac{1}{k}(R_B + R_E)i_{n,B} \right]. \quad (96)$$

Therefore, the overall PM noise transfer function is

$$H_{PM} = -\frac{1}{k}(R_B + R_E)H_{PM,2}. \quad (97)$$

where $H_{PM,2}$ can be calculated using (84b) and (94a) to (94g). Finding the AM noise requires more caution, as the 3rd stage has 2nd order nonlinearity. The AM noise transfer function of the third stage can be written as

$$H_{AM,3} = 2 \frac{g_{m,2}}{g_{m,1}} \quad (98)$$

The second stage has a linear gain of $v_{BE}/v_{i,e} = 1$, as g_2 is purely nonlinear of 2nd order. Therefore, the overall AM

noise transfer function of the 2nd and 3rd cascaded stages is (see appendix A)

$$H_{AM,2-3} = H_{AM,2} + H_{AM,3} \quad (99)$$

Now we can write the AM noise of the collector current as

$$i_{n,I,C}(t) = H_{AM,2-3} \times i_C(t) \times \left[-\frac{1}{k}(R_B + R_E)i_{n,B} \right]. \quad (100)$$

Therefore we have

$$H_{AM} = -\frac{1}{k}(R_B + R_E) \left(H_{AM,2} + 2\frac{g_{m,2}}{g_{m,1}} \right). \quad (101)$$

where $H_{AM,2}$ can be calculated using (84a) and (94a) to (94g). We avoid further approximation and compare the theoretical results with the simulation results, plotted in Figs. 14(c) and 14(d). At moderate excitation levels, H_{PM} shows a good matching with theory at high frequencies. The difference between the theoretical and simulation results at low frequencies is due to the low-frequency pole of HBT transistor caused by self heating, which was not included in our analysis. At higher excitation levels, the higher order nonlinear coefficients affect H_{PM} which leads to deviation from our 2nd order nonlinear analysis. The simulated AM noise transfer function is higher than the estimated value by almost 2-3 times at different excitation levels. This difference can be attributed mainly to approximations related to memoryless elements; for instance, neglecting 2nd order nonlinearity of `rbi`, the nonlinear collector-emitter conductance caused by the Early effect, and the effect of collector parasitic pnp transistor. Although all these effects were neglected, the analytical approach still provides a good estimation of AM and PM noise transfer functions.

VI. CONCLUSIONS

In this paper, we provided a systematic approach for understanding the nonlinear mechanisms that lead to additive AM/PM noise generation in active devices. A mathematical model for including the AM and PM noise in active devices was provided. Based on this model, various noisy nonlinear circuits were analyzed and the AM/PM noise transfer functions were extracted and the analytical results were compared with theory. Finally, this approach was applied to a bipolar transistor, and the analytical results were validated by comparing them with the simulation results.

APPENDIX A

CASCADED STAGES WITH SECOND ORDER NONLINEARITY

An important scenario in nonlinear noise mechanisms is having two nonlinear elements, α and β , acting in series, shown in Fig. 15.

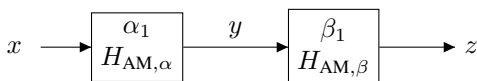

Fig. 15. Cascaded stages with 2nd order nonlinearity.

The first & the second element have a linear gain of α_1 & β_1 and AM noise transfer function of $H_{AM,\alpha}$ & $H_{AM,\beta}$,

respectively. We want to find the AM noise transfer function of the overall system. Let's assume the input has a monotone excitation part, given in (14), and a noise part as

$$x(t) = x_{i,e}(t) + x_{i,n}(t). \quad (102)$$

The output of the first element can be written as

$$y(t) = \alpha_1 x_{i,e}(t) + \alpha_1 x_{i,n}(t) + H_{AM,\alpha} x_{i,n}(t) \alpha_1 x_{i,e}(t), \quad (103)$$

The third term in the right-hand side is the AM noise modulated around the carrier. In the third term in the right-hand side of (103), we placed α_1 intentionally behind $x_{i,e}$ to emphasize that H_{AM} is defined with respect to the *output* of the nonlinear element. Now we apply $y(t)$ to the element β . All the inputs of element β in are linearly transferred to output by coefficient β_1 and an additional AM noise term in generated that is proportional to $H_{AM,\beta}$, the *input* noise, and the *output* signal of element β . Therefore

$$z(t) = \beta_1 [\alpha_1 x_{i,e}(t) + \alpha_1 x_{i,n}(t) + H_{AM,\alpha} x_{i,n}(t) \alpha_1 x_{i,e}(t)], \\ + H_{AM,\beta} [\alpha_1 x_{i,n}(t)] \times [\beta_1 \alpha_1 x_{i,e}(t)], \quad (104)$$

Therefore, the AM noise transfer function of the two elements combined can be written as

$$H_{AM} = H_{AM,\alpha} + \alpha_1 H_{AM,\beta} \quad (105)$$

REFERENCES

- [1] J.-F. Cliche and B. Shillue, "Applications of control precision timing control for radioastronomy maintaining femtosecond synchronization in the atacama large millimeter array," *IEEE Control Systems Magazine*, vol. 26, no. 1, pp. 19–26, 2006.
- [2] H.-D. Nuhn, "Linac coherent light source (lcls) conceptual design report," 11 2002. [Online]. Available: <https://www.osti.gov/biblio/808719>
- [3] A. Khilo, S. J. Spector, M. E. Grein, A. H. Nejadmalayeri, C. W. Holzwarth, M. Y. Sander, M. S. Dahlem, M. Y. Peng, M. W. Geis, N. A. DiLello, J. U. Yoon, A. Motamedi, J. S. Orcutt, J. P. Wang, C. M. Sorace-Agaskar, M. A. Popović, J. Sun, G.-R. Zhou, H. Byun, J. Chen, J. L. Hoyt, H. I. Smith, R. J. Ram, M. Perrott, T. M. Lyszczarz, E. P. Ippen, and F. X. Kärtner, "Photonic ADC: overcoming the bottleneck of electronic jitter," *Optics Express*, vol. 20, no. 4, p. 4454, Feb 2012.
- [4] J. Scheer, "Coherent radar system performance estimation," in *IEEE International Conference on Radar*, 1990, pp. 125–128.
- [5] F. Walls, E. Ferre-Pikal, and S. Jefferts, "Origin of 1/f pm and am noise in bipolar junction transistor amplifiers," *IEEE Transactions on Ultrasonics, Ferroelectrics, and Frequency Control*, vol. 44, no. 2, pp. 326–334, 1997.
- [6] F. Walls, E. Ferre-Pikal, S. R. Jefferts *et al.*, "1/f pm and am noise in amplifiers and oscillators," in *Proc. 2001 ICTF Conf*, 2001, pp. 226–240.
- [7] T.-D. Tomlin, K. Fynn, and A. Cantoni, "A model for phase noise generation in amplifiers," in *Proceedings of the 2000 IEEE/EIA International Frequency Control*

Symposium and Exhibition (Cat. No.00CH37052), 2000, pp. 516–524.

- [8] E. S. Ferre-Pikal and F. H. Savage, “Up-converted 1/f pm and am noise in linear hbt amplifiers,” *IEEE Transactions on Ultrasonics, Ferroelectrics, and Frequency Control*, vol. 55, no. 8, pp. 1698–1704, 2008.
- [9] R. Boudot and E. Rubiola, “Phase noise in rf and microwave amplifiers,” *IEEE Transactions on Ultrasonics, Ferroelectrics, and Frequency Control*, vol. 59, no. 12, pp. 2613–2624, 2012.
- [10] E. Ferre-Pikal, “Reduction of phase noise in linear hbt amplifiers using low-frequency active feedback,” *IEEE Transactions on Circuits and Systems I: Regular Papers*, vol. 51, no. 8, pp. 1417–1421, 2004.
- [11] B. Razavi, *RF Microelectronics*. London, U.K.: Pearson Education, 2011.