

Stochastic Neural Network Symmetrisation in Markov Categories

Rob Cornish

Department of Statistics, University of Oxford

Abstract

We consider the problem of symmetrising a neural network along a group homomorphism: given a homomorphism $\varphi : H \rightarrow G$, we would like a procedure that converts H -equivariant neural networks into G -equivariant ones. We formulate this in terms of Markov categories, which allows us to consider neural networks whose outputs may be stochastic, but with measure-theoretic details abstracted away. We obtain a flexible, compositional, and generic framework for symmetrisation that relies on minimal assumptions about the structure of the group and the underlying neural network architecture. Our approach recovers existing methods for deterministic symmetrisation as special cases, and extends directly to provide a novel methodology for stochastic symmetrisation also. Beyond this, we believe our findings also demonstrate the utility of Markov categories for addressing problems in machine learning in a conceptual yet mathematically rigorous way.

Contents

1. Introduction	1
2. Background on Markov categories	5
3. Group theory in Markov categories	10
4. Symmetrisation	27
5. A general methodology	31
6. Examples	37
7. Application and numerical results	41

1 Introduction

In many machine learning problems, it is useful to have a neural network that is *equivariant* with respect to some group actions. That is, for some group G acting on some input and output spaces X and Y of interest, we would like a neural network $f : X \rightarrow Y$ that satisfies

$$f(g \cdot x) = g \cdot f(x) \tag{1}$$

for all $x \in X$ and $g \in G$. A special case of this is *invariance*, which takes the action on Y to be trivial, and so the requirement becomes $f(g \cdot x) = f(x)$ instead. Such constraints arise in many applications involving some geometric structure, such as computer vision, or

scientific problems where the data involved are known to follow certain symmetries [Bro+17; Bro+21]. However, most off-the-shelf neural networks are not equivariant. Unless care is taken, even after training on data that contains symmetries, typically (1) will fail to hold, possibly to a large degree. This can reduce performance and robustness, and so an active research area considers how to develop neural networks that are equivariant by design.

Intrinsic equivariance vs. symmetrisation Following [Yar18], it is helpful to distinguish between two major approaches to obtaining equivariant neural networks. A significant body of work has focussed on *intrinsic equivariance*, which imposes certain constraints on individual layers of a neural network to ensure that the network as a whole is equivariant [CW16; RSP17; FWW21]. In contrast, a recent line of work may be described as *symmetrisation*, which takes an unconstrained neural network and modifies it in some way to become equivariant. For example, when G is finite, the function

$$x \mapsto \frac{1}{|G|} \sum_{g \in G} f(g^{-1} \cdot x)$$

that averages over the elements of the group is seen always to be invariant, regardless of f [Yar18]. This observation formed the basis of the *Janossy pooling* approach of [Mur+19b], who took G to be the symmetric group of permutations, and obtained in this way a neural network that does not depend on the ordering of its inputs. Subsequently, *frame averaging* [Pun+22] extended this to the case of equivariance and to more general groups, and provided a technique for reducing the cost of the averaging operation, which can be expensive when G is large. An initially parallel approach of *canonicalisation* was proposed by [Kab+23], which relies on a single representative element of the group that is chosen in an equivariant way, and thereby avoids averaging altogether. Both techniques were then generalised by *probabilistic symmetrisation* [Kim+23], which averages over a random element of the group that is sampled in an equivariant way. A related approach of *weighted frames* was also recently proposed by [DLS24]. Overall, symmetrisation approaches are attractive as they can leverage unconstrained neural network architectures as their “backbone”, while still ensuring equivariance overall. This leads to greater modelling flexibility, which these earlier works have shown can often improve performance compared with intrinsic approaches.

Stochastic equivariance In this work, we consider a neural network that is allowed to depend on some additional randomness, so that its outputs are stochastic. Various closely-related notions of equivariance have been proposed for such models in the literature, including [BT20, (8)] and [Xu+22, Proposition 1]. As a first definition for our purposes, our goal is to obtain a neural network f and a random variable \mathbf{U} such that

$$f(g \cdot x, \mathbf{U}) \stackrel{d}{=} g \cdot f(x, \mathbf{U}) \quad (2)$$

for all $x \in X$, $g \in G$, where $\stackrel{d}{=}$ denotes equality in distribution. In other words, we want a model whose distribution of outputs is equivariant across repeated executions rather than necessarily at any single one. This generalises our original condition (1): every deterministically equivariant f is also stochastically equivariant in a degenerate way, but the

converse is not true, since the distributional equality considered here does not imply that f is equivariant in a pointwise or almost sure sense. In this way, stochastic equivariance allows us to consider a broader class of models than could be obtained from the deterministic case directly. Stochastic equivariance is of interest in applications such as generative modelling [Xu+22; Hoo+22; AA22; Yim+23] and reinforcement learning [Bre+23], and in situations where uncertainty quantification is required. It is also relevant for deterministic symmetrisation itself, since although the probabilistic methods of [Kim+23; DLS24] ultimately produce a deterministic output, they rely on a stochastically equivariant neural network for a particular subcomponent.

In much of the following, it is convenient to regard the pair of f and \mathcal{U} as a single entity thought of as a *generative process*, rather than decoupling these as in (2). We formalise this in terms of *Markov kernels*, defined in Section 2.1, which are a standard construction in probability theory for modelling conditional distributions or stochastic maps. In short, a Markov kernel $k : X \rightarrow Y$ encodes for each $x \in X$ a probability distribution on Y that we denote $k(dy|x)$. The equivariance condition we will consider is then as follows:

$$k(dy|g \cdot x) = (g \cdot k)(dy|x) \tag{3}$$

for all $x \in X$, $g \in G$, where $g \cdot k : X \rightarrow Y$ denotes the Markov kernel that first samples from k and then deterministically applies g to the result. If (2) holds, we can obtain a suitable k by defining $k(dy|x)$ as the distribution of $f(x, \mathcal{U})$. Markov kernels therefore subsume our discussion above, and will serve as our primary case of interest in what follows.

Markov categories We use *Markov categories* [CJ19; Fri20] as a framework for reasoning about stochastically equivariant neural networks. An overview of this topic is provided in Section 2 below. At a high level, rather than dealing with Markov kernels directly, we study the behaviour of abstract entities known as *morphisms* that behave like Markov kernels in a precise sense. In doing so, we can prove results about Markov kernels using intuitive, high-level, and often purely diagrammatic arguments, and without needing to worry about low-level measure theoretic details. We also gain significant additional generality, and can specialise to various other settings of interest in a seamless way. For example, although we emphasise stochastic equivariance in what follows, our results are still valid in Markov categories that happen to be purely deterministic, and so also apply to existing work on deterministic symmetrisation as a result.

One consequence of this approach is that we need to generalise various concepts from classical, set-theoretic group theory so that they make sense in a general Markov category. We do so in Section 3 below, including for groups, homomorphisms, actions, equivariance, semidirect and direct products, orbits, and cosets. Our account uses standard constructions for this purpose, although does require some specific considerations for the Markov category setting. We believe this may therefore be of interest in other work that combines groups and Markov categories also.

Throughout the paper, we will make use of various standard concepts from category theory, including as functors, coequalisers, and adjoints. We have sought to do so sparingly, and only when this provides a large enough conceptual benefit to be justified. We have also sought to present the overall methodology we obtain in a way that can be applied in practice even without a detailed understanding of these concepts (see e.g. Sections 5.4 and

6). For readers unfamiliar with category theory, a highly accessible introduction can be found in [Per21]. We will also provide more specific references in various places, as well as examples of these concepts in more concrete settings where appropriate. For readers who do know category theory, these parts can be skipped over without loss of continuity.

Symmetrising along a homomorphism Let \mathcal{C} be a Markov category, and let

$$\varphi : H \rightarrow G$$

be a homomorphism between groups in \mathcal{C} . For practical purposes, φ may be thought of as a subgroup inclusion. At a high level, the problem of symmetrisation we consider is to find some mapping that converts H -equivariant morphisms to G -equivariant morphisms. Most existing work has considered the specific case where H is the trivial group, in which case H -equivariance always holds vacuously, and a mapping of this kind therefore takes as input an arbitrary morphism in \mathcal{C} , which may be regarded as an unconstrained neural network. However, in the deterministic setting, [Kab+23, Section 3.3] also provide a sufficient condition for their canonicalisation procedure also to apply for general subgroup inclusions. This allows already equivariant models to be made “more so” without inadvertently undoing other existing symmetries that are already present. We take this more general problem as our starting point, and our methodology applies uniformly for all choices of φ , including in the stochastic setting. It can also be applied compositionally by symmetrising along multiple homomorphisms in sequence, thereby building up more complex equivariance properties in a structured way.

Our approach We give a high-level overview of our symmetrisation methodology here, which relies on some concepts from category theory to state. Further background and details are given in Sections 4 and 5 below. The group H canonically gives rise to a Markov category \mathcal{C}^H , whose objects are objects of \mathcal{C} equipped with some H -action, and whose morphisms are morphisms of \mathcal{C} that are H -equivariant. We obtain a Markov category \mathcal{C}^G of G -objects and G -equivariant morphisms in a similar way. These categories are related by the functor $R_\varphi : \mathcal{C}^G \rightarrow \mathcal{C}^H$ that maps each G -object to an H -object by *restricting* its action via the homomorphism φ . Our goal is then to obtain functions of the form

$$\mathcal{C}^H(R_\varphi X, R_\varphi Y) \rightarrow \mathcal{C}^G(X, Y), \quad (4)$$

where X and Y are G -objects, and we use the standard notation $\mathsf{D}(U, V)$ to denote the set of morphisms $U \rightarrow V$ in a category D . Notice that a function of this form maps H -equivariant morphisms to G -equivariant ones, which is exactly what is desired of a symmetrisation procedure (although previous work has not framed the problem in this way).

In many familiar settings, such as when dealing with set-theoretic groups, the functor R_φ admits a left adjoint E often known as *extension* or *induction* (see e.g. [MPC97, Chapter I.1]). In this case, for all G -objects X and Y , we always obtain a bijection

$$\mathcal{C}^H(R_\varphi X, R_\varphi Y) \xrightarrow{\cong} \mathcal{C}^G(ER_\varphi X, Y). \quad (5)$$

As such, the original problem (4) becomes equivalently that of finding functions of the form

$$\mathcal{C}^G(ER_\varphi X, Y) \rightarrow \mathcal{C}^G(X, Y), \quad (6)$$

since every function (6) now gives rise to a function (4) and vice versa. In other words, whereas our original problem required us to translate H -equivariance to G -equivariance, now we only need to translate G -equivariance to (another kind of) G -equivariance, which seems more tractable. In particular, functions of the form (6) can be obtained straightforwardly by *precomposing* with any morphism of the form $X \rightarrow ER_\varphi X$ in \mathbf{C}^G . End-to-end, by applying the bijection (5) and then precomposing the result in this way, we always obtain a symmetrisation procedure of the desired form (4). This moreover applies for all G -actions in \mathbf{C} , and is therefore highly generic.

The requirement of obtaining a full left adjoint is quite strong, and in fact not necessary to obtain a bijection of the form (5). In Theorem 5.1, we provide a weaker condition that is sufficient and more convenient for practical purposes. We also show in Theorem 3.1 that this condition is satisfied for all groups and actions when \mathbf{C} is the Markov category of topological spaces and continuous Markov kernels, which seems adequate for many applications. In practice, it is also readily satisfied for many other groups of interest in other contexts, as we demonstrate through various examples. In Section 5.5, we show that the existing methods for deterministic symmetrisation mentioned above can all be recovered as instances of this approach for specific choices of \mathbf{C} . In addition, by instantiating the procedure differently, we obtain for free a novel methodology for stochastic symmetrisation. We apply this procedure to obtain the stochastically equivariant subcomponent required by [Kim+23], and show that this improves its empirical performance on a synthetic numerical example.

Outline The rest of the paper is structured as follows. In Section 2.1 we provide a brief introduction to Markov categories. We aim in particular to allow readers unfamiliar with *string diagrams* to parse these easily, as they will be used throughout the paper. In Section 3, we develop some basic concepts from group theory in the context of a general Markov category. For readers primarily interested in our methodology, this section can initially be skipped over and referred back to on an as-needed basis. In Section 4, we consider symmetrisation generally, giving the necessary definitions to formulate the problem as in (4). In Section 5, we describe our overall approach to symmetrisation based on obtaining bijections of the form (5). In Section 6, we provide various examples of how this approach can be applied for different groups and actions of interest. Finally, in Section 7, we consider implementation details and provide empirical results on a synthetic example.

2 Background on Markov categories

We provide a short introduction to Markov categories here, and refer the reader to [CJ19; Fri20] for a more detailed treatment.

2.1 Markov kernels

A Markov category can be understood as an abstraction of the key structural behaviour of *Markov kernels*, also known as stochastic maps. Given measurable spaces X and Y , recall that a Markov kernel is a function

$$k : \Sigma_Y \times X \rightarrow [0, 1], \tag{7}$$

where Σ_Y denotes the σ -algebra of Y , such that $x \mapsto k(B|x)$ is measurable for each $B \in \Sigma_Y$, and $B \mapsto k(B|x)$ is a probability measure for each $x \in X$. The idea is that Markov kernels formalise the notion of a conditional probability distribution in a rigorous, measure theoretic way, thereby allowing more careful reasoning than is permitted by the usual “density” notation $p(y|x)$ often used in applications. In what follows, we will denote the probability measure $B \mapsto k(B|x)$ more suggestively using “infinitesimal” notation. So, for example,

$$\mathbf{Y} \sim k(dy|x)$$

denotes a Y -valued random variable sampled from k given the input $x \in X$. In addition, rather than writing out the full signature of a Markov kernel as in (7), we will simply write

$$k : X \rightarrow Y.$$

This emphasises the interpretation of Markov kernels as stochastic maps, with X and Y regarded as the *domain* and *codomain* of k respectively. Following other work on Markov categories, we will also represent this graphically using *string diagrams* [Sel10] as follows:

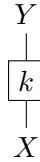

We will follow the same conventions as [CJ19, Section 2] when denoting string diagrams, so that in particular these should always be read from bottom to top. Intuitively, a string diagram represents a *generative process*, with each box denoting some kind of (potentially stochastic) operation or computation, and whose wires track the flow of information, with time flowing upwards. Such diagrams are used informally throughout the machine learning literature already when describing (for example) neural network architectures, and readers will likely find themselves comfortable with this notation after seeing the examples below.

2.2 The Markov category Stoch

The prototypical example of a Markov category is **Stoch**, the Markov category of measurable spaces and Markov kernels. We describe the structure of this Markov category now. Our description will be somewhat informal, emphasising the “sampling” or “generative” interpretation of Markov kernels rather than their rigorous definition as functions of the form (7). A formal treatment can be found in [Fri20, Section 4].

Markov kernels $k : X \rightarrow Y$ and $m : Y \rightarrow Z$ can always be *composed sequentially* to obtain a new Markov kernel $m \circ k : X \rightarrow Z$. We sample from $(m \circ k)(dz|x)$ by sampling

$$\mathbf{Y} \sim k(dy|x) \quad \mathbf{Z} \sim m(dz|\mathbf{Y})$$

and then returning Z . This makes sense whenever the codomain of k matches the domain of m . In string diagrams, $m \circ k$ is represented as follows:

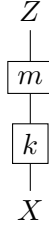

For every measurable space X , there is also an *identity* kernel $\text{id}_X : X \rightarrow X$ that simply returns its input. In string diagrams, this is drawn simply as a wire:



However, there is more structure at play here. Given two measurable spaces X and Y , we can always form the product measurable space, denoted $X \otimes Y$. Now suppose we have two Markov kernels $k : X \rightarrow Y$ and $m : U \rightarrow V$. We can then always obtain a new Markov kernel $k \otimes m : X \otimes U \rightarrow Y \otimes V$ between these product spaces by *parallel composition*, or in other words by sampling from each kernel independently. That is, to sample from $(k \otimes m)(dy, dv|x, u)$, we independently sample

$$Y \sim k(dy|x) \quad V \sim m(dv|u),$$

and then just return the pair (Y, V) . In string diagrams, $k \otimes m$ is denoted

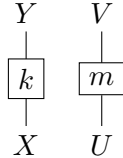

In addition, for any two measurable spaces X and Y , there is also always a kernel $\text{swap}_{X,Y} : X \otimes Y \rightarrow Y \otimes X$ that deterministically *swaps* its two inputs, so that given an input (x, y) , it simply returns (y, x) . In string diagrams, $\text{swap}_{X,Y}$ is denoted suggestively as



While this may seem like a trivial operation, these kernels perform a fundamental role: they allow us to reorganise the layout of a string diagram in any way we want, provided we do not change its overall topology (so each box is connected to the same inputs and outputs before and afterwards). A similarly trivial but very useful operation is *copying*: for any

measurable space X , there is a Markov kernel $\text{copy}_X : X \rightarrow X \otimes X$ that, when given x as input, returns the pair (x, x) . In string diagrams, we denote this kernel as:

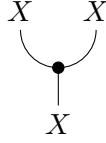

Finally, let I denote the trivial measurable space consisting of the singleton set $\{\bullet\}$ equipped with the trivial σ -algebra. Then for any measurable space X , there is always a (unique) Markov kernel $\text{del}_X : X \rightarrow I$. We represent this in string diagrams as:



and understand this as the Markov kernel that simply *discards* its input. The trivial space I also plays another useful role: kernels $p : I \rightarrow X$ encode a single probability distribution $p(dx|\bullet)$, which allows us to recover *unconditional* distributions as a special case of Markov kernels. In string diagrams, we denote these kernels without an input wire as follows:

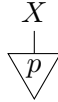

2.3 Markov categories

The general definition of a *Markov category* axiomatises the behaviour of Markov kernels described in the previous section. We provide a high-level overview here, and refer the reader to [Fri20, Definition 2.1] for a rigorous definition. Instead of measurable spaces and Markov kernels, the data of a general Markov category \mathbf{C} consists of a collection of *objects* and a collection of *morphisms*. Like we did for Markov kernels, we denote these morphisms by $k : X \rightarrow Y$, where X and Y are objects in \mathbf{C} referred to as the *domain* and *codomain* of k respectively. We can compose morphisms sequentially (provided they are compatibly typed), and each object X comes equipped with an identity morphism id_X . For any pair of objects X and Y , we can form their *monoidal product* $X \otimes Y$, which plays the role of the product measurable space. We can then compose morphisms k and m in parallel to obtain a new morphism $k \otimes m$ between the monoidal products of their domains and codomains. There is also a distinguished object I referred to as the *monoidal unit* that plays the role of the singleton set, as well as morphisms for swapping, copying, and deleting information. We depict all these constructions using string diagrams in just the same way as we did for Markov kernels.

The formal definition of a Markov category includes additional axioms that ensure these constructions behave like Markov kernels do. For example, it always holds that:

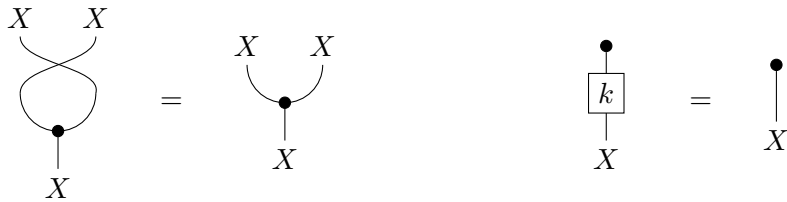

The first condition says that copying some input and then swapping the result is the same as just copying the input. The second condition says that sampling from k given some input and then discarding the result is the same as just discarding the input. Both are intuitively always true for Markov kernels, at least when these are regarded informally as generative processes. We will perform similar manipulations throughout the paper, which can also be understood by analogy with Markov kernels in this way.

2.4 Examples of Markov categories

The Markov category **Stoch** described in Section 2.2, whose objects are measurable spaces and whose morphisms are Markov kernels, will serve as a key example throughout the paper. However, there are other interesting Markov categories beyond this. For our purposes, it will also be relevant to consider **TopStoch** [Fri+23b, Example A.1.4], whose objects are topological spaces and whose morphisms are *continuous* Markov kernels, where a Markov kernel between topological spaces $k : X \rightarrow Y$ is continuous if for every open subset $U \subseteq Y$, the function $x \mapsto k(U|x)$ is lower semicontinuous [FPR21, Section 4]. The monoidal product \otimes returns the product topological space, the monoidal unit I is the singleton topological space, and the remaining components are defined analogously as for **Stoch**. Our main reason for interest in **TopStoch** is that it allows us to prove Theorem 3.1 below, whereas we are not sure whether the analogous result holds for **Stoch**. For practical purposes, **TopStoch** is still very general, since neural networks used in practice are almost invariably continuous.

Beyond these, more basic examples of Markov categories include: **Set**, whose objects are sets and whose morphisms are functions; **Meas**, whose objects are measurable spaces and whose morphisms are measurable functions; and **Top**, whose objects are topological spaces and whose morphisms are continuous functions. For **Set**, the monoidal product is just the cartesian product and the monoidal unit is the singleton set. For **Meas** and **Top** these are similar, but are now equipped with suitable σ -algebras and topologies respectively. That these are indeed Markov categories follows from [Fri20, Remark 2.4]. For the purposes of modelling stochastic phenomena, these examples are clearly less interesting than **Stoch** and **TopStoch**, but they will be useful for examples and intuition in what follows.

Remark 2.1. All the preceding examples are *positive* Markov categories [FR20, Definition 11.22]. This is a mild technical condition that, roughly speaking, ensures *determinism* (see below) has various implications that we would expect. That **Stoch** is positive is shown in [FR20, Example 11.25], and this in turn also implies that **TopStoch** is positive [FR20, Remark 11.26]. It is also straightforward to show that **Set**, **Meas**, and **Top** are all positive too. We will only make use of this condition in a few places. The point of this remark is that, when we do, we will not have sacrificed much generality for practical purposes.

2.5 Determinism

Following [Fri20, Definition 10.1], we will say that a morphism $f : X \rightarrow Y$ in a Markov category \mathbf{C} is *deterministic* if it holds that

Intuitively, this says that repeated independent samples from f are always the same. For example, in **Stoch**, if f is deterministic and we sample independently

$$\mathbf{Y}, \mathbf{Y}' \stackrel{\text{iid}}{\sim} f(dy|x),$$

then $(\mathbf{Y}, \mathbf{Y}) \stackrel{d}{=} (\mathbf{Y}, \mathbf{Y}')$, where notice that the random variable \mathbf{Y} appears twice on the left-hand side. By [Fri20, Example 10.4], a Markov kernel is deterministic if and only if it is zero-one, so that $f(B|x) \in \{0, 1\}$ for all measurable $B \subseteq Y$ and $x \in X$.

Remark 2.2. Every measurable function $f : X \rightarrow Y$ gives rise to a deterministic Markov kernel $k_f : X \rightarrow Y$. Formally, this is defined as

$$k_f(B|x) := \delta_{f(x)}(B) \tag{8}$$

for all measurable $B \subseteq Y$ and $x \in X$, where δ_y denotes the Dirac measure at $y \in Y$. In this way, the morphisms of **Meas** may be regarded as deterministic morphisms in **Stoch** also. A similar story is also true for **Top** and **TopStoch**, where it is straightforward to show that (8) becomes a lower semicontinuous Markov kernel whenever f is continuous.

Remark 2.3. By [Fri20, Remark 10.13], the deterministic morphisms themselves always form a Markov category contained in \mathbf{C} , which we denote by \mathbf{C}_{det} .

3 Group theory in Markov categories

We now show how various concepts from basic group theory can be considered in the context of a general Markov category. This section can be read somewhat nonlinearly and referred back to as definitions appear in later sections.

3.1 Groups, homomorphisms, and actions

We begin by providing the basic definitions of group theory internal to a general Markov category. A feature of our approach is that we require the various group operations all to be *deterministic*. This allows us to recover standard results from set-theoretic group theory that might otherwise not hold in a general Markov category. We discuss this in more detail in Remark 3.2 below.

Definition 3.1. A group in a Markov category \mathcal{C} consists of an object G and deterministic morphisms $* : G \otimes G \rightarrow G$, $e : I \rightarrow G$, and $(-)^{-1} : G \rightarrow G$ in \mathcal{C} that satisfy the following:

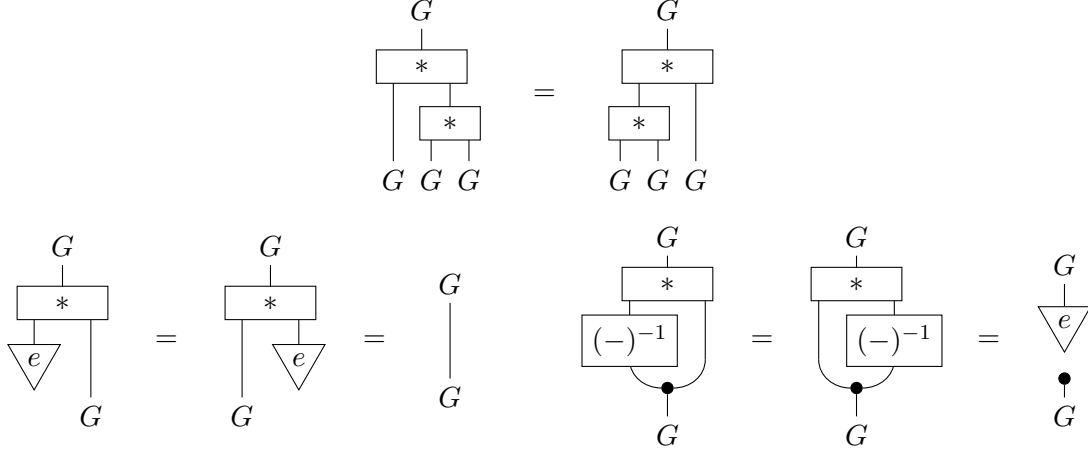

To streamline notation, we will refer to the overall group simply as G , leaving its operations implicit. We will also mostly reuse the same symbols $*$, e , and $(-)^{-1}$ to denote these operations across all groups, even when these may be distinct. When we need to disambiguate, we will use a subscript, e.g. $*_G$ for the multiplication operation of G .

Example 3.1. We spell out how this relates to the classical definition of a group. Under Definition 3.1, a group in \mathbf{Set} is a set G equipped with functions $*$, e and $(-)^{-1}$. Writing $*(g, h)$ simply as gh , the first axiom here says

$$(gh)n = g(hn)$$

for all $g, h, n \in G$. In other words, $*$ is *associative*. Similarly, recall that I in \mathbf{Set} is the singleton set $\{\bullet\}$, and so $e : I \rightarrow G$ encodes a unique value $e(\bullet)$. Denoting $e(\bullet)$ simply as e , the second axiom says

$$eg = ge = g$$

for all $g \in G$, and hence e serves as the *unit*. Finally, writing $(-)^{-1}(g)$ as g^{-1} , the third axiom says

$$g^{-1}g = gg^{-1} = e$$

for all $g \in G$. In other words, every element in G has an *inverse*. This shows that groups in \mathbf{Set} in the sense of Definition 3.1 are precisely groups in the classical sense.

In what follows, we will denote the multiplication, unit, and inversion operations of groups in \mathbf{Set} in the same traditional way as we do here. We will do the same for groups in \mathbf{Meas} and \mathbf{Top} (discussed next), where this notation also makes sense.

Example 3.2. For other Markov categories whose morphisms are functions, such as \mathbf{Meas} and \mathbf{Top} , a similar story to Example 3.1 applies. However, in these cases, the group operations are more restricted than in \mathbf{Set} , since they are required to be morphisms of the ambient category. For example, group operations in \mathbf{Meas} are required to be measurable functions, and group operations in \mathbf{Top} are required to be continuous functions. This is very

natural: for example, in probability theory it is standard to study *measurable groups* (e.g. [Kal02, Page 15]), which exactly correspond to groups in **Meas** here.

In **Stoch** and **TopStoch**, the situation is slightly different, since the group operations here are technically Markov kernels rather than functions. However, by Proposition 3.5 below, groups in **Meas** and **Top** can always be regarded as groups in **Stoch** and **TopStoch** by lifting their operations to deterministic Markov kernels as in (8). All the concrete examples of groups in **Stoch** and **TopStoch** that we consider will be obtained in this way.

Example 3.3. In any Markov category \mathbf{C} , the unit I is always a group, regarded as the *trivial group*. This is clear in **Set**: the trivial group is simply the singleton set $\{\bullet\}$, and there is only one possible choice for each group operation, and the group axioms hold immediately. For general \mathbf{C} , the same idea holds because I is a terminal object [Fri20, Remark 2.3]. Alternatively, this also follows from the case of **Set** by Remark 3.2 below.

Definition 3.2. A homomorphism in a Markov category \mathbf{C} is a deterministic morphism $\varphi : H \rightarrow G$ between groups G and H in \mathbf{C} that satisfies

$$\begin{array}{c} G \\ | \\ \boxed{*} \\ | \quad | \\ \boxed{\varphi} \quad \boxed{\varphi} \\ | \quad | \\ H \quad H \end{array} = \begin{array}{c} G \\ | \\ \boxed{\varphi} \\ | \\ \boxed{*} \\ | \quad | \\ H \quad H \end{array} \quad (9)$$

Example 3.4. In **Set**, as well as in **Meas** and **Top**, the condition (9) translates as saying

$$\varphi(h) \varphi(n) = \varphi(hn)$$

for all $h, n \in H$, which recovers the usual definition of a set-theoretic homomorphism.

Remark 3.1. It is straightforward to check that the composition of homomorphisms is again a homomorphism, and that identities are homomorphisms. In this way, we naturally obtain a category whose objects are groups in \mathbf{C} and whose morphisms are homomorphisms between these.

Example 3.5. For every group G in any Markov category \mathbf{C} , there always exists a unique homomorphism $I \rightarrow G$, namely the unit operation $e : I \rightarrow G$. In **Set**, where I becomes the singleton set $\{\bullet\}$, this is a standard exercise to show. In turn, the same then holds for a general \mathbf{C} by Remark 3.2 below. In categorical terms, this says that I is an *initial object* in the category of groups in \mathbf{C} . (It is also a *terminal object* in this same category.)

Definition 3.3. Let \mathbf{C} be a Markov category. An action of a group G on an object X in \mathbf{C} (or simply a G -action) is a deterministic morphism $\alpha : G \otimes X \rightarrow X$ that satisfies

$$\begin{array}{c} X \\ | \\ \boxed{\alpha} \\ | \quad | \\ G \quad G \quad X \end{array} = \begin{array}{c} X \\ | \\ \boxed{\alpha} \\ | \\ \boxed{*} \\ | \quad | \\ G \quad G \quad X \end{array} \quad \begin{array}{c} X \\ | \\ \boxed{\alpha} \\ | \\ \triangleleft e \\ | \\ X \end{array} = \begin{array}{c} X \\ | \\ X \end{array} \quad (10)$$

Example 3.6. In \mathbf{Set} , denoting $\alpha(g, x)$ as $g \cdot x$, the first equation in (10) says that

$$g \cdot (g' \cdot x) = (gg') \cdot x \quad \text{for all } g, g' \in G \text{ and } x \in X,$$

so α is associative. The second axiom says

$$e \cdot x = x \quad \text{for all } x \in X,$$

so α is unital. As a result, actions in \mathbf{Set} are precisely group actions in the classical sense.

In what follows, we will often use the notation $g \cdot x$ to denote group actions in \mathbf{Set} more generally, as well as in \mathbf{Meas} and \mathbf{Top} , where this notation also makes sense. The specific action this refers to (α here) will always be clear from context.

Example 3.7. A basic example that will nevertheless be useful for us is the *trivial action*. For any group G and object X in a Markov category \mathbf{C} , this is defined as follows:

$$\begin{array}{c} X \\ | \\ \boxed{\varepsilon} \\ | \quad | \\ G \quad X \end{array} \quad := \quad \begin{array}{c} X \\ | \\ \bullet \\ | \\ G \quad X \end{array}$$

When $\mathbf{C} = \mathbf{Set}$, this becomes simply $g \cdot x = x$ for all $g \in G$ and $x \in X$. In what follows, we will use the same notation ε to denote all trivial actions, even though these are technically distinct morphisms for different choices of G and X .

Example 3.8. Let $\alpha_X : G \otimes X \rightarrow X$ and $\alpha_Y : G \otimes Y \rightarrow Y$ be actions in a Markov category \mathbf{C} . Then we always obtain a *diagonal action* defined as follows:

$$\begin{array}{c} X \quad Y \\ | \quad | \\ \boxed{\alpha_X} \quad \boxed{\alpha_Y} \\ | \quad | \quad | \\ \bullet \quad | \quad | \\ G \quad X \quad Y \end{array} \quad (11)$$

When $\mathbf{C} = \mathbf{Set}$, this may be written as $g \cdot (x, y) = (g \cdot x, g \cdot y)$, where $g \in G$, $x \in X$, and $y \in Y$, and some straightforward algebra shows that this is indeed an action. By Remark 3.2 below, this then also implies that (11) is an action for all \mathbf{C} , which is otherwise tedious to prove in terms of string diagrams directly.

Example 3.9. By comparing Definition (3.1) and Definition (3.3), it can be seen that for any group G in a Markov category \mathbf{C} , its multiplication operation $* : G \otimes G \rightarrow G$ is always an action. In other words, every group acts on itself by left multiplication. Additionally, every group acts on itself by the following action, which corresponds to right multiplication by the inverse:

$$\begin{array}{c} G \\ | \\ \boxed{*_{\text{op}}} \\ | \quad | \\ G \quad G \end{array} \quad = \quad \begin{array}{c} G \\ | \\ \boxed{*} \\ | \quad | \\ \boxed{(-)^{-1}} \\ | \quad | \\ G \quad G \end{array}$$

For example, in \mathbf{Set} , this is associative because

$$g \cdot (h \cdot n) = nh^{-1}g^{-1} = n(gh)^{-1} = (gh) \cdot n$$

for all $g, h, n \in G$. Unitality is similarly straightforward. This in fact also shows that $*_{\text{op}}$ is an action for all Markov categories \mathbf{C} , as we explain in Remark 3.2 below.

Remark 3.2. All the morphisms involved in the previous definitions are deterministic. At a high level, we do this in order to ensure that all the familiar results from set-theoretic group theory apply in our context also. In more technical terms (which are not necessary to understand in detail), we have defined groups, homomorphisms, and actions internal to the subcategory \mathbf{C}_{det} of deterministic morphisms in \mathbf{C} . Since \mathbf{C}_{det} is cartesian monoidal [Fri20, Remark 10.13], equations involving these constructions in \mathbf{Set} can be lifted directly to equations in \mathbf{C}_{det} (and hence \mathbf{C}) also. This is a standard technique that makes use of the Yoneda embedding: the idea is that a diagram in \mathbf{C} commutes if and only if its image under the Yoneda embedding does, which reduces to a question about set-theoretic groups, homomorphisms, and actions. Note however that this approach relies on the fact that

$$\mathbf{C}_{\text{det}}(X, Y \otimes Z) \cong \mathbf{C}_{\text{det}}(X, Y) \times \mathbf{C}_{\text{det}}(X, Z),$$

which holds because \mathbf{C}_{det} is cartesian monoidal. The corresponding statement is not always true for \mathbf{C} itself, and more care is required when reasoning by analogy with \mathbf{Set} in that case.

As an example of this technique, recall that for all groups G in \mathbf{Set} and all actions $\alpha : G \otimes X \rightarrow X$ of G , where X may be any set, we have

$$g \cdot (g^{-1} \cdot x) = (gg^{-1}) \cdot x = e \cdot x = x \quad \text{for all } g \in G \text{ and } x \in X. \quad (12)$$

By the applying the Yoneda embedding in this way, the corresponding equation in \mathbf{C}_{det} then follows automatically, namely:

$$= \begin{array}{c} X \\ | \\ \bullet \\ G \end{array} \quad \begin{array}{c} X \\ | \\ X \end{array} \quad (13)$$

We will often use this technique to simplify our presentation, providing set-theoretic justifications like (12) for equations like (13) that hold in a general Markov category. If this appears too opaque, then our set-theoretic proofs may alternatively be thought of as a convenient shorthand for the “real” proofs in terms of string diagrams (which can be more

tedious to write out).¹ For example, (12) translates directly to string diagrams as follows:

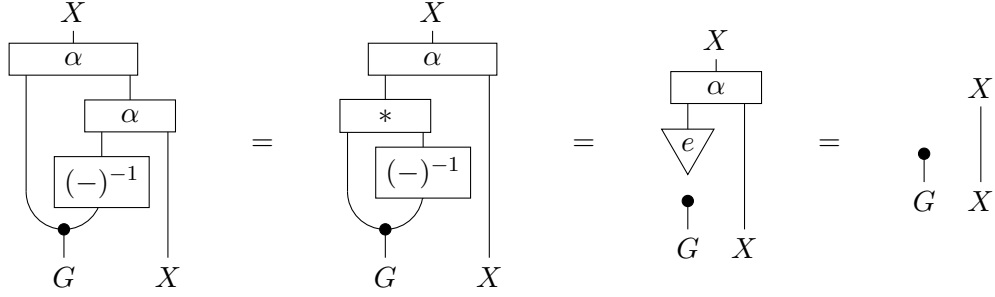

Here we apply the associativity axiom from Definition 3.3, then the inversion axiom from Definition 3.1, and finally the unital axiom from Definition 3.3.

3.2 Equivariance and invariance

The previous definitions suggest an obvious notion of equivariance given next. Notice that, whereas before we defined everything in terms of deterministic morphisms, the notion of equivariance here now applies to all morphisms in \mathbf{C} .

Definition 3.4. Suppose $\alpha_X : G \otimes X \rightarrow X$ and $\alpha_Y : G \otimes Y \rightarrow Y$ are actions in a Markov category \mathbf{C} . A morphism $k : X \rightarrow Y$ in \mathbf{C} is G -equivariant (or simply equivariant) with respect to α_X and α_Y if it holds that

$$\begin{array}{c} Y \\ \boxed{k} \\ \alpha_X \\ \begin{array}{c} | \\ G \end{array} \quad \begin{array}{c} | \\ X \end{array} \end{array} = \begin{array}{c} Y \\ \alpha_Y \\ \begin{array}{c} | \\ G \end{array} \quad \begin{array}{c} \boxed{k} \\ | \\ X \end{array} \end{array} \quad (14)$$

We will say that k is invariant if this holds when α_Y is the trivial action ε .

Example 3.10. In \mathbf{Set} , the morphism k is just a function $X \rightarrow Y$, and k is equivariant if

$$k(g \cdot x) = g \cdot k(x)$$

for all $g \in G$ and $x \in X$. For invariance, this becomes instead $k(g \cdot x) = k(x)$. In both cases, we recover the classical definitions.

Example 3.11. Importantly for our purposes, Definition 3.4 also applies directly to the stochastic setting. In \mathbf{Stoch} (for example), the condition (14) says that

$$\int k(B|x') \alpha_X(dx'|g, x) = \int \alpha_Y(B|g, y) k(dy|x)$$

for all measurable $B \subseteq Y$, $g \in G$, and $x \in X$. Our primary case of interest obtains α_X and α_Y by lifting the actions of some group in \mathbf{Meas} via Proposition 3.5 below. In this case, the condition (14) becomes

$$k(dy|g \cdot x) = (g \cdot k)(dy|x)$$

¹The cartesian monoidal structure of \mathbf{C}_{det} in fact allows this correspondence to be made rigorous also. See e.g. [Lei08] for a discussion.

for all $g \in G$ and $x \in X$, where $(g \cdot k)(dy|x)$ denotes the pushforward of $k(dy|x)$ by the function $y \mapsto g \cdot y$. This recovers the original equivariance condition (3) that we gave for stochastic neural networks at the beginning of the paper.

In the machine learning literature, stochastic equivariance is often defined in a slightly different way. In particular, a conditional *density* $p(y|x)$ is said to be equivariant if

$$p(g \cdot y|g \cdot x) = p(y|x) \tag{15}$$

for all $g \in G$, $x \in X$, and $y \in Y$ (see e.g. [Xu+22, Proposition 2.1]). This is a special case of Definition 3.4, as the following result shows.

Proposition 3.1. *Let $p(y|x)$ be conditional density given $x \in X$ with respect to some base measure μ on Y , and denote by $k : X \rightarrow Y$ the Markov kernel this induces, namely*

$$k(B|x) := \int_B p(y|x) \mu(dy)$$

where $B \subseteq Y$ is measurable and $x \in X$. Suppose G is a group acting on X and Y in Meas such that (15) holds, and that moreover $g \cdot \mu = \mu$ for all $g \in G$, where $g \cdot \mu$ denotes the pushforward of μ by the function $y \mapsto g \cdot y$. Then k is equivariant in the sense of Definition 3.4, where α_X and α_Y are obtained by lifting the actions of G to become Markov kernels via Proposition 3.5 below.

Proof. See Section A.1 of the Appendix. □

The condition $g \cdot \mu = \mu$ used here is often not made explicit in the machine learning literature. This is automatically satisfied in many cases that have appeared (e.g. [Xu+22; Hoo+22]), which take μ to be the Lebesgue measure and G to be some group of transformations with unit Jacobian, such as the orthogonal group. However, this condition may not hold for more general group actions such as scale transformations, in which case equivariance in the sense of Definition 3.4 need not follow from (15).

3.3 Compactness

Compact groups serve as a particularly useful class of groups in many applications. For practical purposes, the most important feature of these is that they admit a *Haar measure*, which is thought of as a uniform distribution over elements of the group. We use this as the basis for our definition of compactness in a general Markov category.

Definition 3.5. *A group G in a Markov category \mathbf{C} is compact if there exists a morphism $\lambda : I \rightarrow G$ in \mathbf{C} , referred to as its Haar measure, that satisfies*

$$\begin{array}{c} G \\ | \\ \boxed{*} \\ | \quad \nabla \lambda \\ G \end{array} = \begin{array}{c} G \\ | \\ \nabla \lambda \\ \bullet \\ | \\ G \end{array} \tag{16}$$

Example 3.12. Let G be a group in \mathbf{Meas} , and lift this to a group in \mathbf{Stoch} in the usual way by Proposition 3.5 below. The condition (16) says that if $\mathbf{G} \sim \lambda$, then

$$g\mathbf{G} \stackrel{d}{=} \mathbf{G}$$

for all $g \in G$. This recovers the usual definition of a (normalised) Haar measure. A standard result shows that a unique such λ exists for every compact second-countable Hausdorff topological group [Kal02, Theorem 2.27]. In particular, this is true for all finite groups, as well as the classical compact matrix groups (such as the orthogonal group).

3.4 Semidirect products

Many groups of interest in applications arise as semidirect products of simpler groups. The following definition allows us to consider these in an abstract Markov category without requiring further assumptions. We give the definition before showing how it corresponds to the usual set-theoretic definition in Example 3.13 below.

Definition 3.6. Let \mathcal{C} be a Markov category, N and H groups in \mathcal{C} , and $\rho : H \otimes N \rightarrow N$ some action of H on N such that

$$\begin{array}{c} N \\ \boxed{*_N} \\ \rho \quad \rho \\ \bullet \quad N \quad N \\ H \quad N \quad N \end{array} = \begin{array}{c} N \\ \boxed{\rho} \\ \boxed{*_N} \\ H \quad N \quad N \end{array} \quad (17)$$

The semidirect product of N and H , denoted $N \rtimes_{\rho} H$, is the group in \mathcal{C} whose underlying object is $N \otimes H$, and whose group operations $*$, e , and $(-)^{-1}$ are defined respectively as

$$\begin{array}{c} N \quad H \\ \boxed{*_N} \quad \boxed{*_H} \\ \rho \\ N \quad H \quad N \quad H \end{array} \quad \begin{array}{c} N \quad H \\ \triangleleft e_N \quad \triangleleft e_H \end{array} \quad \begin{array}{c} N \quad H \\ \boxed{\rho} \\ \boxed{(-)_N^{-1}} \quad \boxed{(-)_H^{-1}} \\ N \quad H \end{array} \quad (18)$$

Technically, we should check that these operations always satisfies the group axioms. By Remark 3.2, since all the morphisms involved are deterministic, it suffices to do so in \mathbf{Set} . The following example shows how Definition 3.6 in \mathbf{Set} corresponds to the usual set-theoretic definition of outer semidirect products, after which this becomes standard to prove.

Example 3.13. In \mathbf{Set} , an (outer) semidirect product is usually defined in terms of a homomorphism $\varphi : H \rightarrow \text{Aut}(N)$, $h \mapsto \varphi_h$, where $\text{Aut}(N)$ denotes the automorphism group of N . (Recall that this is the group of invertible homomorphisms $N \rightarrow N$ equipped with function composition as its multiplication operation.) The idea behind Definition 3.6 is that

every such φ canonically gives rise to an action ρ that satisfies (17) and vice versa. For example, in one direction we may uncurry φ to obtain

$$\rho(h, n) := \varphi_h(n) \tag{19}$$

for $h \in H$ and $n \in N$. That ρ is indeed an action follows from the fact that φ is a homomorphism, which means $\varphi_{e_H} = \text{id}_N$ and $\varphi_h \circ \varphi_{h'} = \varphi_{hh'}$, and moreover ρ satisfies (17) because each $\varphi_h : N \rightarrow N$ is itself a homomorphism. Conversely, by flipping (19) left-to-right, each action ρ that satisfies (17) also defines a homomorphism $\varphi : H \rightarrow \text{Aut}(N)$, as may be checked. Under this correspondence, the group operations (18) then also correspond to their usual set-theoretic definitions. For example, multiplication may be written as

$$(n, h) (n', h') = (n \rho(h, n'), hh')$$

where $n, n' \in N$ and $h, h' \in H$, which recovers the usual definition by replacing $\rho(h, n')$ with $\varphi_h(n')$. The usual argument for outer semidirect products in **Set** now translates directly to show that the group axioms hold, although we omit the details.

Example 3.14. The Euclidean groups $E(d)$ and $SE(d)$ are well-known examples of semidirect products. We show how these can be expressed as instances of Definition 3.6 in **Set** (although this applies equally in **Meas** and **Top**). Let \mathbb{T}^d be the group of translations, or in other words \mathbb{R}^d equipped with vector addition, and let $O(d)$ be the orthogonal group. We then obtain an action $\rho : O(d) \otimes \mathbb{T}^d \rightarrow \mathbb{T}^d$ in the obvious way with $Q \cdot t := Qt$. The condition (17) becomes $Q \cdot (t + t') = Q \cdot t + Q \cdot t'$, which is clearly satisfied. This allows us to obtain the Euclidean group as follows:

$$E(d) := \mathbb{T}_d \rtimes_{\rho} O(d).$$

For example, the group multiplication in (18) becomes

$$(t, Q) (t', Q') = (t + Qt', QQ'),$$

which recovers the usual definition. By substituting the special orthogonal group $SO(d)$ for $O(d)$, we also obtain the special Euclidean group $SE(d)$ in the same way.

Remark 3.3. The condition (17) amounts to saying that N is a group in **C** whose multiplication operation is H -equivariant, where H acts on N diagonally as in Example 3.8. For example, in **Set**, writing $*_N$ as m , this condition becomes

$$m(h \cdot n, h \cdot n') = h \cdot m(n, n')$$

for all $h \in H$ and $n, n' \in N$. By some straightforward manipulations, this in turn implies that the inversion and identity operations of N are also H -equivariant in a particular sense: we obtain $h \cdot n^{-1} = (h \cdot n)^{-1}$ and $h \cdot e_N = e_N$ in **Set**, and similar equations more generally. This gives rise to a particularly streamlined way to describe semidirect products: in terminology from Definition 4.1 below, each semidirect product $N \rtimes_{\rho} H$ in **C** corresponds to a group (N, ρ) in the Markov category \mathbf{C}^H of H -equivariant morphisms, and vice versa. This is known for example in the context of algebraic topology (see [SS22, Lemma 2.1.4]), and shows that Definition 3.6 arises very naturally, despite its apparently complex structure.

A familiar result says that actions of a classical semidirect product $N \rtimes_\rho H$ can always be computed as some H -action followed by some N -action. This translates directly to our setting as follows.

Proposition 3.2. *Let \mathbf{C} be a Markov category. Every action of a semidirect product $N \rtimes_\rho H$ on an object X in \mathbf{C} can be written in the form*

$$\begin{array}{c}
 X \\
 | \\
 \boxed{\beta} \\
 \begin{array}{l}
 | \\
 N
 \end{array}
 \quad
 \begin{array}{l}
 | \\
 \boxed{\alpha} \\
 \begin{array}{l}
 | \\
 H \quad X
 \end{array}
 \end{array}
 \end{array}
 \tag{20}$$

where $\alpha : H \otimes X \rightarrow X$ and $\beta : N \otimes X \rightarrow X$ are actions in \mathbf{C} , and moreover β satisfies:

$$\begin{array}{c}
 X \\
 | \\
 \boxed{\beta} \\
 \begin{array}{l}
 | \\
 \boxed{\rho} \quad \boxed{\alpha} \\
 \begin{array}{l}
 | \\
 H \quad N \quad X
 \end{array}
 \end{array}
 \end{array}
 =
 \begin{array}{c}
 X \\
 | \\
 \boxed{\alpha} \\
 \begin{array}{l}
 | \\
 H \quad \boxed{\beta} \\
 \begin{array}{l}
 | \\
 N \quad X
 \end{array}
 \end{array}
 \end{array}$$

Conversely, for any α and β in \mathbf{C} with these properties, (20) defines an action of $N \rtimes_\rho H$ that we will denote by $\beta \rtimes_\rho \alpha$.

Proof. After applying the correspondence from Example 3.13, this becomes standard to show in \mathbf{Set} . The result then applies more generally by Remark 3.2. \square

Example 3.15. Continuing Example 3.14, suppose we now have an action of $\text{SE}(d) = \mathbb{T}_d \rtimes \text{SO}(d)$ on an arbitrary object in \mathbf{C} . Proposition 3.2 says this can always be computed as an action of $\text{SO}(d)$ followed by an action of \mathbb{T}_d . Adopting the usual interpretation of $\text{SO}(d)$ as rotation matrices, this amounts to a rotation followed by a translation, which recovers the usual result.

As for the classical case, equivariance with respect to the action of a semidirect product is equivalent to equivariance with respect to its two induced actions separately.

Proposition 3.3. *Let \mathbf{C} be a Markov category, and $k : X \rightarrow Y$ a morphism in \mathbf{C} . Then k is equivariant with respect to some actions $\beta_X \rtimes_\rho \alpha_X$ and $\beta_Y \rtimes_\rho \alpha_Y$ of a semidirect product $N \rtimes_\rho K$ in \mathbf{C} if and only if it is both 1) equivariant with respect to α_X and α_Y , and 2) equivariant with respect to β_X and β_Y .*

Proof. We sketch the main idea. That N - and K -equivariance implies $(N \rtimes_\rho K)$ -equivariance follows immediately from two applications of the definition of equivariance. Conversely, since group actions are unital, every action of the form (20) becomes an N -action when e_K is attached its K -input, and a K -action when e_N is attached to its N -input. As such, $(N \rtimes_\rho K)$ -equivariance implies both N - and K -equivariance. \square

3.5 Direct products

An important special case of semidirect products is the direct product. We give this its own definition as follows.

Definition 3.7. Let G and H be groups in a Markov category \mathbf{C} . The direct product of G and H , denoted $G \times H$, is the group in \mathbf{C} consisting of $G \otimes H$ equipped with $*$, e , and $(-)^{-1}$ defined respectively as

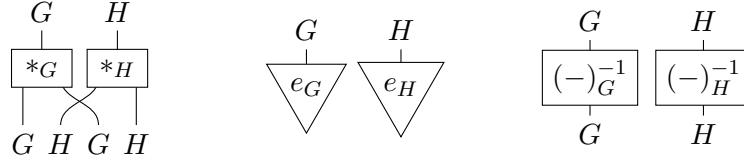

Notice that, as classically, this is just a special case of the semidirect product where the action of H on N is trivial. That is, $N \times H = N \rtimes_{\varepsilon} H$. In this case, the equivariance condition (17) is trivially satisfied, and so $N \times H$ is always a group in \mathbf{C} since $N \rtimes_{\varepsilon} H$ is.

Example 3.16. Suppose G and H are groups in \mathbf{Set} . Then $G \times H$ consists of pairs (g, h) with $g \in G$ and $h \in H$. Multiplication, identities, and inverses are all computed componentwise, so that for example

$$(g, h)(g', h') = (gg', hh')$$

where $g, g' \in G$ and $h, h' \in H$, which recovers the usual definition.

Remark 3.4. By specialising Proposition 3.2 to this context, it holds that actions of a direct product $G \times H$ on an object X correspond bijectively to pairs of actions $\alpha : G \otimes X \rightarrow X$ and $\beta : H \otimes X \rightarrow X$ such that

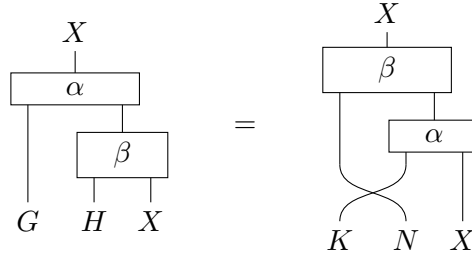

That is, an action of $G \times H$ is simply a pair of an G - and a H -action that commute with each other. Likewise, by specialising Proposition 3.3, it holds that equivariance with respect to $G \times H$ is equivalent to equivariance with respect to G and H separately.

3.6 Orbits

A classical result from group theory is that the action of a group G on a set X always induces an equivalence relation on X , with $x \sim x'$ when $x = g \cdot x'$ for some $g \in G$. The equivalence classes $[x]$ obtained in this way are referred to as *orbits*. The following definition allows us to talk about orbits in the context of Markov categories also.

Definition 3.8. Let $\alpha : G \otimes X \rightarrow X$ be an action in a Markov category \mathbf{C} . An orbit map is a deterministic morphism $q : X \rightarrow X/G$, where X/G may be any object of \mathbf{C} , such that the following is a coequaliser diagram in \mathbf{C}

$$G \otimes X \begin{array}{c} \xrightarrow{\alpha} \\ \xrightarrow{\varepsilon} \end{array} X \xrightarrow{q} X/G \quad (21)$$

that is moreover preserved by the functor $(-) \otimes Y$ for every Y in \mathbf{C} .

Coequalisers are a standard construction in category theory, and are often used as a way to talk about *quotients* in an abstract setting. We provide the main idea here. For (21) to be a coequaliser diagram, two conditions must hold. First, q must satisfy $q \circ \alpha = q \circ \varepsilon$, where recall that ε is the trivial action from Example 3.7. In string diagrams this becomes

$$\begin{array}{c} X/G \\ \downarrow q \\ \boxed{\alpha} \\ \downarrow \downarrow \\ G \quad X \end{array} = \begin{array}{c} X/G \\ \downarrow q \\ \bullet \\ \downarrow \\ G \quad X \end{array}$$

which just says that q is *invariant* with respect to α . In addition, q must be *universal* with this property in the sense that if $k : X \rightarrow Z$ is any other invariant morphism in \mathbf{C} , then there is a unique morphism $k/G : X/G \rightarrow Z$ such that the following diagram commutes:

$$\begin{array}{ccc} X & \xrightarrow{q} & X/G \\ & \searrow k & \downarrow \text{---} k/G \\ & & Z \end{array}$$

Intuitively, this says that q is the most information-preserving invariant morphism out of X , since any other invariant morphism can be computed in some way in terms of its output. For a more detailed discussion of coequalisers, we refer the reader to [Per21, Section 3.4.2].

Remark 3.5. The requirement that q is deterministic is a fairly natural one, as the examples below will show. Our main technical reason for imposing it is for the proof of Proposition 3.4 below. In practice, determinism is not a major restriction. For example, if \mathbf{C} is positive and (21) is a coequaliser diagram, then q is automatically deterministic, and so this does not need to be checked separately. This is true more generally for all coequalisers of deterministic morphisms: see Proposition A.1 in the Appendix.

Remark 3.6. We briefly comment on the preservation condition in Definition 3.8. For practical purposes, this may be understood as a mild technical requirement that ensures parallel compositions of orbit maps are well-behaved. For various \mathbf{C} of interest we can even avoid checking this condition altogether (see Remark 3.8 below). Its key implication is that orbit maps are closed under parallel composition with identity morphisms (which are themselves always orbit maps by Example 3.18 below). In other words, if q is an orbit map with respect to $\alpha : G \otimes X \rightarrow X$, then $q \otimes \text{id}_Y$ is also an orbit map, where G acts on X via α and on Y trivially. See Proposition A.2 in the Appendix for a proof.

Example 3.17. Consider what Definition 3.8 means in **Set**. Let $X/G := \{[x] \mid x \in X\}$ be the set of orbits induced by α , and let $q : X \rightarrow X/G, x \mapsto [x]$ map each element to its orbit. We claim that q is an orbit map. Certainly it is deterministic. We need to show that it is also a coequaliser, or in other words that it is invariant with respect to α , and universal. Invariance is straightforward since

$$q(g \cdot x) = [g \cdot x] = [x] = q(x)$$

by the definition of orbits. For universality, if f is any other invariant function, then $f/G : X/G \rightarrow Y$ defined as $[x] \mapsto f(x)$ is well-defined and invariant, and moreover

$$f(x) = (f/G)([x]) = (f/G)(q(x)),$$

which shows $f = f/G \circ q$. Moreover, since q is surjective, f/G is the only function that can satisfy this, and so it follows that q is a coequaliser.

Finally, to be an orbit map, we must show that q is preserved by every functor $(-) \otimes Y$. Recall that this functor sends each object Z in \mathbf{C} to $Z \otimes Y$, and each morphism f to $f \otimes \text{id}_Y$. The image of (21) under this functor is therefore

$$(G \otimes X) \otimes Y \begin{array}{c} \xrightarrow{\alpha \otimes \text{id}_Y} \\ \xrightarrow{\varepsilon \otimes \text{id}_Y} \end{array} X \otimes Y \xrightarrow{q \otimes \text{id}_Y} X/G \otimes Y \quad (22)$$

and we want to show that this is also a coequaliser diagram. This can be done using a similar argument as we just gave. (In fact, what we showed is really a special case of this more general statement with $Y := I$ the singleton set.) As a result, q is an orbit map.

Example 3.18. For any group G acting trivially on an object X in a Markov category \mathbf{C} , the identity id_X is always an orbit map. Indeed, it is easily checked that the following is a coequaliser diagram:

$$G \otimes X \begin{array}{c} \xrightarrow{\varepsilon} \\ \xrightarrow{\varepsilon} \end{array} X \xrightarrow{\text{id}_X} X \quad (23)$$

Moreover, this is preserved by every functor $(-) \otimes Y$ since we have $\text{id}_X \otimes \text{id}_Y = \text{id}_{X \otimes Y}$. Although trivial, this example will nevertheless be useful for us in what follows.

Remark 3.7. Often there will exist more than one possible choice of orbit map for the same group action. For example, consider the rotation group $G := \text{SO}(2)$ acting on the plane \mathbb{R}^2 in **Set**. By checking the various requirements, it follows that the function $r : \mathbb{R}^2 \rightarrow [0, \infty), x \mapsto \|x\|$ is an orbit map. This is a different construction to the orbit map $q : X \rightarrow X/G$ from Example 3.17, where X/G was defined as a set of equivalence classes. However, in another sense, these two orbit maps are equivalent: a straightforward argument shows that there exists a unique bijection $X/G \rightarrow [0, \infty)$ such that the following commutes:

$$\begin{array}{ccc} X & \xrightarrow{q} & X/G \\ & \searrow r & \downarrow \cong \\ & & [0, \infty) \end{array}$$

In this way, r and q describe the same information, just with different “encodings”. More generally, as a consequence of the Yoneda Lemma, if q and r are orbit maps with respect to the same group action in a Markov category \mathbf{C} , then there always exists a unique isomorphism ϕ such that $r = \phi \circ q$ holds. For practical purposes, this means we are free to choose whichever orbit map is most convenient, and will not sacrifice generality in doing so.

It is not guaranteed that a Markov category will admit all orbit maps: there may exist some α for which a coequaliser diagram (21) does not exist, or is not preserved by every functor $(-) \otimes Y$. We therefore consider examples in which orbit maps are always available.

Example 3.19. \mathbf{Set} admits all orbit maps. This is shown directly by Example 3.17. More abstractly, this can be seen by noting that \mathbf{Set} has coequalisers and is cartesian closed, which means $(-) \otimes Y$ is a left adjoint and hence cocontinuous (see e.g. [Per21, Corollary 4.3.2]). The same idea applies more generally: a Markov category \mathbf{C} admits all orbit maps if it has coequalisers (or even reflexive coequalisers) and is monoidal closed.

Example 3.20. \mathbf{Top} admits all orbit maps. Unlike with \mathbf{Set} , a quick abstract proof is less obvious to us here, but a standard lower-level argument can be used instead. For completeness, we include this in Proposition A.3 in the Appendix.

In both \mathbf{Set} and \mathbf{Top} , every morphism is deterministic. For reasoning about stochastic neural networks, we would like a Markov category that admits all orbit maps, but also more general morphisms. The following provides a convenient and very general example.

Theorem 3.1. *Every action in $\mathbf{TopStoch}$ admits an orbit map.*

Proof. See Section A.4 of the Appendix. □

We do not know whether \mathbf{Meas} or \mathbf{Stoch} admit all orbit maps. In \mathbf{Meas} , it is true that every action gives rise to a coequaliser (21) obtained from the usual measure-theoretic quotient space. A similar statement also holds in \mathbf{Stoch} as a consequence of [MP23, Proposition 3.7]. However, in both cases, we were not able to prove that these coequalisers are always preserved by the functor $(-) \otimes Y$, which our theory below requires.

Remark 3.8. For our symmetrisation methodology below, we will need to construct orbit maps more explicitly than these existence results provide. However, it is still practically useful to know that some orbit map does indeed exist. A straightforward argument shows that if an action α admits some orbit map, then every coequaliser of the form (21) automatically satisfies the preservation condition and is therefore an orbit map. See Proposition A.8 in the Appendix. As such, to show a morphism is an orbit map in $\mathbf{TopStoch}$ (for example), we just need to establish the coequaliser condition: the preservation condition does not need to be checked separately.

3.7 Cosets

In set-theoretic group theory, a subgroup H of a group G gives rise to a set of (left) cosets, whose elements have the form $gH := \{gh \mid h \in H\}$ where $g \in G$. The following definition allows us to talk about cosets in general Markov categories also.

Definition 3.9. Let $\varphi : H \rightarrow G$ be a homomorphism in a Markov category \mathcal{C} . A φ -coset map is an orbit map with respect to the following action of H on G :

$$\begin{array}{c}
 G \\
 | \\
 \boxed{*_{\text{op}}} \\
 | \quad | \\
 \boxed{\varphi} \quad | \\
 H \quad G
 \end{array} \tag{24}$$

In terminology introduced in Definition 4.2 below, the morphism (24) is just the restriction via φ of the action $*_{\text{op}}$ from Example 3.9, and is therefore indeed always an action.

Example 3.21. In Set , Definition 3.9 recovers cosets in the usual sense by letting $\varphi : H \rightarrow G$ be a subgroup inclusion, so that $\varphi(h) = h$. The action (24) becomes

$$h \cdot g = g \varphi(h)^{-1} = gh^{-1}$$

for $h \in H$ and $g \in G$. The cosets of H in G are then exactly the orbits obtained from this action, since we have

$$gH = \{gh \mid h \in H\} = \{gh^{-1} \mid h \in H\} = \{h \cdot g \mid h \in H\},$$

and the right-hand side is seen to be the orbit of g . Letting G/H be the set of these cosets, it now follows from Example 3.17 that the function $G \rightarrow G/H$ defined as $g \mapsto gH$ is an orbit map, and hence a φ -coset map.

Remark 3.9. We will often use the same suggestive notation G/H from Example 3.21 to denote the codomain of a φ -coset map, where $\varphi : H \rightarrow G$ is a homomorphism in a general Markov category \mathcal{C} . However, we emphasise that this is not meant to imply G/H is a quotient *group* in any sense. In particular, recall that G/H from Example 3.21 does not inherit a group structure unless H is a *normal* subgroup. Instead, G/H should be thought of simply as a space of orbits (or more specifically, cosets) without associated group operations. This makes sense to consider regardless of any additional properties H may have.

Example 3.22. Let G be a group in a Markov category \mathcal{C} , and $\varphi : I \rightarrow G$ the unique homomorphism out of the trivial group from Example 3.3. Then (24) becomes trivial. By Example 3.18, it follows that $\text{id}_G : G \rightarrow G$ is an orbit map, and hence a φ -coset map.

Example 3.23. Let $N \rtimes_{\rho} H$ be a semidirect product in a Markov category \mathcal{C} . Recall from Definition 3.6 that this has $N \otimes H$ as its underlying object. We therefore always obtain inclusion and projection morphisms

$$\begin{array}{ccc}
 N & \xrightarrow{i_N} & N \rtimes_{\rho} H & \xleftarrow{i_H} & H \\
 & \xleftarrow{p_N} & & \xrightarrow{p_H} &
 \end{array}$$

where for example

$$\begin{array}{ccc}
 \begin{array}{c} N \quad H \\ | \quad | \\ \boxed{i_N} \\ | \\ N \end{array} & := & \begin{array}{c} N \quad H \\ | \quad | \\ \triangle e_H \\ | \\ N \end{array} & \quad & \begin{array}{c} N \\ | \\ \boxed{p_N} \\ | \quad | \\ N \quad H \end{array} & := & \begin{array}{c} N \\ | \\ N \quad \bullet \\ | \quad | \\ N \quad H \end{array}
 \end{array}$$

and i_H and p_H are similar. By a straightforward argument, both i_N and i_H are homomorphisms. Moreover, p_H is a i_N -coset map, and p_N is a i_H -coset map. See Proposition A.9 in the Appendix. Heuristically, this says that $(N \rtimes_\rho H)/N \cong H$ and $(N \rtimes_\rho H)/H \cong N$, so that after “quotienting out” one factor, we are left with the other.

Example 3.24. Let $\varphi : O(d) \rightarrow GL(d, \mathbb{R})$ be the inclusion homomorphism of the orthogonal group into the general linear group in \mathbf{Set} (for example). Let $PD(d)$ denote the set of d -dimensional positive-definite matrices, and define $q : GL(d, \mathbb{R}) \rightarrow PD(d)$ by $A \mapsto AA^T$. Then q is a φ -coset map. Indeed, this is invariant because

$$q(AQ^{-1}) = AQ^TQA^T = AA^T$$

whenever Q is orthogonal. Now suppose r is also invariant. For $A \in GL(d, \mathbb{R})$ a standard matrix decomposition allows us always to write $A = RQ$ for some orthogonal Q and upper triangular R , which yields

$$r(A) = r(RQ) = r(R) = r(\text{Chol}(RR^T)) = r(\text{Chol}(AA^T)) = r(\text{Chol}(q(A))),$$

where Chol denotes the Cholesky decomposition. This shows that $r(A)$ can be expressed as a function of $q(A)$, and this function must be unique since q is surjective. By Remark 3.8, the preservation condition now holds automatically, and so q is a φ -coset map.

3.8 Coset actions

If $\varphi : H \rightarrow G$ is a homomorphism, then by definition every φ -coset map is H -invariant. However, importantly, a φ -coset map also becomes G -equivariant in a canonical way.

Proposition 3.4. *Let $q : G \rightarrow G/H$ be a φ -coset map. There exists a unique action $*/H : G \otimes G/H \rightarrow G/H$ that makes q equivariant in the sense that*

$$\begin{array}{c} G/H \\ \downarrow \\ \boxed{q} \\ \downarrow \\ \boxed{*} \\ \downarrow \quad \downarrow \\ G \quad G \end{array} = \begin{array}{c} G/H \\ \downarrow \\ \boxed{*/H} \\ \downarrow \quad \downarrow \\ \boxed{q} \\ \downarrow \\ G \quad G \end{array}$$

Proof. See Section A.7.1 of the Appendix. □

Example 3.25. Continuing Example 3.21, the action of G on G/H is given by

$$g \cdot (g'H) = (gg')H.$$

It is straightforward to check that this is well-defined and satisfies the axioms of an action. Moreover,

$$q(gg') = (gg')H = g \cdot (g'H) = g \cdot q(g'),$$

which shows that q is G -equivariant with respect to this action.

Example 3.26. Continuing Example 3.22, the action induced by id_G is simply the action of G on itself by left multiplication. This is always an action by Example 3.9, and it holds trivially that id_G is equivariant with respect to this action on its domain and codomain.

Example 3.27. Continuing Example 3.23 on semidirect products, recall that the projection $p_H : N \rtimes_\rho H \rightarrow H$ is always an i_N -coset map. Proposition 3.4 then induces the following action of $N \rtimes_\rho H$ on H :

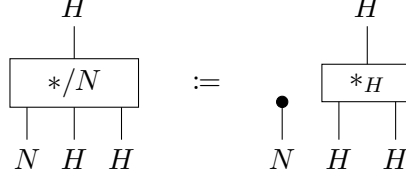

Indeed, it can be seen from Proposition 3.2 that this is always an action. We therefore only need to show that p_H is equivariant with respect to $*$ and $*/N$. By Remark 3.2, this may be done in Set , where for $n, n' \in N$ and $h, h' \in H$ we have

$$p_H((n, h) (n', h')) = p_H(n \rho(h, n'), hh') = hh' = (n, h) \cdot p_H(n', h'),$$

where we use the definition of $*/H$ in the last step. By a similar argument, the action on N induced by the projection $p_N : N \rtimes_\rho H \rightarrow N$, which is an i_H -coset map, is given by

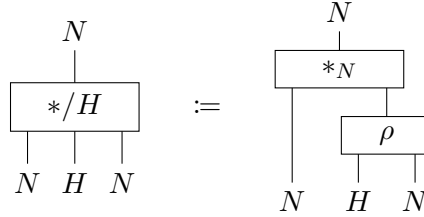

Example 3.28. Continuing Example 3.24, the unique action of $\text{GL}(d, \mathbb{R})$ on $\text{PD}(d)$ that makes q equivariant is given by

$$A \cdot P = APA^T,$$

where $B \in \text{GL}(d, \mathbb{R})$ and $P \in \text{PD}(d)$. It is straightforward to check that this indeed satisfies the axioms of an action, and moreover

$$q(AB) = (AB)(AB)^T = ABB^T A^T = A \cdot (BB^T) = A \cdot q(B)$$

for all $A, B \in \text{GL}(d, \mathbb{R})$, so that q is equivariant with respect to this action.

3.9 Lifting group constructions

It is somewhat tedious to specify groups, actions, and orbit maps in Stoch or TopStoch directly, because the morphisms of these categories are Markov kernels, which are not as straightforward to write down as ordinary functions are. The following technical result provides a convenient way around this.

Proposition 3.5. *Suppose \mathcal{C} and \mathcal{D} are Markov categories, where \mathcal{D} is the Kleisli category of a symmetric monoidal monad on \mathcal{C} . Then the standard inclusion functor $\mathcal{C} \rightarrow \mathcal{D}$ lifts groups, actions, equivariant morphisms, and orbit maps from \mathcal{C} to \mathcal{D} .*

Proof. See Section A.8 in the Appendix. □

As is well known, **Stoch** may be obtained as the Kleisli category of the Giry monad on **Meas** [Gir82], which is symmetric monoidal [Fri20, Lemma 4.1]. A similar statement is true for **TopStoch**, where now the relevant monad is defined on **Top** [FPR21, Corollary 4.17]. As such, this result allows us to specify these various constructions in terms of functions in **Meas** or **Top**, and then lift these to **Stoch** or **TopStoch** automatically. For example, the following may be checked to be an action of the orthogonal group $O(n)$ on $\mathbb{R}^{n \times n}$ in **Top**, and hence in **TopStoch**:

$$Q \cdot A := QAQ^T.$$

Similarly, orbit maps always exist for actions defined in **Top** (see Example 3.20), and these lift directly to **TopStoch** also.

4 Symmetrisation

4.1 Markov categories of equivariant morphisms

It is easily checked that the composition of equivariant morphisms is again equivariant, and that the identity morphism is equivariant. In this way, the equivariant morphisms in **C** form a category. By Proposition B.1 in the Appendix, this is in fact also a Markov category, whose components are defined as follows.

Definition 4.1. *Given a group G in a Markov category \mathbf{C} , we denote by \mathbf{C}^G the Markov category of G -equivariant morphisms, whose components are as follows:*

- *Objects are pairs (X, α_X) of an object X and an action $\alpha_X : G \otimes X \rightarrow X$ in \mathbf{C}*
- *Morphisms $(X, \alpha_X) \rightarrow (Y, \alpha_Y)$ are morphisms $X \rightarrow Y$ in \mathbf{C} that are equivariant with respect to α_X and α_Y , with composition and identities inherited from \mathbf{C}*
- *The monoidal product $(X, \alpha_X) \otimes (Y, \alpha_Y)$ is $(X \otimes Y, \alpha_{X \otimes Y})$, where $\alpha_{X \otimes Y}$ is the diagonal action defined in Example 3.8*
- *The monoidal unit is (I, ε) , where ε is the trivial action defined in Example 3.7*
- *The structure morphisms (e.g. copy and discard) are inherited from \mathbf{C}*

Example 4.1. It is straightforward to check that in any Markov category **C**, the only actions of the trivial group I are trivial. Moreover, a morphism $k : X \rightarrow Y$ in **C** is always equivariant with respect to the trivial actions on X and Y . As a result, \mathbf{C}^I consists of objects of the form (X, ε) , where X may be any object in **C**, and its morphisms $(X, \varepsilon) \rightarrow (Y, \varepsilon)$ are all the morphisms $X \rightarrow Y$ in **C**. In this way, we may regard \mathbf{C}^I and **C** as being the same (although more precisely they are isomorphic as categories).

It will often be cumbersome to write objects in \mathbf{C}^G always as pairs, as in (X, α_X) or (Y, α_Y) . To streamline notation, we will sometimes denote these simply by X, Y, \dots and so on. We will always make clear when we are doing so.

4.2 Action restriction

A homomorphism $\varphi : H \rightarrow G$ always gives rise to a functor $\mathcal{C}^G \rightarrow \mathcal{C}^H$. This provides a link between G -equivariant and H -equivariant morphisms, and so is highly relevant for symmetrisation. This functor acts on objects via *restriction*, which we define first.

Definition 4.2. *Let $\varphi : H \rightarrow G$ be a homomorphism in a Markov category \mathcal{C} . Given an action $\alpha : G \otimes X \rightarrow X$ in \mathcal{C} , its restriction via φ is the following action of H :*

$$\begin{array}{c}
 X \\
 | \\
 \boxed{\alpha} \\
 | \quad | \\
 G \quad X \\
 | \\
 \boxed{\varphi} \\
 | \\
 H
 \end{array}
 \tag{25}$$

Technically, we should check that (25) indeed always defines an action. The following example establishes this in **Set**, and hence in general by Remark 3.2.

Example 4.2. In **Set**, the action (25) may be written as

$$h \cdot x = \varphi(h) \cdot x \quad \text{where } h \in H \text{ and } x \in X. \tag{26}$$

Notice that the original G -action appears here on the right-hand side. This is associative because

$$\varphi(h) \cdot (\varphi(h') \cdot x) = (\varphi(h)\varphi(h')) \cdot x = \varphi(hh') \cdot x,$$

where we use the fact that φ is a homomorphism in the second step. Unitality follows by a similar argument. An important special case occurs when φ is a subgroup inclusion $H \hookrightarrow G$. In this case, $\varphi(h) = h$, and the action (26) becomes the restriction of the original G -action to the subgroup H , which motivates the terminology “restriction”.

With Definition 4.2 given, we are now able to define the functor $\mathcal{C}^G \rightarrow \mathcal{C}^H$ mentioned previously.

Definition 4.3. *Let $\varphi : H \rightarrow G$ be a homomorphism in a Markov category \mathcal{C} . The restriction functor*

$$R_\varphi : \mathcal{C}^G \rightarrow \mathcal{C}^H$$

is defined on objects as $R_\varphi(X, \alpha) := (X, \alpha_\varphi)$, where α_φ denotes the action (25). On morphisms, R_φ is just the identity, so that $R_\varphi(k) := k$.

To see that R_φ is indeed a well-defined functor, just observe that, by definition, a morphism $k : X \rightarrow Y$ in \mathcal{C} is a morphism $R_\varphi(X, \alpha_X) \rightarrow R_\varphi(Y, \alpha_Y)$ in \mathcal{C}^H if it holds that

$$\begin{array}{c}
 Y \\
 | \\
 \boxed{k} \\
 | \\
 \boxed{\alpha_X} \\
 | \quad | \\
 \boxed{\varphi} \quad X \\
 | \\
 H
 \end{array}
 =
 \begin{array}{c}
 Y \\
 | \\
 \boxed{\alpha_Y} \\
 | \quad | \\
 \boxed{\varphi} \quad \boxed{k} \\
 | \quad | \\
 H \quad X
 \end{array}
 \tag{27}$$

This follows immediately when k is equivariant with respect to α_X and α_Y , and hence for all $k : (X, \alpha_X) \rightarrow (Y, \alpha_Y)$ in \mathcal{C}^G . The other functor axioms are immediate.

4.3 Symmetrisation procedures

Our primary methodological aim in this paper is to obtain procedures for *symmetrisation*. At a high-level, given some homomorphism $\varphi : H \rightarrow G$ that we specify, we would like a mapping that sends H -equivariant morphisms to G -equivariant one. We formalise this precisely as follows. Recall that we use the standard notation $D(U, V)$ to denote the set of morphisms $U \rightarrow V$ in a category D .

Definition 4.4. *Let C be a Markov category. A symmetrisation procedure is a function of the form*

$$C^H(R_\varphi X, R_\varphi Y) \rightarrow C^G(X, Y) \quad (28)$$

where $\varphi : H \rightarrow G$ is a homomorphism in C , and X and Y are objects in C^G .

Observe that the left-hand side of (28) consists of morphisms satisfying (27), whereas the right-hand side consists of morphisms that satisfy this condition when φ is removed. For this reason, we intuitively think of a symmetrisation procedure as transporting “less equivariant” morphisms to “more equivariant” ones. In particular, if φ is a subgroup inclusion (for example in Set), then (28) converts morphisms that are equivariant only with respect to the subgroup H into morphisms that are equivariant with respect to the full group G .

Example 4.3. An important special case takes $\varphi : I \rightarrow G$ to be the unique homomorphism out of the trivial group from Example 3.5. By Example 4.1, we may identify C^I may be identified with C itself. As a result, a symmetrisation procedure of this type produces G -equivariant morphisms from arbitrary morphisms in C that are not subject to any equivariance constraints at all.

4.4 Potential desiderata

Definition 4.4 is very minimal, and imposes essentially no structure on the function involved: it must simply map H -equivariant morphisms to G -equivariant ones. In practice, there are various additional properties that we might want a symmetrisation procedure to satisfy. Recall from Section 4.2 that every morphism $X \rightarrow Y$ in C^G is also a morphism of the form $R_\varphi X \rightarrow R_\varphi Y$ in C^H . In other words, it holds that

$$C^G(X, Y) \subseteq C^H(R_\varphi X, R_\varphi Y).$$

As such, a reasonable requirement of a symmetrisation procedure is that it restricts to the identity on $C^G(X, Y)$, and so does not modify its input unless strictly necessary. Precisely:

Definition 4.5. *A symmetrisation procedure $\text{sym} : C^G(R_\varphi X, R_\varphi Y) \rightarrow C^G(X, Y)$ is stable if it satisfies $\text{sym}(k) = k$ for all $k : X \rightarrow Y$ in C^G .*

Beyond its intuitive appeal, stability has other desirable consequences. For example, it follows essentially by definition that a stable symmetrisation procedure is *surjective*. This is clearly of interest for machine learning applications, since it provides a basic guarantee of the overall expressiveness of the procedure: it is possible to obtain every G -equivariant morphism given some appropriate input. Additionally, a stable symmetrisation procedure sym is always *idempotent*, so that $\text{sym}(\text{sym}(k)) = \text{sym}(k)$. This is useful to know at implementation time: we can run all our experiments with sym applied just once, confident that we have not sacrificed any performance by doing so.

4.5 Composing procedures

Symmetrisation procedures may be applied in sequence. For example, suppose we have two homomorphisms

$$K \xrightarrow{\phi} H \xrightarrow{\varphi} G.$$

and two symmetrisation procedures of the form

$$\mathcal{C}^K(R_\phi R_\varphi X, R_\phi R_\varphi Y) \xrightarrow{\text{sym}_\phi} \mathcal{C}^H(R_\varphi X, R_\varphi Y) \xrightarrow{\text{sym}_\varphi} \mathcal{C}^G(X, Y). \quad (29)$$

We may then compose these in the obvious way by first applying sym_ϕ and then applying sym_φ . This allows us to start with a morphism that is K -equivariant and end up with one that is G -equivariant. It follows immediately from inspection of Definition 4.2 that $R_\phi R_\varphi = R_{\varphi \circ \phi}$, and so this composition is a function

$$\mathcal{C}^K(R_{\varphi \circ \phi} X, R_{\varphi \circ \phi} Y) \longrightarrow \mathcal{C}^G(X, Y).$$

This is still a symmetrisation procedure, now along the homomorphism $\varphi \circ \phi : K \rightarrow G$.

Remark 4.1. It is clear that stability and surjectivity are both preserved under composition of symmetrisation procedures. However, idempotence is not in general.

4.6 Deterministic symmetrisation

In many situations, it is desirable to obtain an equivariant neural network that is deterministic. If this is required, one approach is simply to work in a Markov category whose morphisms are always deterministic, such as **Set** or **Top** rather than **Stoch** or **TopStoch**. This ensures any symmetrisation procedure will return a deterministic morphism by construction. However, recent work suggests that there is an advantage to working in a probabilistic setting even when determinism is ultimately sought [Kim+23; DLS24]. An alternative approach suggested by existing work [Pun+22; Kim+23] is instead to symmetrise probabilistically, and then to make the result deterministic by computing its expectation. We describe this now in **Stoch**.

Definition 4.6. Let $Y := \mathbb{R}^d$ for some $d \in \mathbb{N}$. The expectation operator, denoted ave , sends a Markov kernel $k : X \rightarrow Y$ to the Markov kernel $\text{ave}(k) : X \rightarrow Y$, where $\text{ave}(k)(dy|x)$ is Dirac on

$$\int y k(dy|x), \quad (30)$$

provided this integral exists for all $x \in X$.

Here the integral is meant componentwise. Since k is a Markov kernel, a standard argument using Fubini's theorem shows that the function that sends $x \in X$ to (30) defines a measurable function. The Markov kernel $\text{ave}(k)$ is then obtained by lifting this to a deterministic Markov kernel as described in Remark 2.2. A more general definition, where \mathbb{R}^d is replaced by a Banach space, also appears possible.

In general, $\text{ave}(k)$ may not be equivariant even if k is. However, ave does preserve equivariance with respect to *affine* group actions. This occurs very often in practice, since

many actions are defined in terms of elementary matrix operations. The following result makes this more precise.

Proposition 4.1. *Let G be a group in \mathbf{Meas} acting on measurable spaces X and $Y := \mathbb{R}^d$, where the action on Y is affine, and suppose $k : X \rightarrow Y$ is a Markov kernel for which the integral (30) is everywhere defined. If k is equivariant in \mathbf{Stoch} when these actions are lifted to \mathbf{Stoch} (see Proposition 3.5), then $\mathbf{ave}(k)$ is also equivariant with respect to these actions.*

Proof. In the notation of Example 3.11, for all $x \in X$ and $g \in G$ we have

$$\int y k(dy|g \cdot x) = \int y (g \cdot k)(dy|x) = \int (g \cdot y) k(dy|x) = g \cdot \int y k(dy|x),$$

where the second step uses the law of the unconscious statistician, and the third the assumption that the action on Y is affine. This shows that the measurable function $x \mapsto \int y k(dy|x)$ is equivariant. But now observe that $\mathbf{ave}(k)$ is just the Markov kernel obtained by lifting this measurable function to \mathbf{Stoch} as described in Remark 2.2. It therefore follows that $\mathbf{ave}(k)$ is equivariant by Proposition 3.5. \square

In this way, provided these conditions are met, a general strategy for obtaining a deterministic G -equivariant neural network is to apply the following composition:

$$\mathbf{Stoch}^H(R_\varphi X, R_\varphi Y) \xrightarrow{\mathbf{sym}} \mathbf{Stoch}^G(X, Y) \xrightarrow{\mathbf{ave}} \mathbf{Stoch}_{\det}^G(X, Y), \quad (31)$$

where \mathbf{sym} may be any symmetrisation procedure of the type shown.

Remark 4.2. Technically we should regard the composition (31) as a partial function that is defined only on the subset of its domain for which the required integral exists. However, in practice, this is not a major issue. One reason for this is that $\mathbf{ave}(k)$ is always defined when k is deterministic, since then $k(dy|x)$ is Dirac on (30) (see [Fri20, Example 10.5]). As a result, even factoring in integrability caveats, it follows that $\mathbf{ave} \circ \mathbf{sym}$ is always surjective if \mathbf{sym} is, which provides a basic guarantee of its overall expressiveness.

Remark 4.3. The preceding discussion works very concretely in the category \mathbf{Stoch} . A more abstract treatment along the same lines seems possible for a general Markov category that is *representable* in the sense of [Fri+23c]. However, we will not require this greater generality in what follows.

5 A general methodology

5.1 Motivating idea

Suppose the restriction functor R_φ admits a left adjoint E . For any pair of objects X and Y in \mathbf{C}^G , this yields a bijection between the morphisms in \mathbf{C}^H and \mathbf{C}^G as follows:

$$\mathbf{C}^H(R_\varphi X, R_\varphi Y) \xrightarrow{\cong} \mathbf{C}^G(ER_\varphi X, Y). \quad (32)$$

This allows us to map H -equivariant morphisms directly to G -equivariant ones, which seems promising for symmetrisation. However, (32) is not yet a symmetrisation procedure in the

sense of Definition 4.4 since its output does not have the desired type $X \rightarrow Y$. To address this, we add a second step that simply precomposes by some arbitrary morphism

$$\omega : X \rightarrow ER_\varphi X \quad \text{in } \mathcal{C}^G.$$

That is, given $k : ER_\varphi X \rightarrow Y$ in \mathcal{C}^G obtained from (32), we return $k \circ \omega : X \rightarrow Y$, which always has the desired type just by definition of composition. In this way, when a left adjoint E exists, each ω gives rise to a symmetrisation procedure defined as follows:

$$\mathcal{C}^H(R_\varphi X, R_\varphi Y) \xrightarrow{\text{Apply (32)}} \mathcal{C}^G(ER_\varphi X, Y) \xrightarrow{\text{Precompose by } \omega} \mathcal{C}^G(X, Y). \quad (33)$$

To obtain the best results empirically, we want to choose ω “well” in some sense. For this, we will parameterise ω using a neural network that we will then optimise, as discussed later.

5.2 General approach

The requirement of a full left adjoint E is quite strong. The following result provides a weaker condition that still yields bijections of the required form (32) without needing E directly, thereby generalising the approach just described.

Theorem 5.1. *Let \mathcal{C} be a Markov category and $\varphi : H \rightarrow G$ a homomorphism in \mathcal{C} . Suppose a φ -coset map $q : G \rightarrow G/H$ exists, and let $*/H$ be the action of G on G/H induced by Proposition 3.4. Then for every (X, α_X) and (Y, α_Y) in \mathcal{C}^G , there is a bijection*

$$\mathcal{C}^H(R_\varphi(X, \alpha_X), R_\varphi(Y, \alpha_Y)) \xrightarrow{\cong} \mathcal{C}^G((G/H, */H) \otimes (X, \alpha_X), (Y, \alpha_Y)) \quad (34)$$

that sends $k : R_\varphi(X, \alpha_X) \rightarrow R_\varphi(Y, \alpha_Y)$ in \mathcal{C}^H to the unique $k^\#$ in \mathcal{C} such that

$$\begin{array}{c} Y \\ | \\ \boxed{k^\#} \\ | \quad | \\ \boxed{q} \quad | \\ G \quad X \end{array} = \begin{array}{c} Y \\ | \\ \boxed{\alpha_Y} \\ | \quad | \\ \boxed{k} \quad | \\ \boxed{\alpha_X} \\ | \quad | \\ \boxed{(-)^{-1}} \quad | \\ \bullet \quad | \\ G \quad X \end{array} \quad (35)$$

which always exists, and is always a morphism $(G/H, */H) \otimes (X, \alpha_X) \rightarrow (Y, \alpha_Y)$ in \mathcal{C}^G .

Proof. See Section C.1 of the Appendix. □

Remark 5.1. We explain how Theorem 5.1 relates theoretically to the discussion in Section 5.1. (It is not necessary to understand this in order to apply the result in practice.) Given a left adjoint E , the bijections (32) amount to an equivalence of categories between the full

image of R_φ and the co-Kleisli category of the comonad ER_φ .² In classical settings (e.g. [MPC97, (1.6)]), we moreover have

$$ER_\varphi \cong (G/H, */H) \otimes (-).$$

The right-hand side here is part of the reader comonad on \mathcal{C}^G , and so (32) in turn implies an equivalence of categories between the full image of R_φ and the co-Kleisli category of the reader comonad. Theorem 5.1 in effect establishes this equivalence directly, without needing to obtain E . By substituting the reader comonad for ER_φ , we may carry out the steps (33) just as before, where our precomposition morphism now has the form

$$\omega : (X, \alpha_X) \rightarrow (G/H, */H) \otimes (X, \alpha_X) \quad \text{in } \mathcal{C}^G. \quad (36)$$

This approach is both more general and more convenient than constructing a full left adjoint, and we will use it as the basis for the methodology we develop in what follows.

Technically, it does not follow from the statement of Theorem 5.1 alone that the bijections (34) do amount to an equivalence of categories as stated here. It is also necessary to show that these bijections respects function composition, and so define a functor. For theoretical interest, we show this as Corollary C.1 in the Appendix.

Remark 5.2. A φ -coset map $q : G \rightarrow G/H$ often admits a *right-inverse* (or *section*), which is namely a morphism $s : G/H \rightarrow G$ in \mathcal{C} such that

$$q \circ s = \text{id}_{G/H}.$$

For example, a right-inverse of the coset map $g \mapsto gH$ from Example 3.21 selects a representative element of each coset in G/H . This is useful computationally, since by attaching s to the G -input on both sides of (35), we may write k^\sharp explicitly as follows:

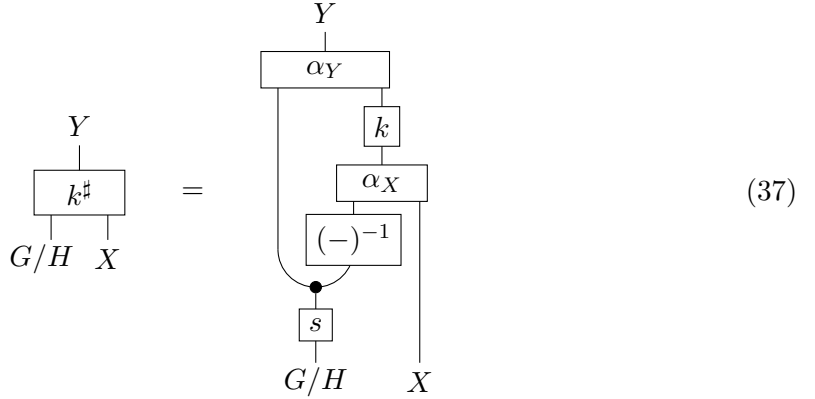

$$\begin{array}{c} Y \\ | \\ \boxed{k^\sharp} \\ | \quad | \\ G/H \quad X \end{array} = \begin{array}{c} Y \\ | \\ \boxed{\alpha_Y} \\ | \quad | \\ \quad \boxed{k} \\ \quad | \\ \quad \boxed{\alpha_X} \\ | \quad | \\ \quad \boxed{(-)^{-1}} \\ | \quad | \\ \quad \bullet \\ \quad | \\ \quad \boxed{s} \\ | \quad | \\ G/H \quad X \end{array} \quad (37)$$

In general there may be many choices of s , but each one will produce the same k^\sharp . Moreover, s need not be equivariant in any sense, so need not be a morphism in \mathcal{C}^G .

Remark 5.3. If \mathcal{C} admits all orbit maps, then it is possible to obtain a left adjoint to R_φ on all of \mathcal{C}^H , rather than just on its full image. We omit the proof of this, but the result

²See [Per21, Section 5.3] for an introduction to comonads, including the reader comonad mentioned below.

follows using very similar ideas as the proof of Theorem 5.1. Compared with (32), this yields a natural bijection

$$\mathcal{C}^H(Z, R_\varphi Y) \cong \mathcal{C}^G(E_\varphi Z, Y)$$

for all Z in \mathcal{C}^H , rather than just when $Z = R_\varphi X$. This may yield interesting possibilities for symmetrisation: for instance, we could generalise (33) to start with a morphism $Z \rightarrow R_\varphi Y$ in \mathcal{C}^H , where now Z may be any object in \mathcal{C}^H , and in the second step precompose instead by a morphism $\omega : X \rightarrow E_\varphi Z$ in \mathcal{C}^G . We leave this for future work to explore.

5.3 Obtaining a precomposition morphism

Suppose Theorem 5.1 applies. To obtain an overall symmetrisation procedure, it remains to select a precomposition morphism ω of the form (36). For this, we will set

$$\begin{array}{c} G/H \quad X \\ \boxed{\omega} \\ X \end{array} := \begin{array}{c} G/H \quad X \\ \boxed{\gamma} \\ \bullet \\ X \end{array} \quad (38)$$

where γ may be any morphism $(X, \alpha_X) \rightarrow (G/H, */H)$ in \mathcal{C}^G . By definition of composition in \mathcal{C}^G , this means ω has the required type from (36) also.

Remark 5.4. We will denote by sym_γ the overall symmetrisation procedure that first applies (34) and then precomposes by (38). End-to-end, this has the following type:

$$\mathcal{C}^H(R_\varphi(X, \alpha_X), R_\varphi(Y, \alpha_Y)) \xrightarrow{\text{sym}_\gamma} \mathcal{C}^G((X, \alpha_X), (Y, \alpha_Y)).$$

However, notice that same choice of γ may be reused across more than one (Y, α_Y) . We will abuse notation slightly by denoting every such procedure using the same symbol sym_γ , even though technically these are distinct functions when their codomains differ.

The choice of (38) sacrifices some generality, since not every morphism in \mathcal{C}^G of the form (36) can be expressed in this way. Our reason for this restriction is that it is sufficient, and for positive Markov categories necessary, to ensure that the overall procedure is stable, as the next result shows. As discussed in Section 4.4, stability in turn means the procedure is surjective and idempotent, both of which are desirable for machine learning applications.

Proposition 5.1. *Assuming Theorem 5.1 applies, the procedure sym_γ is stable for every choice of γ . Conversely, if \mathcal{C} is positive, then every instance of (33) that is stable can be obtained as sym_γ for some choice of γ .*

Proof. See Section C.2 of the Appendix. □

Remark 5.5. As a morphism in \mathcal{C}^G , we require γ already to be G -equivariant. This in effect pushes back the problem of symmetrisation to the choice of γ , which mirrors the situation for deterministic symmetrisation approaches also [Pun+22; Kab+23; Kim+23]. Previous work has assumed γ is given directly in the form of an intrinsically equivariant

neural network. However, our formalism suggests an alternative, *recursive* procedure for obtaining γ , which adds a new layer of flexibility. In particular, we can set

$$\gamma := \text{sym}_{\gamma_1}(m)$$

for some $m : R_\varphi(X, \alpha_X) \rightarrow R_\varphi(G/H, */H)$ in \mathcal{C}^H , where now $\gamma_1 : (X, \alpha_X) \rightarrow (G/H, */H)$ in \mathcal{C}^G . If desired, γ_1 could itself be the result of recursive symmetrisation, and so on. Of course, this still ultimately requires a base case, for which an intrinsically equivariant neural network could be used. In Section 6, we also provide various examples of very simplistic choices that provide a default option in cases where a more complex choice is not available or not desired. We expect that in many cases the recursive approach will lead to a more expressive γ than the base case alone, just as previous work on symmetrisation has shown improved performance compared with intrinsically equivariant baselines. We provide empirical evidence of this in Section 7 below.

5.4 End-to-end procedure

We now summarise the complete steps required to symmetrise a morphism $k : R_\varphi(X, \alpha_X) \rightarrow R_\varphi(Y, \alpha_Y)$ in \mathcal{C}^H along a homomorphism $\varphi : H \rightarrow G$ as described in this section.

1. Obtain a φ -coset map $q : G \rightarrow G/H$ in \mathcal{C}
2. Obtain a right-inverse $s : G/H \rightarrow G$ of q in \mathcal{C}
3. Determine the action $*/H : G \otimes G/H \rightarrow G/H$ induced by Proposition 3.4
4. Obtain a morphism $\gamma : (X, \alpha_X) \rightarrow (G/H, */H)$ in \mathcal{C}^G , either recursively or from some base case
5. Return $\text{sym}_\gamma(k) : (X, \alpha_X) \rightarrow (Y, \alpha_Y)$ in \mathcal{C}^G computed as follows:

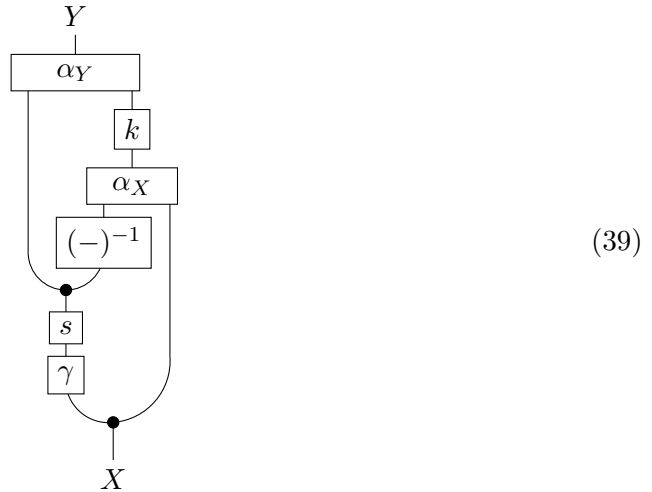

Here the last diagram is obtained simply by attaching our precomposition morphism (38) to k^\sharp as obtained using s in (37). More generally, k^\sharp is still defined even without s , although then only implicitly by the expression (35) which makes its computation more difficult.

Remark 5.6. By Examples 3.19 and 3.20 and Theorem 3.1, a φ -coset map exists for every homomorphism φ in **Set**, **Top**, and **TopStoch**. This procedure is therefore always applicable in all of these cases. For other Markov categories such as **Stoch**, the procedure still applies whenever we can find a φ -coset map. This may not always be possible, although we suspect that any such cases would be somewhat pathological and of less interest practically.

Example 5.1. Suppose $H := I$ is the trivial group and φ is the unique homomorphism

$$I \rightarrow G.$$

By identifying \mathbf{C}^I with \mathbf{C} as in Example 4.1, symmetrising along φ allows us to convert arbitrary morphisms in \mathbf{C} to ones that are G -equivariant. Example 3.22 shows that id_G is always a φ -coset map, and this is trivially its own right-inverse. Moreover, by Example 3.26, the canonical action $*/I$ is just the action of G on itself by left multiplication. As such, in this case, all that is required is to obtain a base case $\gamma : (X, \alpha_X) \rightarrow (G, *)$ in \mathbf{C}^G . We give some default options for specific groups and actions in Section 6.

Remark 5.7. If $\mathbf{C} = \text{Stoch}$, so that its morphisms are actual Markov kernels, then a sampling procedure for (39) may be read off directly. Suppose that G is a group acting on X and Y in **Meas**, and that α_X and α_Y are obtained by lifting these actions to **Stoch** via Proposition 3.5. Given $x \in X$, we may then sample from $\text{sym}_\gamma(k)(dy|x)$ by sampling

$$\Gamma \sim \gamma(dc|x) \quad \mathbf{G} \sim s(dg|\Gamma) \quad \mathbf{Y} \sim k(dy|\mathbf{G}^{-1} \cdot x) \quad \mathbf{Y}' := \mathbf{G} \cdot \mathbf{Y}$$

and returning \mathbf{Y}' . The same story also holds for **TopStoch**.

5.5 Comparison with deterministic methods

Various existing methods for deterministic symmetrisation can be expressed as instances of the framework we have described here. Consider again the setup from Example 5.1, where φ is the trivial homomorphism $I \rightarrow G$. When $\mathbf{C} = \text{Set}$, all the morphisms involved are just functions, and (39) becomes

$$\text{sym}_\gamma(k)(x) = \gamma(x) \cdot k(\gamma(x)^{-1} \cdot x), \quad (40)$$

which recovers the *canonicalisation* approach of [Kab+23, (2)].³ Likewise, suppose $\mathbf{C} = \text{Stoch}$ and that the actions on X and Y are obtained by lifting the actions of some group G in **Meas** according to Proposition 3.5. Moreover, suppose that $k = k_f$ is the Markov kernel obtained by lifting some measurable function $f : X \rightarrow Y$ as described in Remark 2.2. By computing $\text{sym}_\gamma(k_f)$ and then averaging its output over Y as described in Section 4.6, we obtain a Markov kernel whose distribution at $x \in X$ is Dirac on the following:

$$\int \text{sym}_\gamma(k_f)(d\hat{y}|x) = \int g \cdot f(g^{-1} \cdot x) \gamma(dg|x), \quad (41)$$

by the law of the unconscious statistician. Provided the action on Y is affine, Proposition 4.1 then shows that this is equivariant. This recovers the approach of [Kim+23, (4)], who

³For other subgroup inclusions $\varphi : H \rightarrow G$ where s is nontrivial, $\text{sym}_\gamma(k)$ also recovers their more general setup [Kab+23, Theorem 3.1], with our $s \circ \gamma$ playing the role of their h .

consider the case where G is compact and γ admits an equivariant (in the sense of (15)) conditional density with respect to the Haar measure on G . In turn, [Kim+23, Proposition 1] show that *frame averaging* [Pun+22, (3)] is an instance of their approach, where $\gamma(dg|x)$ is uniform on the set produced by the frame at the value x . The right-hand side of (41) also recovers the (equivariant) *weighted frames* approach of [DLS24, Remark 3.4], explicating its relationship to the approach of [Kim+23]. Finally, letting $G := S_n$ be the group of permutations of $\{1, \dots, n\}$, with $\gamma(dg|x)$ uniform on S_n , and equipping Y with the trivial action, (41) becomes

$$\frac{1}{n!} \sum_{\sigma \in S_n} k(\sigma^{-1} \cdot x),$$

which recovers *Janossy pooling* [Mur+19b, Definition 2.1], an early example of a symmetrisation procedure in the machine learning literature.

The framework we have developed here therefore shows that all these existing methods can be recovered as special cases of a general principle based on Theorem 5.1. We also obtain various possibilities for generalisation. For example, rather than averaging the output of $\text{sym}_\gamma(k_f)$ as (41), we can use the symmetrised kernel $\text{sym}_\gamma(k)$ directly as a model that is overall stochastic. This may be useful in contexts where uncertainty quantification is required, or when Y is nonconvex, and so averaging is not meaningful.

6 Examples

We now show how implement the steps described in Section 5.4 across for a variety of homomorphisms $\varphi : H \rightarrow G$. In all cases, φ amounts to some form of a subgroup inclusion. Conceivably there are situations where other homomorphisms are of interest, but inclusions already cover a wide range of practical use-cases. In addition to the other necessary components, we will provide various examples of γ that could be used as base cases in the recursive procedure described in Remark 5.5. These are by no means the only choice, and for instance an intrinsically equivariant neural network could be used instead for this purpose if desired.

Several of the following examples consider an abstract Markov category \mathbf{C} . In some other cases, we take $\mathbf{C} := \mathbf{Set}$. However, we do so mainly to simplify our presentation: \mathbf{Meas} or \mathbf{Top} would work just as well, and in turn the various components we describe (coset maps, right-inverses, etc.) lift to \mathbf{Stoch} or $\mathbf{TopStoch}$ by Proposition 3.5,⁴ and can therefore be used directly for stochastic symmetrisation also.

Example 6.1. Let G be a compact group, and consider the unique homomorphism

$$I \rightarrow G$$

out of the trivial group. Symmetrising along this sends an arbitrary morphism in \mathbf{C} to one that is G -equivariant. By Example 5.1, all we require here is a choice of base case

$$\gamma : (X, \alpha_X) \rightarrow (G, *)$$

⁴Technically, Proposition 3.5 does not establish that right-inverses also lift, but this follows straightforwardly from functoriality of the inclusions $\mathbf{Meas} \rightarrow \mathbf{Stoch}$ and $\mathbf{Top} \rightarrow \mathbf{TopStoch}$.

in \mathbf{C}^G . A default choice for this that applies for any (X, α_X) in \mathbf{C}^G is to take

$$\begin{array}{ccc}
 (G, *) & & (G, *) \\
 \downarrow & & \downarrow \\
 \boxed{\gamma} & := & \triangle \lambda \\
 \downarrow & & \downarrow \\
 (X, \alpha_X) & & (X, \alpha_X)
 \end{array} \tag{42}$$

where $\lambda : I \rightarrow G$ is the Haar measure of G . From Definition 3.5, it follows straightforwardly that λ is always a morphism $(I, \varepsilon) \rightarrow (G, *)$ in \mathbf{C}^G . It therefore follows that γ here has the type shown in (42) just by the definition of composition. In this way, we obtain a general symmetrisation procedure for all compact groups, which is always available regardless of the choice of (X, α_X) .

Example 6.2. In \mathbf{Set} , let \mathbb{T}_d denote the translation group, namely \mathbb{R}^d equipped with vector addition. We consider how to symmetrise along the unique homomorphism

$$I \rightarrow \mathbb{T}_d,$$

which allows us to convert an arbitrary morphism in \mathbf{Set} into one that is \mathbb{T}_d -equivariant. By Example 5.1, all we require here is a choice of base case

$$\gamma : (X, \alpha_X) \rightarrow (\mathbb{T}_d, +)$$

in $\mathbf{Set}^{\mathbb{T}_d}$. This will depend on the choice of (X, α_X) . A common situation takes $X := \mathbb{R}^{d \times n}$, and obtains α_X by columnwise addition. An obvious γ is then the columnwise mean

$$\gamma(x_1, \dots, x_n) := \frac{1}{n} \sum_{i=1}^n x_i, \tag{43}$$

which is easily verified to be equivariant.

Example 6.3. From Example 3.23, a semidirect product always comes equipped with an inclusion homomorphism:

$$i_N : N \rightarrow N \rtimes_{\rho} H.$$

Symmetrising along i_N allows us to convert N -equivariant morphisms to ones that are $(N \rtimes_{\rho} H)$ -equivariant. For this:

- The projection p_H is an i_N -coset map by Example 3.23
- The other inclusion i_H is right-inverse of p_H (as may be checked)
- The coset action is $*/N$ defined in Example 3.27

All that remains then is to find a base case

$$\gamma : (X, \alpha_X) \rightarrow (H, */N) \tag{44}$$

in $\mathbf{C}^{N \rtimes_\rho H}$. When H is compact, a default choice of γ is available using its Haar measure λ in a similar way to Example 6.1.⁵ Specifically, we can take:

$$\begin{array}{ccc}
 (H, */N) & & (H, */N) \\
 \downarrow & & \downarrow \\
 \boxed{\gamma} & := & \triangle \lambda \\
 \downarrow & & \downarrow \\
 (X, \alpha_X) & & (X, \alpha_X)
 \end{array}$$

By the defining property of λ from Definition 3.5 and inspection of the definition of $*/N$, it is seen that λ is a morphism $(I, \varepsilon) \rightarrow (H, */N)$ in $\mathbf{C}^{N \rtimes_\rho H}$, and so it follows that γ as defined here indeed has the desired type (44). This approach works without assumptions on N , which may be noncompact. As a result, symmetrisation can be performed in a fully compositional way in this case: if we know how to obtain N -equivariant morphisms and H is compact, then we know how to obtain $(N \rtimes_\rho H)$ -equivariant morphisms also.

When $\mathbf{C} = \mathbf{Set}$, this recovers [Kab+23, Theorem 3.2]. Indeed, recall from Proposition 3.2 that every action of a semidirect product $N \rtimes_\rho H$ can be decomposed into a H -action followed by an N -action. Moreover, Proposition 3.3 shows that $(N \rtimes_\rho H)$ -equivariance reduces to N - and H -equivariance separately with respect to these decomposed actions. But now the definition of $*/N$ in Example 3.27 is already decomposed in this way, where the N -action is trivial. As such, the base case γ here is required to be H -equivariant and N -invariant, just as in [Kab+23]. However, in the context of \mathbf{Set} , a Haar measure λ does not exist unless G is trivial, and so the default option we provided is no longer available. By considering a more general \mathbf{C} , we therefore obtain a more flexible approach. We can also apply this same idea more generally for stochastic symmetrisation too.

Example 6.4. In addition to the inclusion i_N considered in Example 6.3, a semidirect product comes equipped with an inclusion homomorphism

$$i_H : H \rightarrow N \rtimes_\rho H$$

as defined in Example 3.23. Symmetrising along i_H allows us to convert H -equivariant morphisms to $(N \rtimes_\rho H)$ -equivariant ones. The situation here is dual to Example 6.3:

- The projection p_N is an i_H -coset map by Example 3.23
- The other inclusion i_N is a right-inverse of p_N (as may be checked)
- The coset action is $*/H$ as defined in Example 3.27

To implement our procedure, we therefore only need to find a base case

$$\gamma : (X, \alpha_X) \rightarrow (N, */H)$$

in $\mathbf{C}^{N \rtimes_\rho H}$. Unlike when symmetrising via the other inclusion i_N , a general-purpose approach (that leverages, say, compactness) seems less forthcoming here, but case-by-case choices are

⁵It holds that $G \cong I \rtimes_\varepsilon G$ as groups in \mathbf{C} , and so our approach for compact groups in Example 6.1 is really a special case of the approach here.

still possible. For example, in \mathbf{Set} , consider the special Euclidean group $\mathrm{SE}(d) = \mathbb{T}_d \rtimes_{\rho} \mathrm{SO}(d)$ defined in Example 3.14 (the case of $\mathrm{E}(d)$ is essentially the same). Then $*/H$ becomes

$$(t, Q) \cdot t' = t + Qt'$$

for $t, t' \in \mathbb{T}_d$ and $Q \in \mathrm{SO}(d)$. A common situation takes $X := \mathbb{R}^{d \times n}$ and obtains α_X in a columnwise fashion, so that

$$(t, Q) \cdot (x_1, \dots, x_n) := (Qx_1 + t, \dots, Qx_n + t).$$

Intuitively, X here is thought of as a cloud of n points $x_i \in \mathbb{R}^d$, and $\mathrm{SE}(d)$ acts by rotating and then translating this cloud rigidly. In this case, it is straightforward to check that the columnwise mean (43) is again equivariant with respect to α_X and $*/H$, and so provides a suitable γ .⁶ Substituting this into (39) recovers a standard trick from the literature that involves first subtracting off the centroid of a point cloud so that it is centered at the origin, then applying some H -equivariant neural network, before finally adding the centroid back on to the result [Gar+21, Section 4], [Hoo+22, Section 3.1], [Pun+22, Section 3.1], [Kim+23, Section 2.2]. This has previously been justified in an ad hoc way, but arises naturally from the same underlying principle expressed in Theorem 5.1 as the other examples we consider.

Example 6.5. Rather than symmetrising via N or H as in the previous Examples, it is also possible to symmetrise directly along the unique homomorphism

$$I \rightarrow N \rtimes_{\rho} H$$

into a semidirect product. A procedure of this kind allows us to obtain $(N \rtimes_{\rho} H)$ -equivariant morphisms from arbitrary morphisms in \mathbf{C} . By Example 5.1, all we require in this instance is a choice of base case

$$\gamma : (X, \alpha_X) \rightarrow (N \rtimes_{\rho} H, *) \quad (45)$$

in $\mathbf{C}^{N \rtimes_{\rho} H}$. From the definition of the diagonal action in Example 3.8, as well as the definition of the semidirect product multiplication in Definition 3.6, it is easily checked that

$$(N \rtimes_{\rho} H, *) = (N, */H) \otimes (H, */N)$$

A general approach to obtaining γ is therefore to take

$$\begin{array}{ccc} (N \rtimes_{\rho} H, *) & & (N, */H) \quad (H, */N) \\ \downarrow \boxed{\gamma} & := & \downarrow \boxed{\gamma_N} \quad \downarrow \boxed{\gamma_H} \\ (X, \alpha_X) & & \downarrow \bullet \\ & & (X, \alpha_X) \end{array}$$

where γ_N and γ_H are morphisms in $\mathbf{C}^{N \rtimes_{\rho} H}$ of the types shown. It then follows automatically that the right-hand side has the required type shown on the left. For the Euclidean group in \mathbf{Set} , this recovers the approach of [Kab+23, (9), (10)], who obtain γ_N and γ_H using intrinsically equivariant neural networks.

⁶Similar to the previous Example, it holds that $\mathbb{T}_d \cong \mathbb{T}_d \rtimes_{\varepsilon} I$ as groups in \mathbf{C} , and so Example 6.2 is really a special case of the approach here.

In a sense, this approach is the easiest possible here, since any other γ of the form (45) immediately gives rise to suitable choices of γ_N and γ_H by projecting onto N and H respectively. Notice that this also is a stronger requirement than in Examples 6.3 and 6.4, which required either γ_N or γ_H of this form, but not both. To some extent, this additional complexity is to be expected given we are now symmetrising arbitrary morphisms in \mathbb{C} , whereas previously we were symmetrising morphisms that were already N - or H -equivariant.

Example 6.6. Interestingly, we can even obtain equivariance with respect to the full general linear group $\text{GL}(d, \mathbb{R})$. In Set , consider the inclusion homomorphism

$$\text{O}(d) \rightarrow \text{GL}(d, \mathbb{R}).$$

Symmetrising along this converts $\text{O}(d)$ -equivariant morphisms to $\text{GL}(d, \mathbb{R})$ -equivariant ones. Here a coset map $\text{GL}(d, \mathbb{R}) \rightarrow \text{PD}(d)$ is given by $A \mapsto AA^T$ from Example 3.24, and its induced coset action $*/\text{O}(d)$ is computed as $A \cdot P = APA^T$ by Example 3.28. A right inverse of the coset map may also be obtained straightforwardly by the Cholesky decomposition. We therefore only need a base case

$$\gamma : (X, \alpha_X) \rightarrow (\text{PD}(d), */\text{O}(d))$$

in $\text{Set}^{\text{GL}(d, \mathbb{R})}$. Consider the specific case $X := \mathbb{R}^{d \times n}$, where α_X is obtained by left-multiplication, namely $A \cdot B := AB$. For this we may take $\gamma(B) := BB^T$, which is equivariant since

$$\gamma(A \cdot B) = ABB^T A^T = A\gamma(B)A^T = A \cdot \gamma(B).$$

As for other symmetrisation procedures, this could be used compositionally. For example, we could symmetrise along the inclusion homomorphisms

$$I \rightarrow \text{O}(d) \rightarrow \text{GL}(d, \mathbb{R})$$

in sequence to obtain an $\text{GL}(d, \mathbb{R})$ -equivariant morphism starting from an arbitrary morphism in Set (as opposed to one that is already $\text{O}(d)$ -equivariant). We are not sure of the practical utility of this example, as we are unaware of applications where $\text{GL}(d, \mathbb{R})$ -equivariance has been considered, but believe it provides as an interesting demonstration of the flexibility of our approach.

7 Application and numerical results

We now describe one concrete application of our stochastic symmetrisation approach. In particular, we apply it to the method of [Kim+23], which has obtained state-of-the-art results for deterministic symmetrisation across a variety of tasks. Although their overall model is deterministic, [Kim+23] require a stochastically equivariant neural network as a crucial subcomponent, and use an intrinsically equivariant neural network for this purpose. We show how this component can instead be obtained using our methodology, which allows us apply more flexible off-the-shelf architectures that are not subject to equivariant constraints. Empirically, this leads to improved performance over the intrinsic approach on a synthetic example. More generally, we believe this case study also demonstrates the greater

conceptual and notational clarity that arises by framing this problem in terms of Markov categories, which may be useful for other machine learning applications also.

Other use-cases for stochastic symmetrisation appear possible beyond the one we consider here. In particular, our methodology could also be used more directly to obtain an equivariant model that is overall stochastic, rather than as a component of a deterministic symmetrisation procedure. This may be of interest in applications such as deep generative modelling, or where uncertainty quantification is required. We leave this for future work.

7.1 Architecture

We describe the approach of [Kim+23] within the context of our framework. For concreteness, we formalise this entirely in **Stoch**, which means we think of all model components as Markov kernels, including the deterministic neural networks that we use. Given i.i.d. samples from some distribution $p(dx, dy)$ on $X \otimes Y$, the overall goal is to learn a deterministic $f : X \rightarrow Y$ that we will use as a predictor. We assume that $Y := \mathbb{R}^d$, and that both X and Y are equipped with the actions of some group G in **Stoch**, and we would like f to be equivariant with respect to these actions. We think of f as depending on some additional parameters that correspond to neural network weights, although to streamline notation we keep these implicit in what follows.

Baseline The approach of [Kim+23] in effect applies the strategy described in Section 4.6 above: they first symmetrise an unconstrained neural network in **Stoch**, and then average over the output to obtain a deterministic predictor. More succinctly, they obtain f via:

$$\begin{aligned} k &:= \text{sym}_\gamma(\text{nn}_k) \\ f &:= \text{ave}(k). \end{aligned}$$

Here $\text{nn}_k : X \rightarrow Y$ is some unconstrained neural network. In both [Kim+23] and in our own experiments, this component is deterministic, although this is not strictly necessary. Likewise, $\gamma : (X, \alpha_X) \rightarrow (G, *)$ is a morphism in Stoch^G . For this component, [Kim+23] use the following architecture:

$$\begin{array}{c} G \\ \downarrow \\ \boxed{\gamma} \\ \downarrow \\ X \end{array} \quad := \quad \begin{array}{c} G \\ \downarrow \\ \boxed{\text{pr}} \\ \downarrow \\ \boxed{\text{nn}_\gamma} \\ \downarrow \\ X \end{array} \quad \begin{array}{c} \downarrow \\ \triangle \eta \end{array} \quad (46)$$

Here, at a high level:

- nn_γ is some deterministic neural network that forms the “backbone” of γ
- η is some noise distribution that allows γ overall to be stochastic
- pr projects its input onto G , which is necessary because many groups live on a manifold, whereas neural networks typically output values in some Euclidean space.

If these components are all suitably equivariant, it follows immediately that their composition γ is too. To ensure this, [Kim+23] obtain \mathbf{nn}_γ by using some intrinsically equivariant architecture off-the-shelf. They also provide choices of η and pr suitable for several specific groups of interest [Kim+23, Section 2.2].

Our approach Rather than relying on an intrinsically equivariant neural network, we obtain γ itself through stochastic symmetrisation. All up, our architecture is as follows:

$$\begin{aligned}\gamma &:= \text{sym}_{\gamma_1}(\gamma_0) \\ k &:= \text{sym}_\gamma(\mathbf{nn}_k) \\ f &:= \text{ave}(k)\end{aligned}$$

This corresponds to symmetrising \mathbf{nn}_k using the recursive approach described in Remark 5.5, and then again averaging the result as in Section 4.6. Here $\mathbf{nn}_k : X \rightarrow Y$ is again some unconstrained neural network, and $\gamma_1 : (X, \alpha_X) \rightarrow (G, *)$ is again some morphism in Stoch^G , which means that γ is a morphism in this category also. However, now $\gamma_0 : X \rightarrow G$ is an unconstrained morphism in Stoch , and so can be chosen more freely.

7.2 Training objective

We discuss how to train models of this kind. This has been considered by [Kim+23, (55)], as well as [Mur+19b, (10)] and [Mur+19a, (9)], and the same underlying idea works here as well, although takes on a different form in our notation. Overall, we would like to learn the parameters of our predictor f by stochastic gradient descent. Recall from Definition 4.6 that to sample from $f(d\hat{y}|x) = \text{ave}(k)(d\hat{y}|x)$ requires computing the integral $\int \hat{y} k(d\hat{y}|x)$. This is usually intractable, which poses a challenge for obtaining unbiased gradient estimates of the expected loss. However, for a real-valued loss function ℓ that is convex in its second argument, Jensen’s inequality yields the following upper bound:

$$\begin{aligned}\int \ell(y, \hat{y}) f(d\hat{y}|x) p(dx, dy) &= \int \ell\left(y, \int \hat{y} k(d\hat{y}|x)\right) p(dx, dy) \\ &\leq \int \int \ell(y, \hat{y}) k(d\hat{y}|x) p(dx, dy)\end{aligned}\tag{47}$$

Following the earlier work mentioned, we optimise (47) in the parameters of the model using unbiased estimates of its gradient obtained by Monte Carlo. This strategy may be applied whenever k is reparameterisable [KW22, Section 2.4]. For both the baseline and our approach, this is the case if η (which is the only source of randomness here) is some fixed noise distribution that does not depend on the parameters of the model, as we assume in our experiments.

Remark 7.1. We briefly explain why (47) is reasonable to use as a training objective. Observe that this inequality becomes exact if $k(dy|x)$ is Dirac for all $x \in X$, or equivalently if k is deterministic [Fri20, Example 10.5]. It follows that if (47) is globally optimised over the parameters of the model, the resulting k (which may be stochastic) will perform at least as well as the best-performing *deterministic* k the model can express. But now k has at least two opportunities to become deterministic, which occurs if:

- \mathbf{nn}_k is deterministic and G -equivariant. In this case $k = \text{sym}_\gamma(\mathbf{nn}_k) = \mathbf{nn}_k$ is also deterministic, where the second equality holds because sym_γ is stable (Proposition 5.1). This generalises an observation made by [Mur+19b, Section 2.3].
- \mathbf{nn}_k and γ are both deterministic. In this case, $k = \text{sym}_\gamma(\mathbf{nn}_k)$ is deterministic because sym_γ restricts to a symmetrisation procedure in the deterministic subcategory $\text{Stoch}_{\text{det}}$. This in effect reduces to the canonicalisation approach of [Kab+23].

This “double robustness” suggests that, under typical circumstances, it will be fairly easy for a model to express (or at least approximate) a rich family of deterministic k , which gives reason to anticipate good performance overall even when optimising the bound (47) rather than the true expected loss.

7.3 Numerical example

We applied this setup to a synthetic problem involving matrix inversion. For various choices of $d \in \mathbb{N}$, we took both X and Y to be the general linear group $\text{GL}(d, \mathbb{R})$, and our goal was to learn the inversion map $A \mapsto A^{-1}$. We took $G := \text{O}(d)$ to be the orthogonal group. Observe that if Q is orthogonal, then we have straightforwardly

$$(QA)^{-1} = A^{-1}Q^{-1} = A^{-1}Q^T,$$

so that the inversion map is equivariant when $\text{O}(d)$ acts on X by left multiplication and on Y by right multiplication by the inverse (or equivalently the transpose, which is much cheaper to compute). We therefore sought to make our predictor f equivariant with respect to these actions also. We selected this task because it involves learning a difficult computation that can be easily considered across a range of dimensions. We emphasise that is only one example, and further empirical work is needed to establish that the improvements reported here also carry over to other tasks. Nevertheless, we believe the results here serve as an interesting proof of concept for our approach.

Baseline We compared against the method of [Kim+23], using the same choices as they described for their experiments involving the orthogonal group. Specifically, η was a d -dimensional standard Gaussian, and pr was the Gram-Schmidt procedure. We took \mathbf{nn}_k to be an MLP with two hidden layers of 500 hidden units and tanh activations.⁷ For the intrinsically equivariant \mathbf{nn}_γ , we tried two architectures, namely the EMLP approach of [FWW21], and the “scalars” method of [Vil+21]. For the EMLP, we used the same default architecture involving bilinear and gated nonlinear layers as in [FWW21, Figure 4], while we used an MLP with tanh activations to obtain the unconstrained scalar functions of [Vil+21, (6)] (f_t in their notation). In both cases, \mathbf{nn}_γ had one hidden layer with 500 hidden units, following [Kim+23] in making this smaller than \mathbf{nn}_k .

⁷We took for granted that \mathbf{nn}_k produced values in $\text{GL}(d, \mathbb{R})$. This is reasonable for a neural network with d^2 outputs trained via stochastic gradient descent, since $\text{GL}(d, \mathbb{R})$ is dense in $\mathbb{R}^{d \times d}$.

Our method For our approach, we took nn_k , η , and pr to be the same as for the baseline. For γ_0 , we again used the architecture (46), except that now its “backbone” neural network nn_{γ_0} was an unconstrained MLP. For γ_1 , which needed to be equivariant, we tried two approaches. The first again used the architecture (46), with its “backbone” nn_{γ_1} using the “scalars” approach of [Vil+21, (6)]. The second used the Haar measure of the orthogonal group to obtain γ_1 directly as in (42). In the “scalars” case, both nn_{γ_0} and nn_{γ_1} had one hidden layer with 250 hidden units, where we made these narrower to account for the fact that we required two networks here instead of one. In the Haar case, nn_{γ_0} was wider, with 500 hidden units. We used tanh activations in all cases.

Additional baselines As a further baseline, we trained nn_k directly, without applying any symmetrisation. We also trained a version of the architecture of [Kim+23] where γ was directly obtained using the Haar measure as in (42). Since these models did not require an additional neural network for γ , we made nn_k deeper than before, using three hidden layers of 500 units instead of two. We again used tanh activations in both cases.

Training and testing details We took $p(dx, dy)$ to be the distribution of (\mathbf{X}, \mathbf{Y}) , where \mathbf{X} is a random element of $\text{GL}(n, \mathbb{R})$ with i.i.d. standard Gaussian entries and $\mathbf{Y} := \mathbf{X}^{-1}$. We did not use a finite dataset, but instead sampled new training and testing examples on the fly. In this way, we sought to determine the overall expressive power of the models without concerns about overfitting. We trained all models using the loss function

$$\ell(y, \hat{y}) := \|y^{-1}\hat{y} - I_d\|_F,$$

where $\|\cdot\|_F$ denotes the Frobenius norm, and I_d is the $d \times d$ identity matrix. This loss measures how close \hat{y} is to $y = x^{-1}$ in an “operational” sense. It is easily checked that $L(y, \hat{y})$ is convex in \hat{y} , and accordingly we trained our symmetrised models using the upper bound (47) as described earlier. For the baseline unsymmetrised MLP, we optimised the expected loss directly. We used the Adam optimiser [KB14] with default hyperparameters and a learning rate of 10^{-4} in all cases, and performed 10^5 gradient steps for each model. At test time, given a test input $x \in X$, we computed the prediction of each symmetrised model $f(d\hat{y}|x) = \text{ave}(k)(d\hat{y}|x)$ approximately using Monte Carlo, averaging over 100 samples drawn i.i.d. from $k(dy|x)$.

Results Figure 1 shows the average test loss after training for each model across the range of dimension d that we considered. Our method using the “scalars” architecture for nn_{γ_1} outperformed all other models, including the baseline method of [Kim+23] that used the same (but larger) architecture for nn_γ . This indicates that the greater flexibility obtained by symmetrising γ , rather than using an intrinsically equivariant neural network, can lead to improved performance. In comparison, our method using the Haar measure for γ_1 did not perform as well, but did perform comparably or better than the baseline method of [Kim+23] that used an EMLP for its nn_γ . This is still interesting, as in this case our model did not make use of an intrinsically equivariant neural network as a subcomponent, whereas the baseline did. In other words, our recursive symmetrisation approach (Remark 5.5) can still outperform intrinsic approaches even when using a highly simplistic base case (the Haar

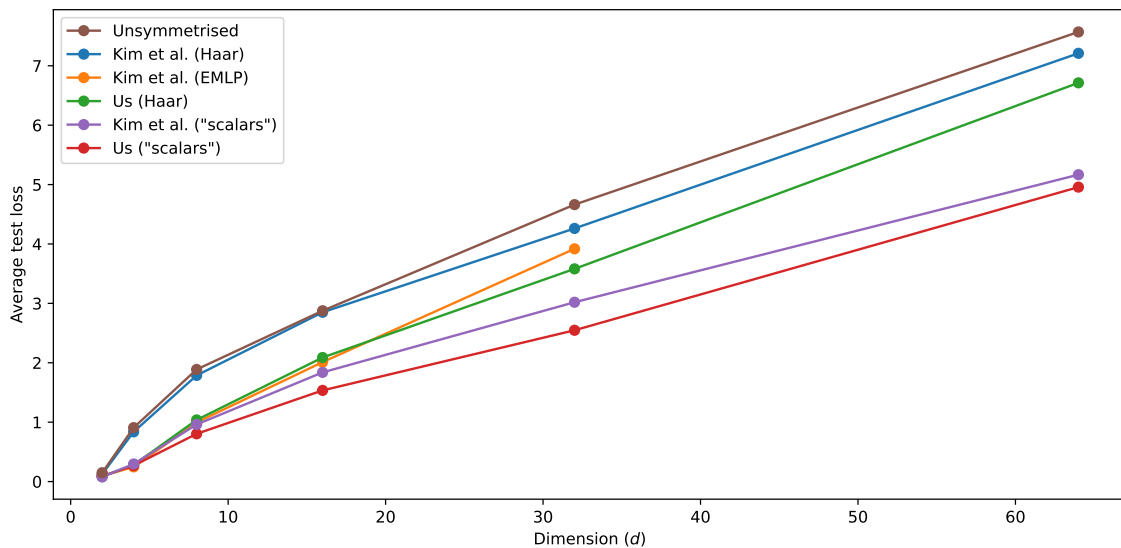

Figure 1: Average test loss obtained after training each model across the range of problem dimensions d considered. The final EMLP data point is missing because of the large memory requirements of its bilinear layers, which exceeded the capacity of our hardware.

measure, in this case). Finally, the remaining two additional baselines performed the worst, which is expected given their more simplistic architectures.

Acknowledgements

This work would not have been possible without John Cornish, Catherine Macaulay, and Rachael Morey, who supported me throughout and kept me focussed and on track. I am also very grateful to Paolo Perrone for his encouragement, enthusiasm, and helpful conversations. Finally, my many thanks to Sam Staton and his research group more generally for creating a welcoming and friendly community that has only made my enthusiasm for this topic grow.

References

- [AA22] Namrata Anand and Tudor Achim. *Protein Structure and Sequence Generation with Equivariant Denoising Diffusion Probabilistic Models*. 2022. arXiv: [2205.15019](https://arxiv.org/abs/2205.15019).
- [Bre+23] Johann Brehmer, Joey Bose, Pim de Haan, and Taco S Cohen. “EDGI: Equivariant Diffusion for Planning with Embodied Agents”. In: *Advances in Neural Information Processing Systems*. Ed. by A. Oh, T. Naumann, A. Globerson, K. Saenko, M. Hardt, and S. Levine. Vol. 36. Curran Associates, Inc., 2023, pp. 63818–63834. URL: https://proceedings.neurips.cc/paper_files/paper/2023/file/c95c049637c5c549c2a08e8d6dcbca4b-Paper-Conference.pdf.

- [Bro+17] Michael M. Bronstein, Joan Bruna, Yann LeCun, Arthur Szlam, and Pierre Vandergheynst. “Geometric Deep Learning: Going beyond Euclidean data”. In: *IEEE Signal Processing Magazine* 34.4 (2017), pp. 18–42. DOI: [10.1109/MSP.2017.2693418](https://doi.org/10.1109/MSP.2017.2693418).
- [Bro+21] Michael M. Bronstein, Joan Bruna, Taco Cohen, and Petar Velicković. *Geometric Deep Learning: Grids, Groups, Graphs, Geodesics, and Gauges*. 2021. arXiv: [2104.13478](https://arxiv.org/abs/2104.13478).
- [Bro06] Ronald Brown. *Topology and groupoids*. 2006.
- [BT20] Benjamin Bloem-Reddy and Yee Whye Teh. “Probabilistic symmetries and invariant neural networks”. In: *The Journal of Machine Learning Research* 21.1 (2020), pp. 3535–3595.
- [CJ19] Kenta Cho and Bart Jacobs. “Disintegration and Bayesian inversion via string diagrams”. In: *Mathematical Structures in Computer Science* 29.7 (Mar. 2019), pp. 938–971. DOI: [10.1017/s0960129518000488](https://doi.org/10.1017/s0960129518000488). URL: <https://doi.org/10.1017/2Fs0960129518000488>.
- [CW16] Taco Cohen and Max Welling. “Group Equivariant Convolutional Networks”. In: *Proceedings of The 33rd International Conference on Machine Learning*. Ed. by Maria Florina Balcan and Kilian Q. Weinberger. Vol. 48. Proceedings of Machine Learning Research. New York, New York, USA: PMLR, 20–22 Jun 2016, pp. 2990–2999. URL: <https://proceedings.mlr.press/v48/cohenc16.html>.
- [DLS24] Nadav Dym, Hannah Lawrence, and Jonathan W. Siegel. *Equivariant Frames and the Impossibility of Continuous Canonicalization*. 2024. arXiv: [2402.16077](https://arxiv.org/abs/2402.16077) [cs.LG].
- [FPR21] Tobias Fritz, Paolo Perrone, and Sharwin Rezagholi. “Probability, valuations, hyperspace: Three monads on top and the support as a morphism”. In: *Mathematical Structures in Computer Science* 31.8 (Sept. 2021), pp. 850–897. ISSN: 1469-8072. DOI: [10.1017/s0960129521000414](https://doi.org/10.1017/s0960129521000414). URL: <http://dx.doi.org/10.1017/S0960129521000414>.
- [FR20] Tobias Fritz and Eigil Fjeldgren Rischel. “Infinite products and zero-one laws in categorical probability”. In: *Compositionality* 2 (3 Aug. 2020). ISSN: 2631-4444. DOI: [10.32408/compositionality-2-3](https://doi.org/10.32408/compositionality-2-3). URL: <https://doi.org/10.32408/compositionality-2-3>.
- [Fri+23a] Tobias Fritz, Tomáš Gonda, Nicholas Gauguin Houghton-Larsen, Antonio Lorenzin, Paolo Perrone, and Dario Stein. “Dilations and information flow axioms in categorical probability”. In: *Mathematical Structures in Computer Science* 33.10 (Oct. 2023), pp. 913–957. ISSN: 1469-8072. DOI: [10.1017/s0960129523000324](https://doi.org/10.1017/s0960129523000324). URL: <http://dx.doi.org/10.1017/S0960129523000324>.
- [Fri+23b] Tobias Fritz, Tomáš Gonda, Antonio Lorenzin, Paolo Perrone, and Dario Stein. *Absolute continuity, supports and idempotent splitting in categorical probability*. 2023. arXiv: [2308.00651](https://arxiv.org/abs/2308.00651) [math.PR].

- [Fri+23c] Tobias Fritz, Tomáš Gonda, Paolo Perrone, and Eigil Fjeldgren Rischel. “Representable Markov categories and comparison of statistical experiments in categorical probability”. In: *Theoretical Computer Science* 961 (June 2023), p. 113896. DOI: [10.1016/j.tcs.2023.113896](https://doi.org/10.1016/j.tcs.2023.113896). URL: <https://doi.org/10.1016%2Fj.tcs.2023.113896>.
- [Fri20] Tobias Fritz. “A synthetic approach to Markov kernels, conditional independence and theorems on sufficient statistics”. In: *Advances in Mathematics* 370 (Aug. 2020), p. 107239. DOI: [10.1016/j.aim.2020.107239](https://doi.org/10.1016/j.aim.2020.107239). URL: <https://doi.org/10.1016%2Fj.aim.2020.107239>.
- [FWW21] Marc Finzi, Max Welling, and Andrew Gordon Gordon Wilson. “A Practical Method for Constructing Equivariant Multilayer Perceptrons for Arbitrary Matrix Groups”. In: *Proceedings of the 38th International Conference on Machine Learning*. Ed. by Marina Meila and Tong Zhang. Vol. 139. Proceedings of Machine Learning Research. PMLR, 18–24 Jul 2021, pp. 3318–3328. URL: <https://proceedings.mlr.press/v139/finzi21a.html>.
- [Gar+21] Victor Garcia Satorras, Emiel Hoogeboom, Fabian Fuchs, Ingmar Posner, and Max Welling. “E(n) Equivariant Normalizing Flows”. In: *Advances in Neural Information Processing Systems*. Ed. by M. Ranzato, A. Beygelzimer, Y. Dauphin, P.S. Liang, and J. Wortman Vaughan. Vol. 34. Curran Associates, Inc., 2021, pp. 4181–4192. URL: https://proceedings.neurips.cc/paper_files/paper/2021/file/21b5680d80f75a616096f2e791affac6-Paper.pdf.
- [Gir82] Michèle Giry. “A categorical approach to probability theory”. In: *Categorical Aspects of Topology and Analysis*. Ed. by B. Banaschewski. Berlin, Heidelberg: Springer Berlin Heidelberg, 1982, pp. 68–85. ISBN: 978-3-540-39041-1.
- [Hoo+22] Emiel Hoogeboom, Víctor Garcia Satorras, Clément Vignac, and Max Welling. “Equivariant Diffusion for Molecule Generation in 3D”. In: *Proceedings of the 39th International Conference on Machine Learning*. Ed. by Kamalika Chaudhuri, Stefanie Jegelka, Le Song, Csaba Szepesvari, Gang Niu, and Sivan Sabato. Vol. 162. Proceedings of Machine Learning Research. PMLR, 17–23 Jul 2022, pp. 8867–8887. URL: <https://proceedings.mlr.press/v162/hoogeboom22a.html>.
- [Kab+23] Sékou-Oumar Kaba, Arnab Kumar Mondal, Yan Zhang, Yoshua Bengio, and Siamak Ravanbakhsh. “Equivariance with Learned Canonicalization Functions”. In: *Proceedings of the 40th International Conference on Machine Learning*. Ed. by Andreas Krause, Emma Brunskill, Kyunghyun Cho, Barbara Engelhardt, Sivan Sabato, and Jonathan Scarlett. Vol. 202. Proceedings of Machine Learning Research. PMLR, 23–29 Jul 2023, pp. 15546–15566. URL: <https://proceedings.mlr.press/v202/kaba23a.html>.
- [Kal02] Olav Kallenberg. *Foundations of Modern Probability*. 2nd ed. Springer, 2002.
- [KB14] Diederik P. Kingma and Jimmy Ba. “Adam: A Method for Stochastic Optimization”. In: *arXiv e-prints*, arXiv:1412.6980 (Dec. 2014), arXiv:1412.6980. DOI: [10.48550/arXiv.1412.6980](https://doi.org/10.48550/arXiv.1412.6980). arXiv: [1412.6980](https://arxiv.org/abs/1412.6980) [cs.LG].

- [Kim+23] Jinwoo Kim, Tien Dat Nguyen, Ayhan Suleymanzade, Hyeokjun An, and Seunghoon Hong. *Learning Probabilistic Symmetrization for Architecture Agnostic Equivariance*. 2023. arXiv: [2306.02866](https://arxiv.org/abs/2306.02866) [cs.LG].
- [KW22] Diederik P Kingma and Max Welling. *Auto-Encoding Variational Bayes*. 2022. arXiv: [1312.6114](https://arxiv.org/abs/1312.6114) [stat.ML].
- [Lei08] Tom Leinster. *Doing without diagrams*. <https://www.maths.ed.ac.uk/~tl/elements.pdf>. Version 10 March 2008. Available online at University of Edinburgh, School of Mathematics. Mar. 2008. URL: <https://www.maths.ed.ac.uk/~tl/elements.pdf> (visited on 04/01/2024).
- [MP22] Sean Moss and Paolo Perrone. “Probability monads with submonads of deterministic states”. In: *Proceedings of the 37th Annual ACM/IEEE Symposium on Logic in Computer Science*. LICS ’22. ACM, Aug. 2022. DOI: [10.1145/3531130.3533355](https://doi.org/10.1145/3531130.3533355). URL: <http://dx.doi.org/10.1145/3531130.3533355>.
- [MP23] Sean Moss and Paolo Perrone. “A category-theoretic proof of the ergodic decomposition theorem”. In: *Ergodic Theory and Dynamical Systems* 43.12 (Feb. 2023), pp. 4166–4192. ISSN: 1469-4417. DOI: [10.1017/etds.2023.6](https://doi.org/10.1017/etds.2023.6). URL: <http://dx.doi.org/10.1017/etds.2023.6>.
- [MPC97] J.P. May, R.J. Piacenza, and M. Cole. *Equivariant Homotopy and Cohomology Theory: Dedicated to the Memory of Robert J. Piacenza*. Regional conference series in mathematics. American Mathematical Society, 1997. ISBN: 9780821803197. URL: <https://books.google.co.uk/books?id=K0cZYVxkQ09C>.
- [Mur+19a] Ryan Murphy, Balasubramaniam Srinivasan, Vinayak Rao, and Bruno Ribeiro. “Relational Pooling for Graph Representations”. In: *Proceedings of the 36th International Conference on Machine Learning*. Ed. by Kamalika Chaudhuri and Ruslan Salakhutdinov. Vol. 97. Proceedings of Machine Learning Research. PMLR, Sept. 2019, pp. 4663–4673. URL: <https://proceedings.mlr.press/v97/murphy19a.html>.
- [Mur+19b] Ryan L. Murphy, Balasubramaniam Srinivasan, Vinayak Rao, and Bruno Ribeiro. “Janossy Pooling: Learning Deep Permutation-Invariant Functions for Variable-Size Inputs”. In: *International Conference on Learning Representations*. 2019. URL: <https://openreview.net/forum?id=BJluy2RcFm>.
- [Per21] Paolo Perrone. *Notes on Category Theory with examples from basic mathematics*. 2021. arXiv: [1912.10642](https://arxiv.org/abs/1912.10642) [math.CT].
- [Pun+22] Omri Puny, Matan Atzmon, Edward J. Smith, Ishan Misra, Aditya Grover, Heli Ben-Hamu, and Yaron Lipman. “Frame Averaging for Invariant and Equivariant Network Design”. In: *International Conference on Learning Representations*. 2022. URL: <https://openreview.net/forum?id=zIUyj55nXR>.
- [Rie17] Emily Riehl. *Category theory in context*. Courier Dover Publications, 2017.

- [RSP17] Siamak Ravanbakhsh, Jeff Schneider, and Barnabás Póczos. “Equivariance Through Parameter-Sharing”. In: *Proceedings of the 34th International Conference on Machine Learning*. Ed. by Doina Precup and Yee Whye Teh. Vol. 70. Proceedings of Machine Learning Research. PMLR, June 2017, pp. 2892–2901. URL: <https://proceedings.mlr.press/v70/ravanbakhsh17a.html>.
- [Sel10] P. Selinger. “A Survey of Graphical Languages for Monoidal Categories”. In: *New Structures for Physics*. Springer Berlin Heidelberg, 2010, pp. 289–355. DOI: [10.1007/978-3-642-12821-9_4](https://doi.org/10.1007/978-3-642-12821-9_4). URL: https://doi.org/10.1007/978-3-642-12821-9_4.
- [SS22] Hisham Sati and Urs Schreiber. *Equivariant principal infinity-bundles*. 2022. arXiv: [2112.13654](https://arxiv.org/abs/2112.13654) [math.AT].
- [Vil+21] Soledad Villar, David W Hogg, Kate Storey-Fisher, Weichi Yao, and Ben Blum-Smith. “Scalars are universal: Equivariant machine learning, structured like classical physics”. In: *Advances in Neural Information Processing Systems*. Ed. by A. Beygelzimer, Y. Dauphin, P. Liang, and J. Wortman Vaughan. 2021. URL: <https://openreview.net/forum?id=ba27-RzNaIv>.
- [Xu+22] Minkai Xu, Lantao Yu, Yang Song, Chence Shi, Stefano Ermon, and Jian Tang. “GeoDiff: A Geometric Diffusion Model for Molecular Conformation Generation”. In: *International Conference on Learning Representations*. 2022. URL: <https://openreview.net/forum?id=PzcvxEMzvQC>.
- [Yar18] Dmitry Yarotsky. *Universal approximations of invariant maps by neural networks*. 2018. arXiv: [1804.10306](https://arxiv.org/abs/1804.10306) [cs.NE].
- [Yim+23] Jason Yim, Brian L. Trippe, Valentin De Bortoli, Emile Mathieu, Arnaud Doucet, Regina Barzilay, and Tommi Jaakkola. “SE(3) diffusion model with application to protein backbone generation”. In: *Proceedings of the 40th International Conference on Machine Learning*. Ed. by Andreas Krause, Emma Brunskill, Kyunghyun Cho, Barbara Engelhardt, Sivan Sabato, and Jonathan Scarlett. Vol. 202. Proceedings of Machine Learning Research. PMLR, 23–29 Jul 2023, pp. 40001–40039. URL: <https://proceedings.mlr.press/v202/yim23a.html>.

We include here the proofs of various results, organised by their corresponding section from the main text.

A Group theory in Markov categories

A.1 Proof of Proposition 3.1

Proof. For all measurable $B \subseteq Y$, $g \in G$, and $x \in X$, it follows that

$$\begin{aligned}
 k(B|g \cdot x) &= \int_B p(y|g \cdot x) \mu(dy) \\
 &= \int_B p(y|g \cdot x) (g \cdot \mu)(dy) \\
 &= \int_{g^{-1} \cdot B} p(g \cdot y|g \cdot x) \mu(dy) \\
 &= \int_{g^{-1} \cdot B} p(y|x) \mu(dy) \\
 &= k(g^{-1} \cdot B|x) \\
 &= (g \cdot k)(B|x),
 \end{aligned}$$

where the third step uses the law of the unconscious statistician. (Here $g^{-1} \cdot B := \{g^{-1} \cdot y : y \in B\}$.) By Example 3.11, this shows that k is equivariant. \square

A.2 Results on orbit maps

Proposition A.1. *Let \mathbf{C} be a Markov category, and suppose the following is a coequaliser diagram in \mathbf{C} :*

$$X \begin{array}{c} \xrightarrow{f} \\ \xrightarrow{g} \end{array} Y \xrightarrow{h} Z$$

If f , g , and h , are deterministic, then this is also a coequaliser diagram in \mathbf{C}_{det} . Additionally, if \mathbf{C} is positive and f and g are deterministic, then h is deterministic.

Proof. For the first statement, suppose f , g , and h are deterministic, and let $k : Y \rightarrow W$ be a morphism in \mathbf{C}_{det} such that $k \circ f = k \circ g$. Then there is a unique morphism $k' : Z \rightarrow W$ in \mathbf{C} such that $k = k' \circ h$. Since h is a coequaliser, it is an epimorphism. By [FR20, Lemma 10.9], it follows that k' is deterministic, and hence a morphism in \mathbf{C}_{det} also.

For the second statement, suppose \mathbf{C} is positive and f and g are deterministic. Then we have

The diagram illustrates the equality of four expressions. Each expression consists of a morphism from X to a central dot, and two morphisms from the dot to Z . The first expression has f from X to the dot, and h from the dot to Z on both sides. The second expression has f from X to the dot, and h from the dot to Z on both sides. The third expression has g from X to the dot, and h from the dot to Z on both sides. The fourth expression has g from X to the dot, and h from the dot to Z on both sides. The expressions are connected by equals signs, indicating their equality.

where we use the fact that f and g are deterministic in the first and third steps. Since h is a coequaliser, it follows that there exists a unique $k : Z \rightarrow Z \otimes Z$ in \mathbf{C} such that

$$\begin{array}{c} Z & Z \\ | & | \\ \boxed{k} \\ | \\ \boxed{h} \\ | \\ Y \end{array} = \begin{array}{c} Z & Z \\ | & | \\ \boxed{h} & \boxed{h} \\ \curvearrowright & \curvearrowleft \\ \bullet \\ | \\ Y \end{array} \quad (48)$$

Marginalising out each output in turn and using the fact that h is epi (since it is a coequaliser), we obtain

$$\begin{array}{c} Z \\ | \\ \boxed{k} \\ | \\ Z \end{array} = \begin{array}{c} Z \\ | \\ \bullet \\ | \\ \boxed{k} \\ | \\ Z \end{array} = \begin{array}{c} Z \\ | \\ Z \end{array}$$

Since \mathbf{C} is positive, [Fri+23a, Theorem 2.8] now implies that $k = \text{copy}_Z$. Substituting this into (48), it follows that h is deterministic. \square

Proposition A.2. *Let \mathbf{C} be a Markov category, and $\alpha : G \otimes X \rightarrow X$ an action and Y an object in \mathbf{C} . If $q : X \rightarrow X/G$ is an orbit map with respect to α , then $q \otimes \text{id}_Y : X \otimes Y \rightarrow X/G \otimes Y$ is an orbit map with respect to the action*

$$\begin{array}{c} X & Y \\ | & | \\ \boxed{\alpha} & | \\ | & | \\ G & X & Y \end{array} \quad (49)$$

Proof. To see that (49) is indeed an action, observe that it is just the diagonal action (see Example 3.8) obtained from α and the trivial action ε . We now show the result in the case that \mathbf{C} is strictly monoidal, with the general case being similar but notationally more complex. Since q is an orbit map, it is a coequaliser. Moreover, it is preserved by the functor $(-) \otimes Y$, and so the following is also a coequaliser diagram:

$$G \otimes X \otimes Y \begin{array}{c} \xrightarrow{\alpha \otimes \text{id}_Y} \\ \xrightarrow{\varepsilon \otimes \text{id}_Y} \end{array} X \otimes Y \xrightarrow{q \otimes \text{id}_Y} X/G \otimes Y. \quad (50)$$

Observe that $\alpha \otimes \text{id}_Y$ is just (49), and $\varepsilon \otimes \text{id}_Y$ is just the trivial action on $X \otimes Y$. This shows that $q \otimes \text{id}_Y$ is a coequaliser of the form required to be an orbit map with respect to (49). It remains to show that this is preserved by every functor $(-) \otimes Z$. But this holds because we have $\text{id}_Y \otimes \text{id}_Z = \text{id}_{Y \otimes Z}$, and so the image of (50) under $(-) \otimes Z$ is just

$$G \otimes X \otimes Y \otimes Z \begin{array}{c} \xrightarrow{\alpha \otimes \text{id}_{Y \otimes Z}} \\ \xrightarrow{\varepsilon \otimes \text{id}_{Y \otimes Z}} \end{array} X \otimes Y \otimes Z \xrightarrow{q \otimes \text{id}_{Y \otimes Z}} X/G \otimes Y \otimes Z,$$

which is again a coequaliser diagram since q is an orbit map. \square

A.3 Top has orbits

Proposition A.3. *Every action in Top admits an orbit map.*

Proof. We sketch the argument here, which uses standard ideas. Suppose $\alpha : G \otimes X \rightarrow X$ is any action in Top. Let $q : X \rightarrow X/G$ be as defined in Example 3.17, where now X/G is equipped with the final topology with respect to q , which is namely the finest topology that makes q continuous. Then q becomes a coequaliser of α and ε by a similar argument as was given in Example 3.17. (Slightly more care is needed in this case, because the final topology is in general not the only possible topology on X/G that makes q continuous.)

For the preservation condition, given another topological space Y , we must show that the following is also a coequaliser diagram:

$$(G \otimes X) \otimes Y \begin{array}{c} \xrightarrow{\alpha \otimes \text{id}_Y} \\ \xrightarrow{\varepsilon} \end{array} X \otimes Y \xrightarrow{q \otimes \text{id}_Y} X/G \otimes Y$$

Now, certainly q is a surjection, and it is also an open map [Bro06, 11.1.2]. Likewise, id_Y is an open surjection, and so it holds that $q \otimes \text{id}_Y$ is an open surjection too [Bro06, 4.2, Exercise 7]. Consequently $X/G \otimes Y$ must be equipped with the final topology with respect to $q \otimes \text{id}_Y$ [Bro06, 4.2.4]. From here, it may be shown that $q \otimes \text{id}_Y$ is a coequaliser using essentially the same argument as for q itself. \square

A.4 Proof of Theorem 3.1

Our goal in this section is to prove that TopStoch admits all orbit maps. Since TopStoch is the Kleisli category of a certain monad on Top [FPR21], this *almost* follows from Proposition A.3. In particular, some straightforward diagram chasing shows that an orbit map exists for every group action in TopStoch that is obtained by lifting some group action in Top via Proposition 3.5. However, we are not sure whether all actions in TopStoch arise in this way. This is because a deterministic Markov kernel is only required to be zero-one [Fri20, Example 10.4], and in general not all zero-one Markov kernels can be obtained by lifting some measurable function. (See [MP22, Example 3.9] for an example in the case of Meas and Stoch; a similar idea appears to hold for Top and TopStoch also.) We therefore provide a direct proof of the result here. Our approach takes its inspiration from [MP23, Proposition 3.7], which applies for Stoch. We show that, in the topological setting, this construction plays nicely with products, which is required for the preservation condition of orbit maps.

Throughout this section, we use the usual notation $\mathbb{1}_A$ to denote the indicator function of a measurable set A . We also recall that, for X a topological space, a function $f : X \rightarrow [0, 1]$ is *lower semicontinuous* if for every $t \in [0, 1]$ the following set is open:

$$f^{-1}((t, 1]) = \{x \in X \mid f(x) > t\}.$$

A.4.1 The invariant topology

Let $\alpha : G \otimes X \rightarrow X$ be an action in TopStoch. We will keep α fixed throughout this subsection. Given an open $U \subseteq X$, we will say that U is *invariant* if it holds that

$$\alpha(U|g, x) = 1 \quad \text{for all } x \in U \text{ and } g \in G.$$

We then have the following.

Proposition A.4. *The invariant open subsets of X form a topology.*

Proof. Certainly X and \emptyset are invariant (\emptyset vacuously so). Given a collection of invariant open $U_i \subseteq X$, letting $U := \bigcup_i U_i$, we have that U is open, and moreover if $g \in G$ and $x \in U_i$ for some i , then

$$\alpha(U|g, x) \geq \alpha(U_i|g, x) = 1,$$

which means U is invariant. Similarly, given invariant open sets U_1 and U_2 , their intersection $U_1 \cap U_2$ is open. Moreover, it satisfies $\alpha(U_1 \cap U_2|g, x) = 1$ since $\alpha(U_1|g, x) = \alpha(U_2|g, x) = 1$ and is hence invariant. \square

We may therefore define X/G to be the topological space whose underlying set of points is the same as X , but whose topology consists of the invariant open subsets of X . The following result shows that the Borel σ -algebra generated by X/G is then a sub- σ -algebra of the invariant σ -algebra considered by [MP23, Definition 3.6].

Proposition A.5. *For all invariant open $U \subseteq X$, it holds that $\alpha(U|g, x) = \mathbb{1}_U(x)$ for all $g \in G$ and $x \in X$.*

Proof. Let U be open and invariant. By definition, $\alpha(U|g, x) = 1 = \mathbb{1}_U(x)$ if $x \in U$. On the other hand, if $x \notin U$, it holds for all $g \in G$ that (denoting the Markov kernel $(-)^{-1}$ by i)

$$\begin{aligned} 0 = \text{id}_X(U|x) &= \int \alpha(U|g', x') i(dg'|g) \alpha(dx'|g, x) \\ &\geq \int \mathbb{1}_U(x') \alpha(U|g', x') i(dg'|g) \alpha(dx'|g, x) \\ &= \int \mathbb{1}_U(x') i(dg'|g) \alpha(dx'|g, x) \\ &= \alpha(U|g, x). \end{aligned}$$

Here the second step applies the group axioms, and the fourth step uses the fact that U is invariant, so that $\alpha(U|g', x') = 1$ when $x' \in U$. It follows that $\alpha(U|g, x) = 0 = \mathbb{1}_U(x)$ in this case as well. \square

Suppose $U \subseteq X$ is open, but not necessarily invariant. The following construction provides a canonical way to obtain an invariant open set containing U . In particular, we will define

$$G \cdot U := \{x \in X \mid \alpha(U|g, x) = 1 \text{ for some } g \in G\}.$$

We then have the following.

Proposition A.6. *For all open $U \subseteq X$, it holds that $G \cdot U$ is open and invariant, and $U \subseteq G \cdot U$.*

Proof. Let $U \subseteq X$ be open. Given $g \in G$, denote $\alpha_g(x) := \alpha(U|g, x)$. Since α is deterministic, it is zero-one [Fri20, Example 10.4], and so

$$G \cdot U = \bigcup_{g \in G} \alpha_g^{-1}(\{1\}) = \bigcup_{g \in G} \alpha_g^{-1}((0, 1]).$$

A standard argument shows $x \mapsto \alpha_g(x)$ is lower semicontinuous (since $(x, g) \mapsto \alpha_g(x)$ is). It follows that each $\alpha_g^{-1}((0, 1])$ is open, and hence so is $G \cdot U$, being the union of open sets.

To see that $G \cdot U$ is invariant, let $x \in G \cdot U$ and $g \in G$. By definition, there exists $h \in G$ such that (denoting the Markov kernels $(-)^{-1}$ and $*$ by i and m)

$$\begin{aligned} 1 &= \alpha(U|h, x) = \int \alpha(U|h, x'') \alpha(x''|g', x') i(dg'|g) \alpha(dx'|g, x) \\ &= \int \alpha(U|h', x') m(dh'|h, g') i(dg'|g) \alpha(dx'|g, x) \\ &= \int \mathbb{1}_{G \cdot U}(x') \alpha(U|h', x') m(dh'|h, g') i(dg'|g) \alpha(dx'|g, x) \\ &\leq \alpha(G \cdot U|g, x). \end{aligned}$$

Here the second and third steps apply the group axioms, while the fourth uses the fact that $\alpha(U|h', x') = 0$ whenever $x' \notin G \cdot U$, by the definition of $G \cdot U$.

Finally, to show that $U \subseteq G \cdot U$, let $x \in U$. Then the group axioms imply

$$\int \alpha(U|g, x) e(dg|\bullet) = 1,$$

where \bullet denotes the unique element of the one-point space I . Hence there exists $g \in G$ with $\alpha(U|g, x) = 1$, so that $x \in G \cdot U$. \square

Our key reason for developing this construction in `TopStoch` is that the invariant topology plays well with products. To make this precise, let Y be any topological space. Then we always obtain an action as follows:

$$\begin{array}{ccc} & X & Y \\ & \downarrow & \downarrow \\ \boxed{\alpha} & & \\ & \downarrow & \downarrow \\ G & X & Y \end{array} \quad (51)$$

Analogously to X/G , we will denote by $(X \otimes Y)/G$ the topological space consisting of $X \otimes Y$ equipped with the invariant topology induced by (51). We then obtain the following result.

Proposition A.7. *It holds that $(X \otimes Y)/G = X/G \otimes Y$.*

Proof. Suppose $V \subseteq X$ is open and invariant with respect to α , and $W \subseteq Y$ is open. Then by definition of the product topology, $V \times W$ is open in $X \otimes Y$. It is moreover easily verified that $V \times W$ is invariant with respect to (51). Since the rectangle sets form a base for the product topology, this shows that every open subset of $X/G \otimes Y$ is open in $(X \otimes Y)/G$.

Conversely, let $U \subseteq X \otimes Y$ be open and invariant with respect to $\alpha \otimes \text{id}_Y$. By definition of the product topology, we can write

$$U = \bigcup_i V_i \times W_i$$

for some open $V_i \subseteq X$ and $W_i \subseteq Y$. We claim that

$$U = \bigcup_i G \cdot V_i \times W_i, \quad (52)$$

from which it follows that U is open in $X/G \otimes Y$. Indeed, the \subseteq inclusion follows immediately by Proposition A.6. For the \supseteq inclusion, choose $x \in G \cdot V_i$ and $y \in W_i$ arbitrarily. Since U is invariant to (51), Proposition A.5 implies the following for all $g \in G$:

$$\begin{aligned} \mathbb{1}_U(x, y) &= (\alpha \otimes \text{id}_Y)(U|(g, x), y) \\ &\geq (\alpha \otimes \text{id}_Y)(V_i \times W_i|(g, x), y) \\ &= \alpha(V_i|g, x) \mathbb{1}_{W_i}(y) \\ &= \alpha(V_i|g, x). \end{aligned}$$

By definition of $G \cdot V_i$, there exists $g \in G$ such that $\alpha(V_i|g, x) = 1$. Hence we must have $\mathbb{1}_U(x, y) = 1$, and so $(x, y) \in U$. \square

A.4.2 Existence of orbit map coequalisers

Lemma A.1. *Suppose $\alpha : G \otimes X \rightarrow X$ be an action in TopStoch. Let X/G denote X equipped with the invariant topology induced by α , and define $q : X \rightarrow X/G$ by*

$$q(A|x) := \delta_x(A) \quad \text{for } x \in X \text{ and Borel } A \subseteq X/G,$$

where δ_x denotes the Dirac measure at x . Then q is a coequaliser of the parallel arrows $\alpha, \varepsilon : G \otimes X \rightrightarrows X$.

Proof. We first show that q is indeed a well-defined morphism in TopStoch. Certainly $A \mapsto q(A|x)$ is a probability measure for all $x \in X$. Additionally, since X/G is equipped with a coarser topology than X , its Borel σ -algebra is coarser than that of X also. Hence for Borel $A \subseteq X/G$, the function $X \rightarrow [0, 1]$ defined as

$$x \mapsto q(A|x) = \mathbb{1}_A(x) \tag{53}$$

is always measurable with respect to the Borel σ -algebra on X . It follows that q is a Markov kernel. Moreover, for invariant open $A \subseteq X$, the function (53) is lower semicontinuous with respect to the topology on X , since it is the indicator function of an open subset of X . This shows that q is a morphism $X \rightarrow X/G$ in TopStoch.

We now show that q is a coequaliser. For this, we must first show that $q \circ \alpha = q \circ \varepsilon$. This holds because for any invariant open $U \subseteq X$, as well as $x \in X$ and $g \in G$, we have

$$\begin{aligned} \int q(U|x') \alpha(dx'|g, x) &= \int \mathbb{1}_U(x') \alpha(dx'|g, x) \\ &= \alpha(U|g, x) \\ &= \mathbb{1}_U(x) \\ &= q(U|x) \\ &= \int q(U|x') \varepsilon(dx'|g, x), \end{aligned}$$

where the third step applies Lemma A.5. Since the invariant open sets generate the Borel σ -algebra on X/G , this shows $q \circ \alpha = q \circ \varepsilon$.

Now suppose $k : X \rightarrow Y$ in TopStoch also satisfies $k \circ \alpha = k \circ \varepsilon$. Then a morphism $k' : X/G \rightarrow Y$ satisfies $k' \circ q = k$ if and only if

$$\begin{aligned} k(V|x) &= \int k'(V|x') q(dx'|x) \\ &= \int k'(V|x') \delta_x(dx') \\ &= k'(V|x) \end{aligned}$$

for all $x \in X$ and open $V \subseteq Y$. We are therefore done if we can show that $x \mapsto k(V|x)$ is lower semicontinuous with respect to the topology on X/G , so that we may take $k' := k$. For this, choose any open $V \subseteq Y$ and $t \in [0, 1]$. We would like to show that

$$U := \{x \in X \mid k(V|x) > t\}$$

is an invariant open subset of X . Since k is a morphism $X \rightarrow Y$ in TopStoch and hence lower semicontinuous, certainly U is an open subset of X . To prove that U is invariant, we will show that $G \cdot U \subseteq U$, which is sufficient by Proposition A.6. Indeed, if $x \in G \cdot U$, then by definition there exists some $g \in G$ such that $\alpha(U|g, x) = 1$. This yields

$$\begin{aligned} k(V|x) &= \int k(V|x') \alpha(dx'|g, x) \\ &= \int_U k(V|x') \alpha(dx'|g, x) \\ &> t, \end{aligned}$$

where the first step uses the fact that $k \circ \alpha = k \circ \varepsilon$, and the third uses the definition of U . This gives $x \in U$, which is what we wanted to show. \square

A.4.3 Proof of Theorem 3.1

Proof. Suppose $\alpha : G \otimes X \rightarrow X$ is an action in TopStoch . By Lemma A.1, it holds that α and ε have a coequaliser $q : X \rightarrow X/G$ defined as $q(A|x) := \delta_x(A)$, where X/G denotes X equipped with the invariant topology induced by α . Moreover, since q is zero-one by definition, it is deterministic [Fri20, Example 10.4]. Now let Y be an arbitrary topological space. We wish to show that this coequaliser is preserved by the functor $(-)\otimes Y$. Applying Lemma A.1 again, now with respect to the action (51), we also obtain the following coequaliser diagram:

$$(G \otimes X) \otimes Y \begin{array}{c} \xrightarrow{\alpha \otimes \text{id}_Y} \\ \xrightarrow{\varepsilon} \end{array} X \otimes Y \xrightarrow{r} (X \otimes Y)/G$$

where $(X \otimes Y)/G$ denotes $X \otimes Y$ equipped with the invariant topology induced by (51), and $r(A|x, y) := \delta_{(x,y)}(A)$. From Proposition A.7, we know that

$$(X \otimes Y)/G = X/G \otimes Y.$$

Additionally, given Borel $A \subseteq X$ and $B \subseteq Y$, we have

$$\begin{aligned} r(A \times B|x, y) &= \delta_{(x,y)}(A \times B) \\ &= \delta_x(A) \delta_y(B) \\ &= q(A|x) \text{id}_Y(B|y). \end{aligned}$$

This shows $r = q \otimes \text{id}_Y$, and the result now follows. \square

A.5 Orbit maps from coequalisers

Proposition A.8. *Let $\alpha : G \otimes X \rightarrow X$ be an action in a Markov category \mathbf{C} . If α admits some orbit map, then every coequaliser q of the form*

$$G \otimes X \begin{array}{c} \xrightarrow{\alpha} \\ \xrightarrow{\varepsilon} \end{array} X \xrightarrow{q} X/G \quad (54)$$

is an orbit map.

Proof. Let $r : X \rightarrow Z$ be an orbit map for α , and suppose $q : X \rightarrow X/G$ a coequaliser of the form (54). Since r is also a coequaliser, there exists a unique morphism q' such that the triangle in the following diagram commutes:

$$\begin{array}{ccc} G \otimes X & \begin{array}{c} \xrightarrow{\alpha} \\ \xrightarrow{\varepsilon} \end{array} & X & \xrightarrow{r} & Z \\ & & \searrow q & \cong \downarrow q' & \downarrow \\ & & & & X/G \end{array}$$

Here q' is moreover an isomorphism by the Yoneda lemma since q is a coequaliser. Likewise, since r is an orbit map, $r \otimes \text{id}_Y$ is a coequaliser, and so there exists a unique morphism q'' such that the triangle below commutes:

$$\begin{array}{ccc} (G \otimes X) \otimes Y & \begin{array}{c} \xrightarrow{\alpha \otimes \text{id}_Y} \\ \xrightarrow{\varepsilon \otimes \text{id}_Y} \end{array} & X \otimes Y & \xrightarrow{r \otimes \text{id}_Y} & Z \otimes Y \\ & & \searrow q \otimes \text{id}_Y & \cong \downarrow q'' & \downarrow \\ & & & & X/G \otimes Y \end{array}$$

By uniqueness, we must have $q'' = q' \otimes \text{id}_Y$, which is then an isomorphism since q' is. It follows that $q \otimes \text{id}_Y$ is a coequaliser of the parallel arrows in this last diagram, which shows that (54) is preserved by the functor $(-) \otimes Y$. \square

A.6 Coset maps for semidirect products

Proposition A.9. *Let \mathbf{C} be a Markov category, and $N \rtimes_{\rho} H$ a semidirect product in \mathbf{C} . Adopting the notation of Example 3.23, it holds that i_N and i_H are both homomorphisms. Moreover, p_H is an i_N -coset map, and p_N is an i_H -coset map.*

Proof. A standard argument shows that i_N and i_H are homomorphisms when $\mathbf{C} = \mathbf{Set}$, which translates to the general case by Remark 3.2. We prove that p_H is an i_N -coset map, with p_N being similar. For this, we must first prove that p_H is a coequaliser of the form

$$N \otimes (N \rtimes_{\rho} H) \begin{array}{c} \xrightarrow{\alpha} \\ \xrightarrow{\varepsilon} \end{array} N \rtimes_{\rho} H \xrightarrow{p_H} H \quad (55)$$

where α denotes the action

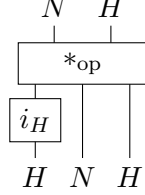

This firstly requires showing that p_H is invariant with respect to α , so that $p_H \circ \alpha = p_H \circ \varepsilon$. By Remark 3.2, it suffices to do so when $\mathbf{C} = \mathbf{Set}$, where for $n, n' \in N$ and $h \in H$ we have

$$\begin{aligned} p_H(n \cdot (n', h)) &= p_H((n', h) (n^{-1}, e_H)) \\ &= p_H(n' \rho(h, n^{-1}), h) \\ &= h \\ &= p_H(n', k). \end{aligned}$$

Next, suppose we have $m : N \rtimes_{\rho} H \rightarrow Y$ in \mathbf{C} that is also invariant to α . Then

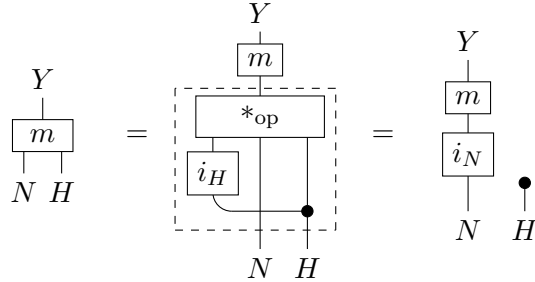

Here the first step holds because m is invariant. The second step follows from some basic manipulations: in \mathbf{Set} , letting ψ denote the dashed box, we have for $n \in N$ and $h \in H$

$$\begin{aligned} \psi(n, h) &= (n, h) i_H(h)^{-1} \\ &= (n, h) (e_N, h^{-1}) \\ &= (n, hh^{-1}) \\ &= (n, e_H). \end{aligned}$$

This shows that $m = (m \circ i_N) \circ p_H$. Since p_H is easily seen to be an epimorphism, it follows that $m \circ i_N$ is unique with this property. All up, this means (55) is a coequaliser diagram. A similar argument shows that this is preserved by every functor $(-)\otimes Y$, from which it follows that p_H is an i_N -coset map. \square

A.7 Induced actions on orbits and cosets

Proposition A.10. *Let \mathcal{C} be a Markov category, and $\alpha : G \otimes X \rightarrow X$ and $\beta : H \otimes X \rightarrow X$ actions in \mathcal{C} that commute in the sense of Remark 3.4 from the main text. If $q : X \rightarrow X/H$ is an orbit map for β , then there exists a unique action $\alpha/H : G \otimes X/H \rightarrow X/H$ that makes q equivariant with respect to G as follows:*

$$\begin{array}{c} X/H \\ \downarrow \\ \boxed{q} \\ \downarrow \\ \boxed{\alpha} \\ \downarrow \quad \downarrow \\ G \quad X \end{array} = \begin{array}{c} X/H \\ \downarrow \\ \boxed{\alpha/H} \\ \downarrow \quad \downarrow \\ \boxed{q} \\ \downarrow \\ G \quad X \end{array} \quad (56)$$

Proof. The idea is that we obtain α/H as the unique morphism in \mathcal{C}_{det} that makes the square below commute:

$$\begin{array}{ccccc} G \otimes (H \otimes X) & \xrightarrow{\text{id}_G \otimes \beta} & G \otimes X & \xrightarrow{\text{id}_G \otimes q} & G \otimes X/H \\ & \xrightarrow{\text{id}_G \otimes \varepsilon} & \downarrow \alpha & & \downarrow \alpha/H \\ & & X & \xrightarrow{q} & X/H \end{array} \quad (57)$$

Notice that this says that (56) holds. Now, by the preservation condition of orbit maps, it holds that $\text{id}_G \otimes q$ is a coequaliser in \mathcal{C} of the parallel arrows shown. As such, α/H exists uniquely in \mathcal{C} whenever

$$q \circ \alpha \circ (\text{id}_G \otimes \beta) = q \circ \alpha \circ (\text{id}_G \otimes \varepsilon).$$

By Remark 3.2, it suffices to show this in Set , where for $g \in G$, $h \in H$, and $x \in X$ we have simply

$$q(g \cdot (h \cdot x)) = q(h \cdot (g \cdot x)) = q(g \cdot x).$$

where the first step uses the assumption that α and β commute, and the second uses the fact that q is invariant to β .

We are therefore done if we can show that α/H is an action. By Proposition A.1, we know that α/H is deterministic, since all the other morphisms appearing in (57) are. To see that α/H is associative, observe that

$$\begin{array}{c} X/H \\ \downarrow \\ \boxed{\alpha/H} \\ \downarrow \quad \downarrow \\ G \quad G \quad X \end{array} = \begin{array}{c} X/H \\ \downarrow \\ \boxed{q} \\ \downarrow \\ \boxed{\alpha} \\ \downarrow \quad \downarrow \\ G \quad G \quad X \end{array} = \begin{array}{c} X/H \\ \downarrow \\ \boxed{q} \\ \downarrow \\ \boxed{\alpha} \\ \downarrow \quad \downarrow \\ \boxed{*} \quad G \quad X \end{array} = \begin{array}{c} X/H \\ \downarrow \\ \boxed{\alpha/H} \\ \downarrow \quad \downarrow \\ \boxed{*} \quad G \quad X \end{array}$$

Here the first step uses (56) twice, the second uses associativity of α , and the third uses (56) again. Now, since q is an orbit map, $\text{id}_{K \otimes K} \otimes q$ is a coequaliser. Since all coequalisers are epimorphisms, it follows that both sides here are equal even when q is removed, which shows associativity. A similar argument shows that α/H is unital and completes the proof. \square

Proposition A.11. *Under the same setup of Proposition A.10, let $k/H : X/H \rightarrow Y$ be a morphism in \mathbf{C} such that $k/H \circ q : X \rightarrow Y$ is equivariant with respect to α and some additional G -action $\alpha_Y : G \otimes Y \rightarrow Y$. Then k/H is equivariant with respect to α/H and α_Y also.*

Proof. We have

$$\begin{array}{c} Y \\ | \\ \boxed{k/H} \\ | \\ \boxed{\alpha/H} \\ | \quad | \\ G \quad \boxed{q} \\ | \\ X \end{array} = \begin{array}{c} Y \\ | \\ \boxed{k/H} \\ | \\ \boxed{q} \\ | \\ \boxed{\alpha} \\ | \quad | \\ G \quad X \end{array} = \begin{array}{c} Y \\ | \\ \boxed{\alpha_Y} \\ | \quad | \\ \boxed{k/H} \\ | \\ \boxed{q} \\ | \\ X \end{array}$$

where the first step uses the fact that q is equivariant by Proposition A.10, and the second step uses the assumption that $k/H \circ q$ is equivariant. Since q is an orbit map, $\text{id}_G \otimes q$ is a coequaliser, and hence an epimorphism. It follows that both sides are equal when q is removed, which gives the result. \square

A.7.1 Proof of Proposition 3.4

Proof. We first show that the action $*$ of G on itself by left multiplication commutes with the action

$$\begin{array}{c} G \\ | \\ \boxed{*_{\text{op}}} \\ | \quad | \\ \boxed{\varphi} \quad | \\ H \quad G \end{array}$$

used in the definition of a φ -coset map. By Remark 3.2, it suffices to show this in Set , where for all $g, g' \in G$ and $h \in H$ we have

$$g \cdot (h \cdot g') = g \cdot (g' \varphi(h)^{-1}) = g(g' \varphi(h)^{-1}) = (gg') \varphi(h)^{-1} = h \cdot (gg') = h \cdot (g \cdot g').$$

The result now follows directly from Proposition A.10. \square

A.8 Proof of Proposition 3.5

Proof. Let $\iota : \mathbf{C} \rightarrow \mathbf{D}$ denote the standard inclusion functor, i.e. the left adjoint of the Kleisli adjunction (see e.g. [Per21, Section 5.1.2] for a definition). Then ι is strict symmetric monoidal [Fri20, Proposition 3.1], and so for any group G in \mathbf{C} with operations

$$* : G \otimes G \rightarrow G \quad e : I_{\mathbf{C}} \rightarrow G \quad (-)^{-1} : G \otimes G$$

we obtain an object $\iota(G)$ in \mathbf{D} along with morphisms

$$\iota(*) : \iota(G) \otimes \iota(G) \rightarrow \iota(G) \quad \iota(e) : I_{\mathbf{D}} \rightarrow \iota(G) \quad \iota((-)^{-1}) : \iota(G) \rightarrow \iota(G),$$

where I_C and $I_D = \iota(I_C)$ denote the monoidal units of C and D respectively. By functoriality of ι , these morphisms in D are deterministic and satisfy the group axioms. In this way $\iota(G)$ becomes a group in D . A similar argument shows that ι lifts group actions and equivariant morphisms. Finally, ι lifts orbit maps because it is a left adjoint and so preserves colimits [Per21, Corollary 4.3.2], and therefore preserves coequalisers in particular. \square

B Symmetrisation

Proposition B.1. *Let G be a group in a Markov category C . Then C^G as described in Definition 4.1 is always a Markov category.*

Proof. It is straightforward to check that the composition of equivariant morphisms is equivariant, and that identity morphisms are always equivariant when their domain and codomain are equipped with the same action of G . In this way, C^G is a category. It is also clear that \otimes is a bifunctor on C^G . We therefore only need to show that the structure maps as defined for C^G satisfy the axioms of a Markov category (including those of a symmetric monoidal category). By definition, these structure maps are inherited from C , and so by [Fri20, Lemma 10.12] are all deterministic, which means we can equivalently show this for $(C_{\text{det}})^G$. But now the latter is just the Eilenberg-Moore category of the action monad $G \otimes (-)$ on C_{det} (see e.g. [Per21, Section 5.2]), which is cartesian monoidal [Fri20, Remark 10.13]. Since the forgetful functor $(C_{\text{det}})^G \rightarrow C_{\text{det}}$ is monadic, it creates limits [Rie17, Theorem 5.6.5], and so this cartesian monoidal structure lifts to $(C_{\text{det}})^G$ in the way described in Definition 4.1. \square

C A general methodology

C.1 Proof of Theorem 5.1

Remark C.1. Recall from Remark 3.2 that the Yoneda Lemma allows us to lift equations that hold for all groups, actions, etc. in Set to equations that hold more generally in the deterministic subcategory of an arbitrary Markov category. At several points in this subsection, we will abuse this technique by applying it even when some morphisms involved are not deterministic. This will streamline our proofs considerably, which become long-winded when expressed in terms of string diagrams. It will also demonstrate how our construction follows the classical set-theoretic arguments, which are standard [MPC97, Chapter I.1]. In the few cases where we do this (which we will flag), it will be clear how to translate our set-theoretic manipulations into a general string-diagrammatic argument. Our approach here may therefore be regarded essentially as a convenient shorthand for the “real” proof. A more formal justification may be possible: the key idea seems to be that, in cases where this approach is valid, we do not reuse the output of any nondeterministic morphism more than once, which seems to be where potential issues could arise.

Lemma C.1. *Let C be a Markov category, and $\varphi : H \rightarrow G$ a homomorphism and $q : G \rightarrow G/H$ a φ -coset map in C . For all $k : R_\varphi(X, \alpha_X) \rightarrow R_\varphi(Y, \alpha_Y)$ in C^H , there exists a unique*

$k^\sharp : G/H \otimes X \rightarrow Y$ in \mathbf{C} such that

$$\begin{array}{c} Y \\ | \\ \boxed{k^\sharp} \\ | \\ \boxed{q} \\ | \\ G \quad X \end{array} = \begin{array}{c} Y \\ | \\ \boxed{\alpha_Y} \\ | \\ \boxed{k} \\ | \\ \boxed{\alpha_X} \\ | \\ \boxed{(-)^{-1}} \\ | \\ G \quad X \end{array} \quad (58)$$

Proof. For brevity, let $\rho : H \otimes (G \otimes X) \rightarrow G \otimes X$ denote the following:

$$\begin{array}{c} G \quad X \\ | \quad | \\ \boxed{*_{\text{op}}} \\ | \quad | \\ \boxed{\varphi} \quad | \\ | \quad | \\ G \quad G \quad X \end{array} \quad (59)$$

This is seen to be the diagonal action (Example 3.8) obtained from the action (24) and the trivial action on X . Also denote by $m : G \otimes X \rightarrow Y$ denote the right-hand side of (58). We claim that $m \circ \rho = m \circ \varepsilon$, or in other words that m is invariant with respect to ρ . Noting the caveat of Remark C.1, we show this in \mathbf{Set} , where for $g \in G$, $h \in H$, and $x \in X$ we have

$$\begin{aligned} m(h \cdot (g, x)) &= m(g \varphi(h)^{-1}, x) \\ &= (g \varphi(h)^{-1}) \cdot k((g \varphi(h)^{-1})^{-1} \cdot x) \\ &= g \cdot (h^{-1} \cdot k(h \cdot (g \cdot x))) \\ &= g \cdot (h^{-1} \cdot h \cdot k(g \cdot x)) \\ &= g \cdot k(g \cdot x) \\ &= m(g, x). \end{aligned}$$

Here the first two steps apply the definitions of ρ and m , and the third uses the definition of the H -actions that equip $R_\varphi(X, \alpha_X)$ and $R_\varphi(Y, \alpha_Y)$. The fourth step then uses the fact that k is H -equivariant. From invariance of m and the universal property of orbit maps, we obtain a unique morphism k^\sharp in \mathbf{C} such that the triangle in the following diagram commutes:

$$\begin{array}{ccccc} H \otimes (G \otimes X) & \xrightarrow{\rho} & G \otimes X & \xrightarrow{q \otimes \text{id}_X} & G/H \otimes X \\ & \xrightarrow{\varepsilon} & & & \downarrow \text{---} k^\sharp \\ & & & \searrow m & Y \end{array}$$

The commuting triangle here says exactly that (58) holds, which gives the result. \square

Lemma C.2. *The morphism k^\sharp described in Lemma C.1 is always a morphism in \mathcal{C}^G of the form*

$$k^\sharp : (G/H, */H) \otimes (X, \alpha_X) \rightarrow (Y, \alpha_Y)$$

where $*/H : G \otimes G/H \rightarrow G/H$ denotes the unique action induced by Proposition 3.4.

Proof. We adopt the same notation as in the proof of Lemma C.1. By definition of \mathcal{C}^G , the action that equips $(G, */H) \otimes (X, \alpha_X)$ is as follows:

$$\begin{array}{ccc}
 & G & X \\
 & \downarrow & \downarrow \\
 & \boxed{*/H} & \boxed{\alpha_X} \\
 & \downarrow & \downarrow \\
 G & & G \\
 & \downarrow & \downarrow \\
 & G & X
 \end{array}
 \tag{60}$$

We will first show that this commutes with the H -action (59). By Remark 3.2, it suffices to do so in **Set**: given $g, g' \in G$, $h \in H$ and $x \in X$, we have

$$\begin{aligned}
 g \cdot (h \cdot (g', x)) &= g \cdot (g' \varphi(h)^{-1}, g \cdot x) \\
 &= (gg' \varphi(h)^{-1}, g \cdot x) \\
 &= h \cdot (gg', g \cdot x) \\
 &= h \cdot (g \cdot (g', x)).
 \end{aligned}$$

Next, we show that m is equivariant with respect to (60) and α_Y . Noting the caveat of Remark C.1, we demonstrate this in **Set**, where we have

$$\begin{aligned}
 m(g \cdot (g', x)) &= m(gg', g \cdot x) \\
 &= (gg') \cdot k((gg')^{-1} \cdot g \cdot x) \\
 &= g \cdot (g' \cdot k((g')^{-1} \cdot x)) \\
 &= g \cdot m(g', x).
 \end{aligned}$$

Now recall that $q \otimes \text{id}_X$ is an orbit map with respect to the H -action (59). Since (58) says

$$m = k^\sharp \circ (q \otimes \text{id}_X),$$

Proposition A.11 implies that k^\sharp is equivariant with respect to (60) and α_Y as desired. \square

C.1.1 Proof of Theorem 5.1

Proof. By Lemmas C.1 and C.2, the assignment $k \mapsto k^\sharp$ defines a function of the required form

$$\mathcal{C}^H(R_\varphi(X, \alpha_X), R_\varphi(Y, \alpha_Y)) \rightarrow \mathcal{C}^G((G/H, */H) \otimes (X, \alpha_X), (Y, \alpha_Y)). \tag{61}$$

We will show that this has an inverse $m \mapsto m \circ \eta$, where η is the morphism

$$\begin{array}{ccc}
 G/H & X & \\
 \downarrow & \downarrow & \\
 \boxed{\eta} & & \\
 \downarrow & & \\
 X & & \\
 & & \\
 & & G/H & X \\
 & & \downarrow & \downarrow \\
 & & \boxed{q} & \\
 & & \downarrow & \\
 & & \nabla e & \\
 & & \downarrow & \\
 & & X &
 \end{array}
 \quad := \quad$$

We will show the assignment $k \mapsto k^\sharp$ from Lemma A.1, which is a function of the form required by the statement of this Theorem by Lemma C.2, has an inverse, namely $m \mapsto m \circ \eta$.

First, we must check that $m \mapsto m \circ \eta$ is actually well-typed. We do so by showing that η is a morphism in \mathcal{C}^H of the following type:

$$R_\varphi(X, \alpha_X) \rightarrow R_\varphi((G/H, */H) \otimes (X, \alpha_X)). \quad (62)$$

Since R_φ is the identity on morphisms, it follows by definition of composition in \mathcal{C}^H that $m \circ \eta = R_\varphi(m) \circ \eta$ is a element of the left-hand side of (61) whenever m is an element of the right-hand side. To show (62), since all the morphisms involved in the definition of η are deterministic, Remark 3.2 allows us to work in Set , where for $h \in H$ and $x \in X$ we have

$$\begin{aligned} \eta(h \cdot x) &= (q(e), \varphi(h) \cdot x) \\ &= (q(\varphi(h) \varphi(h)^{-1}), \varphi(h) \cdot x) \\ &= (\varphi(h) \cdot q(\varphi(h)^{-1}), \varphi(h) \cdot x) \\ &= (\varphi(h) \cdot q(e), \varphi(h) \cdot x) \\ &= h \cdot \eta(x). \end{aligned}$$

Here the third step uses the fact that q is G -equivariant with respect to $*$ and $*/H$ by Proposition A.10, and the fourth uses fact that q is H -invariant since it is an orbit map.

Now we claim that for any morphisms k and m living in the left- and right-hand sides of (61) respectively, it holds that $k = m \circ \eta$ if and only if $m = k^\sharp$. The “if” direction establishes that $m \mapsto m \circ \eta$ is surjective, while the “only if” direction establishes injectivity. Noting the caveat of Remark C.1, we demonstrate the “if” direction in Set as follows, where for $x \in X$ we have

$$\begin{aligned} (k^\sharp \circ \eta)(x) &= k^\sharp(q(e), x) \\ &= e \cdot k(e^{-1} \cdot x) \\ &= k(x). \end{aligned}$$

Here the second step uses (58). For the “only if” direction, suppose $m \circ \eta = k$. From the uniqueness part of Lemma C.1, it follows that $m = k^\sharp$ if we can show that (58) holds when $m \circ \eta$ is substituted for k on its right-hand side. Again noting Remark C.1, we demonstrate this in Set : given any $g \in G$ and $x \in X$, we have

$$\begin{aligned} g \cdot (m \circ \eta)(g^{-1} \cdot x) &= g \cdot m(q(e), g^{-1} \cdot x) \\ &= m(g \cdot q(e), g \cdot g^{-1} \cdot x) \\ &= m(q(g), x), \end{aligned}$$

where the first step uses the assumption that m is H -equivariant, and the second uses the fact that q is G -equivariant with respect to $*$ and $*/H$. Since k^\sharp is unique with this property by Lemma C.1, it follows that $m = k^\sharp$ as desired, which gives the result. \square

Corollary C.1. *The assignment $k \mapsto k^\sharp$ from Theorem 5.1 defines an equivalence of categories between the full image of R_φ and the co-Kleisli category of the reader comonad $(G/H, */H) \otimes (-)$ on \mathcal{C}^G .*

Proof. Recall that the full image of R_φ and the co-Kleisli category of the reader comonad both have the same objects as \mathbf{C}^G . Moreover, their morphisms $(X, \alpha_X) \rightarrow (Y, \alpha_Y)$ are respectively the left- and right-hand sides of (61). Since each assignment $k \mapsto k^\sharp$ from Theorem 5.1 is a bijection, we are therefore done if we can show that this assignment is functorial, or in other words that the following holds for compatibly typed morphisms:

$$(m \circ k)^\sharp = m^\sharp \circ_{\text{ck}} k^\sharp, \quad (63)$$

where the right-hand side denotes co-Kleisli composition. But now observe

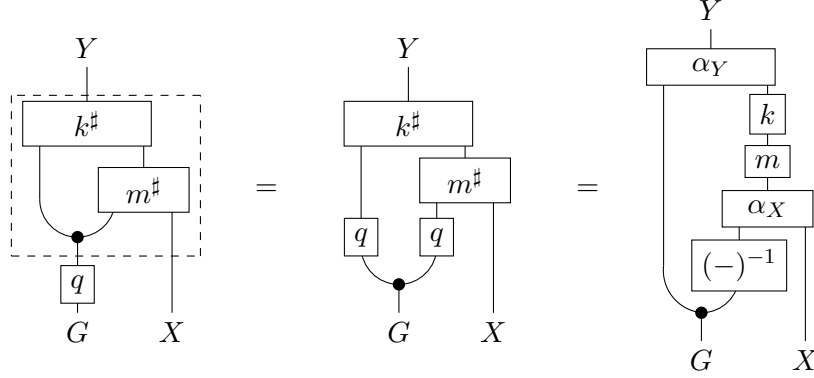

Here the second equality uses the fact that q is deterministic, and the third uses Lemma C.1, together with some basic group-theoretic manipulations. By definition of co-Kleisli composition here (see e.g. [Per21, Example 5.3.11]), the dashed box is precisely $m^\sharp \circ_{\text{ck}} k^\sharp$, and so this shows (63) by the uniqueness part of Lemma C.1. \square

C.2 Proof of Proposition 5.1

Proof. Given arbitrary $\omega : (X, \alpha_X) \rightarrow (G/H, */H) \otimes (X, \alpha_X)$ in \mathbf{C}^G , we will denote

$$\text{sym}_\omega(k) := k^\sharp \circ \omega, \quad (64)$$

where k^\sharp is obtained via Theorem 5.1. In other words, this is just like sym_γ , but where its precomposition morphism is allowed to be arbitrary, rather than taking the specific form (38) from the main text. Now let $k : (X, \alpha_X) \rightarrow (Y, \alpha_Y)$ be a morphism in \mathbf{C}^G . It is then easily verified that sym_ω is *natural* in the following sense:

$$\text{sym}_\omega(k) = \text{sym}_\omega(k \circ \text{id}_X) = k \circ \text{sym}_\omega(\text{id}_X).$$

As a result, sym_ω is stable if and only if $\text{sym}_\omega(\text{id}_X) = \text{id}_X$. Now recall that $(\text{id}_X)^\sharp$ is the unique morphism in \mathbf{C} such that

(where the second step is shown in Remark 3.2), and so we must have

$$\begin{array}{c} X \\ | \\ \boxed{(\text{id}_X)^\sharp} \\ | \quad | \\ G/H \quad X \end{array} = \begin{array}{c} \bullet \\ | \\ G/H \end{array} \begin{array}{c} X \\ | \\ X \end{array}$$

since certainly (65) holds in this case. It follows that sym_ω is stable if and only if

$$\begin{array}{c} X \\ | \\ \boxed{\text{sym}_\omega(\text{id}_X)} \\ | \\ X \end{array} = \begin{array}{c} X \\ | \\ \bullet \\ | \\ \boxed{\omega} \\ | \\ X \end{array} = \begin{array}{c} X \\ | \\ X \end{array}$$

This condition is always satisfied for ω of the form (38) from the main text. Conversely, if C is positive, this condition implies that ω has the form (38) by [Fri+23a, Theorem 2.8]. \square