

Consistent Update Synthesis via Privatized Beliefs

Thomas Schlögl, Roman Kuznets, Giorgio Cignarale

Institute of Computer Engineering, TU Wien, Vienna, Austria.

Contributing authors: tschloegl@ecs.tuwien.ac.at;
rkuznets@ecs.tuwien.ac.at; giorgio.cignarale@tuwien.ac.at;

Abstract

Kripke models are an effective and widely used tool for representing epistemic attitudes of agents in multi-agent systems, including distributed systems. Dynamic Epistemic Logic (DEL) adds communication in the form of model transforming updates. Private communication is key in distributed systems as processes exchanging (potentially corrupted) information about their private local state should not be detectable by any other processes. This focus on privacy clashes with the standard DEL assumption for which updates are applied to the whole Kripke model, which is usually commonly known by all agents, potentially leading to information leakage. In addition, a commonly known model cannot minimize the corruption of agents' local states due to fault information dissemination. The contribution of this paper is twofold: (I) To represent leak-free agent-to-agent communication, we introduce a way to synthesize an action model which stratifies a pointed Kripke model into private agent-clusters, each representing the local knowledge of the processes: Given a goal formula φ representing the effect of private communication, we provide a procedure to construct an action model that (a) makes the goal formula true, (b) maintain consistency of agents' beliefs, if possible, without causing "unrelated" beliefs (minimal change) thus minimizing the corruption of local states in case of inconsistent information. (II) We introduce a new operation between pointed Kripke models and pointed action models called *pointed updates* which, unlike the product update operation of DEL, maintain only the subset of the world-event pairs that are reachable from the point, without unnecessarily blowing up the model size.*

Keywords: Dynamic epistemic logic, Kripke models, Synthesis, Belief revision

*This research was funded in whole or in part by the Austrian Science Fund (FWF) project ByzDEL [10.55776/P33600].

1 Introduction

Epistemic logic (EL) [14] has been extremely successful in modeling epistemic and doxastic attitudes of agents and groups in multi-agent systems, including distributed systems [10]. *Dynamic epistemic logic* (DEL) [18, 8] upgrades EL by introducing model transforming modalities called *updates*. Relational structures such as *action models* in Action Model Logic (AML) and *arrow update models* in the Generalized Arrow Update Logic (GAUL) [15] are used to represent the evolution of agents’ uncertainty under information change in complex communication scenarios. GAUL and AML have proved to be equally *update expressive* [9]. Thus, without loss of generality, we use the term “update models” to refer to either action models of AML or arrow update models of GAUL. In the update *synthesis* task, the aim is to (i) find whether there exists an update model that makes a given goal formula φ true and (ii) construct that update model from φ [9].

Existing synthesis methods typically work in a language extended with quantifiers over updates, such as the Arbitrary Action Modal Logic [11] and Arbitrary Arrow Update Modal Logic [9] and do not address the issue of minimal change as a result of the update. While it is possible to construct AML or GAUL update models representing completely private communication [3] (see, e.g., Fig. 2), there is no standardized update synthesis procedure for it. In addition, most existing synthesis methods do not address belief consistency preservation [9].

Our paper is further motivated by two different yet intertwined issues:

- As argued by Artemov [1], in multi-agent settings, common knowledge of the model (CKM) is required by agents in order to compute higher-order beliefs of other agents. While his argument focuses on uncertainties about facts, it can also be extended to agents’ uncertainty about attitudes of other agents. The underlying problem is that, in multi-agent Kripke models, there is an implicit ontological distinction between two kinds of possible worlds: (a) worlds that are actually possible (AP) and (b) worlds that are only virtually possible (VP). While the former worlds constitute, for a given agent, the arena in which the actual world might lie, the latter kind of worlds are considered only to the extent of computing other agent’s beliefs. Artemov argues that without the CKM (comprising both APs and VPs), agents would not be able to compute such higher-order beliefs. Furthermore, avoiding the CKM assumption improves tolerance against local state corruption: upon receiving corrupted information from a faulty agent, a (correct) agent might only deem the local state of the sender as corrupted, instead of being forced to consider a larger part of the accessible Kripke model inconsistent.
- Update models do not naturally represent private agent-to-agent communication, as the product update operation typical of DEL is applied in principle to the full product of all the world-event pairs whose preconditions are matched [8]. In this sense, these updates are applied globally to the whole model, potentially leading to information leakage. The problem is also identified by Herzig, as “it is not easy to come up with a meaningful notion of a speaker” ([13]), highlighting the fact that local communication might have (undesired) effects on a global model.

Our solution to both issues is to change the structure of the Kripke models under consideration. While Artemov proposes to avoid the CKM by changing the definition

of truth for knowledge [1], we instead suggest a stratified Kripke model structure¹, without changing any basic definitions: by stratifying a Kripke model into a pointed *privatized Kripke model* we detach each agent’s view of the model from any other agent’s view of it. In our stratified models, not only we clearly distinguish between APs and VPs for any agent, but we also avoid the CKM assumption by letting each agent access only a limited and private part of it², without losing the ability to reason about higher-order beliefs of other agents of arbitrary depths. At the same time, while we do not solve the broader issue of agency identified by Herzig, we propose an alternative update operation called *pointed updates* which does not apply to the full product of the Kripke model and the action model. In particular, we exploit the novel stratification method (and the distinction between APs and VPs) to discern when to form a world-event tuple and when not. In this sense, our updates are not applied to the whole model, as they are progressively applied only to those worlds that match a certain structure (other than a certain precondition). The proposed stratified structure complies with the crucial notion of *local view* of an agent, typical of distributed systems, which is only a limited portion of the *global view* of the system, usually inaccessible to agents. The stratification not only represents the idea of each agent having a partial view of a Kripke model, but also distinguishes the actual world from any other worlds, by making it inaccessible. In other words, we endorse a *fallibilistic* assumption, that is, no agent can be sure that the global state of the system is captured in their limited view of it. Naturally, agents might have an accurate view of the system during execution, represented in our model by worlds propositionally equivalent to the actual world that are however accessible only in agents’ (respective) private clusters.

The aim of this paper is to provide a novel action model synthesis mechanism for AML designed for enforcing private beliefs specified by a quantifier-free goal formula while preserving the consistency of agents’ beliefs whenever possible. Our solution to the leak-free consistent update synthesis task accounts for a limited range of goal formulas, restricted to deterministic belief increase only, i.e. to conjunctions of (positive) modal operators. This limitation is due to the fact that preserving minimality and consistency becomes highly problematic for unrestricted goal formulas: one the one hand, negations of belief operators might introduce ignorance, potentially contradicting previously held beliefs. On the other hand, disjunctions of modal operators have multiple realizations, making the update non-deterministic. Addressing the remaining cases (and their interactions) is left for future work.

Finally, the proposed update mechanism is generally more efficient w.r.t. AML and GAUL updates as it deletes all states not reachable from the actual world, making the growth in size of the model at worst linear in the size of the goal formula after one update and decreasing starting from the second update based on the same modal syntactic tree. By contrast, it is well known that repeated applications of AML and GAUL updates lead to the exponential growth of the model. It is also known that the model checking problem is PSPACE-complete [2].

Related work. A prominent approach for dealing dynamically with beliefs in Kripke terms is the Dynamic Belief Revision [4, 7] account, where agents’ conditional

¹More precisely, the kind of structures that will be introduced for privatization are directed acyclic graphs.

²A formal definition of privatization is provided in Section 4.

beliefs are expressed via a plausibility relation ranging over virtual states. This account, however, cannot represent truly *private* updates, as its models encode both plausibility and epistemic relations that would be revealed by the CKM assumption. In recent years, different answers to the limitations of the CKM assumption in the standard semantics for EL and DEL have been proposed, for example by changing accessibility relations [1] or by using belief bases as primitives [16, 17]. Our approach, on the other hand, performs private, leakage-free consistent synthesis by structuring standard Kripke models into exclusively accessible parts that are not known to other agents, let alone commonly known.

Paper organization. We start by giving a motivating example in Section 2, as well as introducing the basic definitions of DEL and the crucial new definition of pointed update. In Section 3 we propose a solution to the leak-free consistent update synthesis for a limited range of goal formulas and we show its fruitfulness by applying it to our motivating example. In Section 4 we illustrate the properties of the synthesized action models, in particular w.r.t. privatization properties, crucial for avoiding information leakage while preserving consistency. Finally, conclusions are provided in Section 5.

2 Formal Preliminaries and Motivation

We use the standard doxastic multimodal language

$$\varphi ::= p \mid \neg\varphi \mid (\varphi \wedge \varphi) \mid B_i\varphi$$

where $i \in \mathcal{A} = \{1, \dots, n\}$ (for $n > 1$) and $p \in Prop$. Formula $B_i\varphi$ means *agent i believes φ (to be true)*; note that we generally do not assume the factivity of beliefs. The other Boolean connectives are defined as usual and $\widehat{B}_i := \neg B_i \neg$ representing the dual modality *considers possible*.

Example 1 (Balder–Loki–Thor example). Teenage brothers Balder, Loki, and Thor prepare for an exam that, as is commonly known among them, contains one question asking to decide whether p or $\neg p$ is the case. Suppose the correct answer is $\neg p$. The initial model \mathcal{M} is the left model of Fig. 1. While the three are studying, Loki, unbeknownst to Thor, tries to trick Balder: Loki lies to Balder that he has overheard Thor boasting to know the correct answer to be p . Balder seems to dismiss Loki’s claim as a ruse, leaving Loki thinking his trick had no effect. In truth, however, Balder does believe Loki and is now under the impression that Loki agrees with Thor that the answer is p . Balder himself, on the other hand, is not going to take Thor’s word on it, given Thor’s propensity to boast and act rashly. Thus, using b , l , and t for the brothers, Loki’s trick should change Balder’s beliefs to achieve the *goal formula*

$$\varphi = B_b(B_t p \wedge B_l B_t p \wedge B_l p) \tag{1}$$

without either affecting Loki’s or Thor’s beliefs or making $B_b p$ true.

Since ignorance of the correct answer is common belief in the initial model \mathcal{M} , the public announcement of φ would cause everybody’s beliefs to become inconsistent, whereas a private message $B_t p \wedge B_l B_t p \wedge B_l p$ would cause the same inconsistency,

but for Balder’s beliefs only. This happens whether one uses the world-removing or arrow-removing updates.

Instead, we propose an update method that stratifies the initial model \mathcal{M} into several clusters representing individual beliefs and updating only some of these clusters, depending on the modal structure of the goal formula, resulting in model \mathcal{M}^U in Fig. 1, where updated clusters are represented by light-gray rectangles. Cluster 0 contains only the actual world v , which no agent considers possible. Cluster -1 (the *sink*) is the copy of the initial model representing (higher-order) beliefs of agents unaffected by the message, including Loki’s and Thor’s beliefs. In particular, the ignorance of the correct answer is still common belief between Loki and Thor. Balder is also ignorant of the correct answer: his beliefs are represented by cluster 1, so $\mathcal{M}^U, v \not\models B_b p \vee B_b \neg p$. But his ignorance is not anymore common with Loki and Thor. Indeed, according to cluster 2, which represents Balder’s beliefs about Thor’s beliefs, $\mathcal{M}^U, v \models B_b B_t p$. Cluster 3 plays the same role for Balder’s beliefs about Loki’s beliefs, making $\mathcal{M}^U, v \models B_b B_l p$. Thus, while himself being ignorant of the answer, Balder thinks that Loki and Thor have chosen for themselves. Finally, cluster 4 is Balder’s beliefs about Loki’s beliefs about Thor’s beliefs so that $\mathcal{M}^U, v \models B_b B_l B_t p$. Overall, $\mathcal{M}^U, v \models \varphi$. The b -labeled double arrow from cluster 3 to the sink -1 represents two b -labeled arrows from the only world of cluster 3 to each of the two worlds of the sink and ensures that Balder believes that Loki believes that Balder has not changed his beliefs, $\mathcal{M}^U, v \models B_b B_l (\neg B_b p \wedge \neg B_b \neg p)$. Similarly, the b, l -labeled double arrows from clusters 2 and 4 to the sink signify that in no scenario where Thor has chosen an answer for himself, does he expect others to be follow his example (or even be aware of his choice). It is easy to see that no agent has inconsistent beliefs, $\mathcal{M}^U \models \neg B_b \perp \wedge \neg B_l \perp \wedge \neg B_t \perp$, and that Loki’s and Thor’s beliefs are the same as in the initial model, $M, v \models B_a \psi$ iff $\mathcal{M}^U, v \models B_a \psi$ for $a \in \{l, t\}$.

Definition 2. The set of *target agents* of a modal formula φ is defined as follows: $\text{ta}(p) := \emptyset$; $\text{ta}(\neg\varphi) := \text{ta}(\varphi)$; $\text{ta}(\varphi \wedge \psi) := \text{ta}(\varphi) \cup \text{ta}(\psi)$; finally $\text{ta}(B_i \varphi) := \{i\}$.

E.g., $\text{ta}(B_b(B_t p \wedge B_l B_t p \wedge B_l p)) = \{b\}$ even though $\text{ta}(B_t p \wedge B_l B_t p \wedge B_l p) = \{t, l\}$.

We introduce the standard definitions of DEL [8]:

Definition 3 (Kripke frame). A Kripke frame for the set of agents \mathcal{A} is a pair $\langle W, R \rangle$ where $W \neq \emptyset$ is a non-empty set, called *domain* and $R = (R_1, \dots, R_n)$ consists of binary *accessibility relations* $R_i \subseteq W \times W$ on W .

Definition 4 (Pointed Kripke model). For a set of agents \mathcal{A} , a *Kripke model* is a triple $\mathcal{M} = \langle S, R, V \rangle$ where $\langle S, R \rangle$ is a Kripke frame with domain S consisting of *possible worlds* or *states*, and the *valuation function* $V: Prop \rightarrow 2^S$ determines the set $V(p) \subseteq S$ of possible worlds where an atom $p \in Prop$ is true. A *pointed Kripke model* is a pair (\mathcal{M}, w) where $w \in S$ represents the *actual world/state*.

Truth at world w of model \mathcal{M} is determined by $\mathcal{M}, w \models p$ iff $w \in V(p)$. Boolean connectives are defined as usual. $\mathcal{M}, w \models B_i \varphi$ iff $\mathcal{M}, w' \models \varphi$ for all $w' \in S$ such that $w R_i w'$. A formula φ is *false at world w* , $\mathcal{M}, w \not\models \varphi$, iff it is not true at w .

Definition 5 (Pointed action model). For a set of agents \mathcal{A} , an *action model* is a triple $\mathcal{U} = \langle E, Q, \text{pre} \rangle$ where $\langle E, Q \rangle$ is a Kripke frame with domain E consisting of *action points* or *events*, and the *precondition function* $\text{pre}: E \rightarrow \mathcal{L}$ assigns the precondition $\text{pre}(\beta) \in \mathcal{L}$ that is necessary for an event $\beta \in E$ to happen. A *pointed action model* is a pair (\mathcal{U}, α) where $\alpha \in E$ represents the *actual event/action point*.

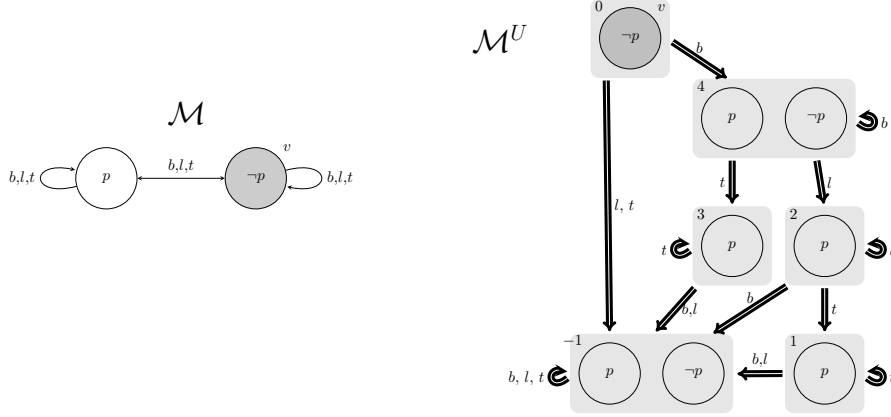

Fig. 1: Left: Initial pointed Kripke model \mathcal{M} . Right: Updated model \mathcal{M}^U (the actual world v is dark gray). A formula φ within a circle representing a world means that φ is true in this world. A light-gray rectangle with n in the top left corner is the cluster that is numbered n . A double arrow from such cluster n to cluster m represents a set of accessibility arrows with the same agent's label from every world of cluster n to every world of cluster m .

Definition 6 (Product update). The (*restricted modal*) *product update* of a Kripke model $\mathcal{M} = \langle S, R, V \rangle$ with an action model $\mathcal{U} = \langle E, Q, \text{pre} \rangle$ is a Kripke model $\mathcal{M} \otimes \mathcal{U} := \langle S', R', V' \rangle$ where

- $S' := \{(v, \beta) \in S \times E \mid \mathcal{M}, v \models \text{pre}(\beta)\}$,
- $R'_i := \{((v, \beta), (u, \gamma)) \in S' \times S' \mid (v, u) \in R_i \text{ and } (\beta, \gamma) \in Q_i\}$,
- $V'(p) := \{(v, \beta) \in S' \mid v \in V(p)\}$.

If $S' = \emptyset$, the product update is undefined.

A product update provides the semantics for a communication scenario represented by a pointed action model (\mathcal{U}, α) : formula φ is true after the communication \mathcal{U} , i.e., $\mathcal{M}, w \models [\mathcal{U}, \alpha]\varphi$, iff $\mathcal{M} \otimes \mathcal{U}, (w, \alpha) \models \varphi$ or $(w, \alpha) \notin S'$.

It is well known that repeatedly applying product updates for multi-round communication can cause exponential blow up of the domain of the model, even for simple models and action models, see Figs. 2–4. Indeed, every updated model has exactly one world where p is false. Hence, a further update of a model of N worlds with \mathcal{U} creates a model with $2N - 1$ worlds.

The standard (often implicit) solution is to reduce the size of the model by deleting all worlds that are unreachable from the resulting actual world. This operation is technically sound, as deleting all these unreachable worlds yields a model that is bisimilar and, hence, modally equivalent [6].

We introduce a new definition of *pointed update* that incorporates this world-removing operation formally and explicitly:

Definition 7 (Pointed update). Let $(\mathcal{M}, w) = (\langle S, R, V \rangle, w)$ be a pointed Kripke model and $(\mathcal{U}, \alpha) = (\langle E, Q, \text{pre} \rangle, \alpha)$ be a pointed action model. If $\mathcal{M}, w \models \text{pre}(\alpha)$, then we define the updated pointed Kripke model $(\mathcal{M} \odot \mathcal{U}, (w, \alpha))$ where



Fig. 2: Left: Initial (pointed) Kripke model \mathcal{M} where agent a and b are uncertain about whether p or $\neg p$ is true. Right: (Pointed) action model \mathcal{U} for a private message p to a : agent a learns p , while b believes that nothing happened. A formula φ within a square representing an event β is the precondition for this event, i.e., $\text{pre}(\beta) = \varphi$.

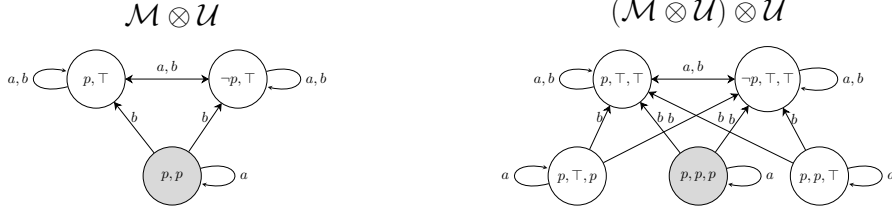

Fig. 3: Left: First product update $\mathcal{M} \otimes \mathcal{U}$ of Kripke model \mathcal{M} with action model \mathcal{U} . Right: Second product update $(\mathcal{M} \otimes \mathcal{U}) \otimes \mathcal{U}$ with the same action model \mathcal{U} . p is true in all worlds that start from p and false in all worlds that start from $\neg p$.

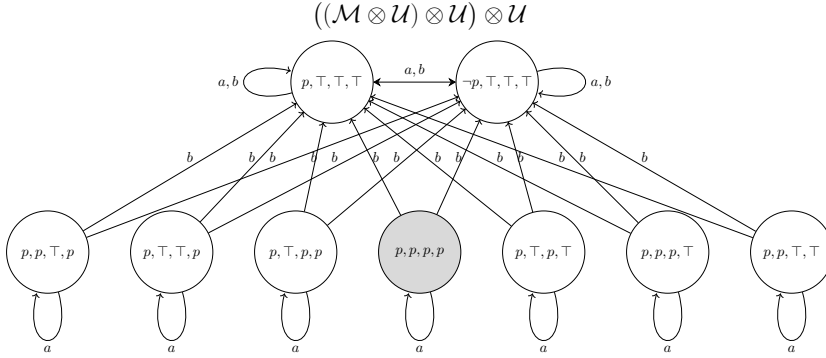

Fig. 4: Third product update $((\mathcal{M} \otimes \mathcal{U}) \otimes \mathcal{U}) \otimes \mathcal{U}$ with the same action model \mathcal{U} .

$\mathcal{M} \odot \mathcal{U} := \langle S^{\mathcal{U}}, R^{\mathcal{U}}, V^{\mathcal{U}} \rangle$ as follows. Let $T^{\mathcal{U}} := \{(v, \beta) \in S \times E \mid \mathcal{M}, v \models \text{pre}(\beta)\}$. Note that $(w, \alpha) \in T^{\mathcal{U}}$.

- The domain $S^{\mathcal{U}}$ is the smallest subset of $T^{\mathcal{U}}$ containing (w, α) such that: if $(v, \beta) \in S^{\mathcal{U}}$, $(u, \gamma) \in T^{\mathcal{U}}$, and both $vR_i u$ and $\beta Q_i \gamma$ for some agent i , then $(u, \gamma) \in S^{\mathcal{U}}$;
- $R_i^{\mathcal{U}} := \{(v, \beta), (u, \gamma)\} \in S^{\mathcal{U}} \times S^{\mathcal{U}} \mid (v, u) \in R_i \text{ and } (\beta, \gamma) \in Q_i\}$;
- $V^{\mathcal{U}}(p) := \{(v, \beta) \in S^{\mathcal{U}} \mid v \in V(p)\}$.

To show that pointed updates produce the same result as product updates but with smaller models, we use the notion of bisimulation.

Definition 8 (Bisimulation). A *bisimulation between Kripke frames* $\langle W, R \rangle$ and $\langle W', R' \rangle$ is a nonempty binary relation $\mathcal{B} \subseteq W \times W'$, such that for every $v \mathcal{B} v'$ and $i \in \mathcal{A}$:

- **Forth:** if $vR_i u$, then there is $u' \in S'$ such that $v'R'_i u'$ and $u \mathcal{B} u'$;
- **Back:** if $v'R'_i u'$, then there is $u \in S$ such that $vR_i u$ and $u \mathcal{B} u'$.

A *bisimulation between Kripke models* $\mathcal{M} = \langle S, R, V \rangle$ and $\mathcal{M}' = \langle S', R', V' \rangle$ is a bisimulation $\mathcal{B} \subseteq S \times S'$ between their frames $\langle S, R \rangle$ and $\langle S', R' \rangle$ that additionally satisfies for every $v \mathcal{B} v'$ and $p \in Prop$:

- **Atoms:** $v \in V(p)$ iff $v' \in V'(p)$.

A *bisimulation between action models* $\mathcal{U} = \langle E, Q, pre \rangle$ and $\mathcal{U}' = \langle E', Q', pre' \rangle$ is a bisimulation $\mathcal{B} \subseteq E \times E'$ between their frames $\langle E, Q \rangle$ and $\langle E', Q' \rangle$ that additionally satisfies for every $\alpha \mathcal{B} \alpha'$:

- **Pre:** $pre(\alpha) = pre'(\alpha')$.

Pointed Kripke models (\mathcal{M}, v) and (\mathcal{M}', v') are *bisimilar*, notation $\mathcal{M}, v \Leftrightarrow \mathcal{M}', v'$, iff there is a bisimulation \mathcal{B} between \mathcal{M} and \mathcal{M}' such that $v \mathcal{B} v'$.

Pointed Kripke models (\mathcal{M}, v) and (\mathcal{M}', v') are *G-bisimilar* for a group $G \subseteq \mathcal{A}$ of agents, notation $\mathcal{M}, v \Leftrightarrow_G \mathcal{M}', v'$, iff for any $a \in G$

- **G-Forth:** if $vR_a u$, then there is $u' \in S'$ such that $v'R'_a u'$ and $\mathcal{M}, u \Leftrightarrow \mathcal{M}', u'$;
- **G-Back:** if $v'R'_a u'$, then there is $u \in S$ such that $vR_a u$ and $\mathcal{M}, u \Leftrightarrow \mathcal{M}', u'$.

The definitions of bisimilarity and *G*-bisimilarity for pointed action models are analogous.

Definition 9 (Equivalences). Pointed Kripke models (\mathcal{M}, v) and (\mathcal{M}', v') are called *modally equivalent*, notation $\mathcal{M}, v \equiv \mathcal{M}', v'$, whenever $\mathcal{M}, v \models \varphi$ iff $\mathcal{M}', v' \models \varphi$ for all formulas φ . They are called *G-indistinguishable for group* $G \subseteq \mathcal{A}$, notation $\mathcal{M}, v \equiv_G \mathcal{M}', v'$, whenever $\mathcal{M}, v \models B_a \varphi$ iff $\mathcal{M}', v' \models B_a \varphi$ for all formulas φ and agents $a \in G$.

Theorem 10 (Bisimilarity implies modal equivalence).

1. If $\mathcal{M}, v \Leftrightarrow \mathcal{M}', v'$, then $\mathcal{M}, v \equiv \mathcal{M}', v'$.
2. If $\mathcal{M}, v \Leftrightarrow_G \mathcal{M}', v'$, then $\mathcal{M}, v \equiv_G \mathcal{M}', v'$.

Proof. The first statement is standard (see [6]). The second statement easily follows from the first. \square

Theorem 11 (Product and pointed updates are bisimilar). *Given a pointed Kripke model (\mathcal{M}, w) and pointed action model (\mathcal{U}, α) such that $\mathcal{M}, w \models pre(\alpha)$, we have $\mathcal{M} \odot \mathcal{U}, (w, \alpha) \Leftrightarrow \mathcal{M} \otimes \mathcal{U}, (w, \alpha)$.*

Proof. Let $\mathcal{M} = \langle S, R, V \rangle$, $\mathcal{U} = \langle E, Q, pre \rangle$, $\mathcal{M} \odot \mathcal{U} = \langle S^\mathcal{U}, R^\mathcal{U}, V^\mathcal{U} \rangle$ and $\mathcal{M} \otimes \mathcal{U} = \langle S', R', V' \rangle$. By construction, $(w, \alpha) \in S^\mathcal{U} \subseteq S'$, and $R^\mathcal{U} = R'_{|(S^\mathcal{U} \times S^\mathcal{U})}$, and $V^\mathcal{U} = V'_{|S^\mathcal{U}}$. Hence, it is easy to see that $\mathcal{B} := \{((v, \beta), (v, \beta)) \mid (v, \beta) \in S^\mathcal{U}\}$ is the requisite bisimulation. \square

Theorem 12 (Updates preserve bisimilarity). *Given bisimilar pointed Kripke model $\mathcal{M}, w \Leftrightarrow \mathcal{M}', w'$ and bisimilar pointed action models $\mathcal{U}, \alpha \Leftrightarrow \mathcal{U}', \alpha'$ such that $\mathcal{M}, w \models pre(\alpha)$, we have $\mathcal{M} \otimes \mathcal{U}, (w, \alpha) \Leftrightarrow \mathcal{M}' \otimes \mathcal{U}', (w', \alpha')$ and $\mathcal{M} \odot \mathcal{U}, (w, \alpha) \Leftrightarrow \mathcal{M}' \odot \mathcal{U}', (w', \alpha')$. The same holds for *G*-bisimilarity.*

Proof. For product updates, the proof can be found in [8]. For pointed updates, it then follows from Theorem 11. The statements for a -bisimilarity easily follow. \square

The advantage of pointed updates can be illustrated by the fact that, while repeated product updates of \mathcal{M} from Fig. 1 with \mathcal{U} from Fig. 2 leads to the exponential growth of the domain, pointed updates yield the three-world pointed Kripke model depicted left in Fig. 3, no matter how many times the pointed update is performed:

$$((\mathcal{M} \odot \mathcal{U}) \odot \mathcal{U}) \odot \cdots \odot \mathcal{U} = \mathcal{M} \otimes \mathcal{U}.$$

In the following section, we use this mechanism to solve the consistent update synthesis problem.

3 Consistent Update Synthesis: Deterministic Belief Increase

In this section, we propose a solution to the consistent update synthesis task for *goal formulas* φ representing *deterministic belief increase* (DBI) by generating a pointed action model \mathcal{U}_φ such that the result of a pointed update of any given pointed Kripke model with \mathcal{U}_φ satisfies φ and inconsistent beliefs (including higher-order beliefs) are not introduced whenever they are possible to avoid. By deterministic belief increase we mean situations when several agents are prescribed additional beliefs (including higher-order beliefs) without creating alternative ways of fulfilling the prescription. Before giving the formal definition, it should be mentioned that there is always a trivial way of creating new beliefs by making the agents' beliefs inconsistent, i.e., making them believe all statements including the desired ones. However, making agents' reasoning inconsistent does not comport with the ideology of minimal change, nor is productive in terms of correcting agents' incidental false beliefs. The main novelty in our method of update synthesis is the aim to preserve consistency whenever possible. Now we give a formal definition of goal formulas representing deterministic belief increase:

Definition 13 (DBI goal formulas, DBI normal form). *DBI goal formulas* φ , or *DBI formulas* for short, are defined by the following BNF:

$$\varphi ::= B_i \xi \mid B_i(\xi \wedge \varphi) \mid (\varphi \wedge \varphi) \mid B_i \varphi \quad (2)$$

where ξ is any purely propositional formula and $i \in \mathcal{A}$. Thus, each DBI goal formula is a non-empty conjunction of belief operators. *Formulas in DBI normal form* are DBI formulas φ obtained by restricting the construction as follows: $B_i \xi$ is always DBI normal; $B_i \varphi$ and $B_i(\xi \wedge \varphi)$ are DBI normal iff φ is DBI normal and $i \notin \text{ta}(\varphi)$; $\varphi \wedge \psi$ is DBI normal iff φ and ψ are DBI normal and $\text{ta}(\varphi) \cap \text{ta}(\psi) = \emptyset$.

Lemma 14. *For any DBI goal formula φ , there exists a DBI normal formula φ' such that $\mathcal{K}45 \models \varphi \equiv \varphi'$, where $\mathcal{K}45$ is the class of all transitive³ and euclidean⁴ frames.*

³If $vR_i u$ and $uR_i w$ then $vR_i w$.

⁴If $vR_i u$ and $vR_i w$ then $uR_i w$.

Proof. It is sufficient to use the following $\mathcal{K}45$ logical equivalences: $B_i B_i \theta \equiv B_i \theta$, $B_i(\xi \wedge B_i \theta) \equiv B_i(\xi \wedge \theta)$, and $B_i \theta \wedge B_i \eta \equiv B_i(\theta \wedge \eta)$. \square

Lemma 15 (*G-bisimilarity and goal formula preservation*). *If $\mathcal{M}, v \simeq_G \mathcal{M}', v'$ and φ is a DBI formula with $\text{ta}(\varphi) \subseteq G$, then $\mathcal{M}, v \models \varphi$ iff $\mathcal{M}', v' \models \varphi$.*

Proof. It follows from Theorem 10 (2) and the fact that φ is a conjunction of $B_i \psi_i$ for $i \in \text{ta}(\varphi) \subseteq G$. \square

Without loss of generality, from now on, we only consider formulas in DBI normal form. For instance, formula (1) is a DBI formula but not DBI normal. Its normal form would be $B_b(B_i p \wedge B_i(p \wedge B_i p))$. Given such a DBI normal formula φ , we now construct a pointed action model $(\mathcal{U}_\varphi, 0)$ such that for any pointed Kripke model (\mathcal{M}, w) , the pointed update $\mathcal{M} \odot \mathcal{U}_\varphi$ is defined, $\mathcal{M} \odot \mathcal{U}_\varphi, (w, 0) \models \varphi$, while other epistemic differences between (\mathcal{M}, w) and $(\mathcal{M} \odot \mathcal{U}_\varphi, (w, 0))$ are minimized. Informally, this means that an update should not influence any beliefs except for those explicitly stated in φ and logically following from φ based on the agents' pre-update beliefs⁵. In particular, if $j \notin \text{ta}(\varphi)$, then j 's beliefs should not be affected even if B_j occurs in φ : updating somebody else's beliefs about j 's beliefs should not affect actual j 's beliefs.

Definition 16 (*Consistent DBI update synthesis*). Given a formula φ in DBI normal form the pointed action model $(\mathcal{U}_\varphi, 0) = (\langle E^\varphi, Q^\varphi, \text{pre}^\varphi \rangle, 0)$ is constructed recursively based on the structure of φ . In all cases, $E^\varphi = \{0, -1\} \sqcup D^\varphi$ with $0 \neq -1$ for some $\emptyset \neq D^\varphi \subseteq \mathbb{N}$, event 0 representing the actual event, unknowable for all, has no incoming arrows, i.e., not $\alpha Q_i^\varphi 0$, and event -1 representing status quo/no change has no outgoing arrows other than reflexive loops, i.e., $-1 Q_i^\varphi \alpha$ iff $\alpha = -1$. $\text{pre}^\varphi(0) = \text{pre}^\varphi(-1) := \top$. Let $\underline{Q}_j^\varphi := Q_j^\varphi \cap ((E^\varphi \setminus \{0\}) \times (E^\varphi \setminus \{0\}))$ be the restriction of Q_j^φ onto $E^\varphi \setminus \{0\}$ for any agent j .

- 1 If $\varphi = B_i \xi$ for a propositional formula ξ , then $D^{B_i \xi} = \{m\}$ for a fresh $m \geq 1$, $\text{pre}^{B_i \xi}(m) := \xi$, $Q_j^{B_i \xi} := \{(0, -1), (m, -1), (-1, -1)\}$ for any $j \neq i$, while at the same time $Q_i^{B_i \xi} := \{(0, m), (m, m), (-1, -1)\}$.
- 2 If $\varphi = B_i \psi$ for a DBI normal formula ψ , then $\mathcal{U}_\psi = (\{0, -1\} \sqcup D^\psi, Q^\psi, \text{pre}^\psi)$ has already been constructed. Let $1 \leq m \notin D^\psi$ be fresh. Then $D^\varphi := D^\psi \sqcup \{m\}$, $\text{pre}^\varphi := \text{pre}^\psi \sqcup \{(m, \top)\}$, i.e., pre^φ agrees with pre^ψ and extends it to $\text{pre}^\varphi(m) := \top$, and the accessibility relations are defined as follows:

$$\begin{aligned} Q_j^\varphi &:= \underline{Q}_j^\psi \sqcup \{(0, -1)\} \sqcup \{(m, k) \mid (0, k) \in Q_j^\psi\} & \text{for any } j \neq i; \\ Q_i^\varphi &:= \underline{Q}_i^\psi \sqcup \{(0, m), (m, m)\}. \end{aligned}$$

- 3 If $\varphi = B_i(\xi \wedge \psi)$ for a DBI normal formula ψ and propositional formula ξ , the construction is the same as in the preceding case with the only change being that $\text{pre}^\varphi(m) := \xi$.
- 4 If $\varphi = \psi \wedge \theta$ for DBI normal formulas ψ and θ , then $\mathcal{U}_\psi = (\{0, -1\} \sqcup D^\psi, Q^\psi, \text{pre}^\psi)$ and $\mathcal{U}_\theta = (\{0, -1\} \sqcup D^\theta, Q^\theta, \text{pre}^\theta)$ have already been constructed. We can assume

⁵We adopt the minimality principle in the same spirit of the standard AGM approach [5] for which an update should lead to the loss of as few previous beliefs as possible [12].

w.l.o.g. that $D^\psi \cap D^\theta = \emptyset$ (otherwise, just rename events in one of them). Take $D^\varphi = D^\psi \sqcup D^\theta$, set $\text{pre}^\varphi = \text{pre}^\psi \cup \text{pre}^\theta$ and, for any j ,

$$Q_j^\varphi := \underline{Q}_j^\psi \cup \underline{Q}_j^\theta \sqcup \{(0, k) \mid (0, k) \in Q_j^\psi \cup Q_j^\theta, k \in D^\psi \sqcup D^\theta\} \sqcup \{(0, -1) \mid (0, k) \notin Q_j^\psi \cup Q_j^\theta \text{ for any } k \in D^\psi \sqcup D^\theta\}.$$

We illustrate this update synthesis method by applying to Example 1:

Example 17. For the DBI normal form $\varphi = B_b(B_t p \wedge B_l(p \wedge B_t p))$ of formula (1) from Example 1, pointed action model $(\mathcal{U}_\varphi, 0)$ constructed according to Definition 16 can be found in the left part of Fig. 6 (stages of construction can be seen in Fig. 5). The result of the pointed update of (\mathcal{M}, v) from the left part of Fig. 1 with this $(\mathcal{U}_\varphi, 0)$ can be seen on the right of Fig. 6 (and is isomorphic to the right part of Fig. 1). It is easy to see that $\mathcal{M} \odot \mathcal{U}_\varphi, (v, 0) \models \varphi$. Since all accessibility relations in this updated model $\mathcal{M} \odot \mathcal{U}_\varphi$ are serial, it follows that it is common belief that all agents have consistent beliefs.

In addition, we claim that this update synthesis has been achieved with minimal change to agents' beliefs. Indeed, it is easy to prove using G -bisimilarities for appropriate groups of agents that

$$\begin{array}{ll} \mathcal{M}, v \equiv_{l,t} \mathcal{M} \odot \mathcal{U}_\varphi, (v, 0) & \mathcal{M}, v \equiv_{b,l} \mathcal{M} \odot \mathcal{U}_\varphi, (u, 1) \\ \mathcal{M}, v \equiv_b \mathcal{M} \odot \mathcal{U}_\varphi, (u, 2) & \mathcal{M}, v \equiv_{b,l} \mathcal{M} \odot \mathcal{U}_\varphi, (u, 3) \end{array}$$

where v is the actual world and u is the other world of \mathcal{M} (we omit set braces in the subscript of \equiv). The statements in the first column mean that the update is imperceptible for agents l and t and that agent b believes that agent l does not think b 's beliefs have changed. Similarly, the second column testifies that b believes himself and thinks that l believes that t does not think either b or l changed their beliefs. In other words, the only higher-order beliefs that are affected by the update are those explicitly dictated by φ .

We illustrate the advantage of using pointed updates over the product update operation using Example 1:

Example 18. Consider the same example but using the product update of standard DEL: The result of updating the initial model with the action model obtained from φ is shown in Fig. 7. In particular, the result of the product update has only one additional world w.r.t. the model obtained via pointed updates $\mathcal{M} \odot \mathcal{U}_\varphi$ of Fig. 6 (left), which is not reachable from the actual world, namely the p world in the v cluster at the top. However, the difference between the two operations is striking in case of iterated updates: applying to the resulting model the product update operation again with the same action model leads to the Kripke model sketched in Fig. 8, which contains a number of worlds that are not reachable from the actual world but copied in every sub-model nonetheless. Compare this to the pointed update operation, whose result is the same for any number of iterations for the same action model (Theorem 28).

Let us now prove that \mathcal{U}_φ performs update synthesis for any DBI normal φ , minimizes belief change of other agents, and preserves consistency whenever possible.

We will use the auxiliary fact that updates do not affect propositional formulas:

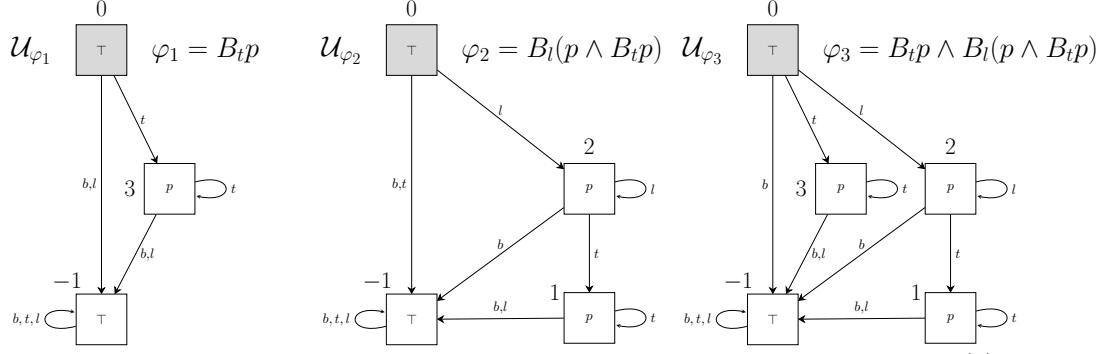

Fig. 5: Intermediate stages in constructing action model \mathcal{U}_φ for DBI formula (1) from Example 1 based on its DBI normal form $\varphi = B_b(B_t p \wedge B_l(p \wedge B_t p))$.

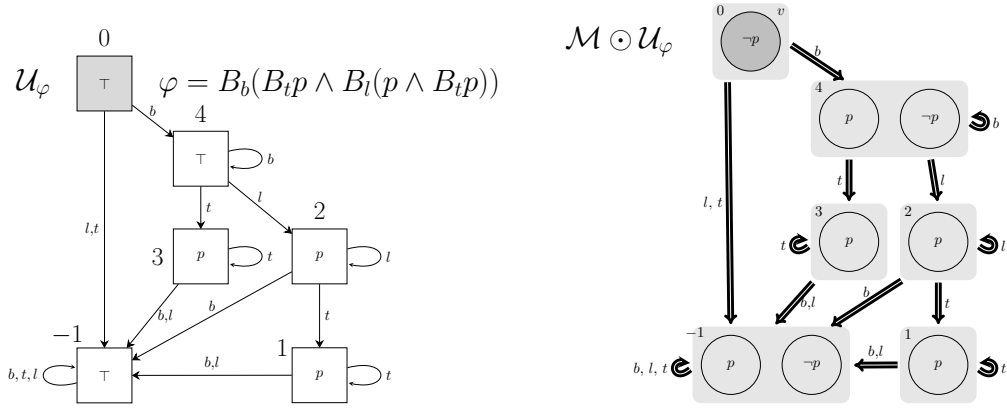

Fig. 6: Successful update synthesis $\mathcal{M} \odot \mathcal{U}_\varphi, (v, 0) \models \varphi$ by applying pointed update with pointed action model $(\mathcal{U}_\varphi, 0)$ for DBI formula (1) from Example 1 to (\mathcal{M}, v) from Fig. 1 (left). (Legend: the real event and world are dark gray; light gray rectangles are a compact way for representing arrows in the updated model: a double arrow with label $a \in \mathcal{A}$ from one rectangle to another represents a set of accessibility arrows with label a from every world in the source rectangle to every world in the target rectangle).

Lemma 19 (Propositional invariance). *Let (w, α) belong to the domain of $\mathcal{M} \odot \mathcal{U}$ for some Kripke model \mathcal{M} and action model \mathcal{U} . Then for any propositional formula ξ ,*

$$\mathcal{M}, w \models \xi \quad \iff \quad \mathcal{M} \odot \mathcal{U}, (w, \alpha) \models \xi. \quad (3)$$

Proof. For product updates \otimes , this is well known (see, e.g., [8]). For pointed updates, it follows from Theorem 11. \square

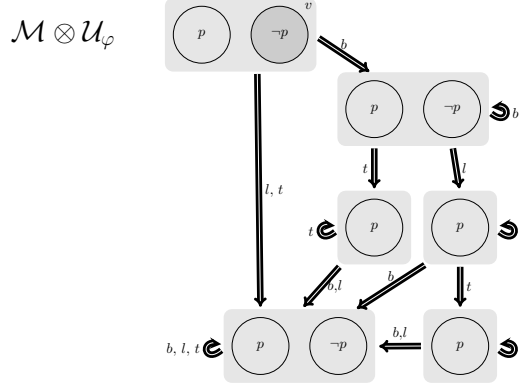

Fig. 7: Balder–Loki–Thor updated model using product updates $\mathcal{M} \odot \mathcal{U}_\varphi$. The real world v is underlined. Grey rectangles are a compact way for representing arrows: A double arrow from a rectangle to another represents a set of accessibility arrows with the same agent’s label from every world in the source rectangle to every world in the target rectangle.

Theorem 20 (Update synthesis success). *For any DBI normal formula φ and any pointed Kripke model (\mathcal{M}, v) , the pointed update of (\mathcal{M}, v) with $(\mathcal{U}_\varphi, 0)$ is defined and*

$$\mathcal{M} \odot \mathcal{U}_\varphi, (v, 0) \models \varphi. \quad (4)$$

Proof. Let $\mathcal{M} = \langle S, R, V \rangle$ with $v \in S$. Per Def. 16, $\mathcal{U}_\varphi = \langle E^\varphi, Q^\varphi, \text{pre}^\varphi \rangle$. The pointed update $\mathcal{M} \odot \mathcal{U}_\varphi, (v, 0)$ is defined because $\text{pre}^\varphi(0) = \top$ always holds. Let $\mathcal{M} \odot \mathcal{U}_\varphi = \langle W^\varphi, R^\varphi, V^\varphi \rangle$. We prove (4) by induction on the construction of φ . For $\varphi = B_i \xi$ with propositional ξ , whenever $(v, 0) R_i^\varphi(u, m)$, then $\mathcal{M}, u \models \xi$ because $\text{pre}^\varphi(m) = \xi$. Hence, $\mathcal{M} \odot \mathcal{U}_\varphi, (u, m) \models \xi$ by Lemma 19. We conclude (4) for $\varphi = B_i \xi$ since (u, m) was chosen arbitrarily.

For $\varphi = B_i \psi$, it follows by construction that $\mathcal{U}_\varphi, m \simeq_{\mathcal{A} \setminus \{i\}} \mathcal{U}_\psi, 0$. Whenever $v R_i u$, since bisimilarity is reflexive, $\mathcal{M} \odot \mathcal{U}_\varphi, (u, m) \simeq_{\mathcal{A} \setminus \{i\}} \mathcal{M} \odot \mathcal{U}_\psi, (u, 0)$ by Theorem 11. By IH, $\mathcal{M} \odot \mathcal{U}_\psi, (u, 0) \models \psi$. By normality of φ , $i \notin \text{ta}(\psi)$. Hence, $\mathcal{M} \odot \mathcal{U}_\varphi, (u, m) \models \psi$ by Lemma 15. Now (4) for $\varphi = B_i \psi$ follows since $(v, 0) R_i^\varphi(u, \alpha)$ iff $v R_i u$ and $\alpha = m$ due to $\text{pre}^\varphi(m) = \top$. The case of $\varphi = B_i(\xi \wedge \psi)$ is analogous, except additionally $\mathcal{M} \odot \mathcal{U}_\varphi, (u, m) \models \xi$ because $\text{pre}^\varphi(m) = \xi$, as in the case of $B_i \xi$.

For $\varphi = \psi_1 \wedge \psi_2$, by construction and normality of φ we have $\mathcal{U}_\varphi, 0 \simeq_{\text{ta}(\psi_j)} \mathcal{U}_{\psi_j}, 0$ and, hence, $\mathcal{M} \odot \mathcal{U}_\varphi, (v, 0) \simeq_{\text{ta}(\psi_j)} \mathcal{M} \odot \mathcal{U}_{\psi_j}, (v, 0)$ for $j = 1, 2$. $\mathcal{M} \odot \mathcal{U}_{\psi_j}, (v, 0) \models \psi_j$ for $j = 1, 2$ by IH. Hence, $\mathcal{M} \odot \mathcal{U}_\varphi, (v, 0) \models \psi_j$ for $j = 1, 2$ by Lemma 15. Now (4) for $\varphi = \psi \wedge \theta$ follows immediately. \square

To formulate statements about minimal change, we need the following definition:

Definition 21 (Independent formulas). Let φ be a DBI normal formula and its corresponding action model $\mathcal{U}_\varphi = \langle E^\varphi, Q^\varphi, \text{pre}^\varphi \rangle$ be constructed according to Def. 16. A modal formula θ is in \top -shape w.r.t. event $\alpha_0 \in E^\varphi$ iff for each sequence of modal operators $B_{i_1} \dots B_{i_k}$ used in the construction of θ , including the empty sequence ε

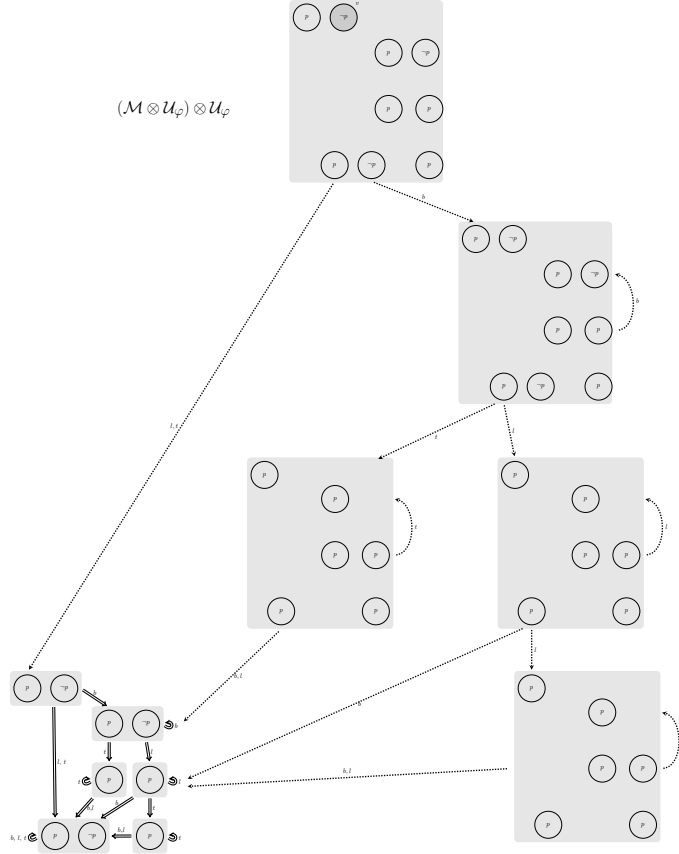

Fig. 8: Sketch of the result of the iterated product update operation $(\mathcal{M} \otimes \mathcal{U}_\varphi) \otimes \mathcal{U}_\varphi$. Grey rectangles are a compact way to represent sub-models originating from worlds in the previous model. Dotted arrows are meant to capture the direction of the arrows and the agents involved. Unlike double arrows, they do not represent arrows from and to all worlds in the rectangle, but only from and to some of these worlds. We leave to the reader their identification. Finally, note that the sink is a copy of the previous model.

with $k = 0$, and for the unique corresponding sequence $\alpha_0 Q_{i_1}^\varphi \alpha_1 Q_{i_2}^\varphi \alpha_2 \dots \alpha_{k-1} Q_{i_k}^\varphi \alpha_k$ of events $\alpha_j \in E^\varphi$ all $\text{pre}^\varphi(\alpha_j) = \top$ for $0 \leq j \leq k$. Formula θ is called *independent* of φ iff it is in \top -shape w.r.t. $0 \in E^\varphi$. If θ is not independent of φ , it is *dependent* on φ . *Example 22.* For formula $\varphi = B_b(B_t p \wedge B_l(p \wedge B_t p))$ from Example 1, we have that $\theta = \neg B_b B_b p \vee B_t B_l p$ is independent from φ because the modality sequences

$$\varepsilon, B_b, B_b B_b, B_t, \text{ and } B_t B_l$$

correspond to event sequences

$$0, 0Q_b^\varphi 4, 0Q_b^\varphi 4Q_t^\varphi 4, 0Q_t^\varphi -1, \text{ and } 0Q_t^\varphi -1Q_t^\varphi -1$$

and preconditions for events 0, 4, and -1 are all \top . On the other hand, $\eta = \neg B_b B_t p$ is dependent on φ because modality sequence $B_b B_t$ corresponds to event sequence $0Q_b^\varphi 4Q_t^\varphi 3$, and $\text{pre}^\varphi(3) = p \neq \top$. Both θ and η were true in \mathcal{M}, v from Fig. 1, left. While the pointed update with $(\mathcal{U}_\varphi, 0)$ keeps θ true, formula η becomes false in $\mathcal{M} \odot \mathcal{U}_\varphi, (v, 0)$ (see Fig. 6, right).

Theorem 23 (Update synthesis minimality). *If formula θ is independent of a DBI normal formula φ , then for any pointed Kripke model (\mathcal{M}, v) ,*

$$\mathcal{M}, v \models \theta \quad \iff \quad \mathcal{M} \odot \mathcal{U}_\varphi, (v, 0) \models \theta. \quad (5)$$

Proof. Let $\mathcal{M} = \langle S, R, V \rangle$. We prove by induction on the construction of θ that, for any $\alpha \in E^\varphi$ and any $u \in S$, if θ is in \top -shape w.r.t. α , then $\mathcal{M}, u \models \theta$ iff $\mathcal{M} \odot \mathcal{U}_\varphi, (u, \alpha) \models \theta$. (5) is an instance of this induction statement for $\alpha = 0$ and $u = v$. Note that if θ is in \top -shape w.r.t. α , then $\text{pre}^\varphi(\alpha) = \top$ because of the empty sequence ε , hence, the pointed update of (\mathcal{M}, u) with $(\mathcal{U}_\varphi, \alpha)$ is defined for all $u \in S$. For propositional atoms, the statement follows from the definition of pointed updates. The cases for Boolean connectives are straightforward. It remains to show the induction statement for $\theta = B_i \eta$. Let $\beta \in E^\varphi$ be the unique event such that $\alpha Q_i^\varphi \beta$. Then $\text{pre}^\varphi(\beta) = \top$ because of sequence B_i of θ and, additionally, η is in \top -shape w.r.t. β . By IH, for any $u \in S$, we have $\mathcal{M}, u \models \eta$ iff $\mathcal{M} \odot \mathcal{U}_\varphi, (u, \beta) \models \eta$. We have $\mathcal{M}, u \not\models B_i \eta$ iff $\mathcal{M}, w \not\models \eta$ for some $uR_i w$. By IH, this is equivalent to $\mathcal{M} \odot \mathcal{U}_\varphi, (w, \beta) \not\models \eta$, which is equivalent to $\mathcal{M} \odot \mathcal{U}_\varphi, (u, \alpha) \not\models B_i \eta$ because $(u, \alpha)R_i^\varphi (w, \gamma)$ iff $uR_i w$ and $\gamma = \beta$. \square

Corollary 24. *Let $\varphi = \bigwedge_{j \in G} B_j \omega_j$ be a DBI normal formula, where $\emptyset \neq G \subseteq \mathcal{A}$.*

1. *If $i \notin \text{ta}(\varphi)$, i.e., if $i \notin G$, then i 's beliefs are unaffected by pointed update \mathcal{U}_φ , i.e., $\mathcal{M}, v \models B_i \sigma$ iff $\mathcal{M} \odot \mathcal{U}_\varphi, (v, 0) \models B_i \sigma$ for any formula σ and any pointed Kripke model (\mathcal{M}, v) .*
2. *If $i \in \text{ta}(\varphi)$, but $\omega_i = \bigwedge_{j \in H} B_j \pi_j$ has no propositional component, then i 's propositional beliefs are unaffected by \mathcal{U}_φ , i.e., $\mathcal{M}, v \models B_i \chi$ iff $\mathcal{M} \odot \mathcal{U}_\varphi, (v, 0) \models B_i \chi$ for any propositional formula χ and any pointed Kripke model (\mathcal{M}, v) .*

Theorem 25 (Update synthesis consistency preservation). *Let φ be a DBI normal formula. Pointed update with \mathcal{U}_φ can only cause (higher-order) inconsistent beliefs if the respective (higher-order) beliefs originally excluded the respective propositional preconditions: for any modality sequence $B_{i_1} \dots B_{i_k}$ with $i_j \neq i_{j+1}$ for any j and any pointed Kripke model (\mathcal{M}, v) ,*

$$\mathcal{M}, v \models \widehat{B}_{i_1} \left(\text{pre}^\varphi(\alpha_1) \wedge \widehat{B}_{i_2} \left(\text{pre}^\varphi(\alpha_2) \wedge \dots \widehat{B}_{i_k} \text{pre}^\varphi(\alpha_k) \right) \right) \quad \iff \quad \mathcal{M} \odot \mathcal{U}_\varphi, (v, 0) \not\models B_{i_1} \dots B_{i_k} \perp \quad (6)$$

for the unique sequence $0Q_{i_1}^\varphi \alpha_1 Q_{i_2}^\varphi \alpha_2 \dots Q_{i_k}^\varphi \alpha_k$ of events $\alpha_j \in E^\varphi$.

Proof. Let $\mathcal{M} = \langle S, R, V \rangle$ and $\mathcal{M} \odot \mathcal{U}_\varphi = \langle S^\varphi, E^\varphi, V^\varphi \rangle$ for the pointed update of (\mathcal{M}, v) with $(\mathcal{U}_\varphi, 0)$. The left statement holds iff there is a sequence $vR_{i_1}s_1R_{i_2}s_2\dots R_{i_k}s_k$ of states from S such that $\mathcal{M}, s_j \models \text{pre}^\varphi(\alpha_j)$ for $j = 1, \dots, k$. It is easy to observe (by induction on k) that this is equivalent to $(s_j, \alpha_j) \in E^\varphi$ for $j = 1, \dots, k$ and $(v, 0)R_{i_1}^\varphi(s_1, \alpha_1)R_{i_2}^\varphi(s_2, \alpha_2)\dots R_{i_k}^\varphi(s_k, \alpha_k)$. The equivalence to the right statement now follows from the fact that $\mathcal{M} \odot \mathcal{U}_\varphi, (s_k, \alpha_k) \not\models \perp$ and the uniqueness of the sequence of α_j 's such that $0Q_{i_1}^\varphi\alpha_1Q_{i_2}^\varphi\alpha_2\dots Q_{i_k}^\varphi\alpha_k$. \square

Corollary 26. *Let φ be a DBI normal formula.*

1. *If φ fits either of the clauses of Cor. 24 for agent i , then \mathcal{U}_φ preserves i 's consistency, i.e., $\mathcal{M}, v \not\models B_i\perp$ iff $\mathcal{M} \odot \mathcal{U}_\varphi, (v, 0) \not\models B_i\perp$ for any (\mathcal{M}, v) .*
2. *If $\varphi = B_i(\xi \wedge \bigwedge_{k \in H} B_k\pi_k) \wedge \bigwedge_{j \in G} B_j\omega_j$ where $i \notin G$ and ξ is propositional, then \mathcal{U}_φ makes i 's beliefs inconsistent if and only if i originally does not consider ξ to be possible, i.e., $\mathcal{M}, v \models \widehat{B}_i\xi$ iff $\mathcal{M} \odot \mathcal{U}_\varphi, (v, 0) \not\models B_i\perp$ for any (\mathcal{M}, v) .*

Definition 27 (Idempotence). We call an action model (\mathcal{U}, α) *idempotent* iff pointed updates $(\mathcal{M} \odot \mathcal{U}, (w, \alpha))$ and $((\mathcal{M} \odot \mathcal{U}) \odot \mathcal{U}, ((w, \alpha), \alpha))$ are defined and isomorphic for any pointed Kripke model (\mathcal{M}, w) .

Theorem 28. *For any DBI normal formula φ and any pointed Kripke model (\mathcal{M}, v) , $\mathcal{M} \odot \mathcal{U}, (v, 0)$ is idempotent.*

Proof. The updates $\mathcal{M} \odot \mathcal{U}, (v, 0)$ and $(\mathcal{M} \odot \mathcal{U}) \odot \mathcal{U}, ((v, 0), 0)$ are always defined by Theorem 20.

Since \mathcal{U}_φ has an out-tree structure, we conduct the proof by induction over this structure beginning from the root 0.

Induction hypothesis: For every state $((w, \alpha), \beta)$ in $(\mathcal{M} \odot \mathcal{U}) \odot \mathcal{U}, \beta = \alpha$.

Base case: Point $(v, 0)$ is the only state that can be combined with 0, since by Definition 16 0 has no incoming edges in \mathcal{U}_φ .

Induction step: Suppose the IH holds for state $((w, \alpha), \alpha)$, but not for its i -accessible state $((x, \beta), \gamma)$, meaning $\gamma \neq \beta$. Note that this i -accessible state must exist, since $(\mathcal{M} \odot \mathcal{U}) \odot \mathcal{U}, ((v, 0), 0)$ could not be smaller than $\mathcal{M} \odot \mathcal{U}, (v, 0)$, as all preconditions in \mathcal{U}_φ are propositional by Definition 16. Since $((w, \alpha), \alpha)R_i^{\mathcal{U}}((x, \beta), \gamma)$ it must be the case that also $(w, \alpha)R_i^{\mathcal{U}}(x, \beta)$ by Definition 7. Since φ is DBI normal, every state in \mathcal{U}_φ has no more than one j -accessible state, hence β is the only i -accessible state from α . Therefore if $((w, \alpha), \alpha)R_i^{\mathcal{U}}((x, \beta), \gamma)$ it must be that $\gamma = \beta$. \square

4 The Role of Privatization

The minimality of the update synthesis method we have described relies on a particular structure of the action model used for the update. We call this structure *privatized*. In this section, we give an explicit definition and show why it serves the purpose of preserving beliefs whenever possible. We begin with the notion of modal syntactic tree, which represents the nesting of modalities within a formula as a tree and provides the basis of the formal definition of privatization. Note that the structure of the action model from Def. 16 (almost) exactly follows this tree structure already, so there was no need to introduce it explicitly.

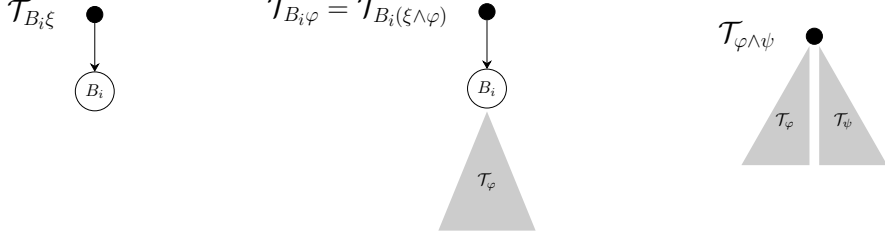

Fig. 9: Modal syntactic trees

Definition 29 (Modal syntactic tree). The *modal syntactic tree* \mathcal{T}_φ of a goal formula φ is an out-tree with a single unlabeled root, while all non-root nodes are labeled with modal operators.

Some examples of modal syntactic trees are provided in Fig. 9: In $\mathcal{T}_{B_i\xi}$, the root has one child-leaf labeled B_i . Both $\mathcal{T}_{B_i\varphi}$ and $\mathcal{T}_{B_i(\xi\wedge\varphi)}$ are obtained by labeling the root of \mathcal{T}_φ with B_i and making it the only child of the new root. Finally, $\mathcal{T}_{\varphi\wedge\psi}$ is obtained by taking the disjoint union of \mathcal{T}_φ and \mathcal{T}_ψ and identifying their roots.

Definition 30 (Modal-syntactic-tree root paths). For formula φ we define $RootP(\varphi)$ as the set of paths $((root, \alpha_1, i_1), \dots, (\alpha_{l-1}, \alpha_l, i_l))$ of length $l \geq 0$ in \mathcal{T}_φ starting from the root, where i_k is the label of α_k for $k = 1, \dots, l$.

Definition 31 (Kripke-frame root walks). For a pointed Kripke frame $(\langle S, R \rangle, w)$ we similarly define the set of root walks $RootW(\langle S, R \rangle, w)$ as the set of all walks starting from the root (point) w . We further define the restriction $RootW_{\text{nsr}}(\langle S, R \rangle, w)$ as the subset of $RootW(\langle S, R \rangle, w)$, where we exclude walks that contain at least two successive edges for the same agent.

Definition 32 (Agent sequence). For a walk $\sigma = ((\alpha_1, \alpha_2, i_1), \dots, (\alpha_l, \alpha_{l+1}, i_l))$ from Defs. 30 or 31 we define $AgSeq(\sigma) := (i_1, \dots, i_l)$. In particular, $AgSeq(\varepsilon) := \varepsilon$. We extend this definition to sets, where for a set of walks Σ , $AgSeq(\Sigma)$ is the set of corresponding agent sequences.

The set of all agent sequences of length l we denote by \mathcal{A}^l . The set of all agent sequences of length l without any successively repeating agents we denote by $\mathcal{A}_{\text{nsr}}^l$.

We now define agent-clusters and agent-accessible parts of the model.

Definition 33 (Clusters and reachable states). For a Kripke frame $\mathcal{F} = \langle W, R \rangle$, world $w \in W$, and sequence $(i_1, \dots, i_l) \in \mathcal{A}^l$ of agents, we introduce the *cluster of path-accessible worlds*

$$C_{\mathcal{F}, w}^{i_1, i_2, \dots, i_l} := \{u \in W \mid (\exists u_2, \dots, u_l \in W) wR_{i_1}u_2R_{i_2}\dots u_lR_{i_l}u\}. \quad (7)$$

In particular, for the empty sequence, $C_{\mathcal{F}, w}^\varepsilon = \{w\}$.

Finally, we have the necessary tools to formally describe the notion of privatization.

Definition 34 (Privatized). We call a pointed Kripke frame $(\mathcal{F}, w) = (\langle S, R \rangle, w)$ *privatized* w.r.t. formula φ iff for any root path $\sigma \in \text{Root}P(\varphi)$

$$C_{\mathcal{F},w}^{\text{AgSeq}(\sigma)} \neq \emptyset \text{ and } \left(\forall \text{agSeq} \in \bigcup_{l=0}^{\infty} \mathcal{A}_{\text{nsr}}^l \setminus \{\text{AgSeq}(\sigma)\} \right) \left(C_{\mathcal{F},w}^{\text{AgSeq}(\sigma)} \cap C_{\mathcal{F},w}^{\text{agSeq}} \right) = \emptyset. \quad (8)$$

Definition 35 (Weakly Privatized). Similarly we call a pointed Kripke frame $(\mathcal{F}, w) = (\langle S, R \rangle, w)$ *weakly privatized* w.r.t. formula φ iff for any root path $\sigma \in \text{Root}P(\varphi)$

$$\left(\forall \text{agSeq} \in \bigcup_{l=0}^{\infty} \mathcal{A}_{\text{nsr}}^l \setminus \{\text{AgSeq}(\sigma)\} \right) \left(C_{\mathcal{F},w}^{\text{AgSeq}(\sigma)} \cap C_{\mathcal{F},w}^{\text{agSeq}} \right) = \emptyset. \quad (9)$$

Definition 36 (Walk accessibility). For a pointed Kripke frame $(\mathcal{F}, w) = (\langle W, R \rangle, w)$ we define *walk accessibility operator*

$$\text{WAcc}_{\text{nsr}}(u, \mathcal{F}, w) := \{ \sigma \in \text{Root}W_{\text{nsr}}(\mathcal{F}, w) \mid \pi_2 \pi_{|\sigma} \sigma = u \} \quad (10)$$

to be the set of agent-alternating walks starting from w and ending in u .

Walk accessibility yields an alternative equivalent definition of privatized frames:

Corollary 37 (Privatized alternative). *A pointed Kripke frame (\mathcal{F}, w) is privatized w.r.t. φ iff for any root path $\sigma \in \text{Root}P(\varphi)$*

$$C_{\mathcal{F},w}^{\text{AgSeq}(\sigma)} \neq \emptyset \text{ and } \left(\forall s \in C_{\mathcal{F},w}^{\text{AgSeq}(\sigma)} \right) |\text{AgSeq}(\text{WAcc}_{\text{nsr}}(s, \mathcal{F}, w))| = 1. \quad (11)$$

Proof. Follows from Defs. 32, 34 and 36. \square

Corollary 38 (Weakly privatized alternative). *A pointed Kripke frame (\mathcal{F}, w) is privatized w.r.t. φ iff for any root path $\sigma \in \text{Root}P(\varphi)$*

$$\left(\forall s \in C_{\mathcal{F},w}^{\text{AgSeq}(\sigma)} \right) |\text{AgSeq}(\text{WAcc}_{\text{nsr}}(s, \mathcal{F}, w))| = 1. \quad (12)$$

Proof. Follows from Defs. 32, 35 and 36. \square

Theorem 39. *For DBI formula φ , the pointed action model $(\mathcal{U}_\varphi, 0)$ is privatized w.r.t. φ .*

Proof. by induction on the recursive construction of \mathcal{U}_φ as by Definition 16.

Base case: For formula $B_i \xi$, where ξ is propositional, since $\text{AgSeq}(\text{Root}P(B_i \xi)) = \{\varepsilon, (i)\}$, we only need to check all states walk-accessible via these two sequences. Since in $\mathcal{U}_{B_i \xi}$ the state $m \notin \{0, -1\}$ is the only state accessible via an i -edge from the root 0, as the 0 itself has no incoming arrows, $\text{AgSeq}(\text{WAcc}_{\text{nsr}}(m, \mathcal{U}_{B_i \xi}, 0)) = \{i\}$. Furthermore the root 0 is only walk-accessible via the empty sequence ε , therefore $\text{AgSeq}(\text{WAcc}_{\text{nsr}}(0, \mathcal{U}_{B_i \xi}, 0)) = \{\varepsilon\}$. Lastly as the sink -1 is not walk-accessible via any of the two sequences ε and (i) in

$AgSeq(\text{Root}P(B_i\xi))$ we conclude that $(\mathcal{U}_{B_i\xi}, 0)$ is indeed privatized w.r.t. $B_i\xi$.

Induction step: If $\varphi = B_i\psi$ for DBI normal formula ψ , then $(\mathcal{U}_\psi, 0)$ is privatized w.r.t. ψ . $\text{Root}P(\varphi)$ extends the paths in $\text{Root}P(\psi)$ right after the root with an edge to m as so:

$$\text{Root}P(\varphi) = \{\varepsilon\} \cup \{((\text{root}, m, i), (m, \alpha_1, j_1) \dots (\alpha_{l-1}, \alpha_l, j_l)) \mid \\ ((\text{root}, \alpha_1, j_1), \dots (\alpha_{l-1}, \alpha_l, j_l)) \in \text{Root}P(\psi) \text{ and } l \geq 0\}.$$

Since the set of walks in $\text{Root}W_{\text{nsr}}(\mathcal{U}_\psi, 0)$ is extended in exactly the same way, $(\mathcal{U}_\varphi, 0)$ must also be privatized w.r.t. φ .

If $\varphi = B_i(\xi \wedge \psi)$ for propositional formula ξ and DBI normal formula ψ , the reasoning is analogous to the previous case, as privatization is a frame property and thus independent of the additional precondition added.

If $\varphi = \psi \wedge \theta$, for DBI normal formulas ψ and θ , then

$$\text{Root}P(\varphi) = \text{Root}P(\psi) \cup \text{Root}P(\theta).$$

Again since by Definition 16 $\text{Root}W(\mathcal{U}_\varphi) = \text{Root}W(\mathcal{U}_\psi) \cup \text{Root}W(\mathcal{U}_\theta)$ is extended the same way, $(\mathcal{U}_\varphi, 0)$ is again privatized w.r.t. φ and we are done. Note that in \mathcal{U}_φ not only the root 0, but also the sink nodes -1 of \mathcal{U}_ψ and \mathcal{U}_θ are unified. \square

We will sometimes lightly abuse the notation by applying properties defined on Kripke frames to Kripke models $\langle S, R, V \rangle$ and action models $\langle E, Q, \text{pre} \rangle$. In all such cases, we mean the property to be applied to frames $\langle S, R \rangle$ and $\langle E, Q \rangle$ respectively.

Lemma 40. *Let the pointed update $(\mathcal{M} \odot \mathcal{U}, (w, \alpha))$ of a pointed Kripke model (\mathcal{M}, w) with a pointed action model (\mathcal{U}, α) be defined. For any $agSeq \in \bigcup_{l=0}^{\infty} \mathcal{A}^l$,*

$$(x, \beta) \in C_{\mathcal{M} \odot \mathcal{U}, (w, \alpha)}^{agSeq} \implies \beta \in C_{\mathcal{U}, \alpha}^{agSeq} \text{ and } x \in C_{\mathcal{M}, w}^{agSeq}. \quad (13)$$

Proof. Let $\mathcal{M} = \langle S, R, V \rangle$, $\mathcal{U} = \langle E, Q, \text{pre} \rangle$, and $\mathcal{M} \odot \mathcal{U} = \langle S', R', V' \rangle$. We use induction on $l = |agSeq|$.

Base case $l = 0$: Since $\mathcal{A}^0 = \{\varepsilon\}$ the statement follows trivially from Defs. 33 and 7.

Induction step: Consider any agent sequence $\overline{agSeq} = agSeq \circ i$ of length $l + 1$ and state $(x, \beta) \in C_{\mathcal{M} \odot \mathcal{U}, (w, \alpha)}^{\overline{agSeq}}$. By Def. 33, there must exist a state $(v, \gamma) \in C_{\mathcal{M} \odot \mathcal{U}, (w, \alpha)}^{agSeq}$ such that $(v, \gamma)R'_i(x, \beta)$, in particular, vR_ix and $\gamma Q_i\beta$ by Def. 7. By IH for \overline{agSeq} of length l , we have $v \in C_{\mathcal{M}, w}^{agSeq}$ and $\gamma \in C_{\mathcal{U}, \alpha}^{agSeq}$. Thus, by Def. 33 both $x \in C_{\mathcal{M}, w}^{\overline{agSeq}}$ and $\beta \in C_{\mathcal{U}, \alpha}^{\overline{agSeq}}$. \square

Theorem 41. *For pointed action model (\mathcal{U}, α) privatized w.r.t. DBI formula φ and pointed epistemic Kripke model (\mathcal{M}, w) if their pointed update exists, then $(\mathcal{M} \odot \mathcal{U}, (w, \alpha))$ is weakly privatized w.r.t. φ .*

Proof. Suppose by contradiction that the pointed action model (\mathcal{U}, α) is privatized w.r.t. φ , but for some pointed Kripke model (\mathcal{M}, v) , the update $(\mathcal{M} \odot \mathcal{U}, (w, \alpha))$

exists, however is not weakly privatized w.r.t. φ . This means that there exists a root path $\sigma \in \text{Root}P(\varphi)$, agent sequence $agseq \in \bigcup_{l=0}^{\infty} \mathcal{A}_{n_{sr}}^l \setminus \text{AgSeq}(\sigma)$ and state $(x, \beta) \in C_{\mathcal{M} \odot \mathcal{U}, (w, \alpha)}^{agseq}$ and $(x, \beta) \in C_{\mathcal{M} \odot \mathcal{U}, (w, \alpha)}^{AgSeq(\sigma)}$. By Lemma 40 this implies that $\beta \in C_{\mathcal{U}, \alpha}^{AgSeq(\sigma)}$ and $\beta \in C_{\mathcal{U}, \alpha}^{agseq}$. However this contradicts the assumption that (\mathcal{U}, α) is privatizing w.r.t. φ , as $C_{\mathcal{U}, \alpha}^{AgSeq(\sigma)} \cap C_{\mathcal{U}, \alpha}^{agseq} = \emptyset$ \square

Theorem 42. *For DBI formula φ and any pointed Kripke model (\mathcal{M}, v) , the pointed update between $(\mathcal{U}_\varphi, 0)$ and (\mathcal{M}, v) is defined and $(\mathcal{M} \odot \mathcal{U}, (w, \alpha))$ is weakly privatized.*

Proof. Follows immediately from Theorem 41. \square

5 Conclusions

We presented a way to synthesize a pointed action model for a limited range of goal formulas that: (i) makes the goal formula true in the resulting model; (ii) privatizes any Kripke model to which it is applied to, thus breaking the common knowledge of the model assumption and simulating totally private communication; (iii) preserves consistency whenever possible, marking a difference from, e.g., [9]; and (iv) has minimal side effects, in the sense that it changes as few beliefs unspecified in the goal formula as possible. In addition, the synthesized pointed action models are combined with pointed Kripke models via the new pointed update operation, which does not apply to the whole model globally, but rather it respects the structure of the privatization introduced in the synthesis. Since the pointed update is a subset of the full product update operation, the proposed update mechanism is quite efficient: only the initial update increases the size of the model at worst linearly in the size of the goal formula, while all subsequent updates via goal formulas with the same belief structure (or substructure thereof) only decrease the model size. Compare this with the exponential blow up after iterated updates using the standard product updates.

Future work. We aim at extending the update mechanism so as to allow a wider range of goal formulas, introducing negations of modal operators, which might introduce ignorance, and disjunctions of modal operators, which have multiple possible realizations, while preserving the properties of privatization, minimality and consistency. Furthermore, we plan to introduce group updates such as public announcements, providing full granularity in the update design.

Acknowledgments. We are grateful to Hans van Ditmarsch, Stephan Felber, Kristina Fruzsza, Rojo Randrianomentsoa, Hugo Rincón Galeana, and Ulrich Schmid for multiple illuminating and inspiring discussions.

References

- [1] S. Artemov. Observable models. In S. Artemov and A. Nerode, editors, *Logical Foundations of Computer Science: International Symposium, LFCS 2020, Deerfield Beach, FL, USA, January 4–7, 2020, Proceedings*, volume 11972 of *Lecture Notes in Computer Science*, pages 12–26. Springer, 2020. [doi:10.1007/978-3-030-36755-8_2](https://doi.org/10.1007/978-3-030-36755-8_2).

- [2] G. Aucher and F. Schwarzentruber. On the complexity of dynamic epistemic logic. In B. C. Schipper, editor, *TARK 2013: Theoretical Aspects of Rationality and Knowledge, Proceedings of the 14th Conference — Chennai, India*, pages 19–28. University of California, Davis, 2013. doi:10.48550/arXiv.1310.6406.
- [3] A. Baltag and B. Renne. Dynamic epistemic logic. In E. N. Zalta, editor, *The Stanford Encyclopedia of Philosophy*. Metaphysics Research Lab, Stanford University, Winter 2016 edition, 2016. Available from: <https://plato.stanford.edu/archives/win2016/entries/dynamic-epistemic/>.
- [4] A. Baltag and S. Smets. A qualitative theory of dynamic interactive belief revision. In G. Bonanno, W. van der Hoek, and M. Wooldridge, editors, *Logic and the Foundations of Game and Decision Theory (LOFT 7)*, volume 3 of *Texts in Logic and Games*, pages 11–58. Amsterdam University Press, 2008. Available from: <https://www.jstor.org/stable/j.ctt46mz4h.4>.
- [5] J. van Benthem and S. Smets. Dynamic logics of belief change. In H. van Ditmarsch, J. Y. Halpern, W. van der Hoek, and B. Kooi, editors, *Handbook of Epistemic Logic*, pages 313–393. College Publications, 2015.
- [6] P. Blackburn, M. de Rijke, and Y. Venema. *Modal Logic*, volume 53 of *Cambridge Tracts in Theoretical Computer Science*. Cambridge University Press, 2001. doi:10.1017/CB09781107050884.
- [7] H. van Ditmarsch. Revocable belief revision. *Studia Logica*, 101(6):1185–1214, December 2013. doi:10.1007/s11225-013-9529-9.
- [8] H. van Ditmarsch, W. van der Hoek, and B. Kooi. *Dynamic Epistemic Logic*, volume 337 of *Synthese Library*. Springer, 2007. doi:10.1007/978-1-4020-5839-4.
- [9] H. van Ditmarsch, W. van der Hoek, B. Kooi, and L. B. Kuijer. Arrow update synthesis. *Information and Computation*, 275:104544, 2020. doi:https://doi.org/10.1016/j.ic.2020.104544.
- [10] R. Fagin, J. Y. Halpern, Y. Moses, and M. Y. Vardi. *Reasoning About Knowledge*. MIT Press, 1995. doi:10.7551/mitpress/5803.001.0001.
- [11] J. Hales. Arbitrary action model logic and action model synthesis. In *2013 28th Annual ACM/IEEE Symposium on Logic and Computer Science (LICS), 25–28 June 2013, New Orleans, Louisiana*, pages 253–262. IEEE, 2013. doi:10.1109/LICS.2013.31.
- [12] S. O. Hansson. Logic of belief revision. In E. N. Zalta, editor, *The Stanford Encyclopedia of Philosophy*. Metaphysics Research Lab, Stanford University, Spring 2022 edition, 2022. Available from: <https://plato.stanford.edu/archives/spr2022/entries/logic-belief-revision/>.
- [13] A. Herzig. Dynamic epistemic logics: promises, problems, shortcomings, and perspectives. *Journal of Applied Non-Classical Logics*, 27(3–4):328–341, 2017. doi:10.1080/11663081.2017.1416036.
- [14] J. Hintikka. *Knowledge and Belief: An Introduction to the Logic of the Two Notions*. Cornell University Press, 1962.
- [15] B. Kooi and B. Renne. Generalized arrow update logic. In K. R. Apt, editor, *TARK XIII, Theoretical Aspects of Rationality and Knowledge: Proceedings of the Thirteenth Conference (TARK 2011)*, pages 205–211. Association for Computing Machinery, 2011. doi:10.1145/2000378.2000403.

- [16] E. Lorini. Exploiting belief bases for building rich epistemic structures. In L. S. Moss, editor, *Proceedings Seventeenth Conference on Theoretical Aspects of Rationality and Knowledge, Toulouse, France, 17–19 July 2019*, volume 297 of *Electronic Proceedings in Theoretical Computer Science*, pages 332–353. Open Publishing Association, 2019. doi:[10.4204/EPTCS.297.21](https://doi.org/10.4204/EPTCS.297.21).
- [17] E. Lorini. Rethinking epistemic logic with belief bases. *Artificial Intelligence*, 282:103233, May 2020. doi:[10.1016/j.artint.2020.103233](https://doi.org/10.1016/j.artint.2020.103233).
- [18] J. A. Plaza. Logics of public communications. In M. L. Emrich, M. S. Pfeifer, M. Hadzikadic, and Z. Ras, editors, *Proceedings of the Fourth International Symposium on Methodologies for Intelligent Systems: Poster Session Program*, pages 201–216. Oak Ridge National Laboratory, 1989.