

A SURVEY ON THE LE-MURAKAMI-OHTSUKI INVARIANT FOR CLOSED 3-MANIFOLDS

BENJAMIN ENRIQUEZ AND ANDERSON VERA

ABSTRACT. We review the original approach to the *Le-Murakami-Ohtsuki (LMO) invariant* of closed 3-manifolds (as opposed to the later approach based on the Aarhus integral). Following the ideas of surgery presentation, we introduce a class of combinatorial structures, called *Kirby structures*, which we prove to yield multiplicative 3-manifold invariants. We illustrate this with the Reshetikhin-Turaev invariants. We then introduce a class of combinatorial structures, called *pre-LMO structures*, and prove that they give rise to Kirby structures. We show how the Kontsevich integral can be used to construct a pre-LMO structure. This yields two families of multiplicative 3-manifold invariants $\{\Omega_n^c\}_{n \geq 1}$ and $\{\Omega_n^o\}_{n \geq 1}$. We review the elimination of redundant information in the latter family, leading to the construction of the LMO invariant. We also provide uniqueness results of some aspects of the LMO construction. The family of invariants $\{\Omega_n^c\}_{n \geq 1}$ is not discussed explicitly in the literature; whereas Ω_n^c enables one to recover Ω_n^o for any $n \geq 1$, we show that these invariants coincide for $n = 1$.

CONTENTS

Introduction	2
Acknowledgements	4
Notations	5
1. Partitions and (oriented) Brauer diagrams	5
1.1. A category <i>Part</i> of partitions	6
1.2. Classification of finite $\mathbb{Z}_2 * \mathbb{Z}_2$ -sets	10
1.3. The category <i>Br</i> of Brauer diagrams	12
1.4. Operations on Brauer diagrams	13
1.5. Oriented Brauer diagrams	14
1.6. Operations on oriented Brauer diagrams	14
1.7. Properties of operations of oriented Brauer diagrams	15
1.8. Schematic representation of Brauer diagrams, oriented Brauer diagrams and their operations	17
2. Links, tangles, KII map, Kirby bialgebras, pre-LMO structures and invariants of 3-manifolds	18
2.1. Presentation of 3-manifolds based on links in S^3	19
2.2. Framed oriented tangles: basic definitions	23
2.3. Orientation-reversal operation for framed oriented tangles	26
2.4. Doubling operations for framed oriented tangles	27
2.5. KII map for framed oriented tangles	27
2.6. Alternative description of the image $\text{KII}\vec{\mathcal{T}}$ of the KII map	29
2.7. Decomposition of the set $\text{KII}\vec{\mathcal{T}}$	38
2.8. Kirby bialgebra, (semi)Kirby structures, and invariants of 3-manifolds	40
2.9. Kirby structures arising from pre-LMO structures over symmetric monoidal categories	43
3. Construction of a pre-LMO structure based on the Kontsevich integral	51
3.1. Preliminaries on linear and cyclic orders	52
3.2. The functor $\hat{\mathcal{A}}(P, \bullet)$ of Jacobi diagrams	53

Date: June 12, 2024.

2020 *Mathematics Subject Classification.* 57K16, 57K31.

Key words and phrases. Knot, tangles, 3-manifold, surgery presentation, Kirby calculus, quantum invariants, Kontsevich integral, Le-Murakami-Ohtsuki invariant.

3.3.	The natural transformation $\text{Tens}^{\mathcal{A}}(P, P')_{\bullet, \bullet'}$	55
3.4.	The natural transformation $\text{Comp}^{\mathcal{A}}(P, P')_{\bullet, \bullet'}$	56
3.5.	The natural transformation $\text{co}^{\mathcal{A}}(P, \bullet)$	58
3.6.	The natural transformation $\text{dbl}_{\mathcal{A}}((P, A), \bullet)$	58
3.7.	Proof of the pre-LMO axioms (LMO1), (LMO2) and (LMO3)	60
3.8.	The natural transformation $\text{co}^{\mathcal{A}}((P, a), \bullet)$ and the assignment $Z_{\mathcal{A}}(\bullet)$	62
3.9.	Proof of the pre-LMO axiom (LMO4) and the pre-LMO structure $\dot{\mathbf{A}}$	66
3.10.	Additional material	66
4.	Construction of two families of invariants $\{\Omega_n^{\mathfrak{c}}\}_{n \geq 1}$ and $\{\Omega_n^{\mathfrak{d}}\}_{n \geq 1}$ of 3-manifolds	70
4.1.	The automorphism cs^{ν} of the algebra $\bigoplus_{k \geq 0} \hat{\mathcal{A}}_k^{\wedge}$	70
4.2.	The algebras $\mathfrak{s}(\mathbf{A})$, \mathfrak{a} and the algebra isomorphism $\overline{\text{cs}}^{\nu} : \mathfrak{s}(\mathbf{A}) \rightarrow \mathfrak{a}$	72
4.3.	The algebras $\mathfrak{b}(n)$ and the morphisms $\varphi_n : \mathfrak{a} \rightarrow \mathfrak{b}(n)$	93
4.4.	The spaces of diagrammatic traces and the LMO diagrammatic trace	96
4.5.	The algebras $\mathfrak{c}(n)$ and the morphisms $\bar{j}_n : \mathfrak{b}(n) \rightarrow \mathfrak{c}(n)$	99
4.6.	The algebras $\mathfrak{d}(n)$ and the morphisms $\text{pr}_n : \mathfrak{c}(n) \rightarrow \mathfrak{d}(n)$	111
4.7.	The equality $\mathfrak{c}(1) = \mathfrak{d}(1)$	112
4.8.	The families of 3-manifold invariants $\{\Omega_n^{\mathfrak{c}}\}_{n \geq 1}$ and $\{\Omega_n^{\mathfrak{d}}\}_{n \geq 1}$	115
4.9.	Equality of $\Omega_1^{\mathfrak{c}}$ and $\Omega_1^{\mathfrak{d}}$	115
4.10.	On the construction of the algebras $\mathfrak{c}(n)$	115
5.	Elimination of redundant information and the LMO invariant	116
5.1.	A bialgebra structure on $\bigoplus_{k \geq 0} \hat{\mathcal{A}}_k^{\wedge}$	117
5.2.	A semi-Kirby structure morphism $\Delta_{n,p}^{\mathfrak{b}} : \mathfrak{b}(n) \rightarrow \mathfrak{b}(p) \otimes \mathfrak{b}(n-p)$	118
5.3.	A Kirby structure morphism $\Delta_{n,p}^{\mathfrak{c}} : \mathfrak{c}(n) \rightarrow \mathfrak{c}(p) \otimes \mathfrak{c}(n-p)$	128
5.4.	A Kirby structure morphism $\Delta_{n,p}^{\mathfrak{d}} : \mathfrak{d}(n) \rightarrow \mathfrak{d}(p) \otimes \mathfrak{d}(n-p)$	129
5.5.	The Kirby structure $\mathfrak{e}(n)$ and the invariant $\Omega_n^{\mathfrak{e}}$	131
5.6.	The LMO invariant Z^{LMO}	133
6.	Relation with the Aarhus integral	133
6.1.	The Aarhus integral	134
	Index of notations	136
	References	139

INTRODUCTION

A *knot* (resp. *link*) is the isotopy class of an embedding of the circle S^1 (resp. several copies of S^1) into the 3-dimensional sphere S^3 . The study of these objects is known as *knot theory*. This theory has relations with many other areas, in particular, it is closely related with the study of the topology of 3-manifolds. (From now on, we use the word 3-manifold to mean compact, connected oriented 3-manifold.) One instance of these relations is the following: starting with a link, we can remove a neighborhood (solid torus) of each of its components and paste them again using some parameters (*framing*). This gives rise to a new 3-manifold, the framed link used in the process is known as a *surgery presentation* of the 3-manifold. Some remarkable facts are that every 3-manifold admits a surgery presentation (Lickorish-Wallace Theorem) and that the links underlying two surgery presentations of the same 3-manifold can be related by a finite sequence of standard modifications called *Kirby moves* (Kirby Theorem), see [37, 58, 27, 39].

Until the 80s, the main approach to construct invariants for knots and 3-manifolds was based on tools of algebraic topology (e.g. homotopy, homology, covering spaces, etc). The close relationship between knots and 3-manifolds was not really used to obtain invariants of the latter using invariants of the former. A new perspective arose in 1984 with the introduction of a new knot invariant: the *Jones polynomial* [25]. This was followed by the discovery of a great variety of new knot invariants following Jones' ideas and interpretations of it [20, 44, 26, 51, 52, 47], notably HOMFLY-PT and Kauffman polynomials, which

established connections with other areas of mathematics: quantum groups, Lie algebras, mathematical physics, etc. This was the starting point of the so-called *quantum invariants* of knots. Around the same time, Witten [59] gave an interpretation of the Jones polynomial using physics ideas which allowed him to suggest the existence of new invariants of 3-manifolds.

One of the possible mathematical constructions of the invariants proposed by Witten was first obtained by N. Reshetikhin and V. Turaev using representations of quantum groups [45]. They showed that the above-mentioned surgery description of 3-manifolds, based in the Lickorish-Wallace and Kirby theorems, enables one to build up 3-manifold invariants out of certain quantum knot invariants (see the surveys [38, 43, 54]). These constructions were generalized to categorical settings in a series of works, see for instance [54].

Around the 90s, Vassiliev [56] proposed another approach for studying knots, based on the study of the topology of the space of all knots and leading to the introduction of an algorithm for constructing knot invariants. In [11], it was shown that the invariants obtained in [56] satisfy the vanishing of certain alternating sums, and it was proved that the set of invariants satisfying this vanishing condition contains the information of the Jones, HOMFLY-PT and Kauffman polynomials. In the independent work [21, 22], the same set of invariants was introduced, and its relation with the HOMFLY-PT polynomial was also obtained. The invariants of this set are called *finite-type invariants* in [21], and commonly referred to as *Vassiliev* or *Vassiliev-Goussarov* invariants.

In [28] (see also [3] where details are worked out), an explicit formula for a knot invariant is given, which is called the *Kontsevich integral*; this invariant takes its values in a degree completed vector space $\mathcal{A}^{\text{chords}} = \prod_{n \geq 0} \mathcal{A}_n^{\text{chords}}$ of *chord diagrams* on a circle. The Kontsevich integral is a *universal Vassiliev invariant*, that is, for any $n \geq 0$ and any \mathbb{Q} -valued Vassiliev invariant V of degree n there exists a linear map $\varphi_V : \mathcal{A}_{\leq n}^{\text{chords}} \rightarrow \mathbb{Q}$ such that V is the composition of the Kontsevich integral with the map $\mathcal{A}^{\text{chords}} \xrightarrow{\text{proj}} \mathcal{A}_{\leq n}^{\text{chords}} \xrightarrow{\varphi_V} \mathbb{Q}$. The Kontsevich integral is also a *universal quantum invariant*, as any such invariant can be recovered by the choice of a *weight system* (constructed from the same data used to construct the quantum invariant: a semi-simple Lie algebra and one of its finite dimensional representations).

As mentioned above, the Reshetikhin-Turaev 3-manifold invariants are constructed using surgery presentations and quantum invariants of knots. Then the question arose of the similar construction of 3-manifold invariants, replacing the quantum invariants of knots by the Kontsevich integral. This question was solved in a series of works. A key step toward a solution is the understanding of the behavior of the Kontsevich integral under Kirby moves; this was accomplished in [30], where Le and Murakami introduced a normalization \check{Z} of the Kontsevich integral and described its behavior under the second Kirby move. In [29, 32], a quotient $\mathcal{A}^{\text{chords}} / (P^2 + \text{COA} + L^{<2})$ of $\mathcal{A}^{\text{chords}}$ was constructed¹, and the corresponding reduction of \check{Z} was shown to be invariant under the second Kirby move. Then a normalization of this reduction, using the signature of the linking matrix, gives rise to a 3-manifold invariant valued in $\mathcal{A}^{\text{chords}} / P^2 + \text{COA} + L^{<2}$.

In [31], this construction was extended to more general quotients $\mathcal{A}^{\text{chords}} / P^{n+1} + \text{COA} + L^{<2n} + (\text{deg} > n)$ giving rise, for each positive integer n , to a 3-manifold invariant taking values in a quotient of a space of *Jacobi diagrams* (trivalent graphs with additional structure up to some local relations), usually denoted by $\mathcal{A}(\emptyset) / (\text{deg} > n)$. These invariants were then reassembled into a single invariant, the *Le-Murakami-Ohtsuki* invariant, taking their values in the space $\mathcal{A}(\emptyset)$. These works are surveyed in [41, 33].

To sum up, the construction in [31] of the LMO invariant proceeds according to the following steps, where we use the notation of the present work:

- (1) Construction of a family of invariants $\{\Omega_n^{\epsilon}\}_{n \geq 1}$
 - (a) description of the fibers of the surgery map $\{\text{framed oriented links in } S^3\} \rightarrow \{\text{3-manifolds}\}$ in terms of the Kirby moves KI and KII;
 - (b) study of the behavior of a normalized version of the Kontsevich invariant of links with respect to the second Kirby move;

¹In [29, 32], the relations P^2 and COA are called 3T-relation and OI-relation, respectively. The relation $L^{<2}$ consists of the 0-vanishing and 1-vanishing relations in [29, 32].

- (c) using (b) and a normalization utilizing the signature of the linking matrix to construct a map $\Omega_n^c : \{\text{framed oriented links in } S^3\} \rightarrow \mathcal{A}_0/(\text{deg} > n)$ for each integer $n > 0$, invariant under the Kirby moves, and which is therefore an invariant of 3-manifolds;
- (2) Elimination of redundant information
 - (a) establishing comparison properties of the various Ω_n^c for $n > 0$, based on coproduct operations of Jacobi diagrams;
 - (b) constructing the LMO invariant Z^{LMO} by putting together the information provided by each Ω_n^c , $n > 0$ which is new with respect to the Ω_k^c with $k < n$.

There is an alternative approach to this construction, based on a diagrammatic version of the Gaussian integral (called *Aarhus integral*), proposed by the authors of [6, 7, 8]. One of the main differences with the original approach is that the Aarhus integral gives the LMO in one fell swoop, that is, without going through the construction of an invariant at each degree. This approach only works for rational homology spheres, which is not a weakness since the LMO invariant is particularly interesting for those types of 3-manifolds, as it is known that the restriction of the LMO invariant to non- \mathbb{Q} -homology spheres can be expressed using classical invariants.

A recurring idea in quantum topology is the identification of the set of homeomorphism classes of closed 3-manifolds with the set of endomorphisms of the empty surface in a category of cobordisms between surfaces. An extension of a given invariant of closed 3-manifolds to a functor with source a category of cobordisms, which recovers it by restriction to the endomorphism set of the empty surface, is called a TQFT (topological quantum field theory) extending this invariant. TQFT extensions of the Reshetikhin-Turaev invariants were constructed in [46, 55]. Similarly, a kind of TQFT extension of the LMO invariant was first obtained in [40] using the original LMO techniques. In [14] a TQFT extension of the LMO invariant was constructed using the Aarhus integral, recovering the previous extension from [15].

The purpose of the present paper is to review the original definition of the LMO invariant. We clarify some of the combinatorial backgrounds of the construction of 3-manifolds invariants using surgery presentation, mainly of the LMO construction, either by relating it with known constructions (Brauer algebras) or introducing appropriate notions (Kirby monoid/structures). We also give a unified and detailed account of some parts of the construction, filling in some gaps. We also provide uniqueness results of some aspects of the LMO construction (see §4.10). Let us describe in detail the contents of each section.

In §1, we make explicit the combinatorial structure underlying the theory of tangles, which we show to be naturally related to that of Brauer category [36]. In §2, we formalize the application of the Lickorish-Wallace and Kirby (LW-K) theorems to the construction of 3-manifold invariants, via the introduction of the notion of *Kirby structure*; these invariants are multiplicative with respect to the connected sum of 3-manifolds. This is illustrated with the Kirby structures giving rise to Reshetikhin-Turaev invariants. We then introduce the notion of *pre-LMO structure*, which naturally yields a Kirby structure. In §3, following literature, we show how the Kontsevich integral and its compatibilities with certain operations (change of orientation, cabling) give rise to a pre-LMO structure. In §4, following the ideas of the source papers, we consider a sequence of maps between different quotient spaces of Jacobi diagrams, which yields two families of multiplicative 3-manifold invariants $\{\Omega_n^c\}_{n \geq 1}$ and $\{\Omega_n^d\}_{n \geq 1}$, see Theorem 4.73. The invariance property of Ω_n^c is new and implies the invariance property for Ω_n^d .

In §5 we construct relations between the various Ω_n^c as well as between the various Ω_n^d . We show that the space $\mathfrak{d}(n)$ where Ω_n^d takes its values is isomorphic to $\mathfrak{e}(n) := \mathcal{A}_0/(\text{deg} > n)$, we denote by Ω_n^c the image of Ω_n^d by this isomorphism. The resulting relations between the $\{\Omega_n^c\}_{n \geq 1}$ account for overlap of the information contained in the various Ω_n^c . The LMO invariant is constructed out of the family $\{\Omega_n^c\}_{n \geq 1}$ by eliminating the redundant information.

For more details, we refer to the local introductions of each section.

Acknowledgements. The research of B.E. has been partially funded by ANR grant “Project HighAGT ANR20-CE40-0016”. The research of A.V. is supported by the grant IBS-R003-Y002. We thank sincerely Jun Murakami and Yuta Nozaki and for helpful and stimulating discussions.

Notations. The following is a list of common notations used throughout this work. Additionally, we refer readers to the index of notations at the end of the paper.

- For an integer $l \geq 0$ we denote by $\llbracket 1, l \rrbracket$ the set of integers k such that $1 \leq k \leq l$. In particular, $\llbracket 1, 0 \rrbracket = \emptyset$.
- For a finite set X we denote by $|X|$ its cardinality; by \mathfrak{S}_X the symmetric group on X and by $\text{FPFI}(X)$ the set of fixed-point free involutions of X .
- For V a \mathbb{C} -vector space and a subset $S \subset V$, we denote by $\text{Vec}_{\mathbb{C}}S$ the subspace of V generated by S , i.e., the smallest subspace of V containing S . If V is complete graded and the subset S consists of homogeneous elements, then $\widehat{\text{Vec}}_{\mathbb{C}}S$ denotes the complete graded subspace of V generated by S .
- For a set X , we denote by $\mathcal{P}(X)$ its power set, i.e., the set of all subsets of X .
- For X a set, we denote by $\mathbb{C}X$ the free \mathbb{C} -vector space on X .
- \emptyset empty word.
- $\emptyset, \tilde{\emptyset}$ empty Brauer diagram, empty tangle, empty link.
- Let Set_f (resp. Set_f^*) be the category whose objects are (resp. pointed) finite sets and set of morphisms given by (resp. pointed) bijections.
- Let Vect denote the category of \mathbb{C} -vector spaces.

1. PARTITIONS AND (ORIENTED) BRAUER DIAGRAMS

Consider a *tangle* in a cube $[-1, 1]^3$, that is, an isotopy class of a proper embedding $T : P \rightarrow [-1, 1]^3$ of a compact 1-manifold P such that $i(\partial P)$ is uniformly distributed in $\{0\} \times (-1, 1) \times \{\pm 1\}$. The abstract underlying compact 1-manifold P is sometimes referred as *skeleton* or *pattern* of the tangle (it does not depend on the isotopy class) and will be called here its *skeletization*. One can define operations of composition and of tensor product on tangles. Similar operations can be defined on skeleta, and they are compatible with skeletization. The *Kontsevich integral* is an invariant of parenthesized tangles which associates to such a tangle an element of a complete vector space constructed by glueing Jacobi diagrams to its skeletization, and is compatible with the tangle operations of composition and tensor product. One of its main features is that it is *universal* for both quantum and Vassiliev invariants, in the sense that any quantum invariant (an invariant associated to a semi-simple Lie algebra and one of its finite dimension representations) or any rational-valued Vassiliev invariant, can be recovered from the Kontsevich integral [28, 2, 34, 1, 13, 16, 41, 24].

A skeleton P can be decomposed as the disjoint union of “circle” and “segment” parts: $P = P_{\text{cir}} \sqcup P_{\text{seg}}$, where P_{cir} consists of the connected components of P with empty boundary (homeomorphic to circles) and P_{seg} consists of those connected components with non-empty boundary (homeomorphic to closed intervals). The operations of composition and tensor product on skeleta can be expressed as follows

$$\begin{aligned} (P \circ Q)_{\text{seg}} &= P_{\text{seg}} \circ Q_{\text{seg}}, & (P \circ Q)_{\text{cir}} &= P_{\text{cir}} \sqcup Q_{\text{cir}} \sqcup \text{Cir}(P_{\text{seg}}, Q_{\text{seg}}), \\ (P \otimes Q)_{\text{seg}} &= P_{\text{seg}} \otimes Q_{\text{seg}}, & (P \otimes Q)_{\text{cir}} &= P_{\text{seg}} \sqcup Q_{\text{cir}}, \end{aligned}$$

where in the right-hand sides, \circ and \otimes are operations on skeleta with empty circle parts, and $\text{Cir}(P_{\text{seg}}, Q_{\text{seg}})$ is a finite set of circle components attached to a pair $(P_{\text{seg}}, Q_{\text{seg}})$ of skeleta with empty circle parts.

For each δ in a unital commutative ring R , there is a *Brauer category* $\mathcal{B}(\delta)$, see [36]. Its objects are non-negative integers, and for non-negative integers n and m , the set of morphisms from n to m is the R -module freely generated by the partitions of $\llbracket 1, n \rrbracket \sqcup \llbracket 1, m \rrbracket$ consisting of subsets of cardinality 2. The operations \circ, \otimes and $\text{Cir}(-, -)$ on skeleta with empty circle parts are closely related with $\mathcal{B}(\delta)$. Namely, the set of morphisms in $\mathcal{B}(\delta)$ can be identified with the R -module freely generated by the set of skeleta with empty circle parts, the tensor product in $\mathcal{B}(\delta)$ then coincides with \otimes , and for P and Q skeleta with empty circle parts, the composition \circ_{δ} in $\mathcal{B}(\delta)$ is given by $P \circ_{\delta} Q := \delta^{|\text{Cir}(P, Q)|} P \circ Q$. In particular, $P \circ Q = P \circ_1 Q$, so that the category of skeleta with empty circle parts equipped with (\circ, \otimes) coincides with the category $\mathcal{B}(1)$, which will be denoted $\underline{\mathcal{B}r}$ in the present paper. This relation with $\mathcal{B}(1)$ motivates our treatment of the notion of skeleton, in which the segment and circle parts are given different statuses: the segments of the skeleta will be identified with morphisms in $\underline{\mathcal{B}r}$, while the circle parts will just be viewed as finite sets.

The section is organized as follows. In §1.1 we introduce the category of partitions \underline{Part} and in §1.2 we establish a classification of finite $\mathbb{Z}_2 * \mathbb{Z}_2$ -sets. The definition of the category \underline{Br} of Brauer diagrams and of the operation $\text{Cir} : \underline{Br} \times \underline{Br} \rightarrow \text{Set}_f$ is introduced in §1.3; based on the results of §1.1 and §1.2, we give a proof of the associativity of the composition of \underline{Br} , as well as of cocycle properties of Cir , which are generally understood in the literature. In §1.4, we study various operations on these objects (tensor product, doubling). We introduce the notion of oriented Brauer diagrams in §1.5 and study its operations and properties in §1.6 and §1.7. Finally, in §1.8, we explain how the abstract notions introduced in the section can be encoded in the familiar diagrams.

1.1. A category \underline{Part} of partitions. For a set X we denote by $\mathcal{P}(X)$ its power set, i.e., the set of all subsets of X .

Definition 1.1. Let X be a set, the set $\text{Part}(X)$ of partitions of X is the subset of $\mathcal{P}(X)$ consisting of all A such that

- (a) for all $\xi \in A$, $\xi \neq \emptyset$
- (b) for all $\xi \neq \eta \in A$, $\xi \cap \eta = \emptyset$
- (c) $X = \bigcup_{\xi \in A} \xi$.

The set $\text{Part}(X)$ is endowed with a lattice structure with partial order \leq given by: for $A, B \in \text{Part}(X)$, we say $A \leq B$ if for all $\omega \in A$ there exists $\xi \in B$ such that $\omega \subset \xi$.

For $A, B \in \text{Part}(X)$, the *join* $A \vee B$ of A and B is defined as $\sup\{A, B\}$, i.e., the least partition of X which is greater or equal than A and B .

The join operation is associative, i.e., $(A \vee B) \vee C = A \vee (B \vee C)$.

Definition 1.2. Let X and Y be sets and $f : X \rightarrow Y$ be a map.

- (a) Define a map $f_* : \text{Part}(X) \rightarrow \text{Part}(Y)$ as follows: for $A \in \text{Part}(X)$, f_*A is the least partition of Y such that for all $\omega \in A$ there exists $\xi \in f_*A$ with $f(\omega) \subset \xi$. Explicitly, $y \equiv y' \pmod{f_*A}$ iff $y = y'$ or there exists x_1, \dots, x_{2n+1} in X such that $y = f(x_1)$, $y' = f(x_{2n+1})$ and $x_{2i+1} \equiv x_{2i+2} \pmod{A}$ for $i = 0, \dots, n-1$ and $f(x_{2i}) = f(x_{2i+1})$ for $i = 1, \dots, n$.

Notice that $\{\{y\} \mid y \in Y \setminus f(X)\} \subset f_*A$ for any $A \in \text{Part}(X)$.

When f is injective, we have

$$f_*A = \bigsqcup_{\omega \in A} \{f(\omega)\} \sqcup \bigsqcup_{y \in Y \setminus f(X)} \{\{y\}\},$$

explicitly, $y \equiv y' \pmod{f_*A}$ iff $y = y'$ or there exist $x, x' \in X$ such that $x \equiv x' \pmod{A}$ and $y = fx$, $y' = fx'$.

- (b) Define a map $f^* : \text{Part}(Y) \rightarrow \text{Part}(X)$ as follows: for $B \in \text{Part}(Y)$, f^*B is the least partition of X such that for all $\xi \in B$ there exists $\omega \in f^*B$ with $f^{-1}(\xi) \subset \omega$. Explicitly, $x \equiv x' \pmod{f^*B}$ iff $fx \equiv fx' \pmod{B}$.

If f is injective, then $f^*f_*A = A$. In general, we have $A \subset f^*f_*A$ and $f^*f_*A = A \vee P_f$, where $P_f \in \text{Part}(X)$ is the partition induced by f . For sets X, Y and Z and maps $f : X \rightarrow Y$ and $g : Y \rightarrow Z$ one checks that $(g \circ f)^* = f^* \circ g^*$ and $(g \circ f)_* = g_* \circ f_*$.

Notation 1.3. Let S_1, S_2, \dots, S_n be sets. For $i_1, \dots, i_k \in \llbracket 1, n \rrbracket$ with $i_1 < \dots < i_k$ we denote by $\text{can}_{S_{i_1} \dots S_{i_k}}^{S_1 \dots S_n} : S_{i_1} \sqcup \dots \sqcup S_{i_k} \rightarrow S_1 \sqcup \dots \sqcup S_n$ the canonical inclusion of $S_{i_1} \sqcup \dots \sqcup S_{i_k}$ into $S_1 \sqcup \dots \sqcup S_n$.

Definition 1.4. Let X be a set and $X' \subset X$. For $A \in \text{Part}(X)$ define the set, denoted $A|_{X'}$, and called *restriction of A to X'* , by

$$A|_{X'} := \{a \in A \mid a \subset X'\} \subset A.$$

Notice that in general $A|_{X'}$ is not a partition of X' .

Definition 1.5. Let X, Y and Z be sets.

- (a) Define $\underline{Part}(X, Y) := \text{Part}(X \sqcup Y)$.

(b) Define a composition map

$$\underline{\mathcal{P}art}(X, Y) \times \underline{\mathcal{P}art}(Y, Z) \rightarrow \underline{\mathcal{P}art}(X, Z),$$

by

$$(A, B) \mapsto B \circ A := (\text{can}_{XZ}^{XYZ})^* \left((\text{can}_{XY}^{XYZ})_*(A) \vee (\text{can}_{YZ}^{XYZ})_*(B) \right).$$

(c) For $A \in \underline{\mathcal{P}art}(X, Y)$ and $B \in \underline{\mathcal{P}art}(Y, Z)$, define the set $\text{Cir}(B, A)$ by

$$\text{Cir}(B, A) := \left((\text{can}_{XY}^{XYZ})_*(A) \vee (\text{can}_{YZ}^{XYZ})_*(B) \right)_{|Y}.$$

Lemma 1.6. *Let X and Y be sets and $Y' \subset Y$. Then for any $U \in \text{Part}(X \sqcup Y)$ there is a bijection $((\text{can}_Y^{XY})^*(U))_{|Y'} \simeq U_{|X \sqcup Y'} \setminus U_{|X}$.*

Proof. By definition we have

$$(1.1) \quad ((\text{can}_Y^{XY})^*(U))_{|Y'} = \{b \in \mathcal{P}(Y) \mid \emptyset \neq b \subset Y' \text{ and } \exists a \in U \text{ such that } b = a \cap Y \text{ and } b \subset Y'\}.$$

Besides,

$$\begin{aligned} U_{|X \sqcup Y'} &= \{a \in U \mid a \subset X \sqcup Y'\} \\ &= \{a \in U \mid a \subset X\} \sqcup \{a \in U \mid a \subset X \sqcup Y' \text{ and } a \cap Y' \neq \emptyset\} \\ &= (U_{|X}) \sqcup \{a \in U \mid a \subset X \sqcup Y' \text{ and } a \cap Y' \neq \emptyset\}. \end{aligned}$$

Therefore,

$$(1.2) \quad U_{|X \sqcup Y'} \setminus U_{|X} = \{a \in U \mid a \subset X \sqcup Y' \text{ and } a \cap Y' \neq \emptyset\}.$$

Define $\varphi : (U_{|X \sqcup Y'} \setminus U_{|X}) \rightarrow ((\text{can}_Y^{XY})^*(U))_{|Y'}$, by $\varphi(a) := a \cap Y$ for any $a \in U_{|X \sqcup Y'} \setminus U_{|X}$.

Let us show that φ is well-defined. If $a \in (U_{|X \sqcup Y'} \setminus U_{|X})$, then $\varphi(a) = a \cap Y \in \mathcal{P}(Y)$. Moreover, $\varphi(a) \supset a \cap Y' \neq \emptyset$ by (1.2). Therefore $\varphi(a) \neq \emptyset$. Also $\varphi(a) = a \cap Y \subset Y'$ since $a \subset X \sqcup Y'$ (see (1.2)). Finally, $\varphi(a) = a \cap Y$ with $a \in U$. All this implies that $\varphi(a) \in ((\text{can}_Y^{XY})^*(U))_{|Y'}$. Besides, if $b \in ((\text{can}_Y^{XY})^*(U))_{|Y'}$, then by (1.1), there exists $a \in U$ with $b = a \cap Y$. Let us show that $a \in (U_{|X \sqcup Y'} \setminus U_{|X})$. By assumption on b , one has $b \subset Y'$, which together with $b = a \cap Y$ implies $a \subset X \sqcup Y'$. Moreover, the same facts imply $b = a \cap Y'$; since $b \neq \emptyset$ by (1.1), then $a \cap Y' \neq \emptyset$. It follows that $a \in (U_{|X \sqcup Y'} \setminus U_{|X})$, therefore $b = a \cap Y = \varphi(a)$, i.e., φ is surjective. Finally, if $a, a' \in U_{|X \sqcup Y'} \setminus U_{|X}$ are such that $\varphi(a) = \varphi(a')$, then $\emptyset \neq \varphi(a) = \varphi(a') \subset a \cap a'$. As U is a partition, this implies $a = a'$, i.e., φ is injective. \square

Lemma 1.7. *Let X, Y, Z and T be sets. Then for any $U \in \text{Part}(X \sqcup Y \sqcup Z)$ and any $V \in \text{Part}(Z \sqcup T)$ we have*

$$(\text{can}_{XZ}^{XZT})^* \left((\text{can}_{XZ}^{XYZ})^*(U) \right) \vee (\text{can}_{ZT}^{XZT})^*(V) = (\text{can}_{XZT}^{XYZT})^* \left((\text{can}_{XYZ}^{XYZT})^*(U) \vee (\text{can}_{ZT}^{XYZT})^*(V) \right).$$

Proof. In general, for any set W and any $U' \in \text{Part}(W \sqcup Z)$ and $V \in \text{Part}(Z \sqcup T)$ the partition $(\text{can}_{WZ}^{WZT})^*(U') \vee (\text{can}_{ZT}^{WZT})^*(V) \in \text{Part}(W \sqcup Z \sqcup T)$ can be described explicitly as follows. Let $\sim_{U'}$ (resp. \sim_V) denote the equivalence relation on $W \sqcup Z$ (resp. $Z \sqcup T$) induced by the partition U' (resp. V). Define a relation \sim on $W \sqcup Z \sqcup T$ by:

- if $w, w' \in W$, then $w \sim w'$ if and only if there exist $n \geq 0$ and $z_1, \dots, z_{2n} \in Z$ such that $w \sim_{U'} z_1 \sim_V z_2 \sim_{U'} \dots \sim_V z_{2n} \sim_{U'} w'$,
- if $z, z' \in Z$, then $z \sim z'$ if and only if there exist $n \geq 0$ and $z_1, \dots, z_{2n} \in Z$ such that $z \sim_{U'} z_1 \sim_V z_2 \sim_{U'} \dots \sim_V z_{2n} \sim_{U'} z'$,
- if $t, t' \in T$, then $t \sim t'$ if and only if there exist $n \geq 0$ and $z_1, \dots, z_{2n} \in Z$ such that $t \sim_V z_1 \sim_{U'} z_2 \sim_V \dots \sim_{U'} z_{2n} \sim_V t'$,
- if $w \in W, z \in Z$, then $w \sim z$ if and only if there exist $n \geq 0$ and $z_1, \dots, z_{2n+1} \in Z$ such that $w \sim_{U'} z_1 \sim_V z_2 \sim_{U'} \dots \sim_{U'} z_{2n+1} \sim_V z$,
- if $w \in W, t \in T$, then $w \sim t$ if and only if there exist $n \geq 0$ and $z_1, \dots, z_{2n+1} \in Z$ such that $w \sim_{U'} z_1 \sim_V z_2 \sim_{U'} \dots \sim_{U'} z_{2n+1} \sim_V t$,

- if $z \in Z$, $t \in T$, then $t \sim z$ if and only if there exist $n \geq 0$ and $z_1, \dots, z_{2n+1} \in Z$ such that $t \sim_V z_1 \sim_{U'} z_2 \sim_V \dots \sim_V z_{2n+1} \sim_{U'} z$.

One checks that \sim is an equivalence relation. Let $P \in \text{Part}(W \sqcup Z \sqcup T)$ be the partition associated to \sim . We have $(\text{can}_{WZ}^{WZT})_*(U') \leq P$ and $(\text{can}_{ZT}^{WZT})_*(V) \leq P$. One also checks that $P \leq (\text{can}_{WZ}^{WZT})_*(U') \vee (\text{can}_{ZT}^{WZT})_*(V) \in \text{Part}(W \sqcup Z \sqcup T)$ and therefore $P = (\text{can}_{WZ}^{WZT})_*(U') \vee (\text{can}_{ZT}^{WZT})_*(V) \in \text{Part}(W \sqcup Z \sqcup T)$.

Let us come back to our particular case ($W := X \sqcup Y$). Notice that $a, a' \in X \sqcup Z$ are such that $a \sim_{(\text{can}_{XZ}^{XYZ})_*(U)} a'$ if and only if $a \sim_U a'$ we then see that the explicit description of both sides of the equality in the statement of the lemma is the same. \square

Proposition 1.8. *Let X, Y, Z and T be sets. Let $A \in \underline{\text{Part}}(X, Y)$, $B \in \underline{\text{Part}}(Y, Z)$, $C \in \underline{\text{Part}}(Z, T)$. Then $C \circ (B \circ A) = (C \circ B) \circ A$. In particular, $(\underline{\text{Part}}, \circ)$ is a category, we call it category of partitions.*

Proof. We show that both $C \circ (B \circ A)$ and $(C \circ B) \circ A$ can be expressed as

$$(1.3) \quad (\text{can}_{XT}^{XYZT})_* \left[(\text{can}_{XY}^{XYZT})_*(A) \vee (\text{can}_{YZ}^{XYZT})_*(B) \vee (\text{can}_{ZT}^{XYZT})_*(C) \right].$$

We have

$$(1.4) \quad \begin{aligned} C \circ (B \circ A) &= (\text{can}_{XT}^{XZT})_* \left((\text{can}_{XZ}^{XZT})_*(B \circ A) \vee (\text{can}_{ZT}^{XZT})_*(C) \right) \\ &= (\text{can}_{XT}^{XZT})_* \left[(\text{can}_{XZ}^{XZT})_* \left((\text{can}_{XZ}^{XYZ})_* \left((\text{can}_{XY}^{XYZ})_*(A) \vee (\text{can}_{YZ}^{XYZ})_*(B) \right) \right) \right. \\ &\quad \left. \vee (\text{can}_{ZT}^{XZT})_*(C) \right], \end{aligned}$$

where the first equality is by the definition by of $C \circ (B \circ A)$ and the second one by the definition of $B \circ A$.

Besides, (1.3) can be expressed as

$$(1.5) \quad \begin{aligned} &(\text{can}_{XT}^{XYZT})_* \left[(\text{can}_{XY}^{XYZT})_*(A) \vee (\text{can}_{YZ}^{XYZT})_*(B) \vee (\text{can}_{ZT}^{XYZT})_*(C) \right] \\ &= (\text{can}_{XT}^{XYZT})_* \left[(\text{can}_{XYZ}^{XYZT})_* \left((\text{can}_{XY}^{XYZ})_*(A) \vee (\text{can}_{YZ}^{XYZ})_*(B) \right) \vee (\text{can}_{ZT}^{XYZT})_*(C) \right] \\ &= \left((\text{can}_{XT}^{XZT})_* \circ (\text{can}_{XZT}^{XYZT})_* \right) \left[(\text{can}_{XYZ}^{XYZT})_* \left((\text{can}_{XY}^{XYZ})_*(A) \vee (\text{can}_{YZ}^{XYZ})_*(B) \right) \right. \\ &\quad \left. \vee (\text{can}_{ZT}^{XYZT})_*(C) \right]. \end{aligned}$$

In the first equality we have used the identities $\text{can}_{XY}^{XYZT} = \text{can}_{XYZ}^{XYZT} \circ \text{can}_{XY}^{XYZ}$ and $\text{can}_{YZ}^{XYZT} = \text{can}_{XYZ}^{XYZT} \circ \text{can}_{YZ}^{XYZ}$ and the fact that $(\text{can}_{XYZ}^{XYZT})_*$ is join-preserving. In the second equality we have used the identity $\text{can}_{XT}^{XYZT} = \text{can}_{XZT}^{XYZT} \circ \text{can}_{XT}^{XZT}$.

Applying $(\text{can}_{XT}^{XZT})_*$ to equality in Lemma 1.7 with $U := (\text{can}_{XY}^{XYZ})_*(A) \vee (\text{can}_{YZ}^{XYZ})_*(B)$ and $V := C$ we obtain that the last term in (1.4) is equal to the last term in (1.5). That is, $C \circ (B \circ A)$ can be expressed as in (1.3). A similar reasoning allows us to show that $(C \circ B) \circ A$ is also expressed as in (1.3). Therefore $C \circ (B \circ A) = (C \circ B) \circ A$. \square

Lemma 1.9. *Let X, Y, Z and T be sets. Let $U \in \text{Part}(X \sqcup Y \sqcup Z)$ and $C \in \text{Part}(Z \sqcup T)$. Then*

- the assignment $\psi : U|_Y \rightarrow (\text{can}_{XYZ}^{XYZT})_*(U) \vee (\text{can}_{ZT}^{XYZT})_*(C)$ taking $a \in U|_Y$ to the unique class of $(\text{can}_{XYZ}^{XYZT})_*(U) \vee (\text{can}_{ZT}^{XYZT})_*(C)$ containing $\text{can}_{XYZ}^{XYZT}(a)$, denoted \tilde{a} , is well-defined and takes values in $\left((\text{can}_{XYZ}^{XYZT})_*(U) \vee (\text{can}_{ZT}^{XYZT})_*(C) \right)|_Y$,*
- the induced map*

$$\psi : U|_Y \longrightarrow \left((\text{can}_{XYZ}^{XYZT})_*(U) \vee (\text{can}_{ZT}^{XYZT})_*(C) \right)|_Y$$

by (a) is a bijection.

Proof. Let denote by \sim_P , \sim_U and \sim_C the equivalence relations on $X \sqcup Y \sqcup Z \sqcup T$, on $X \sqcup Y \sqcup Z$ and on $Z \sqcup T$ induced by $P := (\text{can}_{XYZ}^{XYZT})_*(U) \vee (\text{can}_{ZT}^{XYZT})_*(C)$, by U and by C , respectively. We also recall from the proof of Lemma 1.7 that (taking $W := X \sqcup Y$) there is an explicit description of \sim_P .

(a) If $a \in U|_Y$ then $\text{can}_{XYZ}^{XYZT}(a) \subset X \sqcup Y \sqcup Z \sqcup T$. Moreover, $\text{can}_{XYZ}^{XYZT}(a)$ is an equivalence class of $(\text{can}_{XYZ}^{XYZT})_*(U)$ and therefore there exists a unique class \tilde{a} in $(\text{can}_{XYZ}^{XYZT})_*(U) \vee (\text{can}_{ZT}^{XYZT})_*(C)$ containing $\text{can}_{XYZ}^{XYZT}(a)$. Let us show that $\tilde{a} \subset Y$, i.e., $\tilde{a} \in \left((\text{can}_{XYZ}^{XYZT})_*(U) \vee (\text{can}_{ZT}^{XYZT})_*(C) \right)_{|Y}$. Assuming the contrary and using the explicit description of \sim_P we have:

- If there exists $\tilde{\alpha} \in \tilde{a} \cap X$, then for every $\alpha \in a$ we have $\alpha \sim_P \tilde{\alpha}$. Hence, $\alpha \sim_U \tilde{\alpha}$. That is, $a \cap X \neq \emptyset$ which contradicts $a \in U|_Y$.
- If there exists $\tilde{\alpha} \in \tilde{a} \cap Z$, then for every $\alpha \in a$ we have $\alpha \sim_P \tilde{\alpha}$. Therefore, there exists $n \geq 0$ and $z_1, \dots, z_{2n} \in Z$ such that $\alpha \sim_U z_1 \sim_C z_2 \sim_U \dots \sim_C z_{2n} \sim_U \tilde{\alpha}$. Hence, $\tilde{\alpha}$ or z_1 belong to $a \cap Z$ which contradicts $a \in U|_Y$.
- If there exists $\tilde{\alpha} \in \tilde{a} \cap T$, then for every $\alpha \in a$ we have $\alpha \sim_P \tilde{\alpha}$. Therefore, there exists $n \geq 0$ and $z_1, \dots, z_{2n+1} \in Z$ such that $\alpha \sim_U z_1 \sim_C z_2 \sim_U \dots \sim_U z_{2n+1} \sim_C \tilde{\alpha}$. Hence, $z_1 \in a \cap Z$ which contradicts $a \in U|_Y$.

To sum up, $\tilde{a} \subset Y$.

(b) If $a \in P|_Y$, then $a \in P$ and $a \subset Y$. Since $(\text{can}_{XYZ}^{XYZT})_*(U) \leq P$, there exists $A' \subset U$ such that $a = \sqcup_{a' \in A'} a'$. Moreover, for all $a' \in A'$ we have $a' \subset Y$. Hence, $A' \subset U|_Y$.

Let $a', a'' \in A'$, then for all $\alpha' \in a' \subset Y$ and for all $\alpha'' \in a'' \subset Y$ we have $\alpha' \sim_P \alpha''$. By the explicit description of \sim_P we then have $\alpha' \sim_U \alpha''$ or there exists $n \geq 0$ and $z_1, \dots, z_{2n} \in Z$ such that $\alpha' \sim_U z_1 \sim_C z_2 \sim_U \dots \sim_C z_{2n} \sim_U \alpha''$. The latter case is discarded because it contradicts $a' \subset Y$. We conclude $a' = a''$, therefore $a \in U|_Y$ and $A' = \{a\}$; then $\psi(a) = a$ which shows the surjectivity of ψ . The same argument shows that $\psi(a) = \text{can}_{XYZ}^{XYZT}(a)$ which using the injectivity of can_{XYZ}^{XYZT} implies the injectivity of ψ . \square

Proposition 1.10. *Let X, Y, Z and T be sets. Let $A \in \underline{\text{Part}}(X, Y)$, $B \in \underline{\text{Part}}(Y, Z)$, $C \in \underline{\text{Part}}(Z, T)$. Then there is a bijection*

$$\text{bij}_{C,B,A} : \text{Cir}(C, B) \sqcup \text{Cir}(C \circ B, A) \longrightarrow \text{Cir}(B, A) \sqcup \text{Cir}(C, B \circ A).$$

Proof. Let $\Upsilon := (\text{can}_{XY}^{XYZT})_*(A) \vee (\text{can}_{YZ}^{XYZT})_*(B) \vee (\text{can}_{ZT}^{XYZT})_*(C) \in \text{Part}(X \sqcup Y \sqcup Z \sqcup T)$. Using the equalities $(\text{can}_{XY}^{XYZT})_* = (\text{can}_{XYZ}^{XYZT} \circ \text{can}_{XY}^{XYZ})_* = (\text{can}_{XYZ}^{XYZT})_* \circ (\text{can}_{XY}^{XYZ})_*$ and $(\text{can}_{YZ}^{XYZT})_* = (\text{can}_{XYZ}^{XYZT} \circ \text{can}_{YZ}^{XYZ})_* = (\text{can}_{XYZ}^{XYZT})_* \circ (\text{can}_{YZ}^{XYZ})_*$ together with Lemma 1.9 (with $U := (\text{can}_{XY}^{XYZ})_*(A) \vee (\text{can}_{YZ}^{XYZ})_*(B)$) we have

$$\begin{aligned} \text{Cir}(B, A) &= U|_Y \simeq \left[(\text{can}_{XYZ}^{XYZT})_*(U) \vee \text{can}_{ZT}^{XYZT}(C) \right]_{|Y} \\ (1.6) \quad &= \left[(\text{can}_{XYZ}^{XYZT})_* \left((\text{can}_{XY}^{XYZ})_*(A) \vee (\text{can}_{YZ}^{XYZ})_*(B) \right) \vee (\text{can}_{ZT}^{XYZT})_*(C) \right]_{|Y} \\ &= \left[(\text{can}_{XY}^{XYZT})_*(A) \vee (\text{can}_{YZ}^{XYZT})_*(B) \vee (\text{can}_{ZT}^{XYZT})_*(C) \right]_{|Y} \\ &= \Upsilon|_Y. \end{aligned}$$

Besides, notice that for any $V \in \text{Part}(X \sqcup Y \sqcup Z)$ we have

$$\begin{aligned} (1.7) \quad &\left((\text{can}_{XYZ}^{XYZT})_*(V) \vee (\text{can}_{ZT}^{XYZT})_*(C) \right)_{Y \sqcup Z} \setminus \left((\text{can}_{XYZ}^{XYZT})_*(V) \vee (\text{can}_{ZT}^{XYZT})_*(C) \right)_Y \\ &\simeq \left[(\text{can}_{XZT}^{XYZT})_* \left((\text{can}_{XYZ}^{XYZT})_*(V) \vee (\text{can}_{ZT}^{XYZT})_*(C) \right) \right]_{|Z} \\ &= \left[(\text{can}_{XZ}^{XZT})_* \left((\text{can}_{XZ}^{XYZ})_*(V) \right) \vee (\text{can}_{ZT}^{XZT})_*(C) \right]_{|Z} \end{aligned}$$

where the isomorphism is given by Lemma 1.6 and the equality is given by Lemma 1.7.

Considering the instance of (1.7) with $V := (\text{can}_{XY}^{XYZ})_*(A) \vee (\text{can}_{YZ}^{XYZ})_*(B)$ and using the equalities $(\text{can}_{XY}^{XYZT})_* = (\text{can}_{XYZ}^{XYZT} \circ \text{can}_{XY}^{XYZ})_* = (\text{can}_{XYZ}^{XYZT})_* \circ (\text{can}_{XY}^{XYZ})_*$ and $(\text{can}_{YZ}^{XYZT})_* = (\text{can}_{XYZ}^{XYZT} \circ \text{can}_{YZ}^{XYZ})_* = (\text{can}_{XYZ}^{XYZT})_* \circ (\text{can}_{YZ}^{XYZ})_*$

$\text{can}_{YZ}^{XYZ})* = (\text{can}_{XYZ}^{XYZT})* \circ (\text{can}_{YZ}^{XYZ})*$ we obtain

$$\begin{aligned} \Upsilon_{|Y \sqcup Z} \setminus \Upsilon_{|Y} &\simeq \left[(\text{can}_{XZ}^{XZT})* \left((\text{can}_{XZ}^{XYZ})* \left((\text{can}_{XY}^{XYZ})* (A) \vee (\text{can}_{YZ}^{XYZ})* (B) \right) \right) \vee (\text{can}_{ZT}^{XZT})* (C) \right]_{|Z} \\ &= \left[(\text{can}_{XZ}^{XZT})* (B \circ A) \vee (\text{can}_{ZT}^{XZT})* (C) \right]_{|Z} \\ &= \text{Cir}(C, B \circ A). \end{aligned}$$

Combining the above isomorphism with that in (1.6) we get

$$\Upsilon_{|Y \sqcup Z} \simeq \text{Cir}(B, A) \sqcup \text{Cir}(C, B \circ A).$$

Similarly, we show

$$\Upsilon_{|Y \sqcup Z} \simeq \text{Cir}(C, B) \sqcup \text{Cir}(C \circ B, A),$$

which finishes the proof. \square

Remark 1.11. By using similar arguments to the ones used in the proof of Proposition 1.10, we can show that for any composable objects A, B, C, D in $\mathcal{P}art$ the diagram

$$\begin{array}{ccc} & \text{Cir}(C, B) \sqcup \text{Cir}(D, (CB)) \sqcup \text{Cir}(D(CB), A) & \\ & \nearrow \text{bij}_{D,C,B} \sqcup \text{Id}_{\text{Cir}((DC)B,A)} & \\ \text{Cir}(D, C) \sqcup \text{Cir}(DC, B) \sqcup \text{Cir}((DC)B, A) & & \text{Id}_{\text{Cir}(C,B)} \sqcup \text{bij}_{D,CB,A} \\ & \searrow & \\ & \text{Cir}(C, B) \sqcup \text{Cir}(CB, A) \sqcup \text{Cir}(D, (CB)A) & \\ \text{Id}_{\text{Cir}(D,C)} \sqcup \text{bij}_{DC,B,A} & & \\ \text{Cir}(D, C) \sqcup \text{Cir}(B, A) \sqcup \text{Cir}(DC, BA) & & \\ & \nearrow \text{bij}_{C,B,A} \sqcup \text{Id}_{\text{Cir}(D,(CB)A)} & \\ (\text{Id}_{\text{Cir}(B,A)} \sqcup \text{bij}_{D,C,BA}) \circ t & & \\ & \searrow & \\ & \text{Cir}(B, A) \sqcup \text{Cir}(C, BA) \sqcup \text{Cir}(D, C(BA)) & \end{array}$$

commutes, where $t := t_{(\text{Cir}(D,C), \text{Cir}(B,A))} \sqcup \text{Id}_{\text{Cir}(DC,BA)} : \text{Cir}(D, C) \sqcup \text{Cir}(B, A) \rightarrow \text{Cir}(B, A) \sqcup \text{Cir}(D, C)$ is the canonical bijection. By simplicity we have omitted \circ from the notation in the above diagram.

Remark 1.12. In [18], Deligne introduces a $\mathbb{Z}[T]$ -linear tensor category $\text{Rep}_1(S_T)$ with a particular object X . For U and V finite sets, $\text{Rep}_1(S_T)(X^{\otimes U}, X^{\otimes V})$ is a free $\mathbb{Z}[T]$ -module with basis $([P])_{P \in \text{Part}(U \sqcup V)}$ ([18, §8.2]). For U, V and W finite sets and $P \in \text{Part}(U \sqcup V)$ and $Q \in \text{Part}(V \sqcup W)$, one has $[Q] \circ [P] = T^{|\text{Cir}(P,Q)|} \langle Q \circ P \rangle_{U \sqcup W}$, where $\langle Q \circ P \rangle_{U \sqcup W}$ coincides with the partition $P \circ Q$ defined in Definition 1.5(b). The associativity of the composition in $\text{Rep}_1(S_T)$ is equivalent to the equalities $(R \circ Q) \circ P = R \circ (Q \circ P)$ (see Proposition 1.8) and $|\text{Cir}(RQ, P)| + |\text{Cir}(R, Q)| = |\text{Cir}(R, QP)| + |\text{Cir}(Q, P)|$ (which is a consequence of Proposition 1.10). See also [17] for more details on the category $\text{Rep}_1(S_T)$.

1.2. Classification of finite $\mathbb{Z}_2 * \mathbb{Z}_2$ -sets.

Notation 1.13. Let X_1, \dots, X_n be sets. The image of $x \in X_i$ under the injection $X_i \subset X_1 \sqcup \dots \sqcup X_n$, i.e., under the map $\text{can}_{X_i}^{X_1 \dots X_n} : X_i \rightarrow X_1 \sqcup \dots \sqcup X_n$ (see Notation 1.3), is denoted by using $i-1$ bars over x . For instance $X_1 \ni x \mapsto x \in X_1 \sqcup X_2 \sqcup X_3$ and $X_2 \ni x \mapsto \bar{x} \in X_1 \sqcup X_2 \sqcup X_3$ and $X_3 \ni x \mapsto \bar{\bar{x}} \in X_1 \sqcup X_2 \sqcup X_3$

Consider the group $G := \mathbb{Z} \rtimes \mathbb{Z}_2 = \langle t, c \mid c^2 = 1, ct = t^{-1}c \rangle$. For $N \in \mathbb{Z}_{\geq 1}$ define the cofinite subgroups A_N , B_N and C_N of $\mathbb{Z} \rtimes \mathbb{Z}_2$ generated by $\{t^N\}$, $\{t^N, c\}$ and $\{t^N, ct\}$, respectively.

Lemma 1.14. *Define the map*

$$F : \mathbb{Z}_{\geq 1} \sqcup (2\mathbb{Z}_{\geq 0} + 1) \sqcup (2\mathbb{Z}_{\geq 0} \times \{0, 1\}) \longrightarrow \{\text{cofinite subgroups of } G\}$$

by $F(N) := A_N$, $F(\overline{2N+1}) := B_{2N+1}$, $F(\overline{(2N, 0)}) := B_{2N}$ and $F(\overline{(2N, 1)}) := C_{2N}$. Then F induces a bijection

$$[F] : \mathbb{Z}_{\geq 1} \sqcup (2\mathbb{Z}_{\geq 0} + 1) \sqcup (2\mathbb{Z}_{\geq 0} \times \{0, 1\}) \longrightarrow \frac{\{\text{cofinite subgroups of } G\}}{\text{conjugation}}.$$

Proof. For $x \in (2\mathbb{Z}_{\geq 0} + 1) \sqcup (2\mathbb{Z}_{\geq 0} \times \{0, 1\})$ we set $|x| := x$ if $x \in 2\mathbb{Z}_{\geq 0} + 1$ and $|x| := y$ if $x = (y, \epsilon) \in 2\mathbb{Z}_{\geq 0} \times \{0, 1\}$.

Let us first show the injectivity of $[F]$. Let $z, z' \in \mathbb{Z}_{\geq 1} \sqcup (2\mathbb{Z}_{\geq 0} + 1) \sqcup (2\mathbb{Z}_{\geq 0} \times \{0, 1\})$ such that $[F]z = [F]z'$. Then $\text{Im}(F(z) \subset G \rightarrow \mathbb{Z}_2) = \text{Im}(F(z') \subset G \rightarrow \mathbb{Z}_2)$ is equal to \mathbb{Z}_2 or $\{0\}$. In the first case, $z, z' \in \mathbb{Z}_{\geq 0}$ and so $2z = |G/F(z)| = |G/F(z')| = 2z'$. Consequently, $z = z'$. In the second case, $z, z' \in (2\mathbb{Z}_{\geq 0} + 1) \sqcup (2\mathbb{Z}_{\geq 0} \times \{0, 1\})$ and we have $|z| = |G/F(z)| = |G/F(z')| = |z'|$. Therefore, $z = z'$ or there exists $N \in \mathbb{Z}_{\geq 0}$ with $z = (2N, 0)$ and $z' = (2N, 1)$. We claim that the latter option is not possible. Indeed, we have $F(2N, 0) \cap \{t^k c \mid k \in \mathbb{Z}\} = B_{2N} \cap \{t^k c \mid k \in \mathbb{Z}\} \subset \{t^k c \mid k \in 2\mathbb{Z}\}$. Besides, for any $g \in G$ we have $(gF(2N, 1)g^{-1}) \cap \{t^k c \mid k \in \mathbb{Z}\} = (gC_{2N}g^{-1}) \cap \{t^k c \mid k \in \mathbb{Z}\} \subset \{t^k c \mid k \in 2\mathbb{Z} + 1\}$. In consequence, $[F](2N, 0) \neq [F](2N, 1)$. We then conclude that $z = z'$, i.e., $[F]$ is injective.

We proceed to show the surjectivity of $[F]$. Let H be a cofinite subgroup of G . Suppose that $\text{Im}(H \subset G \rightarrow \mathbb{Z}_2) = \{0\}$, then $H \leq \ker(G \rightarrow \mathbb{Z}_2) = \mathbb{Z}$ and the map $\mathbb{Z}/H \rightarrow G/H$ is injective. Hence, H is a cofinite subgroup of \mathbb{Z} , i.e., there exists $N \in \mathbb{Z}_{\geq 1}$ such that $H = \langle t^N \rangle = A_N = F(N)$.

Suppose now that $\text{Im}(H \subset G \rightarrow \mathbb{Z}_2) = \mathbb{Z}_2$. The map $\mathbb{Z}/H \cap \mathbb{Z} \rightarrow G/H$ is injective and therefore $H \cap \mathbb{Z}$ is a cofinite subgroup of \mathbb{Z} , i.e., there exists $M \in \mathbb{Z}_{\geq 1}$ such that $H \cap \mathbb{Z} = \langle t^M \rangle$. Besides, the group $\langle t^k c \mid k \in \mathbb{Z} \rangle$ is endowed with a free and transitive action of $\langle t \rangle = \mathbb{Z}$ which induces a free and transitive action of $H \cap \mathbb{Z}$ on $H \cap \langle t^k c \mid k \in \mathbb{Z} \rangle$. Therefore, there exists $a \in \mathbb{Z}$ such that $H \cap \langle t^k c \mid k \in \mathbb{Z} \rangle = \{t^{a+lM} c \mid l \in \mathbb{Z}\}$. Hence, $H = \{t^{lM} \mid l \in \mathbb{Z}\} \sqcup \{t^{a+lM} c \mid l \in \mathbb{Z}\}$. We have the following possibilities:

- (a) the integers M and a are both even. Let $b \in \mathbb{Z}$ such that $a = 2b$, then $H = t^b B_M t^{-b}$, i.e., $[H] = [F](\overline{(M, 0)})$.
- (b) the integer M is even and a is odd. Let $b \in \mathbb{Z}$ such that $a = 2b + 1$, then $H = t^b C_M t^{-b}$, i.e., $[H] = [F](\overline{(M, 1)})$.
- (c) the integer M is odd. Then $H = t^d C_M t^{-db}$, where $d = a/2$ if a is even and $d = (a + M)/2$ if a is odd. We then have $[H] = [F](\overline{M})$.

□

Proposition 1.15. *Let $\tilde{G} := \mathbb{Z}_2 * \mathbb{Z}_2 = \langle \alpha, \beta \mid \alpha^2 = \beta^2 = 1 \rangle$. Let X be a finite \tilde{G} -set and for $\gamma \in \{\alpha, \beta\}$ define $X^\gamma := \{x \in X \mid \gamma x = x\}$. Then $(|X^\alpha|, |X^\beta|) \in \{(0, 0), (2, 0), (1, 1), (0, 2)\}$ and therefore $|X^\alpha| + |X^\beta| \in \{0, 2\}$.*

Proof. We use the isomorphism $\tilde{G} \simeq G = \mathbb{Z} \rtimes \mathbb{Z}_2 = \langle t, c \mid c^2 = 1, ct = t^{-1}c \rangle$ given by $\alpha\beta \leftrightarrow t$ and $\beta \leftrightarrow c$. Besides, recall that there is a bijection

$$\frac{\{\text{finite } G\text{-sets}\}}{\text{isomorphism}} \simeq \frac{\{\text{cofinite subgroups of } G\}}{\text{conjugation}}.$$

By Lemma 1.14 the cofinite subgroups of G are classified in the three families A_N , B_N and C_N . Let us consider case by case. If $X = G/A_N$, then $X = \{\bar{1}, \bar{t}, \dots, \overline{t^{N-1}}\} \sqcup \{\bar{c}, \bar{ct}, \dots, \overline{ct^{N-1}}\}$ and c acts on X by $c \cdot \bar{t}^m = \overline{ct^m}$ and $c \cdot \overline{ct^m} = \bar{t}^m$. Hence, $X^c = \emptyset$. Similarly, tc acts on X by $tc \cdot \bar{t}^m = \overline{ct^{m-1}}$ and $tc \cdot \overline{ct^m} = \bar{t}^{m-1}$. Hence, $X^{tc} = \emptyset$. Therefore, $(|X^\alpha|, |X^\beta|) = (|X^{tc}|, |X^c|) = (0, 0)$.

If $X = G/B_N$, then $X = \{\bar{1}, \bar{t}, \dots, \overline{t^{N-1}}\}$ and c acts on X by $c \cdot \bar{t}^m = \overline{t^{-m}}$. Hence, $X^\beta \simeq X^c \simeq \{x \in \mathbb{Z}_N \mid 2x = 0\}$. Similarly, tc acts on X by $tc \cdot \bar{t}^m = \overline{t^{-m+1}}$. Hence, $X^\alpha \simeq X^{tc} \simeq \{x \in \mathbb{Z}_N \mid 2x = 1\}$. Then, if N is even we have $(|X^\alpha|, |X^\beta|) = (0, 2)$ and if N is odd we have $(|X^\alpha|, |X^\beta|) = (1, 1)$.

Finally, if $X = G/C_N$, then $X = \{\bar{1}, \bar{t}, \dots, \overline{t^{N-1}}, \bar{c}\}$ and c acts on X by $c \cdot \bar{c} = \bar{1}$ and $c \cdot \bar{t}^m = \overline{t^{1-m}}$. Hence, $X^\beta \simeq X^c \simeq \{x \in \mathbb{Z}_N \mid 2x = 1\}$. Similarly, tc acts on X by $tc \cdot \bar{c} = \bar{t}$, and $tc \cdot \bar{t}^m = \overline{t^{2-m}}$. Hence, $X^\alpha \simeq X^{tc} \simeq \{x \in \mathbb{Z}_N \mid 2(m-1) = 0\}$. Then, if N is even we have $(|X^\alpha|, |X^\beta|) = (2, 0)$ and if N is odd we have $(|X^\alpha|, |X^\beta|) = (1, 1)$. \square

1.3. The category $\underline{\mathcal{B}r}$ of Brauer diagrams.

Definition 1.16. Let X, Y be sets. Define the set $\underline{\mathcal{B}r}'(X, Y) \subset \underline{\mathcal{P}art}(X, Y)$ to be the subset of $\underline{\mathcal{P}art}(X, Y) = \text{Part}(X \sqcup Y)$ consisting of the partitions where all the constituents are of cardinality 2.

For a finite set X we denote by $\text{FPFI}(X)$ the set of fixed-point free involutions of X . Therefore, by definition, we have a bijection $\underline{\mathcal{B}r}'(X, Y) \simeq \text{FPFI}(X \sqcup Y)$. For $A \in \underline{\mathcal{B}r}'(X, Y)$, we denote by σ_A the corresponding element in $\text{FPFI}(X \sqcup Y)$.

Definition 1.17. Let X and Y be sets. For any pair of permutations $\sigma \in \mathfrak{S}_X$ and $\tau \in \mathfrak{S}_Y$ we define their *concatenation* $\sigma * \tau \in \mathfrak{S}_{X \sqcup Y}$ by $\sigma * \tau(a) := \sigma(a)$ if $a \in X$ and $\sigma * \tau(\bar{a}) := \tau(\bar{a})$ if $a \in Y$. Here we use Notation 1.13.

Theorem 1.18. Let X, Y , and Z be sets. If $A \in \underline{\mathcal{B}r}'(X, Y) \subset \underline{\mathcal{P}art}(X, Y)$ and $B \in \underline{\mathcal{B}r}'(Y, Z) \subset \underline{\mathcal{P}art}(X, Z)$ then the element $B \circ A \in \underline{\mathcal{P}art}(X, Z)$ belongs to $\underline{\mathcal{B}r}'(X, Z)$.

Proof. Let $A \in \underline{\mathcal{B}r}'(X, Y)$ and $B \in \underline{\mathcal{B}r}'(Y, Z)$. Let $\alpha := \sigma_A * \text{Id}_Z \in \mathfrak{S}_{X \sqcup Y \sqcup Z}$ and $\beta := \text{Id}_X * \sigma_B \in \mathfrak{S}_{X \sqcup Y \sqcup Z}$, where σ_A and σ_B are as indicated before Definition 1.17. By definition, we have

$$\frac{X \sqcup Y \sqcup Z}{\langle \alpha, \beta \rangle} = (\text{can}_{XY}^{XYZ})_*(A) \vee (\text{can}_{YZ}^{XYZ})_*(B), \quad \text{Cir}(B, A) = \left\{ \omega \in \frac{X \sqcup Y \sqcup Z}{\langle \alpha, \beta \rangle} \mid \omega \subset Y \right\}.$$

Besides, if $\omega \in ((X \sqcup Y \sqcup Z)/\langle \alpha, \beta \rangle) \setminus \text{Cir}(B, A)$, then $\omega \cap (X \sqcup Z) \neq \emptyset$. It follows that $\{\omega \mid \omega \in ((X \sqcup Y \sqcup Z)/\langle \alpha, \beta \rangle) \setminus \text{Cir}(B, A)\}$ is a partition of $X \sqcup Z \sqcup (Y \setminus \cup_{\omega \in \text{Cir}(B, A)} \omega)$. If $U' \subset U$ is an inclusion of sets, and if \mathcal{E} is a partition of U such that for any $x \in \mathcal{E}$, $x \cap U' \neq \emptyset$, then the restriction of the map $\mathcal{P}(U) \rightarrow \mathcal{P}(U')$, $x \mapsto x \cap U'$ to \mathcal{E} is injective, and if we denote by $\mathcal{E}' := \{x \cap U' \mid x \in \mathcal{E}\}$ the image of this map, then the map $\mathcal{E} \rightarrow \mathcal{E}'$ induced by $x \mapsto x \cap U'$ is a bijection; moreover, \mathcal{E}' is a partition of U' . It follows that $\{\omega \cap (X \sqcup Z) \mid \omega \in ((X \sqcup Y \sqcup Z)/\langle \alpha, \beta \rangle) \setminus \text{Cir}(B, A)\}$ is a partition of $X \sqcup Z$. One checks it to coincide with $B \circ A$, therefore

$$B \circ A = \left\{ \omega \cap (X \sqcup Z) \mid \omega \in \frac{X \sqcup Y \sqcup Z}{\langle \alpha, \beta \rangle} \setminus \text{Cir}(B, A) \right\} \in \text{Part}(X \sqcup Z).$$

The combination of the disjoint union decomposition $(X \sqcup Y \sqcup Z)/\langle \alpha, \beta \rangle = (((X \sqcup Y \sqcup Z)/\langle \alpha, \beta \rangle) \setminus \text{Cir}(B, A)) \sqcup \text{Cir}(B, A)$ and of the bijection $((X \sqcup Y \sqcup Z)/\langle \alpha, \beta \rangle) \setminus \text{Cir}(B, A) \rightarrow B \circ A$ gives rise to a natural bijection

$$(1.8) \quad \frac{X \sqcup Y \sqcup Z}{\langle \alpha, \beta \rangle} \simeq (B \circ A) \sqcup \text{Cir}(B, A).$$

Let us show that for any $\varphi \in B \circ A$, we have $|\varphi| = 2$ which shows that $B \circ A \in \underline{\mathcal{B}r}'(X, Z)$. Indeed, if $\omega \in \frac{X \sqcup Y \sqcup Z}{\langle \alpha, \beta \rangle}$, then $\omega^\alpha = \omega \cap X$ and $\omega^\beta = \omega \cap Z$, here we are using the notations from Proposition 1.15. By this proposition, the number $|\omega \cap (X \sqcup Z)| = |\omega^\alpha| + |\omega^\beta|$ belongs to $\{0, 2\}$. If $\varphi := \omega \cap (X \sqcup Z) \in B \circ A$, then $\omega \notin \text{Cir}(B, A)$, that is, $\omega \not\subset Y$. Therefore, $|\varphi| = |\omega \cap (X \sqcup Z)| > 0$. Hence, $|\varphi| = 2$, which finishes the proof. \square

Theorem 1.18 allows to define the category $\underline{\mathcal{B}r}'$ of *abstract Brauer diagrams* with same objects as the category $\underline{\mathcal{P}art}$ of partitions.

Corollary 1.19. *The category $\underline{\mathcal{B}r}'$ of abstract Brauer diagrams is a subcategory of the category $\underline{\mathcal{P}art}$ of partitions.*

Definition 1.20. Define a category $\underline{\mathcal{B}r}$ of Brauer diagrams as follows. The set of objects $\text{Ob}(\underline{\mathcal{B}r})$ of $\underline{\mathcal{B}r}$ is $\mathbb{Z}_{>0}$. For $p, q \in \mathbb{Z}_{>0}$ the set of morphisms $\underline{\mathcal{B}r}(p, q)$ from p to q is given by $\underline{\mathcal{B}r}(p, q) := \underline{\mathcal{B}r}'(\llbracket 1, p \rrbracket, \llbracket 1, q \rrbracket)$. In particular, for any $p, q, r \in \mathbb{Z}_{>0}$ there is a map $\text{Cir} : \underline{\mathcal{B}r}(p, q) \times \underline{\mathcal{B}r}(q, r) \rightarrow \mathcal{S}ets$ satisfying the properties from Proposition 1.10 and Remark 1.11.

Definition 1.21. (a) The set $\mathcal{B}r$ of Brauer diagrams is defined as $\bigsqcup_{p, q \in \mathbb{Z}_{>0}} \underline{\mathcal{B}r}(p, q)$, i.e.,

$$(1.9) \quad \mathcal{B}r = \bigsqcup_{p, q \in \mathbb{Z}_{>0}} \underline{\mathcal{B}r}(p, q) \simeq \{(p, q, \sigma) \mid p, q \in \mathbb{Z}_{>0}, \sigma \in \text{FPFI}(\llbracket 1, p \rrbracket \sqcup \llbracket 1, q \rrbracket)\}.$$

(b) Define the *source* and *target* maps $s, t : \mathcal{B}r \rightarrow \mathbb{Z}_{>0}$ by $s(p, q, \sigma) := p$ and $t(p, q, \sigma) := q$.

(c) Let $\mathcal{B}r \times_{\mathbb{Z}} \mathcal{B}r := \{(a, b) \in \mathcal{B}r^2 \mid t(a) = s(b)\}$ and $\circ_{\mathcal{B}r} : \mathcal{B}r \times_{\mathbb{Z}} \mathcal{B}r \rightarrow \mathcal{B}r$, $(a, b) \mapsto b \circ_{\mathcal{B}r} a$ be the map corresponding to the composition in $\underline{\mathcal{B}r}$.

By convention, $\underline{\mathcal{B}r}(0, 0)$ consists in one element denoted \emptyset .

Definition 1.22. For $(p, q, \sigma) \in \mathcal{B}r$, we define its set of *connected components*, denoted $\pi_0(p, q, \sigma)$, by $\pi_0(p, q, \sigma) := (\llbracket 1, p \rrbracket \sqcup \llbracket 1, q \rrbracket) / \langle \sigma \rangle$.

The map $(p, q, \sigma) \mapsto \pi_0(p, q, \sigma)$ sets up a bijection underline $\underline{\mathcal{B}r}(p, q) \rightarrow \underline{\mathcal{B}r}'(\llbracket 1, p \rrbracket, \llbracket 1, q \rrbracket)$ for any $p, q \in \mathbb{Z}_{>0}$. Moreover, the collection of these maps is compatible with compositions on both sides. In particular, equation (1.8) implies that for any (p, q, σ) and (q, r, τ) in $\mathcal{B}r$, one has

$$(1.10) \quad \llbracket 1, p \rrbracket \sqcup \llbracket 1, q \rrbracket \sqcup \llbracket 1, r \rrbracket / \langle \alpha, \beta \rangle \simeq \pi_0((q, r, \tau) \circ (p, q, \sigma)) \sqcup \text{Cir}((q, r, \tau), (p, q, \sigma))$$

where α, β are the involutions of $\llbracket 1, p \rrbracket \sqcup \llbracket 1, q \rrbracket \sqcup \llbracket 1, r \rrbracket$ given by $\sigma * \text{Id}_{\llbracket 1, r \rrbracket}$ and $\text{Id}_{\llbracket 1, p \rrbracket} * \tau$.

1.4. Operations on Brauer diagrams.

1.4.1. Tensor product of Brauer diagrams.

Definition 1.23. Let $p, p', q, q' \in \mathbb{Z}_{>0}$ and $(p, q, \sigma), (p', q', \sigma') \in \mathcal{B}r$. Consider the identification $\llbracket 1, p+p' \rrbracket \simeq \llbracket 1, p \rrbracket \sqcup \llbracket 1, p' \rrbracket$ given by $\llbracket 1, p \rrbracket \ni x \mapsto x$ and $\llbracket 1, p' \rrbracket \ni x \mapsto x + p$. Similarly, consider the identification $\llbracket 1, q+q' \rrbracket \simeq \llbracket 1, q \rrbracket \sqcup \llbracket 1, q' \rrbracket$. Therefore,

$$(1.11) \quad \llbracket 1, p+p' \rrbracket \sqcup \llbracket 1, q+q' \rrbracket \simeq \llbracket 1, p \rrbracket \sqcup \llbracket 1, p' \rrbracket \sqcup \llbracket 1, q \rrbracket \sqcup \llbracket 1, q' \rrbracket \simeq \llbracket 1, p \rrbracket \sqcup \llbracket 1, q \rrbracket \sqcup \llbracket 1, p' \rrbracket \sqcup \llbracket 1, q' \rrbracket.$$

Then $\sigma * \sigma'$ (see Definition 1.17) defines a fixed-point free involution of $\llbracket 1, p+p' \rrbracket \sqcup \llbracket 1, q+q' \rrbracket$. The Brauer diagram $(p+p', q+q', \sigma * \sigma')$ is called the *tensor product* of (p, q, σ) and (p', q', σ') and it is denoted by $(p, q, \sigma) \otimes (p', q', \sigma')$.

The following is straightforward.

Lemma 1.24. *The tensor product from Definition 1.23 endows the category $\underline{\mathcal{B}r}$ with a monoidal structure. The unit object is $0 \in \mathbb{Z}_{>0}$ and its identity morphism is \emptyset .*

It follows from the axioms of a monoidal category that for any pair (P_i, P'_i) ($i = 1, 2$) of pairs of composable morphisms in $\underline{\mathcal{B}r}$, one has

$$(1.12) \quad (P'_1 \otimes P'_2) \circ (P_1 \otimes P_2) = (P'_1 \circ P_1) \otimes (P'_2 \circ P_2).$$

Lemma 1.25. *Let P_i, P'_i composable morphisms in $\underline{\mathcal{B}r}$ for $i = 1, 2$. Then there is a bijection*

$$\text{bij}_{P'_1, P_1, P'_2, P_2} : \text{Cir}(P'_1, P_1) \sqcup \text{Cir}(P'_2, P_2) \longrightarrow \text{Cir}(P'_1 \otimes P'_2, P_1 \otimes P_2).$$

Proof. Let $\varphi : \llbracket 1, |t(P_1)| \rrbracket \sqcup \llbracket 1, |t(P_2)| \rrbracket \rightarrow \llbracket 1, |t(P_1)| + |t(P_2)| \rrbracket$ be the canonical bijection taking $x \in \llbracket 1, |t(P_1)| \rrbracket$ to x and $x \in \llbracket 1, |t(P_2)| \rrbracket$ to $x + |t(P_1)|$. One checks that the induced map

$$\text{Cir}(P'_1, P_1) \sqcup \text{Cir}(P'_2, P_2) \longrightarrow \text{Cir}(P'_1 \otimes P'_2, P_1 \otimes P_2)$$

taking $\omega \in \text{Cir}(P'_1, P_1) \sqcup \text{Cir}(P'_2, P_2)$ to $\varphi(\omega)$ is a bijection. \square

1.4.2. Doubling operation for Brauer diagrams.

Definition 1.26. Let $(p, q, \sigma) \in \mathcal{B}r$ and $A \subset \pi_0(p, q, \sigma)$. Set $p' := p + |\sqcup_{\omega \in A} \omega \cap \llbracket 1, p \rrbracket|$ and $q' := q + |\sqcup_{\omega \in A} \omega \cap \llbracket 1, q \rrbracket|$.

- (a) Let $\text{pr}_s : \llbracket 1, p' \rrbracket \rightarrow \llbracket 1, p \rrbracket$ be the only no-decreasing map such that $|\text{pr}_s^{-1}(x)| = \begin{cases} 1 & \text{if } x \notin A \cap \llbracket 1, p \rrbracket \\ 2 & \text{if } x \in A \cap \llbracket 1, p \rrbracket \end{cases}$
- Similarly we define $\text{pr}_t : \llbracket 1, q' \rrbracket \rightarrow \llbracket 1, q \rrbracket$. Set $\text{pr} := \text{pr}_s \sqcup \text{pr}_t : \llbracket 1, p' \rrbracket \sqcup \llbracket 1, q' \rrbracket \rightarrow \llbracket 1, p \rrbracket \sqcup \llbracket 1, q \rrbracket$.
- (b) Let $\sigma' \in \text{FPFI}(\llbracket 1, p' \rrbracket \sqcup \llbracket 1, q' \rrbracket)$ be the only involution such that
- $\sigma \circ \text{pr} = \text{pr} \circ \sigma'$. This implies that for any $x \subset \llbracket 1, p \rrbracket \sqcup \llbracket 1, q \rrbracket$ there is a map $\sigma'_x : \text{pr}^{-1}(x) \rightarrow \text{pr}^{-1}(\sigma(x))$,
 - for any $a \in A$, the map σ'_a is a bijection which is decreasing if $a \subset \llbracket 1, p \rrbracket$ or $a \subset \llbracket 1, q \rrbracket$ and increasing otherwise.
- (c) The Brauer diagram $(p', q', \sigma') \in \mathcal{B}r$ is called the *doubling of (p, q, σ) along A* , and we denote it by $\text{dbl}_{\mathcal{B}r}((p, q, \sigma), A)$ or $(p, q, \sigma)^A$.

1.5. Oriented Brauer diagrams.

Definition 1.27. (a) Let $p, q \geq 0$ be integers. The set $\vec{\mathcal{B}r}(p, q)$ of *oriented Brauer diagrams from p to q* is defined as the set of tuples $((p, q, \sigma), B)$ where $(p, q, \sigma) \in \mathcal{B}r$ and $B \subset \llbracket 1, p \rrbracket \sqcup \llbracket 1, q \rrbracket$ such that $\sigma|_B : B \rightarrow (\llbracket 1, p \rrbracket \sqcup \llbracket 1, q \rrbracket) / \langle \sigma \rangle = \pi_0(p, q, \sigma)$ is a bijection. The elements of B are called the *beginning points* of the diagram $((p, q, \sigma), B)$ and the elements of $E := \sigma(B)$ its *ending points*.

- (b) The set $\vec{\mathcal{B}r}$ of *oriented Brauer diagrams* is defined as $\bigsqcup_{p, q \in \mathbb{Z}_{\geq 0}} \vec{\mathcal{B}r}(p, q)$, i.e.,

$$\vec{\mathcal{B}r} = \left\{ ((p, q, \sigma), B) \mid (p, q, \sigma) \in \mathcal{B}r, B \subset \llbracket 1, p \rrbracket \sqcup \llbracket 1, q \rrbracket \text{ such that } B \simeq (\llbracket 1, p \rrbracket \sqcup \llbracket 1, q \rrbracket) / \sigma \right\}.$$

- (c) For an oriented Brauer diagram $((p, q, \sigma), B)$ we define the set of its *connected components*, denoted $\pi_0((p, q, \sigma), B)$, as the set $\pi_0(p, q, \sigma)$.

We denote by $\vec{\emptyset}$ the unique element of $\vec{\mathcal{B}r}(0, 0)$.

If $((p, q, \sigma), B) \in \vec{\mathcal{B}r}$ and $E := \sigma(B)$, then $B \sqcup E = \llbracket 1, p \rrbracket \sqcup \llbracket 1, q \rrbracket$ and $\sigma|_B : B \rightarrow E$ is a bijection.

Definition 1.28. For $x := ((p, q, \sigma), B)$ an oriented Brauer diagram, we denote by $\text{b}_x : \pi_0(x) \rightarrow B$ and $\text{e}_x : \pi_0(P) \rightarrow E$ the maps such that for any $u \in \pi_0(x)$, one has $u = \{\text{b}_x(u), \text{e}_x(u)\}$.

The maps b_x and e_x are bijections, and the bijection $\sigma|_B : B \rightarrow E$ is the composition $\text{e}_x \circ \text{b}_x^{-1}$.

Definition 1.29. Two elements $((p, q, \sigma), B), ((p', q', \sigma'), B') \in \vec{\mathcal{B}r}$ are *composable* if $q = p'$ and $\sigma(B) \cap \llbracket 1, q \rrbracket = B' \cap \llbracket 1, q \rrbracket$ (notice that this is equivalent to $B \cap \llbracket 1, q \rrbracket = \sigma'(B') \cap \llbracket 1, q \rrbracket$). In such a case, the *composition* of $((p, q, \sigma), B)$ and $((p', q', \sigma'), B')$, denoted $((p', q', \sigma'), B') \circ_{\vec{\mathcal{B}r}} ((p, q, \sigma), B)$, is defined by

$$((p', q', \sigma'), B') \circ_{\vec{\mathcal{B}r}} ((p, q, \sigma), B) := ((p', q', \sigma') \circ_{\mathcal{B}r} (p, q, \sigma), (B \cap \llbracket 1, p \rrbracket) \sqcup (B' \cap \llbracket 1, q' \rrbracket)).$$

Proposition 1.30. *The operation $\circ_{\vec{\mathcal{B}r}}$ is associative.*

Proof. Let $a := ((p, q, \alpha), A), b := ((q, r, \beta), B), c := ((r, s, \gamma), C) \in \vec{\mathcal{B}r}$. The equality $c \circ_{\vec{\mathcal{B}r}} (b \circ_{\vec{\mathcal{B}r}} a) = (c \circ_{\vec{\mathcal{B}r}} b) \circ_{\vec{\mathcal{B}r}} a$ follows from Corollary 1.19, the definition of $\circ_{\vec{\mathcal{B}r}}$ and the equalities of sets

$$\begin{aligned} \left[((A \cap \llbracket 1, p \rrbracket) \sqcup (B \cap \llbracket 1, r \rrbracket)) \cap \llbracket 1, p \rrbracket \right] \sqcup (C \cap \llbracket 1, s \rrbracket) &= (A \cap \llbracket 1, p \rrbracket) \sqcup (C \cap \llbracket 1, s \rrbracket) \\ &= (A \cap \llbracket 1, p \rrbracket) \sqcup \left[((B \cap \llbracket 1, q \rrbracket) \sqcup (C \cap \llbracket 1, s \rrbracket)) \cap \llbracket 1, s \rrbracket \right]. \end{aligned}$$

□

1.6. Operations on oriented Brauer diagrams.

1.6.1. Tensor product of oriented Brauer diagrams.

Definition 1.31. Let $((p, q, \sigma), B), ((p', q', \sigma'), B')$ be oriented Brauer diagrams. The *tensor product* of $((p, q, \sigma), B)$ and $((p', q', \sigma'), B')$, denoted $((p, q, \sigma), B) \otimes ((p', q', \sigma'), B')$, is defined by

$$((p, q, \sigma), B) \otimes ((p', q', \sigma'), B') := ((p, q, \sigma) \otimes (p', q', \sigma'), B \sqcup B') \in \vec{\mathcal{B}}r(p + p', q + q'),$$

where we use the identification (1.11) to see B and B' as subsets of $\llbracket 1, p + p' \rrbracket \sqcup \llbracket 1, q + q' \rrbracket$.

1.6.2. Change of orientation for oriented Brauer diagrams.

Definition 1.32. Let $((p, q, \sigma), B) \in \vec{\mathcal{B}}r$. For $b \in B$, we define an oriented Brauer diagram by

$$\text{co}_{\vec{\mathcal{B}}r}(((p, q, \sigma), B), b) := ((p, q, \sigma), (B \setminus \{b\}) \cup \{\sigma(b)\}).$$

We say that $\text{co}_{\vec{\mathcal{B}}r}(((p, q, \sigma), B), b)$ is obtained from $((p, q, \sigma), B)$ by *change of orientation of b* .

1.6.3. Doubling operation for oriented Brauer diagrams.

Definition 1.33. Let $((p, q, \sigma), B) \in \vec{\mathcal{B}}r$ and $A \subset \pi_0((p, q, \sigma), B)$. Let $p' := p + |\sqcup_{\omega \in A} \omega \cap \llbracket 1, p \rrbracket|$ and $q' := q + |\sqcup_{\omega \in A} \omega \cap \llbracket 1, q \rrbracket|$ and $\text{pr} : \llbracket 1, p' \rrbracket \sqcup \llbracket 1, q' \rrbracket \rightarrow \llbracket 1, p \rrbracket \sqcup \llbracket 1, q \rrbracket$ as in Definition 1.26(a). The *doubling of $((p, q, \sigma), B)$ along A* , denoted $\text{dbl}_{\vec{\mathcal{B}}r}(((p, q, \sigma), B), A)$ or $((p, q, \sigma), B)^A$, is the oriented Brauer diagram defined by

$$\text{dbl}_{\vec{\mathcal{B}}r}(((p, q, \sigma), B), A) := (\text{dbl}_{\mathcal{B}r}((p, q, \sigma), A), \text{pr}^{-1}(B)) \in \vec{\mathcal{B}}r.$$

1.7. Properties of operations of oriented Brauer diagrams.

Definition 1.34. Let $\{+, -\}^*$ be the free associative monoid over $\{+, -\}$, i.e., the set of words in these letters. It can be identified with $\sqcup_{n \geq 0} \{+, -\}^n$, i.e., with the set of pairs (n, f) , where $n \in \mathbb{Z}_{\geq 0}$ and f is a map $\llbracket 1, n \rrbracket \rightarrow \{+, -\}$. For $w \in \{+, -\}^*$, we denote by $|w|$ its *length*: $|w| = n \in \mathbb{Z}_{\geq 0}$ if and only if w is identified with a pair (n, f) as above. The empty word (corresponding to $n = 0$) will be denoted \emptyset .

Definition 1.35. Define the *source* and *target* maps $s, t : \vec{\mathcal{B}}r \rightarrow \{+, -\}^*$ by $s((p, q, \sigma), B)^{-1}(+) = \sigma(B) \cap \llbracket 1, p \rrbracket$ and $s((p, q, \sigma), B)^{-1}(-) = B \cap \llbracket 1, p \rrbracket$; and $t((p, q, \sigma), B)^{-1}(+) = B \cap \llbracket \bar{1}, \bar{q} \rrbracket$ and $t((p, q, \sigma), B)^{-1}(-) = \sigma(B) \cap \llbracket \bar{1}, \bar{q} \rrbracket$.

Notice that two oriented Brauer diagrams a and b are composable (according to Definition 1.29) if and only if $t(a) = s(b)$.

Definition 1.36. The monoidal category $\vec{\mathcal{B}}r$ of oriented Brauer diagrams is defined as follows. The set of objects of $\vec{\mathcal{B}}r$ is $\{+, -\}^*$. For $u, v \in \{+, -\}^*$, the set of morphisms $\vec{\mathcal{B}}r(u, v)$ is the set oriented Brauer diagrams a such that $s(a) = u$ and $t(a) = v$.

For $u, v, w \in \{+, -\}^*$ the composition

$$\vec{\mathcal{B}}r(u, v) \times \vec{\mathcal{B}}r(v, w) \longrightarrow \vec{\mathcal{B}}r(u, w)$$

is given by $\circ_{\vec{\mathcal{B}}r}$ as in Definition 1.29. The identity $\text{Id}_u \in \vec{\mathcal{B}}r(u, u)$ of $u \in \{+, -\}^*$ is the tuple $(\text{Id}_{|u|}, B)$ where $\text{Id}_{|u|} \in \vec{\mathcal{B}}r(|u|, |u|)$ is the identity of $|u|$ and $B = \{x \in \llbracket 1, |u| \rrbracket \mid u(x) = -\} \sqcup \{x \in \llbracket 1, |u| \rrbracket \mid u(x) = +\}$.

At the level of objects, the tensor product is given by the concatenation of words: $u \otimes v := uv$ for any $u, v \in \{+, -\}^*$. For $u, u', v, v' \in \{+, -\}^*$, the tensor product map at the level of morphisms

$$\vec{\mathcal{B}}r(u, v) \times \vec{\mathcal{B}}r(u', v') \longrightarrow \vec{\mathcal{B}}r(uv, u'v')$$

is as in Definition 1.31. The unit object of $\vec{\mathcal{B}}r$ is $0 \in \mathbb{Z}_{\geq 0}$ and its identity morphism is $\vec{\emptyset}$.

In particular, we have the oriented version of (1.12):

$$(1.13) \quad (P'_1 \otimes P'_2) \circ (P_1 \otimes P_2) = (P'_1 \circ P_1) \otimes (P'_2 \circ P_2)$$

for any P_i, P'_i ($i = 1, 2$) composable morphisms in $\vec{\mathcal{B}}r$.

Lemma 1.37. *There is a canonical monoidal functor $\vec{\mathcal{B}}r \rightarrow \mathcal{B}r$ which takes $u \in \{+, -\}^*$ to its length $|u| \in \mathbb{Z}_{\geq 0}$ and it takes a morphism $((p, q, \sigma), B)$ in $\vec{\mathcal{B}}r$ to the morphism (p, q, σ) in $\mathcal{B}r$.*

Proof. The result follows from the definitions of the categories. \square

Definition 1.38. Let $u, v, w \in \{+, -\}^*$. Define the map $\text{Cir} : \vec{\mathcal{B}}r(u, v) \times \vec{\mathcal{B}}r(v, w) \rightarrow \text{Sets}$ as the composition

$$\vec{\mathcal{B}}r(u, v) \times \vec{\mathcal{B}}r(v, w) \longrightarrow \mathcal{B}r(u, v) \times \mathcal{B}r(v, w) \xrightarrow{\text{Cir}} \text{Sets},$$

where the last map was defined in Definition 1.20.

Lemma 1.25 generalizes naturally for oriented Brauer diagrams.

Lemma 1.39. *Let P_i, P'_i composable morphisms in $\vec{\mathcal{B}}r$ for $i = 1, 2$. Then there is a bijection*

$$\text{bij}_{P'_1, P_1, P'_2, P_2} : \text{Cir}(P'_1, P_1) \sqcup \text{Cir}(P'_2, P_2) \longrightarrow \text{Cir}(P'_1 \otimes P'_2, P_1 \otimes P_2).$$

Proof. The result follows from Lemma 1.25 \square

Definition 1.40. For $w \in \{+, -\}^*$ and $A \subset \llbracket 1, |w| \rrbracket$, define the word $\text{dbl}_{\{+, -\}^*}(w, A)$ in $\{+, -\}^*$ (also denoted w^A) by $\text{dbl}_{\{+, -\}^*}(w, A) := (|w| + |A|, w \circ \pi_{|w|, A})$ where $\pi_{|w|, A} : \llbracket 1, |w| + |A| \rrbracket \rightarrow \llbracket 1, |w| \rrbracket$ is the only non-decreasing surjective map such that the fibers of the elements of A (resp. $\llbracket 1, |w| \rrbracket \setminus A$) have cardinality 2 (resp. 1).

Lemma 1.41. *Let $P := ((p, q, \sigma), B) \in \vec{\mathcal{B}}r$ and $A \subset \pi_0(P)$ and $a, b \in B$. Then*

- (a) $s(\text{dbl}_{\vec{\mathcal{B}}r}(P, A)) = \text{dbl}_{\{+, -\}^*}(s(P), \tilde{A} \cap \llbracket 1, p \rrbracket)$ and $t(\text{dbl}_{\vec{\mathcal{B}}r}(P, A)) = \text{dbl}_{\{+, -\}^*}(t(P), \tilde{A} \cap \llbracket 1, q \rrbracket)$, where \tilde{A} is the preimage of A by the projection $\llbracket 1, p \rrbracket \sqcup \llbracket 1, q \rrbracket \rightarrow \pi_0(P)$.
- (b) $\pi_0(\text{co}_{\vec{\mathcal{B}}r}(P, a)) \simeq \pi_0(P)$ and $\text{co}_{\vec{\mathcal{B}}r}(\text{co}_{\vec{\mathcal{B}}r}(P, b), a) = \text{co}_{\vec{\mathcal{B}}r}(\text{co}_{\vec{\mathcal{B}}r}(P, a), b)$ and $\text{co}_{\vec{\mathcal{B}}r}(\text{co}_{\vec{\mathcal{B}}r}(P, a), a) = P$.
- (c) for any $P' \in \vec{\mathcal{B}}r$ we have $\text{dbl}_{\vec{\mathcal{B}}r}(P \otimes P', A) = \text{dbl}_{\vec{\mathcal{B}}r}(P, A) \otimes P'$, where in the left-hand side we identify A with a subset of $\pi_0(P \otimes P')$, still denoted by A , via de inclusion $\pi_0(P) \subset \pi_0(P \otimes P')$.

Proof. Direct verification. \square

Lemma 1.42. (a) For any $P, P' \in \vec{\mathcal{B}}r$, one has $\pi_0(P \otimes P') \simeq \pi_0(P) \sqcup \pi_0(P')$.

(b) For any $P \in \vec{\mathcal{B}}r$ and $A \subset \pi_0(P)$, one has a natural map $\text{proj}_{P, A}^{\pi_0} : \pi_0(\text{dbl}_{\vec{\mathcal{B}}r}(P, A)) \rightarrow \pi_0(P)$.

(c) For any composable pair (P, P') of elements of $\vec{\mathcal{B}}r$ there is a natural map $\text{proj}_{P, P'}^{\pi_0} : \pi_0(P) \sqcup \pi_0(P') \rightarrow \pi_0(P' \circ P) \sqcup \text{Cir}(P', P)$.

Proof. It is enough to show the statements for elements in $\mathcal{B}r$. (a) Let $P = (p, q, \sigma), P' = (p', q', \sigma') \in \mathcal{B}r$. By Definition 1.22, 1.23 and 1.17 we have

$$\pi_0(P \otimes P') = \frac{\llbracket 1, p + p' \rrbracket \sqcup \llbracket 1, q + q' \rrbracket}{\langle \sigma * \sigma' \rangle} \simeq \frac{\llbracket 1, p \rrbracket \sqcup \llbracket 1, q \rrbracket}{\langle \sigma \rangle} \sqcup \frac{\llbracket 1, p' \rrbracket \sqcup \llbracket 1, q' \rrbracket}{\langle \sigma' \rangle} = \pi_0(P) \sqcup \pi_0(P').$$

(b) Let $P = (p, q, \sigma) \in \mathcal{B}r$ and $A \subset \pi_0(P)$. Let $(p', q', \sigma') = \text{dbl}_{\mathcal{B}r}((p, q, \sigma), A)$ and $\text{pr} : \llbracket 1, p' \rrbracket \sqcup \llbracket 1, q' \rrbracket \rightarrow \llbracket 1, p \rrbracket \sqcup \llbracket 1, q \rrbracket$ as in Definition 1.33. By definition of σ' the map $\llbracket 1, p' \rrbracket \sqcup \llbracket 1, q' \rrbracket \xrightarrow{\text{pr}} \llbracket 1, p \rrbracket \sqcup \llbracket 1, q \rrbracket \xrightarrow{\text{proj}} \pi_0(P)$ factors to the quotient $(\llbracket 1, p' \rrbracket \sqcup \llbracket 1, q' \rrbracket) / \langle \sigma' \rangle$ giving the map $\text{proj}_{P, A}^{\pi_0} : \pi_0(\text{dbl}_{\vec{\mathcal{B}}r}(P, A)) \rightarrow \pi_0(P)$.

(c) Let $P = (p, q, \sigma), P' = (q, r, \sigma') \in \mathcal{B}r$ a pair of composable Brauer diagrams. The projection map

$$(\llbracket 1, p \rrbracket \sqcup \llbracket 1, q \rrbracket) \sqcup \llbracket 1, q \rrbracket \sqcup \llbracket 1, r \rrbracket \longrightarrow \frac{\llbracket 1, p \rrbracket \sqcup \llbracket 1, q \rrbracket \sqcup \llbracket 1, r \rrbracket}{\langle \sigma * \text{Id}_{\llbracket 1, r \rrbracket}, \text{Id}_{\llbracket 1, p \rrbracket} * \sigma' \rangle} \simeq \pi_0(P' \circ P) \sqcup \text{Cir}(P', P),$$

see (1.10) for the last identification, factorizes in the map $\text{proj}_{P, P'}^{\pi_0} : \pi_0(P) \sqcup \pi_0(P') \rightarrow \pi_0(P' \circ P) \sqcup \text{Cir}(P', P)$. \square

Definition 1.43. Let $\pm : \{+, -\} \rightarrow \{+, -\}$ be the non-identity involution, i.e., $\pm(+)= -$ and $\pm(-)= +$.

Remark 1.44. Let \mathfrak{B} be the set of tuples (u, v, σ) where $u, v \in \{+, -\}^*$ and $\sigma \in \text{FPFI}(\llbracket 1, |u| \rrbracket \sqcup \llbracket 1, |v| \rrbracket)$ such that

- $u(\sigma(x)) = \pm(u(x))$ if $x, \sigma(x) \in \llbracket 1, |u| \rrbracket$,
- $v(\sigma(x)) = u(x)$ if $x \in \llbracket 1, |u| \rrbracket$ and $\sigma(x) \in \llbracket 1, |v| \rrbracket$,
- $v(\sigma(x)) = \pm(v(x))$ if $x, \sigma(x) \in \llbracket 1, |v| \rrbracket$,
- $u(\sigma(x)) = v(x)$ if $x \in \llbracket 1, |v| \rrbracket$ and $\sigma(x) \in \llbracket 1, |u| \rrbracket$.

There is a unique bijection $\vec{\mathcal{B}}r \rightarrow \mathfrak{B}$ given by $((p, q, \sigma), B) \mapsto (s((p, q, \sigma), B), t((p, q, \sigma), B), \sigma)$ for any $((p, q, \sigma), B) \in \vec{\mathcal{B}}r$, where s and t are as in Definition 1.35. Indeed, one checks that the map $(u, v, \sigma) \mapsto ((|u|, |v|, \sigma), B)$ where $B := \{x \in \llbracket 1, |u| \rrbracket \mid u(x) = -\} \sqcup \{x \in \llbracket 1, |v| \rrbracket \mid v(x) = +\}$ defines an inverse.

1.8. Schematic representation of Brauer diagrams, oriented Brauer diagrams and their operations. We represent a Brauer diagram $(p, q, \sigma) \in \mathcal{B}r$ in the square $[-1, 1]^2$ as follows. Consider p points labelled by $1, \dots, p$ uniformly distributed along $[-1, 1] \times \{0\}$. Similarly consider q points labelled $\bar{1}, \dots, \bar{q}$ uniformly distributed along $[-1, 1] \times \{1\}$. For any $i \in \llbracket 1, p \rrbracket \sqcup \llbracket 1, q \rrbracket$ we join i with $\sigma(i)$ using a path $\overline{i\sigma(i)} = \overline{\sigma(i)i}$ contained in $[-1, 1]^2$ and such that its intersection with $\partial[-1, 1]^2$ consists only of i and $\sigma(i)$. We suppose that $\bigcap_i \overline{i\sigma(i)}$ is a finite set and that all the intersections are transversal. We consider such a diagram up to homotopy. Reciprocally, such a diagram gives rise to a Brauer diagram. See Figure 1.1(a) and (b) for some examples.

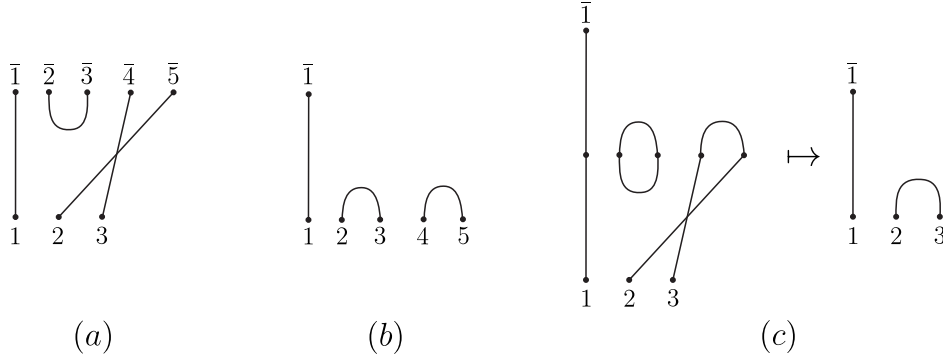

FIGURE 1.1. (a) Schematic representation of the Brauer diagram $(3, 5, \sigma)$ where $\sigma \in \text{FPFI}(\llbracket 1, 3 \rrbracket \sqcup \llbracket 1, 5 \rrbracket)$ is given by $\sigma(1) = \bar{1}$, $\sigma(2) = \bar{5}$, $\sigma(3) = \bar{4}$, $\sigma(\bar{2}) = 3$. (b) Schematic representation of the Brauer diagram $(5, 1, \tau)$ where $\tau \in \text{FPFI}(\llbracket 1, 5 \rrbracket \sqcup \llbracket 1, 1 \rrbracket)$ is given by $\tau(1) = \bar{1}$, $\tau(2) = 3$, $\tau(4) = 5$. (c) Schematic representation of the composed Brauer diagram $(5, 1, \tau) \circ_{\mathcal{B}r} (3, 5, \sigma) = (3, 1, \rho)$ where $\rho \in \text{FPFI}(\llbracket 1, 3 \rrbracket \sqcup \llbracket 1, 1 \rrbracket)$ is given by $\rho(1) = \bar{1}$ and $\rho(2) = 3$.

In the case of an oriented Brauer diagram $((p, q, \sigma), B)$ we orient the path $\overline{b\sigma(b)}$ from b to $\sigma(b)$ for $b \in B$.

For an oriented Brauer diagram $a := ((p, q, \sigma), B)$ we can read the source and target words in $\{+, -\}^*$ in its schematic representation using the following convention: for $i \in \llbracket 1, p \rrbracket$ we have that $s(a)(i) = +$ if the orientation of the schematic representation points toward i and $s(a)(i) = -$ otherwise; and for $i \in \llbracket 1, q \rrbracket$ we have $t(a)(\bar{i}) = -$ if the orientation of the schematic representation points towards \bar{i} and $t(a)(\bar{i}) = +$ otherwise. See Figure 1.2 (a) and (b) for some examples.

The tensor product is described schematically by horizontal concatenation of the schematic representations and horizontal rescaling. The composition is described schematically by vertical concatenation of the schematic representations (read from bottom to top), vertical rescaling and deletion of the circle components, see Figure 1.1(c) Figure 1.2(c) for examples of composition in $\mathcal{B}r$ and $\vec{\mathcal{B}}r$, respectively.

The canonical functor $\vec{\mathcal{B}}r \rightarrow \mathcal{B}r$ is described schematically by forgetting the orientation of the paths. For instance, the image under this functor of the oriented Brauer diagrams in Figure 1.2 is the Brauer diagrams of Figure 1.1.

The Brauer diagram $\text{dbl}_{\vec{\mathcal{B}}r}(((p, q, \sigma), B), A)$ obtained by a doubling operation is described schematically by the parallel doubling of the paths with endpoints in A . We represent the paths in A by using thickened

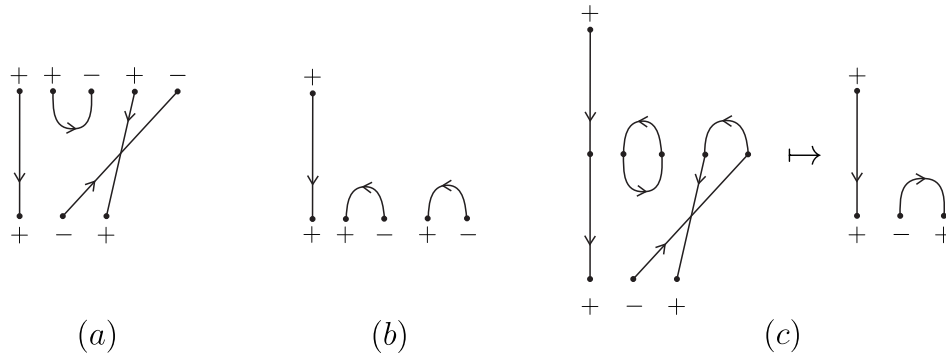

FIGURE 1.2. (a) Schematic representation of the oriented Brauer diagram $((3, 5, \sigma), B)$ with $\sigma(1) = \bar{1}$, $\sigma(2) = \bar{5}$, $\sigma(3) = \bar{4}$, $\sigma(\bar{2}) = \bar{3}$ and $B = \{\bar{1}, \bar{2}, \bar{4}, 2\}$. (b) Schematic representation of the oriented Brauer diagram $((5, 1, \tau), B')$ where $\tau \in \text{FPFI}(\llbracket 1, 5 \rrbracket \sqcup \llbracket 1, 1 \rrbracket)$ is given by $\tau(1) = \bar{1}$, $\tau(2) = 3$, $\tau(4) = 5$ and $B' = \{\bar{1}, 3, 5\}$. (c) Schematic representation of the composed oriented Brauer diagram $((5, 1, \tau), B') \circ_{\mathcal{B}_r} ((3, 5, \sigma), B) = ((3, 1, \rho), B'')$ where $\rho \in \text{FPFI}(\llbracket 1, 3 \rrbracket \sqcup \llbracket 1, 1 \rrbracket)$ is given by $\rho(1) = \bar{1}$ and $\rho(2) = 3$ and $B'' = \{\bar{1}, 2\}$.

lines. The orientation of the new paths after the doubling is compatible with that of the paths before the doubling. In Figure 1.3(a) and (b) we shown an example of doubling for an oriented Brauer diagram.

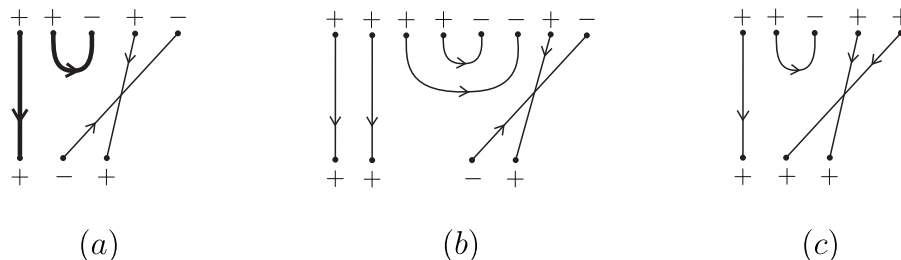

FIGURE 1.3. (a) Schematic representation of the oriented Brauer diagram $((3, 5, \sigma), B)$ with $\sigma(1) = \bar{1}$, $\sigma(2) = \bar{5}$, $\sigma(3) = \bar{4}$, $\sigma(\bar{2}) = \bar{3}$ and $B = \{\bar{1}, \bar{2}, \bar{4}, 2\}$ and we use thickened lines to represent $A = \{\{1, \bar{1}\}, \{2, \bar{3}\}\} \subset \pi_0((3, 5, \sigma), B)_{\text{seg}}$. (b) Schematic representation of the oriented Brauer diagram $\text{dbl}_{\mathcal{B}_r}(((3, 5, \sigma), B), A)$. (c) schematic representation of $\text{co}_{\mathcal{B}_r}(((3, 5, \sigma), B), 2)$.

The change of orientation operation is described schematically by changing the orientation of the corresponding path, see Figure 1.3(a) and (c) for an example.

2. LINKS, TANGLES, KII MAP, KIRBY BIALGEBRAS, PRE-LMO STRUCTURES AND INVARIANTS OF 3-MANIFOLDS

We start this section by recalling the description of 3-manifolds based on surgery along framed oriented links in S^3 and the Lickorish-Wallace and Kirby theorems (§2.1). In §2.2 we introduce basic definitions about the set $\vec{\mathcal{T}}$ of framed oriented tangles, its categorical interpretation and its relation with oriented Brauer diagrams. In §2.3 we define an orientation-reversal operation and the set $\text{CO}\vec{\mathcal{T}} = \sqcup_{k \geq 0} \text{CO}\vec{\mathcal{T}}_k$. In §2.4 we introduce the doubling map for oriented framed tangles. In §2.5 we define the KII map and the set $\text{KII}\vec{\mathcal{T}}$. In §2.6 we give a simplified description of the set $\text{KII}\vec{\mathcal{T}}$ as well as a description of it using the category of parenthesized framed oriented tangles $\mathcal{Pa}\vec{\mathcal{T}}$. In §2.7 we show that $\text{KII}\vec{\mathcal{T}}$ decomposes as a disjoint union $\sqcup_{k \geq 0} \text{KII}\vec{\mathcal{T}}_k$. In §2.8 we use the sets $\text{CO}\vec{\mathcal{T}}$ and $\text{KII}\vec{\mathcal{T}}$ to define the Kirby monoid which allows to describe the monoid of 3-manifolds by reinterpreting the Lickorish-Wallace and Kirby theorems. We introduce the notions of Kirby bialgebra, (semi)Kirby structures and their relation with the construction

of invariants of 3-manifolds. Finally in §2.9 we define the notion of pre-LMO structure and we show that it gives rise to a semi-Kirby structure.

2.1. Presentation of 3-manifolds based on links in S^3 .

2.1.1. Framed oriented links in S^3 .

Definition 2.1. (a) An *oriented link* of l components in S^3 is an embedding of l disjoint copies of S^1 in S^3 , $\coprod_{i=1}^l S^1 \hookrightarrow S^3$. We denote the image of the embedding by $L = K_1 \cup \dots \cup K_l$. See Figure 2.1.

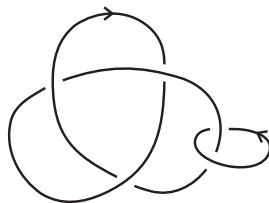

FIGURE 2.1. Oriented link of two components.

(b) A *framed oriented link* $L = (L, f)$ is an oriented link $L = K_1 \cup \dots \cup K_l$ with a *framing* $f = (f_1, \dots, f_l)$, where f_i is the isotopy class of a section of the projection $\partial N(K_i) \rightarrow K_i$, where $N(K_i)$ is a tubular neighborhood of K_i . We orient f_i by using the orientation of K_i . See Figure 2.2.

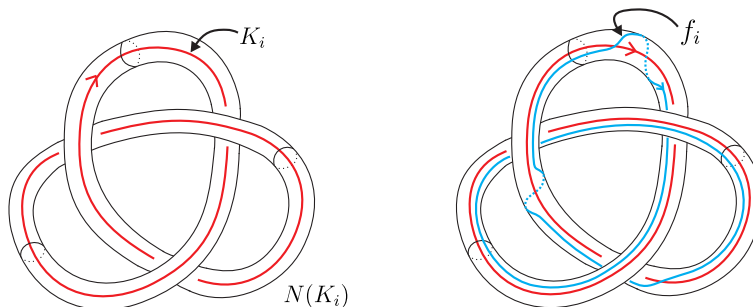

FIGURE 2.2. Tubular neighborhood and framing of the component K_i .

We are interested in framed oriented links up to isotopy. We use the following convention.

Convention 2.2. If L is a framed oriented link, we denote by \mathbf{L} its class modulo isotopy. Reciprocally, if \mathbf{L} is the isotopy class of a framed oriented link, we write L to denote one of its representatives.

2.1.2. *Diagrammatic description of framed oriented links.* An *oriented link diagram* is a planar diagram which may be obtained as a regular projection of an oriented link. Such a diagram gives rise to a framed oriented link by the convention that the framing vector at a given point is contained in the plane of the figure, perpendicular to the tangent vector at this point, and such that the pair (tangent vector, framing vector) gives the counterclockwise orientation of the plane.

By the Reidemeister theorem (see [12]), (oriented) links modulo isotopy can be coded by (oriented) link diagrams modulo planar isotopy and moves denoted RI, RII and RIII. It then follows (see for instance [41, Thm 1.8]) that framed oriented links modulo isotopy are coded by planar diagrams modulo planar isotopy and moves RI', RII and RIII shown in Figure 2.3.

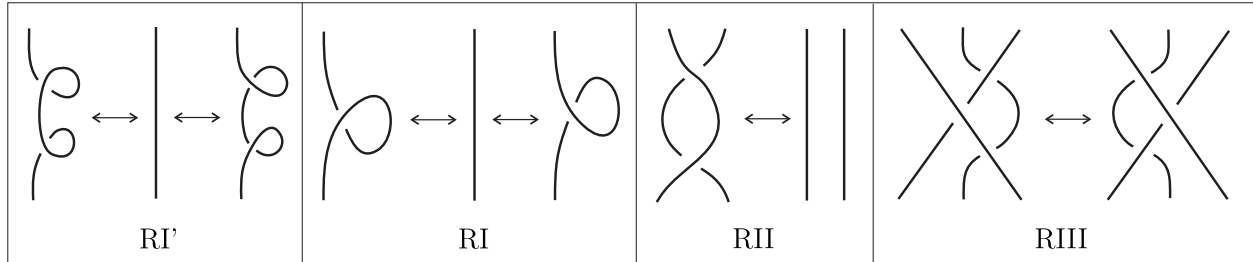

FIGURE 2.3. Reidemeister moves. The orientation is arbitrary.

Summarizing, one gets a commutative diagram

$$\begin{array}{ccc}
 \frac{\{\text{oriented link diagrams}\}}{\text{planar isotopy, RI', RII, RIII}} & \xrightarrow{\sim} & \frac{\{\text{framed oriented links in } S^3\}}{\text{isotopy}} \\
 \downarrow & & \downarrow \\
 \frac{\{\text{oriented link diagrams}\}}{\text{planar isotopy, RI, RII, RIII}} & \xrightarrow{\sim} & \frac{\{\text{oriented links in } S^3\}}{\text{isotopy}}.
 \end{array}$$

The right vertical map decomposes as a disjoint union according to the number l of connected components. For each $l \geq 1$, the group \mathbb{Z}^l acts simply on the source of this map and the quotient identifies with its target.

2.1.3. Linking number. Let K and K' be oriented knots with empty intersection, define the *linking number* $\text{Lk}(K, K') \in \mathbb{Z}$ of K and K' as follows. Consider a diagram of $K \sqcup K'$, denote by $\text{cr}(K, K')$ the set of crossings of the diagram. For each $c \in \text{cr}(K, K')$ associate a sign $\text{sgn}(c) \in \{+1, -1\}$ according to the rule shown in Figure 2.4.



FIGURE 2.4. Sign of crossings.

Set

$$\text{Lk}(K, K') = \frac{1}{2} \sum_{c \in \text{cr}(K, K')} \text{sgn}(c).$$

It can be checked easily that this number is well-defined, i.e., it does not depend on the diagram of $K \sqcup K'$. By definition $\text{Lk}(K, K') = \text{Lk}(K', K)$. For more details and for several equivalent definitions of the linking number we refer to [48, Ch. 5].

For L a framed oriented link, $\pi_0(L)$ is the set of its connected components. For $K \in \pi_0(L)$, define $\text{Lk}(K) := \text{Lk}(K, f_K)$ where f_K is the oriented knot obtaining from K by pushing it along its framing. Then a symmetric matrix $\text{Lk}(L)$ indexed by $\pi_0(L)$ and with integer coefficients is defined by $\text{Lk}(L)_{K, K'} := \text{Lk}(K, K')$ and $\text{Lk}(L)_{K, K} := \text{Lk}(K)$. We call $\text{Lk}(L)$ the *linking matrix* of L . This matrix is an isotopy invariant of the framed oriented link L , therefore we can also write $\text{Lk}(\mathbf{L})$.

2.1.4. *The surgery map.* Let us recall the *Dehn surgery map*

$$(2.1) \quad \frac{\{\text{framed oriented links in } S^3\}}{\text{isotopy}} \longrightarrow \frac{\{\text{closed connected oriented 3-manifolds}\}}{\text{orientation-preserving homeomorphism}}$$

$$L = (L, f) \longmapsto S_L^3$$

(see e.g. [38, Ch. 12] and [48, Ch. 9]). Start with a framed oriented link $L = (L, f) = (K_1 \cup \dots \cup K_l, (f_1, \dots, f_l))$ in S^3 . Let $N(L) = \cup_{i=1}^l N(K_i)$ be a tubular neighborhood of L . For $i \in \llbracket 1, l \rrbracket$, we equip $\partial N(K_i)$ with the orientation induced from that of $S^3 \setminus \text{int}(N(K_i))$ by using the convention of the first normal vector². We identify f_i with a map $S^1 \rightarrow \partial N(K_i)$. We also denote by $m_i : S^1 \rightarrow \partial N(K_i)$ the meridian map, oriented in such a way that (tangent vector of f_i , tangent vector of m_i) gives the opposite orientation of $\partial N(K_i)$.

Recall that $\mathbb{D}^2 \times S^1$ has boundary $S^1 \times S^1$. Let $\ell, m : S^1 \rightarrow S^1 \times S^1$ the maps $x \mapsto (x, *)$ and $x \mapsto (*, x)$, where $*$ is a fixed point in S^1 . For $i \in \llbracket 1, l \rrbracket$, there is a unique (up to isotopy) homeomorphism

$$h_i : \partial(\mathbb{D}^2 \times S^1) \simeq S^1 \times S^1 \longrightarrow \partial N(K_i),$$

such that $h_i \circ \ell = m_i$ and $h_i \circ m = f_i$ (see Figure 2.5). One then sets

$$S_L^3 := (S^3 \setminus \cup_{i=1}^l \text{int}(N(K_i))) \bigcup_{(h_1, \dots, h_l)} (\cup_{i=1}^l (\mathbb{D}^2 \times S^1)).$$

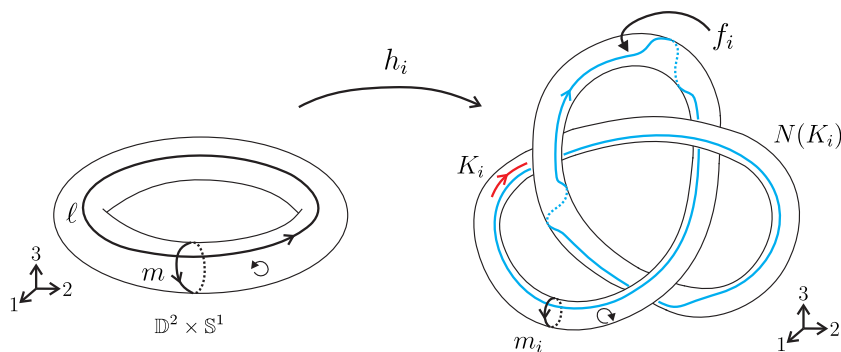

FIGURE 2.5. Attaching map.

The obtained compact oriented 3-manifold S_L^3 does not depend on the isotopy class of L , therefore we can also write S_L^3 .

2.1.5. *Surjectivity and fibers of the surgery map.* According to the Lickorish-Wallace theorem ([37, 58]), the Dehn surgery map (2.1) is surjective.

By contrast, this map is far from being injective. The following theorem allows one to relate the different links giving rise to the same 3-manifold.

Theorem 2.3 ([27]). *Let L and L' be framed oriented links in S^3 . The 3-manifolds S_L^3 and $S_{L'}^3$ are homeomorphic if and only if L and L' are related by a finite sequence of the following moves:*

- 0) *Change of orientation of some components.*
- 1) *Kirby I (KI) move. Starting with a framed oriented link L , perform a disjoint union with the ± 1 -framed unknot (see Figure 2.6).*
- 2) *Kirby I' (KI') move. Inverse operation to KI move.*

²For $p \in \partial N(K_i)$, the orientation of S^3 is a choice of an element of $\pi_0 \text{Iso}(\mathbb{R}, \Lambda^3(T_p S^3))$, therefore in $\pi_0 \text{Iso}(T_p \partial N(K_i)^\perp, \Lambda^2(T_p \partial N(K_i)))$, where $T_p \partial N(K_i)^\perp \subset T_p^* S^3$. An element in $\pi_0 \text{Iso}(\mathbb{R}, T_p \partial N(K_i)^\perp)$ is chosen by taking 1 to a linear form which is positive on vectors pointing outside $S^3 \setminus N(K_i)$ (so inside $N(K_i)$). By composition, this gives an element in $\pi_0 \text{Iso}(\mathbb{R}, \Lambda^2(T_p \partial N(K_i)))$, therefore an orientation of $\partial N(K_i)$.

3) Kirby II (KII) move. Starting with a framed oriented link L , select two different components L_a and L_b . Take a parallel copy of L_b following its framing and label such copy by L_b' . Then, choose a way of performing an orientation-compatible band sum between L_b' and L_a . This results in a new framed oriented link (some examples are shown in Figure 2.7).

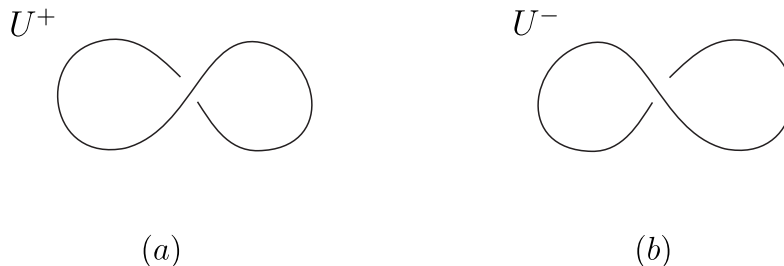

FIGURE 2.6. The ± 1 -framed unknots U^\pm .

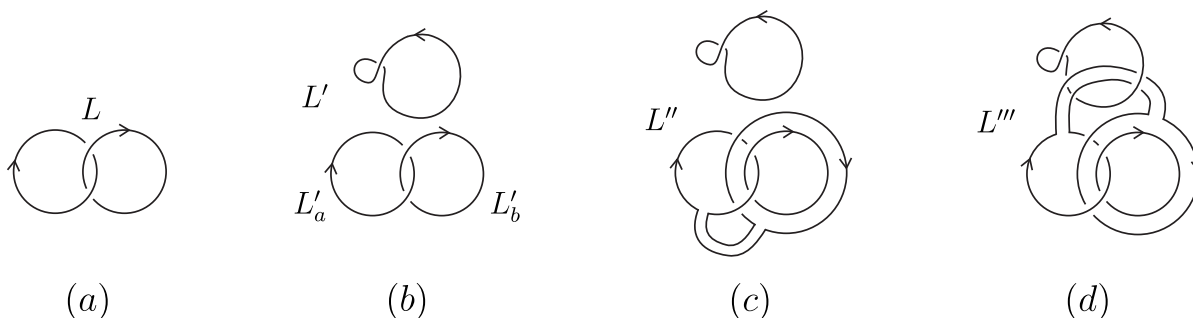

FIGURE 2.7. The link L' is obtained from L by a KI move using a $+1$ -framed unknot. Both L'' and L''' are obtained from L' by a KII move. These moves are based on different ways of performing band sums, which results in L'' and L''' being non-isotopic.

Notice that Theorem 2.3 can be stated replacing framed oriented links by isotopy classes of framed oriented links.

Remark 2.4. By the change of orientation move we can ignore the orientation of the components of a surgery presentation of a 3-manifold.

Example 2.5. Theorem 2.3 can be used to show combinatorially that the 3-manifolds S_H^3 and S^3 are homeomorphic, where H is the 0-framed Hopf link. That is, by means of Kirby moves we can go from the link H to the empty link. See Figure 2.8.

Definition 2.6. (a) Let L and L' be framed oriented links in S^3 . We define the *disjoint union* of L and L' , denoted by $L \dot{\sqcup} L'$, as the framed oriented link in S^3 consisting of L and L' and such that there exists an embedded 3-ball $B \subset S^3$ with $L \in \text{int}(B)$ and $L' \cap B = \emptyset$. This operation does not depend on the isotopy classes of L and L' , therefore we can also write $\mathbf{L} \dot{\sqcup} \mathbf{L}'$.

(b) Let Y and Y' be closed connected oriented 3-manifolds. We define the *connected sum* of Y and Y' , denoted by $Y \# Y'$, as the closed connected oriented 3-manifold $(Y \setminus \text{int}(B)) \sqcup_{\partial B \sim \partial B'} (Y' \setminus \text{int}(B'))$ obtained from Y and Y' by removing the interior of embedded 3-balls $B \subset Y$, $B' \subset Y'$ and identifying the corresponding boundaries with an orientation-compatible gluing map.

The following is straightforward, see for instance [23, 38].

Lemma 2.7. (a) The disjoint union operation $\dot{\sqcup}$ endows the set of isotopy classes of framed oriented links in S^3 with a commutative monoid structure with the (isotopy class of the) empty link as unit element.

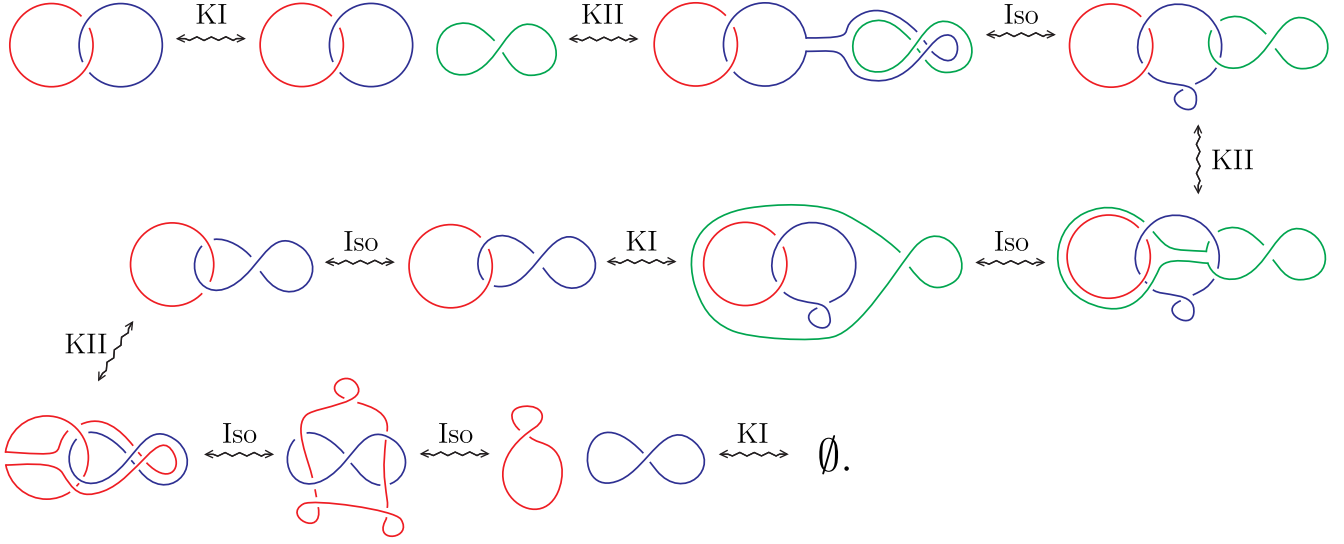

FIGURE 2.8. Combinatorial proof of the homeomorphism between S^3_H and S^3 . In this figure by “Iso” we mean planar isotopies or Reidemeister moves.

(b) The set 3-Mfds of homeomorphism classes of closed connected oriented 3-manifolds has a structure of commutative monoid with product $\#$ given by the connected sum and unit element the homeomorphism class of S^3 .

(c) The surgery map (2.1) defines a monoid homomorphism

$$(2.2) \quad \left(\frac{\{\text{framed oriented links in } S^3\}}{\text{isotopy}}, \sqcup \right) \rightarrow (3\text{-Mfds}, \#),$$

that is, if $Y = S^3_L$ and $Y' = S^3_{L'}$, for some framed oriented links L and L' in S^3 , then $Y \# Y' = S^3_{L \sqcup L'}$. More formally, $[Y \# Y'] = S^3_{L \sqcup L'}$, where $[Y \# Y']$ denotes the homeomorphism class of $Y \# Y'$.

2.2. Framed oriented tangles: basic definitions. In this subsection we introduce the basic terminology about framed oriented tangles as well as some of their operations.

2.2.1. Framed oriented tangles: first operations.

Definition 2.8. A framed (oriented) tangle T is a compact (oriented) 1-manifold properly embedded in the cube $[-1, 1]^3 \subset \mathbb{R}^3$, such that the boundary ∂T (the endpoints of T) is uniformly distributed along $\{0\} \times (-1, 1) \times \{\pm 1\}$ and equipped with a framing which takes the value $-\epsilon_t(0, 1, 0)$ at each endpoint $t \in \partial T$ (for some $\epsilon_t > 0$ enough small). We consider framed (oriented) tangles up to isotopy. We denote by \mathcal{T} and (resp. $\vec{\mathcal{T}}$) the set of framed (resp. framed oriented) tangles up to isotopy. Notice that there is a canonical map $\vec{\mathcal{T}} \rightarrow \mathcal{T}$ which forgets the orientation.

Convention 2.9. If T is a framed (oriented) tangle, we denote by \mathbf{T} its class modulo isotopy. Similarly, if \mathbf{T} is the isotopy class of a framed (oriented) tangle, we denote by T one of its representatives.

Definition 2.10. Let T be a framed tangle.

- Denote by $\partial_b T$ (resp. $\partial_t T$) the subset of ∂T contained in $\{0\} \times [-1, 1] \times \{-1\}$ (resp. in $\{0\} \times [-1, 1] \times \{+1\}$) and call it the *bottom* (resp. *top*) boundary of T . The embedding of ∂T into $\{0\} \times [-1, 1] \times \{\pm 1\}$ allows to equip $\partial_b T$ and $\partial_t T$ with linear orders. We use these orders to identify the elements in $\partial_b T$ with the set $\llbracket 1, |\partial_b T| \rrbracket$ and the elements in $\partial_t T$ with the set $\llbracket 1, |\partial_t T| \rrbracket$.
- Define $\sigma_T \in \text{FPFI}(\llbracket 1, |\partial_b T| \rrbracket \sqcup \llbracket 1, |\partial_t T| \rrbracket)$ by $\sigma(a) = b$ if and only if there exists $C \in \pi_0(T)$ such that $\partial C = \{a, b\}$.

- (c) If moreover T is oriented, we define $B_T \subset \llbracket 1, |\partial_b T| \rrbracket \sqcup \llbracket 1, |\partial_t T| \rrbracket$ to be the image under the identifications $\partial_b T \simeq \llbracket 1, |\partial_b T| \rrbracket$ and $\partial_t T \simeq \llbracket 1, |\partial_t T| \rrbracket$ of the beginning points of ∂T , i.e., the points where the orientation of T is outgoing.

Definition 2.11. (a) Let T be a framed tangle. Define *the underlying Brauer diagram of T* , denoted $\text{br}(T)$, by $\text{br}(T) := (|\partial_b T|, |\partial_t T|, \sigma_T) \in \mathcal{B}r$.

- (b) Let T be a framed oriented tangle. Define *the underlying oriented Brauer diagram of T* , denoted $\vec{\text{br}}(T)$, by $\vec{\text{br}}(T) := ((|\partial_b T|, |\partial_t T|, \sigma_T), B_T) \in \vec{\mathcal{B}}r$.

Lemma 2.12. *There are maps $\text{br} : \mathcal{T} \rightarrow \mathcal{B}r$ and $\vec{\text{br}} : \vec{\mathcal{T}} \rightarrow \vec{\mathcal{B}}r$ taking $\mathbf{T} \in \mathcal{T}$ to $(|\partial_b T|, |\partial_t T|, \sigma_T)$ and $\mathbf{T} \in \vec{\mathcal{T}}$ to $((|\partial_b T|, |\partial_t T|, \sigma_T), B_T)$, where T is a representative of \mathbf{T} . We also denote by br the composite map $\vec{\mathcal{T}} \rightarrow \mathcal{T} \xrightarrow{\text{br}} \mathcal{B}r$.*

Proof. For a framed tangle T , the involution σ_T is invariant under isotopy. Moreover if T is oriented, the set B_T is also invariant under isotopy. That is, the operations br and $\vec{\text{br}}$ are invariant under isotopy. \square

Notation 2.13. Let $\mathbf{T} \in \vec{\mathcal{T}}$. We write $\sigma_{\mathbf{T}}$ for the involution σ_T where T is a representative of \mathbf{T} .

Definition 2.14. Define maps $s, t : \vec{\mathcal{T}} \rightarrow \{+, -\}^*$ as the compositions $\vec{\mathcal{T}} \xrightarrow{\vec{\text{br}}} \vec{\mathcal{B}}r \xrightarrow{s, t} \{+, -\}^*$.

Definition 2.15. (a) Let $p, q \in \mathbb{Z}_{\geq 0}$. Define the set $\mathcal{I}(p, q)$ by

$$\mathcal{I}(p, q) := \{T \mid T \text{ is a framed tangle with } |\partial_b T| = p \text{ and } |\partial_t T| = q\} / \text{isotopy}.$$

- (b) Let $u, v \in \{+, -\}^*$. Define the set $\vec{\mathcal{I}}(u, v)$ by

$$\vec{\mathcal{I}}(u, v) := \{\mathbf{T} \mid \mathbf{T} \text{ is an isotopy class of a framed oriented tangle with } s(\mathbf{T}) = u \text{ and } t(\mathbf{T}) = v\}.$$

Notice that $\mathcal{T} = \bigsqcup_{p, q \geq 0} \mathcal{I}(p, q)$ and $\vec{\mathcal{T}} = \bigsqcup_{u, v \in \{+, -\}^*} \vec{\mathcal{I}}(u, v)$. The maps from Lemma 2.12 restrict to maps $\text{br} : \mathcal{I}(p, q) \rightarrow \vec{\mathcal{B}}r(p, q)$ for any $p, q \in \mathbb{Z}_{\geq 0}$ and to $\vec{\text{br}} : \vec{\mathcal{I}}(u, v) \rightarrow \vec{\mathcal{B}}r(u, v)$ for any $u, v \in \{+, -\}^*$.

Definition 2.16. Let T be a framed (oriented) tangle. We denote by $\pi_0(T)_{\text{cir}}$ (resp. $\pi_0(T)_{\text{seg}}$) the subset of $\pi_0(T)$ consisting of components homeomorphic to the circle S^1 (resp. to the segment $[0, 1]$).

Lemma 2.17. (a) *Let T and T' be framed (oriented) tangles. If T and T' are isotopic, then $\pi_0(T) = \pi_0(T')$, $\pi_0(T)_{\text{cir}} = \pi_0(T')_{\text{cir}}$ and $\pi_0(T)_{\text{seg}} = \pi_0(T')_{\text{seg}}$. We then denote such sets by $\pi_0(\mathbf{T})$, $\pi_0(\mathbf{T})_{\text{cir}}$ and $\pi_0(\mathbf{T})_{\text{seg}}$ respectively.*

- (b) *For $\mathbf{T} \in \vec{\mathcal{T}}$ (or $\mathbf{T} \in \mathcal{T}$), the set $\pi_0(\mathbf{T})_{\text{seg}}$ is canonically identified with the set $\pi_0(\text{br}(\mathbf{T}))$, see Definition 1.22.*

Proof. (a) follows straightforwardly. (b) follows from Lemma 2.12(a) and the definition of $\pi_0(P)$ for a Brauer diagram P , see Definition 1.22. \square

Lemma 2.18. (a) *Let $u, v, z \in \{+, -\}^*$ and $\mathbf{T}_1, \mathbf{T}_2 \in \vec{\mathcal{T}}$ with $s(\mathbf{T}_1) = u$, $t(\mathbf{T}_1) = v = s(\mathbf{T}_2)$, $t(\mathbf{T}_2) = z$. Let T_1 and T_2 be representatives of \mathbf{T}_1 and \mathbf{T}_2 respectively. Let $T_2 \circ T_1$ be the framed oriented tangle obtained from the union of T_1 and T_2 by identifying $\partial_t T_1$ with $\partial_b T_2$ and by rescaling the vertical union of two cubes. The isotopy class of $T_2 \circ T_1$ does not depend on the representatives T_1 and T_2 , we then denote it by $\mathbf{T}_2 \circ \mathbf{T}_1$. We have $s(\mathbf{T}_2 \circ \mathbf{T}_1) = u$ and $t(\mathbf{T}_2 \circ \mathbf{T}_1) = z$.*

- (b) *Let $u, v, u', v' \in \{+, -\}^*$ and $\mathbf{T}_1, \mathbf{T}_2 \in \vec{\mathcal{T}}$ with $s(\mathbf{T}_1) = u$, $t(\mathbf{T}_1) = v$, $s(\mathbf{T}_2) = u'$, $t(\mathbf{T}_2) = v'$. Let T_1 and T_2 be representatives of \mathbf{T}_1 and \mathbf{T}_2 respectively. Let $T_1 \otimes T_2$ be the framed oriented tangle obtained by horizontal juxtaposition and by rescaling the horizontal union of two cubes. The isotopy class of $T_1 \otimes T_2$ does not depend on the representatives T_1 and T_2 , we then denote it by $\mathbf{T}_1 \otimes \mathbf{T}_2$. We have $s(\mathbf{T}_1 \otimes \mathbf{T}_2) = u \cdot u'$ and $t(\mathbf{T}_1 \otimes \mathbf{T}_2) = v \cdot v'$.*

Similar statements hold for the set of non-oriented framed tangles \mathcal{T} .

Proof. The proof follows straightforwardly. \square

2.2.2. Properties of operations on framed oriented tangles.

Lemma 2.19. (a) For any $\mathbf{T}, \mathbf{T}' \in \vec{\mathcal{T}}$ we have

$$\vec{\text{br}}(\mathbf{T} \otimes \mathbf{T}') = \vec{\text{br}}(\mathbf{T}) \otimes \vec{\text{br}}(\mathbf{T}') \quad \text{and} \quad \pi_0(\mathbf{T} \otimes \mathbf{T}')_{\text{cir}} \simeq \pi_0(\mathbf{T})_{\text{cir}} \sqcup \pi_0(\mathbf{T}')_{\text{cir}}.$$

(b) For any composable $\mathbf{T}, \mathbf{T}' \in \vec{\mathcal{T}}$ we have

$$\vec{\text{br}}(\mathbf{T}' \circ \mathbf{T}) = \vec{\text{br}}(\mathbf{T}') \circ_{\vec{\mathcal{B}}r} \vec{\text{br}}(\mathbf{T}) \quad \text{and} \quad \pi_0(\mathbf{T}' \circ \mathbf{T})_{\text{cir}} \simeq \pi_0(\mathbf{T}')_{\text{cir}} \sqcup \pi_0(\mathbf{T})_{\text{cir}} \sqcup \text{Cir}(\vec{\text{br}}(\mathbf{T}'), \vec{\text{br}}(\mathbf{T})),$$

where the set $\text{Cir}(\vec{\text{br}}(\mathbf{T}'), \vec{\text{br}}(\mathbf{T}))$ is as in Definition 1.38.

Similar identities hold for isotopy classes of non-oriented framed tangles.

Proof. The identities clearly hold for framed (oriented) tangles (before taking the quotient by isotopy). Then the result follows from Lemmas 2.12 and 2.17. \square

Definition 2.20. The monoidal category of framed oriented tangles $\vec{\mathcal{T}}$ is defined as follows. The set of objects of $\vec{\mathcal{T}}$ is the free associative monoid $\{+, -\}^*$. For $u, v \in \{+, -\}^*$, the set of morphisms $\vec{\mathcal{T}}(u, v)$ is the set of isotopy classes of framed oriented tangles \mathbf{T} such that $s(\mathbf{T}) = u$ and $t(\mathbf{T}) = v$. Let $z \in \{+, -\}^*$, $\mathbf{T}_1 \in \vec{\mathcal{T}}(u, v)$, $\mathbf{T}_2 \in \vec{\mathcal{T}}(v, z)$. The composition $\mathbf{T}_2 \circ \mathbf{T}_1 \in \vec{\mathcal{T}}(u, z)$ is defined in terms of representatives as in Lemma 2.18(a). The monoidal structure is also defined in terms of representatives as in Lemma 2.18(b).

Lemma 2.21. There is a monoidal functor $\vec{\text{br}} : \vec{\mathcal{T}} \rightarrow \vec{\mathcal{B}}r$ given by the identity on objects and by the map $\vec{\text{br}} : \vec{\mathcal{T}} \rightarrow \vec{\mathcal{B}}r$ from Lemma 2.12 at the level of morphisms.

Proof. The result follows from the combination of Lemmas 2.12, 2.18 and 2.19. \square

2.2.3. The monoid $\vec{\mathcal{T}}(\emptyset, \emptyset)$, 3-manifolds and linking matrices.

Lemma 2.22. We have the following.

- (a) The set $\vec{\mathcal{T}}(\emptyset, \emptyset)$ has two structures of commutative monoid given by composition and \otimes . These two structures coincide with the disjoint union operation from Definition 2.6(a), therefore we will write $(\vec{\mathcal{T}}(\emptyset, \emptyset), \dot{\sqcup})$ for this monoid.
- (b) The map $\vec{\mathcal{T}}(\emptyset, \emptyset) \rightarrow \mathbb{Z}_{\geq 0}$ which takes $\mathbf{L} \in \vec{\mathcal{T}}(\emptyset, \emptyset)$ to $|\pi_0(\mathbf{L})_{\text{cir}}|$ is a monoid homomorphism.
- (c) $\vec{\mathcal{T}}(\emptyset, \emptyset)$ is a $\mathbb{Z}_{\geq 0}$ -graded monoid with decomposition $\vec{\mathcal{T}}(\emptyset, \emptyset) = \bigsqcup_{k \geq 0} \vec{\mathcal{T}}(\emptyset, \emptyset)_k$, where $\vec{\mathcal{T}}(\emptyset, \emptyset)_k$ is the preimage of k under the map in (b).
- (d) There is monoid isomorphism

$$(2.3) \quad \left(\frac{\{\text{framed oriented links in } S^3\}}{\text{isotopy}}, \dot{\sqcup} \right) \simeq (\vec{\mathcal{T}}(\emptyset, \emptyset), \dot{\sqcup}).$$

Proof. (a) follows straightforwardly. (b) follows from the identity $\pi_0(\mathbf{L} \dot{\sqcup} \mathbf{L}') = \pi_0(\mathbf{L}) \sqcup \pi_0(\mathbf{L}')$ for any $\mathbf{L}, \mathbf{L}' \in \vec{\mathcal{T}}(\emptyset, \emptyset)$. The statement in (c) follows from (b) and (d) is straightforward. \square

Remark 2.23. There is a bijection between the nerve $N(\vec{\mathcal{T}})_1$ of the category $\vec{\mathcal{T}}$ and the set $\vec{\mathcal{T}}$.

The composition of (2.2) and (2.3) gives rise to the monoid homomorphism

$$(2.4) \quad (\vec{\mathcal{T}}(\emptyset, \emptyset), \dot{\sqcup}) \longrightarrow (3\text{-Mfds}, \#).$$

in terms of which the Lickorish-Wallace theorem [37, 58] (surjectivity) and Kirby theorem (Theorem 2.3) [27] (description of the kernel) will be reformulated in Proposition 2.74.

For $k \geq 0$ we denote by $\text{Sym}_k(\mathbb{Z})$ the set of $k \times k$ symmetric matrices. We denote by $\text{Sym}_k(\mathbb{Z})/\mathfrak{S}_k$ the set of classes of conjugation by the symmetric group \mathfrak{S}_k . Then $\bigsqcup_{k \geq 0} \text{Sym}_k(\mathbb{Z})/\mathfrak{S}_k$ is a graded monoid with product induced by the direct sum of matrices.

Recall from § 2.1.3 that for a framed oriented link with k components L , its linking matrix $\text{Lk}(L)$ is a symmetric matrix of size $k \times k$.

Lemma 2.24. *There is a graded monoid homomorphism*

$$\text{Lk} : \vec{\mathcal{T}}(\emptyset, \emptyset) \longrightarrow \bigsqcup_{k \geq 0} \text{Sym}_k(\mathbb{Z}) / \mathfrak{S}_k$$

taking the isotopy class \mathbf{L} of a framed oriented link to the conjugacy class of the linking matrix $\text{Lk}(L)$, where L is a representative of \mathbf{L} .

Proof. The result follows from a direct verification. \square

2.2.4. Diagrams of framed (oriented) tangles. An *oriented tangle diagram* is a planar diagram which may be obtained by regular projection from an oriented tangle. Conversely, such a diagram gives rise to an oriented tangle, which can be equipped with a framing by the convention (compatible with that of §2.1.2) that the framing vector at each point is normal to the diagram, contained in the plane of the figure, and oriented to the right (resp. left) at the endpoints of the diagram marked + (resp. -). See Figure 2.9 for a diagram of a framed oriented tangle with its source and target.

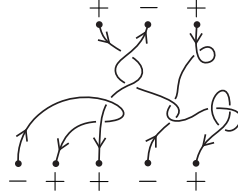

FIGURE 2.9. Oriented tangle diagram representing an element of $\vec{\mathcal{T}}$ with source $- + + - +$ and target $+ - +$.

As in the case of isotopy classes framed oriented links, for working with isotopy classes of framed oriented tangles it is enough to work with their diagrams up to Reidemeister moves, i.e., we have the following bijection:

$$\frac{\{\text{oriented tangle diagrams with blackboard framing}\}}{\text{planar isotopy, RI, RII, RIII}} \simeq \frac{\{\text{framed oriented tangles}\}}{\text{isotopy}}.$$

2.3. Orientation-reversal operation for framed oriented tangles. In this subsection we define an orientation-reversal operation for framed oriented tangles and we study its compatibility with the similar operation for oriented Brauer diagrams. We then introduce the set $\text{CO}\vec{\mathcal{T}} = \bigsqcup_{k \geq 0} \text{CO}\vec{\mathcal{T}}_k$.

Recall from Lemma 2.17 that for $\mathbf{T} \in \vec{\mathcal{T}}$ we have $\pi_0(\mathbf{T}) = \pi_0(\mathbf{T})_{\text{cir}} \sqcup \pi_0(\mathbf{T})_{\text{seg}}$ and $\pi_0(\mathbf{T})_{\text{seg}}$ identifies canonically with $\pi_0(\text{br}(\mathbf{T}))$.

Definition 2.25. Let T be a framed oriented tangle and $c \in \pi_0(T)$. Let $\text{co}_{\vec{\mathcal{T}}}(T, c)$ be the framed oriented tangle obtained from T by changing the orientation of c as well as its framing into their opposites and leaving all other orientations and framings unchanged.

Lemma 2.26. *Let $\mathbf{T} \in \vec{\mathcal{T}}$ and T be a representative of \mathbf{T} . For any $c \in \pi_0(\mathbf{T}) = \pi_0(T)$ (Lemma 2.17) the isotopy class of the framed oriented tangle $\text{co}_{\vec{\mathcal{T}}}(T, c)$ does not depend on the representative T of \mathbf{T} . We denote it by $\text{co}_{\vec{\mathcal{T}}}(\mathbf{T}, c)$.*

Proof. The result follows straightforwardly. \square

Lemma 2.27. *Let $\mathbf{T} \in \vec{\mathcal{T}}$ and $c \in \pi_0(\mathbf{T})$.*

- We have $\pi_0(\text{co}_{\vec{\mathcal{T}}}(\mathbf{T}, c))_{\text{cir}} \simeq \pi_0(\mathbf{T})_{\text{cir}}$.*
- If $c \in \pi_0(\mathbf{T})_{\text{cir}}$, then $\vec{\text{br}}(\text{co}_{\vec{\mathcal{T}}}(\mathbf{T}, c)) = \vec{\text{br}}(\mathbf{T})$.*
- If $c \in \pi_0(\mathbf{T})_{\text{seg}}$, then $\vec{\text{br}}(\text{co}_{\vec{\mathcal{T}}}(\mathbf{T}, c)) = \text{co}_{\vec{\mathcal{B}}_r}(\vec{\text{br}}(\mathbf{T}), c)$. Here we use the identification $\pi_0(\mathbf{T})_{\text{seg}} \simeq \pi_0(\text{br}(\mathbf{T}))$ from Lemma 2.17 (see Definition 1.32 for $\text{co}_{\vec{\mathcal{B}}_r}$).*

Proof. The identities hold for framed oriented tangles (before taking the quotient by isotopy). Then the result follows from Lemmas 2.12, 2.17, and 2.26. \square

Recall the decomposition $\vec{\mathcal{T}}(\emptyset, \emptyset) = \sqcup_{k \geq 0} \vec{\mathcal{T}}(\emptyset, \emptyset)_k$, see Lemma 2.22.

Lemma 2.28. *Let $k \geq 0$ and $\mathbf{T} \in \vec{\mathcal{T}}(\emptyset, \emptyset)_k$, then $\text{co}_{\vec{\mathcal{T}}}(\mathbf{T}, c) \in \vec{\mathcal{T}}(\emptyset, \emptyset)_k$ for any $c \in \pi_0(\mathbf{T})$.*

Proof. The result follows from Lemma 2.26 by using representatives. \square

2.3.1. *The subset $\text{CO}\vec{\mathcal{T}} \subset \vec{\mathcal{T}}(\emptyset, \emptyset) \times \vec{\mathcal{T}}(\emptyset, \emptyset)$. It is clear that if $\mathbf{T} \in \vec{\mathcal{T}}(\emptyset, \emptyset)_k$ (for $k \in \mathbb{Z}_{\geq 1}$) and $c \in \pi_0(\mathbf{T})$ then $\text{co}_{\vec{\mathcal{T}}}(\mathbf{T}, c) \in \vec{\mathcal{T}}(\emptyset, \emptyset)_k$.*

Definition 2.29. For $k \in \mathbb{Z}_{\geq 1}$ define the subset $\text{CO}\vec{\mathcal{T}}_k \subset \vec{\mathcal{T}}(\emptyset, \emptyset)_k \times \vec{\mathcal{T}}(\emptyset, \emptyset)_k$ as

$$(2.5) \quad \text{CO}\vec{\mathcal{T}}_k = \{(\mathbf{T}, \text{co}_{\vec{\mathcal{T}}}(\mathbf{T}, c)) \mid \mathbf{T} \in \vec{\mathcal{T}}(\emptyset, \emptyset)_k, c \in \pi_0(\mathbf{T})\}.$$

We set $\text{CO}\vec{\mathcal{T}}_0 = \emptyset$ and

$$(2.6) \quad \text{CO}\vec{\mathcal{T}} := \bigsqcup_{k \geq 0} \text{CO}\vec{\mathcal{T}}_k = \{(\mathbf{T}, \text{co}_{\vec{\mathcal{T}}}(\mathbf{T}, c)) \mid \mathbf{T} \in \vec{\mathcal{T}}(\emptyset, \emptyset), c \in \pi_0(\mathbf{T})\} \subset \vec{\mathcal{T}}(\emptyset, \emptyset) \times \vec{\mathcal{T}}(\emptyset, \emptyset).$$

2.4. Doubling operations for framed oriented tangles. In this subsection we introduce a doubling operation for framed oriented tangles and study its compatibility with the similar operation for oriented Brauer diagrams.

Definition 2.30. Let T be a framed (oriented) tangle and $X \subset \pi_0(T)_{\text{seg}}$. Let $\text{dbl}_{\vec{\mathcal{T}}}(T, X)$ (also denoted T^X) be the framed (oriented) tangle obtained from T by doubling each of the connected components of T belonging to X along its framing.

Lemma 2.31. *Let $\mathbf{T} \in \vec{\mathcal{T}}$ and T be a representative of \mathbf{T} . For any $X \subset \pi_0(\mathbf{T})_{\text{seg}} = \pi_0(T)_{\text{seg}}$ (Lemma 2.17) the isotopy class of the framed oriented tangle $\text{dbl}_{\vec{\mathcal{T}}}(T, X)$ does not depend on the representative T of \mathbf{T} . We denote it by $\text{dbl}_{\vec{\mathcal{T}}}(\mathbf{T}, X)$.*

Proof. The result is a direct verification. \square

Lemma 2.32. *Let $\mathbf{T} \in \vec{\mathcal{T}}$ and $X \subset \pi_0(\mathbf{T})_{\text{seg}}$.*

- (a) $\pi_0(\text{dbl}_{\vec{\mathcal{T}}}(\mathbf{T}, X))_{\text{cir}} \simeq \pi_0(\mathbf{T})_{\text{cir}}$.
- (b) $\text{br}(\text{dbl}_{\vec{\mathcal{T}}}(\mathbf{T}, X)) = \text{dbl}_{\vec{\mathcal{B}}_r}(\text{br}(\mathbf{T}), X)$. Here we use the identification $\pi_0(\mathbf{T})_{\text{seg}} \simeq \pi_0(\text{br}(\mathbf{T}))$ from Lemma 2.17 (see Definition see Definitions 1.33 and 1.26 for $\text{dbl}_{\vec{\mathcal{B}}_r}$).

Proof. The identities hold for framed oriented tangles (before taking the quotient by isotopy). Then the result follows from Lemmas 2.12, 2.17, and 2.32. \square

Example 2.33. Figure 2.10(a) shows a representative of $\mathbf{T} \in \vec{\mathcal{T}}$ and $X \subset \pi_0(\mathbf{T})_{\text{seg}}$ indicated using thick lines. Figure 2.10(b) shows a representative of $\text{dbl}_{\vec{\mathcal{T}}}(\mathbf{T}, X) \in \vec{\mathcal{T}}$. The image in $\vec{\mathcal{B}}_r$ of these elements under the map br are shown in Figure 1.3(a) and (b) respectively.

2.5. KII map for framed oriented tangles. In this subsection we use the doubling operation from the previous subsection to define a map $\text{KIIMap}_{\vec{\mathcal{T}}}$ which allows us to define the subset $\text{KII}\vec{\mathcal{T}} \subset \vec{\mathcal{T}}(\emptyset, \emptyset) \times \vec{\mathcal{T}}(\emptyset, \emptyset)$.

Definition 2.34. For u one of the elements $+-$ or $-+$ of $\{+, -\}^*$, let $\text{cup}_u^{\mathcal{T}} \in \vec{\mathcal{T}}(\emptyset, u)$ and $\text{cap}_u^{\mathcal{T}} \in \vec{\mathcal{T}}(u, \emptyset)$ be the framed oriented tangles given in Figure 2.11.

Lemma 2.35. *Let $w \in \{+, -\}^*$ be such that $w(1) = \pm(w(2))$ and $\xi \subset \llbracket 1, |w| \rrbracket$ be such that $1 \notin \xi$, $2 \in \xi$. Set*

$$(2.7) \quad e_{w, \xi}^{\vec{\mathcal{T}}} := (\text{cup}_{w(1)w(2)}^{\mathcal{T}} \circ \text{cap}_{w(1)w(2)}^{\mathcal{T}}) \otimes (\otimes_{i=3}^{|w^\xi|} \text{id}_{w^\xi(i)}).$$

Then $e_{w, \xi}^{\vec{\mathcal{T}}} \in \vec{\mathcal{T}}(w^\xi, w^\xi)$, where $w^\xi = \text{dbl}_{\{+, -\}^}(w, \xi)$ is as in Definition 1.40.*

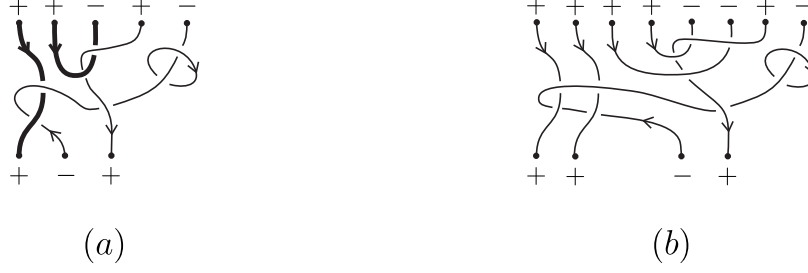

FIGURE 2.10. (a) A representative of an element (\mathbf{T}, X) and (b) a representative of $\text{dbl}_{\vec{\mathcal{T}}}(\mathbf{T}, X)$.



FIGURE 2.11. The elements $\text{cup}_{+-}^{\vec{\mathcal{T}}} \in \vec{\mathcal{I}}(\emptyset, +-)$, $\text{cup}_{-+}^{\vec{\mathcal{T}}} \in \vec{\mathcal{I}}(\emptyset, -+)$, $\text{cap}_{-+}^{\vec{\mathcal{T}}} \in \vec{\mathcal{I}}(-+, \emptyset)$ and $\text{cap}_{+-}^{\vec{\mathcal{T}}} \in \vec{\mathcal{I}}(+-, \emptyset)$.

Proof. By definition of $e_{w,\xi}^{\vec{\mathcal{T}}}$ we have $s(e_{w,\xi}^{\vec{\mathcal{T}}}) = t(e_{w,\xi}^{\vec{\mathcal{T}}}) = w^\xi$. Moreover, $w^\xi(1) = w(1)$ and $w^\xi(2) = w(2)$. \square

Definition 2.36. Let $w \in \{+, -\}^*$, $\mathbf{T} \in \vec{\mathcal{I}}(\emptyset, w)$ and $\mathbf{T}' \in \vec{\mathcal{I}}(w, \emptyset)$. Recall from Definition 2.11 and Lemma 2.12 that $\text{br}(\mathbf{T}) = (0, |w|, \sigma_{\mathbf{T}})$ and $\text{br}(\mathbf{T}') = (|w|, 0, \sigma_{\mathbf{T}'})$ where $\sigma_{\mathbf{T}}, \sigma_{\mathbf{T}'} \in \text{FPFI}(\llbracket 1, |w| \rrbracket)$. We denote by $\sim_{\mathbf{T}, \mathbf{T}'}$ the equivalence relation on $\llbracket 1, |w| \rrbracket$ induced by the action of $\langle \sigma_{\mathbf{T}}, \sigma_{\mathbf{T}'} \rangle$.

Definition 2.37. Set

$$\text{KIIData}_{\vec{\mathcal{T}}} := \left\{ (w, \mathbf{T}, \mathbf{T}', \xi) \left| \begin{array}{l} w \in \{+, -\}^*, w(1) = \pm w(2), \\ \mathbf{T} \in \vec{\mathcal{I}}(\emptyset, w), \mathbf{T}' \in \vec{\mathcal{I}}(w, \emptyset), \\ \xi \in \llbracket 1, |w| \rrbracket / \sim_{\mathbf{T}, \mathbf{T}'}, 1 \notin \xi, 2 \in \xi. \end{array} \right. \right\}.$$

If ξ is an equivalence class for $\sim_{\mathbf{T}, \mathbf{T}'}$, then ξ is a union of orbits for the action of $\langle \sigma_{\mathbf{T}} \rangle$, therefore it defines a subset X_ξ of $\llbracket 1, |w| \rrbracket / \langle \sigma_{\mathbf{T}} \rangle = \pi_0(\text{br}(\mathbf{T}))$. Similarly, ξ defines a subset X'_ξ of $\llbracket 1, |w| \rrbracket / \langle \sigma_{\mathbf{T}'} \rangle = \pi_0(\text{br}(\mathbf{T}'))$. In particular, we have the following association

$$(2.8) \quad \text{KIIData}_{\vec{\mathcal{T}}} \ni (w, \mathbf{T}, \mathbf{T}', \xi) \longmapsto X_\xi \subset \pi_0(\text{br}(\mathbf{T})), \quad X'_\xi \subset \pi_0(\text{br}(\mathbf{T}')).$$

For $(w, \mathbf{T}, \mathbf{T}', \xi) \in \text{KIIData}_{\vec{\mathcal{T}}}$, we have therefore $w \in \{+, -\}^*$ and $\mathbf{T} \in \vec{\mathcal{I}}(\emptyset, w)$ and $\mathbf{T}' \in \vec{\mathcal{I}}(w, \emptyset)$. We set

$$(2.9) \quad \text{KIIMap}_{\vec{\mathcal{T}}}^1(w, \mathbf{T}, \mathbf{T}', \xi) := \mathbf{T}' \circ \mathbf{T} \in \vec{\mathcal{I}}(\emptyset, \emptyset).$$

See Figure 2.12 for a schematic representation using representatives.

Let $(w, \mathbf{T}, \mathbf{T}', \xi) \in \text{KIIData}_{\vec{\mathcal{T}}}$ and $X_\xi \subset \pi_0(\text{br}(\mathbf{T}))$ and $X'_\xi \subset \pi_0(\text{br}(\mathbf{T}'))$ be as in (2.8). By Lemma 1.41, $\mathbf{T}^{X_\xi} \in \vec{\mathcal{I}}(\emptyset, w^\xi)$ and $(\mathbf{T}')^{X'_\xi} \in \vec{\mathcal{I}}(w^\xi, \emptyset)$, where $w^\xi = \text{dbl}_{\{+, -\}^*}(w, \xi)$ is as in Definition 1.40. Moreover, (w, ξ) satisfies the conditions of Lemma 2.35. We set

$$(2.10) \quad \text{KIIMap}_{\vec{\mathcal{T}}}^2(w, \mathbf{T}, \mathbf{T}', \xi) := (\mathbf{T}')^{X'_\xi} \circ e_{w,\xi}^{\vec{\mathcal{T}}} \circ \mathbf{T}^{X_\xi} \in \vec{\mathcal{I}}(\emptyset, \emptyset).$$

See Figure 2.13 for a schematic representation using representatives.

Definition 2.38. (a) Define $\text{KIIMap}_{\vec{\mathcal{T}}}^i$ ($i = 1, 2$) to be the maps $\text{KIIData}_{\vec{\mathcal{T}}} \rightarrow \vec{\mathcal{I}}(\emptyset, \emptyset)$ defined by (2.9) and (2.10). Set

$$\text{KIIMap}_{\vec{\mathcal{T}}} := (\text{KIIMap}_{\vec{\mathcal{T}}}^1, \text{KIIMap}_{\vec{\mathcal{T}}}^2) : \text{KIIData}_{\vec{\mathcal{T}}} \longrightarrow \vec{\mathcal{I}}(\emptyset, \emptyset) \times \vec{\mathcal{I}}(\emptyset, \emptyset).$$

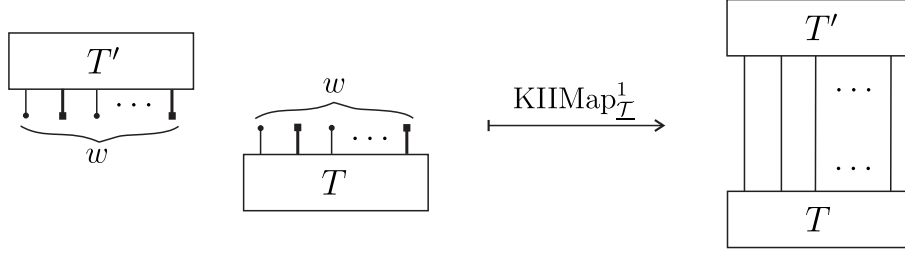

FIGURE 2.12. Schematic representation of $\text{KIIMap}_{\vec{T}}^1(w, \mathbf{T}, \mathbf{T}', \xi) \in \vec{\mathcal{T}}(\emptyset, \emptyset)$ for $(w, \mathbf{T}, \mathbf{T}', \xi) \in \text{KIIData}_{\vec{T}}$ using representatives T and T' of \mathbf{T} and \mathbf{T}' . We use filled squares on the boundary of the tangles to represent ξ and thick lines for representing X_ξ and X'_ξ .

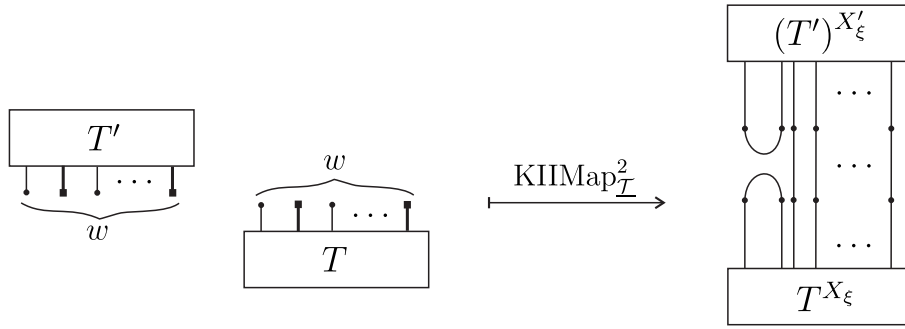

FIGURE 2.13. Schematic representation of $\text{KIIMap}_{\vec{T}}^2(w, \mathbf{T}, \mathbf{T}', \xi) \in \vec{\mathcal{T}}(\emptyset, \emptyset)$ for $(w, \mathbf{T}, \mathbf{T}', \xi) \in \text{KIIData}_{\vec{T}}$ using representatives T and T' of \mathbf{T} and \mathbf{T}' . We use filled squares on the boundary of the tangles to represent ξ and thick lines to represent X_ξ and X'_ξ .

(b) Define the subset $\text{KII}\vec{\mathcal{T}} \subset \vec{\mathcal{T}}(\emptyset, \emptyset) \times \vec{\mathcal{T}}(\emptyset, \emptyset)$ by

$$(2.11) \quad \text{KII}\vec{\mathcal{T}} := \text{Im}(\text{KIIMap}_{\vec{T}}).$$

Example 2.39. Let $(w, \mathbf{T}, \mathbf{T}', \xi) \in \text{KIIData}_{\vec{T}}$, where $w = + - + - + - - + \in \{+, -\}^*$, representatives T and T' of \mathbf{T} and \mathbf{T}' are shown in Figure 2.14(a) and (b) respectively; and $\xi = \{2, 3, 6, 8\} \subset \llbracket 1, 8 \rrbracket$. A representative of $\text{KIIMap}_{\vec{T}}^1(w, \mathbf{T}, \mathbf{T}', \xi) \in \vec{\mathcal{T}}(\emptyset, \emptyset)$ is shown in Figure 2.14(c).

Then $w^\xi = + - - + + - + - - - ++$, and representatives of \mathbf{T}^X and $(\mathbf{T}')^{X'}$ are as in Figure 2.15(a) and (b). Representatives of the elements $e_{(w, \xi)}^{\vec{\mathcal{T}}}$ and $\text{KIIMap}_{\vec{T}}^2(w, \mathbf{T}, \mathbf{T}', \xi)$ are shown in Figure 2.15(c) and (d).

2.6. Alternative description of the image $\text{KII}\vec{\mathcal{T}}$ of the KII map. In §2.5, the set $\text{KII}\vec{\mathcal{T}}$ is defined using the map $\text{KIIMap}_{\vec{T}}$. In this subsection, we give simplified descriptions of this set, first in terms of the category $\vec{\mathcal{T}}$ (Proposition 2.52), then in terms of the category $\mathcal{Pa}\vec{\mathcal{T}}$ of parenthesized tangles (Proposition 2.57). The first description is based on maps

$$\widetilde{\text{KIIMap}}_{\vec{T}, +-}^i \quad \text{and} \quad \widetilde{\text{KIIMap}}_{\vec{T}, -+}^i \quad (i = 1, 2)$$

(see §2.6.1). A map from the source of the disjoint union of these maps to the source of the map $\text{KIIMap}_{\vec{T}}^i$ is constructed in §2.6.2 and a map in the opposite direction is constructed in §2.6.3; the first alternative description of $\text{KII}\vec{\mathcal{T}}$ is then obtained in §2.6.4. In §2.6.5, we introduce the category $\mathcal{Pa}\vec{\mathcal{T}}$ and in §2.6.6,

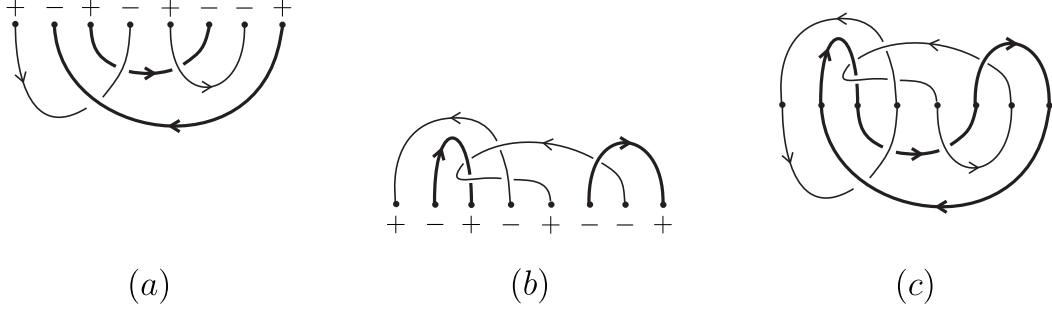

FIGURE 2.14. (a) Representative of $\mathbf{T} \in \vec{\mathcal{T}}(\emptyset, w)$, (b) representative of $\mathbf{T}' \in \vec{\mathcal{T}}(w, \emptyset)$ and (c) representative of $\text{KIIMap}_{\vec{\mathcal{T}}}^1(w, \mathbf{T}, \mathbf{T}', \xi) = \mathbf{T}' \circ \mathbf{T} \in \vec{\mathcal{T}}(\emptyset, \emptyset)$. We use thick lines in (a) and (b) to indicate X_ξ and X'_ξ .

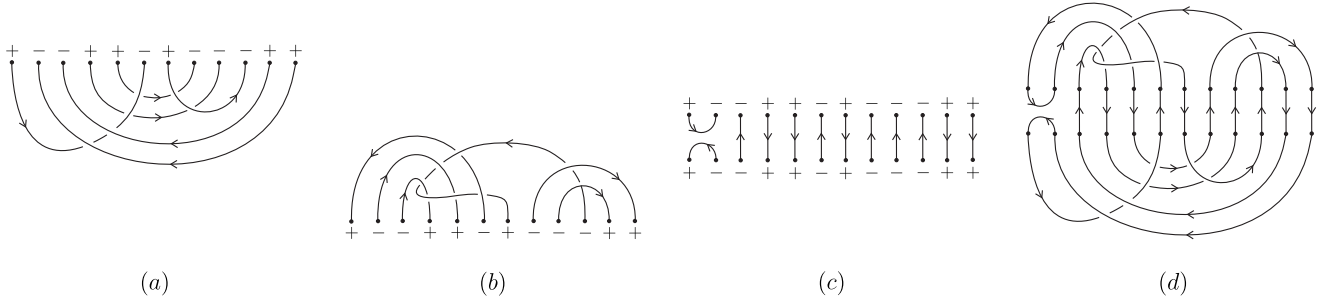

FIGURE 2.15. (a) Representative of $\mathbf{T}^X \in \vec{\mathcal{T}}(\emptyset, w^\xi)$, (b) representative of $(\mathbf{T}')^{X'} \in \vec{\mathcal{T}}(w^\xi, \emptyset)$, (c) representative of $e_{(w, \xi)}^{\vec{\mathcal{T}}} \in \vec{\mathcal{T}}(w^\xi, w^\xi)$, (d) representative of $\text{KIIMap}_{\vec{\mathcal{T}}}^2(w, \mathbf{T}, \mathbf{T}', \xi) = (\mathbf{T}')^{X'_\xi} \circ e_{(w, \xi)}^{\vec{\mathcal{T}}} \circ \mathbf{T}^{X_\xi} \in \vec{\mathcal{T}}(\emptyset, \emptyset)$.

we obtain the description of $\text{KII}\vec{\mathcal{T}}$ in terms of maps

$$\widetilde{\text{KIIMap}}_{\mathcal{P}a\vec{\mathcal{T}}, +-}^i \quad \text{and} \quad \widetilde{\text{KIIMap}}_{\mathcal{P}a\vec{\mathcal{T}}, -+}^i \quad (i = 1, 2)$$

involving elementary generators of this category.

2.6.1. Maps $\widetilde{\text{KIIMap}}_{\vec{\mathcal{T}}, +-}^i : \vec{\mathcal{T}}(\downarrow\uparrow) \rightarrow \vec{\mathcal{T}}(\emptyset, \emptyset)$ and $\widetilde{\text{KIIMap}}_{\vec{\mathcal{T}}, -+}^i : \vec{\mathcal{T}}(\uparrow\downarrow) \rightarrow \vec{\mathcal{T}}(\emptyset, \emptyset)$ for $i = 1, 2$.

Definition 2.40. Let $P \in \vec{\mathcal{B}}r$. Define the subset $\vec{\mathcal{T}}(P)$ of $\vec{\mathcal{T}}$ as the preimage of P under the map $\text{br} : \vec{\mathcal{T}} \rightarrow \vec{\mathcal{B}}r$ (see Lemma 2.12).

Notation 2.41. From now on we use the following notation: $\downarrow := \text{Id}_+ \in \vec{\mathcal{B}}r(+, +)$, $\uparrow := \text{Id}_- \in \vec{\mathcal{B}}r(-, -)$. Then for $\epsilon_1, \dots, \epsilon_n \in \{+, -\}$, one has $\text{Id}_{\epsilon_1 \dots \epsilon_n} = \text{ar}_1 \otimes \dots \otimes \text{ar}_n \in \vec{\mathcal{B}}r(\epsilon_1 \dots \epsilon_n, \epsilon_1 \dots \epsilon_n)$ (denoted $\text{ar}_1 \dots \text{ar}_n$) where $\text{ar}_i \in \{\downarrow, \uparrow\}$ is given by $\text{ar}_i = \downarrow$ if $\epsilon_i = +$ and $\text{ar}_i = \uparrow$ if $\epsilon_i = -$. For instance, $\downarrow\uparrow = \text{Id}_{+-} \in \vec{\mathcal{B}}r(+-, +-)$ and $\uparrow\downarrow = \text{Id}_{-+} \in \vec{\mathcal{B}}r(-+, -+)$.

Definition 2.42. Define maps

$$(2.12) \quad \widetilde{\text{KIIMap}}_{\vec{\mathcal{T}}, +-}^1 : \vec{\mathcal{T}}(\downarrow\uparrow) \rightarrow \vec{\mathcal{T}}(\emptyset, \emptyset) \quad \text{and} \quad \widetilde{\text{KIIMap}}_{\vec{\mathcal{T}}, -+}^1 : \vec{\mathcal{T}}(\uparrow\downarrow) \rightarrow \vec{\mathcal{T}}(\emptyset, \emptyset)$$

as the restrictions of the maps

$$(2.13) \quad \widetilde{\text{KIIMap}}_{\vec{\mathcal{T}}, +-}^1 : \vec{\mathcal{T}}(+-, +-) \rightarrow \vec{\mathcal{T}}(\emptyset, \emptyset) \quad \text{and} \quad \widetilde{\text{KIIMap}}_{\vec{\mathcal{T}}, -+}^1 : \vec{\mathcal{T}}(-+, -+) \rightarrow \vec{\mathcal{T}}(\emptyset, \emptyset)$$

given by

$$(2.14) \quad \widetilde{\text{KIIMap}}_{\vec{\mathcal{T}},+-}^1(\mathbf{S}) = \text{cap}_{+-}^{\mathcal{T}} \circ (\text{Id}_+ \otimes \text{cap}_{-+}^{\mathcal{T}} \otimes \text{Id}_-) \circ (\text{Id}_{+-} \otimes \mathbf{S}) \circ (\text{Id}_+ \otimes \text{cup}_{-+}^{\mathcal{T}} \otimes \text{Id}_-) \circ \text{cup}_{+-}^{\mathcal{T}}$$

for $\mathbf{S} \in \vec{\mathcal{T}}(+-,+-)$. See Figure 2.16 for a schematic representation of $\widetilde{\text{KIIMap}}_{\vec{\mathcal{T}},+-}^1$ using representatives. The map $\widetilde{\text{KIIMap}}_{\vec{\mathcal{T}},-+}^1$ is defined similarly by permuting in this formula the subscripts $+$ and $-$. These maps are well-defined since $\vec{\mathcal{T}}$ is a category.

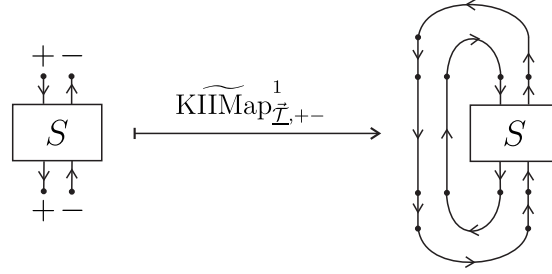

FIGURE 2.16. Schematic representation of the map $\widetilde{\text{KIIMap}}_{\vec{\mathcal{T}},+-}^1$ using representatives.

Lemma 2.43. *Let $\mathbf{S} \in \vec{\mathcal{T}}(\downarrow\uparrow) \subset \vec{\mathcal{T}}(+-,+-)$. Let $c_\downarrow \in \pi_0(\mathbf{S})_{\text{seg}}$ be the connected component corresponding to \downarrow in $\text{br}(\mathbf{S}) = \downarrow\uparrow$. Then the expression*

$$(2.15) \quad \widetilde{\text{KIIMap}}_{\vec{\mathcal{T}},+-}^2(\mathbf{S}) := (\text{cap}_{-+}^{\mathcal{T}} \otimes \text{cap}_{+-}^{\mathcal{T}}) \circ (\text{Id}_- \otimes \text{dbl}_{\vec{\mathcal{T}}}(S, c_\downarrow)) \circ (\text{cup}_{-+}^{\mathcal{T}} \otimes \text{cup}_{+-}^{\mathcal{T}})$$

is well-defined and belongs to $\vec{\mathcal{T}}(\emptyset, \emptyset)$. See Figure 2.17 for a schematic representation of $\widetilde{\text{KIIMap}}_{\vec{\mathcal{T}},+-}^2(\mathbf{S})$ using representatives. Similarly, for $\mathbf{S} \in \vec{\mathcal{T}}(\uparrow\downarrow)$ the element $\widetilde{\text{KIIMap}}_{\vec{\mathcal{T}},-+}^2(\mathbf{S})$ defined as in the right-hand

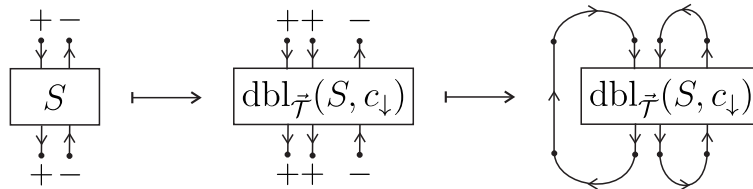

FIGURE 2.17. Schematic representation of the map $\widetilde{\text{KIIMap}}_{\vec{\mathcal{T}},+-}^2$ using representatives.

side of (2.15) but permuting the subscripts $+$ and $-$ belongs to $\vec{\mathcal{T}}(\emptyset, \emptyset)$.

Proof. Let us consider the case $+-$. Let $\mathbf{S} \in \vec{\mathcal{T}}(\downarrow\uparrow) \subset \vec{\mathcal{T}}(+-,+-)$. By Lemma 2.32(b), we have $\text{dbl}_{\vec{\mathcal{T}}}(S, c_\downarrow) \in \vec{\mathcal{T}}(\downarrow\uparrow) \subset \vec{\mathcal{T}}(++-,++-)$, then the result follows since $\vec{\mathcal{T}}$ is a monoidal category. \square

Definition 2.44. Define the maps

$$(2.16) \quad \widetilde{\text{KIIMap}}_{\vec{\mathcal{T}},+-}^2 : \vec{\mathcal{T}}(\downarrow\uparrow) \longrightarrow \vec{\mathcal{T}}(\emptyset, \emptyset) \quad \text{and} \quad \widetilde{\text{KIIMap}}_{\vec{\mathcal{T}},-+}^2 : \vec{\mathcal{T}}(\uparrow\downarrow) \longrightarrow \vec{\mathcal{T}}(\emptyset, \emptyset)$$

by mapping $\mathbf{S} \in \vec{\mathcal{T}}(\downarrow\uparrow)$ to $\widetilde{\text{KIIMap}}_{\vec{\mathcal{T}},+-}^2(\mathbf{S}) \in \vec{\mathcal{T}}(\emptyset, \emptyset)$ and $\mathbf{S} \in \vec{\mathcal{T}}(\uparrow\downarrow)$ to $\widetilde{\text{KIIMap}}_{\vec{\mathcal{T}},-+}^2(\mathbf{S}) \in \vec{\mathcal{T}}(\emptyset, \emptyset)$ given as in Lemma 2.43.

2.6.2. Maps $\varphi_{+-} : \vec{\mathcal{T}}(\downarrow\uparrow) \rightarrow \text{KIIData}_{\vec{\mathcal{T}},+-}$ and $\varphi_{-+} : \vec{\mathcal{T}}(\uparrow\downarrow) \rightarrow \text{KIIData}_{\vec{\mathcal{T}},-+}$. Notice that the set $\text{KIIData}_{\vec{\mathcal{T}}}$ can be decomposed as the disjoint union

$$\text{KIIData}_{\vec{\mathcal{T}}} = \text{KIIData}_{\vec{\mathcal{T}},+-} \sqcup \text{KIIData}_{\vec{\mathcal{T}},-+}$$

where $\text{KIIData}_{\vec{\mathcal{T}},+-}$ (resp. $\text{KIIData}_{\vec{\mathcal{T}},-+}$) consists of the quadruples $(w, \mathbf{T}, \mathbf{T}', \xi)$ with $w(1) = +$ (resp. $w(1) = -$).

Definition 2.45. Define maps

$$(2.17) \quad \varphi_{1,+-} : \vec{\mathcal{I}}(+-,+-) \longrightarrow \vec{\mathcal{I}}(+ - +-, \emptyset) \quad \text{and} \quad \varphi_{1,-+} : \vec{\mathcal{I}}(-+, -+) \longrightarrow \vec{\mathcal{I}}(- + -+, \emptyset)$$

by

$$\varphi_{1,+-}(\mathbf{S}) = \text{cap}_{+-}^{\mathcal{T}} \circ (\text{Id}_+ \otimes \text{cap}_{-+}^{\mathcal{T}} \otimes \text{Id}_-) \circ (\text{Id}_{+-} \otimes \mathbf{S})$$

for $\mathbf{S} \in \vec{\mathcal{I}}(+-,+-)$. The map $\varphi_{1,-+}$ is defined similarly by permuting in this formula the subscripts $+$ and $-$. In Figure 2.18(a) we give a schematic representation of $\varphi_{1,+-}$ using representatives.

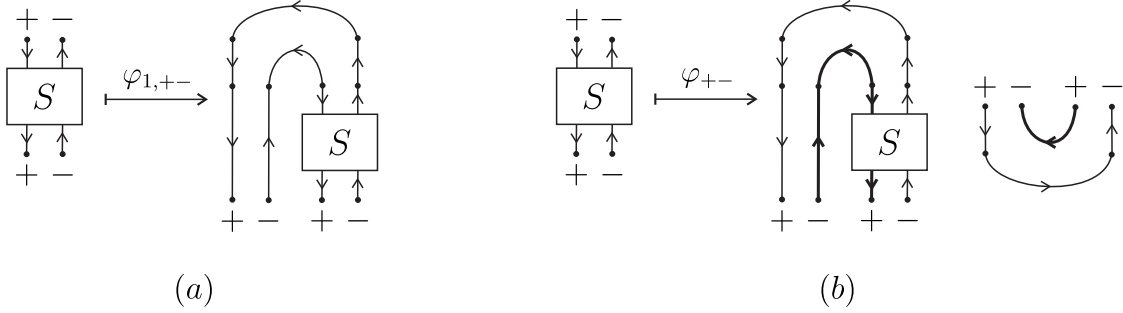

FIGURE 2.18. (a) Schematic representation of $\varphi_{1,+-}(\mathbf{S}) \in \vec{\mathcal{I}}(+ - +-, \emptyset)$ for $\mathbf{S} \in \vec{\mathcal{I}}(+-,+-)$, (b) schematic representation of representatives of \mathbf{T}' and \mathbf{T} and $\varphi_{+-}(\mathbf{S}) = (w, \mathbf{T}, \mathbf{T}', \xi) \in \text{KIIData}_{\vec{\mathcal{T}},+-}$ for $\mathbf{S} \in \vec{\mathcal{T}}(\downarrow\uparrow)$, where $w := + - + -$ and $\xi := \{2, 3\}$.

Lemma 2.46. Let $\mathbf{S} \in \vec{\mathcal{T}}(\downarrow\uparrow) \subset \vec{\mathcal{I}}(+-,+-)$. Let $\mathbf{T}' := \varphi_{1,+-}(\mathbf{S})$ and $\mathbf{T} := (\text{Id}_+ \otimes \text{cup}_{-+}^{\mathcal{T}} \otimes \text{Id}_-) \circ \text{cup}_{+-}^{\mathcal{T}}$. Then $\varphi_{+-}(\mathbf{S}) := (+ - +-, \mathbf{T}, \mathbf{T}', \{2, 3\}) \in \text{KIIData}_{\vec{\mathcal{T}},+-}$. Therefore, this defines a map

$$(2.18) \quad \varphi_{+-} : \vec{\mathcal{T}}(\downarrow\uparrow) \longrightarrow \text{KIIData}_{\vec{\mathcal{T}},+-}$$

We give a schematic representation of the map φ_{+-} in Figure 2.18(b) using representatives. Similarly, for $\mathbf{S} \in \vec{\mathcal{T}}(\uparrow\downarrow)$, let $\mathbf{T}' := \varphi_{1,-+}(\mathbf{S})$ and $\mathbf{T} := (\text{Id}_- \otimes \text{cup}_{+-}^{\mathcal{T}} \otimes \text{Id}_+) \circ \text{cup}_{-+}^{\mathcal{T}}$. Then $\varphi_{-+}(\mathbf{S}) := (- + -+, \mathbf{T}, \mathbf{T}', \{2, 3\}) \in \text{KIIData}_{\vec{\mathcal{T}},-+}$. Therefore, this defines a map

$$(2.19) \quad \varphi_{-+} : \vec{\mathcal{T}}(\uparrow\downarrow) \longrightarrow \text{KIIData}_{\vec{\mathcal{T}},-+}$$

Proof. We prove the statement for φ_{+-} . Let $\mathbf{S} \in \vec{\mathcal{T}}(\downarrow\uparrow)$ and $\varphi_{+-}(\mathbf{S}) = (w, \mathbf{T}, \mathbf{T}', \xi)$ with $w := + - + -$ and $\xi := \{2, 3\}$. We have $w(1) = + = \pm(-) = \pm(w(2))$, $\mathbf{T} \in \vec{\mathcal{I}}(\emptyset, w)$, $\mathbf{T}' \in \vec{\mathcal{I}}(w, \emptyset)$, $1 \notin \xi$, $2 \in \xi$. Moreover, by definition of \mathbf{T} and \mathbf{T}' , we have that $2 \sim_{\mathbf{T}, \mathbf{T}'} 3$, so that ξ is one equivalence class of $\sim_{\mathbf{T}, \mathbf{T}'}$. All this proves that $(w, \mathbf{T}, \mathbf{T}', \xi) \in \text{KIIData}_{\vec{\mathcal{T}}}$, see Definition 2.37. Since $w(1) = +$, then $(w, \mathbf{T}, \mathbf{T}', \xi) \in \text{KIIData}_{\vec{\mathcal{T}},+-}$. \square

2.6.3. Maps $\psi_{+-} : \text{KIIData}_{\vec{\mathcal{T}},+-} \rightarrow \vec{\mathcal{T}}(\downarrow\uparrow)$ and $\psi_{-+} : \text{KIIData}_{\vec{\mathcal{T}},-+} \rightarrow \vec{\mathcal{T}}(\uparrow\downarrow)$.

Definition 2.47. For $w \in \{+, -\}^*$ we define maps

$$(2.20) \quad \psi_{1,+-} : \vec{\mathcal{I}}(+ - \otimes w, \emptyset) \longrightarrow \vec{\mathcal{I}}(w, +-) \quad \text{and} \quad \psi_{1,-+} : \vec{\mathcal{I}}(- + \otimes w, \emptyset) \longrightarrow \vec{\mathcal{I}}(w, -+)$$

by

$$\psi_{1,+-}(\mathbf{T}') := (\text{Id}_{+-} \otimes \mathbf{T}') \circ (\text{Id}_+ \otimes \text{cup}_{-+}^{\mathcal{T}} \otimes \text{Id}_- \otimes \text{Id}_w) \circ (\text{cup}_{+-}^{\mathcal{T}} \otimes \text{Id}_w) \in \vec{\mathcal{I}}(w, +-),$$

for any $\mathbf{T}' \in \vec{\mathcal{I}}(+ - \otimes w, \emptyset)$, the tangle representatives of the elements $\text{cup}_{+-}^{\mathcal{T}}$ and $\text{cup}_{-+}^{\mathcal{T}}$ are shown in Figure 2.11. The map $\psi_{1,-+}$ is defined similarly by permuting in this formula the subscripts $+$ and $-$. In Figure 2.19(a) we give a schematic representation of the map $\psi_{1,+ -}$ using representatives.

Definition 2.48. For $w \in \{+, -\}^*$ we define maps

$$(2.21) \quad \psi_{2,+ -} : \vec{\mathcal{I}}(\emptyset, + - \otimes w) \longrightarrow \vec{\mathcal{I}}(+ -, w) \quad \text{and} \quad \psi_{2,- +} : \vec{\mathcal{I}}(\emptyset, - + \otimes w) \longrightarrow \vec{\mathcal{I}}(- +, w)$$

by

$$\psi_{2,+ -}(\mathbf{T}) := (\text{cap}_{+-}^{\mathcal{T}} \otimes \text{Id}_w) \circ (\text{Id}_+ \otimes \text{cap}_{-+}^{\mathcal{T}} \otimes \text{Id}_- \otimes \text{Id}_w) \circ (\text{Id}_{+-} \otimes \mathbf{T}) \in \vec{\mathcal{I}}(+ -, w)$$

for any $\mathbf{T} \in \vec{\mathcal{I}}(\emptyset, + - \otimes w)$, the tangle representatives of the elements $\text{cap}_{+-}^{\mathcal{T}}$ and $\text{cap}_{-+}^{\mathcal{T}}$ are shown in Figure 2.11. The map $\psi_{2,+ -}$ is defined similarly by permuting in this formula the subscripts $+$ and $-$. In Figure 2.19(b) we give a schematic representation of the map $\psi_{2,+ -}$ using representatives.

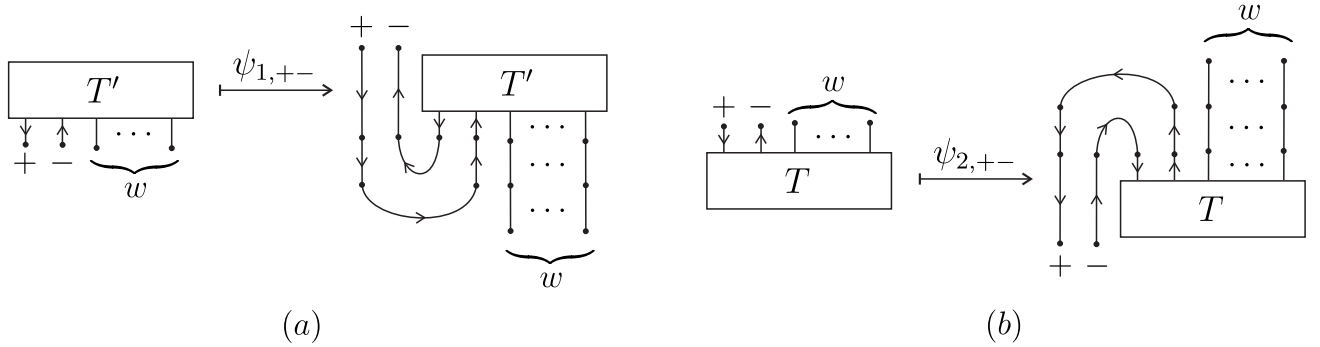

FIGURE 2.19. Let $w \in \{+, -\}^*$ and $\mathbf{T}' \in \vec{\mathcal{I}}(+ - \otimes w, \emptyset)$, $\mathbf{T} \in \vec{\mathcal{I}}(\emptyset, + - \otimes w)$ with tangle representatives T' and T . We show in (a) a schematic representation of a representative of $\psi_{1,+ -}(\mathbf{T}') \in \vec{\mathcal{I}}(w, + -)$ and in (b) a schematic representation of a representative of $\psi_{2,+ -}(\mathbf{T}) \in \vec{\mathcal{I}}(+ -, w)$.

Lemma 2.49. *The maps*

$$\psi_{+-} : \text{KIIData}_{\vec{\mathcal{T}}, +-} \longrightarrow \vec{\mathcal{I}}(+ -, +-) \quad \text{and} \quad \psi_{-+} : \text{KIIData}_{\vec{\mathcal{T}}, -+} \longrightarrow \vec{\mathcal{I}}(- +, - +)$$

defined by

$$\psi_{+-}(w, \mathbf{T}, \mathbf{T}', \xi) = \psi_{1,+ -}(\mathbf{T}') \circ \psi_{2,+ -}(\mathbf{T}) \quad \text{and} \quad \psi_{-+}(\tilde{w}, \mathbf{S}, \mathbf{S}', \tilde{\xi}) = \psi_{1,- +}(\mathbf{S}') \circ \psi_{2,- +}(\mathbf{S})$$

for $(w, \mathbf{T}, \mathbf{T}', \xi) \in \text{KIIData}_{\vec{\mathcal{T}}, +-}$ and $(\tilde{w}, \mathbf{S}, \mathbf{S}', \tilde{\xi}) \in \text{KIIData}_{\vec{\mathcal{T}}, -+}$, take values in $\vec{\mathcal{T}}(\downarrow \uparrow)$ and $\vec{\mathcal{T}}(\uparrow \downarrow)$, respectively. Therefore we have maps

$$(2.22) \quad \psi_{+-} : \text{KIIData}_{\vec{\mathcal{T}}, +-} \longrightarrow \vec{\mathcal{T}}(\downarrow \uparrow) \quad \text{and} \quad \psi_{-+} : \text{KIIData}_{\vec{\mathcal{T}}, -+} \longrightarrow \vec{\mathcal{T}}(\uparrow \downarrow).$$

In Figure 2.20 we show a schematic representation of the map ψ_{+-} using representatives.

Proof. Let us prove the statement for ψ_{+-} . Let $(w, \mathbf{T}, \mathbf{T}', \xi) \in \text{KIIData}_{\vec{\mathcal{T}}, +-}$, by definition

$$\psi_{+-}(w, \mathbf{T}, \mathbf{T}', \xi) \in \vec{\mathcal{I}}(+ -, +-).$$

Therefore, $\vec{\text{br}}(\psi_{+-}(w, \mathbf{T}, \mathbf{T}', \xi)) \in \vec{\mathcal{B}}\mathcal{R}(+-, +-)$. That is, $\vec{\text{br}}(\psi_{+-}(w, \mathbf{T}, \mathbf{T}', \xi)) = ((2, 2, \tau), \{\bar{1}, 2\})$ and $\tau \in \text{FPFI}(\llbracket 1, 2 \rrbracket \sqcup \llbracket 1, 2 \rrbracket)$. There are two possibilities, either $\tau(1) = \bar{1}$ and $\tau(2) = 2$, or $\tau(1) = 2$ and $\tau(\bar{1}) = 2$. The latter case is discarded since $1, 2 \in \llbracket 1, |w| \rrbracket$ are unrelated by $\sim_{\mathbf{T}, \mathbf{T}'}$. Therefore, $\vec{\text{br}}(\psi_{+-}(w, \mathbf{T}, \mathbf{T}', \xi)) = \downarrow \uparrow$. \square

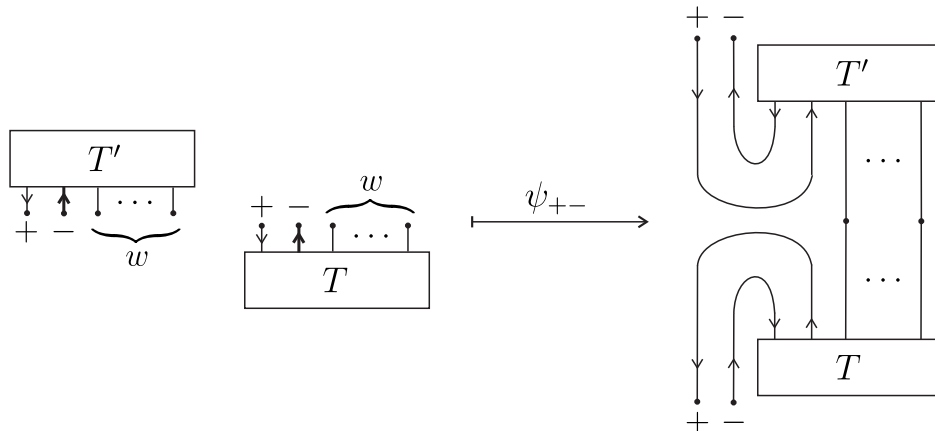

FIGURE 2.20. Schematic representation of $\psi_{+-}(w, \mathbf{T}, \mathbf{T}', \xi) \in \vec{\mathcal{T}}(+-, +-)$ using representatives.

2.6.4. Relation between the two versions of the KII map.

Lemma 2.50. *The following diagrams are commutative*

$$\begin{array}{ccc}
 \text{KIIData}_{\vec{\mathcal{T}}, +-} & \xrightarrow{(\text{KIIMap}_{\vec{\mathcal{T}}}^1, \text{KIIMap}_{\vec{\mathcal{T}}}^2)} & \vec{\mathcal{T}}(\emptyset, \emptyset)^2 \\
 \psi_{+-} \downarrow & \nearrow & \\
 \vec{\mathcal{T}}(\downarrow\uparrow) & \xrightarrow{(\widetilde{\text{KIIMap}}_{\vec{\mathcal{T}}, +-}^1, \widetilde{\text{KIIMap}}_{\vec{\mathcal{T}}, +-}^2)} & \vec{\mathcal{T}}(\emptyset, \emptyset)^2
 \end{array}
 \quad \text{and} \quad
 \begin{array}{ccc}
 \text{KIIData}_{\vec{\mathcal{T}}, +-} & \xrightarrow{(\text{KIIMap}_{\vec{\mathcal{T}}}^1, \text{KIIMap}_{\vec{\mathcal{T}}}^2)} & \vec{\mathcal{T}}(\emptyset, \emptyset)^2 \\
 \uparrow \varphi_{+-} & \nearrow & \\
 \vec{\mathcal{T}}(\downarrow\uparrow) & \xrightarrow{(\widetilde{\text{KIIMap}}_{\vec{\mathcal{T}}, +-}^1, \widetilde{\text{KIIMap}}_{\vec{\mathcal{T}}, +-}^2)} & \vec{\mathcal{T}}(\emptyset, \emptyset)^2
 \end{array}$$

We also have two similar commutative diagrams involving $\text{KIIData}_{\vec{\mathcal{T}}, -+}$ and the maps $\widetilde{\text{KIIMap}}_{\vec{\mathcal{T}}, -+}^1$, $\widetilde{\text{KIIMap}}_{\vec{\mathcal{T}}, -+}^2$.

Proof. Let us treat the case $+-$. Let $(w, \mathbf{T}, \mathbf{T}', \xi) \in \text{KIIData}_{\vec{\mathcal{T}}, +-}$. We work with tangle representatives. Recall the schematic representation of $\psi_{+-}(w, \mathbf{T}, \mathbf{T}', \xi)$ shown in Figure 2.20. Using the schematic representation of the $\widetilde{\text{KIIMap}}_{\vec{\mathcal{T}}, +-}^1$ (see Figure 2.16) we obtain a schematic representation of

$$\widetilde{\text{KIIMap}}_{\vec{\mathcal{T}}, +-}^1(\psi_{+-}(w, \mathbf{T}, \mathbf{T}', \xi))$$

shown in Figure 2.21(a). Besides, in Figure 2.12 we show the schematic representation of

$$\text{KIIMap}_{\vec{\mathcal{T}}}^1(w, \mathbf{T}, \mathbf{T}'\xi).$$

These two tangles representatives are isotopic in S^3 , which proves the equality

$$\widetilde{\text{KIIMap}}_{\vec{\mathcal{T}}, +-}^1(\psi_{+-}(w, \mathbf{T}, \mathbf{T}', \xi)) = \text{KIIMap}_{\vec{\mathcal{T}}}^1(w, \mathbf{T}, \mathbf{T}'\xi).$$

Similarly, by using the schematic representations of $\psi_{+-}(w, \mathbf{T}, \mathbf{T}', \xi)$ (Figure 2.20) and of the map $\widetilde{\text{KIIMap}}_{\vec{\mathcal{T}}, +-}^2$ (Figure 2.17), we obtain a schematic representation of a tangle representative of the element $\widetilde{\text{KIIMap}}_{\vec{\mathcal{T}}, +-}^2(\psi_{+-}(w, \mathbf{T}, \mathbf{T}', \xi))$ shown in Figure 2.21(b), besides we showed a schematic representation of $\text{KIIMap}_{\vec{\mathcal{T}}}^2(w, \mathbf{T}, \mathbf{T}'\xi)$ in Figure 2.13. These two tangles are isotopic in S^3 , which proves the equality $\widetilde{\text{KIIMap}}_{\vec{\mathcal{T}}, +-}^2(\psi_{+-}(w, \mathbf{T}, \mathbf{T}', \xi)) = \text{KIIMap}_{\vec{\mathcal{T}}}^2(w, \mathbf{T}, \mathbf{T}'\xi)$. Therefore we have the commutativity of the left diagram.

Now, let $\mathbf{S} \in \vec{\mathcal{T}}(\downarrow\uparrow)$. In Figure 2.18(b) we showed a schematic representation of a tangle representative of $\varphi_{+-}(\mathbf{S}) = (w, \mathbf{T}, \mathbf{T}', \xi) \in \text{KIIData}_{\vec{\mathcal{T}}, +-}$. In Figure 2.22(a) we show the schematic representation of a tangle

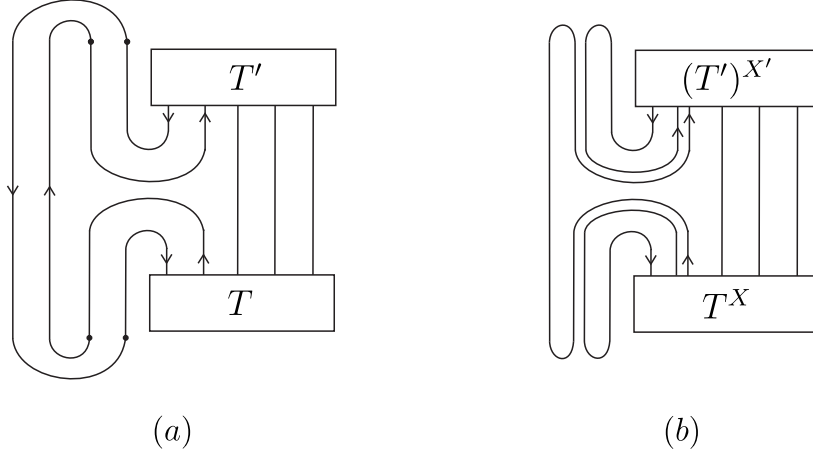

FIGURE 2.21. (a) Schematic representation of a tangle representative of $\widetilde{\text{KIIMap}}_{\underline{T},+}^1(\psi_{+-}(w, \mathbf{T}, \mathbf{T}', \xi))$, (b) schematic representation of a tangle representative of $\widetilde{\text{KIIMap}}_{\underline{T},+}^2(\psi_{+-}(w, \mathbf{T}, \mathbf{T}, \xi))$.

representative of $\text{KIIMap}_{\underline{T}}^1(\varphi_{+-}(\mathbf{S}))$, which is exactly the same tangle representative of $\widetilde{\text{KIIMap}}_{\underline{T},+}^1(\mathbf{T})$ showed in Figure 2.16. In Figure 2.22(b) we show a schematic representation of a tangle representative of

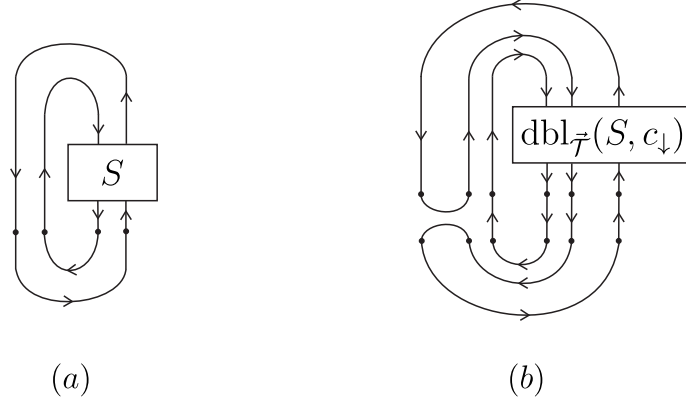

FIGURE 2.22. (a) Schematic representation of a tangle representative of $\widetilde{\text{KIIMap}}_{\underline{T},+}^1(\varphi_{+-}(\mathbf{S}))$, (b) schematic representation of a tangle representative of $\widetilde{\text{KIIMap}}_{\underline{T},+}^2(\varphi_{+-}(\mathbf{S}))$.

$\text{KIIMap}_{\underline{T}}^2(\varphi_{+-}(\mathbf{S}))$ which is isotopic to the tangle representative of $\widetilde{\text{KIIMap}}_{\underline{T},+}^2(\mathbf{S})$ (see Figure 2.21(b) for the schematic representation of the latter). Therefore we have the commutativity of the right diagram. \square

Definition 2.51. Define the map $\widetilde{\text{KIIMap}}_{\underline{T}} : \vec{\mathcal{T}}(\downarrow\uparrow) \sqcup \vec{\mathcal{T}}(\uparrow\downarrow) \rightarrow \vec{\mathcal{T}}(\emptyset, \emptyset) \times \vec{\mathcal{T}}(\emptyset, \emptyset)$ as the disjoint union of the maps

$$(\widetilde{\text{KIIMap}}_{\underline{T},+}^1, \widetilde{\text{KIIMap}}_{\underline{T},+}^2) : \vec{\mathcal{T}}(\downarrow\uparrow) \longrightarrow \vec{\mathcal{T}}(\emptyset, \emptyset) \times \vec{\mathcal{T}}(\emptyset, \emptyset)$$

and

$$(\widetilde{\text{KIIMap}}_{\underline{T},-}^1, \widetilde{\text{KIIMap}}_{\underline{T},-}^2) : \vec{\mathcal{T}}(\uparrow\downarrow) \longrightarrow \vec{\mathcal{T}}(\emptyset, \emptyset) \times \vec{\mathcal{T}}(\emptyset, \emptyset).$$

Proposition 2.52. *The image of the map*

$$(\text{KIIMap}_{\vec{T}}^1, \text{KIIMap}_{\vec{T}}^2) : \text{KIIData}_{\vec{T}} \longrightarrow \vec{T}(\emptyset, \emptyset) \times \vec{T}(\emptyset, \emptyset)$$

is equal to $\text{Im}(\widetilde{\text{KIIMap}}_{\vec{T}})$. Therefore, the set $\text{KII}\vec{T}$ from Definition 2.38(b) can be described as $\text{KII}\vec{T} = \text{Im}(\widetilde{\text{KIIMap}}_{\vec{T}})$.

Proof. This result follows directly from Lemma 2.50. \square

2.6.5. *The monoidal category $\mathcal{Pa}\vec{T}$ of parenthesized framed oriented tangles.* Denote by $\{+, -\}^{(*)}$ the free magma in letters in $\{+, -\}$; elements of $\{+, -\}^{(*)}$ are words in $+, -$ together with a parenthesization (for example $(+-)+ \in \{+, -\}^{(*)}$). The operation of forgetting parenthesizations defines a map $f : \{+, -\}^{(*)} \rightarrow \{+, -\}^*$.

Definition 2.53. (a) Define the set $\mathcal{Pa}\vec{T}$ of isotopy classes of parenthesized framed oriented tangles by

$$\mathcal{Pa}\vec{T} := \{(\mathbf{T}, p, p') \mid \mathbf{T} \in \vec{T} \text{ and } p \text{ and } p' \text{ are parenthesizations of } s(\mathbf{T}) \text{ and } t(\mathbf{T}) \text{ respectively}\}.$$

(b) Define maps $s, t : \mathcal{Pa}\vec{T} \rightarrow \{+, -\}^{(*)}$ by $s(\mathbf{T}, p, p') := (s(\mathbf{T}), p)$ and $t(\mathbf{T}, p, p') := (t(\mathbf{T}), p')$ for any $(\mathbf{T}, p, p') \in \mathcal{Pa}\vec{T}$.

An element in $\mathcal{Pa}\vec{T}$ can be represented by an oriented tangle diagram together with an indication of the parenthesizations for its source and target. In Figure 2.23, we show a representative of an element of $\mathcal{Pa}\vec{T}$ obtained by endowing with parenthesizations the source and target of the element in \vec{T} represented by the tangle diagram from Figure 2.9.

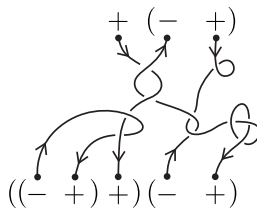

FIGURE 2.23. Representative of an element in $\mathcal{Pa}\vec{T}$ with source $((-+)+)(-+)$ and target $+(-+)$.

We now define the doubling operation and change of orientation operation for elements of $\mathcal{Pa}\vec{T}$.

Definition 2.54. (a) Let $(\mathbf{T}, p, p') \in \mathcal{Pa}\vec{T}$ and $X \subset \pi_0(\mathbf{T})_{\text{seg}}$, define the element $\text{dbl}_{\mathcal{Pa}\vec{T}}((\mathbf{T}, p, p'), X)$ in $\mathcal{Pa}\vec{T}$ by $\text{dbl}_{\mathcal{Pa}\vec{T}}((\mathbf{T}, p, p'), X) := (\text{dbl}_{\vec{T}}(\mathbf{T}, X), p^X, (p')^X)$, where $\text{dbl}_{\vec{T}}(\mathbf{T}, X) = \mathbf{T}^X$ is as in Lemma 2.31 and p^X (resp. $(p')^X$) is the parenthesization of $s(\mathbf{T}^X)$ (resp. $t(\mathbf{T}^X)$) induced by p (resp. p'), the map $\pi_{s(\mathbf{T}), X \cap \partial_b T} : \llbracket 1, |s(\mathbf{T}^X)| \rrbracket \rightarrow \llbracket 1, |s(\mathbf{T})| \rrbracket$ (resp. $\pi_{t(\mathbf{T}), X \cap \partial_t T} : \llbracket 1, |t(\mathbf{T}^X)| \rrbracket \rightarrow \llbracket 1, |t(\mathbf{T})| \rrbracket$) and the condition that the letters located in the positions given by a fiber of $\pi_{s(\mathbf{T}), X \cap \partial_b T}$ (resp. $\pi_{t(\mathbf{T}), X \cap \partial_t T}$) of cardinality 2 do not contain any parenthesis between them.

(b) Let $(\mathbf{T}, p, p') \in \mathcal{Pa}\vec{T}$ and $a \in \pi_0(\mathbf{T})$, define the element $\text{co}_{\mathcal{Pa}\vec{T}}((\mathbf{T}, p, p'), a) \in \mathcal{Pa}\vec{T}$ by

$$\text{co}_{\mathcal{Pa}\vec{T}}((\mathbf{T}, p, p'), a) := (\text{co}_{\vec{T}}(\mathbf{T}, a), p, p'),$$

where $\text{co}_{\vec{T}}(\mathbf{T}, a)$ is as in Lemma 2.26.

Note that by Lemmas 2.21, 2.32(b) and 1.41(a), one has $s(\mathbf{T}^X) = s(\mathbf{T})^{X \cap \partial_b T}$, $t(\mathbf{T}^X) = t(\mathbf{T})^{X \cap \partial_t T}$.

Definition 2.55. The monoidal category of isotopy classes of parenthesized framed oriented tangles $\mathcal{Pa}\vec{T}$ is defined as follows. Its set of objects is the free magma $\{+, -\}^{(*)}$ in $\{+, -\}$. For $u, v \in \{+, -\}^{(*)}$, one has $\mathcal{Pa}\vec{T}(u, v) := \vec{T}(f(u), f(v))$, where $f : \{+, -\}^{(*)} \rightarrow \{+, -\}^*$ is the forget-parenthesization map. The composition in $\mathcal{Pa}\vec{T}$ is defined using the composition in \vec{T} , and the tensor product in $\mathcal{Pa}\vec{T}$ is defined

using the tensor product in $\vec{\mathcal{T}}$ and the compatibility of $f : \{+, -\}^{(*)} \rightarrow \{+, -\}^*$ with the products on both sides.

2.6.6. A description of the subset $\text{KII}\vec{\mathcal{T}} \subset \vec{\mathcal{T}}(\emptyset, \emptyset) \times \vec{\mathcal{T}}(\emptyset, \emptyset)$ using the category $\underline{\mathcal{P}a}\vec{\mathcal{T}}$. Define

$$\mathcal{P}a\vec{\mathcal{T}}(\downarrow\uparrow) \subset \underline{\mathcal{P}a}\vec{\mathcal{T}}((+-), (+-)), \quad \mathcal{P}a\vec{\mathcal{T}}(\uparrow\downarrow) \subset \underline{\mathcal{P}a}\vec{\mathcal{T}}((-+), (-+))$$

as the respective images of

$$\vec{\mathcal{T}}(\downarrow\uparrow) \subset \vec{\mathcal{T}}((+-), (+-)), \quad \vec{\mathcal{T}}(\uparrow\downarrow) \subset \vec{\mathcal{T}}((-+), (-+))$$

under the canonical identifications

$$\vec{\mathcal{T}}((+-), (+-)) \simeq \underline{\mathcal{P}a}\vec{\mathcal{T}}((+-), (+-)), \quad \vec{\mathcal{T}}((-+), (-+)) \simeq \underline{\mathcal{P}a}\vec{\mathcal{T}}((-+), (-+)).$$

Definition 2.56. For $i = 1, 2$, define the maps

$$(2.23) \quad \widetilde{\text{KII}}\text{Map}_{\underline{\mathcal{P}a}\vec{\mathcal{T}}, +-}^i : \mathcal{P}a\vec{\mathcal{T}}(\downarrow\uparrow) \longrightarrow \vec{\mathcal{T}}(\emptyset, \emptyset)$$

as the composition of the maps $\widetilde{\text{KII}}\text{Map}_{\underline{\mathcal{T}}, +-}^i$ from Definition 2.42 and Definition 2.44, with the identification $\mathcal{P}a\vec{\mathcal{T}}(\downarrow\uparrow) \simeq \vec{\mathcal{T}}(\downarrow\uparrow)$. The maps

$$(2.24) \quad \widetilde{\text{KII}}\text{Map}_{\underline{\mathcal{P}a}\vec{\mathcal{T}}, -+}^i : \mathcal{P}a\vec{\mathcal{T}}(\uparrow\downarrow) \longrightarrow \vec{\mathcal{T}}(\emptyset, \emptyset)$$

are defined similarly.

We have therefore the following.

Proposition 2.57. The subset $\text{KII}\vec{\mathcal{T}} \subset \vec{\mathcal{T}}(\emptyset, \emptyset) \times \vec{\mathcal{T}}(\emptyset, \emptyset)$, from Definition 2.38(b) can be described as

$$(2.25) \quad \text{KII}\vec{\mathcal{T}} = \text{Im}((\widetilde{\text{KII}}\text{Map}_{\underline{\mathcal{P}a}\vec{\mathcal{T}}, +-}^1, \widetilde{\text{KII}}\text{Map}_{\underline{\mathcal{P}a}\vec{\mathcal{T}}, +-}^2)) \cup \text{Im}((\widetilde{\text{KII}}\text{Map}_{\underline{\mathcal{P}a}\vec{\mathcal{T}}, -+}^1, \widetilde{\text{KII}}\text{Map}_{\underline{\mathcal{P}a}\vec{\mathcal{T}}, -+}^2)).$$

We now express the maps $\widetilde{\text{KII}}\text{Map}_{\underline{\mathcal{P}a}\vec{\mathcal{T}}, +-}^i$ and $\widetilde{\text{KII}}\text{Map}_{\underline{\mathcal{P}a}\vec{\mathcal{T}}, -+}^i$ for $i = 1, 2$ in terms of morphisms in the category $\underline{\mathcal{P}a}\vec{\mathcal{T}}$.

Definition 2.58. Define the elements

$$\begin{aligned} \text{cup}_{(+ -)(+ -)}^{\mathcal{T}} &\in \underline{\mathcal{P}a}\vec{\mathcal{T}}(\emptyset, (+-)(+-)), & \text{cup}_{(-+)(-+)}^{\mathcal{T}} &\in \underline{\mathcal{P}a}\vec{\mathcal{T}}(\emptyset, (-+)(-+)), \\ \text{cap}_{(+ -)(+ -)}^{\mathcal{T}} &\in \underline{\mathcal{P}a}\vec{\mathcal{T}}((+-)(+-), \emptyset), & \text{cap}_{(-+)(-+)}^{\mathcal{T}} &\in \underline{\mathcal{P}a}\vec{\mathcal{T}}((-+)(-+), \emptyset) \end{aligned}$$

as the images of

$$(2.26) \quad \begin{aligned} (\text{Id}_+ \otimes \text{cup}_{-+}^{\mathcal{T}} \otimes \text{Id}_-) \circ \text{cup}_{+-}^{\mathcal{T}} &\in \vec{\mathcal{T}}(\emptyset, + - + -), & (\text{Id}_- \otimes \text{cup}_{+-}^{\mathcal{T}} \otimes \text{Id}_+) \circ \text{cup}_{+-}^{\mathcal{T}} &\in \vec{\mathcal{T}}(\emptyset, - + - +), \\ \text{cap}_{+-}^{\mathcal{T}} \circ (\text{Id}_+ \otimes \text{cap}_{-+}^{\mathcal{T}} \otimes \text{Id}_-) &\in \vec{\mathcal{T}}(+ - + -, \emptyset), & \text{cap}_{+-}^{\mathcal{T}} \circ (\text{Id}_- \otimes \text{cap}_{-+}^{\mathcal{T}} \otimes \text{Id}_+) &\in \vec{\mathcal{T}}(- + - +, \emptyset) \end{aligned}$$

under the isomorphisms

$$(2.27) \quad \begin{aligned} \vec{\mathcal{T}}(\emptyset, + - + -) &\simeq \underline{\mathcal{P}a}\vec{\mathcal{T}}(\emptyset, (+-)(+-)), & \vec{\mathcal{T}}(\emptyset, - + - +) &\simeq \underline{\mathcal{P}a}\vec{\mathcal{T}}(\emptyset, (-+)(-+)), \\ \vec{\mathcal{T}}(+ - + -, \emptyset) &\simeq \underline{\mathcal{P}a}\vec{\mathcal{T}}((+-)(+-), \emptyset) & \text{and} & \vec{\mathcal{T}}(- + - +, \emptyset) &\simeq \underline{\mathcal{P}a}\vec{\mathcal{T}}((-+)(-+), \emptyset). \end{aligned}$$

Lemma 2.59. (a) There are maps

$$\underline{\mathcal{P}a}\vec{\mathcal{T}}((+-), (+-)) \longrightarrow \underline{\mathcal{P}a}\vec{\mathcal{T}}(\emptyset, \emptyset) \quad \text{and} \quad \underline{\mathcal{P}a}\vec{\mathcal{T}}((-+), (-+)) \longrightarrow \underline{\mathcal{P}a}\vec{\mathcal{T}}(\emptyset, \emptyset)$$

given by

$$(2.28) \quad \mathbf{S} \longmapsto \text{cap}_{(+ -)(+ -)}^{\mathcal{T}} \circ (\text{Id}_{(+ -)} \otimes \mathbf{S}) \circ \text{cup}_{(+ -)(+ -)}^{\mathcal{T}}$$

for $\mathbf{S} \in \underline{\mathcal{P}a}\vec{\mathcal{T}}((+-), (+-))$. The right-hand side map is defined similarly by permuting in this formula the subscripts $+$ and $-$.

(b) The restrictions of the compositions of the above maps with the identification

$$\mathcal{Pa}\vec{\mathcal{T}}(\emptyset, \emptyset) \simeq \vec{\mathcal{T}}(\emptyset, \emptyset)$$

to $\mathcal{Pa}\vec{\mathcal{T}}(\downarrow\uparrow)$ and $\mathcal{Pa}\vec{\mathcal{T}}(\uparrow\downarrow)$, are equal to the maps (2.23) and (2.24) with $i = 1$.

Proof. The part (a) of the lemma is obvious. For (b), notice that elements obtained from formulas (2.14) and (2.28) are identical. Therefore, the maps are equal. \square

Definition 2.60. Define the elements

$$\begin{aligned} \text{cup}_{-((++)-)}^{\mathcal{T}} &\in \mathcal{Pa}\vec{\mathcal{T}}(\emptyset, -((++)-)), & \text{cup}_{+((--)+)}^{\mathcal{T}} &\in \mathcal{Pa}\vec{\mathcal{T}}(\emptyset, +((--)+)), \\ \text{cap}_{-((++)-)}^{\mathcal{T}} &\in \mathcal{Pa}\vec{\mathcal{T}}(-((++)-), \emptyset), & \text{cap}_{+((--)+)}^{\mathcal{T}} &\in \mathcal{Pa}\vec{\mathcal{T}}(+((--)+), \emptyset) \end{aligned}$$

as the images of

$$\begin{aligned} \text{cup}_{+-}^{\mathcal{T}} \otimes \text{cup}_{+-}^{\mathcal{T}} &\in \vec{\mathcal{T}}(\emptyset, - + + -), & \text{cup}_{+-}^{\mathcal{T}} \otimes \text{cup}_{+-}^{\mathcal{T}} &\in \vec{\mathcal{T}}(\emptyset, + - - +), \\ \text{cap}_{+-}^{\mathcal{T}} \otimes \text{cap}_{+-}^{\mathcal{T}} &\in \vec{\mathcal{T}}(- + + -, \emptyset), & \text{cap}_{+-}^{\mathcal{T}} \otimes \text{cap}_{+-}^{\mathcal{T}} &\in \vec{\mathcal{T}}(+ - - +, \emptyset) \end{aligned}$$

under the isomorphisms

$$\begin{aligned} \vec{\mathcal{T}}(\emptyset, - + + -) &\simeq \mathcal{Pa}\vec{\mathcal{T}}(\emptyset, -((++)-)), & \vec{\mathcal{T}}(\emptyset, + - - +) &\simeq \mathcal{Pa}\vec{\mathcal{T}}(\emptyset, +((--)+)), \\ \vec{\mathcal{T}}(- + + -, \emptyset) &\simeq \mathcal{Pa}\vec{\mathcal{T}}(-((++)-), \emptyset) & \text{and} & \vec{\mathcal{T}}(+ - - +, \emptyset) \simeq \mathcal{Pa}\vec{\mathcal{T}}(+((--)+), \emptyset). \end{aligned}$$

Lemma 2.61. The map $\widetilde{\text{KIIMap}}_{\mathcal{Pa}\vec{\mathcal{T}}, +-}^2$ from (2.23) with $i = 2$ is given by

$$(2.29) \quad \mathbf{S} \longmapsto \text{cap}_{-((+++)-)}^{\mathcal{T}} \circ (\text{Id}_- \otimes \text{dbl}_1(\mathbf{S})) \circ \text{cup}_{-((+++)-)}^{\mathcal{T}} \in \vec{\mathcal{T}}(\emptyset, \emptyset),$$

where dbl_1 denotes the doubling operation $\text{dbl}_{\mathcal{Pa}\vec{\mathcal{T}}}$ applied to the elements of $\mathcal{Pa}\vec{\mathcal{T}}(\downarrow\uparrow)$ with respect to the connected component corresponding to \downarrow . The map $\widetilde{\text{KIIMap}}_{\mathcal{Pa}\vec{\mathcal{T}}, -+}^2$ from (2.24) with $i = 2$ is given by the formula obtained from (2.29) by permuting the subscripts $+$ and $-$.

Proof. The result follows because the tangles obtained from formulas (2.15) and (2.29) are identical. \square

2.7. Decomposition of the set $\text{KII}\vec{\mathcal{T}}$. In this subsection we use the maps $\widetilde{\text{KIIMap}}_{\vec{\mathcal{T}}, +-}^i$ and $\widetilde{\text{KIIMap}}_{\vec{\mathcal{T}}, -+}^i$ to show that the set $\text{KII}\vec{\mathcal{T}}$ decomposes as a disjoint union $\sqcup_{k \geq 0} \text{KII}\vec{\mathcal{T}}_k$ such that $\text{KII}\vec{\mathcal{T}}_k \subset \vec{\mathcal{T}}(\emptyset, \emptyset)_k \times \vec{\mathcal{T}}(\emptyset, \emptyset)_k$.

Definition 2.62. Let $P \in \vec{\mathcal{B}}r$, recall from Definition 2.40 the set $\vec{\mathcal{T}}(P)$. For $k \in \mathbb{Z}_{\geq 0}$ define the subset $\vec{\mathcal{T}}(P)_k$ of $\vec{\mathcal{T}}(P)$ as the preimage of k under the map $\vec{\mathcal{T}}(P) \rightarrow \mathbb{Z}_{\geq 0}$ taking $\mathbf{T} \in \vec{\mathcal{T}}(P)$ to $|\pi_0(\mathbf{T})_{\text{cir}}|$. We have $\vec{\mathcal{T}}(P) = \sqcup_{k \geq 0} \vec{\mathcal{T}}(P)_k$.

One checks that $\vec{\mathcal{T}}(\emptyset, \emptyset)_k = \vec{\mathcal{T}}(\vec{\emptyset})_k$, where $\{\vec{\emptyset}\} = \vec{\mathcal{B}}r(\emptyset, \emptyset) = \vec{\mathcal{B}}r(0, 0)$, see Definition 1.27 and Lemma 2.22.

Lemma 2.63. The maps $\widetilde{\text{KIIMap}}_{\vec{\mathcal{T}}, +-}^1$ and $\widetilde{\text{KIIMap}}_{\vec{\mathcal{T}}, -+}^1$ from Definition 2.42 restrict to well-defined maps

$$(2.30) \quad \widetilde{\text{KIIMap}}_{\vec{\mathcal{T}}, k, +-}^1 : \vec{\mathcal{T}}(\downarrow\uparrow)_{k-2} \longrightarrow \vec{\mathcal{T}}(\emptyset, \emptyset)_k \quad \text{and} \quad \widetilde{\text{KIIMap}}_{\vec{\mathcal{T}}, k, -+}^1 : \vec{\mathcal{T}}(\uparrow\downarrow)_{k-2} \longrightarrow \vec{\mathcal{T}}(\emptyset, \emptyset)_k$$

for any $k \in \mathbb{Z}_{\geq 2}$.

Proof. Let us consider the case $+-$. Let $\text{cap}_{+-+}^{\mathcal{T}} := \text{cap}_{+-}^{\mathcal{T}} \circ (\text{Id}_+ \otimes \text{cap}_{+-}^{\mathcal{T}} \otimes \text{Id}_-)$ and $\text{cup}_{+-+}^{\mathcal{T}} := (\text{Id}_+ \otimes \text{cup}_{+-}^{\mathcal{T}} \otimes \text{Id}_-) \circ \text{cup}_{+-}^{\mathcal{T}}$. Let $\mathbf{S} \in \vec{\mathcal{T}}(\downarrow\uparrow)_{k-2}$, by definition $\widetilde{\text{KIIMap}}_{\vec{\mathcal{T}}, +-}^1(\mathbf{S}) \in \vec{\mathcal{T}}(\emptyset, \emptyset)$. Since $\mathbf{S} \in \vec{\mathcal{T}}(\downarrow\uparrow)_{k-2}$, then $|\pi_0(\mathbf{S})_{\text{cir}}| = k - 2$ and $\vec{\text{br}}(\mathbf{S}) = \vec{\text{br}}(\text{Id}_{+-}) = \downarrow\uparrow$. Using Lemma 2.19 we obtain

$$\begin{aligned} |\pi_0(\widetilde{\text{KIIMap}}_{\vec{\mathcal{T}}, +-}^1(\mathbf{S}))_{\text{cir}}| &= |\pi_0(\text{cap}_{+-+}^{\mathcal{T}})_{\text{cir}}| + |\pi_0(\text{Id}_{+-})_{\text{cir}}| + |\pi_0(\mathbf{S})_{\text{cir}}| + |\pi_0(\text{cup}_{+-+}^{\mathcal{T}})_{\text{cir}}| \\ &+ |\text{Cir}(\vec{\text{br}}(\text{cap}_{+-+}^{\mathcal{T}}), \vec{\text{br}}(\text{Id}_{+-}) \otimes \vec{\text{br}}(\mathbf{S}))| + |\text{Cir}(\vec{\text{br}}(\text{cap}_{+-+}^{\mathcal{T}}) \circ (\vec{\text{br}}(\text{Id}_{+-}) \otimes \vec{\text{br}}(\mathbf{S})), \vec{\text{br}}(\text{cup}_{+-+}^{\mathcal{T}}))| \\ &= |\pi_0(\mathbf{S})_{\text{cir}}| + |\text{Cir}(\vec{\text{br}}(\text{cap}_{+-+}^{\mathcal{T}}), \vec{\text{br}}(\text{cup}_{+-+}^{\mathcal{T}}))| = k - 2 + 2 = k. \end{aligned}$$

That is, $\widetilde{\text{KIIMap}}_{\vec{\mathcal{T}},+-}^1(\mathbf{S}) \in \vec{\mathcal{T}}(\emptyset, \emptyset)_k$. □

Lemma 2.64. *The maps $\widetilde{\text{KIIMap}}_{\vec{\mathcal{T}},+-}^2$ and $\widetilde{\text{KIIMap}}_{\vec{\mathcal{T}},-+}^2$ restrict to well-defined maps*

$$(2.31) \quad \widetilde{\text{KIIMap}}_{\vec{\mathcal{T}},k,+}^2 : \vec{\mathcal{T}}(\downarrow\uparrow)_{k-2} \longrightarrow \vec{\mathcal{T}}(\emptyset, \emptyset)_k \quad \text{and} \quad \widetilde{\text{KIIMap}}_{\vec{\mathcal{T}},k,-+}^2 : \vec{\mathcal{T}}(\uparrow\downarrow)_{k-2} \longrightarrow \vec{\mathcal{T}}(\emptyset, \emptyset)_k$$

for any $k \in \mathbb{Z}_{\geq 2}$.

Proof. Let us consider the case $+-$. Let $\mathbf{S} \in \vec{\mathcal{T}}(\downarrow\uparrow)_{k-2}$, by definition $\widetilde{\text{KIIMap}}_{\vec{\mathcal{T}},+-}^2(\mathbf{S}) \in \vec{\mathcal{T}}(\emptyset, \emptyset)$. Since $\mathbf{S} \in \vec{\mathcal{T}}(\downarrow\uparrow)_{k-2}$, then $|\pi_0(\mathbf{S})_{\text{cir}}| = k-2$ and $\vec{\text{br}}(\mathbf{S}) = \vec{\text{br}}(\text{Id}_{+-}) = \downarrow\uparrow$. By Lemma 2.32 we have $|\pi_0(\text{dbl}_1(\mathbf{S}))_{\text{cir}}| = |\pi_0(\mathbf{S})_{\text{cir}}|$ and $\vec{\text{br}}(\text{dbl}_1(\mathbf{S})) = \text{dbl}_{\vec{\text{br}}}(\vec{\text{br}}(\mathbf{S}), \downarrow) = \text{Id}_{++-} \in \vec{\mathcal{B}}_r(++-, ++-)$. Here we use the notation \downarrow to indicate the subset $\{\{1, \bar{1}\}\} \subset \pi_0(\vec{\text{br}}(\mathbf{S}))$. By using these equalities and repeated application of Lemma 2.19 we obtain

$$\begin{aligned} |\pi_0(\widetilde{\text{KIIMap}}_{\vec{\mathcal{T}},+-}^2(\mathbf{S}))_{\text{cir}}| &= |\pi_0(\text{cap}_{-+}^{\mathcal{T}} \otimes \text{cap}_{+-}^{\mathcal{T}})_{\text{cir}}| + |\pi_0(\text{Id}_{-})_{\text{cir}}| + |\pi_0(\text{dbl}_1(\mathbf{S}))_{\text{cir}}| \\ &\quad + |\text{Cir}(\vec{\text{br}}(\text{cap}_{-+}^{\mathcal{T}} \otimes \text{cap}_{+-}^{\mathcal{T}}), \vec{\text{br}}(\text{Id}_{-}) \otimes \vec{\text{br}}(\text{dbl}_1(\mathbf{S})))| \\ &\quad + |\text{Cir}(\vec{\text{br}}(\text{cap}_{-+}^{\mathcal{T}} \otimes \text{cap}_{+-}^{\mathcal{T}}) \circ (\vec{\text{br}}(\text{Id}_{-}) \otimes \vec{\text{br}}(\text{dbl}_1(\mathbf{S}))), \vec{\text{br}}(\text{cup}_{-+}^{\mathcal{T}} \otimes \text{cup}_{+-}^{\mathcal{T}}))| \\ &= 0 + 0 + |\pi_0(\mathbf{S})_{\text{cir}}| + |\text{Cir}(\vec{\text{br}}(\text{cap}_{-+}^{\mathcal{T}} \otimes \text{cap}_{+-}^{\mathcal{T}}), \vec{\text{br}}(\text{Id}_{-++-}))| \\ &\quad + |\text{Cir}(\vec{\text{br}}(\text{cap}_{-+}^{\mathcal{T}} \otimes \text{cap}_{+-}^{\mathcal{T}}), \vec{\text{br}}(\text{cup}_{-+}^{\mathcal{T}} \otimes \text{cup}_{+-}^{\mathcal{T}}))| \\ &= 0 + 0 + (k-2) + 0 + 2 = k. \end{aligned}$$

That is, $\widetilde{\text{KIIMap}}_{\vec{\mathcal{T}},+-}^2(\mathbf{S}) \in \vec{\mathcal{T}}(\emptyset, \emptyset)_k$ □

Proposition 2.65. (a) *The map $\widetilde{\text{KIIMap}}_{\vec{\mathcal{T}}} : \vec{\mathcal{T}}(\downarrow\uparrow) \sqcup \vec{\mathcal{T}}(\uparrow\downarrow) \rightarrow \vec{\mathcal{T}}(\emptyset, \emptyset) \times \vec{\mathcal{T}}(\emptyset, \emptyset)$ restricts to maps*

$$\widetilde{\text{KIIMap}}_{\vec{\mathcal{T}},k} = (\widetilde{\text{KIIMap}}_{\vec{\mathcal{T}},k}^1, \widetilde{\text{KIIMap}}_{\vec{\mathcal{T}},k}^2) : \vec{\mathcal{T}}(\downarrow\uparrow)_{k-2} \sqcup \vec{\mathcal{T}}(\uparrow\downarrow)_{k-2} \longrightarrow \vec{\mathcal{T}}(\emptyset, \emptyset)_k \times \vec{\mathcal{T}}(\emptyset, \emptyset)_k$$

for $k \in \mathbb{Z}_{\geq 2}$.

$$(b) \quad \widetilde{\text{KIIMap}}_{\vec{\mathcal{T}}} = \bigsqcup_{k \in \mathbb{Z}_{\geq 2}} \widetilde{\text{KIIMap}}_{\vec{\mathcal{T}},k}.$$

Proof. (a) follows from Lemmas 2.63 and 2.64 and (b) follows from (a). □

Definition 2.66. For $k \in \mathbb{Z}_{\geq 2}$, define the subset $\text{KII}\vec{\mathcal{T}}_k \subset \vec{\mathcal{T}}(\emptyset, \emptyset)_k \times \vec{\mathcal{T}}(\emptyset, \emptyset)_k$ by

$$(2.32) \quad \text{KII}\vec{\mathcal{T}}_k := \text{Im}(\widetilde{\text{KIIMap}}_{\vec{\mathcal{T}},k}).$$

We set $\text{KII}\vec{\mathcal{T}}_0 = \text{KII}\vec{\mathcal{T}}_1 = \emptyset$.

Corollary 2.67. *The set $\text{KII}\vec{\mathcal{T}}$ from Definition 2.38 decomposes as*

$$(2.33) \quad \text{KII}\vec{\mathcal{T}} = \bigsqcup_{k \in \mathbb{Z}_{\geq 0}} \text{KII}\vec{\mathcal{T}}_k.$$

Proof. We have

$$\begin{aligned} \text{KII}\vec{\mathcal{T}} &= \text{Im}(\widetilde{\text{KIIMap}}_{\vec{\mathcal{T}}}) = \text{Im}(\widetilde{\text{KIIMap}}_{\vec{\mathcal{T}}}) \\ &= \text{Im}\left(\bigsqcup_{k \in \mathbb{Z}_{\geq 2}} \widetilde{\text{KIIMap}}_{\vec{\mathcal{T}},k}\right) = \bigsqcup_{k \in \mathbb{Z}_{\geq 2}} \text{Im}(\widetilde{\text{KIIMap}}_{\vec{\mathcal{T}},k}) = \bigsqcup_{k \in \mathbb{Z}_{\geq 0}} \text{KII}\vec{\mathcal{T}}_k, \end{aligned}$$

in the second equality we use Proposition 2.52 and in the third one Proposition 2.65(c). □

2.8. Kirby bialgebra, (semi)Kirby structures, and invariants of 3-manifolds. The purpose of this subsection is to express the surgery presentation of 3-manifolds in terms of some algebraic structures and to apply this to the construction of invariants of 3-manifolds. In §2.8.1, we describe the Lickorish-Wallace and Kirby theorems in terms of a monoid obtained from the category of tangles, which we call the Kirby monoid. In §2.8.2, we apply this to the construction of invariants of 3-manifolds. Linear versions of these constructions are done in the next subsections: in §2.8.3, the description of §2.8.1 is reformulated in terms of the bialgebra attached to the Kirby monoid (Kirby bialgebra) and the construction of §2.8.2 is reformulated in terms of the notions of (semi)Kirby structures.

2.8.1. *A description of the monoid of homeomorphism classes of 3-manifolds in terms of tangles.*

Definition 2.68. Let S be a set and $R \subset S \times S$, define $\langle R \rangle$ to be the equivalence relation on S defined by: $s \sim s'$ if and only if there exists $k \geq 1$ and $(s_0, \dots, s_k) \in S^{k+1}$ such that $(s_i, s_{i+1}) \in R \cup R^{\text{op}}$ for $i = 0, \dots, k-1$ with $s_0 = s$ and $s_k = s'$. Here $R^{\text{op}} \subset S \times S$ is the image of R under the map which permutes the two factors in $S \times S$. The quotient of S by this relation is then denoted $S/\langle R \rangle$.

Definition 2.69. Let M be a commutative monoid and $R \subset M \times M$. We say that R is *compatible with the monoid structure* if for any $(a, b) \in R$ and any $c \in M$ we have $(ac, bc) \in R$.

Lemma 2.70. *Let M be a commutative monoid and $R \subset M \times M$ compatible with the monoid structure then $M/\langle R \rangle$ has the structure of a commutative monoid and the canonical map $M \rightarrow M/\langle R \rangle$ is a monoid homomorphism.*

Proof. The result follows straightforwardly. □

Recall from Lemma 2.22 the graded monoid structure of $\vec{\mathcal{T}}(\emptyset, \emptyset)$.

Lemma 2.71. *The subsets $\text{KII}\vec{\mathcal{T}} \subset \vec{\mathcal{T}}(\emptyset, \emptyset) \times \vec{\mathcal{T}}(\emptyset, \emptyset)$ and $\text{COT}\vec{\mathcal{T}} \subset \vec{\mathcal{T}}(\emptyset, \emptyset) \times \vec{\mathcal{T}}(\emptyset, \emptyset)$ are compatible with the monoid structure of $\vec{\mathcal{T}}(\emptyset, \emptyset)$, where $\text{KII}\vec{\mathcal{T}}$ and $\text{COT}\vec{\mathcal{T}}$ are as in Definitions 2.29 and 2.38, respectively.*

Proof. The result follows from the definitions of these subsets. □

Corollary 2.72. *The set $\text{Kir} := \vec{\mathcal{T}}(\emptyset, \emptyset)/\langle \text{KII}\vec{\mathcal{T}} \cup \text{COT}\vec{\mathcal{T}} \rangle$ is a commutative monoid, which we call the Kirby monoid. Moreover, Kir is $\mathbb{Z}_{\geq 0}$ -graded, i.e., $\text{Kir} = \bigsqcup_{k \geq 0} \text{Kir}_k$, where*

$$(2.34) \quad \text{Kir}_k := \frac{\vec{\mathcal{T}}(\emptyset, \emptyset)_k}{\langle \text{KII}\vec{\mathcal{T}}_k \cup \text{COT}\vec{\mathcal{T}}_k \rangle},$$

where $\text{KII}\vec{\mathcal{T}}_k$ and $\text{COT}\vec{\mathcal{T}}_k$ are as in Definitions 2.66 and 2.29, respectively.

Proof. The result follows from Lemmas 2.70 and 2.71. □

Lemma 2.73. *If $(M, *)$ is a commutative monoid and $m_1, \dots, m_k \in M$, then the subset $R \subset M \times M$ consisting of pairs (m, m') such that there exist $(a_1, \dots, a_k), (a'_1, \dots, a'_k) \in \mathbb{Z}_{\geq 0}^k$ with $m * m_1^{a_1} * \dots * m_k^{a_k} = m' * m_1^{a'_1} * \dots * m_k^{a'_k}$ is compatible with the monoid structure. We denote by $M/\text{Eq}(m_1, \dots, m_k)$ the corresponding quotient monoid given by Lemma 2.70.*

Proof. The result follows straightforwardly. □

Proposition 2.74. *The monoid homomorphism $\vec{\mathcal{T}}(\emptyset, \emptyset) \rightarrow 3\text{-Mfds}$ from (2.4) induces an isomorphism of commutative monoids*

$$\frac{\text{Kir}}{\text{Eq}(U^+, U^-)} \simeq 3\text{-Mfds},$$

where Kir is the Kirby monoid (see Corollary 2.72) and $U^\pm \in \vec{\mathcal{T}}(\emptyset, \emptyset)_1$ are the ± 1 -framed unknots shown Figure 2.6.

Proof. It follows from the Lickorish-Wallace theorem ([37, 58]) that $\vec{\mathcal{T}}(\emptyset, \emptyset) \rightarrow 3\text{-Mfds}$ is surjective. It follows from Kirby's theorem (see Theorem 2.3) that this homomorphism factors as a composition of monoid homomorphisms $\vec{\mathcal{T}}(\emptyset, \emptyset) \rightarrow \text{Kir} \rightarrow \text{Kir}/\text{Eq}(U^+, U^-) \rightarrow 3\text{-Mfds}$ among which the last morphism $\text{Kir}/\text{Eq}(U^+, U^-) \rightarrow 3\text{-Mfds}$ is injective. All this implies that $\text{Kir}/\text{Eq}(U^+, U^-) \rightarrow 3\text{-Mfds}$ is a monoid isomorphism. \square

2.8.2. Algebraic construction of invariants of 3-manifolds.

Definition 2.75. Let $\sigma_{\pm}, \sigma_0 : \vec{\mathcal{T}}(\emptyset, \emptyset) \rightarrow \mathbb{Z}_{\geq 0}$ be the maps which take x to $\sigma_{\pm}(x)$ and $\sigma_0(x)$, where $\sigma_+(x)$ (resp. $\sigma_-(x)$ and $\sigma_0(x)$) is the number of positive (resp. negative and zero) eigenvalues of the linking matrix of $x \in \vec{\mathcal{T}}(\emptyset, \emptyset)$.

Lemma 2.76. *The maps $\sigma_{\pm}, \sigma_0 : \vec{\mathcal{T}}(\emptyset, \emptyset) \rightarrow \mathbb{Z}_{\geq 0}$ are morphisms of commutative monoids which factor through morphisms $\text{Kir} \rightarrow \mathbb{Z}_{\geq 0}$, where Kir is the Kirby monoid (see Corollary 2.72). Moreover, $\sigma_{\epsilon}(U^{\epsilon'}) = \delta_{\epsilon, \epsilon'}$ for $\epsilon, \epsilon' \in \{+, -\}$.*

Proof. The linking matrix of a representative T of $\mathbf{T} \in \vec{\mathcal{T}}(\emptyset, \emptyset)_k$ is a symmetric matrix in $\text{Mat}_k(\mathbb{Z})$, which undergoes a transformation $m \mapsto {}^t P m P$ with $P \in \text{GL}_k(\mathbb{Z})$ both if T undergoes a KII move (see [49, §3.3] for more details) or a change of orientation (in that case P is diagonal). Therefore, the number of positive (resp. negative and zero) eigenvalues does not change under the equivalence relation $\langle \text{KII}\vec{\mathcal{T}} \cup \text{CO}\vec{\mathcal{T}} \rangle$ induced by $\text{KII}\vec{\mathcal{T}} \cup \text{CO}\vec{\mathcal{T}}$. Therefore, they factor through morphisms $\text{Kir} \rightarrow \mathbb{Z}_{\geq 0}$. The last statement of the lemma is obvious. \square

Lemma 2.77. *The monoid morphism σ_0 factors through $\text{Eq}(U^+, U^-)$, and therefore defines a monoid homomorphism $\sigma_0 : \text{Kir}/\text{Eq}(U^+, U^-) \rightarrow \mathbb{Z}_{\geq 0}$ which fits in the following commutative diagram*

$$\begin{array}{ccc} \text{Kir} & \xrightarrow{\sigma_0} & \mathbb{Z}_{\geq 0} \\ \text{Eq}(U^+, U^-) & \xrightarrow{\quad} & \\ \simeq \downarrow & \nearrow & \\ 3\text{-Mfds} & & \end{array}$$

where the vertical map is the surgery map (2.1) and the diagonal map takes the homeomorphism class of a 3-manifold Y to $\dim_{\mathbb{Q}}(H_1(Y, \mathbb{Q}))$. One has therefore $\sigma_0(L) = \dim_{\mathbb{Q}}(H_1(S_L^3, \mathbb{Q}))$ for any framed oriented link L .

Proof. For any framed oriented link L we have $\text{Lk}(L \dot{\cup} U^{\pm}) = \text{Lk}(L) \oplus \{\pm 1\}$, therefore $\sigma_0(L \dot{\cup} U^{\pm}) = \sigma_0(L)$ and hence σ_0 factors through $\text{Eq}(U^+, U^-)$. Besides, there is a simply-connected 4-manifold W_L with $\partial W_L = S_L^3$ such that $\dim_{\mathbb{Q}}(H_2(W_L; \mathbb{Q})) = \dim_{\mathbb{Q}}(H_2(W_L, S_L^3; \mathbb{Q})) = |\pi_0(L)|$ and basis of these modules such that the matrix of the morphism j_* in the short exact sequence

$$0 \longrightarrow H_2(S_L^3; \mathbb{Q}) \xrightarrow{i_*} H_2(W_L; \mathbb{Q}) \xrightarrow{j_*} H_2(W_L, S_L^3; \mathbb{Q}) \xrightarrow{\delta_*} H_1(S_L^3; \mathbb{Q}) \longrightarrow 0$$

is given by $\text{Lk}(L)$, see for instance [49, Theorems 6.1 and 6.2]. Hence, $\text{coker}(\text{Lk}(L)) \simeq H_1(S_L^3; \mathbb{Q})$. Since $\text{Lk}(L)$ is a symmetric matrix, it is diagonalisable. By definition, the multiplicity of the eigenvalue 0 is $\sigma_0(L)$, therefore $\dim(\text{coker}(\text{Lk}(L))) = \sigma_0(L)$. Hence, $\sigma_0(L) = \dim_{\mathbb{Q}}(H_1(S_L^3, \mathbb{Q}))$. All the described arguments do not depend on the isotopy class of L . \square

Proposition 2.78. *Let $(M, *)$ be a commutative monoid and $f : \text{Kir} \rightarrow M$ be a monoid morphism such that $f(U^{\pm})$ are invertible in M . Then the map $\tilde{f} : \text{Kir} \rightarrow M$ defined by*

$$\tilde{f}(x) := (f(U^+))^{-\sigma_+(x)} * (f(U^-))^{-\sigma_-(x)} * f(x)$$

is a monoid morphism, which moreover factors through a monoid morphism $\text{Kir}/\text{Eq}(U^+, U^-) \rightarrow M$ which by composition with the monoid isomorphism of Proposition 2.74 gives rise to a monoid homomorphism $3\text{-Mfds} \rightarrow M$.

Proof. The results follows from Lemma 2.76 and the definition of $\text{Kir}/\text{Eq}(U^+, U^-)$. \square

Example 2.79. To an integer $r \geq 3$ and a primitive $4r$ -th root of unity, one associates the map $f_0 : \vec{\mathcal{T}}(\emptyset, \emptyset) \rightarrow \mathbb{C}$ defined as follows. Let $L \in \vec{\mathcal{T}}(\emptyset, \emptyset)$ and let D be a link diagram of L and \bar{D} the link diagram obtained from D by forgetting the orientations. Let $f_0(L) := \langle \bar{D}^\omega \rangle$, where $\langle \bar{D}^\omega \rangle$ is as in [41, §8.2] or [38, Chapter 13]. Then f_0 is multiplicative (Kauffman bracket is multiplicative) and factors through a multiplicative map $f : \text{Kir} \rightarrow \mathbb{C}$ (see [38, Lemma 13.5] or [41, Theorem 8.11]). Moreover, $f(U^\pm) \neq 0$. Therefore, by Proposition 2.78, it induces a monoid homomorphism

$$(2.35) \quad \text{RT}_r : 3\text{-Mfds} \rightarrow \mathbb{C},$$

which coincides with the *Reshetikhin-Turaev* invariant as defined in [41, §8.2].

2.8.3. Kirby bialgebra, (semi)Kirby structures, and invariants of 3-manifolds. Let S be a set, then $\mathbb{Z}S$ has a coalgebra structure defined by the condition that any element of S is group-like and with trivial counit.

Let S be a set and $R \subset S \times S$. Consider the map $R \rightarrow \mathbb{Z}S$ given by $(s, s') \mapsto s - s'$. It extends to a morphism of abelian groups $\mathbb{Z}R \rightarrow \mathbb{Z}S$. The cokernel of this map is $\mathbb{Z}S/\langle R \rangle$, where $\langle R \rangle \subset \mathbb{Z}S$ is its image. It is equipped with a coalgebra structure, and the projection $\mathbb{Z}S \rightarrow \mathbb{Z}S/\langle R \rangle$ is a morphism of coalgebras. Moreover, the map $S \rightarrow \mathbb{Z}S/\langle R \rangle$ induces a map

$$(2.36) \quad \frac{S}{\langle R \rangle} \longrightarrow \frac{\mathbb{Z}S}{\langle R \rangle}$$

If M is a commutative monoid, then $\mathbb{Z}M$ has a bialgebra structure. If moreover $R \subset M \times M$ is compatible with the monoid structure, then $\mathbb{Z}M/\langle R \rangle$ is a quotient bialgebra of $\mathbb{Z}M$. The map $M \rightarrow \mathbb{Z}M/\langle R \rangle$ is a monoid morphism, which induces a monoid morphism

$$(2.37) \quad \frac{M}{\langle R \rangle} \longrightarrow \frac{\mathbb{Z}M}{\langle R \rangle}.$$

Lemma 2.80. *The map (2.36) induces an isomorphism of coalgebras $\mathbb{Z}(S/\langle R \rangle) \simeq \mathbb{Z}S/\langle R \rangle$. Similarly, the map (2.37) induces an isomorphism of bialgebras $\mathbb{Z}(M/\langle R \rangle) \simeq \mathbb{Z}M/\langle R \rangle$.*

Proof. The result follows straightforwardly. \square

Definition 2.81. We call the bialgebra $\mathfrak{Kir} := \mathbb{Z}\vec{\mathcal{T}}(\emptyset, \emptyset)/(\text{KII}\vec{\mathcal{T}} \cup \text{CO}\vec{\mathcal{T}})$ the *Kirby bialgebra*. It is a commutative, associative, cocommutative and coassociative bialgebra. As an algebra \mathfrak{Kir} is $\mathbb{Z}_{\geq 0}$ -graded

$$\mathfrak{Kir} = \bigoplus_{k \geq 0} \mathfrak{Kir}_k,$$

where

$$\mathfrak{Kir}_k = \frac{\mathbb{Z}\vec{\mathcal{T}}(\emptyset, \emptyset)_k}{(\text{KII}\vec{\mathcal{T}}_k \cup \text{CO}\vec{\mathcal{T}}_k)} = \frac{\mathbb{Z}\vec{\mathcal{T}}(\emptyset, \emptyset)_k}{(\text{KII}\vec{\mathcal{T}}_k) + (\text{CO}\vec{\mathcal{T}}_k)}.$$

Recall that $\text{KII}\vec{\mathcal{T}}_0 = \text{KII}\vec{\mathcal{T}}_1 = \text{CO}\vec{\mathcal{T}}_0 = \emptyset$, therefore $(\text{KII}\vec{\mathcal{T}}_0) = (\text{KII}\vec{\mathcal{T}}_1) = (\text{CO}\vec{\mathcal{T}}_0) = \{0\}$. We denote the coproduct in \mathfrak{Kir} by $\Delta_{\mathfrak{Kir}}$.

Lemma 2.82. *There is a graded isomorphism of bialgebras $\mathfrak{Kir} \simeq \mathbb{Z}\text{Kir}$, where Kir is the Kirby monoid (see Corollary 2.72).*

Proof. The result is an instance of Lemma 2.80. \square

Definition 2.83. A *semi-Kirby structure* is a pair (A, μ) where $\mu : \mathfrak{Kir} \rightarrow A$ is an algebra morphism. A semi-Kirby structure (A, μ) is called a *Kirby structure* if the elements $\mu(U^\pm) \in A$ are invertible.

Example 2.84. Consider the pair (\mathbb{C}, μ_r) , where $\mu_r : \mathfrak{Kir} \rightarrow \mathbb{C}$ is the algebra homomorphism induced by the map $f : \text{Kir} \rightarrow \mathbb{C}$ from Example 2.79 (using Lemma 2.80). Then (\mathbb{C}, μ_r) is a Kirby structure.

Definition 2.85. We define the category of semi-Kirby structures, denoted \mathcal{SKS} , as follows. The objects of \mathcal{SKS} are semi-Kirby structures. If $(A, \mu), (B, \nu) \in \text{Ob}(\mathcal{SKS})$, the set of morphisms $\mathcal{SKS}((A, \mu), (B, \nu))$ consists of algebra homomorphism $\phi : A \rightarrow B$ such that $\nu = \phi \circ \mu$. The composition in \mathcal{SKS} is induced by the composition of algebra homomorphisms. We denote by \mathcal{KS} the full subcategory of \mathcal{SKS} of Kirby structures.

Lemma 2.86. (a) *If $(A, \mu) \in \text{Ob}(\mathcal{SKS})$ and $f : A \rightarrow B$ is an algebra homomorphism, then $(B, f \circ \mu)$ is in $\text{Ob}(\mathcal{SKS})$, and f induces a morphism $(A, \mu) \rightarrow (B, f \circ \mu)$ in \mathcal{SKS} .*

(b) *If $(A, \mu) \in \text{Ob}(\mathcal{KS})$ and $f : A \rightarrow B$ is an algebra homomorphism, then $(B, f \circ \mu)$ is in $\text{Ob}(\mathcal{KS})$.*

In both cases, we call $(B, f \circ \mu)$ the push-forward of (A, μ) by f .

Proof. This follows straightforwardly. \square

Lemma 2.87. *A tensor structure is defined on \mathcal{SKS} by $(A, \mu) \otimes (B, \nu) := (A \otimes B, (\mu \otimes \nu) \circ \Delta_{\mathfrak{Rit}})$ at the level of objects and induced by the tensor product of algebra homomorphisms at the level of morphisms. Moreover, \mathcal{KS} is a tensor subcategory of \mathcal{SKS} .*

Proof. The first claim is straightforward and the fact that \mathcal{KS} is a tensor subcategory follows from group-likeness of U^\pm in the bialgebra \mathfrak{Rit} . \square

Definition 2.88. An algebra-valued invariant of (closed, oriented) 3-manifolds is a pair (A, i) where A is an algebra and $i : 3\text{-Mfds} \rightarrow (A, \cdot)$ is a monoid morphism, where (A, \cdot) is the underlying multiplicative monoid of A .

Definition 2.89. We define the category \mathcal{Inv} of algebra-valued invariants of 3-manifolds as follows. The objects are algebra-valued invariants of 3-manifolds (A, i) as in Definition 2.88. If $(A, i), (B, j) \in \text{Ob}(\mathcal{Inv})$, the set of morphisms $\mathcal{Inv}((A, i), (B, j))$ consists of algebra homomorphisms $\phi : A \rightarrow B$ such that $j = \phi \circ i$.

Lemma 2.90. *The category \mathcal{Inv} is a monoidal category with tensor product given by $(A, i) \otimes (B, j) := (A \otimes B, i \otimes j)$ at the level of objects and induced by the tensor product of algebra homomorphisms at the level of morphisms.*

Proof. This follows straightforwardly. \square

Proposition 2.91. *There is a monoidal functor $\mathcal{KS} \rightarrow \mathcal{Inv}$, taking a Kirby structure (A, μ) to the algebra-valued invariant of 3-manifolds $(A, Z_{(A, \mu)})$, where $Z_{(A, \mu)} : 3\text{-Mfds} \rightarrow (A, \cdot)$ takes the homeomorphism class of a 3-manifold $Y = S_L^3$ to $\mu(U^+)^{-\sigma_+(L)} \mu(U^-)^{-\sigma_-(L)} \mu(L) \in A$ where L is any surgery presentation of Y and σ_\pm are as in Definition 2.75. In particular, for any 3-manifold Y and any $(A, \mu), (B, \nu) \in \mathcal{KS}$, we have*

$$(2.38) \quad Z_{((A, \mu) \otimes (B, \nu))}(Y) = Z_{(A, \mu)}(Y) \otimes Z_{(B, \nu)}(Y),$$

the equality (2.38) is in $A \otimes B$. Moreover, if $\phi : (A, \mu) \rightarrow (B, \nu)$ is a morphism of Kirby structures and $Y \in 3\text{-Mfds}$, then $Z_{(B, \nu)}(Y) = \phi(Z_{(A, \mu)}(Y))$ as elements of B .

Proof. Let (A, μ) be a Kirby structure. Then the monoid morphism $Z_{(A, \mu)}$ is well-defined by Proposition 2.78. The assignment $(A, \mu) \rightarrow (A, Z_{(A, \mu)})$ therefore takes objects of \mathcal{KS} to objects of \mathcal{Inv} . A morphism $\phi : (A, \mu) \rightarrow (B, \nu)$ in \mathcal{KS} is an algebra homomorphism $\phi : A \rightarrow B$ such that $\nu = \phi \circ \mu$. One then checks that ϕ sets up a morphism $(A, Z_{(A, \mu)}) \rightarrow (B, Z_{(B, \nu)})$ in \mathcal{Inv} , which is defined to be the image of $(A, \mu) \rightarrow (B, \nu)$. This defines the announced functor $\mathcal{KS} \rightarrow \mathcal{Inv}$ and one then checks that it has the announced monoidal functor property. \square

Example 2.92. Let (\mathbb{C}, μ_r) be the Kirby structure from Example 2.84. Then the image under the functor $\mathcal{KS} \rightarrow \mathcal{Inv}$ (from Proposition 2.91) is the Reshetikhin-Turaev invariant RT_r from (2.35), that is,

$$Z_{(\mathbb{C}, \mu_r)} = \text{RT}_r.$$

2.9. Kirby structures arising from pre-LMO structures over symmetric monoidal categories.

In this subsection, we first introduce the notion of pre-LMO structures (§2.9.1). Then we show that such a structure gives rise to a semi-Kirby structure (§2.9.3).

2.9.1. *Definition of pre-LMO structure.* Let $\mathcal{S}et_f$ (resp. $\mathcal{S}et_f^*$) be the category whose objects are (resp. pointed) finite sets and set of morphisms given by (resp. pointed) bijections.

Notation 2.93. Let $\tau_{\bullet, \diamond}^{\mathcal{S}et_f} : \bullet \sqcup \diamond \rightarrow \diamond \sqcup \bullet$ denote the natural isomorphism between the functors $\bullet \sqcup \diamond, \diamond \sqcup \bullet : (\mathcal{S}et_f)^2 \rightarrow \mathcal{S}et_f$. in particular, for any finite sets S and S' , the map $\tau_{S, S'}^{\mathcal{S}et_f} : S \sqcup S' \rightarrow S' \sqcup S$ is the canonical bijection between $S \sqcup S'$ and $S' \sqcup S$.

Definition 2.94. A *pre-LMO structure*

$$\mathbf{X} = \left(\left\{ \mathcal{X}(P, \bullet) \right\}_{P \in \vec{\mathcal{B}}r}, \left\{ \text{Tens}^{\mathcal{X}}(P, P')_{\bullet, \bullet'} \right\}_{P, P' \in \vec{\mathcal{B}}r}, \left\{ \text{Comp}^{\mathcal{X}}(P, P')_{\bullet, \bullet'} \right\}_{P, P' \text{ composable in } \vec{\mathcal{B}}r}, \right. \\ \left. \left\{ \text{co}^{\mathcal{X}}(P, \bullet) \right\}_{P \in \vec{\mathcal{B}}r}, \left\{ \text{dbl}_{\mathcal{X}}((P, A), \bullet) \right\}_{P \in \vec{\mathcal{B}}r, A \subset \pi_0(P)}, Z_{\mathcal{X}}(\bullet) \right)$$

consists of the following.

(LMO1) The data: For each $P \in \vec{\mathcal{B}}r$ a functor $\mathcal{X}(P, \bullet) : \mathcal{S}et_f \rightarrow \mathcal{V}ect$. For each $w \in \{+, -\}^*$ an element $\text{Id}_w^{\mathcal{X}} \in \mathcal{X}(\text{Id}_w, \emptyset)$. For each pair $P, P' \in \vec{\mathcal{B}}r$ a natural transformation $\text{Tens}^{\mathcal{X}}(P, P')_{\bullet, \diamond} : \mathcal{X}(P, \bullet) \otimes \mathcal{X}(P', \diamond) \rightarrow \mathcal{X}(P \otimes P', \bullet \sqcup \diamond)$ from the functor $\mathcal{X}(P, \bullet) \otimes \mathcal{X}(P', \diamond) : \mathcal{S}et_f \times \mathcal{S}et_f \rightarrow \mathcal{V}ect$ to the functor $\mathcal{X}(P \otimes P', \bullet \sqcup \diamond) : \mathcal{S}et_f \times \mathcal{S}et_f \rightarrow \mathcal{V}ect$. And for every composable $P, P' \in \vec{\mathcal{B}}r$ a natural transformation $\text{Comp}^{\mathcal{X}}(P, P')_{\bullet, \diamond} : \mathcal{X}(P, \bullet) \otimes \mathcal{X}(P', \diamond) \rightarrow \mathcal{X}(P' \circ P, \bullet \sqcup \diamond \sqcup \text{Cir}(P', P))$ from the functor $\mathcal{X}(P, \bullet) \otimes \mathcal{X}(P', \diamond) : \mathcal{S}et_f \rightarrow \mathcal{V}ect$ to the functor $\mathcal{X}(P' \circ P, \bullet \sqcup \diamond \sqcup \text{Cir}(P', P)) : \mathcal{S}et_f \rightarrow \mathcal{V}ect$.

The conditions:

(a) For any $P \in \vec{\mathcal{B}}r$, any $S \in \mathcal{S}et_f$ and any $x \in \mathcal{X}(P, S)$ we have

$$\text{Comp}^{\mathcal{X}}(P, \text{Id}_{\text{t}(P)})_{S, \emptyset} (x \otimes \text{Id}_{\text{t}(P)}^{\mathcal{X}}) = x \quad \text{and} \quad \text{Comp}^{\mathcal{X}}(\text{Id}_{\text{s}(P)}, P)_{\emptyset, S} (\text{Id}_{\text{s}(P)}^{\mathcal{X}} \otimes x) = x.$$

(b) For any $P, P', P'' \in \vec{\mathcal{B}}r$, we have

$$\text{Tens}^{\mathcal{X}}(P \otimes P', P'')_{\bullet \sqcup \diamond, \star} \circ (\text{Tens}^{\mathcal{X}}(P, P')_{\bullet, \diamond} \otimes \text{Id}_{\mathcal{X}(P'', \star)}) \\ = \text{Tens}^{\mathcal{X}}(P, P' \otimes P'')_{\bullet, \diamond \sqcup \star} \circ (\text{Id}_{\mathcal{X}(P, \bullet)} \otimes \text{Tens}^{\mathcal{X}}(P', P'')_{\diamond, \star})$$

and

$$\mathcal{X}(P, \tau_{\bullet, \diamond}^{\mathcal{S}et_f}) \circ \text{Tens}^{\mathcal{X}}(\vec{\emptyset}, P)_{\bullet, \diamond} = \text{Tens}^{\mathcal{X}}(P, \vec{\emptyset})_{\diamond, \bullet} \circ \tau^{\mathcal{V}ect}(\vec{\emptyset}, P)_{\bullet, \diamond}$$

where $\tau^{\mathcal{V}ect}(P, P')_{\bullet, \diamond} : \mathcal{X}(P, \bullet) \otimes \mathcal{X}(P', \diamond) \rightarrow \mathcal{X}(P', \diamond) \otimes \mathcal{X}(P, \bullet)$ is the natural isomorphism induced by switching components in the tensor product of $\mathcal{V}ect$.

(c) For any $P, P', P'' \in \vec{\mathcal{B}}r$ composable, we have

$$\mathcal{X}(P'' \circ P' \circ P, \text{Id}_{\bullet \sqcup \diamond \sqcup \star}) \sqcup \text{bij}_{P'', P', P} \circ \text{Comp}^{\mathcal{X}}(P, P'' \circ P')_{\bullet, \dagger} \circ (\text{Id}_{\mathcal{X}(P, \bullet)} \otimes \text{Comp}^{\mathcal{X}}(P', P'')_{\diamond, \star}) \\ = \theta \circ (\text{Comp}^{\mathcal{X}}(P' \circ P, P'')_{\bullet \sqcup \diamond \sqcup \text{Cir}(P', P), \star}) \circ (\text{Comp}^{\mathcal{X}}(P, P')_{\bullet, \diamond} \otimes \text{Id}_{\mathcal{X}(P'', \star)})$$

where $\dagger := \diamond \sqcup \star \sqcup \text{Cir}(P'', P')$ and $\theta := \mathcal{X}(P'' \circ P' \circ P, \text{Id}_{\bullet \sqcup \diamond} \sqcup \tau_{\text{Cir}(P', P), \star}^{\mathcal{S}et_f} \sqcup \text{Id}_{\text{Cir}(P'', P' \circ P)})$ (see Notation 2.93) and

$$\text{bij}_{P'', P', P} : \text{Cir}(P'', P') \sqcup \text{Cir}(P'' \circ P', P) \longrightarrow \text{Cir}(P', P) \sqcup \text{Cir}(P'', P' \circ P)$$

is the bijection from Proposition 1.10.

(d) For any $P_i, P'_i \in \vec{\mathcal{B}}r$ ($i = 1, 2$) composable, we have

$$\text{Comp}^{\mathcal{X}}(P'_1 \otimes P'_2, P_1 \otimes P_2)_{\bullet_1 \sqcup \bullet_2, \bullet'_1 \sqcup \bullet'_2} \circ (\text{Tens}^{\mathcal{X}}(P_1, P_2)_{\bullet_1, \bullet_2} \otimes \text{Tens}^{\mathcal{X}}(P'_1, P'_2)_{\bullet'_1, \bullet'_2}) \\ = \mathcal{X}((P'_1 \otimes P'_2) \circ (P_1 \otimes P_2), \text{Id}_{\bullet_1} \sqcup \tau_{\bullet'_1, \bullet_2}^{\mathcal{S}et_f} \sqcup \text{Id}_{\bullet_2} \sqcup \text{bij}_{P'_1, P_1, P'_2, P_2}) \\ \circ \mathcal{X}((P'_1 \circ P_1) \otimes (P'_2 \circ P_2), \text{Id}_{\bullet_1 \sqcup \bullet'_1} \sqcup \tau_{\text{Cir}(P'_1, P_1), \bullet_2 \sqcup \bullet'_2}^{\mathcal{S}et_f} \sqcup \text{Id}_{\text{Cir}(P'_2, P_2)}) \\ \circ (\text{Tens}^{\mathcal{X}}(P'_1 \circ P_1, P'_2 \circ P_2)_{\bullet_1 \sqcup \bullet'_1 \sqcup \text{Cir}(P'_1, P_1), \bullet_2 \sqcup \bullet'_2 \sqcup \text{Cir}(P'_2, P_2)}) \\ \circ (\text{Comp}^{\mathcal{X}}(P_1, P'_1)_{\bullet_1, \bullet'_1} \otimes \text{Comp}^{\mathcal{X}}(P_2, P'_2)_{\bullet_2, \bullet'_2}) \circ (\text{Id}_{\mathcal{X}(P_1, \bullet_1)} \otimes \tau^{\mathcal{V}ect}(P_2, P'_1)_{\bullet_2, \bullet'_1} \otimes \text{Id}_{\mathcal{X}(P'_2, \bullet'_2)})$$

where

$$\text{bij}_{P'_1, P_1, P'_2, P_2} : \text{Cir}(P'_1, P_1) \sqcup \text{Cir}(P'_2, P_2) \longrightarrow \text{Cir}(P'_1 \otimes P'_2, P_1 \otimes P_2)$$

is the bijection from Lemma 1.39.

(LMO2) The data: For any $P \in \vec{\mathcal{B}}r$ a natural involution $\text{co}^{\mathcal{X}}(P, \bullet) : \mathcal{X}(P, \bullet) \rightarrow \mathcal{X}(P, \bullet)$ of the functor $\mathcal{X}(P, \bullet) : \text{Set}_f^* \rightarrow \text{Vect}$ taking the pointed finite set (S, s) to the vector space $\mathcal{X}(P, S)$. In particular, for any S finite set and $s \in S$ there is a linear involution $\text{co}^{\mathcal{X}}(P, (S, s)) : \mathcal{X}(P, S) \rightarrow \mathcal{X}(P, S)$.

The conditions:

(a) For any $s, s' \in S$, we have

$$\text{co}^{\mathcal{X}}(P, (S, s)) \circ \text{co}^{\mathcal{X}}(P, (S, s')) = \text{co}^{\mathcal{X}}(P, (S, s')) \circ \text{co}^{\mathcal{X}}(P, (S, s)).$$

(b) For any finite sets S and S' and $s \in S$, the diagram

$$(2.39) \quad \begin{array}{ccc} \mathcal{X}(\vec{\emptyset}, S) \times \mathcal{X}(\vec{\emptyset}, S') & \xrightarrow{\text{Tens}^{\mathcal{X}}(\vec{\emptyset}, \vec{\emptyset})_{S, S'}} & \mathcal{X}(\vec{\emptyset}, S \sqcup S') \\ \text{co}^{\mathcal{X}}(\vec{\emptyset}, (S, s)) \times \text{Id}_{\mathcal{X}(\vec{\emptyset}, S')} \downarrow & & \downarrow \text{co}^{\mathcal{X}}(\vec{\emptyset}, (S \sqcup S', s)) \\ \mathcal{X}(\vec{\emptyset}, S) \times \mathcal{X}(\vec{\emptyset}, S') & \xrightarrow{\text{Tens}^{\mathcal{X}}(\vec{\emptyset}, \vec{\emptyset})_{S, S'}} & \mathcal{X}(\vec{\emptyset}, S \sqcup S') \end{array}$$

commutes, where in the right vertical arrow we identify s with an element of $S \sqcup S'$ via the inclusion $S \subset S \sqcup S'$.

(LMO3) The data: for any $P \in \vec{\mathcal{B}}r$ and $A \subset \pi_0(P)$ a natural transformation

$$\text{dbl}_{\mathcal{X}}(P, A)(\bullet) : \mathcal{X}(P, \bullet) \rightarrow \mathcal{X}(\text{dbl}_{\vec{\mathcal{B}}r}(P, A), \bullet)$$

between the functors $\mathcal{X}(P, \bullet) : \text{Set}_f \rightarrow \text{Vect}$ and $\mathcal{X}(\text{dbl}_{\vec{\mathcal{B}}r}(P, A), \bullet) : \text{Set}_f \rightarrow \text{Vect}$, in particular, for any finite set S there is a linear map $\text{dbl}_{\mathcal{X}}(P, A)(S) : \mathcal{X}(P, S) \rightarrow \mathcal{X}(\text{dbl}_{\vec{\mathcal{B}}r}(P, A), S)$.

The condition: for any $P, P' \in \vec{\mathcal{B}}r$ and $A \subset \pi_0(P)$, the diagram of natural transformations

$$(2.40) \quad \begin{array}{ccc} \mathcal{X}(P, \bullet) \times \mathcal{X}(P', \diamond) & \xrightarrow{\text{Tens}^{\mathcal{X}}(P, P')_{\bullet, \diamond}} & \mathcal{X}(P \otimes P', \bullet \sqcup \diamond) \\ \text{dbl}_{\mathcal{X}}(P, A)(\bullet) \times \text{Id}_{\mathcal{X}(P', \diamond)} \downarrow & & \downarrow \text{dbl}_{\mathcal{X}}(P \otimes P', A)(\bullet \sqcup \diamond) \\ \mathcal{X}(\text{dbl}_{\vec{\mathcal{B}}r}(P, A), \bullet) \times \mathcal{X}(P', \diamond) & & \mathcal{X}(\text{dbl}_{\vec{\mathcal{B}}r}(P \otimes P', A), \bullet \sqcup \diamond) \\ & \searrow \text{Tens}^{\mathcal{X}}(\text{dbl}_{\vec{\mathcal{B}}r}(P, A), P')_{\bullet, \diamond} & \swarrow \\ & \mathcal{X}(\text{dbl}_{\vec{\mathcal{B}}r}(P, A) \otimes P', \bullet \sqcup \diamond) & \end{array}$$

commutes. In the right vertical arrow we identify $A \subset \pi_0(P)$ as a subset of $\pi_0(P \otimes P')$, still denoted by A , via the inclusion $\pi_0(P) \subset \pi_0(P \otimes P')$. The equality in Diagram (2.40) follows from the equality in Lemma 1.41(c).

(LMO4) The data: an assignment $\mathcal{P}a\vec{\mathcal{T}} \ni \mathbf{T} \mapsto Z_{\mathcal{X}}(\mathbf{T}) \in \mathcal{X}(\vec{\text{br}}(\mathbf{T}), \pi_0(\mathbf{T})_{\text{circ}})$.

The conditions:

(a) For any $w \in \{+, -\}^{(*)}$ we have $Z_{\mathcal{X}}(\text{Id}_w) = \text{Id}_{f(w)}^{\mathcal{X}}$, where $f : \{+, -\}^{(*)} \rightarrow \{+, -\}^*$ is the forgetful parenthesization map.

(b) For any $\mathbf{T}, \mathbf{T}' \in \mathcal{P}a\vec{\mathcal{T}}$,

$$\text{Tens}^{\mathcal{X}}(\vec{\text{br}}(\mathbf{T}), \vec{\text{br}}(\mathbf{T}'))_{\pi_0(\mathbf{T})_{\text{cir}}, \pi_0(\mathbf{T}')_{\text{cir}}} (Z_{\mathcal{X}}(\mathbf{T}) \otimes Z_{\mathcal{X}}(\mathbf{T}')) = Z_{\mathcal{X}}(\mathbf{T} \otimes \mathbf{T}'),$$

where the ambient vector spaces of both sides are identified using Lemma 2.19(a).

(c) For any composable $\mathbf{T}, \mathbf{T}' \in \mathcal{P}a\vec{\mathcal{T}}$,

$$\text{Comp}^{\mathcal{X}}(\vec{\text{br}}(\mathbf{T}), \vec{\text{br}}(\mathbf{T}'))_{\pi_0(\mathbf{T})_{\text{cir}}, \pi_0(\mathbf{T}')_{\text{cir}}} (Z_{\mathcal{X}}(\mathbf{T}) \otimes Z_{\mathcal{X}}(\mathbf{T}')) = Z_{\mathcal{X}}(\mathbf{T}' \circ \mathbf{T}),$$

where the ambient vector spaces of both sides are identified using Lemma 2.19(b).

(d) Let $\mathbf{T} \in \mathcal{Pa}\vec{\mathcal{T}}$ and $s \in \pi_0(\mathbf{T})_{\text{cir}}$. Then

$$Z_{\mathcal{X}}(\text{co}_{\vec{\mathcal{T}}}(\mathbf{T}, s)) = \text{co}^{\mathcal{X}}(\vec{\text{br}}(\mathbf{T}), (\pi_0(\mathbf{T})_{\text{cir}}, s))(Z_{\mathcal{X}}(\mathbf{T}))$$

where the ambient vector spaces of both sides in the equality are identified using Lemma 2.27.

(e) Let $\mathbf{T} \in \mathcal{Pa}\vec{\mathcal{T}}$ and $A \subset \pi_0(\mathbf{T})_{\text{seg}} \simeq \pi_0(\vec{\text{br}}(\mathbf{T}))$. Then

$$Z_{\mathcal{X}}(\text{dbl}_{\vec{\mathcal{T}}}(\mathbf{T}, A)) = \text{dbl}_{\mathcal{X}}(\vec{\text{br}}(\mathbf{T}), A)(\pi_0(\mathbf{T})_{\text{cir}})(Z_{\mathcal{X}}(\mathbf{T})),$$

where the ambient vector spaces of both sides are identified using Lemma 2.32.

2.9.2. *The coinvariant space functor applied to a pre-LMO structure.* In this subsection, we fix a pre-LMO structure \mathbf{X} .

Definition 2.95. Define the category of *vector spaces endowed with a group action*, denoted by $\mathcal{Vect}\mathcal{Gp}$, as follows. The objects are pairs (G, V) where G is a group and V is a G -module. Let (G, V) and (G', V') be objects of $\mathcal{Vect}\mathcal{Gp}$. A morphism $(G, V) \rightarrow (G', V')$ is a pair (φ, f) , where $\varphi : G \rightarrow G'$ is a group homomorphism and $f : V \rightarrow V'$ is a linear map, satisfying $f(g \cdot v) = \varphi(g) \cdot f(v)$ for any $g \in G$ and $v \in V$.

Recall that for G a group acting on a vector space V , i.e. for an object (G, V) of $\mathcal{Vect}\mathcal{Gp}$, the space of coinvariants V_G is the quotient of V by the subspace generated by $g \cdot v - v$ where $v \in V$ and $g \in G$.

Lemma 2.96. *There is a functor $\mathcal{Vect}\mathcal{Gp} \rightarrow \mathcal{Vect}$, which we call the coinvariant space functor, defined by $(G, V) \mapsto V_G$ at the level of objects and taking a morphism $(\varphi, f) : (G, V) \rightarrow (G', V')$ in $\mathcal{Vect}\mathcal{Gp}$ to the unique linear map $f_{\varphi} : V_G \rightarrow V'_{G'}$ such that $f_{\varphi} \circ \text{proj}_{(G, V)} = \text{proj}_{(G', V')} \circ f$, where $\text{proj}_{(G, V)} : V \rightarrow V_G$ is the canonical projection.*

Proof. The proof is straightforward. □

Definition 2.97. Let $k \in \mathbb{Z}_{\geq 0}$ and $P \in \vec{\mathcal{B}}r$. The action of \mathfrak{S}_k on $\llbracket 1, k \rrbracket$ induces an action of \mathfrak{S}_k on the vector space $\mathcal{X}(P, \llbracket 1, k \rrbracket)$. We set $\mathcal{X}(P)_k := \mathcal{X}(P, \llbracket 1, k \rrbracket)_{\mathfrak{S}_k}$ for $k \geq 1$ and $\mathcal{X}(P)_0 := \mathcal{X}(P, \emptyset)$. By convention, we denote $\mathcal{X}(\vec{\emptyset})_k$ by \mathcal{X}_k .

Lemma 2.98. *Let $P \in \vec{\mathcal{B}}r$ and S be a finite set. The map $\text{proj}_{P, S}^{\mathcal{X}} : \mathcal{X}(P, S) \rightarrow \mathcal{X}(P)_{|S|}$ obtained by the composition of the isomorphism $\mathcal{X}(P, S) \rightarrow \mathcal{X}(P, \llbracket 1, |S| \rrbracket)$ induced by the choice of a bijection $S \simeq \llbracket 1, |S| \rrbracket$ and of the canonical projection $\mathcal{X}(P, \llbracket 1, |S| \rrbracket) \rightarrow \mathcal{X}(P)_{|S|}$ is independent of the choice of such a bijection.*

Proof. Direct verification. □

Lemma 2.99. *Let $P, P' \in \vec{\mathcal{B}}r$ and $k, k' \in \mathbb{Z}_{\geq 0}$.*

(a) *The pair of the vector space morphism*

$$\text{Tens}^{\mathcal{X}}(P, P')_{\llbracket 1, k \rrbracket, \llbracket 1, k' \rrbracket} : \mathcal{X}(P, \llbracket 1, k \rrbracket) \otimes \mathcal{X}(P', \llbracket 1, k' \rrbracket) \longrightarrow \mathcal{X}(P \otimes P', \llbracket 1, k \rrbracket \sqcup \llbracket 1, k' \rrbracket)$$

and of the group morphism $\mathfrak{S}_k \times \mathfrak{S}_{k'} \rightarrow \mathfrak{S}_{k+k'}$ induces a linear map

$$\mathcal{X}(P)_k \otimes \mathcal{X}(P')_{k'} \longrightarrow \mathcal{X}(P \otimes P')_{k+k'}$$

which will be denoted $x \otimes x' \mapsto x \otimes_{\mathcal{X}} x'$ for any $x \in \mathcal{X}(P)_k$ and $x' \in \mathcal{X}(P')_{k'}$.

(b) *Assume that P, P' are composable. The pair of the vector space morphism*

$$\text{Comp}^{\mathcal{X}}(P, P')_{\llbracket 1, k \rrbracket, \llbracket 1, k' \rrbracket} : \mathcal{X}(P, \llbracket 1, k \rrbracket) \otimes \mathcal{X}(P', \llbracket 1, k' \rrbracket) \longrightarrow \mathcal{X}(P \otimes P', \llbracket 1, k \rrbracket \sqcup \llbracket 1, k' \rrbracket) \sqcup \text{Cir}(P', P)$$

and of the group morphism $\mathfrak{S}_{\llbracket 1, k \rrbracket} \times \mathfrak{S}_{\llbracket 1, k' \rrbracket} \rightarrow \mathfrak{S}_{\llbracket 1, k' \rrbracket \sqcup \llbracket 1, k \rrbracket} \sqcup \text{Cir}(P', P)}$ induces a linear map

$$\mathcal{X}(P)_k \otimes \mathcal{X}(P')_{k'} \longrightarrow \mathcal{X}(P' \circ P)_{k+k'+|\text{Cir}(P', P)|}$$

which will be denoted $x \otimes x' \mapsto x' \circ_{\mathcal{X}} x$ for any $x \in \mathcal{X}(P)_k$ and $x' \in \mathcal{X}(P')_{k'}$.

Proof. The fact the mentioned pairs of vector space and group morphisms are morphisms in the category $\mathcal{Vect}\mathcal{Gp}$ follows from the naturality of the transformations $\text{Tens}^{\mathcal{X}}(P, P')_{\bullet, \diamond}$ and $\text{Comp}^{\mathcal{X}}(P, P')_{\bullet, \diamond}$. □

Lemma 2.100. *The operations $\otimes_{\mathcal{X}}$ and $\circ_{\mathcal{X}}$ have the following properties:*

(a) For any $P \in \vec{\mathcal{B}}r$, any $k \in \mathbb{Z}_{\geq 0}$ and any $x \in \mathcal{X}(P)_k$ we have

$$x \circ_{\mathcal{X}} \text{Id}_{\mathfrak{t}(P)}^{\mathcal{X}} = x = \text{Id}_{\mathfrak{s}(P)}^{\mathcal{X}} \circ_{\mathcal{X}} x.$$

The equality is in $\mathcal{X}(P)_k$, where $\text{Id}_{\mathfrak{s}(P)}^{\mathcal{X}} \in \mathcal{X}(\text{Id}_{\mathfrak{s}(P)})_0$ and $\text{Id}_{\mathfrak{t}(P)}^{\mathcal{X}} \in \mathcal{X}(\text{Id}_{\mathfrak{t}(P)})_0$.

(b) For any $P, P', P'' \in \vec{\mathcal{B}}r$, any $k, k', k'' \in \mathbb{Z}_{\geq 0}$ and $x \in \mathcal{X}(P)_k, x' \in \mathcal{X}(P')_{k'}, x'' \in \mathcal{X}(P'')_{k''}$ and $y \in \mathcal{X}_{k'}$ we have

$$(x \otimes_{\mathcal{X}} x') \otimes_{\mathcal{X}} x'' = x \otimes_{\mathcal{X}} (x' \otimes_{\mathcal{X}} x'') \quad \text{and} \quad x \otimes_{\mathcal{X}} y = y \otimes_{\mathcal{X}} x.$$

The first equality is in $\mathcal{X}(P \otimes P' \otimes P'')_{k+k'+k''}$ and the second one in $\mathcal{X}(P)_{k+k'}$.

(c) For any $P, P', P'' \in \vec{\mathcal{B}}r$ composable, any $k, k', k'' \in \mathbb{Z}_{\geq 0}$ and $x \in \mathcal{X}(P)_k, x' \in \mathcal{X}(P')_{k'}$ and $x'' \in \mathcal{X}(P'')_{k''}$ we have

$$(x'' \circ_{\mathcal{X}} x') \circ_{\mathcal{X}} x = x'' \circ_{\mathcal{X}} (x' \circ_{\mathcal{X}} x).$$

The equality is in $\mathcal{X}(P'' \circ P' \circ P)_{k+k'+k''+|\text{Cir}(P',P)|+|\text{Cir}(P'',P' \circ P)|}$ (note that

$$|\text{Cir}(P', P)| + |\text{Cir}(P'', P' \circ P)| = |\text{Cir}(P'', P')| + |\text{Cir}(P'' \circ P', P)|$$

by Proposition 1.10).

(d) For any $P_i, P'_i \in \vec{\mathcal{B}}r$ ($i = 1, 2$) composable, any $k_i, k'_i \in \mathbb{Z}_{\geq 0}$ and any $x_i \in \mathcal{X}(P_i)_{k_i}, x'_i \in \mathcal{X}(P'_i)_{k'_i}$ ($i = 1, 2$) we have

$$(x'_1 \otimes_{\mathcal{X}} x'_2) \circ_{\mathcal{X}} (x_1 \otimes_{\mathcal{X}} x_2) = (x'_1 \circ_{\mathcal{X}} x_1) \otimes_{\mathcal{X}} (x'_2 \circ_{\mathcal{X}} x_2).$$

The equality is in $\mathcal{X}((P'_1 \circ P_1) \otimes (P'_2 \circ P_2))_{k_1+k'_1+|\text{Cir}(P'_1,P_1)|+k_2+k'_2+|\text{Cir}(P'_2,P_2)|}$.

Proof. The result follows by applying the coinvariant space functor to the identities from the axiom (LMO1) in Definition 2.94. \square

Lemma 2.101. Let $P \in \vec{\mathcal{B}}r$ and $A \subset \pi_0(P)$, and $k \in \mathbb{Z}_{\geq 0}$, the map $\text{dbl}_{\mathcal{X}}(P, A)(\llbracket 1, k \rrbracket) : \mathcal{X}(P, \llbracket 1, k \rrbracket) \rightarrow \mathcal{X}(\text{dbl}_{\vec{\mathcal{B}}r}(P, A), \llbracket 1, k \rrbracket)$ (obtained from axiom (LMO3) in Definition 2.94) is \mathfrak{S}_k -equivariant; denote by

$$\text{dbl}_{\mathcal{X}}(P, A)_k : \mathcal{X}(P)_k \longrightarrow \mathcal{X}(\text{dbl}_{\vec{\mathcal{B}}r}(P, A))_k$$

the induced linear map.

Proof. The result follows from the naturality of the transformation $\text{dbl}_{\mathcal{X}}(P, A)(\bullet)$. \square

Lemma 2.102. Let $P, P' \in \vec{\mathcal{B}}r$, $A \subset \pi_0(P)$, $k, k' \in \mathbb{Z}_{\geq 0}$ and $x \in \mathcal{X}(P)_k, x' \in \mathcal{X}(P')_{k'}$. Then

$$\text{dbl}_{\mathcal{X}}(P \otimes P', A)_{k+k'}(x \otimes_{\mathcal{X}} x') = \text{dbl}_{\mathcal{X}}(P, A)_k(x) \otimes_{\mathcal{X}} x'.$$

On the left-hand side of the equality we see $A \subset \pi_0(P \otimes P')$ through the canonical inclusion $\pi_0(P) \subset \pi_0(P \otimes P')$. The equality is in $\mathcal{X}(\text{dbl}_{\vec{\mathcal{B}}r}(P, A) \otimes P')_{k+k'} = \mathcal{X}(\text{dbl}_{\vec{\mathcal{B}}r}(P \otimes P', A))_{k+k'}$ (notice that $\text{dbl}_{\vec{\mathcal{B}}r}(P, A) \otimes P' = \text{dbl}_{\vec{\mathcal{B}}r}(P \otimes P', A)$ by Lemma 1.41(c)).

Proof. The result follows applying the coinvariant space functor to the equality arising from the commutative diagram (2.40) in (LMO3) with $\bullet = \llbracket 1, k \rrbracket$ and $\diamond = \llbracket 1, k' \rrbracket$. \square

2.9.3. Semi-Kirby structure associated to a pre-LMO structure. In this subsection, we fix a pre-LMO structure \mathbf{X} . From now on, if \mathbf{T} is a parenthesized framed oriented tangle such that $\pi_0(\mathbf{T})_{\text{cir}} = \emptyset$, we see $Z_{\mathcal{X}}(\mathbf{T})$ as an element of $\mathcal{X}(\text{br}(\mathbf{T}))_0 = \mathcal{X}(\text{br}(\mathbf{T}), \emptyset)$, see Definition 2.97.

Definition 2.103. Let $k \in \mathbb{Z}_{\geq 2}$. Define the map $\text{KIIMap}_{\mathcal{X}, k, +-}^1 : \mathcal{X}(\downarrow \uparrow)_{k-2} \rightarrow \mathcal{X}_k$ by

$$(2.41) \quad \text{KIIMap}_{\mathcal{X}, k, +-}^1(x) := Z_{\mathcal{X}}(\text{cap}_{(+--)(+-)}^{\mathcal{T}}) \circ_{\mathcal{X}} (\text{Id}_{+-}^{\mathcal{X}} \otimes_{\mathcal{X}} x) \circ Z_{\mathcal{X}}(\text{cup}_{(+--)(+-)}^{\mathcal{T}})$$

for any $x \in \mathcal{X}(\downarrow \uparrow)_{k-2}$. The elements $\text{cap}_{(+--)(+-)}^{\mathcal{T}}$ and $\text{cup}_{(+--)(+-)}^{\mathcal{T}}$ in $\mathcal{Pa}\vec{\mathcal{T}}$ are as in Definition 2.58. Similarly, we define a map $\text{KIIMap}_{\mathcal{X}, k, +-}^1 : \mathcal{X}(\uparrow \downarrow)_{k-2} \rightarrow \mathcal{X}_k$ by exchanging $+$ and $-$ in the above formula.

Notice that the above map is well-defined by Lemma 2.99 and the fact that

$$|\text{Cir}(\vec{\text{br}}(\text{cap}_{(+)(+-)}^{\mathcal{T}}), \vec{\text{br}}(\text{cup}_{(+)(+-)}^{\mathcal{T}}))| = 2.$$

Definition 2.104. Let $k \in \mathbb{Z}_{\geq 2}$. Define the map $\text{KIIMap}_{\mathcal{X},k,+}^2 : \mathcal{X}(\downarrow\uparrow)_{k-2} \rightarrow \mathcal{X}_k$ by

$$(2.42) \quad \text{KIIMap}_{\mathcal{X},k,+}^2(x) := Z_{\mathcal{X}}(\text{cap}_{-((++)-)}^{\mathcal{T}}) \circ_{\mathcal{X}} (\text{Id}_{-}^{\mathcal{X}} \otimes_{\mathcal{X}} \text{dbl}_{\mathcal{X}}(\downarrow\uparrow, \downarrow)_{k-2}(x)) \circ_{\mathcal{X}} Z_{\mathcal{X}}(\text{cup}_{-((++)-)}^{\mathcal{T}})$$

for any $x \in \mathcal{X}(\downarrow\uparrow)_{k-2}$. The elements $\text{cap}_{-((++)-)}^{\mathcal{T}}$ and $\text{cup}_{-((++)-)}^{\mathcal{T}}$ are as in Definition 2.60. Similarly, we define a map $\text{KIIMap}_{\mathcal{X},k,-}^2 : \mathcal{X}(\uparrow\downarrow)_{k-2} \rightarrow \mathcal{X}_k$ by exchanging $+$ and $-$ in the above formula.

Lemma 2.105. Let $k \in \mathbb{Z}_{\geq 1}$. The vector space $\mathcal{X}(\vec{\emptyset}, [1, k])$ is equipped both with the action of $\mathfrak{S}_{[2,k]} \simeq \mathfrak{S}_{k-1}$ and \mathfrak{S}_k as in Definition 2.97. The linear map

$$\text{co}^{\mathcal{X}}(\vec{\emptyset}, ([1, k], 1)) : \mathcal{X}(\vec{\emptyset}, [1, k]) \longrightarrow \mathcal{X}(\vec{\emptyset}, [1, k])$$

given by axiom (LMO2) together with the group homomorphism $\mathfrak{S}_{k-1} \simeq \mathfrak{S}_{[2,k]} \rightarrow \mathfrak{S}_k$ determine a morphism in VectGp . Define the linear map

$$\text{co}_k^{\mathcal{X}} : \mathcal{X}(\vec{\emptyset}, [1, k])_{\mathfrak{S}_{k-1}} \rightarrow \mathcal{X}_k$$

to be its image by the coinvariant space functor.

Proof. The result follows from the functor status of the assignment $\mathcal{X}(P, \bullet)$ for any $P \in \vec{\mathcal{B}}r$ and of the natural transformation status of $\text{co}^{\mathcal{X}}$. \square

Definition 2.106. Let $k \in \mathbb{Z}_{\geq 1}$. We denote by $\text{proj}_{1,k-1}^{\mathcal{X}} : \mathcal{X}(\vec{\emptyset}, [1, k])_{\mathfrak{S}_{k-1}} \rightarrow \mathcal{X}_k$ the projection induced by the injective homomorphism $\mathfrak{S}_{k-1} \simeq \mathfrak{S}_{[2,k]} \hookrightarrow \mathfrak{S}_k$ determined by the inclusion $[2, k] \subset [1, k]$.

Definition 2.107. (a) For $k \geq 2$, define the subspaces $(\text{KII}\mathcal{X}_k)$ of \mathcal{X}_k and $(\text{KII}\mathcal{X})$ of $\bigoplus_{k \geq 0} \mathcal{X}_k$ by

$$(2.43) \quad (\text{KII}\mathcal{X}_k) := \text{Im}(\text{KIIMap}_{\mathcal{X},k,+}^2 - \text{KIIMap}_{\mathcal{X},k,+}^1) + \text{Im}(\text{KIIMap}_{\mathcal{X},k,-}^2 - \text{KIIMap}_{\mathcal{X},k,-}^1) \subset \mathcal{X}_k$$

and

$$(2.44) \quad (\text{KII}\mathcal{X}) := \bigoplus_{k \geq 2} (\text{KII}\mathcal{X}_k) \subset \bigoplus_{k \geq 0} \mathcal{X}_k.$$

(b) Let $k \in \mathbb{Z}_{\geq 1}$. Define the subspaces $(\text{CO}\mathcal{X}_k)$ of \mathcal{X}_k and $(\text{CO}\mathcal{X})$ of $\bigoplus_{k \geq 0} \mathcal{X}_k$ by

$$(\text{CO}\mathcal{X}_k) := \text{Im}(\text{co}_k^{\mathcal{X}} - \text{proj}_{1,k-1}^{\mathcal{X}})$$

and

$$(\text{CO}\mathcal{X}) := \bigoplus_{k \geq 1} (\text{CO}\mathcal{X}_k) \subset \bigoplus_{k \geq 0} \mathcal{X}_k.$$

We set $(\text{KII}\mathcal{X}_0) = (\text{KII}\mathcal{X}_1) = (\text{CO}\mathcal{X}_0) = \{0\}$.

Lemma 2.108. Let $A := \bigoplus_{k \geq 0} \mathcal{X}_k$, $M_{+-} := \bigoplus_{k \geq 2} \mathcal{X}(\downarrow\uparrow)_{k-2}$, $M_{-+} := \bigoplus_{k \geq 2} \mathcal{X}(\uparrow\downarrow)_{k-2}$, and let $f_{+-} : M_{+-} \rightarrow A$ and $f_{-+} : M_{-+} \rightarrow A$ be the linear maps defined by

$$f_{+-} := \bigoplus_{k \geq 2} (\text{KIIMap}_{\mathcal{X},k,+}^2 - \text{KIIMap}_{\mathcal{X},k,+}^1) \quad \text{and} \quad f_{-+} := \bigoplus_{k \geq 2} (\text{KIIMap}_{\mathcal{X},k,-}^2 - \text{KIIMap}_{\mathcal{X},k,-}^1).$$

Then A is a commutative algebra, M_{+-} and M_{-+} are right A -modules, and f_{+-} , f_{-+} and $f := f_{+-} + f_{-+}$ are morphisms of right A -modules, the algebra A being equipped with its regular module structure over itself.

Proof. The direct sum over $k, k' \geq 0$ of the linear maps $\mathcal{X}_k \otimes \mathcal{X}_{k'} \rightarrow \mathcal{X}_{k+k'}$ (given as in Lemma 2.99(a) with $P = P' = \vec{\emptyset}$) induces a graded product on $\bigoplus_{k \geq 0} \mathcal{X}_k$ which is associative and commutative by Lemma 2.100(b). One could also check that the same product structure on $\bigoplus_{k \geq 0} \mathcal{X}_k$ is induced by the maps $\circ_{\mathcal{X}}$ given as in Lemma 2.99(b) with $P = P' = \vec{\emptyset}$.

The direct sum over $k \geq 2$ and $k' \geq 0$ of the linear maps $\mathcal{X}(\downarrow\uparrow)_{k-2} \otimes \mathcal{X}_{k'} \rightarrow \mathcal{X}(\downarrow\uparrow)_{k+k'-2}$ (given as in Lemma 2.99(a) with $P = \downarrow\uparrow$ and $P' = \vec{\emptyset}$) induces a linear map $M_{+-} \otimes A \rightarrow M_{+-}$. The fact that it defines a right A -module structure over M_{+-} is a consequence of Lemma 2.100(b). One similarly defines a right A -module map $M_{-+} \otimes A \rightarrow M_{-+}$. Let us show that $f_{+-} : M_{+-} \rightarrow A$ is a morphism of right A -modules.

Let $k \geq 2$, $l \geq 0$, $m \in \mathcal{X}(\downarrow\uparrow)_{k-2}$ and $a \in \mathcal{X}_l$. By the definition of $\text{KIIMap}_{\mathcal{X}, k-2+l, +-}^1$ and Lemma 2.100(b) and (d) we have

$$\text{KIIMap}_{\mathcal{X}, k-2+l, +-}^1(m \otimes_{\mathcal{X}} a) = \text{KIIMap}_{\mathcal{X}, k-2+l, +-}^1(m) \otimes_{\mathcal{X}} a$$

Using in addition Lemma 2.102, we obtain

$$\text{KIIMap}_{\mathcal{X}, k-2+l, +-}^2(m \otimes_{\mathcal{X}} a) = \text{KIIMap}_{\mathcal{X}, k-2, +-}^2(m) \otimes_{\mathcal{X}} a.$$

This implies that for $i = 1, 2$, the map $\bigoplus_k \text{KIIMap}_{\mathcal{X}, k, +-}^i$ defines a right A -module homomorphism $M_{+-} \rightarrow A$. One has $f_{+-} = \bigoplus_k \text{KIIMap}_{\mathcal{X}, k, +-}^1 - \bigoplus_k \text{KIIMap}_{\mathcal{X}, k, +-}^2$, therefore $f_{+-} : M_{+-} \rightarrow A$ is a right A -module homomorphism. One proves similarly that $f_{-+} : M_{-+} \rightarrow A$ is a right A -module homomorphism. \square

Lemma 2.109. *Consider the commutative $\mathbb{Z}_{\geq 0}$ -graded algebra $A := \bigoplus_{k \geq 0} \mathcal{X}_k$ (see Lemma 2.108). Then*

- (a) $N := \bigoplus_k \mathcal{X}(\vec{\emptyset}, [1, k])_{\mathfrak{S}_{k-1}}$ is a right A -module.
- (b) Recall the maps $\text{proj}_{1, k-1}^{\mathcal{X}} : \mathcal{X}(\vec{\emptyset}, [1, k])_{\mathfrak{S}_{k-1}} \rightarrow \mathcal{X}_k$ and $\text{co}_k^{\mathcal{X}} : \mathcal{X}(\vec{\emptyset}, [1, k])_{\mathfrak{S}_{k-1}} \rightarrow \mathcal{X}_k$ from Definition 2.106 and Lemma 2.105, respectively. Then $\bigoplus_{k \geq 1} \text{proj}_{1, k-1}^{\mathcal{X}} : N \rightarrow A$ and $\bigoplus_k \text{co}_k^{\mathcal{X}} : N \rightarrow A$ are homomorphisms of A -modules.
- (c) $\bigoplus_{k \geq 1} (\text{proj}_k^{\mathcal{X}} - \text{co}_k^{\mathcal{X}}) : N \rightarrow A$ is a homomorphism of A -modules.

Proof. (a) Let $k, k' \in \mathbb{Z}_{\geq 0}$. The map $\text{Tens}^{\mathcal{X}}(\vec{\emptyset}, \vec{\emptyset})_{[1, k], [1, k']}$ is compatible with the group homomorphism $\mathfrak{S}_{k-1} \times \mathfrak{S}_{k'} \rightarrow \mathfrak{S}_{k+k'}$ defined by the composition of the inclusion $\mathfrak{S}_{k-1} \times \mathfrak{S}_{k'} \subset \mathfrak{S}_k \times \mathfrak{S}_{k'}$ with the concatenation group homomorphism $\mathfrak{S}_k \times \mathfrak{S}_{k'} \rightarrow \mathfrak{S}_{k+k'}$ and defines therefore a morphism in the category $\text{Vect}\mathcal{G}p$. Taking its image by the coinvariant space functor, we obtain a linear map $\mathcal{X}(\vec{\emptyset}, [1, k])_{\mathfrak{S}_{k-1}} \times \mathcal{X}_{k'} \rightarrow \mathcal{X}(\vec{\emptyset}, [1, k])_{\mathfrak{S}_{k+k'-1}}$. The direct sum over k and k' of these maps defines a linear map $N \otimes A \rightarrow A$. The module property of this map follows from the associativity axioms for the natural transformation $\text{Tens}^{\mathcal{X}}(\vec{\emptyset}, \vec{\emptyset})_{\bullet, \circ}$, see (LMO1) (b).

(b) The fact that the map $\bigoplus_{k \geq 1} \text{proj}_{1, k-1}^{\mathcal{X}} : N \rightarrow A$ is a homomorphism of A -modules follows from the commutative diagram obtained as the direct sum over k and k' of the images by the coinvariant space functor of the commutative diagram in the category $\text{Vect}\mathcal{G}p$ with underlying vector spaces and groups diagrams

$$\begin{array}{ccc} \mathcal{X}(\vec{\emptyset}, [1, k]) \otimes \mathcal{X}(\vec{\emptyset}, [1, k']) & \xrightarrow{\text{Tens}^{\mathcal{X}}(\vec{\emptyset}, \vec{\emptyset})_{[1, k], [1, k']}} & \mathcal{X}(\vec{\emptyset}, [1, k+k']) \\ \text{Id} \otimes \text{Id} \downarrow & & \downarrow \text{Id} \\ \mathcal{X}(\vec{\emptyset}, [1, k]) \otimes \mathcal{X}(\vec{\emptyset}, [1, k']) & \xrightarrow{\text{Tens}^{\mathcal{X}}(\vec{\emptyset}, \vec{\emptyset})_{[1, k], [1, k']}} & \mathcal{X}(\vec{\emptyset}, [1, k+k']) \end{array}$$

and

$$(2.45) \quad \begin{array}{ccc} \mathfrak{S}_{k-1} \times \mathfrak{S}_{k'} & \xrightarrow{\text{conc}_{k-1, k'}} & \mathfrak{S}_{k+k'-1} \\ \downarrow & & \downarrow \\ \mathfrak{S}_k \times \mathfrak{S}_{k'} & \xrightarrow{\text{conc}_{k, k'}} & \mathfrak{S}_{k+k'} \end{array}$$

where $\text{conc}_{k, l} : \mathfrak{S}_k \times \mathfrak{S}_l \rightarrow \mathfrak{S}_{k+l}$ is the concatenation group homomorphism $(\sigma, \tau) \mapsto \sigma * \tau \in \mathfrak{S}_{[1, k] \sqcup [1, l]} \simeq \mathfrak{S}_{k+l}$, see Definition 1.17. The fact that $\bigoplus_{k \geq 1} \text{co}_k^{\mathcal{X}} : N \rightarrow A$ is a homomorphism of A -modules follows from the commutative diagram obtained as the direct sum over k and k' of the images by the coinvariant

space functor of the commutative diagrams in $\mathcal{VectGrp}$ with underlying groups diagram (2.45) and vector spaces diagram

$$\begin{array}{ccc} \mathcal{X}(\vec{\emptyset}, [1, k]) \otimes \mathcal{X}(\vec{\emptyset}, [1, k']) & \xrightarrow{\text{Tens}^{\mathcal{X}}(\vec{\emptyset}, \vec{\emptyset})_{[1, k], [1, k']}} & \mathcal{X}(\vec{\emptyset}, [1, k + k']) \\ \text{co}^{\mathcal{X}}(\vec{\emptyset}, ([1, k], 1)) \otimes \text{Id} \downarrow & & \downarrow \text{co}^{\mathcal{X}}(\vec{\emptyset}, ([1, k + k'], 1)) \\ \mathcal{X}(\vec{\emptyset}, [1, k]) \otimes \mathcal{X}(\vec{\emptyset}, [1, k']) & \xrightarrow{\text{Tens}^{\mathcal{X}}(\vec{\emptyset}, \vec{\emptyset})_{[1, k], [1, k']}} & \mathcal{X}(\vec{\emptyset}, [1, k + k']). \end{array}$$

The latter diagram is commutative because of axioms (LMO1) (b) and (LMO2) (d).

(c) Follows from (b) and the A -module homomorphism property of the difference map $A \oplus A \rightarrow A$ taking (x, y) to $x - y$ for any $x, y \in A$. □

Proposition 2.110. *Consider the commutative $\mathbb{Z}_{\geq 0}$ -graded algebra $\bigoplus_{k \geq 0} \mathcal{X}_k$ (see Lemma 2.108). Then*

- (a) *The subspaces $(\text{KII}\mathcal{X})$, $(\text{CO}\mathcal{X})$ and $(\text{KII}\mathcal{X}) + (\text{CO}\mathcal{X})$ are $\mathbb{Z}_{\geq 0}$ -graded ideals of $\bigoplus_{k \geq 0} \mathcal{X}_k$. The quotient*

$$(2.46) \quad \mathfrak{s}(\mathbf{X}) = \frac{\bigoplus_{k \geq 0} \mathcal{X}_k}{(\text{KII}\mathcal{X}) + (\text{CO}\mathcal{X})}$$

is therefore a $\mathbb{Z}_{\geq 0}$ -graded algebra. Explicitly, $\mathfrak{s}(\mathbf{X}) = \bigoplus_{k \geq 0} \mathfrak{s}(\mathbf{X})_k$ where

$$(2.47) \quad \mathfrak{s}(\mathbf{X})_k = \frac{\mathcal{X}_k}{(\text{KII}\mathcal{X}_k) + (\text{CO}\mathcal{X}_k)}.$$

- (b) *Let $k \in \mathbb{Z}_{\geq 0}$. Let $Z_{\mathcal{X}, k} : \vec{\mathcal{T}}(\vec{\emptyset}, \vec{\emptyset})_k \rightarrow \mathcal{X}_k$ be the map such that for any $\mathbf{T} \in \vec{\mathcal{T}}(\vec{\emptyset}, \vec{\emptyset})_k$ one has $Z_{\mathcal{X}, k}(\mathbf{T}) := \text{proj}_{\vec{\emptyset}, \pi_0(\mathbf{T})_{\text{cir}}}^{\mathcal{X}}(Z_{\mathcal{X}}(\mathbf{T}))$ where $\text{proj}_{\vec{\emptyset}, \pi_0(\mathbf{T})_{\text{cir}}}^{\mathcal{X}} : \mathcal{X}(\vec{\emptyset}, \pi_0(\mathbf{T})_{\text{cir}}) \rightarrow \mathcal{X}_{|\pi_0(\mathbf{T})_{\text{cir}}|} = \mathcal{X}_k$ is as in Lemma 2.98. There is a unique linear map $\mu_k : \mathfrak{Kir}_k \rightarrow \mathfrak{s}(\mathbf{X})_k$, such that the following diagram of sets commutes,*

$$\begin{array}{ccc} \vec{\mathcal{T}}(\emptyset, \emptyset)_k & \xrightarrow{Z_{\mathcal{X}, k}} & \mathcal{X}_k \\ \downarrow & & \downarrow \\ \mathfrak{Kir}_k & \xrightarrow{\mu_k} & \mathfrak{s}(\mathbf{X})_k, \end{array}$$

where $\vec{\mathcal{T}}(\emptyset, \emptyset)_k$ is as in Lemma 2.22(c). The direct sum over $k \geq 0$ of these maps is an algebra morphism $\mu : \mathfrak{Kir} \rightarrow \mathfrak{s}(\mathbf{X})$, i.e., the pair $(\mathfrak{s}(\mathbf{X}), \mu)$ is a semi-Kirby structure, we call it the semi-Kirby structure associated to \mathbf{X} . Here \mathfrak{Kir} and \mathfrak{Kir}_k are as in Definition 2.81.

Proof. (a) Let $A := \bigoplus_{k \geq 0} \mathcal{X}_k$. By Definition 2.107, $(\text{KII}\mathcal{X})$ and $(\text{CO}\mathcal{X})$ are $\mathbb{Z}_{\geq 0}$ -graded subspaces of A . Both subspaces are defined as images of linear maps with target A . By Lemmas 2.108 and 2.109, their sources are equipped with A -module structures, and the linear maps are A -module morphisms, the target being equipped with the regular A -module structure. This implies that $(\text{KII}\mathcal{X})$ and $(\text{CO}\mathcal{X})$ are ideals of A .

(b) The map $Z_{\mathcal{X}, k}$ extends to a morphism of abelian groups $Z_{\mathcal{X}, k} : \mathbb{Z}\vec{\mathcal{T}}(\emptyset, \emptyset)_k \rightarrow \mathcal{X}_k$. Let us show that $Z_{\mathcal{X}, k}((\text{KII}\vec{\mathcal{T}}_k)) \subset (\text{KII}\mathcal{X}_k)$ and $Z_{\mathcal{X}, k}((\text{CO}\vec{\mathcal{T}}_k)) \subset (\text{CO}\mathcal{X}_k)$, which by Definition 2.81 implies the existence of a map $\mu_k : \mathfrak{Kir}_k \rightarrow \mathfrak{s}(\mathbf{X})_k$.

For $P \in \vec{\mathcal{B}}r$, there is a map $Z_{\mathcal{X}, P, k} : \mathcal{P}a\vec{\mathcal{T}}(P)_k \rightarrow \mathcal{X}(P)_k$ such that for any $\mathbf{T} \in \mathcal{P}a\vec{\mathcal{T}}(P)_k$ one has $Z_{\mathcal{X}, k}(\mathbf{T}) := \text{proj}_{P, \pi_0(\mathbf{T})_{\text{cir}}}^{\mathcal{X}}(Z_{\mathcal{X}}(\mathbf{T}))$ where $\text{proj}_{P, \pi_0(\mathbf{T})_{\text{cir}}}^{\mathcal{X}} : \mathcal{X}(P, \pi_0(\mathbf{T})_{\text{cir}}) \rightarrow \mathcal{X}(P)_{|\pi_0(\mathbf{T})_{\text{cir}}|} = \mathcal{X}(P)_k$ is as in

Lemma 2.98. The commutativity of the diagrams

$$\begin{array}{ccc}
\mathcal{P}a\vec{\mathcal{T}}(\downarrow\uparrow)_{k-2} & \xrightarrow{\widetilde{\text{KII}}\text{map}_{\mathcal{P}a\vec{\mathcal{T}},k,+}^i} & \vec{\mathcal{T}}(\emptyset, \emptyset)_k \\
\downarrow Z_{\mathcal{X},\downarrow\uparrow,k-2} & & \downarrow Z_{\mathcal{X},k} \\
\mathcal{X}(\downarrow\uparrow)_{k-2} & \xrightarrow{\text{KII}\text{map}_{\mathcal{X},k,+}^i} & \mathcal{X}_k
\end{array}
\quad \text{and} \quad
\begin{array}{ccc}
\mathcal{P}a\vec{\mathcal{T}}(\uparrow\downarrow)_{k-2} & \xrightarrow{\widetilde{\text{KII}}\text{map}_{\mathcal{P}a\vec{\mathcal{T}},k,-}^i} & \vec{\mathcal{T}}(\emptyset, \emptyset)_k \\
\downarrow Z_{\mathcal{X},\uparrow\downarrow,k-2} & & \downarrow Z_{\mathcal{X},k} \\
\mathcal{X}(\uparrow\downarrow)_{k-2} & \xrightarrow{\text{KII}\text{map}_{\mathcal{X},k,-}^i} & \mathcal{X}_k
\end{array}$$

follows from axioms (LMO4) (a), (b) and (c) for $i = 1$; and (LMO4) (a), (b), (c) and (e) for $i = 2$. Here $\text{KII}\text{map}_{\mathcal{X},k,+}^i$, $\text{KII}\text{map}_{\mathcal{X},k,-}^i$ for $i = 1, 2$ are as in Definitions 2.103 and 2.104. The above implies the commutativity of the diagram

$$(2.48) \quad
\begin{array}{ccc}
\mathcal{P}a\vec{\mathcal{T}}(\downarrow\uparrow)_{k-2} \times \mathcal{P}a\vec{\mathcal{T}}(\uparrow\downarrow)_{k-2} & \xrightarrow{f_{k,+} \oplus f_{k,-}} & \mathbb{Z}\vec{\mathcal{T}}(\emptyset, \emptyset)_k \\
\downarrow Z_{\mathcal{X},\downarrow\uparrow,k-2} \oplus Z_{\mathcal{X},\uparrow\downarrow,k-2} & & \downarrow Z_{\mathcal{X},k} \\
\mathcal{X}(\downarrow\uparrow)_{k-2} \oplus \mathcal{X}(\uparrow\downarrow)_{k-2} & \xrightarrow{g_{k,+} \oplus g_{k,-}} & \mathcal{X}_k,
\end{array}$$

where

$$\begin{aligned}
f_{k,+} &= \widetilde{\text{KII}}\text{map}_{\mathcal{P}a\vec{\mathcal{T}},k,+}^2 - \widetilde{\text{KII}}\text{map}_{\mathcal{P}a\vec{\mathcal{T}},k,+}^1, & f_{k,-} &= \widetilde{\text{KII}}\text{map}_{\mathcal{P}a\vec{\mathcal{T}},k,-}^2 - \widetilde{\text{KII}}\text{map}_{\mathcal{P}a\vec{\mathcal{T}},k,-}^1, \\
g_{k,+} &= \text{KII}\text{map}_{\mathcal{X},k,+}^2 - \text{KII}\text{map}_{\mathcal{X},k,+}^1 & \text{and} & & g_{k,-} &= \text{KII}\text{map}_{\mathcal{X},k,-}^2 - \text{KII}\text{map}_{\mathcal{X},k,-}^1.
\end{aligned}$$

By Proposition 2.57, $(\text{KII}\vec{\mathcal{T}}_k) = \text{Im}(f_{k,+} \oplus f_{k,-})$. The diagram then implies that $Z_{\mathcal{X},k}((\text{KII}\vec{\mathcal{T}}_k))$ is contained in $\text{Im}(g_{k,+} \oplus g_{k,-})$, which is $(\text{KII}\mathcal{X}_k)$.

Besides, for any $\mathbf{T} \in \vec{\mathcal{T}}(\emptyset, \emptyset)_k$ and $c \in \pi_0(\mathbf{T})_{\text{cir}}$, one has

$$Z_{\mathcal{X},k}(\text{co}_{\vec{\mathcal{T}}}(\mathbf{T}, c)) - Z_{\mathcal{X},k}(\mathbf{T}) = (\text{co}^{\mathcal{X}}(\vec{\partial}, \pi_0(\mathbf{T})_{\text{cir}}) - \text{Id})(Z_{\mathcal{X},k}(\mathbf{T}))$$

by (LMO4) (d), therefore $Z_{\mathcal{X},k}(\text{co}_{\vec{\mathcal{T}}}(\mathbf{T}, c)) - Z_{\mathcal{X},k}(\mathbf{T}) \in \text{CO}\mathcal{X}_k$. It follows that $Z_{\mathcal{X},k}((\text{CO}\vec{\mathcal{T}}_k)) \subset (\text{CO}\mathcal{X}_k)$. This completes the proof of the first statement. The second statement then follows from (LMO1) (b). \square

3. CONSTRUCTION OF A PRE-LMO STRUCTURE BASED ON THE KONTSEVICH INTEGRAL

The purpose of this section is to introduce a pre-LMO structure

$$\begin{aligned}
\mathring{\mathbf{A}} &= \left(\{ \mathring{A}^\wedge(P, \bullet) \}_{P \in \vec{\mathcal{B}}_r}, \{ \text{Tens}^{\mathcal{A}}(P, P')_{\bullet, \bullet'} \}_{P, P' \in \vec{\mathcal{B}}_r}, \{ \text{Comp}^{\mathcal{A}}(P, P')_{\bullet, \bullet'} \}_{P, P' \text{ composable in } \vec{\mathcal{B}}_r}, \right. \\
&\quad \left. \{ \text{co}^{\mathcal{A}}(P, \bullet) \}_{P \in \vec{\mathcal{B}}_r}, \{ \text{dbl}_{\mathcal{A}}((P, A), \bullet) \}_{P \in \vec{\mathcal{B}}_r, A \subset \pi_0(P)}, Z_{\mathcal{A}}(\bullet) \right)
\end{aligned}$$

see Definition 2.94. We start §3.1 with some preliminaries about linear and cyclic orders. In §3.2 (resp. §3.3, §3.4, §3.5 and §3.6), we introduce the functor $\mathring{A}(P, \bullet)$ of *Jacobi diagrams* with underlying oriented Brauer diagram P (resp. $\text{Tens}^{\mathcal{A}}(P, P')_{\bullet, \bullet'}$, $\text{Comp}^{\mathcal{A}}(P, P')_{\bullet, \bullet'}$, $\text{co}^{\mathcal{A}}(P, \bullet)$, $\text{dbl}_{\mathcal{A}}((P, A), \bullet)$). In §3.7, we verify that these data satisfy the pre-LMO axioms (LMO1), (LMO2) and (LMO3), see Theorem 3.31. In §3.8 we introduce a natural transformation $\{ \text{co}^{\mathcal{A}}((P, a), \bullet) \}_{P \in \vec{\mathcal{B}}_r, a \in \pi_0(P)}$ and define the assignment $Z_{\mathcal{A}}(\bullet)$ (*Kontsevich integral*). We conclude with §3.9 proving axiom (LMO4) and therefore that $\mathring{\mathbf{A}}$ is a pre-LMO structure, see Theorem 3.41. Further properties of $\mathring{\mathbf{A}}$ are discussed in §3.10.

3.1. Preliminaries on linear and cyclic orders. Recall that a *linear order* (or *total order*) on a set X is a subset $L \subset X^2$ (one writes $a < b$ if and only if $(a, b) \in L$), such that: for any a , $a < a$ is not true (irreflexivity); for any a, b, c , $a < b$ and $b < c$ implies $a < c$ (transitivity); and for any distinct a, b , one has $a < b$ or $b < a$. A set endowed with a linear order is called *linearly ordered set*.

If $(X, <)$ is a linearly ordered set and $Y \subset X$, then the restriction of $<$ to Y endows it with a linear order.

We will need the notion of *cyclic order* on a set X . When X is finite, a cyclic order on X is the same as: (a) an orbit of the action of the group of cyclic permutations on the set of linear orders on X or (b) a transitive action of \mathbb{Z} on X by permutations, (see [57, Chapter 1]). More generally, we have the following.

Definition 3.1. [57, Chapter 1]³ Let X be a set. A *cyclic order* on X is a subset $C \subset X^3$, we write $[a < b < c]$ instead of $(a, b, c) \in C$, such that

- (a) for any pairwise distinct $a, b, c \in X$, we have either $[a < b < c]$ or $[b < a < c]$, but not both;
- (b) for any $a, b, c \in X$ we have $[a < b < c]$ if and only if $[b < c < a]$;
- (c) if $a, b, c, d \in X$ are such that $[a < b < c]$ and $[a < c < d]$ then $[a < b < d]$.
- (d) if $a, b, c \in X$ are not pairwise distinct, then $[a < b < c]$ does not hold.

Notice that if $|X| \leq 2$, the only cyclic order on X is $\emptyset \subset X^3$. A set X endowed with a cyclic order is called *cyclically ordered set*.

Lemma 3.2. (a) Let $(I, <_I)$ be a linearly ordered set and let $\{(A_i, <_i)\}_{i \in I}$ be a family of linearly ordered sets indexed by I . Then there is a unique linear order \prec on $\bigsqcup_{i \in I} A_i$, such that for each $i \in I$, its restriction to A_i coincides with $<_i$, and for any $i, j \in I$ with $i <_I j$ and any $x \in A_i$ and $y \in A_j$, one has $x \prec y$.

- (b) Let $(I, [\cdot < \cdot < \cdot])$ be a cyclically ordered set and let $\{(A_i, <_i)\}_{i \in I}$ be a family of linearly ordered sets indexed by I . Let $A := \bigsqcup_{i \in I} A_i$ and $\pi : A \rightarrow I$ the canonical projection ($\pi(a) = i$ if and only if $a \in A_i$). Then there is a unique cyclic order $[\cdot < \cdot < \cdot]_A$ on A such that for any $a, b, c \in A$, one has $[a < b < c]_A$ if and only if one of the following conditions is satisfied:

- (1) $[\pi(a) < \pi(b) < \pi(c)]$,
- (2) $\pi(a) = \pi(b) \neq \pi(c)$ and $a <_{\pi(a)} b$,
- (3) $\pi(b) = \pi(c) \neq \pi(a)$ and $b <_{\pi(b)} c$
- (4) $\pi(c) = \pi(a) \neq \pi(b)$ and $c <_{\pi(c)} a$
- (5) $\pi(a) = \pi(b) = \pi(c)$ and one of the following requirements is verified $a <_{\pi(a)} b <_{\pi(a)} c$ or $c <_{\pi(a)} a <_{\pi(a)} b$ or $b <_{\pi(a)} c <_{\pi(a)} a$.

Proof. (a) The binary relation \prec on $\bigsqcup_{i \in I} A_i$ is uniquely determined by the conditions of the statement, i.e., if $x, y \in \bigsqcup_{i \in I} A_i$ are such that $x, y \in A_i$ for some $i \in I$, then $x \prec y$ if and only if $x <_i y$ and if $x \in A_i$ and $y \in A_j$ for $i \neq j$ then $x \prec y$ if and only if $i <_I j$. It is straightforward to check that \prec defines a linear order on $\bigsqcup_{i \in I} A_i$.

(b) The ternary relation $[\cdot < \cdot < \cdot]_A$ on $A := \bigsqcup_{i \in I} A_i$ is uniquely determined by the conditions of the statement. It is easy to check that it defines a cyclic order on A . \square

Definition 3.3. (a) A *partially defined injective self-map* (PDISM for short) on a finite set X is a diagram $X \supset D_{\text{succ}} \xrightarrow{\text{succ}} X$, denoted shortly by succ , where D_{succ} is a subset of X (the *domain of definition* of succ) and $\text{succ} : D_{\text{succ}} \rightarrow X$ is an injective map.

- (b) Let succ be a PDISM on a finite set X . We set $X_0 := X \setminus D_{\text{succ}}$, that is X_0 is the subset of X of elements for which the image of the map succ is not defined.

Lemma 3.4. Let X be a finite set and succ be a PDISM on X and $X_0 \subset X$ as in Definition 3.3. For $x \in X$, let $N(x)$ be the set $\{n \in \mathbb{Z}_{\geq 0} \mid \text{succ}^n(x) \text{ is defined}\}$. Define $\text{orb}(x) \subset X$ as

$$\text{orb}(x) := \{\text{succ}^n(x) \mid n \in N(x)\} \cup \{y \in X \mid \text{there exists } k \in \mathbb{Z}_{\geq 0} \text{ such that } \text{succ}^k(y) = x\},$$

so $\text{orb}(x) \in \mathcal{P}(X)$. This defines a map $\text{orb} : X \rightarrow \mathcal{P}(X)$. We have

³Condition (d) in Definition 3.1 is present in the Russian edition, but has been mistakenly erased from the English translation.

- (a) $\text{orb}(X) \subset \mathcal{P}(X)$ is a partition of X .
- (b) Let $\text{orb}_{\text{lin}}(X) := \{\omega \in \text{orb}(X) \mid \omega \cap X_0 \neq \emptyset\}$ and $\text{orb}_{\text{cyc}}(X) := \{\omega \in \text{orb}(X) \mid \omega \cap X_0 = \emptyset\}$. Then $\text{orb}(X) = \text{orb}_{\text{lin}}(X) \sqcup \text{orb}_{\text{cyc}}(X)$. One also has $\cup_{\omega \in \text{orb}_{\text{lin}}(X)} \omega = \{x \in X \mid N(x) \text{ is finite}\}$ and $\cup_{\omega \in \text{orb}_{\text{cyc}}(X)} \omega = \{x \in X \mid N(x) \text{ is infinite}\}$.
- (c) Let $\omega \in \text{orb}_{\text{lin}}(X)$, then $|\omega \cap X_0| = 1$, we denote by ω_0 the only element in $\omega \cap X_0$. The set ω (viewed as a subset of X) is equipped with a linear order $<_\omega$, such that for each $x \in \omega \setminus X_0$ one has $x <_\omega \text{succ}(x)$ and $x <_\omega \omega_0$.
- (d) For $\omega \in \text{orb}_{\text{cyc}}(X)$, the restriction to ω (viewed as a subset of X) of the map succ defines a transitive action of \mathbb{Z} and therefore equips ω with a cyclic order.

Proof. (a) Clearly we have $X = \cup_x \text{orb}(x)$. One checks that if $\text{orb}(x) \cap \text{orb}(x') \neq \emptyset$ then $\text{orb}(x) = \text{orb}(x')$.

(b) Follows directly from the definitions of $\text{orb}_{\text{lin}}(X)$ and $\text{orb}_{\text{cyc}}(X)$.

(c) The fact that $|\omega \cap X_0| = 1$ follows from the injectivity of succ . One then has $\omega = \{\text{succ}^{-i}(\omega_0) \mid i \in \llbracket 0, |\omega| - 1 \rrbracket\}$ which is clearly equipped with a linear order as stated in the lemma.

(d) Follows straightforwardly. \square

Lemma 3.5. *Let X be a finite set, let succ be a PDISM on X and let $X_0 \subset X$ be as in Definition 3.3. Set $Y := X \setminus X_0$, $Y_0 := \text{succ}^{-1}(X_0)$.*

- (a) *There is a unique PDISM succ_Y on Y with domain of definition $Y \setminus Y_0$, given by $\text{succ}_Y(y) := \text{succ}(y)$ for all $y \in Y \setminus Y_0$.*
- (b) *Let $\text{orb}(X)$ (resp. $\text{orb}(Y)$) be the partition of X (resp. Y) and $\text{orb}(Y) = \text{orb}_{\text{lin}}(Y) \sqcup \text{orb}_{\text{cyc}}(Y)$ (resp. $\text{orb}(X) = \text{orb}_{\text{lin}}(X) \sqcup \text{orb}_{\text{cyc}}(X)$) be its decomposition obtained by applying Lemma 3.4 to (X, X_0, succ) (resp. (Y, Y_0, succ_Y)). There are canonical bijections $\text{orb}_{\text{cyc}}(X) \simeq \text{orb}_{\text{cyc}}(Y)$ and*

$$\text{orb}_{\text{lin}}(X) \simeq \text{orb}_{\text{lin}}(Y) \sqcup \{x \in X_0 \mid \text{succ}^{-1}(x) = \emptyset\}.$$

- (c) *There is a canonical bijection between the underlying set of each element of $\text{orb}_{\text{cyc}}(Y)$ and its image in $\text{orb}_{\text{cyc}}(X)$, compatible with the cyclic orders; and there is an injection of the underlying set of each element of $\text{orb}_{\text{lin}}(Y)$ to that of its image in $\text{orb}_{\text{lin}}(X)$, compatible with the linear orders.*

Proof. (a) follows straightforwardly. (b) We can show that $\text{orb}_{\text{cyc}}(X) = \text{orb}_{\text{cyc}}(Y)$. Indeed, if $\omega \in \text{orb}_{\text{cyc}}(X)$, then $\omega = \text{orb}(x)$ for some $x \in X$, since $\omega \cap X_0 = \text{orb}(x) \cap X_0 = \emptyset$ then $x \in Y$ and clearly $\omega \cap Y_0 = \text{orb}(x) \cap Y_0 = \emptyset$. Therefore $\omega = \text{orb}(x) \in \text{orb}_{\text{cyc}}(Y)$. The converse inclusion is evident. Let us show the second statement in (b), if $\omega \in \text{orb}_{\text{lin}}(Y)$, then $\omega = \text{orb}(y)$ with $y \in Y$. Since $\omega \cap Y_0 = \text{orb}(y) \cap Y_0 \neq \emptyset$, then there exist $y_0 \in Y_0$ such that $\omega = \text{orb}(y_0)$. It follows that $\omega \cup \{\text{succ}(y_0)\} \in \text{orb}(X)$ and $(\omega \cup \{\text{succ}(y_0)\}) \cap X_0 \neq \emptyset$, that is, $\omega \cup \{\text{succ}(y_0)\} \in \text{orb}_{\text{lin}}(X)$. This defines an injective map $\text{orb}_{\text{lin}}(Y) \rightarrow \text{orb}_{\text{lin}}(X)$ with image $\text{orb}_{\text{lin}}(X) \setminus \{x \in X_0 \mid \text{succ}^{-1}(x) = \emptyset\}$. (c) follows from (b). \square

3.2. The functor $\hat{A}^\wedge(P, \bullet)$ of Jacobi diagrams.

Definition 3.6. A *vertex-oriented univalent graph* is a finite graph whose vertices are univalent or trivalent, and such that for each trivalent vertex the set of half-edges incident to it is cyclically ordered. We allow looped edges (without vertices). For D is a vertex-oriented univalent graph, we denote by ∂D its set of univalent vertices.

Definition 3.7. Let $P \in \vec{\mathcal{B}}r$ be an oriented Brauer diagram (see Definition 1.27) and let S be a finite set. A *Jacobi diagram on (P, S)* is a class of a tuple $\underline{D} = (D, \varphi, \{\text{lin}_l\}_{l \in \pi_0(P)}, \{\text{cyc}_s\}_{s \in S})$ where D is a vertex-oriented univalent graph (loops without vertices are allowed), $\varphi : \partial D \rightarrow \pi_0(P) \sqcup S$ is a map, and for each $l \in \pi_0(P)$, lin_l is a linear order on $\varphi^{-1}(l)$ and for each $s \in S$, cyc_s is a cyclic order on $\varphi^{-1}(s)$. Two such tuples $\underline{D} = (D, \varphi, \{\text{lin}_l\}_{l \in \pi_0(P)}, \{\text{cyc}_s\}_{s \in S})$ and $\underline{\tilde{D}} = (\tilde{D}, \tilde{\varphi}, \{\tilde{\text{lin}}_l\}_{l \in \pi_0(P)}, \{\tilde{\text{cyc}}_s\}_{s \in S})$ are considered equivalent if there exists a graph isomorphism $\psi : D \rightarrow \tilde{D}$ such that $\tilde{\varphi} \circ \psi|_{\partial D} = \varphi$ and inducing isomorphisms of linear and cyclic ordered sets $(\varphi^{-1}(l), \text{lin}_l) \cong (\tilde{\varphi}^{-1}(l), \tilde{\text{lin}}_l)$ and $(\varphi^{-1}(s), \text{cyc}_s) \cong (\tilde{\varphi}^{-1}(s), \tilde{\text{cyc}}_s)$ for any $l \in \pi_0(P)$ and any $s \in S$. We denote by $\text{Jac}(P, S)$ the set of Jacobi diagrams on (P, S) .

Definition 3.8. Let $P \in \vec{\mathcal{B}}r$ be an oriented Brauer diagram and let S be a finite set. We denote by $\emptyset_{(P,S)}$ the Jacobi diagram on (P, S) given by the tuple with $D = \emptyset$.

In order to represent a Jacobi diagram $\underline{D} = (D, \varphi, \{\text{lin}_l\}_{l \in \pi_0(P)}, \{\text{cyc}_s\}_{s \in S})$ on (P, S) by a drawing, we use the schematic representation of P (see §1.8) using solid lines, we draw with solid lines an oriented circle labelled by s for each element $s \in S$, we use dashed lines to represent D , and the map $\varphi : \partial D \rightarrow \pi_0(P) \sqcup S$ is indicated by attaching the univalent vertices to the solid lines so that the linear orders and cyclic orders coincide with the orders induced by the orientations of the solid lines. The vertex orientation of trivalent vertices of D is counterclockwise by convention. In particular, the schematic representation of $\emptyset_{(P,S)}$ coincides with the schematic representation of the oriented Brauer diagram P . See Figure 3.1 for more examples.

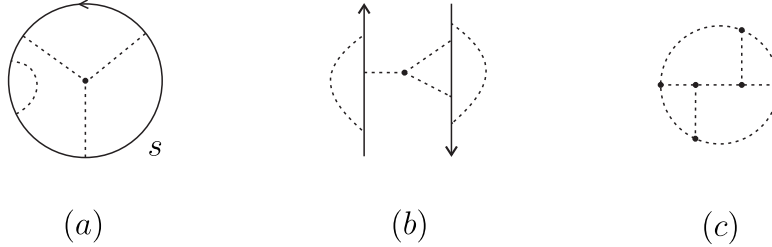

FIGURE 3.1. Jacobi diagrams with $(P, S) = (\vec{\emptyset}, \{s\})$ in (a), $(P, S) = (\uparrow\downarrow, \emptyset)$ in (b) and $(P, S) = (\vec{\emptyset}, \emptyset)$ in (c).

Definition 3.9. Let P be an oriented Brauer diagram and S a finite set. For $x \in \pi_0(P) \sqcup S$, define the map

$$m_x : \mathring{\text{Jac}}(P, S) \longrightarrow \mathbb{Z}_{\geq 0}, \quad \underline{D} \mapsto m_x(\underline{D})$$

where $m_x(\underline{D}) := |\varphi^{-1}(x)|$ for any $\underline{D} = (D, \varphi, \{\text{lin}_l\}_{l \in \pi_0(P)}, \{\text{cyc}_s\}_{s \in S}) \in \mathring{\text{Jac}}(P, S)$.

Definition 3.10. Let P be an oriented Brauer diagram and S a finite set. The *space of Jacobi diagrams on (P, S)* is the \mathbb{C} -vector space generated by the set $\mathring{\text{Jac}}(P, S)$ of Jacobi diagrams on (P, S) up to the STU, AS, and IHX relations:

$$\mathring{\mathcal{A}}(P, S) := \frac{\mathbb{C}\mathring{\text{Jac}}(P, S)}{(\text{STU}, \text{AS}, \text{IHX})}$$

where the relations STU, AS, IHX are the local relations shown in Figure 3.2 using the schematic representation of Jacobi diagrams. In particular, we remark that in the STU relation the solid line could be a portion of the schematic representation of an element of $\pi_0(P)$ or a portion of a circle representing an element of S .

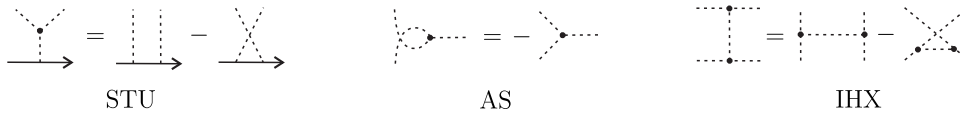

FIGURE 3.2. Relations in $\mathring{\mathcal{A}}(P, S)$. The solid line in the STU relation can be a portion of the schematic representation of an element of $\pi_0(P)$ or a portion of a circle representing an element of S .

We define the *degree* of a Jacobi diagram \underline{D} by

$$(3.1) \quad \deg(\underline{D}) := \frac{1}{2}((\text{number of trivalent vertices of } D) + |\partial D|) \in \mathbb{Z}_{\geq 0}.$$

One checks that this induces a degree on the space $\mathring{\mathcal{A}}(P, S)$. We denote by $\mathring{\mathcal{A}}^\wedge(P, S)$ its degree completion. From now on, for a Jacobi diagram \underline{D} on (P, S) , we denote by $[\underline{D}]$ its class in $\mathring{\mathcal{A}}(P, S) \subset \mathring{\mathcal{A}}^\wedge(P, S)$.

Definition 3.11. Let $P \in \vec{Br}$ be an oriented Brauer diagram and let S be a finite set. We denote by $(P, S)_{\mathcal{A}}$ the class in $\mathring{A}(P, S) \subset \mathring{A}^{\wedge}(P, S)$ of the Jacobi diagram $\emptyset_{(P, S)}$, see Definition 3.8. In the case $S = \emptyset$, we just write $P_{\mathcal{A}}$ for this class.

Denote by $ComplGrVect$ the category whose objects are complete graded vector spaces and with morphisms continuous, grading-preserving, linear maps.

Lemma 3.12. *Let P be an oriented Brauer diagram. Then*

- (a) *The assignment $S \mapsto \mathring{Jac}(P, S)$ for S a finite set, and for $f : S \rightarrow S'$ a bijection between S, S' the map $\mathring{Jac}(P, S) \rightarrow \mathring{Jac}(P, S')$ defined by*

$$(D, \varphi, \{\text{lin}_l\}_{l \in \pi_0(P)}, \{\text{cyc}_s\}_{s \in S}) \mapsto (D, (\text{Id}_{\pi_0(P)} \sqcup f) \circ \varphi, \{\text{lin}_l\}_{l \in \pi_0(P)}, \{\text{cyc}_{f^{-1}(s')}\}_{s' \in S'})$$

for any $(D, \varphi, \{\text{lin}_l\}_{l \in \pi_0(P)}, \{\text{cyc}_s\}_{s \in S}) \in \mathring{Jac}(P, S)$ defines a functor $F_P : \text{Set}_f \rightarrow \text{Set}$.

- (b) *The assignment in (a) composed with the canonical map $\mathring{Jac}(P, S) \rightarrow \mathring{A}(P, S)$ (resp. $\mathring{Jac}(P, S) \rightarrow \mathring{A}^{\wedge}(P, S)$) induces a functor $\text{Set}_f \rightarrow \text{Vect}$ (resp. $\text{Set}_f \rightarrow \text{ComplGrVect}$).*

Proof. Let S, S', S'' be finite sets and $f : S \rightarrow S', g : S' \rightarrow S''$ bijections.

(a) Clearly we have $F_P(\text{Id}_S) = \text{Id}_{\mathring{Jac}(P, S)}$ and $F_P(f)$ is well-defined because f is a bijection. Let $(D, \varphi, \{\text{lin}_l\}_{l \in \pi_0(P)}, \{\text{cyc}_s\}_{s \in S}) \in \mathring{Jac}(P, S)$. The equality $(\text{Id}_{\pi_0(P)} \sqcup (g \circ f)) \circ \varphi = (\text{Id}_{\pi_0(P)} \sqcup g) \circ ((\text{Id}_{\pi_0(P)} \sqcup f) \circ \varphi)$ and the fact that f and g are bijections imply $F_P(g \circ f) = F_P(g) \circ F_P(f)$.

(b) One checks that the \mathbb{C} -linear extension of the map $F_P(f) : \mathring{Jac}(P, S) \rightarrow \mathring{Jac}(P, S')$ is compatible with the STU, IHX and AS relations which together with (a) imply the statement. \square

3.3. The natural transformation $\text{Tens}^{\mathcal{A}}(P, P')_{\bullet, \bullet}$.

Definition 3.13. For P, P' oriented Brauer diagrams and S, S' finite sets, define a map

$$(3.2) \quad \text{Tens}^{\mathring{Jac}}(P, P')_{S, S'} : \mathring{Jac}(P, S) \times \mathring{Jac}(P', S') \longrightarrow \mathring{Jac}(P \otimes P', S \sqcup S'), \quad (\underline{D}, \underline{D}') \mapsto \underline{D} \otimes \underline{D}'$$

where for $\underline{D} = (D, \varphi, \{\text{lin}_l\}_{l \in \pi_0(P)}, \{\text{cyc}_s\}_{s \in S}) \in \mathring{Jac}(P, S)$ and $\underline{D}' = (D', \varphi', \{\text{lin}'_l\}_{l \in \pi_0(P')}, \{\text{cyc}'_s\}_{s \in S'}) \in \mathring{Jac}(P', S')$ the expression $\underline{D} \otimes \underline{D}'$ denotes the Jacobi diagram on $P \otimes P'$ given by

$$(D \sqcup D', \varphi \sqcup \varphi', \{\text{lin}_l\}_{l \in \pi_0(P)} \sqcup \{\text{lin}'_l\}_{l \in \pi_0(P')}, \{\text{cyc}_s\}_{s \in S} \sqcup \{\text{cyc}'_s\}_{s \in S'}).$$

Here we use the canonical identifications $\pi_0(P \otimes P') \simeq \pi_0(P) \sqcup \pi_0(P')$, and the equality $\partial(D \sqcup D') = \partial D \sqcup \partial D'$.

Lemma 3.14. *The map (3.2) induces a continuous linear map*

$$(3.3) \quad \text{Tens}^{\mathcal{A}}(P, P')_{S, S'} : \mathring{A}^{\wedge}(P, S) \otimes \mathring{A}^{\wedge}(P', S') \longrightarrow \mathring{A}^{\wedge}(P \otimes P', S \sqcup S')$$

for any oriented Brauer diagrams P and P' and any finite sets S and S' . The assignment $(S, S') \mapsto \text{Tens}^{\mathcal{A}}(P, P')_{S, S'}$ is a natural transformation relating the functors $\text{Set}_f^2 \rightarrow \text{Vect}$ given by $(S, S') \mapsto \mathring{A}^{\wedge}(P, S) \otimes \mathring{A}^{\wedge}(P', S')$ and $(S, S') \mapsto \mathring{A}^{\wedge}(P \otimes P', S \sqcup S')$.

Proof. One checks that the bilinear extension of the map (3.2) is compatible with the STU, AS and IHX relations. One also checks that the assignment $(S, S') \mapsto \text{Tens}^{\mathcal{A}}(P, P')_{S, S'}$ is compatible with pairs $(f, g) : (S, S') \rightarrow (E, E')$ of bijections $f : S \rightarrow E$ and $f' : S' \rightarrow E'$ which implies the second statement. \square

Notation 3.15. We will write $x \otimes_{\mathcal{A}} x'$ instead of $\text{Tens}^{\mathcal{A}}(P, P')_{S, S'}(x \otimes x')$ for any $x \in \mathring{A}^{\wedge}(P, S)$ and $x' \in \mathring{A}^{\wedge}(P', S')$ and we refer to such an element as the tensor product of x and x' . In drawings, the tensor product $x \otimes_{\mathcal{A}} x'$ is described by the horizontal concatenation of x and x' , see Figure 3.3 for an example.

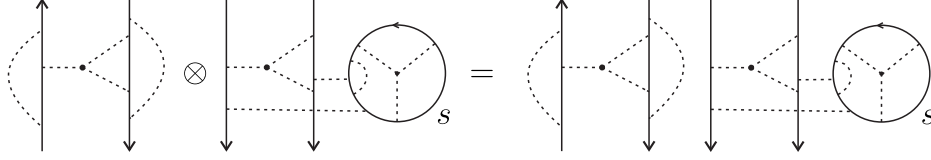

FIGURE 3.3. Schematic representation of the tensor product of an element in $\mathring{\mathcal{A}}^\wedge(\uparrow\downarrow, \emptyset)$ and an element in $\mathring{\mathcal{A}}^\wedge(\downarrow\downarrow, \{s\})$ which gives rise to an element in $\mathring{\mathcal{A}}^\wedge(\uparrow\downarrow\downarrow\downarrow, \{s\})$.

3.4. The natural transformation $\text{Comp}^A(P, P')_{\bullet, \bullet}$. Let $P, P' \in \vec{\mathcal{B}}r$ be a composable pair of oriented Brauer diagrams and S, S' finite sets. Recall from Lemma 1.42(c) that there is a map $\text{proj}_{P, P'}^{\pi_0} : \pi_0(P) \sqcup \pi_0(P') \rightarrow \pi_0(P' \circ P) \sqcup \text{Cir}(P', P)$. Its disjoint union with the identity maps of S and S' is a map $\text{proj}_{P, P'}^{S, S'} : \pi_0(P) \sqcup S \sqcup \pi_0(P') \sqcup S' \rightarrow \pi_0(P' \circ P) \sqcup S \sqcup S' \sqcup \text{Cir}(P', P)$. We have $(\text{proj}_{P, P'}^{\pi_0})^{-1}(x) = (\text{proj}_{P, P'}^{S, S'})^{-1}(x)$ for any $x \in \pi_0(P' \circ P) \sqcup \text{Cir}(P', P)$.

Lemma 3.16. *Let (P, P') be a composable pair in $\vec{\mathcal{B}}r$. One then has $P = ((p, q, \sigma), B)$, $P' = ((q, r, \sigma'), B')$, and there exists a subset $L \subset \llbracket 1, q \rrbracket$ such that $\text{can}_2(L) = E \cap \llbracket 1, q \rrbracket$ and $\text{can}_1(L) = B' \cap \llbracket 1, q \rrbracket$, where $E := \sigma(B) \subset \llbracket 1, p \rrbracket \sqcup \llbracket 1, q \rrbracket$ (see Definition 1.30) and $\text{can}_1 : \llbracket 1, q \rrbracket \rightarrow \llbracket 1, q \rrbracket \sqcup \llbracket 1, r \rrbracket$ and $\text{can}_2 : \llbracket 1, q \rrbracket \rightarrow \llbracket 1, p \rrbracket \sqcup \llbracket 1, q \rrbracket$ denote the canonical inclusions. We also set $E' := \sigma'(B') \subset \llbracket 1, p' \rrbracket \sqcup \llbracket 1, q' \rrbracket$. We have*

- (a) *For any $x \in \pi_0(P' \circ P)$ the set $(\text{proj}_{P, P'}^{\pi_0})^{-1}(x) \subset \pi_0(P) \sqcup \pi_0(P')$ admits a unique linear order $<$ with the following properties:*
- (i) *If $\alpha \in \llbracket 1, q \rrbracket$ is such that $\text{can}_2(\alpha) \in E \subset \llbracket 1, p \rrbracket \sqcup \llbracket 1, q \rrbracket$ and $\text{can}_1(\alpha) \in B' \subset \llbracket 1, q \rrbracket \sqcup \llbracket 1, r \rrbracket$, then $\{\sigma(\text{can}_2(\alpha)), \text{can}_2(\alpha)\} \in \pi_0(P)$ and $\{\text{can}_1(\alpha), \sigma'(\text{can}_1(\alpha))\} \in \pi_0(P')$ are such that*

$$\{\sigma(\text{can}_2(\alpha)), \text{can}_2(\alpha)\} < \{\text{can}_1(\alpha), \sigma'(\text{can}_1(\alpha))\}.$$
 - (ii) *If $\alpha \in \llbracket 1, q \rrbracket$ is such that $\text{can}_2(\alpha) \in B \subset \llbracket 1, p \rrbracket \sqcup \llbracket 1, q \rrbracket$ and $\text{can}_1(\alpha) \in E' \subset \llbracket 1, q \rrbracket \sqcup \llbracket 1, r \rrbracket$, then $\{\sigma(\text{can}_2(\alpha)), \text{can}_2(\alpha)\} \in \pi_0(P)$ and $\{\text{can}_1(\alpha), \sigma'(\text{can}_1(\alpha))\} \in \pi_0(P')$ are such that*

$$\{\text{can}_1(\alpha), \sigma'(\text{can}_1(\alpha))\} < \{\sigma(\text{can}_2(\alpha)), \text{can}_2(\alpha)\}.$$
- (b) *Let $x \in \text{Cir}(P', P)$. Let $X := (\text{proj}_{P, P'}^{\pi_0})^{-1}(x)$. If $y \in X \cap \pi_0(P)$, then there exists a unique $\alpha \in \llbracket 1, q \rrbracket$ such that $e_P(y) = \text{can}_2(\alpha)$, and there exists a unique element $y' \in \pi_0(P')$ such that $b_{P'}(y') = \text{can}_1(\alpha)$. If $y \in X \cap \pi_0(P')$, then there exist a unique $\alpha \in \llbracket 1, q \rrbracket$ such that $e_P(y) = \text{can}_1(\alpha)$, and there exists a unique element $y' \in \pi_0(P)$ such that $b_P(y) = \text{can}_2(\alpha)$. The assignment $y \mapsto y'$ defines a self-map succ_X of X . The map succ_X is a permutation, therefore defines an action of \mathbb{Z} on X . This action is transitive, therefore defines a cyclic order on X .*

Proof. Recall the canonical injections $\text{can}_{12} : \llbracket 1, p \rrbracket \sqcup \llbracket 1, q \rrbracket \rightarrow \llbracket 1, p \rrbracket \sqcup \llbracket 1, q \rrbracket \sqcup \llbracket 1, r \rrbracket$ and $\text{can}_{23} : \llbracket 1, q \rrbracket \sqcup \llbracket 1, r \rrbracket \rightarrow \llbracket 1, p \rrbracket \sqcup \llbracket 1, q \rrbracket \sqcup \llbracket 1, r \rrbracket$. Set $V := \llbracket 1, p \rrbracket \sqcup \llbracket 1, q \rrbracket \sqcup \llbracket 1, r \rrbracket$, it follows from the assumption that the subsets $\text{can}_{12}(B)$, $\text{can}_{23}(B')$, $\text{can}_{12}(E) \cap \llbracket 1, p \rrbracket$, $\text{can}_{23}(E) \cap \llbracket 1, r \rrbracket$ of $\llbracket 1, p \rrbracket \sqcup \llbracket 1, q \rrbracket \sqcup \llbracket 1, r \rrbracket$ form a partition of V . Set $V_0 := (\text{can}_{12}(E) \cap \llbracket 1, p \rrbracket) \sqcup (\text{can}_{23}(E') \cap \llbracket 1, r \rrbracket)$ and define $\text{succ} : V \setminus V_0 \rightarrow V$ by $\text{succ}(\text{can}_{12}(b)) := \text{can}_{12}(\sigma(b))$ and $\text{succ}(\text{can}_{23}(b')) := \text{can}_{23}(\sigma'(b'))$ for $b \in B$, $b' \in B'$. The injectivity of succ follows from the partition status of $(\text{can}_{12}(B), \text{can}_{23}(B'), \text{can}_{12}(E) \cap \llbracket 1, p \rrbracket, \text{can}_{23}(E) \cap \llbracket 1, r \rrbracket)$, the injectivity of can_{12} and can_{23} , and the permutation status of σ and σ' . By Lemma 3.4, one attaches to (V, V_0, succ) a set $\text{orb}(V)$ equipped with a partition $(\text{orb}_{\text{lin}}(V), \text{orb}_{\text{cyc}}(V))$.

There is a canonical bijection $\text{orb}(V) \simeq (\llbracket 1, p \rrbracket \sqcup \llbracket 1, q \rrbracket \sqcup \llbracket 1, r \rrbracket) / \langle \alpha, \beta \rangle$ inducing a bijection between the partitions $(\text{orb}_{\text{lin}}(V), \text{orb}_{\text{cyc}}(V))$ and $(\pi_0(P' \circ P), \text{Cir}(P', P))$, see Equation (1.8).

Besides, $\{v \in V_0 \mid \text{succ}^{-1}(v) = \emptyset\} = \emptyset$. Indeed, if $v \in V_0$, then either there exists $e \in E$ with $\text{can}_{12}(e) \in \llbracket 1, p \rrbracket$ and $v = \text{can}_{12}(e)$; in that case $\text{can}_{12}(\sigma(e)) \in \text{succ}^{-1}(v)$; or there exists $e' \in E'$ with $\text{can}_{23}(e') \in \llbracket 1, r \rrbracket$ and $v = \text{can}_{23}(e')$; in that case $\text{can}_{23}(\sigma'(e')) \in \text{succ}^{-1}(v)$. By Lemma 3.5, one derives a bijection $\text{orb}(V \setminus V_0) \simeq \text{orb}(V)$ inducing a bijection between the partitions $(\text{orb}_{\text{lin}}(V \setminus V_0), \text{orb}_{\text{cyc}}(V \setminus V_0))$ and $(\text{orb}_{\text{lin}}(V), \text{orb}_{\text{cyc}}(V))$. Now $V \setminus V_0 \simeq B \sqcup B' \simeq \pi_0(P) \sqcup \pi_0(P')$. Transporting structures, we obtain a PDISM on $\pi_0(P) \sqcup \pi_0(P')$, see Definition 3.3. Its associated partition is in bijection with $(\text{orb}_{\text{lin}}(V \setminus$

V_0), $\text{orb}_{\text{cyc}}(V \setminus V_0)$), and therefore with $(\pi_0(P' \circ P), \text{Cir}(P', P))$, and whose underlying cyclic and linear orders are as announced. \square

Definition 3.17. Let $P, P' \in \vec{\mathcal{B}}r$ be a composable pair of oriented Brauer diagrams and S, S' finite sets. Define a map

$$(3.4) \quad \text{Comp}^{\text{Jac}}(P, P')_{S, S'} : \text{Jac}(P, S) \times \text{Jac}(P', S') \longrightarrow \text{Jac}(P' \circ P, S \sqcup S' \sqcup \text{Cir}(P', P)), \quad (\underline{D}, \underline{D}') \longmapsto \underline{D}' \circ \underline{D}$$

where for $\underline{D} = (D, \varphi, \{\text{lin}_l\}_{x \in \pi_0(P)}, \{\text{cyc}_s\}_{s \in S}) \in \text{Jac}(P, S)$ and $\underline{D}' = (D', \varphi', \{\text{lin}'_x\}_{x \in \pi_0(P')}, \{\text{cyc}'_s\}_{s \in S'}) \in \text{Jac}(P', S')$ the expression $\underline{D}' \circ \underline{D}$ denotes the Jacobi diagram on $P' \circ P'$ given by

$$(D \sqcup D', \text{proj}_{P, P'}^{S, S'} \circ (\varphi \sqcup \varphi'), \{\underline{\text{lin}}_l\}_{x \in \pi_0(P' \circ P)}, \{\text{cyc}_s\}_{s \in S} \sqcup \{\text{cyc}'_s\}_{s \in S'} \sqcup \{\underline{\text{cyc}}_x\}_{x \in \text{Cir}(P', P)})$$

with $\text{proj}_{P, P'}^{S, S'}$ as in Lemma 3.16(b) and orders $\underline{\text{lin}}_x$ and $\underline{\text{cyc}}_x$ defined as follows. Let $x \in \pi_0(P' \circ P)$, by Lemma 3.16(a), the set $(\text{proj}_{P, P'}^{S, S'})^{-1}(x) \subset \pi_0(P) \sqcup \pi_0(P')$ is linearly ordered, let us say it is given by $x_1 < x_2 < \dots < x_k$. This order induces the linear order

$$(\varphi \sqcup \varphi')^{-1}(x_1) < (\varphi \sqcup \varphi')^{-1}(x_2) < \dots < (\varphi \sqcup \varphi')^{-1}(x_k)$$

on the family of sets $\{(\varphi \sqcup \varphi')^{-1}(x_i)\}_{i \in \llbracket 1, k \rrbracket}$. By hypothesis each set $(\varphi \sqcup \varphi')^{-1}(x_i)$ is linearly ordered, then by Lemma 3.2(a), there is a unique linear order on

$$(\text{proj}_{P, P'}^{S, S'} \circ (\varphi \sqcup \varphi'))^{-1}(x) = \sqcup_{i=1}^k (\varphi \sqcup \varphi')^{-1}(x_i)$$

satisfying the conditions stated in Lemma 3.2(a), we denote this order by $\underline{\text{lin}}_x$. The cyclic order $\underline{\text{cyc}}_x$ for $x \in \text{Cir}(P' \circ P)$ is defined similarly using Lemma 3.16(b) and Lemma 3.2(b).

Lemma 3.18. *The composition map (3.4) induces a continuous bilinear map*

$$(3.5) \quad \text{Comp}^{\mathcal{A}}(P, P')_{S, S'} : \mathring{\mathcal{A}}^{\wedge}(P, S) \times \mathring{\mathcal{A}}^{\wedge}(P', S') \longrightarrow \mathring{\mathcal{A}}^{\wedge}(P' \circ P, S \sqcup S' \sqcup \text{Cir}(P', P)),$$

for any composable Brauer diagrams P and P' and any finite sets S and S' . The assignment $(S, S') \mapsto \text{Comp}^{\mathcal{A}}(P, P')_{S, S'}$ is a natural transformation relating the functors $\text{Set}_f^2 \rightarrow \text{Vect}$ given by $(S, S') \mapsto \mathring{\mathcal{A}}^{\wedge}(P, S) \otimes \mathring{\mathcal{A}}^{\wedge}(P', S')$ and $(S, S') \mapsto \mathring{\mathcal{A}}^{\wedge}(P' \circ P, S \sqcup S' \sqcup \text{Cir}(P', P))$.

Proof. One checks that the bilinear extension of the map (3.4) is compatible with the STU, AS and IHX relations. One also checks that the assignment $(S, S') \mapsto \text{Comp}^{\mathcal{A}}(P, P')_{S, S'}$ is compatible with pairs $(f, g) : (S, S') \rightarrow (E, E')$ of bijections $f : S \rightarrow E$ and $f' : S' \rightarrow E'$ which implies the second statement. \square

Notation 3.19. Let $P, P' \in \vec{\mathcal{B}}r$ be composable oriented Brauer diagrams and S and S' finite sets. We will write $x' \circ_{\mathcal{A}} x$ instead of $\text{Comp}^{\mathcal{A}}(P, P')_{S, S'}(x \otimes x')$ for any $x \in \mathring{\mathcal{A}}^{\wedge}(P, S)$ and $x' \in \mathring{\mathcal{A}}^{\wedge}(P', S')$ and we refer to such an element as the composition of x and x' . In drawings, the composition $x' \circ_{\mathcal{A}} x$ is described by the vertical concatenation of x' above x , see Figure 3.4 for an example.

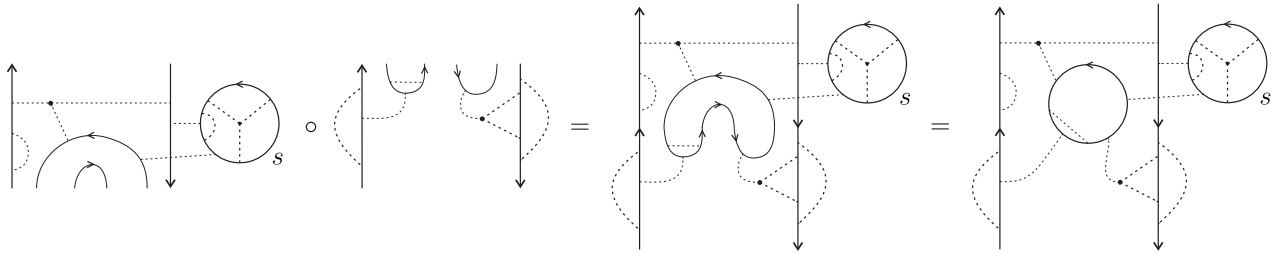

FIGURE 3.4. Schematic representation of the composition of Jacobi diagrams.

3.5. The natural transformation $\text{co}^A(P, \bullet)$.

Definition 3.20. Let P be an oriented Brauer diagram, S a finite set and $s_0 \in S$. Define a map

$$(3.6) \quad \text{co}^{\mathring{\text{Jac}}}(P, (S, s_0)) : \mathring{\text{Jac}}(P, S) \longrightarrow \mathbb{C}\mathring{\text{Jac}}(P, S)$$

by

$$\text{co}^{\mathring{\text{Jac}}}(P, (S, s_0))(D, \varphi, \{\text{lin}_l\}_{l \in \pi_0(P)}, \{\text{cyc}_s\}_{s \in S}) = (-1)^{|\varphi^{-1}(s_0)|} (D, \varphi, \{\text{lin}_l\}_{l \in \pi_0(P)}, \{\text{cyc}_s\}_{s \in S \setminus \{s_0\}} \sqcup \{\overline{\text{cyc}}_{s_0}\})$$

for any $(D, \varphi, \{\text{lin}_l\}_{l \in \pi_0(P)}, \{\text{cyc}_s\}_{s \in S}) \in \mathring{\text{Jac}}(P, S)$, where $\overline{\text{cyc}}_{s_0}$ denotes the opposite cyclic order of cyc_{s_0} on the set $\varphi^{-1}(s_0) \subset \partial D$.

Lemma 3.21. Let P be an oriented Brauer diagram, S a finite set and $s_0 \in S$. The map (3.6) induces a continuous linear map

$$(3.7) \quad \text{co}^A(P, (S, s)) : \mathring{A}^\wedge(P, S) \longrightarrow \mathring{A}^\wedge(P, S).$$

The assignment $(S, s) \mapsto \text{co}^A(P, (S, s))$ is a natural self-transformation of the functor $\text{Set}_f^* \rightarrow \text{Vec}_{\mathbb{C}}$ given by $(S, s) \mapsto \mathring{A}^\wedge(P, S)$.

Proof. One checks that the linear extension of the map (3.6) is compatible with the STU, AS and IHX relations. One also checks that the assignment $(S, s) \mapsto \text{co}^A(P, (S, s))$ is compatible with pointed bijections $f : (S, s_0) \rightarrow (E, e_0)$ which implies the second statement. \square

In drawings, the element $\text{co}^A(P, (S, s))(x)$ is obtained from $x \in \mathring{A}^\wedge(P, S)$ by changing the orientation of the circle in the schematic representation of x labelled by s_0 and multiplying it by (-1) power to the number of univalent vertices attached to this circle, see Figure 3.5 for an example.

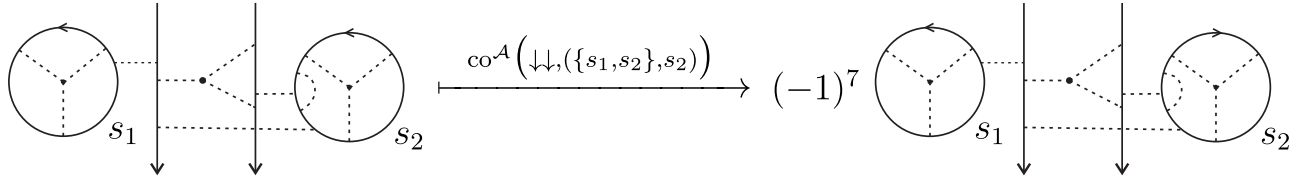

FIGURE 3.5. Schematic representation of the change of orientation operation for Jacobi diagrams.

3.6. The natural transformation $\text{dbl}_A((P, A), \bullet)$.

Definition 3.22. For $P \in \vec{\mathcal{B}}r$ and $A \subset \pi_0(P)$ and S a finite set. Use the simplified notation P^A for $\text{dbl}_{\vec{\mathcal{B}}r}(P, A)$. By Lemma 3.2(c), there is a map $\text{proj}_{P^A}^{\pi_0} : \pi_0(P^A) \rightarrow \pi_0(P)$. Let

$$(D, \varphi, \{\text{lin}_x\}_{x \in \pi_0(P)}, \{\text{cyc}_s\}_{s \in S}) \in \mathring{\text{Jac}}(P, S).$$

For any $\tilde{\varphi} : \partial D \rightarrow \pi_0(P^A) \sqcup S$ such that $\text{proj}_{P^A}^{\pi_0} \circ \tilde{\varphi} = \varphi$ and $x' \in \pi_0(P^A)$, one has $\tilde{\varphi}^{-1}(x') \subset \varphi^{-1}(x)$, where $x := \text{proj}_{P^A}^{\pi_0}(x')$. Define $\text{lin}_{x'}^{\tilde{\varphi}}$ as the linear order on $\tilde{\varphi}^{-1}(x')$ given by the restriction of lin_x , see §3.1.

Define a map

$$(3.8) \quad \text{dbl}_{\mathring{\text{Jac}}}((P, A), S) : \mathring{\text{Jac}}(P, S) \longrightarrow \mathbb{C}\mathring{\text{Jac}}(P^A, S)$$

by

$$(D, \varphi, \{\text{lin}_x\}_{x \in \pi_0(P)}, \{\text{cyc}_s\}_{s \in S}) \longmapsto \sum_{\tilde{\varphi} : \partial D \rightarrow \pi_0(P^A) \sqcup S \text{ with } \text{proj}_{P^A}^{\pi_0} \circ \tilde{\varphi} = \varphi} (D, \tilde{\varphi}, \{\text{lin}_{x'}^{\tilde{\varphi}}\}_{x' \in \pi_0(P^A)}, \{\text{cyc}_s\}_{s \in S}).$$

Lemma 3.23. *Let $P \in \vec{\mathcal{B}r}$ and $A \subset \pi_0(P)$ and S be a finite set. The map (3.8) induces a continuous linear map*

$$(3.9) \quad \text{dbl}_{\mathcal{A}}((P, A), S) : \mathring{\mathcal{A}}^{\wedge}(P, S) \longrightarrow \mathring{\mathcal{A}}^{\wedge}(P^A, S).$$

The assignment $S \mapsto \text{dbl}_{\mathcal{A}}((P, A), S)$ defines a natural transformation $\text{dbl}_{\mathcal{A}}((P, A), \bullet) : \mathring{\mathcal{A}}^{\wedge}(P, \bullet) \longrightarrow \mathring{\mathcal{A}}^{\wedge}(P^A, \bullet)$ between the functors $\mathring{\mathcal{A}}^{\wedge}(P, \bullet) : \text{Set}_f \rightarrow \text{Vect}$ and $\mathring{\mathcal{A}}^{\wedge}(P^A, \bullet) : \text{Set}_f \rightarrow \text{Vect}$.

Proof. One checks that the linear extension of the map (3.8) is compatible with the STU, AS and IHX relations. One also checks that the assignment $S \mapsto \text{dbl}_{\mathcal{A}}((P, A), S)$ is compatible with bijections $S \rightarrow E$ which implies the second statement. \square

Remark 3.24. In drawings, we use the *box notation* to denote the sum over all the possible ways of gluing the univalent vertices of a diagram D attached to the grey box to the segments involved in it, so that if there are k univalent vertices attached to it and two segments, the sum consists of 2^k terms. See Figure 3.6.

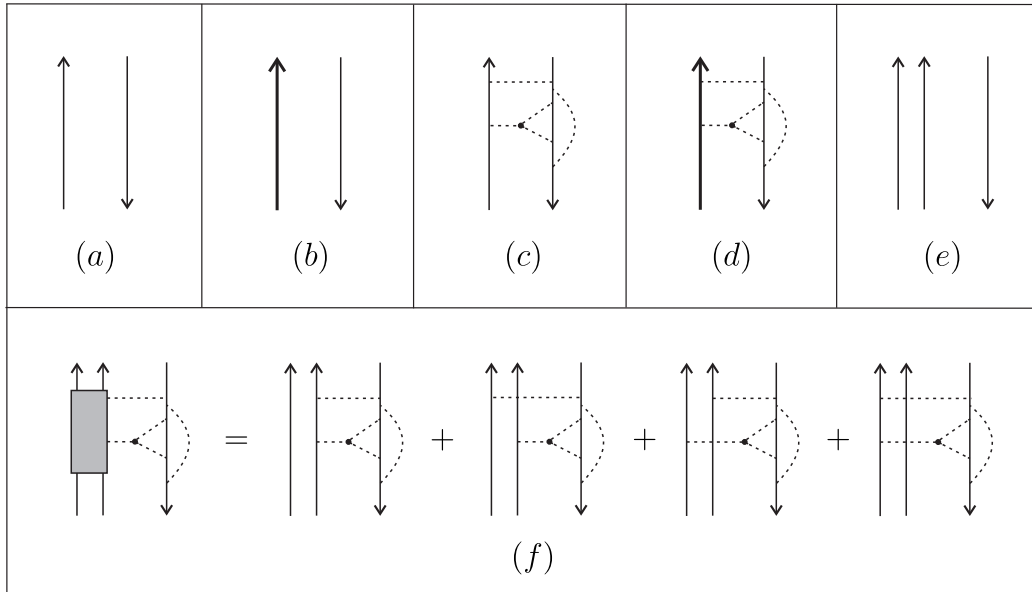

FIGURE 3.6. Schematic representation of $\text{dbl}_{\mathcal{A}}((\uparrow\downarrow, \{\uparrow\}), \emptyset) : \mathring{\mathcal{A}}^{\wedge}(\uparrow\downarrow, \emptyset) \longrightarrow \mathring{\mathcal{A}}^{\wedge}(\uparrow\uparrow\downarrow, \emptyset)$. In (a) we show $P = \uparrow\downarrow \in \vec{\mathcal{B}r}$, in (b) we show $(P, A) = (\uparrow\downarrow, \{\uparrow\})$ using thick lines for representing $A \subset \pi_0(P)$. In (c) we show an element $\underline{D} \in \mathring{\text{Jac}}(\uparrow\downarrow, \emptyset)$. In (e) we show $P^A = \uparrow\downarrow^{\{\uparrow\}} = \text{dbl}_{\vec{\mathcal{B}r}}(P, A) = \uparrow\uparrow\downarrow$ and in (f) we show a schematic representation of $\text{dbl}_{\mathring{\text{Jac}}}((\uparrow\downarrow, \{\uparrow\}), \emptyset)(\underline{D})$ using the box notation. Its class in $\mathring{\mathcal{A}}^{\wedge}(\uparrow\uparrow\downarrow, \emptyset)$ is $\text{dbl}_{\mathcal{A}}((\uparrow\downarrow, \{\uparrow\}), \emptyset)([\underline{D}])$.

Convention 3.25. Consider a pair (P, A) with $P \in \vec{\mathcal{B}r}$ and $A \subset \pi_0(P)$ and S a finite set. For $[\underline{D}] \in \mathring{\mathcal{A}}^{\wedge}(P, S)$, we also represent $[\underline{D}]^A := \text{dbl}_{\mathcal{A}}((P, A), S)([\underline{D}]) \in \mathring{\mathcal{A}}^{\wedge}(P^A, S)$ schematically by using two nested blue boxes around the schematic representation of \underline{D} and A is indicated by using \vee 's (resp. \wedge 's) between the two blue boxes on each top (resp. bottom) boundary point $a \in \bigsqcup_{p \in A} p \cap \llbracket 1, \text{t}(P) \rrbracket$ (resp. $a \in \bigsqcup_{p \in A} p \cap \llbracket 1, \text{t}(P) \rrbracket$). In Figure 3.7 we shown an example of this notation.

Convention 3.26. If $P = \text{Id}_w \in \vec{\mathcal{B}r}(w, w)$ for $w \in \{+, -\}^*$, then for $i \in \llbracket 1, |w| \rrbracket$, we denote by dbl_i the map $\text{dbl}_{\mathcal{A}}(P, \{i, i\})$. Moreover, if $|w| = 1$ we write dbl instead of dbl_1 .

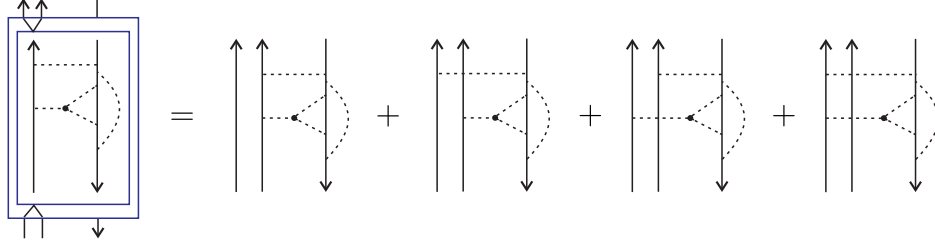

FIGURE 3.7. The element $\text{dbl}_1([\underline{D}]) \in \mathring{\mathcal{A}}^\wedge(P^A, \emptyset)$ from Figure 3.6 (f) using the convention of nested blue boxes for doubling.

3.7. Proof of the pre-LMO axioms (LMO1), (LMO2) and (LMO3).

Lemma 3.27. *Let X, Y and Z be finite sets and let $\text{succ}_{XY}, \text{succ}_{YZ}$ be PDISMs (see Definition 3.3) on $X \sqcup Y$ and $Y \sqcup Z$. Let $\text{orb}(X \sqcup Y) = \text{orb}_{\text{lin}}(X \sqcup Y) \sqcup \text{orb}_{\text{cyc}}(X \sqcup Y)$ and $\text{orb}(Y \sqcup Z) = \text{orb}_{\text{lin}}(Y \sqcup Z) \sqcup \text{orb}_{\text{cyc}}(Y \sqcup Z)$ as in Lemma 3.4. Suppose that $\text{succ}_{XY}(X) \subset Y$, $\text{succ}_{XY}(Y) \subset X$, and $\text{succ}_{YZ}(Y) \subset Z$, $\text{succ}_{YZ}(Z) \subset Y$. Assume also that $\text{succ}_{XY}(X) \cap \text{succ}_{YZ}(Z) = \emptyset$ and that for $y \in Y$, $\text{succ}_{XY}(y)$ is defined if and only if $\text{succ}_{YZ}(y)$ is undefined.*

- (a) A PDISM $\text{succ}_{XY,Z}$ on $\text{orb}_{\text{lin}}(X \sqcup Y) \sqcup Z$ is defined as follows: Let $\omega \in \text{orb}_{\text{lin}}(X \sqcup Y)$ and m_ω be the maximal element of the underlying set of ω ;
 - (i) if $m_\omega \in X$, then $\text{succ}_{XY,Z}(\omega)$ is undefined;
 - (ii) if $m_\omega \in Y$, then $\text{succ}_{XY}(m_\omega)$ is undefined, therefore $\text{succ}_{YZ}(m_\omega)$ is defined and belongs to Z , and one sets $\text{succ}_{XY,Z}(\omega) := \text{succ}_{YZ}(m_\omega)$. If $z \in Z$, then if $\text{succ}_{YZ}(z)$ is undefined, then so is $\text{succ}_{XY,Z}(z)$; and if $\text{succ}_{YZ}(z)$ is defined, then it belongs to Y and if one denotes it y , then $\text{succ}_{XY,Z}(z) := (y, \text{succ}_{XY}(y), \text{succ}_{XY}^2(y), \dots) \in \text{orb}_{\text{lin}}(X \sqcup Y)$.
- (b) A PDISM $\text{succ}_{X,YZ}$ on $X \sqcup \text{orb}_{\text{lin}}(Y \sqcup Z)$ is similarly defined.
- (c) A PDISM succ on $X \sqcup Y \sqcup Z$ is defined as follows: for $x \in X$, if $\text{succ}_{XY}(x)$ is undefined, then $\text{succ}(x)$ is undefined; if $\text{succ}_{XY}(x)$ is defined, then $\text{succ}(x) := \text{succ}_{XY}(x)$; for $z \in Z$, if $\text{succ}_{YZ}(z)$ is undefined, then $\text{succ}(z)$ is undefined; if $\text{succ}_{YZ}(z)$ is defined, then $\text{succ}(z) := \text{succ}_{YZ}(z)$; if $y \in Y$, then either $\text{succ}_{XY}(y)$ is defined, then $\text{succ}(y) := \text{succ}_{XY}(y)$; or $\text{succ}_{YZ}(y)$ is defined, then $\text{succ}(y) := \text{succ}_{YZ}(y)$.
- (d) The PDISM succ coincides with the PDISM on $X \sqcup Y \sqcup Z$ obtained by combining the PDISM $\text{succ}_{XY,Z}$ on $\text{orb}_{\text{lin}}(X \sqcup Y) \sqcup Z$, the map $X \sqcup Y \sqcup Z \rightarrow (\text{orb}_{\text{lin}}(X \sqcup Y) \sqcup Z) \sqcup \text{orb}_{\text{cyc}}(X \sqcup Y)$, the linear (resp. cyclic) order in the fibers of $\text{orb}_{\text{lin}}(X \sqcup Y) \sqcup Z$ (resp. $\text{orb}_{\text{cyc}}(X \sqcup Y)$) for this map, and Lemma 3.2, as well as with the PDISM on $X \sqcup Y \sqcup Z$ obtained by combining the PDISM $\text{succ}_{X,YZ}$ the map $X \sqcup Y \sqcup Z \rightarrow (X \sqcup \text{orb}_{\text{lin}}(Y \sqcup Z)) \sqcup \text{orb}_{\text{cyc}}(Y \sqcup Z)$, the linear (resp. cyclic) order in the fibers of $X \sqcup \text{orb}_{\text{lin}}(Y \sqcup Z)$ (resp. $\text{orb}_{\text{cyc}}(Y \sqcup Z)$) for this map, and Lemma 3.2.

Proof. The result follows straightforwardly from the definitions. \square

Lemma 3.28. *The collection of assignments taking:*

- (a) $P \in \vec{\mathcal{B}}r$ to the functor $\mathring{\mathcal{A}}^\wedge(P, \bullet) : \text{Set}_f \rightarrow \text{Vect}$, see §3.2;
- (b) $w \in \{+, -\}^*$ to the element $\text{Id}_w^A := (\text{Id}_w)_A \in \mathring{\mathcal{A}}^\wedge(\text{Id}_w, \emptyset)$, see Definition 3.11;
- (c) each pair $P, P' \in \vec{\mathcal{B}}r$ to the natural transformation $\text{Tens}^A(P, P')_{\bullet, \diamond} : \mathring{\mathcal{A}}^\wedge(P, \bullet) \otimes \mathring{\mathcal{A}}^\wedge(P', \diamond) \rightarrow \mathring{\mathcal{A}}^\wedge(P \otimes P', \bullet \sqcup \diamond)$, see §3.3;
- (d) every composable pair $P, P' \in \vec{\mathcal{B}}r$ to the natural transformation $\text{Comp}^A(P, P')_{\bullet, \diamond} : \mathring{\mathcal{A}}^\wedge(P, \bullet) \otimes \mathring{\mathcal{A}}^\wedge(P', \diamond) \rightarrow \mathring{\mathcal{A}}^\wedge(P' \circ P, \bullet \sqcup \diamond \sqcup \text{Cir}(P', P))$, see §3.4;

satisfies the axiom (LMO1) in Definition 2.94.

Proof. The only non-immediate statement is (c) from (LMO1). It relies on the following statements: (a) for (P, P') and (P', P'') two composable pairs in $\vec{\mathcal{B}}r$, the diagram (3.10)

$$\begin{array}{ccc}
\pi_0(P'') \sqcup \pi_0(P') \sqcup \pi_0(P) & \xrightarrow{\text{Id}} & \pi_0(P'') \sqcup \pi_0(P') \sqcup \pi_0(P) \\
\downarrow \text{proj}_{P'', P'}^{\pi_0} \sqcup \text{Id}_{\pi_0(P)} & & \downarrow \text{Id}_{\pi_0(P'')} \sqcup \text{proj}_{P', P}^{\pi_0} \\
\pi_0(P'' \circ P') \sqcup \text{Cir}(P'', P') \sqcup \pi_0(P) & & \pi_0(P'') \sqcup \pi_0(P' \circ P) \sqcup \text{Cir}(P', P) \\
\downarrow \simeq & & \downarrow \text{Id} \\
\pi_0(P'' \circ P') \sqcup \pi_0(P) \sqcup \text{Cir}(P'', P') & & \pi_0(P'') \sqcup \pi_0(P' \circ P) \sqcup \text{Cir}(P', P) \\
\downarrow \text{proj}_{P'' \circ P', P}^{\pi_0} \sqcup \text{Id}_{\text{Cir}(P'', P')} & & \downarrow \text{proj}_{P'' \circ P', P}^{\pi_0} \sqcup \text{Id}_{\text{Cir}(P', P)} \\
\pi_0((P'' \circ P') \circ P) \sqcup \text{Cir}(P'' \circ P', P) \sqcup \text{Cir}(P'', P') & \xrightarrow{\varphi} & \pi_0(P'' \circ (P' \circ P)) \sqcup \text{Cir}(P'', P' \circ P) \sqcup \text{Cir}(P', P)
\end{array}$$

commutes, where $\varphi := \text{Id} \sqcup \text{bij}_{P'', P', P}$ (see Proposition 1.10) and the notation $\text{proj}_{\bullet, \diamond}^{\pi_0}$ is as in Lemma 1.42; and (b) the linear (resp. cyclic) orders on the fibers of $\pi_0((P'' \circ P') \circ P)$ and $\pi_0(P'' \circ (P' \circ P))$ (resp. $\text{Cir}(P'' \circ P', P) \sqcup \text{Cir}(P'', P')$ and $\text{Cir}(P'', P' \circ P) \sqcup \text{Cir}(P', P)$) for the composed map corresponding to the left (resp. right) column of (3.10) (obtained using Lemma 3.2) coincide. This follows from Lemma 3.27 with $X := \pi_0(P)$, $Y := \pi_0(P')$ and $Z := \pi_0(P'')$ and succ_{XY} and succ_{YZ} given by Lemma 3.16. \square

Lemma 3.29. *The collection of assignments: (a) and (c) as in Lemma 3.28 and*

- (e) *the assignment taking $P \in \vec{\mathcal{B}}r$ to the natural involution $\text{co}^A(P, \bullet) : \mathring{A}^\wedge(P, \bullet) \rightarrow \mathring{A}^\wedge(P, \bullet)$ of the functor $\mathring{A}^\wedge(P, \bullet) : \text{Set}_f^* \rightarrow \text{Vect}$ taking the pointed finite set (S, s) to the vector space $\mathring{A}^\wedge(P, S)$, see Lemma 3.21;*

satisfies the axiom (LMO2) in Definition 2.94.

Proof. It follows directly from Definition 3.20 that the analogous statement to (a) in (LMO2) in the setting of Jacobi diagrams holds. By considering the corresponding linear extensions and quotient by the STU, AS and IHX relations we then obtain the desired result. Similarly, for finite sets S and S' and $s_0 \in S$, the diagram

$$\begin{array}{ccc}
\mathring{\text{Jac}}(\vec{\emptyset}, S) \times \mathring{\text{Jac}}(\vec{\emptyset}, S') & \xrightarrow{\text{Tens}^{\mathring{\text{Jac}}(\vec{\emptyset}, \vec{\emptyset})}_{S, S'}} & \mathring{\text{Jac}}(\vec{\emptyset}, S \sqcup S') \\
\downarrow \text{co}^{\mathring{\text{Jac}}(\vec{\emptyset}, (S, s_0))} \times \text{Id}_{\mathring{\text{Jac}}(\vec{\emptyset}, S')} & & \downarrow \text{co}^{\mathring{\text{Jac}}(\vec{\emptyset}, (S \sqcup S', s_0))} \\
\mathring{\text{CJac}}(\vec{\emptyset}, S) \times \mathring{\text{Jac}}(\vec{\emptyset}, S') & \xrightarrow{\text{CTens}^{\mathring{\text{Jac}}(\vec{\emptyset}, \vec{\emptyset})}_{S, S'}} & \mathring{\text{CJac}}(\vec{\emptyset}, S \sqcup S')
\end{array}$$

commutes. Indeed, let $\underline{D} = (D, \varphi, \emptyset, \{\text{cyc}_s\}_{s \in S}) \in \mathring{\text{Jac}}(\vec{\emptyset}, S)$ (resp. $\underline{D}' = (D', \varphi', \emptyset, \{\text{cyc}_{s'}\}_{s' \in S'}) \in \mathring{\text{Jac}}(\vec{\emptyset}, S')$). The image of $(\underline{D}, \underline{D}')$ by $\text{co}^{\mathring{\text{Jac}}(\vec{\emptyset}, (S, s_0))} \times \text{Id}_{\mathring{\text{Jac}}(\vec{\emptyset}, S')}$ is $((-1)^{|\varphi^{-1}(s_0)|} \underline{D}^{s_0}, \underline{D}')$, where

$$\underline{D}^{s_0} := (D, \varphi, \emptyset, \{\text{cyc}_s\}_{s \in S \setminus \{s_0\}} \sqcup \{\overline{\text{cyc}}_{s_0}\}),$$

see Definition 3.20. The image of the latter element by $\text{CTens}^{\mathring{\text{Jac}}(\vec{\emptyset}, \vec{\emptyset})}_{S, S'}$ is

$$(-1)^{|\varphi^{-1}(s_0)|} (D \sqcup D', \varphi \sqcup \varphi', \emptyset, \{\text{cyc}_s\}_{s \in S \setminus \{s_0\}} \sqcup \{\overline{\text{cyc}}_{s_0}\} \sqcup \{\text{cyc}_{s'}\}_{s' \in S'}),$$

see Definition 3.13. The image of $(\underline{D}, \underline{D}')$ under the composition $\text{co}^{\mathring{\text{Jac}}(\vec{\emptyset}, (S \sqcup S', s_0))} \circ \text{Tens}^{\mathring{\text{Jac}}(\vec{\emptyset}, \vec{\emptyset})}_{S, S'}$ is

$$(-1)^{|\varphi \sqcup \varphi'|^{-1}(s_0)|} (D \sqcup D', \varphi \sqcup \varphi', \emptyset, \{\text{cyc}_s\}_{s \in S \setminus \{s_0\}} \sqcup \{\overline{\text{cyc}}_{s_0}\} \sqcup \{\text{cyc}_{s'}\}_{s' \in S'}).$$

The equality of the expressions (3.12) and (3.13) follows from the equality between $(\varphi \sqcup \varphi')^{-1}(s_0)$ and $\varphi^{-1}(s_0)$, which shows the commutativity of diagram (3.11). The statement (b) in (LMO2) follows from the commutativity of this diagram. \square

Lemma 3.30. *The collection of assignments (a) and (c) from Lemma 3.28 together with*

(f) *the assignment taking a pair (P, A) with $P \in \vec{\mathcal{B}}r$ and $A \subset \pi_0(P)$ to the natural transformation $\text{dbl}_A((P, A), \bullet) : \mathring{A}^\wedge(P, \bullet) \rightarrow \mathring{A}^\wedge(\text{dbl}_{\vec{\mathcal{B}}r}(P, A), \bullet)$ (see Lemma 3.23)*

satisfies axiom (LMO3) from Definition 2.94.

Proof. This is a consequence of the commutativity of the analogue of diagram (2.40) in (LMO3) of Definition 2.94 for spaces of Jacobi diagrams, which we now prove. Let $P, P' \in \vec{\mathcal{B}}r$, let $A \subset \pi_0(P)$ and S and S' be finite sets. We denote by $\text{pr} := \text{proj}_{P,A}^{\pi_0} : \pi_0(\text{dbl}_{\vec{\mathcal{B}}r}(P, A)) \rightarrow \pi_0(P)$ the natural projection map, see Lemma 1.42(b). Let $\underline{D} = (D, \varphi, \{\text{lin}_l\}_{l \in \pi_0(P)}, \{\text{cyc}_s\}_{s \in S}) \in \mathring{\text{Jac}}(P, S)$ and $\underline{D}' = (D', \varphi', \{\text{lin}_{l'}\}_{l' \in \pi_0(P')}, \{\text{cyc}_{s'}\}_{s' \in S'}) \in \mathring{\text{Jac}}(P', S')$. Observe that for $\psi : \partial D \sqcup \partial D' \rightarrow \pi_0(\text{dbl}_{\vec{\mathcal{B}}r}(P, A)) \sqcup S \sqcup \pi_0(P') \sqcup S'$ a map such that $(\text{pr} \sqcup \text{Id}_{S \sqcup \pi_0(P') \sqcup S'}) \circ \psi = \varphi \sqcup \varphi'$, one has: for all $l \in \pi_0(\text{dbl}_{\vec{\mathcal{B}}r}(P, A))$, $\psi^{-1}(l)$ is contained in $\varphi^{-1}(\text{pr}(l))$, which is equipped with the linear order $\text{lin}_{\varphi^{-1}(\text{pr}(l))}$, therefore $\psi^{-1}(l)$ is equipped with the restriction of this linear order, we denote it by $\text{lin}_{\varphi^{-1}(\text{pr}(l))|_{\psi^{-1}(l)}}$; for $l' \in \pi_0(P')$, $\psi^{-1}(l')$ is equal to $(\varphi')^{-1}(l')$, which is equipped with the linear order $\text{lin}_{l'}$; for $s \in S$ (resp. $s' \in S'$), $\psi^{-1}(s)$ (resp. $\psi^{-1}(s')$) is equal to $\varphi^{-1}(s)$ (resp. $(\varphi')^{-1}(s')$), which is equipped with the cyclic order cyc_s (resp. $\text{cyc}_{s'}$). Then one checks that the common value of the images of $\underline{D} \otimes \underline{D}'$ by the two involved maps is equal to

$$\sum_{\psi} (D \sqcup D', \psi, \{\text{lin}_{\varphi^{-1}(\text{pr}(l))|_{\psi^{-1}(l)}}\}_{l \in \pi_0(\text{dbl}_{\vec{\mathcal{B}}r}(P, A))}, \{\text{lin}_{l'}\}_{l' \in \pi_0(P')}, \{\text{cyc}_s\}_{s \in S}, \{\text{cyc}_{s'}\}_{s' \in S'})$$

where the sum runs over the set of maps $\psi : \partial D \sqcup \partial D' \rightarrow \pi_0(\text{dbl}_{\vec{\mathcal{B}}r}(P, A)) \sqcup S \sqcup \pi_0(P') \sqcup S'$ such that $(\text{pr} \sqcup \text{Id}_{S \sqcup \pi_0(P') \sqcup S'}) \circ \psi = \varphi \sqcup \varphi'$. □

We summarize the results of this section in the following result.

Theorem 3.31. *The collection of assignments (a)–(d) in Lemma 3.28, (e) in Lemma 3.29 and (f) in Lemma 3.30, satisfies axioms (LMO1), (LMO2) and (LMO3) from Definition 2.94.*

3.8. The natural transformation $\text{co}^A((P, a), \bullet)$ and the assignment $Z_A(\bullet)$.

3.8.1. *The natural transformation $\text{co}^A((P, a), \bullet)$.* Let $P \in \vec{\mathcal{B}}r$, let $a \in \pi_0(P)$. Recall that there is a canonical bijection $\pi_0(\text{co}_{\vec{\mathcal{B}}r}(P, a)) \simeq \pi_0(P)$, see Lemma 1.41. Let S be a finite set. For

$$(D, \varphi, \{\text{lin}_l\}_{l \in \pi_0(P)}, \{\text{cyc}_s\}_{s \in S}) \in \mathring{\text{Jac}}(P, S),$$

the tuple $(D, \tilde{\varphi}, \{\widetilde{\text{lin}}_l\}_{l \in \pi_0(\text{co}_{\vec{\mathcal{B}}r}(P, a))}, \{\text{cyc}_s\}_{s \in S})$, where $\tilde{\varphi}$ is the composition of $\partial D \xrightarrow{\varphi} \pi_0(P)$ with the bijection $\pi_0(P) \simeq \pi_0(\text{co}_{\vec{\mathcal{B}}r}(P, a))$ and where for $l \in \pi_0(\text{co}_{\vec{\mathcal{B}}r}(P, a)) \simeq \pi_0(P)$, $\widetilde{\text{lin}}_l$ is equal to lin_l if $l \neq a$ and is equal to $\overline{\text{lin}}_a$ (the opposite linear order of lin_a) otherwise, belongs to $\mathring{\text{Jac}}(\text{co}_{\vec{\mathcal{B}}r}(P, a), S)$.

Definition 3.32. Let P be an oriented Brauer diagram and S be a finite set. Define a map

$$(3.14) \quad \text{co}^{\mathring{\text{Jac}}}((P, a), S) : \mathring{\text{Jac}}(P, S) \longrightarrow \mathbb{C}\mathring{\text{Jac}}(\text{co}_{\vec{\mathcal{B}}r}(P, a), S)$$

by $(D, \varphi, \{\text{lin}_l\}_{l \in \pi_0(P)}, \{\text{cyc}_s\}_{s \in S}) \mapsto (-1)^{|\varphi^{-1}(a)|} (D, \tilde{\varphi}, \{\widetilde{\text{lin}}_l\}_{l \in \pi_0(\text{co}_{\vec{\mathcal{B}}r}(P, a))}, \{\text{cyc}_s\}_{s \in S})$.

This map is illustrated in Figure 3.8.

Lemma 3.33. *Let P be an oriented Brauer diagram and S be a finite set. The map (3.14) induces a continuous linear isomorphism*

$$(3.15) \quad \text{co}^A((P, a), S) : \mathring{A}^\wedge(P, S) \rightarrow \mathring{A}^\wedge(\text{co}_{\vec{\mathcal{B}}r}(P, a), S).$$

The assignment $S \mapsto \text{co}^A((P, a), \bullet)$ defines a natural isomorphism of the functors $\mathring{A}^\wedge(P, \bullet) : \text{Set}_f \rightarrow \text{Vect}$ and $\mathring{A}^\wedge(\text{co}_{\vec{\mathcal{B}}r}(P, a), \bullet) : \text{Set}_f \rightarrow \text{Vect}$.

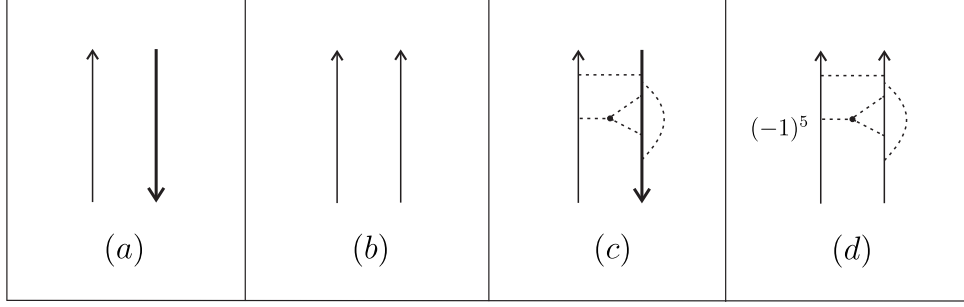

FIGURE 3.8. Schematic illustration of the change of orientation map $\text{co}^{\text{Jac}}((\uparrow\downarrow, \downarrow), \emptyset) : \mathring{\text{Jac}}(\uparrow\downarrow, \emptyset) \longrightarrow \mathbb{C}\mathring{\text{Jac}}(\text{co}_{\vec{\mathcal{B}}_r}(\uparrow\downarrow, \downarrow), \emptyset) = \mathring{\text{Jac}}(\uparrow\uparrow, \emptyset)$. In (a) we show the schematic representation of the oriented Brauer diagram $\uparrow\downarrow$ with $a \in \pi_0(\uparrow\downarrow)$ indicated by using thick lines. In (b) we show the schematic representation of $\text{co}_{\vec{\mathcal{B}}_r}(\uparrow\downarrow, \downarrow) = \uparrow\uparrow$. In (c) we show a schematic representation of a Jacobi diagram on $(\uparrow\downarrow, \emptyset)$ and in (d) its image under the map $\text{co}^{\text{Jac}}((\uparrow\downarrow, \downarrow), \emptyset)$.

Proof. It follows easily from the definition that the linear extension of the map (3.14) is compatible with the STU, AS and IHX relations. One also checks that the assignment $S \mapsto \text{co}^{\mathcal{A}}((P, a), \bullet)$ is compatible with bijections $f : S \rightarrow S'$. \square

Convention 3.34. If $P = \text{Id}_w \in \vec{\mathcal{B}}_r(w, w)$ for $w \in \{+, -\}^*$, then for $i \in \llbracket 1, |w| \rrbracket$, we denote by co_i the map $\text{co}_{\mathcal{A}}(P, \tilde{w}(i))$, where $\tilde{w}(i)$ denotes the element in $\pi_0(\text{Id}_w)$ corresponding to i . Moreover, if $|w| = 1$ we write co instead of co_1 .

3.8.2. *The assignment $Z_{\mathcal{A}}(\bullet)$.* In this subsection we associate to a parenthesized tangle T an element $Z_{\mathcal{A}}(T) \in \mathring{\mathcal{A}}^\wedge(\vec{\text{br}}(T), \pi_0(T))$ called the Kontsevich integral of T , which is an isotopy invariant of parenthesized tangles, and therefore defines an element $Z_{\mathcal{A}}(\mathbf{T}) \in \mathring{\mathcal{A}}^\wedge(\vec{\text{br}}(\mathbf{T}), \pi_0(\mathbf{T}))$ for any $\mathbf{T} \in \mathcal{Pa}\vec{\mathcal{T}}$. We follow the combinatorial approach [35, 24, 41].

Recall that a family of morphisms in a monoidal category $\underline{\mathcal{C}}$ is a *generating family* if every morphism of $\underline{\mathcal{C}}$ can be obtained from its morphisms and the morphisms Id_x with $x \in \text{Ob}(\underline{\mathcal{C}})$ by a finite number of applications of the tensor product and composition.

The following can be deduced from [53, Thm. 3.2]), see also [3, Thm. 1] or [41, Thm. 6.5].

Theorem 3.35 (Turaev). *Let \mathcal{E} be the family consisting of the set of parenthesized tangles shown in Figure 3.9, where the thick lines in the figures in position three and four (from left to right) represent a trivial tangle (with arbitrary orientation) and the black dots some non-associative words on $\{+, -\}$. Then*



FIGURE 3.9. Elements of the \mathcal{E} .

the family \mathcal{E} is a generating family of the monoidal category $\mathcal{Pa}\vec{\mathcal{T}}$.

Lemma 3.36. *The parenthesized tangles shown in Figure 3.10 are particular elements of \mathcal{E} and all the elements in position three and four (from left to right) in Figure 3.9 can be obtained from these particular elements by applying to them a finite number of doubling operations $\text{dbl}_{\mathcal{Pa}\vec{\mathcal{T}}}$ and change of orientation operations $\text{co}_{\mathcal{Pa}\vec{\mathcal{T}}}$ (see Definition 2.54).*

Proof. The result follows straightforwardly. \square

FIGURE 3.10. Particular elements of \mathcal{E} .

To define $Z_{\mathcal{A}}$ we need an *associator* Φ . More precisely, let $\mathbb{C}\langle\langle A, B \rangle\rangle$ be the power series ring on the non-commutative free variables A and B . We fix an *even Drinfeld associator* $\varphi(A, B) \in \mathbb{C}\langle\langle A, B \rangle\rangle$. This is an exponential series satisfying several conditions, see [4, 19] or [41, Appendix D] for the precise definitions.

There is an algebra morphism

$$(3.16) \quad \text{can} : \mathbb{C}\langle\langle A, B \rangle\rangle \longrightarrow \mathring{\mathcal{A}}^\wedge(\downarrow\downarrow\downarrow, \emptyset)$$

given by

$$A \longmapsto \begin{array}{c} \downarrow \cdots \downarrow \\ \downarrow \end{array} \quad \text{and} \quad B \longmapsto \begin{array}{c} \downarrow \downarrow \cdots \downarrow \\ \downarrow \end{array}.$$

Set $\Phi := \text{can}(\varphi(A, B)) \in \mathring{\mathcal{A}}^\wedge(\downarrow\downarrow\downarrow, \emptyset)$. Therefore Φ is an exponential series of Jacobi diagrams satisfying several properties, see [41, (6.11)–(6.13)]. The element Φ is also called an *even Drinfeld associator*. In low degree we have:

$$\Phi = 1 + \frac{1}{24} \begin{array}{c} \downarrow \cdots \downarrow \\ \downarrow \end{array} + \text{deg} \geq 4 \quad \text{and} \quad \Phi^{-1} = 1 - \frac{1}{24} \begin{array}{c} \downarrow \cdots \downarrow \\ \downarrow \end{array} + \text{deg} \geq 4.$$

Here 1 means $\downarrow\downarrow\downarrow$. Set

$$\nu := \left(\begin{array}{c} \downarrow \quad \text{co}_2 \quad \downarrow \\ \downarrow \end{array} \Phi \right)^{-1} = \downarrow + \frac{1}{48} \begin{array}{c} \downarrow \cdots \downarrow \\ \downarrow \end{array} + (\text{deg} \geq 4) \in \mathring{\mathcal{A}}^\wedge(\downarrow, \emptyset)$$

where co_2 is as in Convention 3.26. One can show that the element $\nu \in \mathring{\mathcal{A}}^\wedge(\downarrow, \emptyset)$ does not depend on the choice of the associator Φ , see for instance [41, Thm. 6.7]. Its explicit value was conjectured in [5], this is known as the *wheels conjecture*, and it was proved in [10].

We also need the square root of ν :

$$\nu^{\frac{1}{2}} = \downarrow + \frac{1}{96} \begin{array}{c} \downarrow \cdots \downarrow \\ \downarrow \end{array} + (\text{deg} \geq 4) \in \mathring{\mathcal{A}}^\wedge(\downarrow, \emptyset)$$

The following is the main theorem of this subsection, it was obtained by Le–Murakami [34, 35], see also [3, 13, 42]. We refer to [24, §17.2] for a detailed explanation.

Theorem 3.37 (Le–Murakami). *There is a unique assignment*

$$\mathcal{PaT} \ni \mathbf{T} \longmapsto Z_{\mathcal{A}}(\mathbf{T}) \in \mathring{\mathcal{A}}^\wedge(\vec{\text{br}}(\mathbf{T}), \pi_0(\mathbf{T})_{\text{cir}}),$$

such that

- (a) $Z_{\mathcal{A}}(\text{Id}_{w'}) = \text{Id}_{w'} \in \mathring{\mathcal{A}}^\wedge(\downarrow_{|w'|}, \emptyset)$ for any $w' \in \{+\}^{(*)}$, where $w' \in \{+\}^*$ is the image under the natural forget-parenthesization map $\{+\}^{(*)} \rightarrow \{+\}^*$ and $\downarrow_{|w'|} = \text{Id}_{w'} \in \vec{\mathcal{B}}r(w', w')$ and

$$Z_{\mathcal{A}}\left(\begin{array}{c} (+ \quad +) \\ \diagdown \quad \diagup \\ (+ \quad +) \end{array}\right) = \left[\frac{1}{2}\right] = \boxed{\exp\left(\frac{1}{2}\downarrow\downarrow\right)} = \begin{array}{c} \diagdown \quad \diagup \\ \diagdown \quad \diagup \end{array} + \frac{1}{2} \begin{array}{c} \text{---} \\ \diagdown \quad \diagup \\ \text{---} \end{array} + \frac{1}{8} \begin{array}{c} \text{---} \\ \diagdown \quad \diagup \\ \text{---} \\ \text{---} \end{array} + (\text{deg} \geq 3),$$

$$Z_{\mathcal{A}}\left(\begin{array}{c} (+ \quad +) \\ \diagup \quad \diagdown \\ (+ \quad +) \end{array}\right) = \left[\frac{1}{2}\right] = \boxed{\exp\left(-\frac{1}{2}\downarrow\downarrow\right)} = \begin{array}{c} \diagup \quad \diagdown \\ \diagup \quad \diagdown \end{array} - \frac{1}{2} \begin{array}{c} \text{---} \\ \diagup \quad \diagdown \\ \text{---} \end{array} + \frac{1}{8} \begin{array}{c} \text{---} \\ \diagup \quad \diagdown \\ \text{---} \\ \text{---} \end{array} + (\text{deg} \geq 3),$$

$$Z_{\mathcal{A}}\left(\begin{array}{c} \curvearrowright \\ (+ \quad -) \end{array}\right) = \nu^{\frac{1}{2}} \curvearrowright, \quad Z_{\mathcal{A}}\left(\begin{array}{c} (+ \quad -) \\ \curvearrowleft \end{array}\right) = \nu^{\frac{1}{2}} \curvearrowleft,$$

$$Z_{\mathcal{A}}\left(\begin{array}{c} (+ \quad ++ \\ \downarrow \quad \downarrow \\ ++ \quad + \end{array}\right) = \Phi, \quad Z_{\mathcal{A}}\left(\begin{array}{c} (++ \quad + \\ \downarrow \quad \downarrow \\ + \quad ++ \end{array}\right) = \Phi^{-1};$$

and on parenthesized tangles shown in position three and four (from left to right) in Figure 3.9 $Z_{\mathcal{A}}$ is defined using the corresponding doubling and change of orientation operations applied to the parenthesized tangles in Figure 3.10, for instance

$$Z_{\mathcal{A}}\left(\begin{array}{c} (+ \quad (- \quad +)) \\ \downarrow \quad \downarrow \quad \downarrow \\ (+ \quad -) \quad (+ \quad -) \end{array}\right) = \text{co}_4 \text{co}_2 \text{dbl}_3 \Phi = 1 - \frac{1}{24} \begin{array}{c} \uparrow \quad \uparrow \quad \uparrow \\ \downarrow \quad \downarrow \quad \downarrow \\ \uparrow \quad \uparrow \quad \uparrow \end{array} + \frac{1}{24} \begin{array}{c} \uparrow \quad \uparrow \quad \uparrow \\ \downarrow \quad \downarrow \quad \downarrow \\ \downarrow \quad \downarrow \quad \downarrow \end{array} + (\text{deg} \geq 4).$$

Here we are using Convention 3.26.

- (b) $Z_{\mathcal{A}}$ satisfies axiom (LMO4)(b) in Definition 2.94.
(c) $Z_{\mathcal{A}}$ satisfies axiom (LMO4)(c) in Definition 2.94.
(d) $Z_{\mathcal{A}}$ satisfies axiom (LMO4)(d) from Definition 2.94 and for any $\mathbf{T} \in \mathcal{Pa}\vec{\mathcal{T}}$ and $a \in \pi_0(\mathbf{T})_{\text{seg}} \simeq \pi_0(\vec{\text{br}}(\mathbf{T}))$ we have

$$Z_{\mathcal{A}}(\text{co}_{\mathcal{Pa}\vec{\mathcal{T}}}(\mathbf{T}, a)) = \text{co}^{\mathcal{A}}((\vec{\text{br}}(\mathbf{T}), a), \pi_0(\mathbf{T})_{\text{cir}})(Z_{\mathcal{A}}(\mathbf{T})).$$

Proof. Denote by $Z_{\mathcal{A}}$ the assignment \check{Z} from [24, §17.2]. Then $Z_{\mathcal{A}}$ satisfies property (a) by [24, Def. 17.7, 17.5 and (17.3)], properties (b), (c), (d), by [24, Def. 17.5 and 17.7]. One can check that these conditions define $Z_{\mathcal{A}}$ uniquely. \square

It is important to notice that the value of $Z_{\mathcal{A}}$ on a framed oriented link does not depend on the choice of an associator [35, Thm. 8].

By definition, If U denotes the unknot with trivial framing, we have $Z_{\mathcal{A}}(U) = \nu \in \mathring{\mathcal{A}}^\wedge(\downarrow, \emptyset) \cong \mathring{\mathcal{A}}^\wedge(\vec{\emptyset}, \pi_0(U)_{\text{cir}})$, see [41, Proposition 6.3] for the isomorphism $\mathring{\mathcal{A}}^\wedge(\downarrow, \emptyset) \cong \mathring{\mathcal{A}}^\wedge(\vec{\emptyset}, \{s\})$.

Convention 3.38. For an element $\mathbf{T} \in \mathcal{Pa}\vec{\mathcal{T}}(u, v)$ with parenthesized tangle representative T , we denote by

$$\begin{array}{c} v' \\ \boxed{T} \\ u' \end{array}$$

the element $Z_{\mathcal{A}}(\mathbf{T}) \in \mathring{\mathcal{A}}^\wedge(\vec{\text{br}}(\mathbf{T}), \pi_0(\mathbf{T})_{\text{circ}})$, where $\vec{\text{br}}(\mathbf{T}) \in \vec{\mathcal{B}}r(u', v')$ and $u', v' \in \{+\}^*$ are the images under the natural forget-parenthesization map $\{+, -\}^{(*)} \rightarrow \{+, -\}^*$. Moreover, sometimes we will omit the symbols $+$ and $-$ from the notation since these can be recovered from the orientation of T or from the orientation of its underlying Brauer diagram. Since $Z_{\mathcal{A}}$ defines an isotopy invariant of parenthesized tangles, we will write sometimes $Z_{\mathcal{A}}(T)$ instead of $Z_{\mathcal{A}}(\mathbf{T})$ for any $\mathbf{T} \in \mathcal{Pa}\vec{\mathcal{T}}(u, v)$ with tangle representative T .

Example 3.39. Here we use Conventions 3.38 and 3.26.

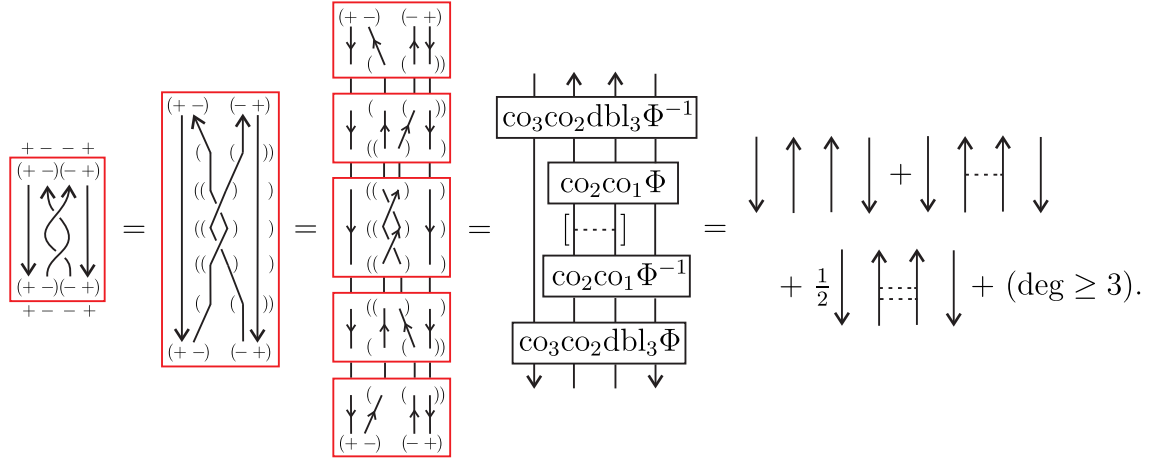

3.9. Proof of the pre-LMO axiom (LMO4) and the pre-LMO structure $\mathring{\mathbf{A}}$.

Lemma 3.40. *The collection of assignments (a)–(d) in Lemma 3.28, (e) in Lemma 3.29 and (f) in Lemma 3.30 together with*

(g) *the assignment $\mathcal{P}a\vec{T} \ni \mathbf{T} \mapsto Z_{\mathcal{A}}(\mathbf{T}) \in \mathring{\mathcal{A}}^\wedge(\vec{\text{br}}(\mathbf{T}), \pi_0(\mathbf{T}_{\text{circ}}))$*

satisfies axiom (LMO4) from Definition 2.94.

Proof. Items (a)–(d) in (LMO4) follow from Theorem 3.37. Item (e) in (LMO4) is a reformulation of [30, Theorem 4.2]. See also [41, §6.5]. \square

We can summarize the results in §3.2 – §3.8 in the following theorem.

Theorem 3.41. *The tuple*

$$\mathring{\mathbf{A}} := \left(\{ \mathring{\mathcal{A}}^\wedge(P, \bullet) \}_{P \in \vec{\mathcal{B}}_r}, \{ \text{Tens}^{\mathcal{A}}(P, P')_{\bullet, \bullet'} \}_{P, P' \in \vec{\mathcal{B}}_r}, \{ \text{Comp}^{\mathcal{A}}(P, P')_{\bullet, \bullet'} \}_{P, P' \text{ composable in } \vec{\mathcal{B}}_r}, \right. \\ \left. \{ \text{co}^{\mathcal{A}}(P, \bullet) \}_{P \in \vec{\mathcal{B}}_r}, \{ \text{dbl}_{\mathcal{A}}((P, A), \bullet) \}_{P \in \vec{\mathcal{B}}_r, A \subset \pi_0(P)}, Z_{\mathcal{A}}(\bullet) \right)$$

is a pre-LMO structure in the sense of Definition 2.94.

Since $\mathring{\mathbf{A}}$ is a pre-LMO structure, one may apply Proposition 2.110, so that one may attach to it the semi-Kirby structure $(\mathfrak{s}(\mathring{\mathbf{A}}), \mu)$.

3.10. Additional material.

3.10.1. Some relations among Jacobi diagrams.

Definition 3.42. Define the oriented Brauer diagrams $\text{cup}_{+-} := ((0, 2, (12)), \{1\}) \in \vec{\mathcal{B}}_r(\emptyset, +-)$, where (12) is the only element in $\text{FPFI}(\emptyset \sqcup \llbracket 1, 2 \rrbracket)$ and $\{1\} \subset \emptyset \sqcup \llbracket 1, 2 \rrbracket$ is the set beginning points, see Definition 1.27. Similarly, define $\text{cup}_{-+} := ((0, 2, (12)), \{2\}) \in \vec{\mathcal{B}}_r(\emptyset, -+)$, $\text{cap}_{-+} := ((2, 0, (12)), \{1\}) \in \vec{\mathcal{B}}_r(-+, \emptyset)$ and $\text{cap}_{+-} := ((2, 0, (12)), \{2\}) \in \vec{\mathcal{B}}_r(+-, \emptyset)$. Finally, define $\tau_{++} := ((2, 2, (1\bar{2})(2\bar{1})), \{\bar{1}, \bar{2}\}) \in \vec{\mathcal{B}}_r(++ , ++)$, we use Notation 1.13. The schematic representations of cup_{+-} , cup_{-+} , cap_{-+} and cap_{+-} coincide with the schematic representation of the oriented tangles shown in Figure 2.11 and that of τ_{++} is shown in Figure 3.11.

Definition 3.43. Define the map

$$z : \mathring{\mathcal{A}}^\wedge(\downarrow, \emptyset) \longrightarrow \mathring{\mathcal{A}}^\wedge(\uparrow, \emptyset)$$

by

$$z(x) = (\text{Id}_-^{\mathcal{A}} \otimes_{\mathcal{A}} (\text{cap}_{+-})_{\mathcal{A}}) \circ_{\mathcal{A}} (\text{Id}_-^{\mathcal{A}} \otimes_{\mathcal{A}} x \otimes_{\mathcal{A}} \text{Id}_-^{\mathcal{A}}) \circ_{\mathcal{A}} ((\text{cup}_{-+})_{\mathcal{A}} \otimes_{\mathcal{A}} \text{Id}_-^{\mathcal{A}})$$

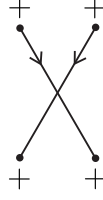

FIGURE 3.11. Schematic representation of the oriented Brauer diagram $\tau_{++} \in \vec{\mathcal{B}r}(++, ++)$.

for any $x \in \mathring{\mathcal{A}}^\wedge(\downarrow, \emptyset)$. Here $\text{Id}_-^{\mathcal{A}} = (\text{Id}_-)_A \in \mathring{\mathcal{A}}^\wedge(\text{Id}_-, \emptyset)$ and $(\text{cup}_{-+})_A \in \mathring{\mathcal{A}}^\wedge(\text{cup}_{-+}, \emptyset)$ are as in Definition 3.11, where $\text{Id}_- \in \vec{\mathcal{B}r}(-, -)$ is the identity morphism and $\text{cup}_{-+} \in \vec{\mathcal{B}r}(\emptyset, -+)$ as in Definition 3.42. In Figure 3.12 we show a schematic representation of this map.

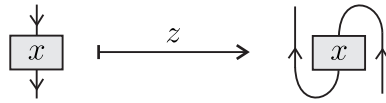

FIGURE 3.12. Schematic representation of the map $z : \mathring{\mathcal{A}}^\wedge(\downarrow, \emptyset) \rightarrow \mathring{\mathcal{A}}^\wedge(\uparrow, \emptyset)$. We represent $x \in \mathring{\mathcal{A}}^\wedge(\downarrow, \emptyset)$ by the grey-colored box.

Lemma 3.44. *The map $z : \mathring{\mathcal{A}}^\wedge(\downarrow, \emptyset) \rightarrow \mathring{\mathcal{A}}^\wedge(\uparrow, \emptyset)$ from Definition 3.43 is an algebra anti-homomorphism, i.e., $z(x \circ y) = z(y) \circ z(x)$ for any $x, y \in \mathring{\mathcal{A}}^\wedge(\downarrow, \emptyset)$.*

Proof. Let $x, y \in \mathring{\mathcal{A}}^\wedge(\downarrow, \emptyset)$. In Figure 3.13 we give a schematic proof of the equality $z(x \circ y) = z(y) \circ z(x)$. \square

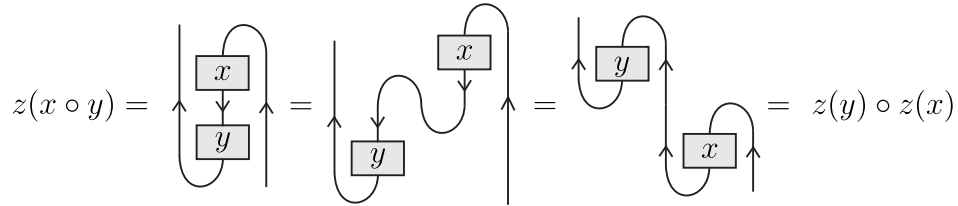

FIGURE 3.13. The map $z : \mathring{\mathcal{A}}^\wedge(\downarrow, \emptyset) \rightarrow \mathring{\mathcal{A}}^\wedge(\uparrow, \emptyset)$ is an algebra anti-homomorphism.

Lemma 3.45. *For any $x \in \mathring{\mathcal{A}}^\wedge(\downarrow, \emptyset)$, we have*

$$\begin{array}{c} \boxed{z(x)} \\ \downarrow \end{array} = \begin{array}{c} \uparrow \\ \boxed{x} \end{array}, \quad \begin{array}{c} \downarrow \\ \boxed{z(x)} \end{array} = \begin{array}{c} \boxed{x} \\ \uparrow \end{array}, \quad \begin{array}{c} \boxed{z(x)} \\ \downarrow \end{array} = \begin{array}{c} \uparrow \\ \boxed{x} \end{array} \quad \text{and} \quad \begin{array}{c} \downarrow \\ \boxed{z(x)} \end{array} = \begin{array}{c} \boxed{x} \\ \uparrow \end{array}.$$

where $z : \mathring{\mathcal{A}}^\wedge(\downarrow, \emptyset) \rightarrow \mathring{\mathcal{A}}^\wedge(\uparrow, \emptyset)$ is map from Definition 3.43.

Proof. We prove the first equality, the other ones follow similarly. We have

$$\begin{array}{c} \boxed{z(x)} \\ \downarrow \end{array} = \begin{array}{c} \uparrow \\ \boxed{x} \\ \downarrow \end{array} = \begin{array}{c} \uparrow \\ \boxed{x} \\ \downarrow \end{array} = \begin{array}{c} \uparrow \\ \boxed{x} \end{array}.$$

\square

Lemma 3.46. Let $w_1, w_2 \in \{+, -\}^*$, $w = w_1 \otimes + \otimes w_2$, $w' = w_1 \otimes - \otimes w_2$. Recall the notation $\text{Id}_w \in \vec{\mathcal{B}}r(w, w)$ and $\text{Id}_{w'} \in \vec{\mathcal{B}}r(w', w')$. Let $D \in \mathring{\mathcal{A}}^\wedge(\text{Id}_w, \emptyset)$, $E \in \mathring{\mathcal{A}}^\wedge(\text{Id}_{w'}, \emptyset)$, $y \in \mathring{\mathcal{A}}^\wedge(\downarrow, \emptyset)$ and $x' \in \mathring{\mathcal{A}}^\wedge(\uparrow, \emptyset)$. Then

$$D \circ (\text{Id}_{w_1} \otimes x \otimes \text{Id}_{w_2}) = (\text{Id}_{w_1} \otimes x \otimes \text{Id}_{w_2}) \circ D \quad \text{and} \quad E \circ (\text{Id}_{w_1} \otimes y \otimes \text{Id}_{w_2}) = (\text{Id}_{w_1} \otimes y \otimes \text{Id}_{w_2}) \circ E.$$

Schematically

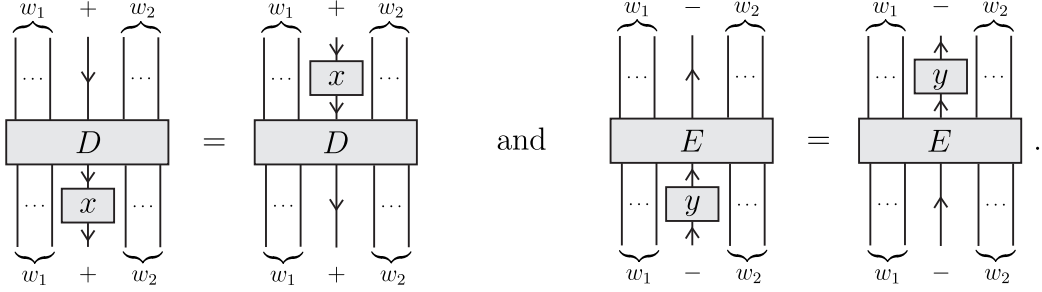

Proof. This is a well-known result, see for instance [24, Lemma 16.13] for the case $w_1 = \emptyset$. \square

Lemma 3.47. Let $w_1, w_2 \in \{+, -\}^*$ with $|w_1| = i - 1 \geq 1$, $w = w_1 \otimes + \otimes w_2$, $w' = w_1 \otimes - \otimes w_2$. Let $D \in \mathring{\mathcal{A}}^\wedge(\text{Id}_w, \emptyset)$, $E \in \mathring{\mathcal{A}}^\wedge(\text{Id}_{w'}, \emptyset)$, $y \in \mathring{\mathcal{A}}^\wedge(\downarrow^n, \emptyset)$ and $x' \in \mathring{\mathcal{A}}^\wedge(\uparrow^n, \emptyset)$ where $n \geq 1$. Then

$$\text{dbl}_i^{(n-1)}(D) \circ (\text{Id}_{w_1} \otimes x \otimes \text{Id}_{w_2}) = (\text{Id}_{w_1} \otimes x \otimes \text{Id}_{w_2}) \circ \text{dbl}_i^{(n-1)}(D)$$

and

$$\text{dbl}_i^{(n-1)}(E) \circ (\text{Id}_{w_1} \otimes y \otimes \text{Id}_{w_2}) = (\text{Id}_{w_1} \otimes y \otimes \text{Id}_{w_2}) \circ \text{dbl}_i^{(n-1)}(E).$$

Schematically

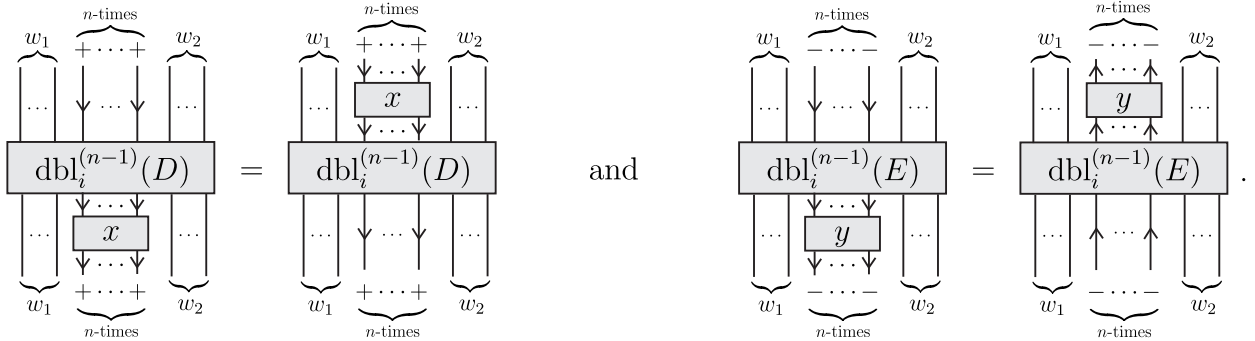

Proof. This is a well-known result, see for instance [24, Lemma 16.14] for the case $w_1 = \emptyset$. \square

3.10.2. *The functor $\mathring{\mathcal{A}}(P, \bullet, \diamond)$ of Jacobi diagrams with free vertices.* We introduce a slight generalization of Definition 3.7.

Definition 3.48. Let P be an oriented Brauer diagram and let S and Σ be finite sets. Let $\mathring{\text{Jac}}(P, S, \Sigma)$ be the set consisting of classes of tuples $\underline{D} = (D, \varphi, \{\text{lin}_l\}_{l \in \pi_0(P)}, \{\text{cyc}_s\}_{s \in S})$ where

- D is a vertex-oriented univalent graph,
- $\varphi : \partial D \rightarrow \pi_0(P) \sqcup S \sqcup \Sigma$ is a map such that its image contains Σ and the preimage of any element of Σ has cardinality 1,
- lin_l is a linear order on $\varphi^{-1}(l)$ for each $l \in \pi_0(P)$,
- cyc_s is a cyclic order on $\varphi^{-1}(s)$ for each $s \in S$.

Two such tuples \underline{D} and $\underline{\tilde{D}}$ being considered equivalent if there exists a graph isomorphism $\psi : D \rightarrow \tilde{D}$ compatible with all the structures (see Definition 3.7).

In particular, $\mathring{\text{Jac}}(P, S, \emptyset)$ coincides with the set $\mathring{\text{Jac}}(P, S)$ as in Definition 3.7.

Definition 3.49. Let D and D' be vertex-oriented univalent graphs and (d, d', θ) be a triple where $d \subset \partial D$, $d' \subset \partial D'$ and $\theta : d \rightarrow d'$ is a bijection. Define the *glueing of D and D' along (d, d', θ)* , denoted by $D \sqcup_{(d, d', \theta)} D'$, as the vertex-oriented univalent graph obtained from D and D' by glueing together the univalent vertices with endpoints in d and d' along θ . Notice that $\partial(D \sqcup_{(d, d', \theta)} D') = (\partial D \setminus d) \sqcup (\partial D' \setminus d')$.

Definition 3.50. Let P and P' be oriented Brauer diagrams and S, S', Σ finite sets. Define the map

$$(3.17) \quad \langle \cdot, \cdot \rangle : \mathring{\text{Jac}}(P, S, \Sigma) \times \mathring{\text{Jac}}(P', S', \Sigma) \longrightarrow \mathring{\text{Jac}}(P \otimes P', S \sqcup S')$$

as follows. Let $(\underline{D}, \underline{D}') \in \mathring{\text{Jac}}(P, S, \Sigma) \times \mathring{\text{Jac}}(P', S', \Sigma)$ where

$$\underline{D} = (D, \varphi : \partial D \rightarrow \pi_0(P) \sqcup S \sqcup \Sigma, \{\text{lin}_l\}_{l \in \pi_0(P)}, \{\text{cyc}_s\}_{s \in S})$$

and

$$\underline{D}' = (D', \varphi' : \partial D' \rightarrow \pi_0(P') \sqcup S' \sqcup \Sigma, \{\text{lin}_{l'}\}_{l' \in \pi_0(P')}, \{\text{cyc}_{s'}\}_{s' \in S'}).$$

Define $\langle \underline{D}, \underline{D}' \rangle \in \mathring{\text{Jac}}(P \otimes P', S \sqcup S')$ by

$$\langle \underline{D}, \underline{D}' \rangle := (D \sqcup_{(d, d', \theta)} D', \varphi|_{\partial D \setminus \varphi^{-1}(\Sigma)} \sqcup \varphi'|_{\partial D' \setminus \varphi'^{-1}(\Sigma)}, \{\text{lin}_l\}_{l \in \pi_0(P)} \sqcup \{\text{lin}_{l'}\}_{l' \in \pi_0(P')}, \{\text{cyc}_s\}_{s \in S} \sqcup \{\text{cyc}_{s'}\}_{s' \in S'})$$

where $d = \varphi^{-1}(\Sigma)$, $d' = (\varphi')^{-1}(\Sigma)$ and $\theta : \varphi^{-1}(\Sigma) \rightarrow (\varphi')^{-1}(\Sigma)$ is the composition of the bijections $\varphi^{-1}(\Sigma) \rightarrow \Sigma$ and $(\varphi')^{-1}(\Sigma) \rightarrow \Sigma$.

For any oriented Brauer diagrams P, P' , and finite sets S, S', Σ, Σ' define the tensor product map

$$(3.18) \quad \mathring{\text{Jac}}(P, S, \Sigma) \times \mathring{\text{Jac}}(P', S', \Sigma') \longrightarrow \mathring{\text{Jac}}(P \otimes P', S \sqcup S', \Sigma \sqcup \Sigma')$$

taking the pair $(\underline{D}, \underline{D}') \in \mathring{\text{Jac}}(P, S, \Sigma) \times \mathring{\text{Jac}}(P', S', \Sigma')$ where $\underline{D} = (D, \varphi, \{\text{lin}_l\}_{l \in \pi_0(P)}, \{\text{cyc}_s\}_{s \in S})$ and $\underline{D}' = (D', \varphi', \{\text{lin}_{l'}\}_{l' \in \pi_0(P')}, \{\text{cyc}_{s'}\}_{s' \in S'})$ to the Jacobi diagram $\underline{D} \otimes \underline{D}' \in \mathring{\text{Jac}}(P \otimes P', S \sqcup S', \Sigma \sqcup \Sigma')$ given by

$$\underline{D} \otimes \underline{D}' = (D \sqcup D', \varphi \sqcup \varphi', \{\text{lin}_l\}_{l \in \pi_0(P)} \sqcup \{\text{lin}_{l'}\}_{l' \in \pi_0(P')}, \{\text{cyc}_s\}_{s \in S} \sqcup \{\text{cyc}_{s'}\}_{s' \in S'}).$$

The above definition coincides with the definition tensor product map (3.2) when $\Sigma = \Sigma' = \emptyset$.

Definition 3.51. Let P be an oriented Brauer diagram and let S and Σ be finite sets. The *space of Jacobi diagrams on (P, S, Σ)* is the \mathbb{C} -vector space generated by the set $\mathring{\text{Jac}}(P, S, \Sigma)$ of Jacobi diagrams on (P, S, Σ) up to the STU, AS, and IHX relations:

$$\mathring{\mathcal{A}}(P, S, \Sigma) := \frac{\mathbb{C}\mathring{\text{Jac}}(P, S, \Sigma)}{(\text{STU}, \text{AS}, \text{IHX})}$$

where the relations STU, AS, and IHX are as in Definition 3.10.

For P an oriented Brauer diagram and S, Σ finite sets, the formula (3.1) defines a degree deg on $\mathring{\mathcal{A}}(P, S, \Sigma)$. We denote by $\mathring{\mathcal{A}}^\wedge(P, S, \Sigma)$ its completion with respect to this degree. The class of $\underline{D} \in \mathring{\text{Jac}}(P, S, \Sigma)$ in $\mathring{\mathcal{A}}(P, S, \Sigma) \subset \mathring{\mathcal{A}}^\wedge(P, S, \Sigma)$ is denoted by $[\underline{D}]$.

Assume that $P = \vec{\emptyset}$ and $S = \emptyset$. Define a map $\text{deg}_{\text{cyc}} : \text{Jac}(\vec{\emptyset}, \emptyset, \Sigma) \rightarrow \mathbb{Z}_{\geq 0}$ by

$$(3.19) \quad \text{deg}_{\text{cyc}}(\underline{D}) := \frac{1}{2}((\text{number of trivalent vertices of } D) - |\partial D|) + |\pi_0(D)|.$$

Then $(|\pi_0|, \text{deg}_{\text{cyc}}, \text{deg})$ defines a tridegree on $\mathbb{C}\mathring{\text{Jac}}(\vec{\emptyset}, \emptyset, \Sigma)$. The relations AS and IHX relate diagrams with identical triples $(\#\text{univalent vertices}, \#\text{trivalent vertices}, |\pi_0|)$, hence $(|\pi_0|, \text{deg}_{\text{cyc}}, \text{deg})$ defines a tridegree on $\mathring{\mathcal{A}}(\vec{\emptyset}, \emptyset, \Sigma)$. Then the completion $\mathring{\mathcal{A}}^\wedge(\vec{\emptyset}, \emptyset, \Sigma)$ of $\mathring{\mathcal{A}}(\vec{\emptyset}, \emptyset, \Sigma)$ with respect to deg is equipped with the bidegree $(|\pi_0|, \text{deg}_{\text{cyc}})$. For $c, d \in \mathbb{Z}_{\geq 0}$, denote by $\mathring{\mathcal{A}}^\wedge(\vec{\emptyset}, \emptyset, \Sigma)[c, d]$ the part of $\mathring{\mathcal{A}}^\wedge(\vec{\emptyset}, \emptyset, \Sigma)$ of bidegree (c, d) .

Let P be an oriented Brauer diagram and S, Σ, Σ' be finite sets. One checks that any map $f : \Sigma \rightarrow \Sigma'$ induces maps $f_* : \mathring{\text{Jac}}(P, S, \Sigma) \rightarrow \mathring{\text{Jac}}(P, S, \Sigma')$ and $\mathring{\mathcal{A}}(P, S, \Sigma) \rightarrow \mathring{\mathcal{A}}(P, S, \Sigma')$. Moreover, if Σ'' is other finite set and $g : \Sigma' \rightarrow \Sigma''$ is a map, one has $(g \circ f)_* = g_* \circ f_*$.

The pairing (3.17) induces a well-defined continuous bilinear map

$$(3.20) \quad \langle \cdot, \cdot \rangle : \mathring{\mathcal{A}}^\wedge(P, S, \Sigma) \times \mathring{\mathcal{A}}^\wedge(P', S', \Sigma) \longrightarrow \mathring{\mathcal{A}}^\wedge(P \otimes P', S \sqcup S').$$

Remark 3.52. The map (3.20) is a particular case of the map introduced in [6, Definition 2.9].

The tensor map (3.18) induces a well-defined continuous bilinear map

$$(3.21) \quad \circ_{\mathcal{A}} : \mathring{A}^{\wedge}(P, S, \Sigma) \times \mathring{A}^{\wedge}(P', S', \Sigma') \longrightarrow \mathring{A}^{\wedge}(P \otimes P', S \sqcup S', \Sigma \sqcup \Sigma').$$

Similarly, for any composable pair (P, P') of oriented Brauer diagrams, one defines a composition map

$$(3.22) \quad \circ_{\mathcal{A}} : \mathring{A}^{\wedge}(P, S, \Sigma) \times \mathring{A}^{\wedge}(P', S', \Sigma') \longrightarrow \mathring{A}^{\wedge}(P' \circ P, S \sqcup S' \sqcup \text{Cir}(P', P), \Sigma \sqcup \Sigma').$$

The above map coincides with the map (3.5) when $\Sigma = \Sigma' = \emptyset$.

4. CONSTRUCTION OF TWO FAMILIES OF INVARIANTS $\{\Omega_n^c\}_{n \geq 1}$ AND $\{\Omega_n^d\}_{n \geq 1}$ OF 3-MANIFOLDS

In §3.9, we constructed a semi-Kirby structure $(\mathfrak{s}(\mathbf{A}), \mu)$ where the algebra $\mathfrak{s}(\mathbf{A})$ is a quotient of $\bigoplus_{k \geq 0} \mathring{A}_k^{\wedge}$, where $\mathring{A}_k^{\wedge} = \mathring{A}^{\wedge}(\vec{\emptyset}, \llbracket 1, k \rrbracket)_{\mathfrak{S}_k}$. In §4.1, we review the definition of an algebra automorphism cs^{ν} of $\bigoplus_{k \geq 0} \mathring{A}_k^{\wedge}$. In §4.2, we construct an algebra \mathfrak{a} and an algebra isomorphism $\overline{cs}^{\nu} : \mathfrak{s}(\mathbf{A}) \rightarrow \mathfrak{a}$. Fix an integer $n > 0$. In §4.3, we construct an algebra $\mathfrak{b}(n)$ and an algebra morphism $\varphi_n : \mathfrak{a} \rightarrow \mathfrak{b}(n)$. In §4.4 we define a *space of diagrammatic traces* and the *LMO diagrammatic trace*. In §4.5 we construct an algebra $\mathfrak{c}(n)$ and use the LMO diagrammatic trace to define an algebra morphism $\bar{j}_n : \mathfrak{b}(n) \rightarrow \mathfrak{c}(n)$. In §4.6, we define algebras $\mathfrak{d}(n)$ and algebra morphisms $\text{pr}_n : \mathfrak{c}(n) \rightarrow \mathfrak{d}(n)$ which give rise to the push-forward semi-Kirby structures $(\mathfrak{b}(n), \varphi_n \circ \overline{cs}^{\nu} \circ Z_{\mathcal{A}})$, $(\mathfrak{c}(n), \bar{j}_n \circ \varphi_n \circ \overline{cs}^{\nu} \circ Z_{\mathcal{A}})$ and $(\mathfrak{d}(n), \text{pr}_n \circ \bar{j}_n \circ \varphi_n \circ \overline{cs}^{\nu} \circ Z_{\mathcal{A}})$. We then prove that the semi-Kirby structures $(\mathfrak{c}(n), \bar{j}_n \circ \varphi_n \circ \overline{cs}^{\nu} \circ Z_{\mathcal{A}})$ and $(\mathfrak{d}(n), \text{pr}_n \circ \bar{j}_n \circ \varphi_n \circ \overline{cs}^{\nu} \circ Z_{\mathcal{A}})$ are Kirby structures for any $n \geq 1$ (Theorem 4.67 and Proposition 4.69); moreover in §4.7, we show the equality $\mathfrak{c}(1) = \mathfrak{d}(1)$ ⁴.

The relations between the involved algebras can be described by the following overall diagram of algebra morphisms, where $(\text{KII}^s \mathring{A}^{\wedge})$, P^{n+1} and $L^{<2n}$ are suitable ideals of $\bigoplus_{k \geq 0} \mathring{A}_k^{\wedge}$, and P_0^{n+1} , O^n and $(\text{deg} > n)$ ideals of \mathring{A}_0^{\wedge} ; and cs^{ν} and j_n are suitable algebra morphisms.

$$\begin{array}{cccccccccccc}
\mathbb{Z}\vec{T}(\emptyset, \emptyset) & \xrightarrow{Z_{\mathcal{A}}} & \bigoplus_{k \geq 0} \mathring{A}_k^{\wedge} & \xrightarrow{cs^{\nu}} & \bigoplus_{k \geq 0} \mathring{A}_k^{\wedge} & \xrightarrow{\text{Id}} & \bigoplus_{k \geq 0} \mathring{A}_k^{\wedge} & \xrightarrow{j_n} & \mathring{A}_0^{\wedge} & \xrightarrow{\text{Id}} & \mathring{A}_0^{\wedge} \\
\downarrow & & \downarrow & & \downarrow & & \downarrow & & \downarrow & & \downarrow \\
\frac{\mathbb{Z}\vec{T}(\emptyset, \emptyset)}{(\text{KII}\vec{T}\cup\text{CO}\vec{T})} & \xrightarrow{Z_{\mathcal{A}}} & \bigoplus_{k \geq 0} \mathring{A}_k^{\wedge} & \xrightarrow{\overline{cs}^{\nu}} & \bigoplus_{k \geq 0} \mathring{A}_k^{\wedge} & \xrightarrow{\varphi_n} & \bigoplus_{k \geq 0} \mathring{A}_k^{\wedge} & \xrightarrow{\bar{j}_n} & \mathring{A}_0^{\wedge} & \xrightarrow{\text{pr}_n} & \mathring{A}_0^{\wedge} \\
\parallel & & \parallel & & \parallel & & \parallel & & \parallel & & \parallel \\
\mathfrak{Kir} & \xrightarrow{Z_{\mathcal{A}}} & \mathfrak{s}(\mathbf{A}) & \xrightarrow{\overline{cs}^{\nu}} & \mathfrak{a} & \xrightarrow{\varphi_n} & \mathfrak{b}(n) & \xrightarrow{\bar{j}_n} & \mathfrak{c}(n) & \xrightarrow{\text{pr}_n} & \mathfrak{d}(n).
\end{array}$$

In §4.8 we derive from the Kirby structures $(\mathfrak{c}(n), \bar{j}_n \circ \varphi_n \circ \overline{cs}^{\nu} \circ Z_{\mathcal{A}})$ and $(\mathfrak{d}(n), \text{pr}_n \circ \bar{j}_n \circ \varphi_n \circ \overline{cs}^{\nu} \circ Z_{\mathcal{A}})$ the 3-manifold invariants Ω_n^c and Ω_n^d with values in $\mathfrak{c}(n)$ and $\mathfrak{d}(n)$ and related by $\Omega_n^d(Y) = \text{pr}_n(\Omega_n^c(Y))$ for any 3-manifold Y (Theorem 4.73). In §4.9 we deduce the equality $\Omega_1^c = \Omega_1^d$. The construction of Ω_n^d was first obtained in [31]. In §4.10, we show the universality of the morphism $\bar{j}_n : \mathfrak{b}(n) \rightarrow \mathfrak{c}(n)$ in the class of surjective graded algebra morphisms $\mathfrak{b}(n) \rightarrow A$ giving rise to Kirby structures.

4.1. The automorphism cs^{ν} of the algebra $\bigoplus_{k \geq 0} \mathring{A}_k^{\wedge}$. Recall that $\bigoplus_{k \geq 0} \mathring{A}_k^{\wedge}$ is a commutative algebra equipped with the product induced by the tensor product (Lemma 2.108). One checks that this product coincides with the one induced by composition. In this subsection, we associate to each $\alpha \in \mathring{A}^{\wedge}(\downarrow, \emptyset)$ an endomorphism cs^{α} of this algebra, which is an automorphism if α is invertible.

⁴In [32] it is shown, in our terminology, that $(\mathfrak{b}(1), \varphi_1 \circ \overline{cs}^{\nu} \circ Z_{\mathcal{A}})$ is a Kirby structure; it seems to follow from [31] that there is an isomorphism of Kirby structures $\mathfrak{b}(1) \simeq \mathfrak{c}(1)$, where $\mathfrak{c}(1)$ is as in Definition 5.35, which given Lemma 5.37, implies the isomorphism $\mathfrak{b}(1) \simeq \mathfrak{d}(1)$.

Let us start by recalling some notations. Let $k \in \mathbb{Z}_{\geq 0}$. Let $P \in \vec{\mathcal{B}}r$ be an oriented Brauer diagram, from Definition 2.97, $\mathcal{X}(P)_k$ denotes the coinvariant space $\mathcal{X}(P, \llbracket 1, k \rrbracket)_{\mathfrak{S}_k}$. From Notation 2.41, $\downarrow^k := \downarrow \cdots \downarrow = \text{Id}_{+\otimes k} \in \vec{\mathcal{B}}r(+^{\otimes k}, +^{\otimes k})$ and $\uparrow^k := \uparrow \cdots \uparrow = \text{Id}_{-\otimes k} \in \vec{\mathcal{B}}r(-^{\otimes k}, -^{\otimes k})$.

Define the oriented Brauer diagrams $\text{cup}^k \in \vec{\mathcal{B}}r(\emptyset, -^{\otimes k} \otimes +^{\otimes k})$ and $\text{cap}^k \in \vec{\mathcal{B}}r(-^{\otimes k} \otimes +^{\otimes k}, \emptyset)$ by

$$\text{cup}^k := ((0, 2k, \sigma_{\text{cup}^k}), B := \llbracket k+1, 2k \rrbracket) \quad \text{and} \quad \text{cap}^k := ((2k, 0, \sigma_{\text{cap}^k}), B' := \llbracket 1, k \rrbracket)$$

where σ_{cup^k} and σ_{cap^k} are the FPFIs of $\llbracket 1, 2k \rrbracket$ defined by $\sigma_{\text{cup}^k}(i) = \sigma_{\text{cap}^k}(i) = 2k - i + 1$ for every $i \in \llbracket 1, k \rrbracket$. One easily checks that $|\text{Cir}(\text{cup}^k, \text{cap}^k)| = k$.

Denote by $\text{cup}_{\mathcal{A}}^k$ (resp. $\text{cap}_{\mathcal{A}}^k$) the element in $\mathring{\mathcal{A}}^\wedge(\text{cup}^k, \emptyset)$ (resp. $\mathring{\mathcal{A}}^\wedge(\text{cap}^k, \emptyset)$) corresponding to cup^k (resp. cap^k), see Definition 3.11. Let $\text{Id}_{(-)\otimes k}^{\mathcal{A}} \in \mathring{\mathcal{A}}^\wedge(\uparrow^k, \emptyset)$ as in Lemma 3.28(b).

Definition 4.1. Define the linear continuous map

$$\text{clos}_k : \mathring{\mathcal{A}}^\wedge(\downarrow^k \otimes P, \emptyset) \longrightarrow \mathring{\mathcal{A}}^\wedge(P, \text{Cir}(\text{cup}^k, \text{cap}^k))$$

by $\text{clos}_k(x) := \text{cap}_{\mathcal{A}}^k \circ (\text{Id}_{(-)\otimes k}^{\mathcal{A}} \otimes x) \circ \text{cup}_{\mathcal{A}}^k$ for any $x \in \mathring{\mathcal{A}}^\wedge(\downarrow^k \otimes P, \emptyset)$.

Lemma 4.2. Let $k \in \mathbb{Z}_{\geq 0}$ and let $P \in \vec{\mathcal{B}}r$ be an oriented Brauer diagram.

(a) For any $\alpha \in \mathring{\mathcal{A}}^\wedge(\downarrow, \emptyset)$ there exists a unique linear continuous endomorphism

$$\tilde{\text{cs}}_{P,k}^\alpha : \mathring{\mathcal{A}}^\wedge(P, \text{Cir}(\text{cup}^k, \text{cap}^k)) \longrightarrow \mathring{\mathcal{A}}^\wedge(P, \text{Cir}(\text{cup}^k, \text{cap}^k))$$

such that the diagram

$$\begin{array}{ccc} \mathring{\mathcal{A}}^\wedge(\downarrow^k \otimes P, \emptyset) & \xrightarrow{\text{clos}_k} & \mathring{\mathcal{A}}^\wedge(P, \text{Cir}(\text{cup}^k, \text{cap}^k)) \\ (\alpha^{\otimes k} \circ \bullet) \otimes \text{Id}_{\text{t}(P)} \downarrow & & \downarrow \tilde{\text{cs}}_{P,k}^\alpha \\ \mathring{\mathcal{A}}^\wedge(\downarrow^k \otimes P, \emptyset) & \xrightarrow{\text{clos}_k} & \mathring{\mathcal{A}}^\wedge(P, \text{Cir}(\text{cup}^k, \text{cap}^k)) \end{array}$$

is commutative (where $\text{t}(P)$ denotes the target of P in the category $\vec{\mathcal{B}}r$).

(b) Let $\alpha \in \mathring{\mathcal{A}}^\wedge(\downarrow, \emptyset)$. For S a finite set, the endomorphism of $\mathring{\mathcal{A}}^\wedge(P, S)$ defined by $\mathring{\mathcal{A}}^\wedge(P, \phi) \circ \tilde{\text{cs}}_{P,|S|}^\alpha \circ \mathring{\mathcal{A}}^\wedge(P, \phi)^{-1}$, is independent of the choice of a bijection $\phi : \text{Cir}(\text{cup}^{|S|}, \text{cap}^{|S|}) \rightarrow S$, where $\mathring{\mathcal{A}}^\wedge(P, \bullet)$ is the functor from Section 3.2. This endomorphism will be denoted by $\tilde{\text{cs}}_{P,S}^\alpha$. When $S = \llbracket 1, k \rrbracket$, it induces a linear endomorphism

$$(4.1) \quad \text{cs}_{P,k}^\alpha : \mathring{\mathcal{A}}^\wedge(P)_k \longrightarrow \mathring{\mathcal{A}}^\wedge(P)_k$$

called α -connected sum map.

(c) Let cs^α be the endomorphism of $\bigoplus_{k \geq 0} \mathring{\mathcal{A}}_k^\wedge$ given by $\bigoplus_{k \geq 0} \text{cs}_{P,k}^\alpha$ then cs^α is an algebra endomorphism.

(d) If $\alpha, \beta \in \mathring{\mathcal{A}}^\wedge(\downarrow, \emptyset)$ then $\text{cs}^{\beta \circ \alpha} = \text{cs}^\beta \circ \text{cs}^\alpha$.

(e) Moreover, if $\alpha \in \mathring{\mathcal{A}}^\wedge(\downarrow, \emptyset)$ is invertible, then cs^α is an algebra automorphism.

Proof. (a) is a formulation of well-known results, see for instance [24, Thm. 16.20]. These results imply that for fixed $P \in \vec{\mathcal{B}}r$ and $\alpha \in \mathring{\mathcal{A}}^\wedge(\downarrow, \emptyset)$, the map $\tilde{\text{cs}}_{P,k}^\alpha$ is equivariant under the action of $\mathfrak{S}_{\text{Cir}(\text{cup}^k, \text{cap}^k)}$, which implies the independence stated in (b). The association $S \mapsto \tilde{\text{cs}}_{P,S}^\alpha$ for any finite set S , is then a natural equivalence of the functor $S \mapsto \mathring{\mathcal{A}}^\wedge(P, S)$ with itself, which implies that for $S = \llbracket 1, k \rrbracket$ the map $\tilde{\text{cs}}_{P, \llbracket 1, k \rrbracket}^\alpha$ is \mathfrak{S}_k -equivariant. The endomorphism $\tilde{\text{cs}}_{P,k}^\alpha$ is then defined by applying the functor of coinvariants, this finishes the proof of (b). Statement (c) is a consequence of the following more general claim: let P and P' be oriented Brauer diagrams, if $x \in \mathring{\mathcal{A}}^\wedge(P)_k$ and $x' \in \mathring{\mathcal{A}}^\wedge(P')_{k'}$ then $\text{cs}_{P \otimes P', k+k'}^\alpha(x \otimes x') = \text{cs}_{P,k}^\alpha(x) \otimes \text{cs}_{P',k'}^\alpha(x')$ which can be shown from the definitions of the maps and the tensor product. (d) follows from the fact that the map taking α to the endomorphism of $\mathring{\mathcal{A}}^\wedge(\downarrow^k \otimes P, \emptyset)$ in the commutative diagram in (a) is an algebra morphism. (e) follows from (d). \square

Remark 4.3. One can prove that the ring $(\mathring{\mathcal{A}}^\wedge(\downarrow, \emptyset), \circ)$ is commutative, see for instance [41, Proposition 6.1].

Intuitively, the operation $cs_{P,k}^\alpha$ corresponds to inserting the element α (or $z(\alpha)$) to each circle component of the schematic representation of \underline{D} , see Figure 4.1 for a schematic representation.

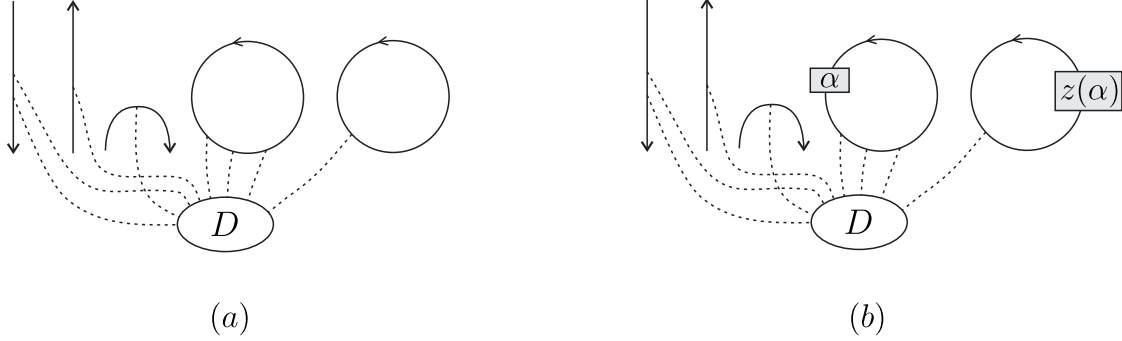

FIGURE 4.1. (a) schematic representation of a Jacobi diagram \underline{D} on $(P, [1, 2])$ and (b) its image under the map $cs_{P,2}^\alpha$.

We specialize the map in Lemma 4.2(c) to the invertible element ν defined in subsection 3.9, to obtain an algebra automorphism:

$$(4.2) \quad cs^\nu : \bigoplus_{k \geq 0} \mathring{\mathcal{A}}_k^\wedge \longrightarrow \bigoplus_{k \geq 0} \mathring{\mathcal{A}}_k^\wedge.$$

Remark 4.4. In [31], a normalization \check{Z} of the Kontsevich integral $Z_{\mathcal{A}}$ restricted to links is defined as the composed map $cs^\nu \circ Z_{\mathcal{A}}$.

4.2. The algebras $\mathfrak{s}(\mathbf{A})$, \mathfrak{a} and the algebra isomorphism $\overline{cs}^\nu : \mathfrak{s}(\mathbf{A}) \rightarrow \mathfrak{a}$. Let \mathbf{A} be the pre-LMO structure from Theorem 3.41. By Proposition 2.110, this pre-LMO structure gives rise to a semi-Kirby structure $(\mathfrak{s}(\mathbf{A}), \mu)$. In §4.2.1 we recall the definition of the algebra $\mathfrak{s}(\mathbf{A})$ as the quotient of $\bigoplus_{k \geq 0} \mathring{\mathcal{A}}_k^\wedge$ by the sum of the ideals $(\text{KII}\mathring{\mathcal{A}}^\wedge)$ and $(\text{CO}\mathring{\mathcal{A}}^\wedge)$. In §4.2.2 we define the ideal $(\text{KII}^s\mathring{\mathcal{A}}^\wedge)$ of $\bigoplus_{k \geq 0} \mathring{\mathcal{A}}_k^\wedge$ and the algebra \mathfrak{a} as the quotient of $\bigoplus_{k \geq 0} \mathring{\mathcal{A}}_k^\wedge$ by the sum of the ideals $(\text{KII}^s\mathring{\mathcal{A}}^\wedge)$ and $(\text{CO}\mathring{\mathcal{A}}^\wedge)$. In §4.2.4 and §4.2.5 we show that $cs^\nu((\text{KII}\mathring{\mathcal{A}}^\wedge)) = (\text{KII}^s\mathring{\mathcal{A}}^\wedge)$ and $cs^\nu((\text{CO}\mathring{\mathcal{A}}^\wedge)) = (\text{CO}\mathring{\mathcal{A}}^\wedge)$, respectively. This enables us to construct the isomorphism of algebras $\overline{cs}^\nu : \mathfrak{s}(\mathbf{A}) \rightarrow \mathfrak{a}$ in §4.2.5.

4.2.1. The algebra $\mathfrak{s}(\mathbf{A})$. By specializing Definition 2.107 to the pre-LMO structure \mathbf{A} , we have $(\text{KII}\mathring{\mathcal{A}}^\wedge) = \bigoplus_{k \geq 2} (\text{KII}\mathring{\mathcal{A}}_k^\wedge)$ where $(\text{KII}\mathring{\mathcal{A}}_k^\wedge) \subset \mathring{\mathcal{A}}_k^\wedge$ is given by

$$(4.3) \quad (\text{KII}\mathring{\mathcal{A}}_k^\wedge) = \text{Im} \left(\text{KIIMap}_{\mathring{\mathcal{A}}^\wedge, k, +-}^2 - \text{KIIMap}_{\mathring{\mathcal{A}}^\wedge, k, +-}^1 \right) + \text{Im} \left(\text{KIIMap}_{\mathring{\mathcal{A}}^\wedge, k, +-}^2 - \text{KIIMap}_{\mathring{\mathcal{A}}^\wedge, k, +-}^1 \right)$$

where the maps $\text{KIIMap}_{\mathring{\mathcal{A}}^\wedge, k, +-}^1$ and $\text{KIIMap}_{\mathring{\mathcal{A}}^\wedge, k, +-}^2$ (as well as their $-+$ versions) are the specializations of (2.41) and (2.42) to \mathbf{A} . In Figure 4.2 we give a schematic representation of these maps using Conventions 3.38 and 3.25.

Similarly, we have $(\text{CO}\mathring{\mathcal{A}}^\wedge) = \bigoplus_{k \geq 1} (\text{CO}\mathring{\mathcal{A}}_k^\wedge) \subset \bigoplus_{k \geq 0} \mathring{\mathcal{A}}_k^\wedge$ where $(\text{CO}\mathring{\mathcal{A}}_k^\wedge) \subset \mathring{\mathcal{A}}_k^\wedge$ is given by

$$(\text{CO}\mathring{\mathcal{A}}_k^\wedge) = \text{Im}(\text{co}_k^{\mathring{\mathcal{A}}} - \text{proj}_{1, k-1}^{\mathring{\mathcal{A}}}) \subset \mathring{\mathcal{A}}_k^\wedge,$$

see Definition 2.106. By Proposition 2.110, $(\text{KII}\mathring{\mathcal{A}}^\wedge)$ and $(\text{CO}\mathring{\mathcal{A}}^\wedge)$ are both ideals of the commutative algebra $\bigoplus_{k \geq 0} \mathring{\mathcal{A}}_k^\wedge$ and its associated semi-Kirby structure $\mathfrak{s}(\mathbf{A})$ is given by

$$(4.4) \quad \mathfrak{s}(\mathbf{A}) = \frac{\bigoplus_{k \geq 0} \mathring{\mathcal{A}}_k^\wedge}{(\text{KII}\mathring{\mathcal{A}}^\wedge) + (\text{CO}\mathring{\mathcal{A}}^\wedge)},$$

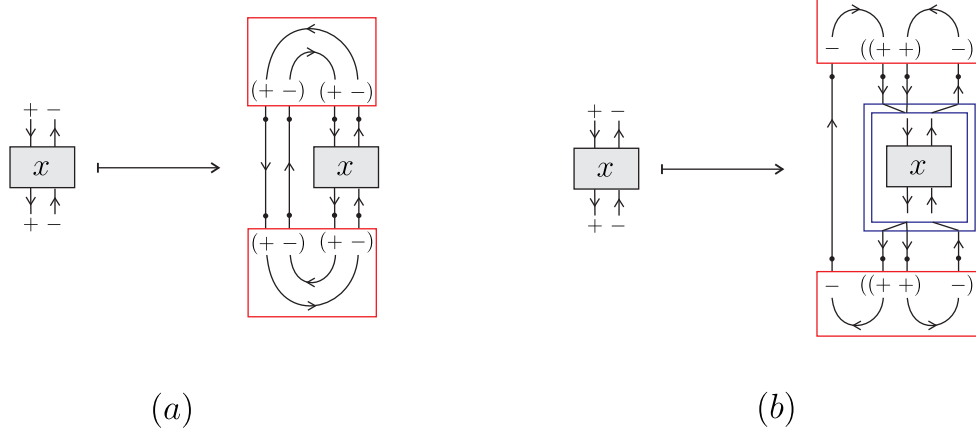

FIGURE 4.2. (a) The map $\text{KIIMap}^1_{\mathring{A}^\wedge, k, +-}$, (b) the map $\text{KIIMap}^2_{\mathring{A}^\wedge, k, +-}$. We represent $x \in \mathring{A}^\wedge(\downarrow\uparrow)_{k-2}$ by the grey-colored box. Notice that there are $k - 2$ circles in the schematic representation of x which are not shown in the figure.

together with the algebra morphism $\mu : \mathfrak{Kir} \rightarrow \mathfrak{s}(\mathbf{A})$ induced by the Kontsevich integral.

4.2.2. *The algebra \mathfrak{a} .* We introduce a variant of the KII maps $\text{KIIMap}^1_{\mathring{A}^\wedge, k, +-}$ and $\text{KIIMap}^2_{\mathring{A}^\wedge, k, +-}$ (as well as their $-+$ versions) which are simpler. Recall that $\downarrow\uparrow \in \vec{\mathcal{B}r}$ denotes the identity morphism in $\vec{\mathcal{B}r}(+-, +-)$.

Define cup_{+---} , cup_{-++} , cap_{+---} and cap_{-++} to be the underlying oriented Brauer diagrams of the tangles cup_{+---}^T , cup_{-++}^T , cap_{+---}^T and cap_{-++}^T from Definition 2.58. Let $(\text{cup}_{+---})_{\mathcal{A}}$, $(\text{cup}_{-++})_{\mathcal{A}}$, $(\text{cap}_{+---})_{\mathcal{A}}$ and $(\text{cap}_{-++})_{\mathcal{A}}$ be the corresponding elements in the respective spaces $\mathring{A}^\wedge(\text{cup}_{+---}, \emptyset)$, $\mathring{A}^\wedge(\text{cup}_{-++}, \emptyset)$, $\mathring{A}^\wedge(\text{cap}_{+---}, \emptyset)$ and $\mathring{A}^\wedge(\text{cap}_{-++}, \emptyset)$, see Definition 3.11.

Lemma 4.5. *Let $k \geq 2$ be an integer. There are well-defined continuous linear maps*

$$\text{KIIMap}^{\mathring{A}^\wedge, k, +-}_{\mathring{A}^\wedge, k, +-}^{s, 1} : \mathring{A}^\wedge(\downarrow\uparrow)_{k-2} \longrightarrow \mathring{A}_k^\wedge, \quad \text{KIIMap}^{\mathring{A}^\wedge, k, +-}_{\mathring{A}^\wedge, k, +-}^{s, 2} : \mathring{A}^\wedge(\downarrow\uparrow)_{k-2} \longrightarrow \mathring{A}_k^\wedge$$

and

$$\text{KIIMap}^{\mathring{A}^\wedge, k, -+}_{\mathring{A}^\wedge, k, -+}^{s, 1} : \mathring{A}^\wedge(\uparrow\downarrow)_{k-2} \longrightarrow \mathring{A}_k^\wedge, \quad \text{KIIMap}^{\mathring{A}^\wedge, k, -+}_{\mathring{A}^\wedge, k, -+}^{s, 2} : \mathring{A}^\wedge(\uparrow\downarrow)_{k-2} \longrightarrow \mathring{A}_k^\wedge$$

given by

$$(4.5) \quad \text{KIIMap}^{\mathring{A}^\wedge, k, +-}_{\mathring{A}^\wedge, k, +-}^{s, 1}(x) := (\text{cap}_{+---})_{\mathcal{A}} \circ_{\mathcal{A}} ((\text{Id}_{+-})_{\mathcal{A}} \otimes_{\mathcal{A}} x) \circ_{\mathcal{A}} (\text{cup}_{+---})_{\mathcal{A}}$$

and

$$(4.6) \quad \text{KIIMap}^{\mathring{A}^\wedge, k, +-}_{\mathring{A}^\wedge, k, +-}^{s, 2}(x) := (\text{cap}_{-++})_{\mathcal{A}} \circ_{\mathcal{A}} ((\text{Id}_{-})_{\mathcal{A}} \otimes_{\mathcal{A}} \text{dbl}_1(x)) \circ_{\mathcal{A}} (\text{cup}_{-++})_{\mathcal{A}},$$

for any $x \in \mathring{A}^\wedge(\downarrow\uparrow)_{k-2}$. In (4.6), we are using Convention 3.26. See Figure 4.3 for a schematic representation of these maps using Conventions 3.38 and 3.25.

Similarly for $y \in \mathring{A}^\wedge(\uparrow\downarrow)_{k-2}$, the elements $\text{KIIMap}^{\mathring{A}^\wedge, k, -+}_{\mathring{A}^\wedge, k, -+}^{s, 1}(y) \in \mathring{A}_k^\wedge$ and $\text{KIIMap}^{\mathring{A}^\wedge, k, -+}_{\mathring{A}^\wedge, k, -+}^{s, 2}(y) \in \mathring{A}_k^\wedge$ are defined by the formulas obtained from (4.5) and (4.6) by permuting the subscripts $+$ and $-$. The superscript s refers to simple.

Proof. Let us do the proof for the map $\text{KIIMap}^{\mathring{A}^\wedge, k, +-}_{\mathring{A}^\wedge, k, +-}^{s, 1}$, the other cases are similar. We have $(\text{cup}_{+---})_{\mathcal{A}} \in \mathring{A}^\wedge(\text{cup}_{+---})_0$ and $(\text{Id}_{+-})_{\mathcal{A}} \otimes_{\mathcal{A}} x \in \mathring{A}^\wedge(\uparrow\downarrow)_{k-2}$ hence $((\text{Id}_{+-})_{\mathcal{A}} \otimes_{\mathcal{A}} x) \circ_{\mathcal{A}} (\text{cup}_{+---})_{\mathcal{A}} \in \mathring{A}^\wedge(\text{cap}_{+---})_{k-2}$. Moreover, $(\text{cap}_{+---})_{\mathcal{A}} \in \mathring{A}^\wedge(\text{cap}_{+---})_0$ therefore the final triple composition (4.5) belongs to

$$\mathring{A}^\wedge(\vec{\emptyset})_{k-2+|\text{Cir}(\text{cap}_{+---}, \text{cup}_{+---})|} = \mathring{A}_k^\wedge.$$

□

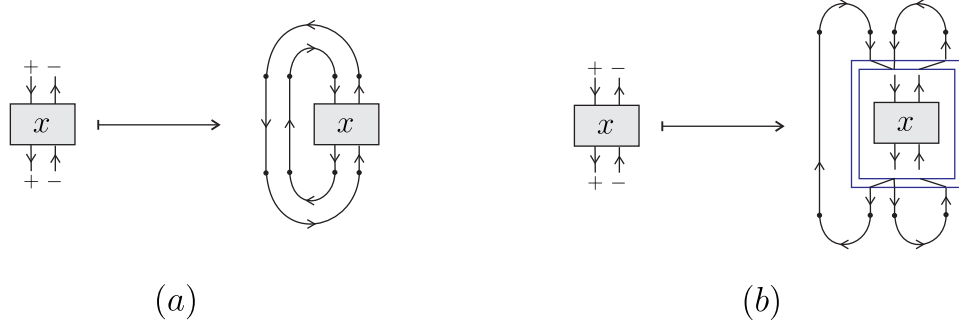

FIGURE 4.3. (a) The map $\text{KIIMap}_{\mathring{\mathcal{A}}^\wedge, k, +-}^{s,1}$, (b) the map $\text{KIIMap}_{\mathring{\mathcal{A}}^\wedge, k, +-}^{s,2}$. We represent $x \in \mathring{\mathcal{A}}^\wedge(\downarrow\uparrow)_{k-2}$ by the grey-colored box and we use Convention 3.25 for representing $\text{dbl}_1(x) \in \mathring{\mathcal{A}}^\wedge(\downarrow\downarrow\uparrow)_{k-2}$.

Definition 4.6. Let $k \geq 2$, define the subgroups $(\text{KII}^s \mathring{\mathcal{A}}_k^\wedge)$ of $\mathring{\mathcal{A}}_k^\wedge$ and $(\text{KII}^s \mathring{\mathcal{A}}^\wedge)$ of $\bigoplus_{k \geq 0} \mathring{\mathcal{A}}_k^\wedge$ by

$$(4.7) \quad (\text{KII}^s \mathring{\mathcal{A}}_k^\wedge) := \text{Im} \left(\text{KIIMap}_{\mathring{\mathcal{A}}^\wedge, k, +-}^{s,2} - \text{KIIMap}_{\mathring{\mathcal{A}}^\wedge, k, +-}^{s,1} \right) + \text{Im} \left(\text{KIIMap}_{\mathring{\mathcal{A}}^\wedge, k, -+}^{s,2} - \text{KIIMap}_{\mathring{\mathcal{A}}^\wedge, k, -+}^{s,1} \right)$$

and

$$(4.8) \quad (\text{KII}^s \mathring{\mathcal{A}}^\wedge) := \bigoplus_{k \geq 0} (\text{KII}^s \mathring{\mathcal{A}}_k^\wedge) \subset \bigoplus_{k \geq 0} \mathring{\mathcal{A}}_k^\wedge,$$

where we set $(\text{KII}^s \mathring{\mathcal{A}}_0^\wedge) = (\text{KII}^s \mathring{\mathcal{A}}_1^\wedge) = \{0\}$.

Lemma 4.7. *The subgroup $(\text{KII}^s \mathring{\mathcal{A}}^\wedge)$ is a $\mathbb{Z}_{\geq 0}$ -graded ideal of $\bigoplus_{k \geq 0} \mathring{\mathcal{A}}_k^\wedge$.*

Proof. The reasoning is the same as in the proof of Proposition 2.110(a). □

Since $(\text{CO} \mathring{\mathcal{A}}^\wedge)$ is also an ideal of $\bigoplus_{k \geq 0} \mathring{\mathcal{A}}_k^\wedge$, so is $(\text{KII}^s \mathring{\mathcal{A}}^\wedge) + (\text{CO} \mathring{\mathcal{A}}^\wedge)$.

Definition 4.8. Define the commutative algebra \mathfrak{a} as the quotient algebra

$$(4.9) \quad \mathfrak{a} := \frac{\bigoplus_{k \geq 0} \mathring{\mathcal{A}}_k^\wedge}{(\text{KII}^s \mathring{\mathcal{A}}^\wedge) + (\text{CO} \mathring{\mathcal{A}}^\wedge)} = \bigoplus_{k \geq 0} \frac{\mathring{\mathcal{A}}_k^\wedge}{(\text{KII}^s \mathring{\mathcal{A}}_k^\wedge) + (\text{CO} \mathring{\mathcal{A}}_k^\wedge)}.$$

4.2.3. *The linear isomorphisms cs_{+-}^ν and cs_{-+}^ν .* Recall that for a Jacobi diagram x , the element $\text{cs}^\nu(x)$ is obtained from x by inserting ν or $z(\nu)$ in each circle component, see §4.1. In this subsection we introduce maps cs_{+-}^ν and cs_{-+}^ν which also insert ν or $z(\nu)$ in the segment components.

Definition 4.9. For any integer $k \geq 2$, define the linear maps

$$(4.10) \quad \text{cs}_{+-}^\nu : \mathring{\mathcal{A}}^\wedge(\downarrow\uparrow)_{k-2} \longrightarrow \mathring{\mathcal{A}}^\wedge(\downarrow\uparrow)_{k-2} \quad \text{and} \quad \text{cs}_{-+}^\nu : \mathring{\mathcal{A}}^\wedge(\uparrow\downarrow)_{k-2} \longrightarrow \mathring{\mathcal{A}}^\wedge(\uparrow\downarrow)_{k-2}$$

by

$$(4.11) \quad \text{cs}_{+-}^\nu(x) = (\nu \otimes_{\mathcal{A}} z(\nu) \otimes_{\mathcal{A}} Z_{\mathcal{A}}(\text{cap}_{(+)(+)}^{\mathcal{T}})) \circ_{\mathcal{A}} (((\text{cup}_{+-} \circ_{\mathcal{A}} (\text{cap}_{+-} \circ_{\mathcal{A}})) \otimes_{\mathcal{A}} \text{cs}^\nu(x)) \circ_{\mathcal{A}} (\text{Id}_{+-} \otimes_{\mathcal{A}} Z_{\mathcal{A}}(\text{cup}_{(+)(+)}^{\mathcal{T}})))$$

for any $x \in \mathring{\mathcal{A}}^\wedge(\downarrow\uparrow)_{k-2}$, where $z(\nu) \in \mathring{\mathcal{A}}^\wedge(\uparrow)_0$ denotes the image of $\nu \in \mathring{\mathcal{A}}^\wedge(\downarrow)_0$ under the map $z : \mathring{\mathcal{A}}^\wedge(\downarrow)_0 \rightarrow \mathring{\mathcal{A}}^\wedge(\uparrow)_0$ from Definition 3.43. See Figure 4.4 for a schematic representation.

For $x \in \mathring{\mathcal{A}}^\wedge(\uparrow\downarrow)_{k-2}$, the element $\text{cs}_{-+}^\nu(x) \in \mathring{\mathcal{A}}^\wedge(\uparrow\downarrow)_{k-2}$ is defined by the formula obtained from (4.11) by permuting the subscripts $+$ and $-$, and by replacing $\nu \otimes_{\mathcal{A}} z(\nu)$ with $z(\nu) \otimes_{\mathcal{A}} \nu$.

Lemma 4.10. *Let $k \in \mathbb{Z}_{\geq 2}$. The linear maps*

$$(4.12) \quad \text{cs}_{+-}^\nu : \mathring{\mathcal{A}}^\wedge(\downarrow\uparrow)_{k-2} \longrightarrow \mathring{\mathcal{A}}^\wedge(\downarrow\uparrow)_{k-2} \quad \text{and} \quad \text{cs}_{-+}^\nu : \mathring{\mathcal{A}}^\wedge(\uparrow\downarrow)_{k-2} \longrightarrow \mathring{\mathcal{A}}^\wedge(\uparrow\downarrow)_{k-2}$$

are isomorphisms.

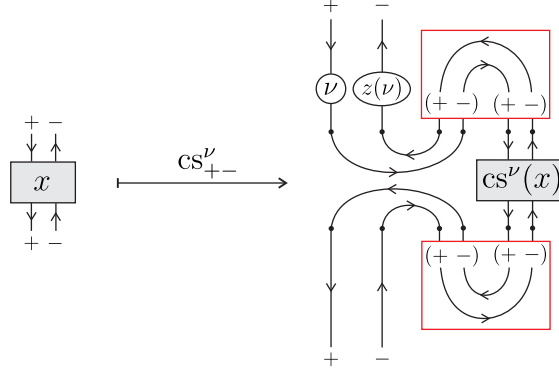

FIGURE 4.4. Schematic representation of the map $\text{cs}_{+-}^\nu : \mathring{\mathcal{A}}(\downarrow\uparrow)_{k-2} \rightarrow \mathring{\mathcal{A}}(\downarrow\uparrow)_{k-2}$. We represent $x \in \mathring{\mathcal{A}}(\downarrow\uparrow)_{k-2}$ by the grey-colored box. The map $\text{cs}_{-+}^\nu : \mathring{\mathcal{A}}(\uparrow\downarrow)_{k-2} \rightarrow \mathring{\mathcal{A}}(\uparrow\downarrow)_{k-2}$ has a similar schematic representation but with all the orientations reversed and by replacing $\nu \otimes_{\mathcal{A}} z(\nu)$ with $z(\nu) \otimes_{\mathcal{A}} \nu$.

Proof. Let us consider the case $+-$. Define the map

$$\tilde{\text{cs}}_{+-}^\nu : \mathring{\mathcal{A}}^\wedge(\downarrow\uparrow)_{k-2} \longrightarrow \mathring{\mathcal{A}}^\wedge(\downarrow\uparrow)_{k-2}$$

by

$$\begin{aligned} \tilde{\text{cs}}_{+-}^\nu(x) = & \left(\nu^{-1} \otimes_{\mathcal{A}} z(\nu)^{-1} \otimes_{\mathcal{A}} (\text{cap}_{+-})_{\mathcal{A}} \right) \circ_{\mathcal{A}} \left((Z_{\mathcal{A}}(\text{cup}_{(+ -)(+ -)}^{\mathcal{T}}) \circ_{\mathcal{A}} Z_{\mathcal{A}}(\text{cup}_{(+ -)(+ -)}^{\mathcal{T}})) \otimes_{\mathcal{A}} \text{cs}^{\nu^{-1}}(x) \right) \\ & \circ_{\mathcal{A}} \left(\text{Id}_{+-} \otimes_{\mathcal{A}} (\text{cup}_{+-})_{\mathcal{A}} \right), \end{aligned}$$

for $x \in \mathring{\mathcal{A}}^\wedge(\downarrow\uparrow)_{k-2}$. Schematically:

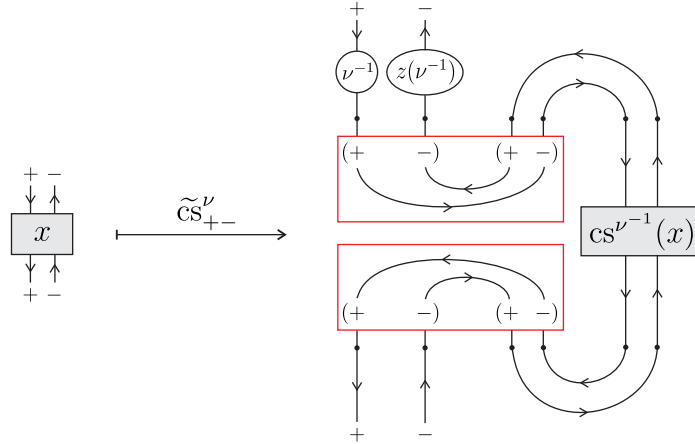

Let $x \in \mathring{\mathcal{A}}^\wedge(\downarrow\uparrow)_{k-2}$, in Figure 4.5 we show a schematic argument for the equality $\tilde{\text{cs}}_{+-}^\nu \circ \text{cs}_{+-}^\nu(x) = x$. In the second equality in Figure 4.5 we have used the compatibility of $Z_{\mathcal{A}}$ with the tensor product and composition and the fact the $\nu \otimes z(\nu)$ is central in the algebra $\mathring{\mathcal{A}}^\wedge(\downarrow\uparrow)_{k-2}$, see Lemma 3.46. In the third equality we have used Lemma 3.44 and a combination of Lemmas 3.45 and 3.46.

Therefore

$$\tilde{\text{cs}}_{+-}^\nu \circ \text{cs}_{+-}^\nu = \text{Id}_{\mathring{\mathcal{A}}^\wedge(\downarrow\uparrow)_{k-2}}.$$

Similarly, one checks $\text{cs}_{-+}^\nu \circ \tilde{\text{cs}}_{-+}^\nu = \text{Id}_{\mathring{\mathcal{A}}^\wedge(\uparrow\downarrow)_{k-2}}$. The case $-+$ is similar. \square

4.2.4. *The equality $\text{cs}^\nu((\text{KII}\mathring{\mathcal{A}}^\wedge)) = (\text{KII}^s\mathring{\mathcal{A}}^\wedge)$.* The automorphism cs^ν of $\bigoplus_{k \geq 0} \mathring{\mathcal{A}}_k^\wedge$ given in (4.2) allows us to relate the two ideals $(\text{KII}\mathring{\mathcal{A}}^\wedge)$ and $(\text{KII}^s\mathring{\mathcal{A}}^\wedge)$ given in (4.3) and (4.8), respectively.

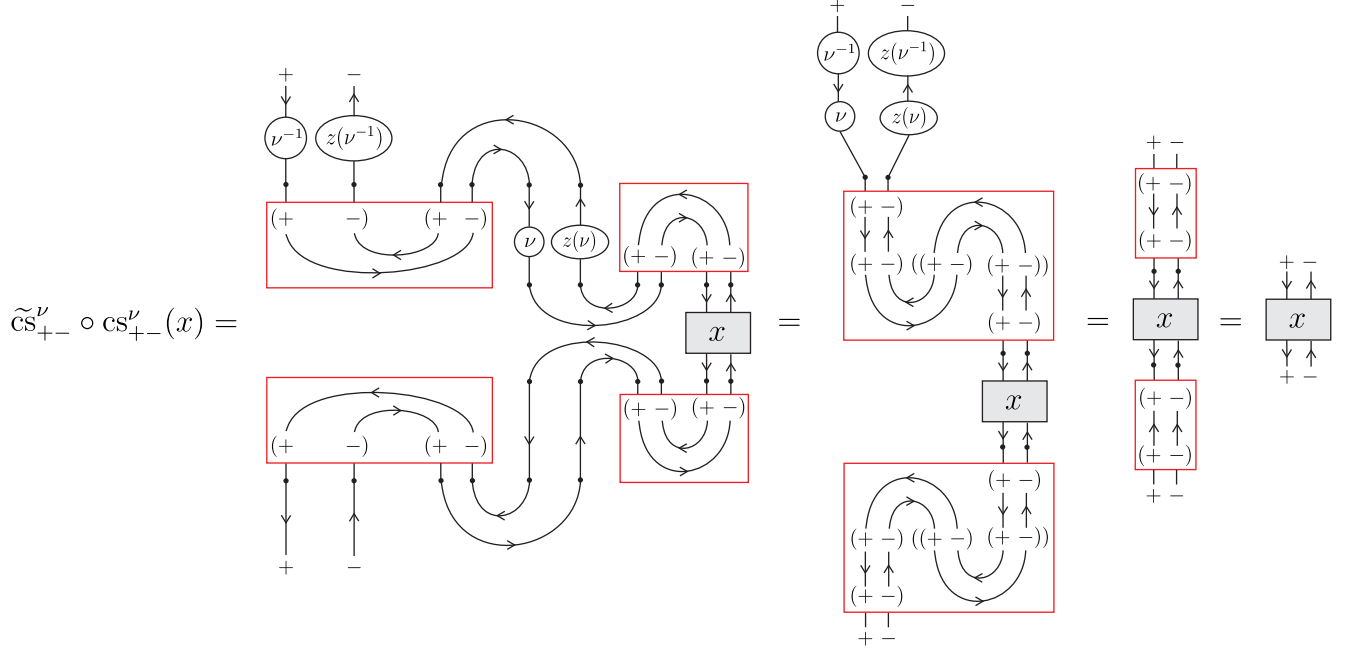

FIGURE 4.5. The equality $\tilde{cs}_{+-}^\nu \circ cs_{+-}^\nu(x) = x$. We represent $x \in \mathring{\mathcal{A}}^\wedge(\downarrow\uparrow)_{k-2}$ by the grey-colored box.

Lemma 4.11. *Let*

$$A := \mathring{\mathcal{A}}^\wedge(\text{cap}_{+-+}, \emptyset) \otimes \mathring{\mathcal{A}}^\wedge(\downarrow\uparrow\downarrow\uparrow, \text{Cir}(\text{cup}^{k-2}, \text{cap}^{k-2})) \otimes \mathring{\mathcal{A}}^\wedge(\text{cup}_{+-+}, \emptyset)$$

and

$$B := \mathring{\mathcal{A}}^\wedge(\text{cap}_{+-+}, \emptyset) \otimes \mathring{\mathcal{A}}^\wedge(\downarrow^{k-2} \otimes \downarrow\uparrow\downarrow\uparrow, \emptyset) \otimes \mathring{\mathcal{A}}^\wedge(\text{cup}_{+-+}, \emptyset)$$

Recall the anti-homomorphism $z : \mathring{\mathcal{A}}^\wedge(\downarrow, \emptyset) \rightarrow \mathring{\mathcal{A}}^\wedge(\uparrow, \emptyset)$ from Definition 3.43. Let $h : B \rightarrow B$ be the linear map defined by

$$(4.13) \quad h(x \otimes y \otimes w) = x \otimes (y \circ_{\mathcal{A}} (\nu^{\otimes k-2} \otimes_{\mathcal{A}} \nu \otimes_{\mathcal{A}} z(\nu) \otimes_{\mathcal{A}} \text{Id}_{+-}^{\mathcal{A}})) \otimes w$$

for any $x \in \mathring{\mathcal{A}}^\wedge(\text{cap}_{+-+}, \emptyset)$, $y \in \mathring{\mathcal{A}}^\wedge(\downarrow^{k-2} \otimes \downarrow\uparrow\downarrow\uparrow, \emptyset)$ and $w \in \mathring{\mathcal{A}}^\wedge(\text{cup}_{+-+}, \emptyset)$.

Let g be the endomorphism of $\mathring{\mathcal{A}}^\wedge(\downarrow^k, \emptyset)$ defined by

$$(4.14) \quad g(x) = (\text{Id}_{+\otimes(k-2)}^{\mathcal{A}} \otimes_{\mathcal{A}} \nu \otimes_{\mathcal{A}} \text{Id}_+^{\mathcal{A}}) \circ_{\mathcal{A}} x \circ_{\mathcal{A}} (\nu^{\otimes(k-2)} \otimes_{\mathcal{A}} \text{Id}_+^{\mathcal{A}} \otimes_{\mathcal{A}} \nu)$$

for any $x \in \mathring{\mathcal{A}}^\wedge(\downarrow^k, \emptyset)$.

Let $\tilde{\lambda}_k^\nu : \mathring{\mathcal{A}}^\wedge(\downarrow\uparrow\downarrow\uparrow, \text{Cir}(\text{cup}^{k-2}, \text{cap}^{k-2})) \rightarrow \mathring{\mathcal{A}}^\wedge(\downarrow\uparrow\downarrow\uparrow, \text{Cir}(\text{cup}^{k-2}, \text{cap}^{k-2}))$ be the linear map given by

$$(4.15) \quad \tilde{\lambda}_k^\nu(x) = (\nu \otimes z(\nu) \otimes \text{Id}_{+-}) \circ \tilde{cs}_{\downarrow\uparrow\downarrow\uparrow, \text{Cir}(\text{cup}^{k-2}, \text{cap}^{k-2})}^\nu(x)$$

for any $x \in \mathring{\mathcal{A}}^\wedge(\downarrow\uparrow\downarrow\uparrow, \text{Cir}(\text{cup}^{k-2}, \text{cap}^{k-2}))$,

Let $c : B \rightarrow A$ be the linear map given by $c = \text{Id} \otimes \text{clos}_{k-2} \otimes \text{Id}$, where clos_{k-2} is as in Definition 4.1 with $P = \downarrow\uparrow\downarrow\uparrow$.

Let $f : B \rightarrow \mathring{\mathcal{A}}^\wedge(\downarrow^k, \emptyset)$ be the linear map defined schematically in Figure 4.6.

Then the diagrams in (4.16) and (4.17) are commutative.

$$(4.16) \quad \begin{array}{ccc} B & \xrightarrow{c} & A \\ h \downarrow & & \downarrow \text{Id} \otimes \tilde{\lambda}_k^\nu \otimes \text{Id} \\ B & \xrightarrow{c} & A \end{array} \quad \begin{array}{ccc} B & \xrightarrow{f} & \mathring{\mathcal{A}}^\wedge(\downarrow^k, \emptyset) \\ h \downarrow & & \downarrow g \\ B & \xrightarrow{f} & \mathring{\mathcal{A}}^\wedge(\downarrow^k, \emptyset) \end{array}$$

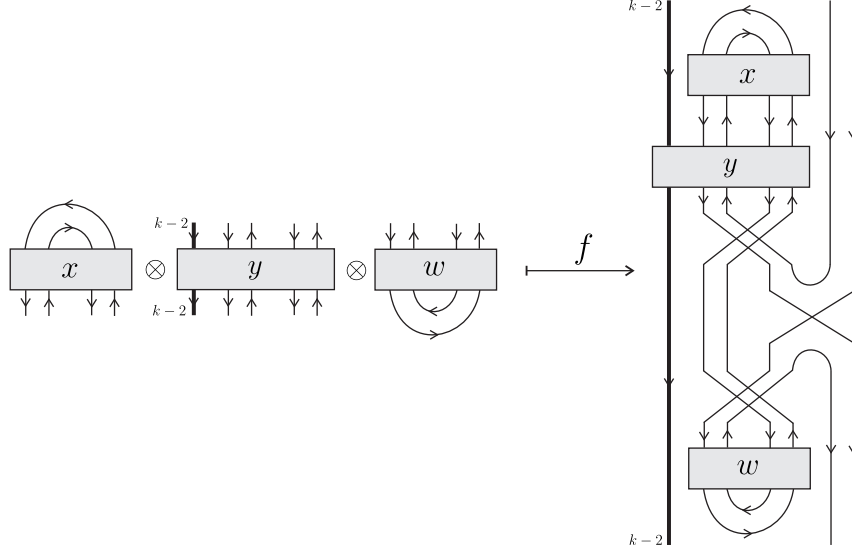

FIGURE 4.6. The linear map f . The thick line with the label $k - 2$ means $k - 2$ vertical segments oriented downward.

$$(4.17) \quad \begin{array}{ccc} B & \xrightarrow{f} \mathring{A}^\wedge(\downarrow^k, \emptyset) & \xrightarrow{\text{clos}_k} \mathring{A}^\wedge(\vec{\emptyset}, \text{Cir}(\text{cup}^k, \text{cap}^k)) \\ \downarrow c & & \downarrow \simeq \\ A & \longrightarrow \mathring{A}^\wedge(\vec{\emptyset}, \text{Cir}(\text{cap}^{k-2}, \text{cap}^{k-2}) \sqcup \text{Cir}(\text{cap}_{+-+-}, \text{cup}_{+-+-})) & \end{array}$$

The bottom map in (4.17) is the composition map and the right vertical isomorphism is induced by the bijection $\text{Cir}(\text{cup}^k, \text{cap}^k) \xrightarrow{\simeq} \text{Cir}(\text{cap}^{k-2}, \text{cap}^{k-2}) \sqcup \text{Cir}(\text{cap}_{+-+-}, \text{cup}_{+-+-})$ which identifies the most outer circles in $\text{cup}^k \circ \text{cap}^k$ with $\text{Cir}(\text{cap}_{+-+-}, \text{cup}_{+-+-})$.

Proof. Let $R := \text{Cir}(\text{cap}^{k-2}, \text{cup}^{k-2})$. Define the linear maps

$$a : \mathring{A}^\wedge(\downarrow^{k-2} \otimes \downarrow\uparrow\downarrow\uparrow, \emptyset) \rightarrow \mathring{A}^\wedge(\downarrow^{k-2} \otimes \downarrow\uparrow\downarrow\uparrow, \emptyset) \quad \text{and} \quad b : \mathring{A}^\wedge(\downarrow\uparrow\downarrow\uparrow, R) \rightarrow \mathring{A}^\wedge(\downarrow\uparrow\downarrow\uparrow, R)$$

by $a(y) = (\text{Id}_{(+)^{\otimes(k-2)}}^A \otimes_A \nu \otimes_A z(\nu) \otimes_A \text{Id}_{+-}^A) \circ_A y$ for any $y \in \mathring{A}^\wedge(\downarrow^{k-2} \otimes \downarrow\uparrow\downarrow\uparrow, \emptyset)$ and by $b(y) = (\nu \otimes_A z(\nu) \otimes_A \text{Id}_{+-}^A) \circ_A y$ for any $y \in \mathring{A}^\wedge(\downarrow\uparrow\downarrow\uparrow, R)$. In diagram (4.18), the left triangle commutes because of associativity of the composition, the right triangle commutes by the definition of the involved maps, the top square commutes by Lemma 4.2(a) and the bottom square commutes by the identity represented schematically in Figure 4.7. Therefore the outer square, which is the left diagram on the left of (4.16), commutes.

$$(4.18) \quad \begin{array}{ccc} \mathring{A}^\wedge(\downarrow^{k-2} \otimes \downarrow\uparrow\downarrow\uparrow, \emptyset) & \xrightarrow{\text{clos}_{k-2}} & \mathring{A}^\wedge(\downarrow\uparrow\downarrow\uparrow, R) \\ \downarrow (\nu^{\otimes(k-2)} \otimes_A \nu \otimes_A z(\nu) \otimes_A \text{Id}_{+-}^A) \circ_A \bullet & \searrow (\nu^{\otimes(k-2)} \otimes_A \text{Id}_{+-}^A) \circ_A \bullet & \swarrow \tilde{\text{cs}}_{\downarrow\uparrow\downarrow\uparrow, R}^\nu \\ \mathring{A}^\wedge(\downarrow^{k-2} \otimes \downarrow\uparrow\downarrow\uparrow, \emptyset) & \xrightarrow{\text{clos}_{k-2}} \mathring{A}^\wedge(\downarrow\uparrow\downarrow\uparrow, R) & \\ \downarrow (\nu^{\otimes(k-2)} \otimes_A \nu \otimes_A z(\nu) \otimes_A \text{Id}_{+-}^A) \circ_A \bullet & \swarrow a & \searrow b \\ \mathring{A}^\wedge(\downarrow^{k-2} \otimes \downarrow\uparrow\downarrow\uparrow, \emptyset) & \xrightarrow{\text{clos}_{k-2}} & \mathring{A}^\wedge(\downarrow\uparrow\downarrow\uparrow, R) \\ & & \downarrow \tilde{\lambda}_k^\nu \end{array}$$

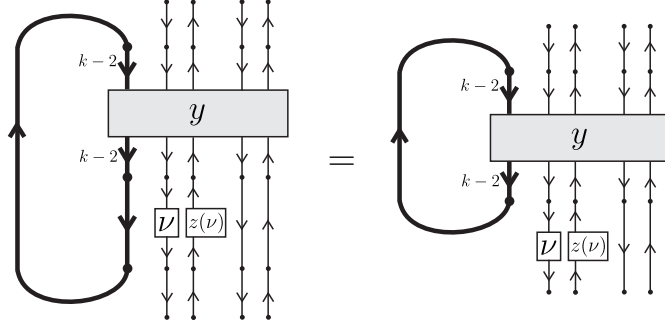

FIGURE 4.7. Schematic proof of the equality $\text{clos}_{k-2} \circ a(y) = \text{clos}_{k-2}(y) \circ_{\mathcal{A}} (\nu \otimes_{\mathcal{A}} z(\nu) \otimes_{\mathcal{A}} \text{Id}_{+-}^{\mathcal{A}})$ in $\mathring{\mathcal{A}}^{\wedge}(\downarrow\uparrow\downarrow\uparrow, \text{Cir}(\text{cap}^{k-2}, \text{cup}^{k-2}))$ for any $y \in \mathring{\mathcal{A}}^{\wedge}(\downarrow^{k-2} \otimes \downarrow\uparrow\downarrow\uparrow, \emptyset)$.

Let $y \in \mathring{\mathcal{A}}^{\wedge}(\downarrow^{k-2} \otimes \downarrow\uparrow\downarrow\uparrow, \emptyset)$. Multiple applications of Lemma 3.46 implies

$$(4.19) \quad y \circ_{\mathcal{A}} (\nu^{\otimes(k-2)} \otimes_{\mathcal{A}} \nu \otimes_{\mathcal{A}} z(\nu) \otimes_{\mathcal{A}} \text{Id}_{+-}^{\mathcal{A}}) = (\nu^{\otimes(k-2)} \otimes_{\mathcal{A}} \nu \otimes_{\mathcal{A}} z(\nu) \otimes_{\mathcal{A}} \text{Id}_{+-}^{\mathcal{A}}) \circ_{\mathcal{A}} y,$$

equality in $\mathring{\mathcal{A}}^{\wedge}(\downarrow^{k-2} \otimes \downarrow\uparrow\downarrow\uparrow, \emptyset)$. A schematic representation of it is shown in Figure 4.8. Equality (4.19)

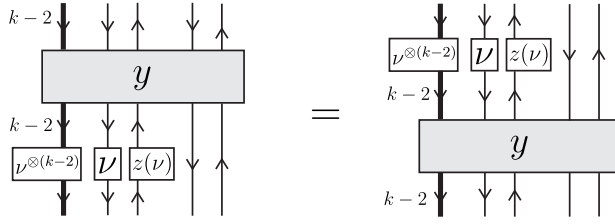

FIGURE 4.8. Schematic representation of the equality (4.19).

implies the commutativity of the diagram on the left in (4.16).

Let $x \in \mathring{\mathcal{A}}^{\wedge}(\text{cap}_{+-+--}, \emptyset)$, $y \in \mathring{\mathcal{A}}^{\wedge}(\downarrow^{k-2} \otimes \downarrow\uparrow\downarrow\uparrow, \emptyset)$ and $w \in \mathring{\mathcal{A}}^{\wedge}(\text{cup}_{+-+--}, \emptyset)$. We give schematic representation of $f \circ h(x \otimes y \otimes w)$ and $g \circ f(x \otimes y \otimes w)$ in Figure 4.9(a) and (b), respectively.

Lemma 3.45 implies that these two elements are equal in $\mathring{\mathcal{A}}^{\wedge}(\downarrow^k, \emptyset)$, which is exactly the commutativity of the diagram on the right in (4.16).

The commutativity of the diagram (4.17) follows from the equality shown in Figure 4.10. \square

Lemma 4.12. *Let $k \in \mathbb{Z}_{\geq 2}$. Let*

$$\lambda_k^{\nu} : \mathring{\mathcal{A}}^{\wedge}(\downarrow\uparrow\downarrow\uparrow)_{k-2} \longrightarrow \mathring{\mathcal{A}}^{\wedge}(\downarrow\uparrow\downarrow\uparrow)_{k-2}$$

be the map defined by $\lambda_k^{\nu}(x) := (\nu \otimes_{\mathcal{A}} z(\nu) \otimes_{\mathcal{A}} (\text{Id}_{+-})_{\mathcal{A}}) \circ_{\mathcal{A}} \text{cs}_{\downarrow\uparrow\downarrow\uparrow, k-2}^{\nu}(x)$ for any $x \in \mathring{\mathcal{A}}^{\wedge}(\downarrow\uparrow\downarrow\uparrow)_{k-2}$. The composition operation $\circ_{\mathcal{A}}$ gives rise to a continuous linear map

$$\mathring{\mathcal{A}}^{\wedge}(\text{cap}_{+-+--})_0 \otimes \mathring{\mathcal{A}}^{\wedge}(\downarrow\uparrow\downarrow\uparrow)_{k-2} \otimes \mathring{\mathcal{A}}^{\wedge}(\text{cup}_{+-+--})_0 \longrightarrow \mathring{\mathcal{A}}_{k-2+|\text{Cir}(\text{cap}_{+-+--}, \text{cup}_{+-+--})}^{\wedge} = \mathring{\mathcal{A}}_k^{\wedge}.$$

Then the diagram

$$(4.20) \quad \begin{array}{ccc} \mathring{\mathcal{A}}^{\wedge}(\text{cap}_{+-+--})_0 \otimes \mathring{\mathcal{A}}^{\wedge}(\downarrow\uparrow\downarrow\uparrow)_{k-2} \otimes \mathring{\mathcal{A}}^{\wedge}(\text{cup}_{+-+--})_0 & \longrightarrow & \mathring{\mathcal{A}}_k^{\wedge} \\ \text{Id} \otimes \lambda_k^{\nu} \otimes \text{Id} \downarrow & & \downarrow \text{cs}^{\nu} \\ \mathring{\mathcal{A}}^{\wedge}(\text{cap}_{+-+--})_0 \otimes \mathring{\mathcal{A}}^{\wedge}(\downarrow\uparrow\downarrow\uparrow)_{k-2} \otimes \mathring{\mathcal{A}}^{\wedge}(\text{cup}_{+-+--})_0 & \longrightarrow & \mathring{\mathcal{A}}_k^{\wedge} \end{array}$$

is commutative.

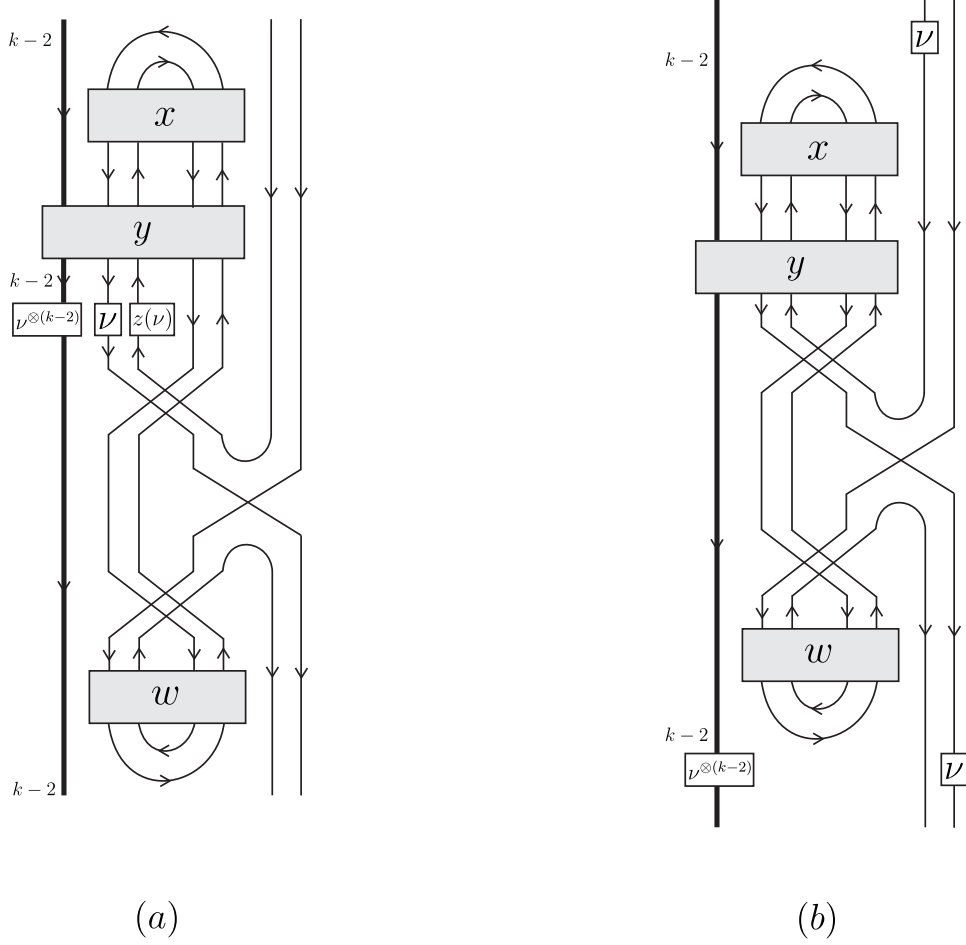

FIGURE 4.9. (a) Schematic representation of $f \circ h(x \otimes y \otimes w)$. (b) Schematic representation of $g \circ f(x \otimes y \otimes w)$.

Proof. Let A , B and $\tilde{\lambda}_k^\nu$ be as in Lemma 4.11. Let $S := \text{Cir}(\text{cap}^{k-2}, \text{cup}^{k-2}) \sqcup \text{Cir}(\text{cap}_{+--+}, \text{cup}_{+--+})$. The composition map $A \rightarrow \mathring{A}^\wedge(\vec{\partial}, S)$ and the maps $\text{Id} \otimes \tilde{\lambda}_k^\nu \otimes \text{Id} : A \rightarrow A$ and $\tilde{\text{cs}}_{\vec{\partial}, S}^\nu : \mathring{A}^\wedge(\vec{\partial}, S) \rightarrow \mathring{A}^\wedge(\vec{\partial}, S)$ are respectively compatible with the evident group homomorphism $\mathfrak{S}_{\text{Cir}(\text{cap}^{k-2}, \text{cup}^{k-2})} \rightarrow \mathfrak{S}_S$ and with the actions of these groups. Therefore, they give rise to morphisms in the category VectGp . By their definition and since $|S| = k$ and $|\text{Cir}(\text{cap}^{k-2}, \text{cup}^{k-2})| = k - 2$, the images of these morphisms under the coinvariant space functor are the maps involved in Diagram (4.20). The announced commutativity is then a consequence of the commutativity of Diagram (4.21), which we now prove.

$$(4.21) \quad \begin{array}{ccc} A & \longrightarrow & \mathring{A}^\wedge(\vec{\partial}, S) \\ \text{Id} \otimes \tilde{\lambda}_k^\nu \otimes \text{Id} \downarrow & & \downarrow \tilde{\text{cs}}_{\vec{\partial}, S}^\nu \\ A & \longrightarrow & \mathring{A}^\wedge(\vec{\partial}, S) \end{array}$$

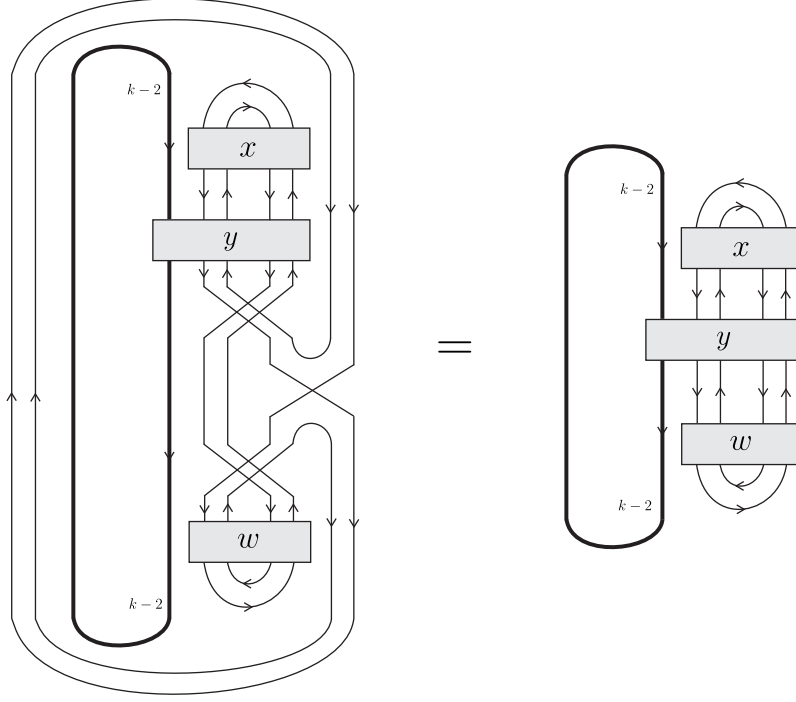

FIGURE 4.10. Equality implying the commutativity of the diagram (4.17).

We will decompose Diagram (4.21) in several diagrams. Let c , f , g , and h as in Lemma 4.11 and consider the diagram (4.22).

$$(4.22) \quad \begin{array}{ccc} A & \xrightarrow{\quad} & \mathring{A}^\wedge(\vec{\emptyset}, S) \\ \downarrow \text{Id} \otimes \tilde{\lambda}_k^\nu \otimes \text{Id} & \swarrow c & \searrow \cong \\ B & \xrightarrow{f} \mathring{A}^\wedge(\downarrow^k, \emptyset) \xrightarrow{\text{clos}_k} \mathring{A}^\wedge(\vec{\emptyset}, \text{Cir}(\text{cap}^k, \text{cup}^k)) & \downarrow \tilde{c}_{\vec{\emptyset}, \text{Cir}(\text{cap}^k, \text{cup}^k)}^\nu \\ & \searrow g \left(\bullet \circ_{\mathcal{A}} \nu^{\otimes k} \right) & \downarrow \tilde{c}_{\vec{\emptyset}, \text{Cir}(\text{cap}^k, \text{cup}^k)}^\nu \\ B & \xrightarrow{f} \mathring{A}^\wedge(\downarrow^k, \emptyset) \xrightarrow{\text{clos}_k} \mathring{A}^\wedge(\vec{\emptyset}, \text{Cir}(\text{cap}^k, \text{cup}^k)) & \downarrow \tilde{c}_{\vec{\emptyset}, S}^\nu \\ \downarrow c & \swarrow c & \searrow \cong \\ A & \xrightarrow{\quad} & \mathring{A}^\wedge(\vec{\emptyset}, S) \end{array}$$

The top and bottom pentagons are the commutative diagram (4.17), the square on the left is the commutative diagram on the left of (4.16), the inner square involving f , g and h is the commutative diagram on the right of (4.16). By Lemma 3.46 we have $g = \bullet \circ_{\mathcal{A}} \nu^{\otimes k}$. The inner square involving clos_k is commutative by Lemma 4.2(a). The square on the right is commutative by Lemma 4.2(b). All this implies the commutativity of the outer square which is exactly (4.21). This finishes the proof. \square

Lemma 4.13. *The diagram*

$$(4.23) \quad \begin{array}{ccc} \mathring{A}^\wedge(\downarrow \uparrow)_{k-2} & \xrightarrow{\text{KIIMap}_{\mathring{A}^\wedge, k, +-}^1} & \mathring{A}_k^\wedge \\ \text{cs}_{+-}^\nu \downarrow & & \downarrow \text{cs}^\nu \\ \mathring{A}^\wedge(\downarrow \uparrow)_{k-2} & \xrightarrow{\text{KIIMap}_{\mathring{A}^\wedge, k, +-}^{s,1}} & \mathring{A}_k^\wedge \end{array} .$$

commutes, where the maps cs_{+-}^ν and cs^ν are given in (4.12) and (4.2) respectively. We also have a similar commutative diagram involving the space $\mathring{\mathcal{A}}^\wedge(\uparrow\downarrow)_{k-2}$ and the $-+$ versions of the stated maps.

Proof. We use the schematic representations of the maps cs_{+-}^ν , $\text{KIIMap}_{\mathring{\mathcal{A}}^\wedge, k, +-}^1$ and $\text{KIIMap}_{\mathring{\mathcal{A}}^\wedge, k, +-}^{s,1}$ given in Figures 4.4, 4.2 and 4.3 to give a schematic proof in Figure 4.11. In the second equality we have used Lemma 3.45 and in the third equality Lemma 4.12.

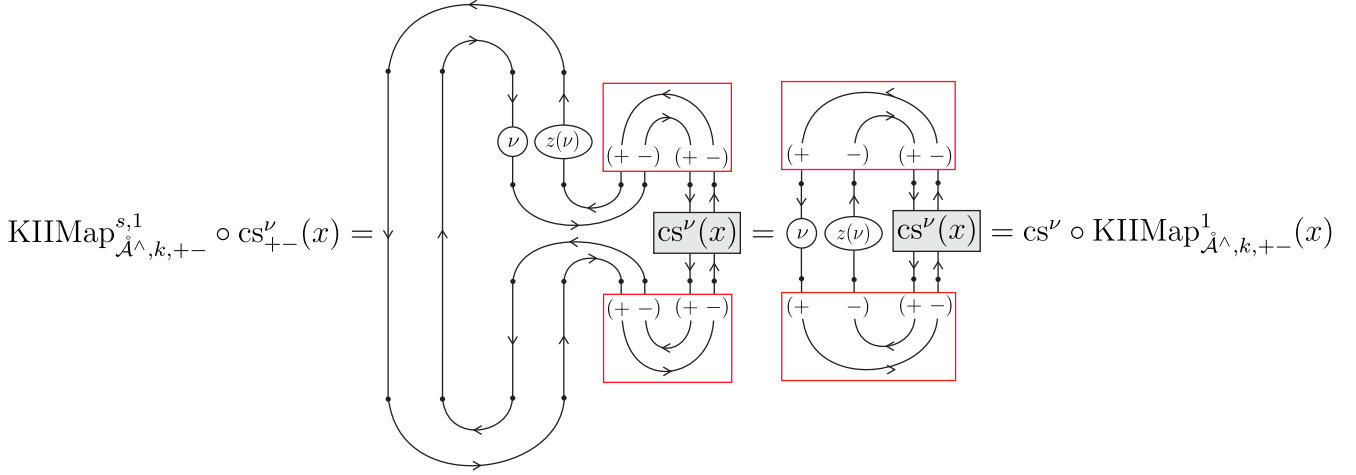

FIGURE 4.11. The equality $\text{KIIMap}_{\mathring{\mathcal{A}}^\wedge, k, +-}^{s,1} \circ cs_{+-}^\nu(x) = cs^\nu \circ \text{KIIMap}_{\mathring{\mathcal{A}}^\wedge, k, +-}^1(x)$. We represent $x \in \mathring{\mathcal{A}}^\wedge(\uparrow\downarrow)_{k-2}$ by the grey-colored box.

□

Consider the oriented Brauer diagrams $\text{cap}_{-+++} := \text{cap}_{-+} \otimes \text{cap}_{+-} \in \vec{\mathcal{B}}r(-++-, \emptyset)$, $\text{cup}_{-+++} := \text{cup}_{-+} \otimes \text{cup}_{+-} \in \vec{\mathcal{B}}r(\emptyset, -++-)$, $\text{cap}_{+---} := \text{cap}_{+-} \otimes \text{cap}_{-+} \in \vec{\mathcal{B}}r(+---, \emptyset)$ and $\text{cup}_{+---} := \text{cup}_{+-} \otimes \text{cup}_{-+} \in \vec{\mathcal{B}}r(\emptyset, +---)$. Here the oriented Brauer diagrams cap_u and cup_u for $u \in \{-+, +- \}$ are as in Definition 3.42.

Definition 4.14. Define the multilinear maps

$$\langle , , \rangle_{k, +-} : \mathring{\mathcal{A}}^\wedge(\text{cap}_{-+++})_0 \otimes \mathring{\mathcal{A}}^\wedge(\text{cup}_{-+++})_0 \otimes \mathring{\mathcal{A}}^\wedge(\uparrow\downarrow)_{k-2} \longrightarrow \mathring{\mathcal{A}}_k^\wedge$$

and

$$\langle , , \rangle_{k, -+} : \mathring{\mathcal{A}}^\wedge(\text{cap}_{+---})_0 \otimes \mathring{\mathcal{A}}^\wedge(\text{cup}_{+---})_0 \otimes \mathring{\mathcal{A}}^\wedge(\uparrow\downarrow)_{k-2} \longrightarrow \mathring{\mathcal{A}}_k^\wedge$$

by

$$\langle x, y, z \rangle_{k, +-} = x \circ_{\mathcal{A}} ((\text{Id}_{-})_{\mathcal{A}} \otimes_{\mathcal{A}} z) \circ_{\mathcal{A}} y, \quad \text{and} \quad \langle x, y, z \rangle_{k, -+} = x' \circ_{\mathcal{A}} ((\text{Id}_{+})_{\mathcal{A}} \otimes_{\mathcal{A}} z') \circ_{\mathcal{A}} y'$$

for any $x \in \mathring{\mathcal{A}}^\wedge(\text{cap}_{-+++})_0$, $y \in \mathring{\mathcal{A}}^\wedge(\text{cup}_{-+++})_0$, $z \in \mathring{\mathcal{A}}^\wedge(\uparrow\downarrow)_{k-2}$, $x' \in \mathring{\mathcal{A}}^\wedge(\text{cap}_{+---})_0$, $y' \in \mathring{\mathcal{A}}^\wedge(\text{cup}_{+---})_0$ and $z' \in \mathring{\mathcal{A}}^\wedge(\uparrow\downarrow)_{k-2}$. See Figure 4.12 for a schematic representation of these maps.

Lemma 4.15. Let $x \in \mathring{\mathcal{A}}^\wedge(\text{cap}_{-+++})_0$, $y \in \mathring{\mathcal{A}}^\wedge(\text{cup}_{-+++})_0$, $z \in \mathring{\mathcal{A}}^\wedge(\uparrow\downarrow)_{k-2}$, $v \in \mathring{\mathcal{A}}^\wedge(\uparrow\downarrow)_0$, $x' \in \mathring{\mathcal{A}}^\wedge(\text{cap}_{+---})_0$, $y' \in \mathring{\mathcal{A}}^\wedge(\text{cup}_{+---})_0$, $z' \in \mathring{\mathcal{A}}^\wedge(\uparrow\downarrow)_{k-2}$ and $v' \in \mathring{\mathcal{A}}^\wedge(\uparrow\downarrow)_0$ with v and v' invertible. Set

$$u := (\text{Id}_{-})_{\mathcal{A}} \otimes_{\mathcal{A}} v \otimes_{\mathcal{A}} (\text{Id}_{-})_{\mathcal{A}} \in \mathring{\mathcal{A}}^\wedge(\uparrow\downarrow\uparrow\downarrow)_0 \quad \text{and} \quad u' := (\text{Id}_{+})_{\mathcal{A}} \otimes_{\mathcal{A}} v' \otimes_{\mathcal{A}} (\text{Id}_{+})_{\mathcal{A}} \in \mathring{\mathcal{A}}^\wedge(\uparrow\downarrow\uparrow\downarrow)_0.$$

Then

(4.24)

$$\langle x \circ_{\mathcal{A}} u, u^{-1} \circ_{\mathcal{A}} y, \text{dbl}_1(z) \rangle = \langle x, y, \text{dbl}_1(z) \rangle_{k, +-} \quad \text{and} \quad \langle x \circ_{\mathcal{A}} u, u^{-1} \circ_{\mathcal{A}} y, \text{dbl}_1(z) \rangle = \langle x, y, \text{dbl}_1(z) \rangle_{k, -+}$$

Proof. In Figure 4.13 we give a schematic proof of the first identity in (4.24). In the second equality we use Lemma 3.47. □

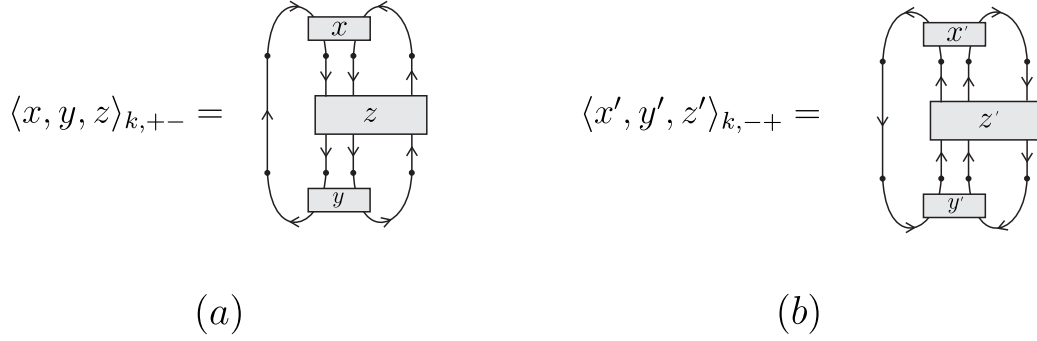

FIGURE 4.12. Schematic representations of the maps $\langle \cdot, \cdot, \cdot \rangle_{k,+}$ and $\langle \cdot, \cdot, \cdot \rangle_{k,-}$. Notice that in the grey-colored boxes labelled by z and z' there is implicit $k - 2$ circles which are not shown in the figure.

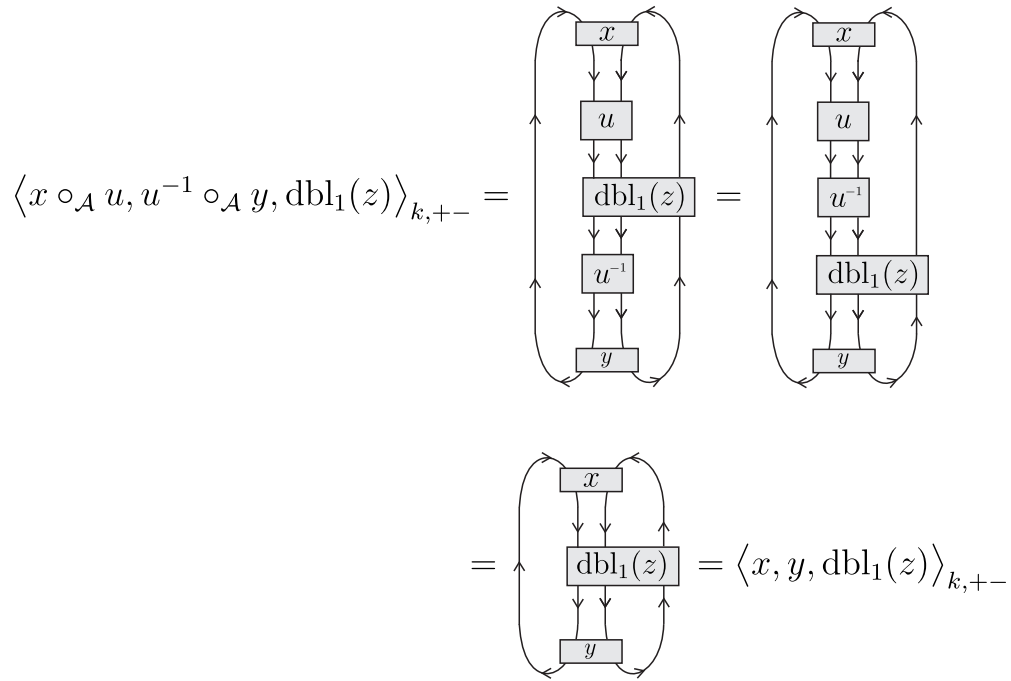

FIGURE 4.13. Schematic proof of the first identity in (4.24).

Lemma 4.16. *Let*

$$\alpha_{t,+}, \beta_{t,+} \in \mathring{\mathcal{A}}^\wedge(\text{cap}_{-++})_0, \quad \alpha_{b,+}, \beta_{t,+} \in \mathring{\mathcal{A}}^\wedge(\text{cup}_{-++})_0,$$

$$\alpha_{t,-}, \beta_{t,-} \in \mathring{\mathcal{A}}^\wedge(\text{cap}_{+--})_0, \quad \alpha_{b,-}, \beta_{t,-} \in \mathring{\mathcal{A}}^\wedge(\text{cup}_{+--})_0$$

be the elements given by

$$\begin{aligned}\alpha_{t,+ -} &= Z_{\mathcal{A}}(\text{cap}_{-((++)-)}^{\mathcal{T}}) \circ_{\mathcal{A}} ((\text{Id}_{-})_{\mathcal{A}} \otimes_{\mathcal{A}} \nu \otimes_{\mathcal{A}} \nu \otimes_{\mathcal{A}} (\text{Id}_{-})_{\mathcal{A}}), \\ \alpha_{b,+ -} &= Z_{\mathcal{A}}(\text{cup}_{-((++)-)}^{\mathcal{T}}), \\ \beta_{t,+ -} &= ((\text{cap}_{-+})_{\mathcal{A}} \otimes_{\mathcal{A}} (\text{cap}_{+-})_{\mathcal{A}}) \circ_{\mathcal{A}} \left((\text{Id}_{-})_{\mathcal{A}} \otimes_{\mathcal{A}} \text{dbl}_1((\nu \otimes_{\mathcal{A}} z(\nu) \otimes_{\mathcal{A}} Z_{\mathcal{A}}(\text{cap}_{(+-)(+-)}^{\mathcal{T}})) \right. \\ &\quad \left. \circ_{\mathcal{A}} ((\text{cup}_{+-+})_{\mathcal{A}} \otimes (\text{Id}_{+-})_{\mathcal{A}}) \right), \\ \beta_{b,+ -} &= \left((\text{Id}_{-})_{\mathcal{A}} \otimes_{\mathcal{A}} \text{dbl}_1(((\text{cap}_{+-+})_{\mathcal{A}} \otimes_{\mathcal{A}} (\text{Id}_{+-})_{\mathcal{A}}) \circ_{\mathcal{A}} ((\text{Id}_{+-})_{\mathcal{A}} \otimes_{\mathcal{A}} Z_{\mathcal{A}}(\text{cup}_{(+-)(+-)}^{\mathcal{T}}))) \right) \\ &\quad \circ_{\mathcal{A}} ((\text{cup}_{-+})_{\mathcal{A}} \otimes_{\mathcal{A}} (\text{cup}_{+-})_{\mathcal{A}}).\end{aligned}$$

The elements $\alpha_{t,-+}$, $\alpha_{b,-+}$, $\beta_{t,-+}$ and $\beta_{b,-+}$ as given by the formulas obtained from the previous ones by permuting the subscripts $+$ and $-$, and ν and $z(\nu)$. In Figures 4.14 and 4.15 we give a schematic representations of these elements using Conventions 3.38 and 3.25.

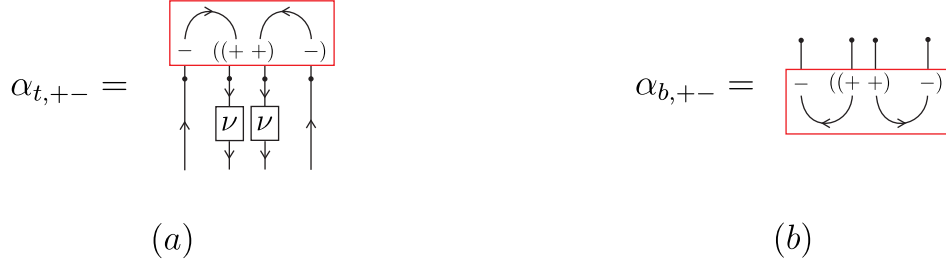

FIGURE 4.14. Schematic representation of the elements $\alpha_{t,+ -}$ and $\alpha_{b,+ -}$. The elements $\alpha_{t,-+}$ and $\alpha_{b,-+}$ have similar representations but with the opposite orientation and replacing ν with $z(\nu)$.

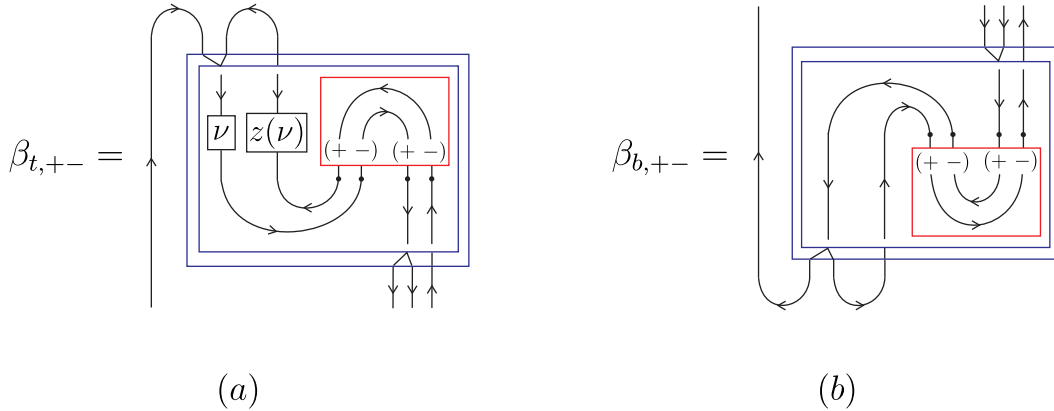

FIGURE 4.15. Schematic representation of the elements $\beta_{t,+ -}$ and $\beta_{b,+ -}$. The elements $\beta_{t,-+}$ and $\beta_{b,-+}$ have similar representations but with the opposite orientation and permuting ν with $z(\nu)$.

Then for any $k \geq 2$ and any $x \in \mathring{\mathcal{A}}^{\wedge}(\downarrow\uparrow)_{k-2}$ we have

$$(4.25) \quad \langle \alpha_{t,+ -}, \alpha_{b,+ -}, \text{dbl}_1(\text{cs}^{\nu}(x)) \rangle_{k,+ -} = \text{cs}^{\nu} \circ \text{KIIMap}_{\mathring{\mathcal{A}}^{\wedge}, k, + -}^2(x)$$

$$(4.26) \quad \langle \beta_{t,+ -}, \beta_{b,+ -}, \text{dbl}_1(\text{cs}^{\nu}(x)) \rangle_{k,+ -} = \text{KIIMap}_{\mathring{\mathcal{A}}^{\wedge}, k, + -}^{s, 2} \circ \text{cs}_{+ -}^{\nu}(x).$$

(equalities in $\mathring{\mathcal{A}}_k^\wedge$). Similarly,

$$(4.27) \quad \langle \alpha_{t,-+}, \alpha_{b,-+}, \text{dbl}_1(\text{cs}^\nu(y)) \rangle_{k,-+} = \text{cs}^\nu \circ \text{KIIMap}_{\mathring{\mathcal{A}}^\wedge, k, -+}^2(y)$$

$$(4.28) \quad \langle \beta_{t,-+}, \beta_{b,-+}, \text{dbl}_1(\text{cs}^\nu(y)) \rangle_{k,-+} = \text{KIIMap}_{\mathring{\mathcal{A}}^\wedge, k, +-}^{s,2} \circ \text{cs}_{-+}^\nu(y)$$

for any $y \in \mathring{\mathcal{A}}^\wedge(\uparrow\downarrow)_{k-2}$ (equalities in $\mathring{\mathcal{A}}_k^\wedge$). Here we are using Convention 3.26 for the doubling map.

Proof. The four equalities follow directly by the definitions of the elements and maps involved together with Lemma 4.12, Lemma 3.45, the commutativity of cs^ν with the doubling operation and the compatibility of the composition with the doubling operation. For instance, in Figure 4.16 we show a schematic version of the proof of (4.25).

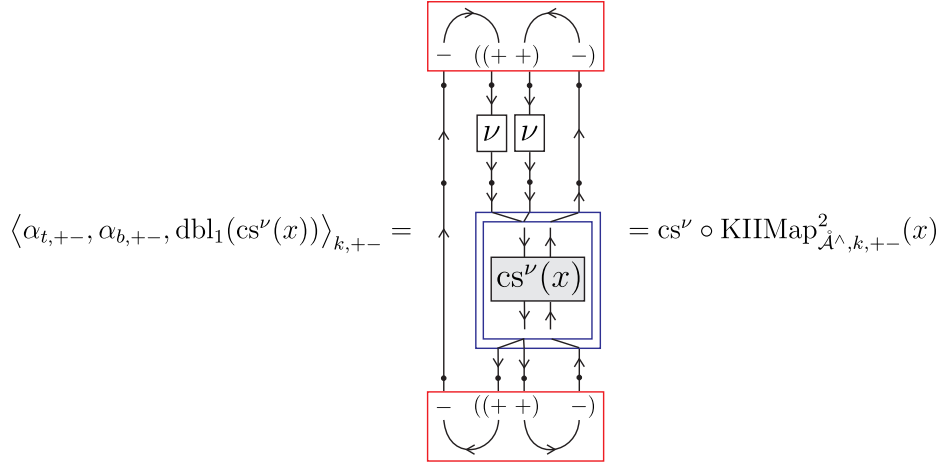

FIGURE 4.16. Schematic representation of the proof of (4.25). In the second equality we use the schematic representation of $\text{KIIMap}_{\mathring{\mathcal{A}}^\wedge, k, +-}^2$ from Figure 4.2.

In Figure 4.17 we show a schematic proof of (4.26), where in the second equality we use the compatibility of the doubling map $\text{dbl}_1 : \mathring{\mathcal{A}}^\wedge(\downarrow\uparrow) \rightarrow \mathring{\mathcal{A}}^\wedge(\downarrow\downarrow\uparrow\uparrow)$ with the composition in $\mathring{\mathcal{A}}^\wedge(\downarrow\uparrow)$. \square

Lemma 4.17. Let P be the oriented Brauer diagram $(\text{Id}_+ \otimes \text{cup}_{+-} \otimes \text{Id}_-) \circ \text{cup}_{+-}$. Consider the action of $\mathring{\mathcal{A}}^\wedge(\downarrow\uparrow\uparrow\uparrow)_0$ on $\mathring{\mathcal{A}}^\wedge(P)_0$ given by composition. Let $\gamma \in \mathring{\mathcal{A}}^\wedge(\downarrow\uparrow\uparrow\uparrow)_0$ be the element

$$\gamma = \begin{array}{c} \downarrow \downarrow \downarrow \\ \downarrow \downarrow \downarrow \\ \downarrow \downarrow \downarrow \\ \downarrow \downarrow \downarrow \end{array} \begin{array}{c} \uparrow \uparrow \\ \uparrow \uparrow \\ \uparrow \uparrow \\ \uparrow \uparrow \end{array} - \begin{array}{c} \downarrow \downarrow \downarrow \\ \downarrow \downarrow \downarrow \\ \downarrow \downarrow \downarrow \\ \downarrow \downarrow \downarrow \end{array} \begin{array}{c} \uparrow \uparrow \\ \uparrow \uparrow \\ \uparrow \uparrow \\ \uparrow \uparrow \end{array} = \begin{array}{c} \downarrow \downarrow \downarrow \uparrow \uparrow \\ \downarrow \downarrow \downarrow \uparrow \uparrow \\ \downarrow \downarrow \downarrow \uparrow \uparrow \\ \downarrow \downarrow \downarrow \uparrow \uparrow \end{array} + \begin{array}{c} \downarrow \downarrow \downarrow \uparrow \uparrow \\ \downarrow \downarrow \downarrow \uparrow \uparrow \\ \downarrow \downarrow \downarrow \uparrow \uparrow \\ \downarrow \downarrow \downarrow \uparrow \uparrow \end{array} - \begin{array}{c} \downarrow \downarrow \downarrow \uparrow \uparrow \\ \downarrow \downarrow \downarrow \uparrow \uparrow \\ \downarrow \downarrow \downarrow \uparrow \uparrow \\ \downarrow \downarrow \downarrow \uparrow \uparrow \end{array} - \begin{array}{c} \downarrow \downarrow \downarrow \uparrow \uparrow \\ \downarrow \downarrow \downarrow \uparrow \uparrow \\ \downarrow \downarrow \downarrow \uparrow \uparrow \\ \downarrow \downarrow \downarrow \uparrow \uparrow \end{array}$$

then $\gamma \cdot m = 0$ for any $m \in \mathring{\mathcal{A}}^\wedge(P)_0$.

Proof. Let $m \in \mathring{\mathcal{A}}^\wedge(P)_0$, which we represent with a grey-colored box labelled with m over the schematic representation of the oriented Brauer P . Then we have

$$\gamma \cdot m = \begin{array}{c} \downarrow \downarrow \downarrow \uparrow \uparrow \\ \downarrow \downarrow \downarrow \uparrow \uparrow \\ \downarrow \downarrow \downarrow \uparrow \uparrow \\ \downarrow \downarrow \downarrow \uparrow \uparrow \end{array} \begin{array}{c} \uparrow \uparrow \\ \uparrow \uparrow \\ \uparrow \uparrow \\ \uparrow \uparrow \end{array} - \begin{array}{c} \downarrow \downarrow \downarrow \uparrow \uparrow \\ \downarrow \downarrow \downarrow \uparrow \uparrow \\ \downarrow \downarrow \downarrow \uparrow \uparrow \\ \downarrow \downarrow \downarrow \uparrow \uparrow \end{array} \begin{array}{c} \uparrow \uparrow \\ \uparrow \uparrow \\ \uparrow \uparrow \\ \uparrow \uparrow \end{array} = \begin{array}{c} \downarrow \downarrow \downarrow \uparrow \uparrow \\ \downarrow \downarrow \downarrow \uparrow \uparrow \\ \downarrow \downarrow \downarrow \uparrow \uparrow \\ \downarrow \downarrow \downarrow \uparrow \uparrow \end{array} \begin{array}{c} \uparrow \uparrow \\ \uparrow \uparrow \\ \uparrow \uparrow \\ \uparrow \uparrow \end{array} - \begin{array}{c} \downarrow \downarrow \downarrow \uparrow \uparrow \\ \downarrow \downarrow \downarrow \uparrow \uparrow \\ \downarrow \downarrow \downarrow \uparrow \uparrow \\ \downarrow \downarrow \downarrow \uparrow \uparrow \end{array} \begin{array}{c} \uparrow \uparrow \\ \uparrow \uparrow \\ \uparrow \uparrow \\ \uparrow \uparrow \end{array}$$

In the second equality we have used Lemma 3.47. Besides, we have

$$\begin{array}{c} \downarrow \downarrow \downarrow \uparrow \uparrow \\ \downarrow \downarrow \downarrow \uparrow \uparrow \\ \downarrow \downarrow \downarrow \uparrow \uparrow \\ \downarrow \downarrow \downarrow \uparrow \uparrow \end{array} - \begin{array}{c} \downarrow \downarrow \downarrow \uparrow \uparrow \\ \downarrow \downarrow \downarrow \uparrow \uparrow \\ \downarrow \downarrow \downarrow \uparrow \uparrow \\ \downarrow \downarrow \downarrow \uparrow \uparrow \end{array} = \begin{array}{c} \downarrow \downarrow \downarrow \uparrow \uparrow \\ \downarrow \downarrow \downarrow \uparrow \uparrow \\ \downarrow \downarrow \downarrow \uparrow \uparrow \\ \downarrow \downarrow \downarrow \uparrow \uparrow \end{array} + \begin{array}{c} \downarrow \downarrow \downarrow \uparrow \uparrow \\ \downarrow \downarrow \downarrow \uparrow \uparrow \\ \downarrow \downarrow \downarrow \uparrow \uparrow \\ \downarrow \downarrow \downarrow \uparrow \uparrow \end{array} - \begin{array}{c} \downarrow \downarrow \downarrow \uparrow \uparrow \\ \downarrow \downarrow \downarrow \uparrow \uparrow \\ \downarrow \downarrow \downarrow \uparrow \uparrow \\ \downarrow \downarrow \downarrow \uparrow \uparrow \end{array} - \begin{array}{c} \downarrow \downarrow \downarrow \uparrow \uparrow \\ \downarrow \downarrow \downarrow \uparrow \uparrow \\ \downarrow \downarrow \downarrow \uparrow \uparrow \\ \downarrow \downarrow \downarrow \uparrow \uparrow \end{array} = - \begin{array}{c} \downarrow \downarrow \downarrow \uparrow \uparrow \\ \downarrow \downarrow \downarrow \uparrow \uparrow \\ \downarrow \downarrow \downarrow \uparrow \uparrow \\ \downarrow \downarrow \downarrow \uparrow \uparrow \end{array} - \begin{array}{c} \downarrow \downarrow \downarrow \uparrow \uparrow \\ \downarrow \downarrow \downarrow \uparrow \uparrow \\ \downarrow \downarrow \downarrow \uparrow \uparrow \\ \downarrow \downarrow \downarrow \uparrow \uparrow \end{array} = 0.$$

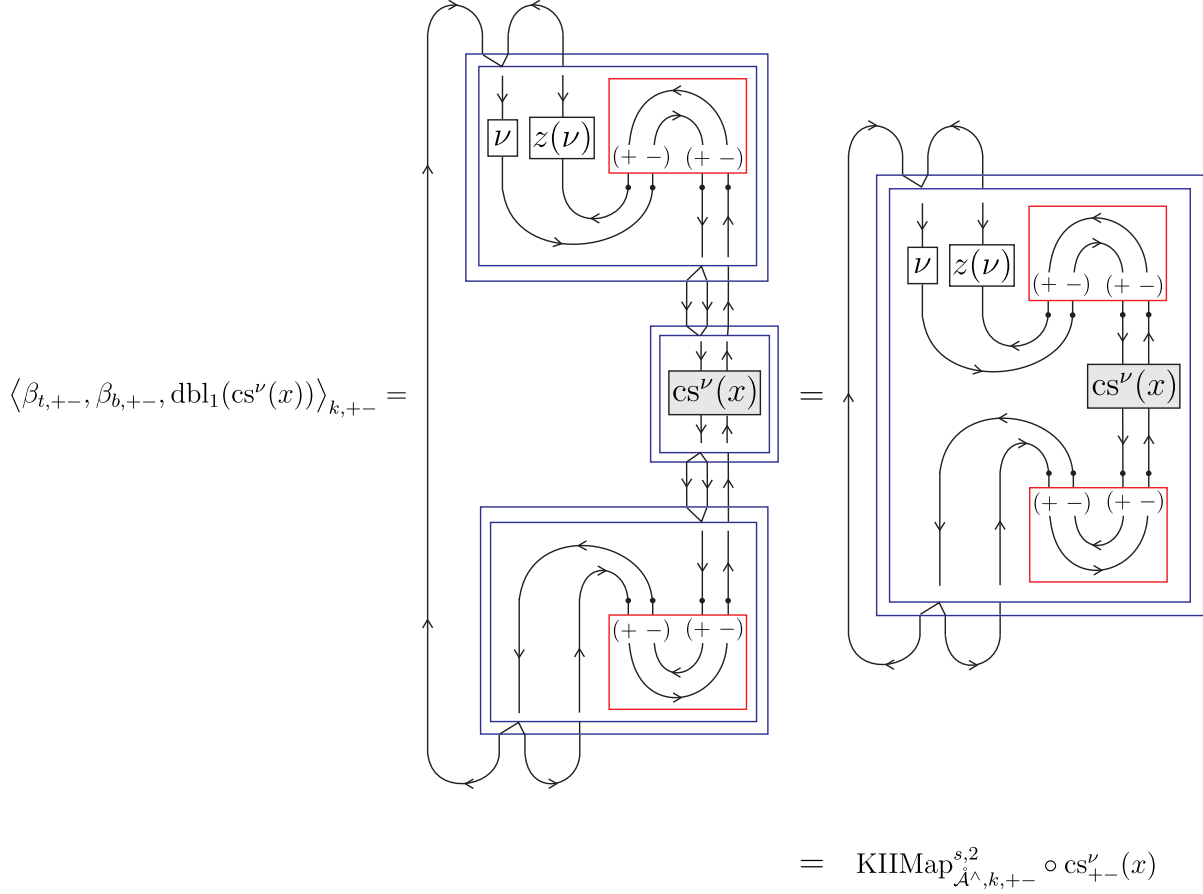

FIGURE 4.17. Schematic representation of the proof of (4.26).

In the second equality we have used a STU relation in the first \downarrow involving the first and third term and a STU relation in the second \downarrow involving the second and fourth term. Last equality follows by the AS relation. Therefore, $\gamma \cdot m = 0$. \square

Notice that the linear maps $\text{co}_3 : \mathring{A}^{\wedge}(\downarrow\downarrow\downarrow)_0 \rightarrow \mathring{A}^{\wedge}(\downarrow\downarrow\uparrow)_0$ and $\text{dbl}_3 : \mathring{A}^{\wedge}(\downarrow\downarrow\uparrow)_0 \rightarrow \mathring{A}^{\wedge}(\downarrow\downarrow\uparrow\uparrow)_0$ are algebra morphisms. Therefore, the composition map

$$(4.29) \quad \delta := \text{dbl}_3 \circ \text{co}_3 \circ \text{can} : \mathbb{C}\langle\langle A, B \rangle\rangle \longrightarrow \mathring{A}^{\wedge}(\downarrow\downarrow\uparrow\uparrow)$$

is also an algebra morphism, where $\text{can} : \mathbb{C}\langle\langle A, B \rangle\rangle \rightarrow \mathring{A}^{\wedge}(\downarrow\downarrow\downarrow)_0$ is the algebra morphism given in (3.16). Explicitly, the morphism δ is given by

$$A \longmapsto \begin{array}{c} \vdots \\ \downarrow \\ \vdots \\ \downarrow \\ \vdots \end{array} \begin{array}{c} \uparrow \\ \vdots \\ \uparrow \\ \vdots \\ \uparrow \end{array} \quad \text{and} \quad B \longmapsto - \begin{array}{c} \vdots \\ \downarrow \\ \vdots \\ \downarrow \\ \vdots \end{array} \begin{array}{c} \uparrow \\ \vdots \\ \uparrow \\ \vdots \\ \uparrow \end{array} - \begin{array}{c} \vdots \\ \downarrow \\ \vdots \\ \downarrow \\ \vdots \end{array} \begin{array}{c} \uparrow \\ \vdots \\ \uparrow \\ \vdots \\ \uparrow \end{array}.$$

Corollary 4.18. *Let P be as in Lemma 4.17. Then for any $x \in \mathbb{C}\langle\langle A, B \rangle\rangle[A, B]\mathbb{C}\langle\langle A, B \rangle\rangle$ and any $m \in \mathring{A}^{\wedge}(P)_0$ we have $\delta(x) \cdot m = 0$.*

Proof. Notice that $\delta([A, B]) = \gamma$, where γ is the element described in Lemma 4.17. Therefore, by this lemma, $\delta([A, B]) \cdot m = 0$ for any $m \in \mathring{A}^{\wedge}(P)_0$, therefore $[A, B] \in \ker(\delta)$. Since δ is an algebra morphism, its kernel is a two-sided ideal, therefore it contains $\mathbb{C}\langle\langle A, B \rangle\rangle[A, B]\mathbb{C}\langle\langle A, B \rangle\rangle$. \square

Corollary 4.19. *Let P be as in Lemma 4.17. Then for any $m \in \mathring{\mathcal{A}}^\wedge(P)_0$ we have*

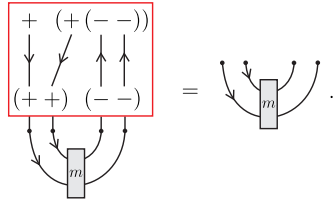

Here we are using Convention 3.38 and represent m as in the proof of Lemma 4.17.

Proof. By definition of $Z_{\mathcal{A}}$, the left-hand side is given by

$$(4.30) \quad \text{LHS} = (\text{dbl}_3 \circ \text{co}_3(\Phi)) \circ m = (\text{dbl}_3 \circ \text{co}_3 \circ \text{can}(\varphi(A, B))) \circ m = \delta(\varphi(A, B)) \cdot m,$$

where δ is the algebra morphism (4.29). Besides, we can write the even Drinfeld associator $\varphi(A, B)$ as

$$\varphi(A, B) = 1 + \theta(A, B)$$

with $\theta(A, B) \in \mathbb{C}\langle\langle A, B \rangle\rangle[A, B]\mathbb{C}\langle\langle A, B \rangle\rangle$. Replacing in (4.30) and using Corollary 4.18, we have

$$\text{LHS} = \delta(1 + \theta(A, B)) \cdot m = m = \text{RHS}.$$

□

Lemma 4.20. *We have*

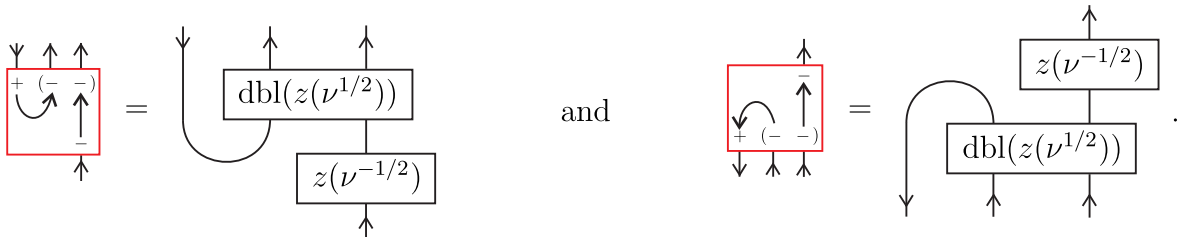

where $z : \mathring{\mathcal{A}}^\wedge(\downarrow) \rightarrow \mathring{\mathcal{A}}^\wedge(\uparrow)$ is the map given in (3.43). We have similar identities obtained by changing all the orientations and replacing $z(\nu^{\pm 1/2})$ with $\nu^{\pm 1/2}$.

Proof. Let us prove the first identity. Using the definition of $Z_{\mathcal{A}}$ and its compatibility with composition and tensor product, we have

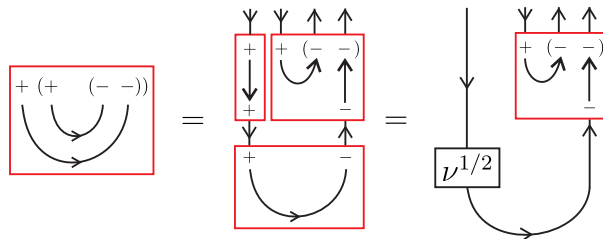

Besides

In the first and second equalities we have used the definition of $Z_{\mathcal{A}}$, its compatibility with the composition, tensor product and doubling operation, see Theorem 3.37. The third equality follows from Corollary 4.19.

Thus

Therefore

The second identity can be proved similarly. □

Lemma 4.21. *Let*

$$u_{+-} = (\text{Id}_-)_A \otimes_{\mathcal{A}} (\text{dbl}(\nu^{-1/2}) \circ_{\mathcal{A}} (\nu^{1/2} \otimes_{\mathcal{A}} (\text{Id}_+)_A)) \otimes_{\mathcal{A}} (\text{Id}_-)_A \in \mathring{\mathcal{A}}^{\wedge}(\uparrow\downarrow\uparrow)$$

and

$$u_{-+} = (\text{Id}_+)_A \otimes_{\mathcal{A}} (\text{dbl}(z(\nu^{-1/2})) \circ_{\mathcal{A}} (z(\nu^{1/2}) \otimes_{\mathcal{A}} (\text{Id}_-)_A)) \otimes_{\mathcal{A}} (\text{Id}_+)_A \in \mathring{\mathcal{A}}^{\wedge}(\downarrow\uparrow\downarrow).$$

Then

$$(4.31) \quad \alpha_{t,+} = \beta_{t,+} \circ_{\mathcal{A}} u_{+-}, \quad \alpha_{b,+} = u_{+-}^{-1} \circ_{\mathcal{A}} \beta_{b,+}$$

and

$$(4.32) \quad \alpha_{t,-} = \beta_{t,-} \circ_{\mathcal{A}} u_{-+}, \quad \alpha_{b,-} = u_{-+}^{-1} \circ_{\mathcal{A}} \beta_{b,-}$$

Proof. Let us prove the two identities from (4.31), those ones in (4.32) are proved similarly. In Figure 4.18 we show the identity $\beta_{t,k,+} = \alpha_{t,k,+} \circ_{\mathcal{A}} (u_{+-})^{-1}$. We use: the compatibility of the doubling map with the composition and tensor product in the second equality; Lemma 3.40 in third equality; Lemma 3.45 in the fourth equality; Lemmas 3.45 and 3.46 in the fifth equality and Lemma 4.20 in the sixth equality.

Let us now prove the second identity in (4.31). Using the compatibility of the doubling map with the composition and tensor product and Lemma 3.40, we get the equalities shown in Figure 4.19.

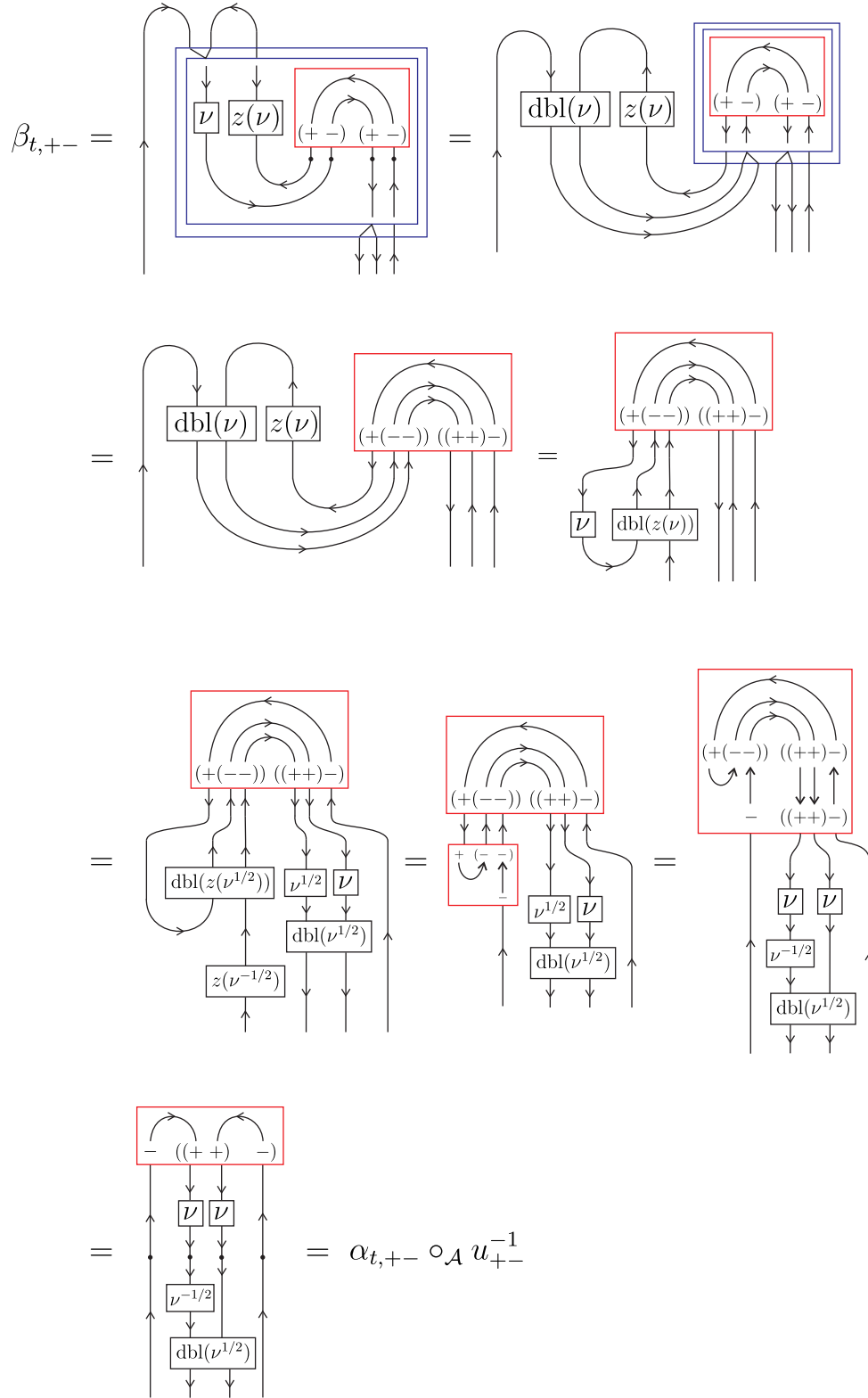
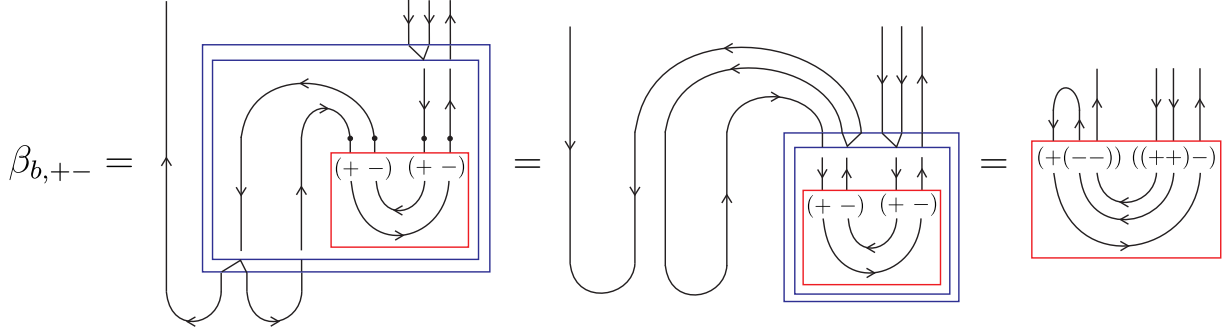
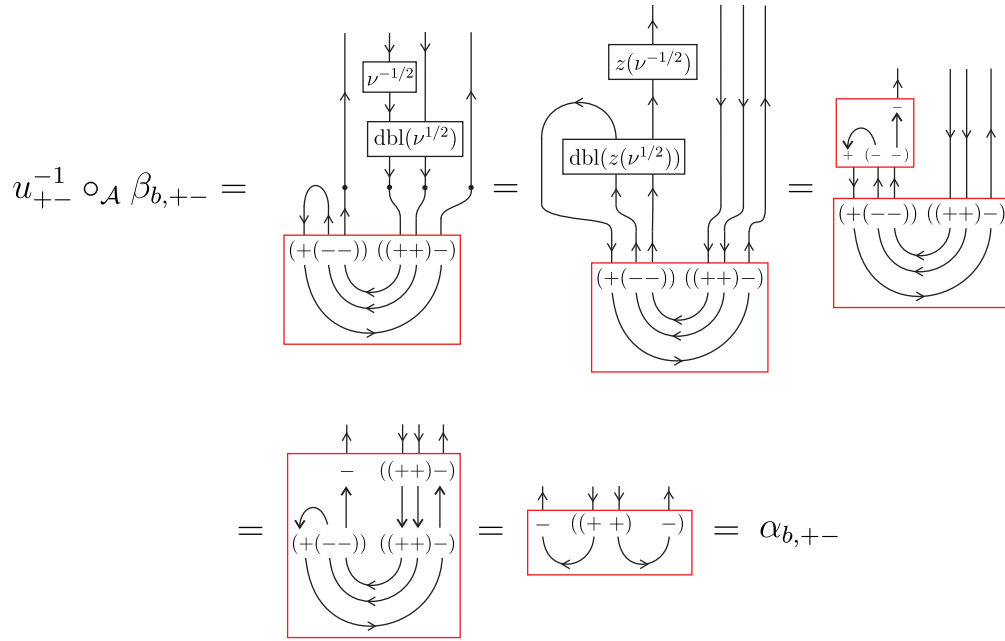

FIGURE 4.18. Proof of the equality $\beta_{t,+} = \alpha_{t,+} \circ_{\mathcal{A}} u_{+-}^{-1}$ from Lemma 4.21.

Using the identity from Figure 4.19, we show in Figure 4.20 the equality $u_{+-}^{-1} \circ_{\mathcal{A}} \beta_{b,+} = \alpha_{t,+}$. We use: Lemmas 3.45 and 3.46 in the second equality; Lemma 4.20 in the third equality and the compatibility of $Z_{\mathcal{A}}$ with tensor product and composition in the fourth equality.

FIGURE 4.19. Some equivalent expressions of $\beta_{b,+}$.FIGURE 4.20. Proof of the equality $u_{+-}^{-1} \circ_{\mathcal{A}} \beta_{b,+} = \alpha_{b,+}$ from Lemma 4.21.

□

Proposition 4.22. *Let $k \in \mathbb{Z}_{\geq 2}$. The diagram*

$$(4.33) \quad \begin{array}{ccc} \mathring{\mathcal{A}}^\wedge(\downarrow\uparrow)_{k-2} & \xrightarrow{\text{KIIMap}_{\mathring{\mathcal{A}}^\wedge, k, +-}^2} & \mathring{\mathcal{A}}_k^\wedge \\ \text{cs}_{+-}^\nu \downarrow & & \downarrow \text{cs}^\nu \\ \mathring{\mathcal{A}}^\wedge(\downarrow\uparrow)_{k-2} & \xrightarrow{\text{KIIMap}_{\mathring{\mathcal{A}}^\wedge, k, +-}^{s, 2}} & \mathring{\mathcal{A}}_k^\wedge \end{array} .$$

commutes, where the maps cs_{+-}^ν and cs^ν are given in (4.12) and (4.2) respectively. We also have a similar commutative diagram involving the space $\mathring{\mathcal{A}}^\wedge(\downarrow\uparrow)_{k-2}$ and the $-+$ versions of the stated maps.

Proof. Let $x \in \mathring{\mathcal{A}}^\wedge(\downarrow\uparrow)_{k-2}$, then

$$\begin{aligned} \text{cs}^\nu \circ \text{KIIMap}_{\mathring{\mathcal{A}}^\wedge, k, +-}^2(x) &= \langle \alpha_{t, +-}, \alpha_{b, +-}, \text{dbl}_1(\text{cs}^\nu(x)) \rangle_{k, +-} \\ &= \langle \beta_{t, +-} \circ_{\mathcal{A}} u_{+-}, u_{+-}^{-1} \circ_{\mathcal{A}} \beta_{b, +-}, \text{dbl}_1(\text{cs}^\nu(x)) \rangle_{k, +-} \\ &= \langle \beta_{t, +-}, \beta_{b, +-}, \text{dbl}_1(\text{cs}^\nu(x)) \rangle_{k, +-} \\ &= \text{KIIMap}_{\mathring{\mathcal{A}}^\wedge, k, +-}^{s, 2} \circ \text{cs}_{+-}^\nu(x). \end{aligned}$$

We have used equation (4.25) from Lemma 4.16 in the first equality, Lemma 4.21 in the second equality, Lemma 4.15 in the third equality and equation (4.26) from Lemma 4.16 in the last equality. \square

Corollary 4.23. *Let $k \in \mathbb{Z}_{\geq 2}$. The diagram*

$$(4.34) \quad \begin{array}{ccc} \mathring{\mathcal{A}}^\wedge(\downarrow\uparrow)_{k-2} & \xrightarrow{\text{KIIMap}_{\mathring{\mathcal{A}}^\wedge, k, +-}^2 - \text{KIIMap}_{\mathring{\mathcal{A}}^\wedge, k, +-}^1} & \mathring{\mathcal{A}}_k^\wedge \\ \text{cs}_{+-}^\nu \downarrow & & \downarrow \text{cs}^\nu \\ \mathring{\mathcal{A}}^\wedge(\downarrow\uparrow)_{k-2} & \xrightarrow{\text{KIIMap}_{\mathring{\mathcal{A}}^\wedge, k, +-}^{s, 2} - \text{KIIMap}_{\mathring{\mathcal{A}}^\wedge, k, +-}^{s, 1}} & \mathring{\mathcal{A}}_k^\wedge \end{array} .$$

commutes, where the maps cs_{+-}^ν and cs^ν are given in (4.12) and (4.2) respectively. We also have a similar commutative diagram involving the space $\mathring{\mathcal{A}}^\wedge(\uparrow\downarrow)_{k-2}$ and the $-+$ versions of the stated maps.

Proof. The result follows directly from Lemma 4.13 and Proposition 4.22. \square

Corollary 4.24. *The algebra automorphism cs^ν of $\bigoplus_{k \geq 0} \mathring{\mathcal{A}}_k^\wedge$ is such that $\text{cs}^\nu((\text{KII}\mathring{\mathcal{A}}^\wedge)) = (\text{KII}^s \mathring{\mathcal{A}}^\wedge)$.*

Proof. The result follows from Corollary 4.23, from the fact that the maps cs_{+-}^ν and cs^ν are bijective (Lemma 4.10 and Lemma 4.2(e)) and from the definitions of $(\text{KII}\mathring{\mathcal{A}}^\wedge)$, $\text{KII}^s \mathring{\mathcal{A}}^\wedge$ (see (4.3) and (4.7)). \square

4.2.5. *The equality $\text{cs}^\nu((\text{CO}\mathring{\mathcal{A}}^\wedge)) = (\text{CO}\mathring{\mathcal{A}}^\wedge)$.*

Lemma 4.25. *The algebra automorphism $\text{cs}^\nu = \bigoplus_{k \geq 0} \text{cs}_{\vec{\emptyset}, k}^\nu$ of $\bigoplus_{k \geq 0} \mathring{\mathcal{A}}_k^\wedge$ is such that $\text{cs}^\nu((\text{CO}\mathring{\mathcal{A}}^\wedge)) = (\text{CO}\mathring{\mathcal{A}}^\wedge)$.*

Proof. Let $k \geq 0$ be an integer and let us identify $\text{Cir}(\text{cup}^k, \text{cap}^k)$ with the set $\llbracket 1, k \rrbracket$ by associating increasing numbers from the innermost circle to the outermost circle in $\text{cap}^k \circ \text{cup}^k$ and, by simplicity, continue to denote by clos_k the composite map $\mathring{\mathcal{A}}^\wedge(\downarrow^k, \emptyset) \xrightarrow{\text{clos}_k} \mathring{\mathcal{A}}^\wedge(\vec{\emptyset}, \text{Cir}(\text{cup}^k, \text{cap}^k)) \simeq \mathring{\mathcal{A}}^\wedge(\vec{\emptyset}, \llbracket 1, k \rrbracket)$.

Consider the diagram (4.35).

$$(4.35) \quad \begin{array}{ccccc} \mathring{\mathcal{A}}^\wedge(\vec{\emptyset}, \llbracket 1, k \rrbracket) & \xrightarrow{\tilde{\text{cs}}_{\vec{\emptyset}, \llbracket 1, k \rrbracket}^\nu} & \mathring{\mathcal{A}}^\wedge(\vec{\emptyset}, \llbracket 1, k \rrbracket) & & \\ & \swarrow \text{clos}_k & & \searrow \text{clos}_k & \\ & \mathring{\mathcal{A}}^\wedge(\downarrow^k, \emptyset) & \xrightarrow{\bullet \circ_{\mathcal{A}} \nu^{\otimes k}} & \mathring{\mathcal{A}}^\wedge(\downarrow^k, \emptyset) & \\ \text{co}^{\mathcal{A}}(\vec{\emptyset}, (\llbracket 1, k \rrbracket, 1)) \downarrow & \text{co}^{\mathcal{A}}((\downarrow^k, \downarrow_1), \emptyset) \downarrow & & \downarrow \text{co}^{\mathcal{A}}((\downarrow^k, \downarrow_1), \emptyset) & \downarrow \text{co}^{\mathcal{A}}(\vec{\emptyset}, (\llbracket 1, k \rrbracket, 1)) \\ & \mathring{\mathcal{A}}^\wedge(\uparrow\downarrow^{k-1}, \emptyset) & \xrightarrow{a} & \mathring{\mathcal{A}}^\wedge(\uparrow\downarrow^{k-1}, \emptyset) & \\ & \swarrow \widetilde{\text{clos}}_k & & \searrow \widetilde{\text{clos}}_k & \\ \mathring{\mathcal{A}}^\wedge(\vec{\emptyset}, \llbracket 1, k \rrbracket) & \xrightarrow{\tilde{\text{cs}}_{\vec{\emptyset}, \llbracket 1, k \rrbracket}^\nu} & \mathring{\mathcal{A}}^\wedge(\vec{\emptyset}, \llbracket 1, k \rrbracket) & & \end{array}$$

where $a(y) := y \circ_{\mathcal{A}} (z(\nu) \otimes_{\mathcal{A}} \nu^{\otimes k-1})$ for any $y \in \mathring{\mathcal{A}}^\wedge(\uparrow\downarrow^{k-1}, \emptyset)$ and $\text{co}^{\mathcal{A}}((\downarrow^k, \downarrow_1), \emptyset) : \mathring{\mathcal{A}}^\wedge(\downarrow^k, \emptyset) \rightarrow \mathring{\mathcal{A}}^\wedge(\uparrow\downarrow^{k-1}, \emptyset)$ is as in Lemma 3.33 (the subindexed arrow \downarrow_1 indicates the first arrow, from left to right, in \downarrow^k).

The map $\widetilde{\text{clos}}_k : \mathring{\mathcal{A}}^\wedge(\uparrow\downarrow^{k-1}, \emptyset) \rightarrow \mathring{\mathcal{A}}^\wedge(\vec{\emptyset}, \llbracket 1, k \rrbracket)$ is defined as the composition of clos_k with the map $\zeta : \mathring{\mathcal{A}}(\uparrow\downarrow^{k-1}, \emptyset) \rightarrow \mathring{\mathcal{A}}(\downarrow^k, \emptyset)$ given by

$$x \xrightarrow{\zeta} (\text{Id}_+^{\mathcal{A}} \otimes_{\mathcal{A}} (\text{cap}_{+-})_{\mathcal{A}} \otimes_{\mathcal{A}} \text{Id}_{+ \otimes k-1}^{\mathcal{A}}) \circ_{\mathcal{A}} ((\tau_{++})_{\mathcal{A}} \otimes_{\mathcal{A}} x) \circ_{\mathcal{A}} (\text{Id}_+^{\mathcal{A}} \otimes_{\mathcal{A}} (\text{cup}_{+-})_{\mathcal{A}} \otimes_{\mathcal{A}} \text{Id}_{+ \otimes k-1}^{\mathcal{A}})$$

for any $x \in \mathring{\mathcal{A}}(\uparrow\downarrow^{k-1}, \emptyset)$, where cap_{+-} , cup_{+-} and τ_{++} are the oriented Brauer diagrams as in Definition 3.42, and the notation $(P)_{\mathcal{A}}$, for an oriented Brauer diagram P , is as in Definition 3.11.

The top square in diagram (4.35) is commutative by definition of the map $\widetilde{\text{cs}}_{\vec{\emptyset}, \llbracket 1, k \rrbracket}^{\nu}$, see Lemma 4.2(a). The bottom square in (4.35) can be decomposed as shown in diagram (4.36).

$$(4.36) \quad \begin{array}{ccccc} \mathring{\mathcal{A}}^\wedge(\uparrow\downarrow^{k-1}, \emptyset) & \xrightarrow{a} & \mathring{\mathcal{A}}^\wedge(\uparrow\downarrow^{k-1}, \emptyset) & & \\ \downarrow \widetilde{\text{clos}}_k & \searrow \zeta & & \swarrow \zeta & \downarrow \widetilde{\text{clos}}_k \\ & \mathring{\mathcal{A}}^\wedge(\downarrow^k, \emptyset) & \xrightarrow{\bullet \circ_{\mathcal{A}} \nu^{\otimes k}} & \mathring{\mathcal{A}}^\wedge(\downarrow^k, \emptyset) & \\ & \swarrow \text{clos}_k & & \searrow \text{clos}_k & \\ \mathring{\mathcal{A}}^\wedge(\vec{\emptyset}, \llbracket 1, k \rrbracket) & \xrightarrow{\widetilde{\text{cs}}_{\vec{\emptyset}, \llbracket 1, k \rrbracket}^{\nu}} & \mathring{\mathcal{A}}^\wedge(\vec{\emptyset}, \llbracket 1, k \rrbracket) & & \end{array}$$

The bottom square in (4.36) is commutative by definition of $\widetilde{\text{cs}}_{\vec{\emptyset}, \llbracket 1, k \rrbracket}^{\nu}$, see Lemma 4.2(a). The triangles on the left and right in (4.36) are the same diagram and it commutes by definition. The top square in (4.36) commutes by Lemmas 3.45 and 3.46. Therefore, the outer square in (4.36), which is the bottom square in (4.35), is commutative.

The left and right squares in (4.35) are identical diagrams. Their commutativity is a consequence of that of the diagram

$$(4.37) \quad \begin{array}{ccc} \mathbb{C}\mathring{\text{Jac}}(\downarrow^k, \emptyset) & \xrightarrow{\text{clos}_k^{\text{Jac}}} & \mathbb{C}\mathring{\text{Jac}}(\vec{\emptyset}, \llbracket 1, k \rrbracket) \\ \downarrow \text{co}^{\text{Jac}}(\downarrow^k, \downarrow_1, \emptyset) & & \downarrow \text{co}^{\text{Jac}}(\vec{\emptyset}, \llbracket 1, k \rrbracket, 1) \\ \mathbb{C}\mathring{\text{Jac}}(\uparrow\downarrow^{k-1}, \emptyset) & \xrightarrow{\widetilde{\text{clos}}_k^{\text{Jac}}} & \mathbb{C}\mathring{\text{Jac}}(\vec{\emptyset}, \llbracket 1, k \rrbracket) \end{array}$$

where $\text{clos}_k^{\text{Jac}}$, $\widetilde{\text{clos}}_k^{\text{Jac}}$ are the obvious lifts of their $\mathring{\mathcal{A}}^\wedge$ -counterparts. Commutativity of (4.37) follows from the commutativity of the following diagram

$$\begin{array}{ccc} \mathbb{Z}L & \xrightarrow{f} & \mathbb{Z}C \\ \text{co}^L \downarrow & & \downarrow \text{co}^C \\ \mathbb{Z}L & \xrightarrow{f} & \mathbb{Z}C \end{array}$$

where L (resp. C) is the set of classes of tuples $(X, f, \{\text{lin}_i\}_{i \in \llbracket 1, k \rrbracket})$ (resp. $(X, f, \{\text{cyc}_i\}_{i \in \llbracket 1, k \rrbracket})$) where X is a finite set, $f : X \rightarrow \llbracket 1, k \rrbracket$ is a map, and for any $i \in \llbracket 1, k \rrbracket$, lin_i (resp. cyc_i) is a linear (resp. cyclic) order on $f^{-1}(i)$. The linear map $f : \mathbb{Z}L \rightarrow \mathbb{Z}C$ is induced by the set map $L \rightarrow C$ defined on representatives of classes by $(X, f, \{\text{lin}_i\}_{i \in \llbracket 1, k \rrbracket}) \mapsto (X, f, \{\text{cyc}(\text{lin}_i)\}_{i \in \llbracket 1, k \rrbracket})$ where $\text{cyc}(\text{lin})$ is the cyclic order associated to a linear order lin . The map $\text{co}^L : \mathbb{Z}L \rightarrow \mathbb{Z}L$ (resp. $\text{co}^C : \mathbb{Z}C \rightarrow \mathbb{Z}C$) is induced by the association $(X, f, \{\text{lin}_i\}_{i \in \llbracket 1, k \rrbracket}) \mapsto (-1)^{|f^{-1}(1)|} (X, f, \{\widetilde{\text{lin}}_1, \text{lin}_2, \dots, \text{lin}_k\})$ where $\widetilde{\text{lin}}$ denotes the linear order opposite to the linear order lin (resp. $(X, f, \{\text{cyc}_i\}_{i \in \llbracket 1, k \rrbracket}) \mapsto (-1)^{|f^{-1}(1)|} (X, f, \{\widetilde{\text{cyc}}_1, \text{cyc}_2, \dots, \text{cyc}_k\})$ where $\widetilde{\text{cyc}}$ is the cyclic order opposite to the cyclic order cyc).

Let us show the commutativity of the inner square. We can check that for any $x, y \in \mathring{\mathcal{A}}^\wedge(\downarrow^k, \emptyset)$ we have

$$(4.38) \quad \text{co}^{\mathcal{A}}(\downarrow^k, \downarrow_1, \emptyset)(x \circ_{\mathcal{A}} y) = \text{co}^{\mathcal{A}}(\downarrow^k, \downarrow_1, \emptyset)(x) \circ_{\mathcal{A}} \text{co}^{\mathcal{A}}(\downarrow^k, \downarrow_1, \emptyset)(y).$$

Besides, all the terms appearing in the invertible element $\nu \in \mathring{\mathcal{A}}^\wedge(\downarrow)$ (see §3.8.2) have an even number of univalent vertices attached to \downarrow (see [10] for an explicit formula for ν). Therefore, $\text{co}^{\mathcal{A}}((\downarrow^k, \downarrow_1), \emptyset)(\nu^{\otimes k}) = z(\nu) \otimes_{\mathcal{A}} \nu^{\otimes k-1}$. Using this and (4.38) we obtain

$$\text{co}^{\mathcal{A}}((\downarrow^k, \downarrow_1), \emptyset)(x \circ_{\mathcal{A}} \nu^{\otimes k}) = \text{co}^{\mathcal{A}}((\downarrow^k, \downarrow_1), \emptyset)(x) \circ_{\mathcal{A}} (z(\nu) \otimes_{\mathcal{A}} \nu^{\otimes k-1}),$$

for any $x \in \mathring{\mathcal{A}}^\wedge(\downarrow^k, \emptyset)$, which is precisely the stated commutativity.

We then have that the external square diagram of (4.35) is commutative. The square diagram obtained from the external square diagram of (4.35) by replacing the vertical maps by the identity is also trivially commutative. Both diagrams are compatible with commutative group diagram

$$\begin{array}{ccc} \mathfrak{S}_{k-1} & \xrightarrow{\text{Id}} & \mathfrak{S}_{k-1} \\ \downarrow & & \downarrow \\ \mathfrak{S}_k & \xrightarrow{\text{Id}} & \mathfrak{S}_k \end{array}$$

where the vertical arrows are induced by the obvious identification $\llbracket 1, k-1 \rrbracket \simeq \llbracket 2, k \rrbracket \subset \llbracket 1, k \rrbracket$. This result in two commutative diagrams in \mathcal{VecGp} . Applying the coinvariant space functor (see Lemma 2.96) to these commutative diagrams, we obtain that the two diagrams in (4.39) are commutative.

(4.39)

$$\begin{array}{ccc} \mathring{\mathcal{A}}^\wedge(\vec{\emptyset}, \llbracket 1, k \rrbracket)_{\mathfrak{S}_{k-1}} & \xrightarrow{\text{cs}_{\vec{\emptyset}, 1, k-1}^\nu} & \mathring{\mathcal{A}}^\wedge(\vec{\emptyset}, \llbracket 1, k \rrbracket)_{\mathfrak{S}_{k-1}} & \mathring{\mathcal{A}}^\wedge(\vec{\emptyset}, \llbracket 1, k \rrbracket)_{\mathfrak{S}_{k-1}} & \xrightarrow{\text{cs}_{\vec{\emptyset}, 1, k-1}^\nu} & \mathring{\mathcal{A}}^\wedge(\vec{\emptyset}, \llbracket 1, k \rrbracket)_{\mathfrak{S}_{k-1}} \\ \text{proj}_{1, k-1}^{\mathcal{A}} \downarrow & & \downarrow \text{proj}_{1, k-1}^{\mathcal{A}} & \text{co}_k^{\mathcal{A}} \downarrow & & \downarrow \text{co}_k^{\mathcal{A}} \\ \mathring{\mathcal{A}}_k^\wedge & \xrightarrow{\text{cs}_{\vec{\emptyset}, k}^\nu} & \mathring{\mathcal{A}}_k^\wedge & \mathring{\mathcal{A}}_k^\wedge & \xrightarrow{\text{cs}_{\vec{\emptyset}, k}^\nu} & \mathring{\mathcal{A}}_k^\wedge \end{array}$$

where the endomorphism $\text{cs}_{\vec{\emptyset}, 1, k-1}^\nu$ of $\mathring{\mathcal{A}}^\wedge(\vec{\emptyset}, \llbracket 1, k \rrbracket)_{\mathfrak{S}_{k-1}}$ is defined to be the image by the coinvariant space functor of the endomorphism $\tilde{\text{cs}}_{\vec{\emptyset}, \llbracket 1, k \rrbracket}^\nu$ of $\mathring{\mathcal{A}}^\wedge(\vec{\emptyset}, \llbracket 1, k \rrbracket)$ equipped with the action of \mathfrak{S}_{k-1} . This implies that the diagram obtained from the diagrams in (4.39) by replacing the vertical maps by $\text{co}_k^{\mathcal{A}} - \text{proj}_{1, k-1}^{\mathcal{A}}$ and $\text{co}_k^{\mathcal{A}} - \text{proj}_{1, k-1}^{\mathcal{A}}$ is commutative. Since $(\text{CO}\mathring{\mathcal{A}}_k^\wedge) = \text{Im}(\text{co}_k^{\mathcal{A}} - \text{proj}_{1, k-1}^{\mathcal{A}} : \mathring{\mathcal{A}}^\wedge(\vec{\emptyset}, \llbracket 1, k \rrbracket)_{\mathfrak{S}_{k-1}} \rightarrow \mathring{\mathcal{A}}_k^\wedge)$, the commutativity of the latter implies $\text{cs}_{\vec{\emptyset}, k}^\nu((\text{CO}\mathring{\mathcal{A}}_k^\wedge)) \subset (\text{CO}\mathring{\mathcal{A}}_k^\wedge)$. Since $\text{cs}_{\vec{\emptyset}, k}^\nu$ is an automorphism (see Lemma 4.2), this implies the equality $\text{cs}_{\vec{\emptyset}, k}^\nu((\text{CO}\mathring{\mathcal{A}}_k^\wedge)) = (\text{CO}\mathring{\mathcal{A}}_k^\wedge)$. The result then follows from the equalities $\text{cs}^\nu = \bigoplus_{k \geq 0} \text{cs}_{\vec{\emptyset}, k}^\nu$ (see Lemma 4.2(c)) and $(\text{CO}\mathring{\mathcal{A}}^\wedge) = \bigoplus_{k \geq 1} (\text{CO}\mathring{\mathcal{A}}_k^\wedge)$ (see §4.2.1). \square

4.2.6. *The algebra isomorphism $\overline{\text{cs}}^\nu : \mathfrak{s}(\mathbf{A}) \rightarrow \mathfrak{a}$.*

Proposition 4.26. *The algebra automorphism cs^ν of $\bigoplus_{k \geq 0} \mathring{\mathcal{A}}_k^\wedge$ (see Equation(4.2)) induces an algebra isomorphism*

$$(4.40) \quad \overline{\text{cs}}^\nu : \mathfrak{s}(\mathbf{A}) \longrightarrow \mathfrak{a},$$

where $\mathfrak{s}(\mathbf{A})$ is given in (4.4) and \mathfrak{a} in (4.9).

Proof. By Corollary 4.24 and Lemma 4.25 the algebra automorphism cs^ν of $\bigoplus_{k \geq 0} \mathring{\mathcal{A}}_k^\wedge$ satisfies

$$\text{cs}^\nu((\text{KII}\mathring{\mathcal{A}}^\wedge) + (\text{CO}\mathring{\mathcal{A}}^\wedge)) = (\text{KII}^s\mathring{\mathcal{A}}^\wedge) + (\text{CO}\mathring{\mathcal{A}}^\wedge).$$

It then follows from the definitions $\mathfrak{s}(\mathbf{A})$ and \mathfrak{a} that cs^ν induces an algebra isomorphism $\overline{\text{cs}}^\nu : \mathfrak{s}(\mathbf{A}) \rightarrow \mathfrak{a}$. \square

Remark 4.27. The algebra isomorphism (4.40) is compatible with the $\mathbb{Z}_{\geq 0}$ -gradings of its source and target.

4.3. **The algebras $\mathfrak{b}(n)$ and the morphisms $\varphi_n : \mathfrak{a} \rightarrow \mathfrak{b}(n)$.** Throughout this subsection let $n \geq 1$ be an integer. In this subsection we use the notations from subsection 3.2. In particular we use the map $m_C : \mathring{\text{Jac}}(P, S) \rightarrow \mathbb{Z}_{\geq 0}$ from Definition 3.9, the space $\mathring{\mathcal{A}}^\wedge(P, S)$ from Definition 3.10 (for $S \neq \emptyset$) and the pairing $\langle \cdot, \cdot \rangle$ from (3.20).

4.3.1. *The algebra $\mathfrak{b}(n)$.*

Definition 4.28. For any integers $k, r \geq 0$ define the subspace $L_k^{<r}$ of $\mathring{\mathcal{A}}_k^\wedge$ by

$$L_k^{<r} := \widehat{\text{Vect}}_{\mathbb{C}} \{ [\underline{D}] \in \mathring{\mathcal{A}}_k^\wedge \mid \underline{D} \in \mathring{\text{Jac}}(\vec{\emptyset}, \llbracket 1, k \rrbracket) \text{ and } \exists i \in \llbracket 1, k \rrbracket \text{ with } m_i(\underline{D}) < r \}.$$

That is, $L_k^{<r}$ consists of linear combinations of classes of Jacobi diagrams in which there is at least one circle component with less than r attached univalent vertices to it. See Figure 4.21 for an example.

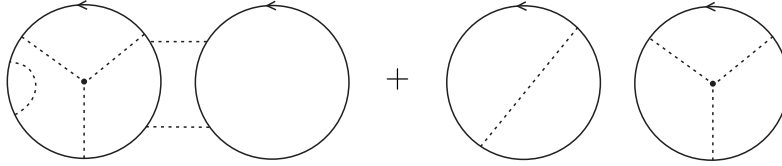

FIGURE 4.21. An element of $L_2^{<3}$.

We set

$$(4.41) \quad L^{<2n} := \bigoplus_{k \geq 0} L_k^{<2n} \subset \bigoplus_{k \geq 0} \mathring{\mathcal{A}}_k^\wedge.$$

Let Σ be a finite set. Recall that we denote by $\text{FPFI}(\Sigma)$ the set of fixed-point free involutions of Σ . This set is of cardinality 0 if $|\Sigma|$ is odd and $(2m-1)!/(2^{m-1}(m-1)!)$ if $|\Sigma| = 2m$ for some $m \geq 1$. There is a map

$$(4.42) \quad \mathring{\text{Jac}} : \text{FPFI}(\Sigma) \longrightarrow \mathring{\text{Jac}}(\vec{\emptyset}, \emptyset, \Sigma),$$

(see Definition 3.48) associating to each $\tau \in \text{FPFI}(\Sigma)$ (for $|\Sigma|$ even) the Jacobi diagram $\mathring{\text{Jac}}(\tau)$ on $(\vec{\emptyset}, \emptyset, \Sigma)$ whose vertex-oriented univalent graph consists of the disjoint union of $|\Sigma|/2$ segments each one of this having endpoints colored by s and $\tau(s)$ for $s \in \Sigma$. Such kind of Jacobi diagrams are called *struts*.

Definition 4.29. For $k \geq 1$, define $\varsigma_k \in \mathring{\mathcal{A}}^\wedge(\vec{\emptyset}, \emptyset, \llbracket 1, 2k \rrbracket)$ by

$$\varsigma_k := \sum_{\tau \in \text{FPFI}(\llbracket 1, 2k \rrbracket)} [\mathring{\text{Jac}}(\tau)],$$

where $[\cdot] : \mathbb{C}\mathring{\text{Jac}}(\vec{\emptyset}, \emptyset, \llbracket 1, 2k \rrbracket) \rightarrow \mathring{\mathcal{A}}^\wedge(\vec{\emptyset}, \emptyset, \llbracket 1, 2k \rrbracket)$ is the canonical projection. In Figure 4.22 we show the element ς_2 and some of the terms of ς_3 .

Definition 4.30. Let P an oriented Brauer diagram and $n \geq 0$.

(a) For any finite set S , define the subspace

$$P^{n+1}(P, S) := \left\{ \langle x, \varsigma_{n+1} \rangle \in \mathring{\mathcal{A}}^\wedge(P, S) \mid x \in \mathring{\mathcal{A}}^\wedge(P, S, \llbracket 1, 2(n+1) \rrbracket) \right\} \subset \mathring{\mathcal{A}}^\wedge(P, S),$$

the pairing being as in (3.20) with $\Sigma = \llbracket 1, 2(n+1) \rrbracket$. See Figure 4.23 for an example.

(b) For any $k \geq 0$, define $P^{n+1}(P)_k$ to be the image of $P^{n+1}(P, \llbracket 1, k \rrbracket) \subset \mathring{\mathcal{A}}^\wedge(P, \llbracket 1, k \rrbracket)$ by the projection $\mathring{\mathcal{A}}^\wedge(P, \llbracket 1, k \rrbracket) \rightarrow \mathring{\mathcal{A}}^\wedge(P)_k$.

(c) For $k \geq 0$, we set $P_k^{n+1} := P^{n+1}(\vec{\emptyset})_k \subset \mathring{\mathcal{A}}_k^\wedge$.

We set

$$(4.43) \quad P^{n+1} := \bigoplus_{k \geq 0} P_k^{n+1} \subset \bigoplus_{k \geq 0} \mathring{\mathcal{A}}_k^\wedge.$$

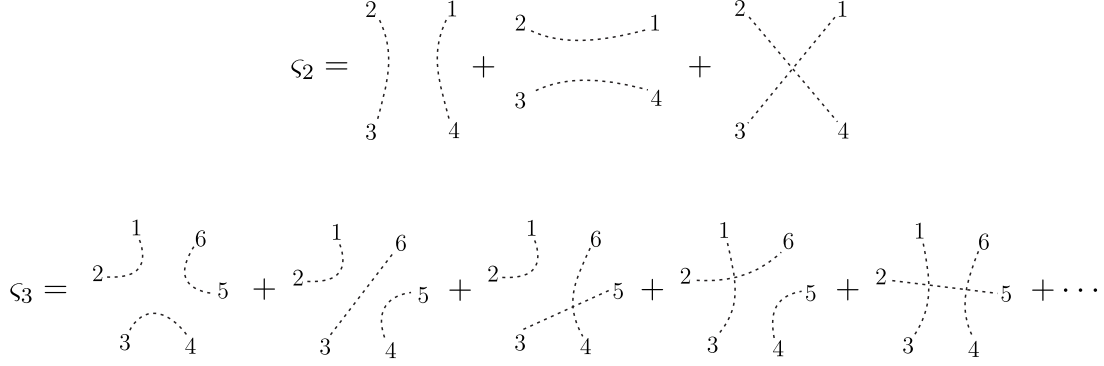
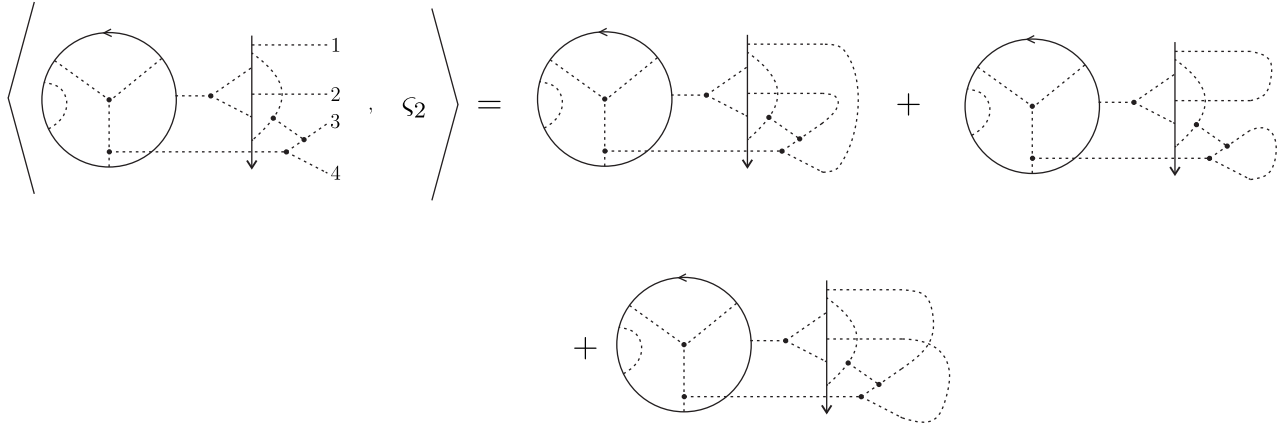
FIGURE 4.22. The elements ς_2 and ς_3 .FIGURE 4.23. An element of $P^2(\downarrow, \{1\})$.

Lemma 4.31. *The subspaces $L^{<2n}$ and P^{n+1} are $\mathbb{Z}_{\geq 0}$ -graded ideals of $\bigoplus_{k \geq 0} \mathring{\mathcal{A}}_k^\wedge$.*

Proof. Let $\underline{E} \in \text{Jac}(\vec{\partial}, [1, k])$, $\underline{D} \in \text{Jac}(\vec{\partial}, [1, l])$ and $i \in [1, l]$ such that $m_i(\underline{D}) < 2n$, then $m_i(\underline{D} \otimes_{\mathcal{A}} \underline{E}) < 2n$. This implies $\mathring{\mathcal{A}}_k^\wedge \cdot L_l^{<2n} \subset L_{k+l}^{<2n}$. Hence $L^{<2n}$ is an ideal of $\bigoplus_{k \geq 0} \mathring{\mathcal{A}}_k^\wedge$.

Let $k, l \geq 0$, one checks the identity $\langle y \otimes_{\mathcal{A}} x, s \rangle = y \otimes_{\mathcal{A}} \langle x, s \rangle$ (identity in $\mathring{\mathcal{A}}^\wedge(\vec{\partial}, [1, k+l])$) for any $y \in \mathring{\mathcal{A}}^\wedge(\vec{\partial}, [1, l])$, $x \in \mathring{\mathcal{A}}^\wedge(\vec{\partial}, [1, k], [1, 2(n+1)])$ and $s \in \mathring{\mathcal{A}}^\wedge(\vec{\partial}, \emptyset, [1, 2(n+1)])$, where $\otimes_{\mathcal{A}}$ is as in (3.21) in the LHS and as in Notation 3.15 in the RHS.

It follows from the specialization of this identity to $s = \varsigma_{n+1}$ that the linear map $\otimes_{\mathcal{A}} : \mathring{\mathcal{A}}^\wedge(\vec{\partial}, [1, k]) \otimes \mathring{\mathcal{A}}^\wedge(\vec{\partial}, [1, l]) \rightarrow \mathring{\mathcal{A}}^\wedge(\vec{\partial}, [1, k+l])$ induces a map $\mathring{\mathcal{A}}^\wedge(\vec{\partial}, [1, k]) \otimes P_l^{n+1} \rightarrow P_{k+l}^{n+1}$ between the subspaces of the source and target of this map. Taking coinvariants, one derives the inclusion $\mathring{\mathcal{A}}_k^\wedge \cdot P_l^{n+1} \subset P_{k+l}^{n+1}$. Hence P^{n+1} is an ideal of $\bigoplus_{k \geq 0} \mathring{\mathcal{A}}_k^\wedge$. \square

By Proposition 2.110(a), $(\text{CO}\mathring{\mathcal{A}}^\wedge)$ is an ideal of $\bigoplus_{k \geq 0} \mathring{\mathcal{A}}_k^\wedge$, therefore so is $L^{<2n} + P^{n+1} + (\text{CO}\mathring{\mathcal{A}}^\wedge)$.

Definition 4.32. Define the commutative algebra $\mathfrak{b}(n)$ as the quotient algebra

$$(4.44) \quad \mathfrak{b}(n) = \frac{\bigoplus_{k \geq 0} \mathring{\mathcal{A}}_k^\wedge}{L^{<2n} + P^{n+1} + (\text{CO}\mathring{\mathcal{A}}^\wedge)} = \bigoplus_{k \geq 0} \frac{\mathring{\mathcal{A}}_k^\wedge}{L_k^{<2n} + P_k^{n+1} + (\text{CO}\mathring{\mathcal{A}}_k^\wedge)}.$$

4.3.2. *The morphism $\varphi_n : \mathfrak{a} \rightarrow \mathfrak{b}(n)$.*

Proposition 4.33 (See [41, Lemma 10.4]). *For any integer $k \geq 2$ we have*

$$\mathring{A}^\wedge(\downarrow\uparrow)_{k-2} = P^{n+1}(\downarrow\uparrow)_{k-2} + \widehat{\text{Vect}}_{\mathbb{C}} \left\{ [D] \in \mathring{A}^\wedge(\downarrow\uparrow)_{k-2} \mid \underline{D} \in \mathring{\text{Jac}}(\downarrow\uparrow, \llbracket 1, k-2 \rrbracket) \text{ with } m_\downarrow(\underline{D}) \leq 2n \right\}.$$

We have a similar result using $\uparrow\downarrow$ and m_\uparrow instead of $\downarrow\uparrow$ and m_\downarrow .

Proof. Lemma 3.1 in [31] (see also [41, Lemma 10.4]) proves for any finite set S , any oriented Brauer diagram P and $C \in \pi_0(P)$, the equality

$$\mathring{A}^\wedge(P, S) = P^{n+1}(P, S) + \widehat{\text{Vect}}_{\mathbb{C}} \left\{ [D] \in \mathring{A}^\wedge(P, S) \mid \underline{D} \in \mathring{\text{Jac}}(P, S) \text{ with } m_C(\underline{D}) \leq 2n \right\}.$$

The result follows upon taking coinvariants from the specialization of this equality to $S = \llbracket 1, k-2 \rrbracket$, $P = \downarrow\uparrow$, and $C = \downarrow \in \pi_0(\downarrow\uparrow)$. \square

Lemma 4.34. *For any $k \geq 2$ we have*

$$\left(\text{KIIMap}_{\mathring{A}^\wedge, k, +-}^{s,2} - \text{KIIMap}_{\mathring{A}^\wedge, k, +-}^{s,1} \right) (P^{n+1}(\downarrow\uparrow)_{k-2}) \subset P_k^{n+1}.$$

Similarly

$$\left(\text{KIIMap}_{\mathring{A}^\wedge, k, -+}^{s,2} - \text{KIIMap}_{\mathring{A}^\wedge, k, -+}^{s,1} \right) (P^{n+1}(\uparrow\downarrow)_{k-2}) \subset P_k^{n+1}.$$

Proof. Let us prove the first inclusion. For P an oriented Brauer diagram, $k \geq 0$ and Σ a finite set, define $\mathring{A}^\wedge(P, \Sigma)_k$ to be the space $\mathring{A}^\wedge(P, \llbracket 1, k \rrbracket, \Sigma)_{\mathfrak{S}_k}$. For $i = 1, 2$, one can define the maps

$$(4.45) \quad \text{KIIMap}_{\mathring{A}^\wedge, k, +-}^{s,i} : \mathring{A}^\wedge(\downarrow\uparrow, \llbracket 1, 2(n+1) \rrbracket)_{k-2} \longrightarrow \mathring{A}^\wedge(\vec{\emptyset}, \llbracket 1, 2(n+1) \rrbracket)_k$$

by the same formulas as those given in (4.5) and (4.6) in Lemma 4.5. By definition of these maps the diagram

$$\begin{array}{ccc} \mathring{A}^\wedge(\downarrow\uparrow, \llbracket 1, 2(n+1) \rrbracket)_{k-2} & \xrightarrow{\langle \cdot, s_{n+1} \rangle} & \mathring{A}^\wedge(\downarrow\uparrow)_{k-2} \\ \downarrow \text{KIIMap}_{\mathring{A}^\wedge, k, +-}^{s,i} & & \downarrow \text{KIIMap}_{\mathring{A}^\wedge, k, +-}^{s,i} \\ \mathring{A}^\wedge(\vec{\emptyset}, \llbracket 1, 2(n+1) \rrbracket)_k & \xrightarrow{\langle \cdot, s_{n+1} \rangle} & \mathring{A}_k^\wedge \end{array}$$

commutes. Then the result follows. \square

Lemma 4.35. *Let $k \geq 2$ and $\underline{D} = (D, \varphi, \{\text{lin}_l\}_{l \in \pi_0(\downarrow\uparrow)}, \{\text{cyc}_s\}_{s \in \llbracket 1, k-2 \rrbracket}) \in \mathring{\text{Jac}}(\downarrow\uparrow, \llbracket 1, k-2 \rrbracket)$. Then*

- (a) *There exist $(\tilde{\varphi}, \{\widetilde{\text{cyc}}_s\}_{s \in \llbracket 1, k \rrbracket})$ and $(\varphi_i, \{\text{cyc}_s^i\}_{s \in \llbracket 1, k \rrbracket})_i$, indexed by the set of maps $i : \varphi^{-1}(\downarrow) \rightarrow \{1, 2\}$, where $\tilde{\varphi}, \varphi_i : \partial D \rightarrow \llbracket 1, k \rrbracket$ are maps and for each $s \in \llbracket 1, k \rrbracket$, $\widetilde{\text{cyc}}_s$ and cyc_s^i are cyclic orders on $\tilde{\varphi}^{-1}(s)$ and $\varphi_i^{-1}(s)$ respectively; such that*

$$\text{KIIMap}_{\mathring{A}^\wedge, k, +-}^{s,1}([\underline{D}]) = [\tilde{D}] \quad \text{and} \quad \text{KIIMap}_{\mathring{A}^\wedge, k, +-}^{s,2}([\underline{D}]) = \sum_i [\underline{D}_i],$$

where \tilde{D} and \tilde{D}_i are the elements of $\mathring{\text{Jac}}(\vec{\emptyset}, \llbracket 1, k \rrbracket)$ defined by $\tilde{D} := (D, \tilde{\varphi}, \{\widetilde{\text{cyc}}_s\}_{s \in \llbracket 1, k \rrbracket})$ and $\underline{D}_i := (D, \varphi_i, \{\text{cyc}_s^i\}_{s \in \llbracket 1, k \rrbracket})$.

- (b) *Let $i_1 : \varphi^{-1}(\downarrow) \rightarrow \{1, 2\}$ be the constant map with value 1. Then*

$$(\varphi_{i_1}, \{\text{cyc}_s^{i_1}\}_{s \in \llbracket 1, k \rrbracket}) = (\tilde{\varphi}, \{\widetilde{\text{cyc}}_s\}_{s \in \llbracket 1, k \rrbracket}).$$

- (c) *For any map $i : \varphi^{-1}(1) \rightarrow \{1, 2\}$ with $i \neq i_1$, we have $m_1(\underline{D}_i) < m_\downarrow(\underline{D})$ (in these expressions, the indices 1 and \downarrow respectively refer to elements of $\llbracket 1, k \rrbracket$ and of $\pi_0(\downarrow\uparrow)$).*

- (d)

$$(\text{KIIMap}_{\mathring{A}^\wedge, k, +-}^{s,2} - \text{KIIMap}_{\mathring{A}^\wedge, k, +-}^{s,1})([\underline{D}]) \in L_k^{< m_\downarrow(\underline{D})}.$$

We have similar results involving the maps $\text{KIIMap}_{\mathring{\mathcal{A}}^\wedge, k, +-}^{s,1}$ and $\text{KIIMap}_{\mathring{\mathcal{A}}^\wedge, k, +-}^{s,2}$ and the set $\text{Jac}(\uparrow\downarrow, \llbracket 1, k-2 \rrbracket)$.

Proof. (a) It follows from the definition of the maps $\text{KIIMap}_{\mathring{\mathcal{A}}^\wedge, k, +-}^{s,j}$ for $j = 1, 2$, (see Lemma 4.5) that the first equality holds with $\tilde{\varphi}$ being the composition of φ with the bijection $\pi_0(\downarrow\uparrow) \sqcup \llbracket 1, k-2 \rrbracket \rightarrow \llbracket 1, k \rrbracket$ given by $\downarrow \mapsto 1$, $\uparrow \mapsto 2$, $s \mapsto s+2$ for $s \in \llbracket 1, k-2 \rrbracket$, and for $s \in \llbracket 3, k \rrbracket$, $\widetilde{\text{cyc}}_s := \text{cyc}_{s-2}$ and for $s \in \{1, 2\}$, $\widetilde{\text{cyc}}_s$ is the cyclic order derived from the linear order $\text{lin}_{s'}$ where s' is the preimage of s under the bijection $\pi_0(\downarrow\uparrow) \simeq \{1, 2\}$ given by $\downarrow \mapsto 1$ and $\uparrow \mapsto 2$, as in Lemma 3.2(b) (with $I = \{\downarrow\}$ or $I = \{\uparrow\}$). The second equality holds if for each map $i : \varphi^{-1}(1) \rightarrow \{1, 2\}$, the map $\varphi_i : \partial D \rightarrow \llbracket 1, k \rrbracket$ is defined by the conditions that $(\varphi_i)|_{\varphi^{-1}(\downarrow)} = i$ and $(\varphi_i)|_{\partial D \setminus \varphi^{-1}(\downarrow)}$ is the composition of $\varphi|_{\partial D \setminus \varphi^{-1}(\downarrow)} : \partial D \setminus \varphi^{-1}(\downarrow) \rightarrow \{\uparrow\} \sqcup \llbracket 1, k-2 \rrbracket$ with the map $\{\uparrow\} \sqcup \llbracket 1, k-2 \rrbracket \rightarrow \llbracket 1, k \rrbracket$ given by $\uparrow \mapsto 2$ and $s \mapsto s+2$ for $s \in \llbracket 1, k-2 \rrbracket$, and the cyclic orders are defined by $\text{cyc}_s^i := \text{cyc}_{s-2}$ for $s \in \llbracket 3, k \rrbracket$ and cyc_1^i is the cyclic order derived from the restriction of the linear order lin_\downarrow to $i^{-1}(1)$ as in Lemma 3.2(b) (with $I = \{\downarrow\}$), and cyc_2^i is the cyclic order obtained from the linear orders lin_\uparrow and the restriction of the linear order lin_\downarrow to $i^{-1}(2)$ as in Lemma 3.2(b) (with $I = \{\downarrow, \uparrow\}$ equipped with its unique cyclic order).

(b) Follows directly from the definition of $(\varphi_{i_1}, \{\text{cyc}_s^{i_1}\}_{s \in \llbracket 1, k \rrbracket})$ and $(\tilde{\varphi}, \{\widetilde{\text{cyc}}_s\}_{s \in \llbracket 1, k \rrbracket})$ in (a).

(c) By the definitions given in (a), for any map $i : \varphi^{-1}(\downarrow) \rightarrow \{1, 2\}$ we have

$$(4.46) \quad m_1(\underline{D}_i) + m_2(\underline{D}_i) = m_\downarrow(\underline{D}) + m_\uparrow(\underline{D}) \quad \text{and} \quad m_2(\underline{D}_i) = |i^{-1}(2)| + m_\uparrow(\underline{D}).$$

If $i \neq i_1$, then $|i^{-1}(2)| > 0$ and therefore, by (4.46), we get $m_1(\underline{D}_i) < m_\downarrow(\underline{D})$.

(d) By (a) and (b) we have

$$\left(\text{KIIMap}_{\mathring{\mathcal{A}}^\wedge, k, +-}^{s,2} - \text{KIIMap}_{\mathring{\mathcal{A}}^\wedge, k, +-}^{s,1} \right) (\llbracket \underline{D} \rrbracket) = \sum_{i \neq i_1} \llbracket \underline{D}_i \rrbracket$$

and by (c) each $\llbracket \underline{D}_i \rrbracket$ with $i \neq i_1$ belongs to $L^{< m_\downarrow(\underline{D})}$, which finishes the proof. \square

Proposition 4.36 (See [41, Prop. 10.5]). *For any $k \geq 2$ we have*

$$(4.47) \quad (\text{KII}^s \mathring{\mathcal{A}}_k^\wedge) \subset L_k^{< 2n} + P_k^{n+1}.$$

Therefore $(\text{KII}^s \mathring{\mathcal{A}}^\wedge) \subset L^{< 2n} + P^{n+1}$.

Proof. Recall from Definition 4.6 that

$$(\text{KII}^s \mathring{\mathcal{A}}_k^\wedge) := \text{Im} \left(\text{KIIMap}_{\mathring{\mathcal{A}}^\wedge, k, +-}^{s,2} - \text{KIIMap}_{\mathring{\mathcal{A}}^\wedge, k, +-}^{s,1} \right) + \text{Im} \left(\text{KIIMap}_{\mathring{\mathcal{A}}^\wedge, k, +-}^{s,2} - \text{KIIMap}_{\mathring{\mathcal{A}}^\wedge, k, +-}^{s,1} \right).$$

Besides

$$\begin{aligned} \text{Im} \left(\text{KIIMap}_{\mathring{\mathcal{A}}^\wedge, k, +-}^{s,2} - \text{KIIMap}_{\mathring{\mathcal{A}}^\wedge, k, +-}^{s,1} \right) &= \left(\text{KIIMap}_{\mathring{\mathcal{A}}^\wedge, k, +-}^{s,2} - \text{KIIMap}_{\mathring{\mathcal{A}}^\wedge, k, +-}^{s,1} \right) (\mathring{\mathcal{A}}^\wedge(\downarrow\uparrow)_{k-2}) \\ &= \left(\text{KIIMap}_{\mathring{\mathcal{A}}^\wedge, k, +-}^{s,2} - \text{KIIMap}_{\mathring{\mathcal{A}}^\wedge, k, +-}^{s,1} \right) (P^{n+1}(\downarrow\uparrow)_{k-2}) \\ &\quad + \widehat{\text{Vect}}_{\mathbb{C}} \left\{ \left(\text{KIIMap}_{\mathring{\mathcal{A}}^\wedge, k, +-}^{s,2} - \text{KIIMap}_{\mathring{\mathcal{A}}^\wedge, k, +-}^{s,1} \right) (\llbracket \underline{D} \rrbracket) \mid \underline{D} \in \text{Jac}(\downarrow\uparrow, \llbracket 1, k-2 \rrbracket) \text{ with } m_\downarrow(\underline{D}) \leq 2n \right\} \\ &\subset P_k^{n+1} + L_k^{< 2n}. \end{aligned}$$

We have used Proposition 4.33 in the second equality; and Lemma 4.34 and Lemma 4.35(d) in the last inclusion. Similarly for the second term of $(\text{KII}^s \mathring{\mathcal{A}}_k^\wedge)$. Therefore, we conclude $(\text{KII}^s \mathring{\mathcal{A}}_k^\wedge) \subset L^{< 2n} + P^{n+1}$. \square

Corollary 4.37. *The identity map of $\bigoplus_{k \geq 0} \mathring{\mathcal{A}}_k^\wedge$ induces an algebra morphism $\varphi_n : \mathfrak{a} \rightarrow \mathfrak{b}(n)$, where \mathfrak{a} is as in (4.9) and $\mathfrak{b}(n)$ as in (4.44).*

Proof. The result follows directly from Proposition 4.36. \square

Remark 4.38. The algebra morphism φ_n is compatible with the $\mathbb{Z}_{\geq 0}$ -gradings of its source and target.

4.4. The spaces of diagrammatic traces and the LMO diagrammatic trace.

4.4.1. *The space of diagrammatic traces.* For a finite group G , a pair (P, S) of an oriented Brauer diagram P and a finite set S , and a finite G -set Σ , there is an action of G on $\mathring{\text{Jac}}(P, S, \Sigma)$, $\mathbb{C}\mathring{\text{Jac}}(P, S, \Sigma)$, $\mathring{\mathcal{A}}(P, S, \Sigma)$ and $\mathring{\mathcal{A}}^\wedge(P, S, \Sigma)$ induced by the action of G on Σ . Recall that for $m \geq 0$ we denote by \mathbb{Z}_m the cyclic group of order m (this is \emptyset for $m = 0$). In particular, for any integer $n \geq 1$ we have actions of \mathfrak{S}_n (using the identification $\mathbb{Z}_n \simeq \llbracket 0, n-1 \rrbracket$) and \mathbb{Z}_n (by addition) on $\mathring{\mathcal{A}}(\vec{\emptyset}, \emptyset, \mathbb{Z}_n)$.

Definition 4.39. A *diagrammatic trace* is an element $T_\bullet := (T_n)_{n \geq 0} \in \prod_{n \geq 0} \mathring{\mathcal{A}}(\vec{\emptyset}, \emptyset, \mathbb{Z}_n)$ satisfying:

- (1) $T_0 = T_1 = 0$,
- (2) for $n \geq 2$, the element T_n is invariant under the action of \mathbb{Z}_n , i.e. $(1 \cdots n)T_n = T_n$,
- (3) (*STU-compatibility*) $T_m - (i \ i+1)T_m = T_{m-1} *_i \wr$ for any $m \geq 3$ and $i \in \mathbb{Z}_m$,

where $T_{m-1} \mapsto T_{m-1} *_i \wr$ is the linear map $\mathring{\mathcal{A}}(\vec{\emptyset}, \emptyset, \mathbb{Z}_{m-1}) \rightarrow \mathring{\mathcal{A}}(\vec{\emptyset}, \emptyset, \mathbb{Z}_m)$ derived from the map

$$\mathring{\text{Jac}}(\vec{\emptyset}, \emptyset, \mathbb{Z}_{m-1}) \longrightarrow \mathring{\text{Jac}}(\vec{\emptyset}, \emptyset, \mathbb{Z}_m)$$

which takes $\underline{D} \in \mathring{\text{Jac}}(\vec{\emptyset}, \emptyset, \mathbb{Z}_{m-1})$ to the Jacobi diagram $\underline{D} *_i \wr$ obtained from \underline{D} by gluing the \wr -shaped graph to the univalent vertex labelled i and re-labelling the vertices so that the remaining vertices of the \wr -shaped graph become i and $i+1$ with the cyclic order in the new trivalent vertex given by $[a < i+1 < i]$, where a is the edge connecting the \wr -shaped graph with \underline{D} , see Figure 4.24.

Denote by $\text{DiagTr} \subset \prod_{n \geq 0} \mathring{\mathcal{A}}(\vec{\emptyset}, \emptyset, \mathbb{Z}_n)$ the subset of all diagrammatic traces.

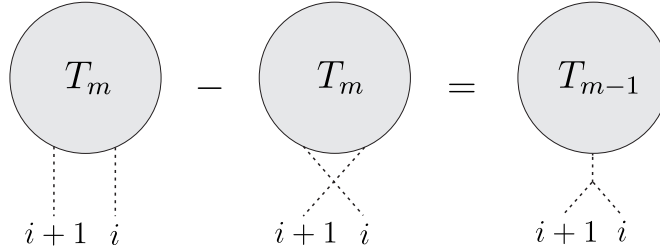

FIGURE 4.24. Schematic description of the STU-compatibility condition of a diagrammatic trace $T_\bullet = (T_n)_{n \geq 0}$.

Lemma 4.40. Equip $\prod_{n \geq 0} \mathring{\mathcal{A}}(\vec{\emptyset}, \emptyset, \mathbb{Z}_n)$ with the bigrading: For $c, d \in \mathbb{Z}_{\geq 0}$

$$\left(\prod_{n \geq 0} \mathring{\mathcal{A}}(\vec{\emptyset}, \emptyset, \mathbb{Z}_n) \right) [c, d] := \prod_{n \geq 0} \mathring{\mathcal{A}}(\vec{\emptyset}, \emptyset, \mathbb{Z}_n) [c, d]$$

induced by $(|\pi_0|, \deg_{\text{cyc}})$ (see (3.19)). Then DiagTr is a bigraded subspace of $\prod_{n \geq 0} \mathring{\mathcal{A}}(\vec{\emptyset}, \emptyset, \mathbb{Z}_n)$. We denote by $\text{DiagTr}[c, d]$ the space of diagrammatic traces of bidegree (c, d) .

Proof. The self-maps of $\mathring{\mathcal{A}}(\vec{\emptyset}, \emptyset, \mathbb{Z}_m)$ defined by $T \mapsto (1 \cdots n)T$ and $T \mapsto (i, i+1)T$, as well as the map $\mathring{\mathcal{A}}(\vec{\emptyset}, \emptyset, \mathbb{Z}_{m-1}) \rightarrow \mathring{\mathcal{A}}(\vec{\emptyset}, \emptyset, \mathbb{Z}_m)$ defined by $T \mapsto T *_i \wr$ are compatible with the bidegrees. It follows that DiagTr is the kernel of a linear map of bidegree $(0, 0)$ with source $\prod_{n \geq 0} \mathring{\mathcal{A}}(\vec{\emptyset}, \emptyset, \mathbb{Z}_n)$ and with target $\mathring{\mathcal{A}}(\vec{\emptyset}, \emptyset, \mathbb{Z}_0) \times \mathring{\mathcal{A}}(\vec{\emptyset}, \emptyset, \mathbb{Z}_1) \times \prod_{n \geq 2} \mathring{\mathcal{A}}(\vec{\emptyset}, \emptyset, \mathbb{Z}_n) \times \prod_{n \geq 2} \mathring{\mathcal{A}}(\vec{\emptyset}, \emptyset, \mathbb{Z}_n)$, which implies the result. \square

One checks that if $T_\bullet = (T_n)_{n \geq 0} \in \text{DiagTr}[c, d]$, then $\deg(T_n) = n + d - c$ for any $n \geq 2$.

Lemma 4.41 ([31, Proposition 2.3]). Let $T_\bullet = (T_n)_{n \geq 0}$ and $T'_\bullet = (T'_n)_{n \geq 0}$ be diagrammatic traces. For $n \geq 0$, set $T''_n := \sum_{p, q \mid p+q=n} \sum_{\sigma \in \mathfrak{S}_{p, q}} \sigma_*(T_p \otimes_{\mathcal{A}} T'_q)$ where $\otimes_{\mathcal{A}}$ is as in (3.21), $\mathfrak{S}_{p, q}$ is the set of bijections $\mathbb{Z}_p \sqcup \mathbb{Z}_q \rightarrow \mathbb{Z}_{p+q}$ whose restrictions to \mathbb{Z}_p and \mathbb{Z}_q are both increasing (using the identifications of \mathbb{Z}_p , \mathbb{Z}_q and \mathbb{Z}_{p+q} with $\llbracket 0, p-1 \rrbracket$, $\llbracket 0, q-1 \rrbracket$ and $\llbracket 0, p+q-1 \rrbracket$ respectively) and σ_* is defined as in §3.10.2. Then $T_\bullet * T'_\bullet := (T''_n)_{n \geq 0}$ is a diagrammatic trace.

Lemma 4.42. Equipped with the product from Lemma 4.41, and with the bidegree from Lemma 4.40, the vector space DiagTr as a $\mathbb{Z}_{\geq 0}^2$ -graded commutative algebra.

Proof. The result is a direct verification. \square

The commutative algebra $\mathring{\mathcal{A}}(\vec{\emptyset}, \emptyset, \emptyset)$ is bigraded by $(|\pi_0|, \deg_{\text{cyc}})$. It acts on DiagTr by $a * (T_n)_{n \geq 0} := (a \otimes_{\mathcal{A}} T_n)_{n \geq 0}$. Then DiagTr is naturally a bigraded $\mathring{\mathcal{A}}(\vec{\emptyset}, \emptyset, \emptyset)$ -bimodule, and the algebra structure of DiagTr gives rise to a structure of algebra of DiagTr in the category of $\mathring{\mathcal{A}}(\vec{\emptyset}, \emptyset, \emptyset)$ -bimodules.

Remark 4.43. Consider the family $U_{\bullet} := (U_n)_{n \geq 0} \in \prod_{n \geq 0} \mathring{\mathcal{A}}(\vec{\emptyset}, \emptyset, \mathbb{Z}_n)$, where $U_0 = U_1 = 0$ and for $n \geq 2$, U_n consists of a dashed loop with n legs attached to it, see Figure 4.25 for the schematic representation of U_8 . One checks that $U_{\bullet} \in \text{DiagTr}[1, 1]$.

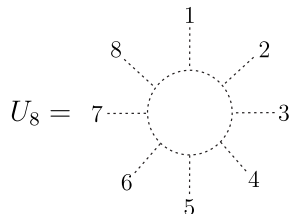

FIGURE 4.25. The element $U_8 \in \mathring{\mathcal{A}}(\vec{\emptyset}, \emptyset, \mathbb{Z}_8)$.

4.4.2. The LMO diagrammatic trace.

Lemma 4.44 ([31, Proposition 2.2]). *The space $\text{DiagTr}[1, 0]$ is 1-dimensional. A generator $T_{\bullet}^{\text{LMO}} = (T_n^{\text{LMO}})_{n \geq 0}$ is such that T_n^{LMO} is given by Figure 4.26 for $n = 2, 3, 4$. For any $n \geq 2$, T_n^{LMO} is a sum of connected tree diagrams, hence $\deg(T_n^{\text{LMO}}) = n - 1$ for \deg given by (3.1). We call T^{LMO} the LMO diagrammatic trace.*

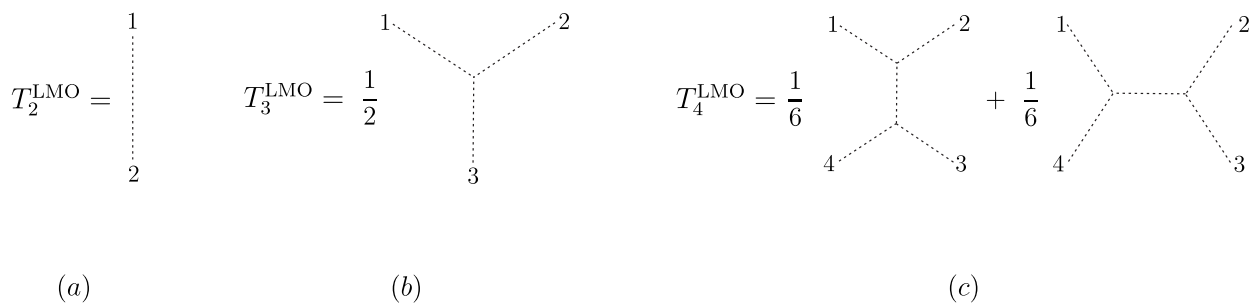

FIGURE 4.26. The elements $T_2^{\text{LMO}} \in \mathring{\mathcal{A}}(\vec{\emptyset}, \emptyset, \mathbb{Z}_2)$, $T_3^{\text{LMO}} \in \mathring{\mathcal{A}}(\vec{\emptyset}, \emptyset, \mathbb{Z}_3)$ and $T_4^{\text{LMO}} \in \mathring{\mathcal{A}}(\vec{\emptyset}, \emptyset, \mathbb{Z}_4)$.

4.4.3. Lie algebras and the space of diagrammatic traces.

Definition 4.45. Recall that a trace on an associative algebra A is a linear map $T : A \rightarrow \mathbb{C}$ such that $T(ab) = T(ba)$ for any $a, b \in A$. Denote by $\mathbb{T}(A)$ the set of traces of A ; this is a vector subspace of A^* .

Lemma 4.46. *Let \mathfrak{g} be a Lie algebra. Let $U\mathfrak{g}$ denote the enveloping algebra of \mathfrak{g} and $\Delta : U\mathfrak{g} \rightarrow U\mathfrak{g} \otimes U\mathfrak{g}$ the canonical coproduct. We use the notation $\Delta(x) = \sum x^{(1)} \otimes x^{(2)}$.*

- (a) *Let $\tau_1, \tau_2 \in \mathbb{T}(U\mathfrak{g})$. The map $\tau_1 \otimes \tau_2 : U\mathfrak{g} \rightarrow \mathbb{C}$ defined by $(\tau_1 * \tau_2)(x) = \sum \tau_1(x^{(1)}) \otimes \tau_2(x^{(2)})$ for any $x \in U\mathfrak{g}$, is a trace of $U\mathfrak{g}$.*
- (b) *The operation in (a) endows $\mathbb{T}(U\mathfrak{g})$ with a structure of commutative algebra.*

Proof. The result is a direct verification. \square

Similar to the definition of a weight system, see [24, Chapter 14], any pair $(\mathfrak{g}, \langle \cdot, \cdot \rangle_{\mathfrak{g}})$, where \mathfrak{g} is a finite dimensional Lie algebra and $\langle \cdot, \cdot \rangle_{\mathfrak{g}}$ is a non-degenerated invariant pairing on \mathfrak{g} , gives rise to a collection of linear maps

$$(4.48) \quad \mathring{\mathcal{A}}(\text{Id}_{[[1, m]]}, \emptyset, [[1, n]]) \longrightarrow \text{Hom}(\mathfrak{g}^{\otimes n}, U\mathfrak{g}^{\otimes m})$$

which moreover intertwine the composition

$$\circ_{\mathcal{A}} : \mathring{\mathcal{A}}(\text{Id}_{[[1, m]]}, \emptyset, [[1, n]]) \otimes \mathring{\mathcal{A}}(\text{Id}_{[[1, m']]} , \emptyset, [[1, n']]) \longrightarrow \mathring{\mathcal{A}}(\text{Id}_{[[1, m+n']]}, \emptyset, [[1, n+n']])$$

(see (3.22)) with the map induced by the product in $U\mathfrak{g}^{\otimes m}$ and the concatenation $\mathfrak{g}^{\otimes n} \otimes \mathfrak{g}^{\otimes n'} \rightarrow \mathfrak{g}^{\otimes n+n'}$; the tensor product

$$\otimes_{\mathcal{A}} : \mathring{\mathcal{A}}(\text{Id}_{[[1, m]]}, \emptyset, [[1, n]]) \otimes \mathring{\mathcal{A}}(\text{Id}_{[[1, m']]} , \emptyset, [[1, n']]) \longrightarrow \mathring{\mathcal{A}}(\text{Id}_{[[1, m+m']]}, \emptyset, [[1, n+n']])$$

(see (3.21)) with the operation defined by the concatenations $\mathfrak{g}^{\otimes n} \otimes \mathfrak{g}^{\otimes n'} \rightarrow \mathfrak{g}^{\otimes n+n'}$ and $U\mathfrak{g}^{\otimes m} \otimes U\mathfrak{g}^{\otimes m'} \rightarrow U\mathfrak{g}^{\otimes m+m'}$; and the connecting operation $\mathring{\mathcal{A}}(\text{Id}_{[[1, m]]}, \emptyset, [[1, n]]) \otimes \mathring{\mathcal{A}}(\text{Id}_{[[1, p]]}, \emptyset, [[1, n]]) \rightarrow \mathring{\mathcal{A}}(\text{Id}_{[[1, m+p]]}, \emptyset, \emptyset)$ (see (3.20)) with the map arising from the concatenation of $U\mathfrak{g}^{\otimes m}$ and $U\mathfrak{g}^{\otimes p}$ and the composition of the n -th power of the element of $\mathfrak{g} \otimes \mathfrak{g}$ arising from the pairing $\langle \cdot, \cdot \rangle_{\mathfrak{g}}$.

For $n \geq 0$, the bijection $\mathbb{Z}_n \simeq [[0, n-1]]$ and the map (4.48) give rise to a linear map $\mathring{\mathcal{A}}(\vec{\emptyset}, \emptyset, \mathbb{Z}_n) \rightarrow \text{Hom}(\mathfrak{g}^{\otimes n}, \mathbb{C})$. The product over $n \geq 0$ of these maps is a linear map

$$(4.49) \quad \text{ev}_{\mathfrak{g}} : \prod_{n \geq 0} \mathring{\mathcal{A}}(\vec{\emptyset}, \emptyset, \mathbb{Z}_n) \longrightarrow \text{Hom}(T\mathfrak{g}, \mathbb{C}),$$

where $T\mathfrak{g}$ is the tensor algebra of \mathfrak{g} .

Lemma 4.47. *The image of DiagTr by the map (4.49) is contained in $\mathbb{T}(U\mathfrak{g})$. The resulting map $\text{DiagTr} \rightarrow \mathbb{T}(U\mathfrak{g})$ is an algebra morphism.*

Proof. Recall that $\mathbb{T}(U\mathfrak{g}) \subset (U\mathfrak{g})^* \subset (T\mathfrak{g})^*$. Let $T_{\bullet} \in \text{DiagTr}$, by the condition (3) in Definition 4.39, the map $\text{ev}_{\mathfrak{g}}(T_{\bullet})$ vanishes on the two-sided ideal of $T\mathfrak{g}$ generated by the elements $x \otimes y - y \otimes x - [x, y]$ for $x, y \in \mathfrak{g}$. It follows that $\text{ev}_{\mathfrak{g}}(T_{\bullet}) \in U\mathfrak{g}^*$. The relation (2) in Definition 4.39 then implies that $\text{ev}_{\mathfrak{g}}(T_{\bullet}) \in \mathbb{T}(U\mathfrak{g})$. The algebra morphism property follows from the definition of the product structure on $\mathbb{T}(U\mathfrak{g})$ (see Lemma 4.46(a)) and the expression of the coproduct of a pure tensor in $T\mathfrak{g}$ based on pure shuffles, namely $\Delta(x_1 \cdots x_n) = \sum_{a=0}^n \sum_{\sigma \in \mathfrak{S}_{a, n-a}} x_{\sigma(1)} \cdots x_{\sigma(a)} \otimes x_{\sigma(a+1)} \cdots x_{\sigma(n)}$, where the sets $\mathfrak{S}_{a, n-a}$ are as in Lemma 4.41. \square

Remark 4.48. One checks that the image of the element U_{\bullet} from Remark 4.43 is the trace on $U\mathfrak{g}$ induced by the adjoint representation of $U\mathfrak{g}$ on \mathfrak{g} , namely $\text{ev}_{\mathfrak{g}}(U_{\bullet}) = \text{tr}_{\mathfrak{g}}$, where $\text{tr}_{\mathfrak{g}} \in \mathbb{T}(U\mathfrak{g})$ is given by $U\mathfrak{g} \ni a \mapsto \text{tr}_{\mathfrak{g}}(\text{ad}_a)$, and $U\mathfrak{g} \ni a \mapsto \text{ad}_a$ is the algebra morphism $U\mathfrak{g} \rightarrow \text{End}(\mathfrak{g})$ whose restriction to \mathfrak{g} is the map $x \mapsto \text{ad}_x = (y \mapsto [x, y])$ for any $x, y \in \mathfrak{g}$.

4.5. The algebras $\mathfrak{c}(n)$ and the morphisms $\bar{j}_n : \mathfrak{b}(n) \rightarrow \mathfrak{c}(n)$. Throughout this subsection let $n \geq 1$ be an integer.

4.5.1. Gradings on $\bigoplus_{k \geq 0} \mathring{\mathcal{A}}_k^{\wedge}$ and $\mathring{\mathcal{A}}_0^{\wedge}$. Recall that for any pair (P, S) of an oriented Brauer diagram P and a finite set S , the space $\mathring{\mathcal{A}}(P, S)$ is equipped with the grading deg given in (3.1), for which the composition (see §3.4) and tensor product (see §3.3) operations are homogeneous. These operations coincide in the case of a pair of the form $(\vec{\emptyset}, [[1, k]])$ for $k \geq 0$. They induce graded maps $\mathring{\mathcal{A}}_k \otimes \mathring{\mathcal{A}}_l \rightarrow \mathring{\mathcal{A}}_{k+l}$ for $k, l \geq 0$, which define an algebra structure on the vector space $\bigoplus_{k \geq 0} \mathring{\mathcal{A}}_k$. This algebra is equipped with a bigrading $(\text{deg}, \text{deg}_{\text{cir}})$ where $\mathring{\mathcal{A}}_k$ is the homogeneous component of degree k for deg_{cir} . The algebra $\bigoplus_{k \geq 0} \mathring{\mathcal{A}}_k^{\wedge}$ is the completion of the latter algebra for deg .

The subspace $\mathring{\mathcal{A}}_0$ of $\bigoplus_{k \geq 0} \mathring{\mathcal{A}}_k$ is a subalgebra, equipped with the degree deg . We denote by $\mathring{\mathcal{A}}_0^{\wedge}$ its degree completion.

4.5.2. *The algebra morphisms* $j^{T_\bullet} : \bigoplus_{k \geq 0} \mathring{\mathcal{A}}_k^\wedge \rightarrow \mathring{\mathcal{A}}_0^\wedge$ *associated to a diagrammatic trace* T_\bullet . In this subsection we define a map $j^{T_\bullet} : \bigoplus_{k \geq 0} \mathring{\mathcal{A}}_k^\wedge \rightarrow \mathring{\mathcal{A}}_0^\wedge$ associated to a diagrammatic trace T_\bullet . If T_\bullet is the n -th power (using the product $*$ from Lemma 4.46) of the diagrammatic LMO trace (see Lemma 4.44), then j^{T_\bullet} is the map introduced in [31, Section 2] (see also [41, Chapter 10]).

Definition 4.49. For $k \geq 1$ and $n_1, \dots, n_k \geq 0$ and $i \in \llbracket 1, k \rrbracket$. Set

$$\mathcal{A} := \bigoplus_{m_1, \dots, m_k \geq 0} \mathring{\mathcal{A}}^\wedge(\vec{\emptyset}, \emptyset, \mathbb{Z}_{m_1} \sqcup \dots \sqcup \mathbb{Z}_{m_k}).$$

(a) Define the linear map

$$\varphi_{(n_1, \dots, n_k, i)} : \mathring{\mathcal{A}}^\wedge(\vec{\emptyset}, \emptyset, \mathbb{Z}_{n_1} \sqcup \dots \sqcup \mathbb{Z}_{n_k}) \longrightarrow \mathring{\mathcal{A}}^\wedge(\vec{\emptyset}, \emptyset, \mathbb{Z}_{n_1} \sqcup \dots \sqcup \mathbb{Z}_{n_k}) \subset \mathcal{A}$$

by $T \mapsto \tilde{T} - T$, where \tilde{T} is the action of the permutation of $\mathbb{Z}_{n_1} \sqcup \dots \sqcup \mathbb{Z}_{n_k}$ given by $x \mapsto x + 1$ for i -th component. Let

$$\varphi^{\text{cyc}} : \bigoplus_{i \in \llbracket 1, k \rrbracket, n_1, \dots, n_k \in \mathbb{Z}_{\geq 0}} \mathring{\mathcal{A}}^\wedge(\vec{\emptyset}, \emptyset, \mathbb{Z}_{n_1} \sqcup \dots \sqcup \mathbb{Z}_{n_k}) \longrightarrow \mathcal{A}$$

be defined as

$$\varphi^{\text{cyc}} := \sum_{i=1}^k \sum_{n_1, \dots, n_k \geq 0} \varphi_{(n_1, \dots, n_k, i)}.$$

(b) For $i \in \llbracket 1, k \rrbracket$ such that $n_i \geq 2$, define the linear map

$$\psi_{(n_1, \dots, n_k, i)}^1 : \mathring{\mathcal{A}}^\wedge(\vec{\emptyset}, \emptyset, \mathbb{Z}_{n_1} \sqcup \dots \sqcup \mathbb{Z}_{n_k}) \longrightarrow \mathring{\mathcal{A}}^\wedge(\vec{\emptyset}, \emptyset, \mathbb{Z}_{n_1} \sqcup \dots \sqcup \mathbb{Z}_{n_{i-1}} \sqcup \dots \sqcup \mathbb{Z}_{n_k}) \subset \mathcal{A}$$

as the map derived from the map

$$\mathring{\text{Jac}}(\vec{\emptyset}, \emptyset, \mathbb{Z}_{n_1} \sqcup \dots \sqcup \mathbb{Z}_{n_k}) \longrightarrow \mathring{\text{Jac}}(\vec{\emptyset}, \emptyset, \mathbb{Z}_{n_1} \sqcup \dots \sqcup \mathbb{Z}_{n_{i-1}} \sqcup \dots \sqcup \mathbb{Z}_{n_k})$$

which takes $\underline{D} \in \mathring{\text{Jac}}(\vec{\emptyset}, \emptyset, \mathbb{Z}_{n_1} \sqcup \dots \sqcup \mathbb{Z}_{n_k})$ to the Jacobi diagram $\underline{D} *_{(n_i-2, n_i-1)} \wedge$ obtained from \underline{D} by gluing the two univalent vertices (corresponding to \mathbb{Z}_{n_i}) labelled by $n_i - 2$ and $n_i - 1$ to two of the univalent vertices of the \wedge -shaped graph and labelling the remaining vertex of the \wedge -shaped graph by $n_i - 2 \in \mathbb{Z}_{n_{i-1}} \subset \mathbb{Z}_{n_1} \sqcup \dots \sqcup \mathbb{Z}_{n_{i-1}} \sqcup \dots \sqcup \mathbb{Z}_{n_k}$. The cyclic order of the new trivalent vertex is $[\text{old}(n_i - 1) < \text{new}(n_i - 2) < \text{old}(n_i - 2)]$.

(c) For $i \in \llbracket 1, k \rrbracket$ such that $n_i \geq 2$, define the linear map

$$\psi_{(n_1, \dots, n_k, i)}^2 : \mathring{\mathcal{A}}^\wedge(\vec{\emptyset}, \emptyset, \mathbb{Z}_{n_1} \sqcup \dots \sqcup \mathbb{Z}_{n_k}) \longrightarrow \mathring{\mathcal{A}}^\wedge(\vec{\emptyset}, \emptyset, \mathbb{Z}_{n_1} \sqcup \dots \sqcup \mathbb{Z}_{n_k}) \subset \mathcal{A}$$

by $T \mapsto \tilde{T} - T$, where \tilde{T} is obtained from T by the action of the transposition of $\mathbb{Z}_{n_1} \sqcup \dots \sqcup \mathbb{Z}_{n_k}$ given by the exchange of the elements $n_i - 2$ and $n_i - 1$ in position i .

(d) For $i \in \llbracket 1, k \rrbracket$ such that $n_i \geq 2$, let

$$\psi_{(n_1, \dots, n_k, i)} : \mathring{\mathcal{A}}^\wedge(\vec{\emptyset}, \emptyset, \mathbb{Z}_{n_1} \sqcup \dots \sqcup \mathbb{Z}_{n_k}) \longrightarrow \mathcal{A}$$

given by $\psi_{(n_1, \dots, n_k, i)} := \psi_{(n_1, \dots, n_k, i)}^1 + \psi_{(n_1, \dots, n_k, i)}^2$. Let

$$\psi^{\text{STU}} : \bigoplus_{(n_1, \dots, n_k, i) \mid (n_1, \dots, n_k) \in \mathbb{Z}_{\geq 0}^k \text{ and } n_i \geq 2} \mathring{\mathcal{A}}^\wedge(\vec{\emptyset}, \emptyset, \mathbb{Z}_{n_1} \sqcup \dots \sqcup \mathbb{Z}_{n_k}) \longrightarrow \mathcal{A}$$

the map defined by

$$\psi^{\text{STU}} := \sum_{i=1}^k \sum_{n_1, \dots, n_k \geq 0, \text{ with } n_i \geq 2} \psi_{(n_1, \dots, n_k, i)}.$$

Recall that if G is a group acting on a set Σ then $\Sigma^G := \{s \in \Sigma \mid g \cdot s = s\}$ is called the set of *invariant elements* and Σ/G , i.e., the set of all orbits of Σ under the action of G , is called the *quotient set* of the action. If G acts on a \mathbb{C} -vector space V , then V^G is a vector space. If Σ is a G -space, one has $(\mathbb{C}\Sigma)^G = \mathbb{C}(\Sigma^G)$ and $(\mathbb{C}\Sigma)_G = \mathbb{C}(\Sigma/G)$, where the $(\mathbb{C}\Sigma)_G$ denotes the space of coinvariants of the pair $(G, \mathbb{C}\Sigma)$ (see §2.9.2).

Then for any family n_1, \dots, n_k of non-negative integers, the group $\mathbb{Z}_{n_1} \times \dots \times \mathbb{Z}_{n_k}$ acts on the disjoint union $\mathbb{Z}_{n_1} \sqcup \dots \sqcup \mathbb{Z}_{n_k}$, the action of \mathbb{Z}_{n_i} on itself being by the product and the action of \mathbb{Z}_{n_i} on \mathbb{Z}_{n_j} being trivial if $i \neq j$.

Lemma 4.50. *For any $k \geq 1$ and any family n_1, \dots, n_k of non-negative integers, there is a bijection*

$$(4.50) \quad \bigsqcup_{n_1, \dots, n_k \geq 0} \mathring{\text{Jac}}(\vec{\emptyset}, \emptyset, \mathbb{Z}_{n_1} \sqcup \dots \sqcup \mathbb{Z}_{n_k}) / \mathbb{Z}_{n_1} \times \dots \times \mathbb{Z}_{n_k} \longrightarrow \mathring{\text{Jac}}(\vec{\emptyset}, \llbracket 1, k \rrbracket),$$

which induces an isomorphism

$$(4.51) \quad \frac{\bigoplus_{n_1, \dots, n_k \geq 0} \mathring{\mathcal{A}}^\wedge(\vec{\emptyset}, \emptyset, \mathbb{Z}_{n_1} \sqcup \dots \sqcup \mathbb{Z}_{n_k})_{\mathbb{Z}_{n_1} \times \dots \times \mathbb{Z}_{n_k}}}{[\text{Im}(\psi^{\text{STU}})]} \simeq \frac{\bigoplus_{n_1, \dots, n_k \geq 0} \mathring{\mathcal{A}}^\wedge(\vec{\emptyset}, \emptyset, \mathbb{Z}_{n_1} \sqcup \dots \sqcup \mathbb{Z}_{n_k})}{\text{Im}(\psi^{\text{STU}}) + \text{Im}(\varphi^{\text{cyc}})} \simeq \mathring{\mathcal{A}}^\wedge(\vec{\emptyset}, \llbracket 1, k \rrbracket),$$

where ψ^{STU} and φ^{cyc} are as in Definition 4.49 and where $[\text{Im}(\psi^{\text{STU}})]$ is the image of $\text{Im}(\psi^{\text{STU}})$ under the canonical projection $V \rightarrow V_G$ for $V = \bigoplus_{n_1, \dots, n_k \geq 0} \mathring{\mathcal{A}}^\wedge(\vec{\emptyset}, \emptyset, \mathbb{Z}_{n_1} \sqcup \dots \sqcup \mathbb{Z}_{n_k})$ and $G = \bigoplus_{n_1, \dots, n_k \geq 0} \mathbb{Z}_{n_1} \times \dots \times \mathbb{Z}_{n_k}$.

Proof. An element of $\mathring{\text{Jac}}(\vec{\emptyset}, \llbracket 1, k \rrbracket)$ is a triple $(D, \varphi, \{\text{cyc}_s\}_{s \in \llbracket 1, k \rrbracket})$ where D is a vertex-oriented univalent graph, $\varphi : \partial D \rightarrow \llbracket 1, k \rrbracket$ is a map and for $s \in \llbracket 1, k \rrbracket$, cyc_s is a cyclic order on $\varphi^{-1}(s)$. The assignment $(D, \varphi, \{\text{cyc}_s\}_{s \in \llbracket 1, k \rrbracket}) \mapsto (|\varphi^{-1}(1)|, \dots, |\varphi^{-1}(k)|)$ defines a map $\mathring{\text{Jac}}(\vec{\emptyset}, \llbracket 1, k \rrbracket) \rightarrow \mathbb{Z}_{\geq 0}^k$ and therefore a partition $\mathring{\text{Jac}}(\vec{\emptyset}, \llbracket 1, k \rrbracket) = \bigsqcup_{n_1, \dots, n_k \geq 0} \mathring{\text{Jac}}(\vec{\emptyset}, \llbracket 1, k \rrbracket)_{(n_1, \dots, n_k)}$; where an element of $\mathring{\text{Jac}}(\vec{\emptyset}, \llbracket 1, k \rrbracket)_{(n_1, \dots, n_k)}$ is identified with the triple of a vertex-oriented univalent graph D , a partition of ∂D in k components of cardinalities n_1, \dots, n_k and a cyclic order on each of these components.

Notice that a cyclic order on a finite set S is the same as an element of the quotient set $\text{Bij}(S, \mathbb{Z}_{|S|}) / \mathbb{Z}_{|S|}$, where $\text{Bij}(S, \mathbb{Z}_{|S|})$ denotes the set of bijections from S to $\mathbb{Z}_{|S|}$. Therefore each set $\mathring{\text{Jac}}(\vec{\emptyset}, \llbracket 1, k \rrbracket)_{(n_1, \dots, n_k)}$ can be identified with $\mathring{\text{Jac}}(\vec{\emptyset}, \emptyset, \mathbb{Z}_{n_1} \sqcup \dots \sqcup \mathbb{Z}_{n_k}) / \mathbb{Z}_{n_1} \times \dots \times \mathbb{Z}_{n_k}$, which gives the stated bijection.

The bijection (4.50) induces a linear isomorphism

$$\bigoplus_{n_1, \dots, n_k \geq 0} \mathbb{C} \mathring{\text{Jac}}(\vec{\emptyset}, \emptyset, \mathbb{Z}_{n_1} \sqcup \dots \sqcup \mathbb{Z}_{n_k})_{\mathbb{Z}_{n_1} \times \dots \times \mathbb{Z}_{n_k}} \longrightarrow \mathbb{C} \mathring{\text{Jac}}(\vec{\emptyset}, \llbracket 1, k \rrbracket),$$

which gives rise to a morphism

$$\frac{\bigoplus_{n_1, \dots, n_k \geq 0} \mathbb{C} \mathring{\text{Jac}}(\vec{\emptyset}, \emptyset, \mathbb{Z}_{n_1} \sqcup \dots \sqcup \mathbb{Z}_{n_k})}{\text{Im}(\varphi_{\mathring{\text{Jac}}}^{\text{cyc}})} \longrightarrow \mathring{\mathcal{A}}^\wedge(\vec{\emptyset}, \llbracket 1, k \rrbracket),$$

where $\varphi_{\mathring{\text{Jac}}}^{\text{cyc}}$ is the analogue of the map φ^{cyc} between sets of Jacobi diagrams. One checks that it induces a map

$$\frac{\bigoplus_{n_1, \dots, n_k \geq 0} \mathring{\mathcal{A}}^\wedge(\vec{\emptyset}, \emptyset, \mathbb{Z}_{n_1} \sqcup \dots \sqcup \mathbb{Z}_{n_k})}{\text{Im}(\psi^{\text{STU}}) + \text{Im}(\varphi^{\text{cyc}})} \longrightarrow \mathring{\mathcal{A}}^\wedge(\vec{\emptyset}, \llbracket 1, k \rrbracket)$$

and that this map is an isomorphism. The first isomorphism in (4.51) follows since taking coinvariants with respect to the action of $\mathbb{Z}_{n_1} \times \dots \times \mathbb{Z}_{n_k}$ is equivalent to taking the quotient by $[\text{Im}(\varphi^{\text{cyc}})]$. \square

Proposition 4.51. *Let $T_\bullet = (T_m)_{m \geq 0}$ be a diagrammatic trace of bidegree (c, d) (see Lemma 4.40). Set $j^{T_\bullet}[0] := \text{Id} : \mathring{\mathcal{A}}_0^\wedge \rightarrow \mathring{\mathcal{A}}_0^\wedge$ be the identity map. For any integer $k \geq 1$ we can associate to T_\bullet a \mathfrak{S}_k -equivariant continuous linear map $j^{T_\bullet}[k] : \mathring{\mathcal{A}}^\wedge(\vec{\emptyset}, \llbracket 1, k \rrbracket) \rightarrow \mathring{\mathcal{A}}^\wedge(\vec{\emptyset}, \emptyset)$ and therefore a continuous linear map $j^{T_\bullet}[k] : \mathring{\mathcal{A}}_k^\wedge \rightarrow \mathring{\mathcal{A}}_0^\wedge$. The assignment $T_\bullet \mapsto j^{T_\bullet}[k]$ is polynomial of degree k with respect to T_\bullet ; in*

particular, for any $\lambda \in \mathbb{C}$ and $k \geq 1$, we have $j^{\lambda T_\bullet}[k] = \lambda^k j^{T_\bullet}[k]$ and $T_\bullet \mapsto j^{T_\bullet}[1]$ is linear. Moreover, the direct sum

$$(4.52) \quad j^{T_\bullet} = \bigoplus_{k \geq 0} j^{T_\bullet}[k] : \bigoplus_{k \geq 0} \mathring{A}_k^\wedge \longrightarrow \mathring{A}_0^\wedge$$

is an algebra homomorphism and for a homogeneous $x \in \mathring{A}_k^\wedge$ one has

$$(4.53) \quad \deg(j^{T_\bullet}(x)) = \deg(x) + (d - c)k,$$

with \deg being defined on \mathring{A}_k^\wedge and \mathring{A}_0^\wedge as in (3.1).

Proof. Let $k \geq 1$ be an integer. For $n_1, \dots, n_k \geq 0$, the map (3.21) gives rise to a linear map

$$\mathring{A}^\wedge(\vec{\emptyset}, \emptyset, \mathbb{Z}_{n_1}) \otimes \dots \otimes \mathring{A}^\wedge(\vec{\emptyset}, \emptyset, \mathbb{Z}_{n_k}) \longrightarrow \mathring{A}^\wedge(\vec{\emptyset}, \emptyset, \mathbb{Z}_{n_1} \sqcup \dots \sqcup \mathbb{Z}_{n_k}),$$

which restricts to a linear map

$$\mathring{A}^\wedge(\vec{\emptyset}, \emptyset, \mathbb{Z}_{n_1})^{\mathbb{Z}_{n_1}} \otimes \dots \otimes \mathring{A}^\wedge(\vec{\emptyset}, \emptyset, \mathbb{Z}_{n_k})^{\mathbb{Z}_{n_k}} \longrightarrow \mathring{A}^\wedge(\vec{\emptyset}, \emptyset, \mathbb{Z}_{n_1} \sqcup \dots \sqcup \mathbb{Z}_{n_k})^{\mathbb{Z}_{n_1} \times \dots \times \mathbb{Z}_{n_k}}.$$

If G is a group, if V, W are G -modules and Z is a vector space, then any G -invariant linear map $V \otimes W \rightarrow Z$ induces a linear map $V^G \otimes W^G \rightarrow Z$, obtained by factorization of its restriction to $V^G \otimes W^G$. It follows that in the situation of the pairing (3.20), if Σ is equipped with an action of a group G , it induces a pairing

$$\mathring{A}^\wedge(P, S, \Sigma)^G \otimes \mathring{A}^\wedge(P', S', \Sigma)_G \longrightarrow \mathring{A}^\wedge(P \otimes P', S \sqcup S').$$

In our case, we obtain the pairing

$$\mathring{A}^\wedge(\vec{\emptyset}, \emptyset, \mathbb{Z}_{n_1} \sqcup \dots \sqcup \mathbb{Z}_{n_k})^{\mathbb{Z}_{n_1} \times \dots \times \mathbb{Z}_{n_k}} \otimes \mathring{A}^\wedge(\vec{\emptyset}, \emptyset, \mathbb{Z}_{n_1} \sqcup \dots \sqcup \mathbb{Z}_{n_k})_{\mathbb{Z}_{n_1} \times \dots \times \mathbb{Z}_{n_k}} \longrightarrow \mathring{A}^\wedge(\vec{\emptyset}, \emptyset).$$

In particular, the pairing with $T_{n_1} \otimes \dots \otimes T_{n_k} \in \mathring{A}^\wedge(\vec{\emptyset}, \emptyset, \mathbb{Z}_{n_1} \sqcup \dots \sqcup \mathbb{Z}_{n_k})_{\mathbb{Z}_{n_1} \times \dots \times \mathbb{Z}_{n_k}}$, induces a linear map

$$(4.54) \quad \langle T_{n_1} \otimes \dots \otimes T_{n_k}, \bullet \rangle : \mathring{A}^\wedge(\vec{\emptyset}, \emptyset, \mathbb{Z}_{n_1} \sqcup \dots \sqcup \mathbb{Z}_{n_k})_{\mathbb{Z}_{n_1} \times \dots \times \mathbb{Z}_{n_k}} \longrightarrow \mathring{A}^\wedge(\vec{\emptyset}, \emptyset),$$

the direct sum over $n_1, \dots, n_k \geq 0$ gives rise to the linear map

$$(4.55) \quad \bigoplus_{n_1, \dots, n_k \geq 0} \langle T_{n_1} \otimes \dots \otimes T_{n_k}, \bullet \rangle : \bigoplus_{n_1, \dots, n_k \geq 0} \mathring{A}^\wedge(\vec{\emptyset}, \emptyset, \mathbb{Z}_{n_1} \sqcup \dots \sqcup \mathbb{Z}_{n_k})_{\mathbb{Z}_{n_1} \times \dots \times \mathbb{Z}_{n_k}} \longrightarrow \mathring{A}^\wedge(\vec{\emptyset}, \emptyset).$$

By the STU-compatibility of T_\bullet (see Definition 4.39), the map (4.55) gives rise, by factorization, to a map

$$(4.56) \quad \bigoplus_{n_1, \dots, n_k \geq 0} \langle T_{n_1} \otimes \dots \otimes T_{n_k}, \bullet \rangle : \frac{\bigoplus_{n_1, \dots, n_k \geq 0} \mathring{A}^\wedge(\vec{\emptyset}, \emptyset, \mathbb{Z}_{n_1} \sqcup \dots \sqcup \mathbb{Z}_{n_k})_{\mathbb{Z}_{n_1} \times \dots \times \mathbb{Z}_{n_k}}}{\text{Im}(\psi^{\text{STU}})} \longrightarrow \mathring{A}^\wedge(\vec{\emptyset}, \emptyset),$$

where ψ^{STU} is as in Definition 4.49(d). Using Lemma 4.50, one then defines a linear map

$$(4.57) \quad j^{T_\bullet}[k] : \mathring{A}^\wedge(\vec{\emptyset}, [1, k]) \stackrel{(4.51)}{\simeq} \frac{\bigoplus_{n_1, \dots, n_k \geq 0} \mathring{A}^\wedge(\vec{\emptyset}, \emptyset, \mathbb{Z}_{n_1} \sqcup \dots \sqcup \mathbb{Z}_{n_k})_{\mathbb{Z}_{n_1} \times \dots \times \mathbb{Z}_{n_k}}}{\text{Im}(\psi^{\text{STU}})} \stackrel{(4.56)}{\longrightarrow} \mathring{A}^\wedge(\vec{\emptyset}, \emptyset)$$

The map (4.57) is described schematically in Figure 4.27.

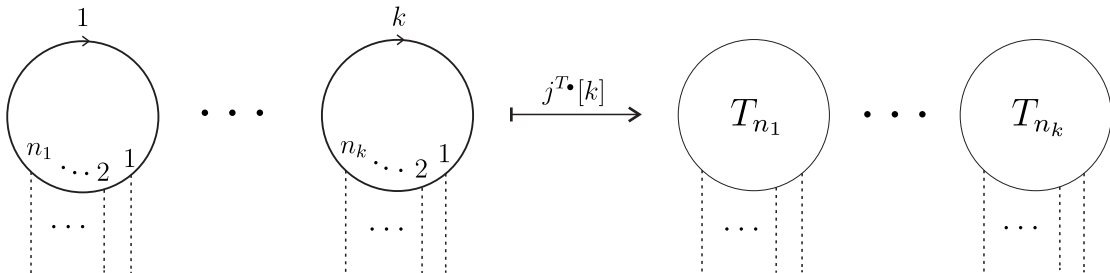

FIGURE 4.27. Schematic representation of the map (4.57).

This map is \mathfrak{S}_k -invariant, therefore it induces a linear map $j^{T_\bullet}[k] : \mathring{\mathcal{A}}_k^\wedge \rightarrow \mathring{\mathcal{A}}_0^\wedge$. We then check that the direct sum $j^{T_\bullet} = \bigoplus_{k \geq 0} j^{T_\bullet}[k] : \bigoplus_{k \geq 0} \mathring{\mathcal{A}}_k^\wedge \rightarrow \mathring{\mathcal{A}}_0^\wedge$ is an algebra homomorphism and that for $x \in \mathring{\mathcal{A}}_k^\wedge$ one has $\deg(j^{T_\bullet}(x)) = \deg(x) + (d-c)k$. \square

By Lemma 4.41, for integer $n \geq 1$ the n -th power $(T_\bullet^{\text{LMO}})^{*n}$ of the LMO diagrammatic trace T_\bullet^{LMO} (see Lemma 4.44) is a diagrammatic trace.

Definition 4.52. Let $n \geq 1$ be an integer. Define the algebra homomorphism

$$(4.58) \quad j_n^{\text{LMO}} : \bigoplus_{k \geq 0} \mathring{\mathcal{A}}_k^\wedge \longrightarrow \mathring{\mathcal{A}}_0^\wedge$$

as the morphism associated by Proposition 4.51 to the n -th power $(T_\bullet^{\text{LMO}})^{*n}$ of the LMO diagrammatic trace T_\bullet^{LMO} .

Specializing (4.53) to the LMO diagrammatic trace, for $x \in \mathring{\mathcal{A}}_k^\wedge$ one has

$$(4.59) \quad \deg(j_n^{\text{LMO}}(x)) = \deg(x) - kn,$$

where \deg is as in (3.1).

Definition 4.53. Let $n \geq 1$ be an integer and S a finite set. Define a map $\mathbb{C}\mathring{\text{Jac}}(\vec{\emptyset}, S) \rightarrow \mathbb{C}\mathring{\text{Jac}}(\vec{\emptyset}, S \times \llbracket 1, n \rrbracket)$ by

$$(4.60) \quad \underline{D} = (D, \varphi : \partial D \rightarrow S, \{\text{cyc}_s\}_{s \in S}) \longmapsto \underline{D}^{(n)} := \sum_{\psi : \partial D \rightarrow S \times \llbracket 1, n \rrbracket \mid \text{pr}_1 \circ \psi = \varphi} (D, \psi, \{\text{cyc}_{(s,i)}^\psi\}_{(s,i) \in S \times \llbracket 1, n \rrbracket})$$

where $\text{pr}_1 : S \times \llbracket 1, n \rrbracket \rightarrow S$ is the projection on the first component and for any $\psi : \partial D \rightarrow S \times \llbracket 1, n \rrbracket$ such that $\text{pr}_1 \circ \psi = \varphi$ and any $(s, i) \in S \times \llbracket 1, n \rrbracket$, we denote by $\text{cyc}_{(s,i)}^\psi$ the cyclic order on $\psi^{-1}(s, i) \subset \varphi^{-1}(s)$ induced by the restriction of the cyclic order cyc_s on $\varphi^{-1}(s)$.

Lemma 4.54. Let $n, k \geq 1$ be integers. For any diagrammatic trace T_\bullet and $\underline{D} \in \mathring{\text{Jac}}(\vec{\emptyset}, \llbracket 1, k \rrbracket)$, one has

$$j^{(T_\bullet)^{*n}}([\underline{D}]) = \frac{1}{(n!)^k} j^{T_\bullet}([\underline{D}^{(n)}]).$$

In particular, specializing to the LMO diagrammatic trace, one has

$$j_n^{\text{LMO}}([\underline{D}]) = \frac{1}{(n!)^k} j_1^{\text{LMO}}([\underline{D}^{(n)}]).^5$$

Proof. For E a finite set, denote by $\text{Part}_n(E)$ the set of ordered n -partitions of E , and by $\text{UPart}_n(E) := \text{Part}_n(E)/\mathfrak{S}_n$ the set of its unordered n -partitions. Let $\underline{D} = (D, \varphi : \partial D \rightarrow \llbracket 1, k \rrbracket, \{\text{cyc}_s\}_{s \in \llbracket 1, k \rrbracket}) \in \mathring{\text{Jac}}(\vec{\emptyset}, \llbracket 1, k \rrbracket)$. To each $((A_1^1, \dots, A_n^1), \dots, (A_1^k, \dots, A_n^k)) \in \text{Part}_n(\varphi^{-1}(1)) \times \dots \times \text{Part}_n(\varphi^{-1}(k))$ attach the map $\psi : \partial D \rightarrow \llbracket 1, k \rrbracket \times \llbracket 1, n \rrbracket$ such that $\psi(A_i^s) := (s, i)$. Then the assignment

$$((A_1^1, \dots, A_n^1), \dots, (A_1^k, \dots, A_n^k)) \longmapsto j^{T_\bullet}(D, \psi, \{\text{cyc}_{(s,i)}^\psi\}_{(s,i) \in \llbracket 1, k \rrbracket \times \llbracket 1, n \rrbracket}),$$

where $\text{cyc}_{(s,i)}^\psi$ is as in Definition 4.53, is a map

$$\text{Part}_n(\varphi^{-1}(1)) \times \dots \times \text{Part}_n(\varphi^{-1}(k)) \longrightarrow \mathbb{C}\mathring{\text{Jac}}(\vec{\emptyset}, \emptyset).$$

It factors through a map

$$\text{UPart}_n(\varphi^{-1}(1)) \times \dots \times \text{UPart}_n(\varphi^{-1}(k)) \longrightarrow \mathbb{C}\mathring{\text{Jac}}(\vec{\emptyset}, \emptyset).$$

The element $j^{T_\bullet}([\underline{D}^{(n)}])$ (resp. $j^{(T_\bullet)^{*n}}([\underline{D}])$) is equal to the sum of the classes in $\mathring{\mathcal{A}}^\wedge(\vec{\emptyset}, \emptyset)$ of the images of the former (resp. latter) map. The result then follows from the fact that the fibers of the projection $\text{Part}_n(\varphi^{-1}(1)) \times \dots \times \text{Part}_n(\varphi^{-1}(k)) \rightarrow \text{UPart}_n(\varphi^{-1}(1)) \times \dots \times \text{UPart}_n(\varphi^{-1}(k))$ are all of cardinality $(n!)^k$. \square

⁵In [41, pag. 281], there is typo, the factor $1/n!$ should be $1/(n!)^l$.

4.5.3. The algebra $\mathfrak{c}(n)$.

Definition 4.55. Let X be the element in $\mathring{\mathcal{A}}_0^\wedge$ defined as the class of the connected Jacobi diagram without trivalent vertices (dashed loop). Notice that it has degree 0.

Definition 4.56. Define O^n to be the closed ideal of the commutative algebra $\mathring{\mathcal{A}}_0^\wedge$ generated by $X + 2n$. Since $X + 2n$ is homogeneous of degree 0, then O^n is a complete graded ideal of $\mathring{\mathcal{A}}_0^\wedge$.

Recall that P_0^{n+1} is a complete graded ideal of $\mathring{\mathcal{A}}_0^\wedge$ (see Definition 4.30(c)). Hence $P_0^{n+1} + O^n$ is also a complete graded ideal of $\mathring{\mathcal{A}}_0^\wedge$.

Definition 4.57. Define the complete graded commutative algebra $\mathfrak{c}(n)$ as the quotient algebra

$$(4.61) \quad \mathfrak{c}(n) = \frac{\mathring{\mathcal{A}}_0^\wedge}{P_0^{n+1} + O^n}.$$

4.5.4. The algebra morphism $\bar{j}_n : \mathfrak{b}(n) \rightarrow \mathfrak{c}(n)$.

Lemma 4.58. Let $k \geq 1$ be an integer. Then $j_1^{\text{LMO}} = j_1^{\text{LMO}} \circ \text{co}_k^A$. Here $\text{co}_k^A : \mathring{\mathcal{A}}^\wedge(\vec{\emptyset}, \llbracket 1, k \rrbracket)_{\mathfrak{S}_{k-1}} \rightarrow \mathring{\mathcal{A}}_k^\wedge$ is the change of orientation map from Lemma 2.105 specialized to the pre-LMO structure \mathbf{A} .

Proof. The space $\mathring{\mathcal{A}}_k^\wedge$ is topologically spanned by the classes of elements in $\bigsqcup_{n_1, \dots, n_k \geq 0} \mathring{\text{Jac}}(\vec{\emptyset}, \emptyset, \mathbb{Z}_{n_1} \times \dots \times \mathbb{Z}_{n_k}) / \mathbb{Z}_{n_1} \times \dots \times \mathbb{Z}_{n_k}$, see Lemma 4.50. For $\underline{D} \in \mathring{\text{Jac}}(\vec{\emptyset}, \emptyset, \mathbb{Z}_{n_1} \times \dots \times \mathbb{Z}_{n_k})$, the image of the corresponding element in $\mathring{\mathcal{A}}^\wedge(\vec{\emptyset}, \llbracket 1, k \rrbracket)_{\mathfrak{S}_{k-1}}$ under co_k^A is $(-1)^{n_1}$ times class of the element obtained from \underline{D} by the automorphism of $\mathbb{Z}_{n_1} \times \dots \times \mathbb{Z}_{n_k}$ given by the action of -1 on the first component. The image of the latter element by j_1^{LMO} is therefore the pairing with $(-1)^{n_1}$ times the effect of the action of same automorphism of $\mathbb{Z}_{n_1} \times \dots \times \mathbb{Z}_{n_k}$ on the disjoint union of $T_{n_1}^{\text{LMO}}, \dots, T_{n_k}^{\text{LMO}}$. By [31, Lemma 2.5], this element coincides with the disjoint union of $T_{n_1}^{\text{LMO}}, \dots, T_{n_k}^{\text{LMO}}$ therefore the image by $j_1^{\text{LMO}} \circ \text{co}_k^A$ of the corresponding element associated to \underline{D} coincides with its image under j_1^{LMO} . \square

Proposition 4.59. We have

$$j_n^{\text{LMO}}(L^{<2n} + P^{n+1} + (\text{CO}\mathring{\mathcal{A}}^\wedge)) \subset P_0^{n+1} \subset P_0^{n+1} + O^n.$$

Therefore, j_n^{LMO} induces an algebra homomorphism

$$(4.62) \quad \bar{j}_n : \mathfrak{b}(n) \longrightarrow \mathfrak{c}(n),$$

where $\mathfrak{b}(n)$ is as in (4.44) and $\mathfrak{c}(n)$ as in (4.61).

Proof. Let $k \geq 0$ be an integer and $\underline{D} = (D, \varphi, \{\text{cyc}_s\}_{s \in \llbracket 1, k \rrbracket}) \in \mathring{\text{Jac}}(\vec{\emptyset}, \llbracket 1, k \rrbracket)$ and $i \in \llbracket 1, k \rrbracket$ be such that $|\varphi^{-1}(i)| < 2n$, that is $[\underline{D}] \in L^{<2n}(k)$. In what follows, we use the notation from the proof of Lemma 4.54. Any $(A_1^i, \dots, A_n^i) \in \text{Part}_n(\varphi^{-1}(i))$ is such that for some $s \in \llbracket 1, n \rrbracket$ we have $|A_s^i| < 2$. This implies $j_1^{\text{LMO}}([\underline{D}^{(n)}]) = 0$, which by Lemma 4.53 implies $j_n^{\text{LMO}}([\underline{D}]) = 0$. Therefore, $j_n^{\text{LMO}}(L^{<2n}) = 0$, and hence $j_n^{\text{LMO}}(L^{<2n}) = 0$.

For $\underline{D} = (D, \varphi, \{\text{cyc}_s\}_{s \in \llbracket 1, k \rrbracket}) \in \mathring{\text{Jac}}(\vec{\emptyset}, \llbracket 1, k \rrbracket)$ and $X \subset \llbracket 1, k \rrbracket$, let

$$\text{co}_X(\underline{D}) := (-1)^{|\varphi^{-1}(X)|} (D, \varphi, \{\text{cyc}_s\}_{s \in \llbracket 1, k \rrbracket}^X),$$

where $\text{cyc}_s^X := \text{cyc}_s$ if $s \notin X$ and $\text{cyc}_s^X := \overline{\text{cyc}}_s$ if $s \in X$. Then for $\underline{D} \in \mathring{\text{Jac}}(\vec{\emptyset}, \llbracket 1, k \rrbracket)$ one has

$$\begin{aligned} j_n^{\text{LMO}}([\text{co}_1(\underline{D})]) &= \frac{1}{(n!)^k} j_1^{\text{LMO}}([\text{co}_1(\underline{D})^{(n)}]) = \frac{1}{(n!)^k} j_1^{\text{LMO}}([\text{co}_{1 \times \llbracket 1, k \rrbracket}(\underline{D})^{(n)}]) \\ &= \frac{1}{(n!)^k} j_1^{\text{LMO}}([\text{co}_{(1,1)} \circ \dots \circ \text{co}_{(1,k)}(\underline{D})^{(n)}]) = \frac{1}{(n!)^k} j_1^{\text{LMO}}([\underline{D}^{(n)}]) = j_n^{\text{LMO}}([\underline{D}]) \end{aligned}$$

(using Lemma 4.58 and Lemma 4.54), which implies that $j_n^{\text{LMO}}((\text{CO}\mathring{\mathcal{A}}^\wedge)) = 0$.

For T_\bullet a diagrammatic trace and $k, l \geq 1$, one defines similarly to the map $j^{T_\bullet}[k]$ from (4.52) a map

$$(4.63) \quad j^{T_\bullet}[k, l] : \mathring{A}^\wedge(\vec{\partial}, \llbracket 1, k \rrbracket, \llbracket 1, l \rrbracket) \longrightarrow \mathring{A}^\wedge(\vec{\partial}, \emptyset, \llbracket 1, l \rrbracket)$$

such that for any $\sigma \in \mathring{A}^\wedge(\vec{\partial}, \emptyset, \llbracket 1, l \rrbracket)$, one has $j^{T_\bullet}[k] \circ \langle \cdot, \sigma \rangle = \langle \cdot, \sigma \rangle \circ j^{T_\bullet}[k, l]$ (equality of maps $\mathring{A}^\wedge(\vec{\partial}, \llbracket 1, k \rrbracket, \llbracket 1, l \rrbracket) \longrightarrow \mathring{A}^\wedge(\vec{\partial}, \emptyset, \emptyset)$), where $\langle \cdot, \cdot \rangle$ is as in (3.20). Specializing to $T_\bullet = (T^{\text{LMO}})^{*n}$, $l := 2(n+1)$ and $\sigma := \varsigma_{n+1}$ (from Definition 4.29), one obtains the second equality in

$$\begin{aligned} j_n^{\text{LMO}}[k](P^{n+1}(\vec{\partial}, \llbracket 1, k \rrbracket)) &= j_n^{\text{LMO}}[k] \left(\langle \mathring{A}^\wedge(\vec{\partial}, \llbracket 1, k \rrbracket, \llbracket 1, 2(n+1) \rrbracket), \varsigma_{n+1} \rangle \right) \\ &= \left\langle j^{(T^{\text{LMO}})^{*n}}[k, 2n](\mathring{A}^\wedge(\vec{\partial}, \llbracket 1, k \rrbracket, \llbracket 1, 2(n+1) \rrbracket)), \varsigma_{n+1} \right\rangle \\ &\subset \left\langle \mathring{A}^\wedge(\vec{\partial}, \emptyset, \llbracket 1, 2(n+1) \rrbracket), \varsigma_{n+1} \right\rangle \\ &= P^{n+1}(\vec{\partial})_0 = P_0^{n+1} \end{aligned}$$

where the first and last equalities follow from Definition 4.30. Therefore $j_n^{\text{LMO}}[k](P_k^{n+1}) \subset P_0^{n+1}$ and hence $j_n^{\text{LMO}}(P^{n+1}) \subset P_0^{n+1}$. \square

Since $(\mathfrak{b}(n), \varphi_n \circ \overline{\text{cs}}^\nu \circ \hat{Z})$ is a semi-Kirby structure, then by Lemma 2.86, the pair $(\mathfrak{c}(n), \bar{j}_n \circ \varphi_n \circ \overline{\text{cs}}^\nu \circ \hat{Z})$ is also a semi-Kirby structure.

4.5.5. *The Kirby structure $(\mathfrak{c}(n), \bar{j}_n \circ \varphi_n \circ \overline{\text{cs}}^\nu \circ \hat{Z})$.* In this subsection we prove that the semi-Kirby structure $(\mathfrak{c}(n), \bar{j}_n \circ \varphi_n \circ \overline{\text{cs}}^\nu \circ \hat{Z})$ is in fact a Kirby structure (Theorem 4.67). In order to do this, we need to prove that the elements $\bar{j}_n \circ \varphi_n \circ \overline{\text{cs}}^\nu \circ \hat{Z}(U^\pm) \in \mathring{A}_0^\wedge / (P_0^{n+1} + O^n)$ are invertible.

In view of this we will compute explicitly the degree 0 part

$$(\mathring{A}_0^\wedge / P_0^{n+1})[0] = \mathring{A}_0^\wedge[0] / (\mathring{A}_0^\wedge[0] \cap P_0^{n+1})$$

of the quotient algebra $\mathring{A}_0^\wedge / P_0^{n+1}$. This will be done in Proposition 4.62 based on a result (Lemma 4.61) on fixed-point free involutions. Recall that we denote by $\text{FPFI}(S)$ the set of fixed-point free involutions of a set S .

Definition 4.60. Let S be a set.

(a) Define the map

$$(4.64) \quad ((\cdot, \cdot)) : \text{FPFI}(S) \times \text{FPFI}(S) \longrightarrow \mathbb{Z}_{>0}$$

by $((\sigma, \tau)) = |S / \langle \sigma, \tau \rangle|$, i.e., the number of orbits of the action of the subgroup $\langle \sigma, \tau \rangle \leq \mathfrak{S}_S$ generated by $\sigma, \tau \in \text{FPFI}(S)$ on the set S .

(b) Define the bilinear map

$$(4.65) \quad \langle\langle \cdot, \cdot \rangle\rangle : \mathbb{Z}\text{FPFI}(S) \times \mathbb{Z}\text{FPFI}(S) \longrightarrow \mathbb{Z}[X]$$

by $\langle\langle \sigma, \tau \rangle\rangle = X^{((\sigma, \tau))}$ for any $\sigma, \tau \in \text{FPFI}(S)$.

Lemma 4.61. Let S be a set with $|S|$ even and $\sigma_0 \in \text{FPFI}(S)$. Then

$$(4.66) \quad \sum_{\sigma \in \text{FPFI}(S)} \langle\langle \sigma_0, \sigma \rangle\rangle = X(X+2) \cdots (X+2(|S|-1)).$$

Proof. For a polynomial $Q(X)$ we denote by $c_{X^k}(Q(X))$ the coefficient of X^k in $Q(X)$. Set $m := |S|/2$, we may assume that $S = \llbracket 1, 2m \rrbracket$ and $\sigma_0 = (12) \cdots (2m-1, 2m) \in \text{FPFI}(\llbracket 1, 2m \rrbracket)$. We have

$$\sum_{\sigma \in \text{FPFI}(\llbracket 1, 2m \rrbracket)} \langle\langle \sigma_0, \sigma \rangle\rangle = \sum_{k \geq 0} \left| \{ \sigma \in \text{FPFI}(\llbracket 1, 2m \rrbracket) \mid \langle\langle \sigma_0, \sigma \rangle\rangle = |\llbracket 1, 2m \rrbracket / \langle \sigma, \tau \rangle| = k \} \right| X^k.$$

Besides, it is well know that

$$(4.67) \quad \sum_{k \geq 0} \left| \{ \sigma \in \mathfrak{S}_m \mid \sigma \text{ has } k \text{ cycles} \} \right| X^k = X(X+1) \cdots (X+(m-1)),$$

see for instance [50, Proposition 1.3.4]. Hence,

$$\begin{aligned} c_{X^k}(X(X+2) \cdots (X+2(m-1))) &= 2^{m-k} c_{X^k}(X(X+1) \cdots (X+(m-1))) \\ &= 2^{n-k} \left| \{ \sigma \in \mathfrak{S}_m \mid \sigma \text{ has } k \text{ cycles} \} \right|. \end{aligned}$$

Therefore, we need to show the equality

$$(4.68) \quad \left| \{ \sigma \in \text{FPFI}(\llbracket 1, 2m \rrbracket) \mid \langle \langle \sigma_0, \sigma \rangle \rangle = \llbracket 1, 2m \rrbracket / \langle \sigma_0, \sigma \rangle \mid = k \} \right| = 2^{m-k} \left| \{ \sigma \in \mathfrak{S}_m \mid \sigma \text{ has } k \text{ cycles} \} \right|.$$

We set

$$(4.69) \quad A = \left\{ (\sigma, (x_\omega)_{\omega \in \llbracket 1, 2m \rrbracket / \langle \sigma, \sigma_0 \rangle}) \mid \sigma \in \text{FPFI}(\llbracket 1, 2m \rrbracket) \text{ and } \forall \omega \in \llbracket 1, 2m \rrbracket / \langle \sigma, \sigma_0 \rangle : x_\omega \in \omega / \langle \sigma \sigma_0 \rangle \right\},$$

and

$$(4.70) \quad B = \left\{ (\tau, \lambda) \left| \begin{array}{l} \tau \in \mathfrak{S}_{\llbracket 1, 2m \rrbracket / \langle \sigma_0 \rangle} \text{ and} \\ \lambda : \llbracket 1, 2m \rrbracket / \langle \sigma_0 \rangle \rightarrow \llbracket 1, 2m \rrbracket \text{ is a section} \\ \text{of the projection } \pi : \llbracket 1, 2m \rrbracket \rightarrow \llbracket 1, 2m \rrbracket / \langle \sigma_0 \rangle \end{array} \right. \right\}.$$

Let us construct a map $f : A \rightarrow B$. Let $(\sigma, (x_\omega)_{\omega \in \llbracket 1, 2m \rrbracket / \langle \sigma, \sigma_0 \rangle}) \in A$. Each $\omega \in \llbracket 1, 2m \rrbracket / \langle \sigma, \sigma_0 \rangle$ is an orbit of $\langle \sigma, \sigma_0 \rangle$ in $\llbracket 1, 2m \rrbracket$, therefore is a $\langle \sigma, \sigma_0 \rangle$ -invariant subset of $\llbracket 1, 2m \rrbracket$. For each $\omega \in \llbracket 1, 2m \rrbracket / \langle \sigma, \sigma_0 \rangle$, x_ω is an orbit of the action of $\langle \sigma \sigma_0 \rangle$ on ω therefore it is a $\langle \sigma \sigma_0 \rangle$ -invariant subset of ω . The various $\omega \in \llbracket 1, 2m \rrbracket / \langle \sigma, \sigma_0 \rangle$ are disjoint subsets of $\llbracket 1, 2m \rrbracket$ therefore the various $x_\omega, \omega \in \llbracket 1, 2m \rrbracket / \langle \sigma, \sigma_0 \rangle$ are disjoint $\langle \sigma \sigma_0 \rangle$ -invariant subsets of $\llbracket 1, 2m \rrbracket$. Their union $\cup_{\omega \in \llbracket 1, 2m \rrbracket / \langle \sigma, \sigma_0 \rangle} x_\omega$ is therefore a $\langle \sigma \sigma_0 \rangle$ -invariant subset of $\llbracket 1, 2m \rrbracket$. Hence, the inclusion map

$$\iota : \bigsqcup_{\omega \in \llbracket 1, 2m \rrbracket / \langle \sigma, \sigma_0 \rangle} x_\omega \hookrightarrow \llbracket 1, 2m \rrbracket$$

is injective and equivariant under the action of $\sigma \sigma_0$.

Since each x_ω is $\langle \sigma \sigma_0 \rangle$ -invariant, then the union $\sqcup_{\omega \in \llbracket 1, 2m \rrbracket / \langle \sigma, \sigma_0 \rangle} x_\omega$ is equipped with a permutation denoted $(\sigma \sigma_0)_{|\sqcup_{\omega} x_\omega}$.

Consider the map

$$(4.71) \quad b := \pi \circ \iota : \bigsqcup_{\omega \in (\llbracket 1, 2m \rrbracket / \langle \sigma, \sigma_0 \rangle)} x_\omega \hookrightarrow \llbracket 1, 2m \rrbracket \longrightarrow \llbracket 1, 2m \rrbracket / \langle \sigma_0 \rangle.$$

Notice that each ω is a finite set equipped with a transitive action of the group $\mathbb{Z} \rtimes \mathbb{Z}_2$, where the generator of \mathbb{Z} acts by $\sigma \sigma_0$ and the generator of \mathbb{Z}_2 acts by σ_0 . One can show that such $\mathbb{Z} \rtimes \mathbb{Z}_2$ -sets correspond bijectively to $\mathbb{Z}_{\geq 0}$, the $\mathbb{Z} \rtimes \mathbb{Z}_2$ -set corresponding to $k \in \mathbb{Z}_{\geq 0}$ being $\mathbb{Z}_k \times \{1, -1\}$, the action of σ_0 being $\text{Id} \times (\epsilon \mapsto -\epsilon)$ and the action of $\sigma \sigma_0$ being given by $(a, \epsilon) \mapsto (a + \epsilon, \epsilon)$. It follows from this description that such a $\mathbb{Z} \rtimes \mathbb{Z}_2$ -set E is such that $E / \langle \sigma \sigma_0 \rangle$ has cardinality 2 and that for each $x_E \in E / \langle \sigma \sigma_0 \rangle$, the composition $x_E \hookrightarrow E \rightarrow E / \langle \sigma_0 \rangle$ is bijective. In particular, for each $\omega \in \llbracket 1, 2m \rrbracket / \langle \sigma, \sigma_0 \rangle$, the composition $x_\omega \hookrightarrow \omega \rightarrow \omega / \langle \sigma_0 \rangle$ is bijective. The disjoint union over $\omega \in \llbracket 1, 2m \rrbracket / \langle \sigma, \sigma_0 \rangle$, of these maps is therefore a bijection, and as it identifies with (4.71), the latter map is a bijection.

Let $\tau = b \circ (\sigma \sigma_0)_{|\sqcup_{\omega} x_\omega} \circ b^{-1} \in \mathfrak{S}_{\llbracket 1, 2m \rrbracket / \langle \sigma_0 \rangle}$ and $\lambda = \iota \circ b^{-1} : \llbracket 1, 2m \rrbracket / \langle \sigma_0 \rangle \rightarrow \llbracket 1, 2m \rrbracket$. Since $b = \pi \circ \iota$ and b is bijective, one has $\pi \circ (\iota \circ b^{-1}) = \pi \circ \lambda = \text{Id}_{\llbracket 1, 2m \rrbracket / \langle \sigma, \sigma_0 \rangle}$, therefore λ is a section of $\pi : \llbracket 1, 2m \rrbracket \rightarrow \llbracket 1, 2m \rrbracket / \langle \sigma_0 \rangle$. It follows that $(\tau, \lambda) \in B$. One can then define $f : A \rightarrow B$ by

$$(4.72) \quad f(\sigma, (x_\omega)_{\omega \in (\llbracket 1, 2m \rrbracket / \langle \sigma, \sigma_0 \rangle)}) = (\tau, \lambda) \in B.$$

Define a map $g : B \rightarrow A$ as follows. Let $(\tau, \lambda) \in B$, then $\lambda : \llbracket 1, 2m \rrbracket / \langle \sigma_0 \rangle \rightarrow \llbracket 1, 2m \rrbracket$ is an injection. Moreover, it follows from $\langle \sigma_0 \rangle \simeq \mathbb{Z}_2$ and from the freeness of the action of $\langle \sigma_0 \rangle$ on $\llbracket 1, 2m \rrbracket$ that

$$\llbracket 1, 2m \rrbracket = \lambda(\llbracket 1, 2m \rrbracket / \langle \sigma_0 \rangle) \sqcup \sigma_0(\lambda(\llbracket 1, 2m \rrbracket / \langle \sigma_0 \rangle)).$$

Therefore, we have a bijection

$$(4.73) \quad \tilde{b} : ([1, 2m]/\langle\sigma_0\rangle) \times \{0, 1\} \longrightarrow [1, 2m]$$

given by $\tilde{b}(\underline{a}, 0) = \lambda(\underline{a})$ and $\tilde{b}(\underline{a}, 1) = \sigma_0(\lambda(\underline{a}))$ for any $\underline{a} \in [1, 2m]/\langle\sigma_0\rangle$.

Besides, consider the permutation $\tilde{\sigma}$ of $([1, 2m]/\langle\sigma_0\rangle) \times \{0, 1\}$ given by

$$(4.74) \quad \tilde{\sigma} : ([1, 2m]/\langle\sigma_0\rangle) \times \{0, 1\} \longrightarrow ([1, 2m]/\langle\sigma_0\rangle) \times \{0, 1\}$$

given by $\tilde{\sigma}(\underline{a}, 0) = (\tau^{-1}(\underline{a}), 1)$ and $\tilde{\sigma}(\underline{a}, 1) = (\tau(\underline{a}), 0)$ for any $\underline{a} \in [1, 2m]/\langle\sigma_0\rangle$. Clearly, $\tilde{\sigma}$ is a fixed-point free involution of $([1, 2m]/\langle\sigma_0\rangle) \times \{0, 1\}$.

Set $\hat{\sigma} := \tilde{b} \circ \tilde{\sigma} \circ \tilde{b}^{-1} \in \text{FPFI}([1, 2m])$. For $\omega \in [1, 2m]/\langle\hat{\sigma}, \sigma_0\rangle$, define $x_\omega := \omega \cap \lambda([1, 2m]/\langle\sigma_0\rangle)$, i.e., one of the two orbits of the action of $\langle\hat{\sigma}\sigma_0\rangle$ on ω . Thus, $x_\omega \in \omega/\langle\hat{\sigma}\sigma_0\rangle$. We set

$$(4.75) \quad g(\tau, \lambda) = (\hat{\sigma}, (x_\omega)_{\omega \in [1, 2m]/\langle\hat{\sigma}, \sigma_0\rangle}) \in A.$$

One checks that $f \circ g = \text{Id}_B$ and $g \circ f = \text{Id}_A$, that is, f is bijective.

Consider the maps

$$(4.76) \quad p_A : A \longrightarrow \mathbb{Z}_{\geq 0} \quad \text{and} \quad p_B : B \longrightarrow \mathbb{Z}_{\geq 0}$$

given by

$$p_A(\sigma, (x_\omega)_{\omega \in [1, 2m]/\langle\sigma, \sigma_0\rangle}) = |[1, 2m]/\langle\sigma, \sigma_0\rangle| \quad \text{and} \quad p_B(\tau, \lambda) = |([1, 2m]/\langle\sigma_0\rangle)/\langle\tau\rangle|,$$

for any $(\sigma, (x_\omega)_{\omega \in [1, 2m]/\langle\sigma, \sigma_0\rangle}) \in A$ and any $(\tau, \lambda) \in B$. One checks that the diagram

$$\begin{array}{ccc} A & \xrightarrow{f} & B \\ & \searrow p_A & \downarrow p_B \\ & & \mathbb{Z}_{\geq 0} \end{array}$$

commutes. As a consequence, we have

$$(4.77) \quad |p_A^{-1}(k)| = |p_B^{-1}(k)|$$

for any $k \in \mathbb{Z}_{\geq 0}$. Let us compute these cardinalities.

There is a map $\pi : A \rightarrow \text{FPFI}([1, 2m])$ given by $\pi(\sigma, (x_\omega)_{\omega \in [1, 2m]/\langle\sigma, \sigma_0\rangle}) = \sigma$. It follows from the classification of transitive finite $\mathbb{Z} \times \mathbb{Z}_2$ -sets that if ω is an orbit of σ in $[1, 2m]$, then $|\omega/\langle\sigma\sigma_0\rangle| = 2$. For $\sigma \in \text{FPFI}([1, 2m])$, the fiber over σ of $A \rightarrow \text{FPFI}([1, 2m])$ is in bijection with $\prod_{\omega \in [1, 2m]/\langle\sigma, \sigma_0\rangle} \omega/\langle\sigma\sigma_0\rangle$, therefore

$$(4.78) \quad \pi^{-1}(\sigma) = 2^{|[1, 2m]/\langle\sigma, \sigma_0\rangle|}.$$

The map $\pi : A \rightarrow \text{FPFI}([1, 2m])$ induces a map

$$(4.79) \quad p_A^{-1}(k) \longrightarrow \{\sigma \in \text{FPFI}([1, 2m]) \mid \langle\langle\sigma_0, \sigma\rangle\rangle = |[1, 2m]/\langle\sigma_0, \sigma\rangle| = k\}$$

Then by (4.78), the cardinality of the fiber of the map (4.79) is 2^k . Hence,

$$(4.80) \quad |p_A^{-1}(k)| = 2^k \left| \{\sigma \in \text{FPFI}([1, 2m]) \mid \langle\langle\sigma_0, \sigma\rangle\rangle = |[1, 2m]/\langle\sigma_0, \sigma\rangle| = k\} \right|.$$

Besides, there are exactly $2^{|([1, 2m]/\langle\sigma_0\rangle)|} = 2^n$ sections of the projection $\pi : [1, 2m] \rightarrow [1, 2m]/\langle\sigma_0\rangle$. Since

$$p_B^{-1}(k) = \{\tau \in \mathfrak{S}_{[1, 2m]/\langle\sigma_0\rangle} \mid |([1, 2m]/\langle\sigma_0\rangle)/\langle\tau\rangle| = k\} \times \{\text{sections of } \pi : [1, 2m] \rightarrow [1, 2m]/\langle\sigma_0\rangle\},$$

one has

$$(4.81) \quad \begin{aligned} |p_B^{-1}(k)| &= 2^m \left| \{\tau \in \mathfrak{S}_{[1, 2m]/\langle\sigma_0\rangle} \mid |([1, 2m]/\langle\sigma_0\rangle)/\langle\tau\rangle| = k\} \right| \\ &= 2^m \left| \{\tau \in \mathfrak{S}_m \mid \tau \text{ has } k \text{ cycles}\} \right|. \end{aligned}$$

From (4.77), (4.80) and (4.81) we deduce (4.68), which completes the proof. \square

Proposition 4.62. *Let X denote the connected Jacobi diagram on $\vec{\emptyset}$ without trivalent vertices (i.e. a dashed loop). Then*

(a) *for $n \geq 2$, the ideal $\mathring{A}_0^\wedge[0] \cap P_0^n$ of $\mathring{A}_0^\wedge[0]$ is generated by $X(X+2) \cdots (X+2(n-1))$. Hence, there is an algebra isomorphism*

$$(4.82) \quad \left(\frac{\mathring{A}_0^\wedge}{P_0^n} \right) [0] = \frac{\mathring{A}_0^\wedge[0]}{\mathring{A}_0^\wedge[0] \cap P_0^n} \simeq \frac{\mathbb{C}[X]}{(X(X+2) \cdots (X+2(n-1)))},$$

(b) *for $n \geq 1$, there are algebra isomorphisms*

$$(4.83) \quad \left(\frac{\mathring{A}_0^\wedge}{P_0^{n+1} + O^n} \right) [0] \simeq \frac{\mathbb{C}[X]}{(X+2n)} \simeq \mathbb{C},$$

where the first isomorphism is induced by (4.82) and the second isomorphism is given by evaluation at $-2n$. Here O^n is as in Definition 4.56.

Proof. (a) Recall that

$$P_0^n = \text{Im}(\mathring{A}^\wedge(\vec{\emptyset}, \emptyset, \llbracket 1, 2n \rrbracket) \xrightarrow{\langle \cdot, \varsigma_n \rangle} \mathring{A}_0^\wedge),$$

where $\langle \cdot, \cdot \rangle$ is the graded pairing (3.20) and $\varsigma_n \in \mathring{A}^\wedge(\vec{\emptyset}, \emptyset, \llbracket 1, 2n \rrbracket)$ is as in Definition 4.29. Since ς_n has degree 0, then the map $\langle \cdot, \varsigma_n \rangle$ is of degree 0. Hence,

$$(4.84) \quad P_0^n \cap \mathring{A}_0^\wedge[0] = \text{Im}(\mathring{A}^\wedge(\vec{\emptyset}, \emptyset, \llbracket 1, 2n \rrbracket)[0] \xrightarrow{\langle \cdot, \varsigma_n \rangle} \mathring{A}_0^\wedge[0]) = \langle \mathring{A}^\wedge(\vec{\emptyset}, \emptyset, \llbracket 1, 2n \rrbracket)[0], \varsigma_n \rangle.$$

Besides,

$$(4.85) \quad \mathring{A}^\wedge(\vec{\emptyset}, \emptyset, \llbracket 1, 2n \rrbracket)[0] = \bigoplus_{\sigma \in \text{FPFI}(\llbracket 1, 2n \rrbracket)} \mathbb{C}[X][\mathring{\text{Jac}}(\sigma)],$$

where $\mathring{\text{Jac}}$ is as in (4.42) and $[\] : \mathring{\text{Jac}}(\vec{\emptyset}, \emptyset, \llbracket 1, 2n \rrbracket) \rightarrow \mathring{A}^\wedge(\vec{\emptyset}, \emptyset, \llbracket 1, 2n \rrbracket)$ denotes the projection. We continue to denote by $\mathring{\text{Jac}}$ the linear extension of the map from (4.42). Notice that $\mathring{\text{Jac}}(\varsigma_n) = \tilde{\varsigma}_n$, where

$$\tilde{\varsigma}_n := \sum_{\sigma \in \text{ZFPI}(\llbracket 1, 2n \rrbracket)} \sigma \in \text{ZFPI}(\llbracket 1, 2n \rrbracket).$$

Thus, for any $Q(X) \in \mathbb{C}[X] = \mathring{A}_0^\wedge[0]$ and $\sigma \in \text{FPFI}(\llbracket 1, 2n \rrbracket)$, we have

$$(4.86) \quad \langle Q(X) \mathring{\text{Jac}}(\sigma), \varsigma_n \rangle = Q(X) \langle \mathring{\text{Jac}}(\sigma), \mathring{\text{Jac}}(\tilde{\varsigma}_n) \rangle = Q(X) \langle\langle \sigma, \tilde{\varsigma}_n \rangle\rangle,$$

where $\langle\langle \cdot, \cdot \rangle\rangle$ is the pairing (4.65) and $\langle \cdot, \cdot \rangle$ is the pairing (3.20).

For $g \in \mathfrak{S}_{2n}$ define the map $\text{Ad}_g : \text{FPFI}(\llbracket 1, 2n \rrbracket) \rightarrow \text{FPFI}(\llbracket 1, 2n \rrbracket)$ by $\text{Ad}_g(\sigma) := g\sigma g^{-1}$ for any $\sigma \in \text{FPFI}(\llbracket 1, 2n \rrbracket)$. Then, if $\sigma, \tau \in \text{FPFI}(\llbracket 1, 2n \rrbracket)$ and $g \in \mathfrak{S}_{2n}$, we have $\langle\langle \text{Ad}_g(\sigma), \text{Ad}_g(\tau) \rangle\rangle = \langle\langle \sigma, \tau \rangle\rangle$.

Fix $\sigma_0 \in \text{FPFI}(\llbracket 1, 2n \rrbracket)$, then

$$(4.87) \quad \tilde{\varsigma}_n = \sum_{\sigma \in \text{FPFI}(\llbracket 1, 2n \rrbracket)} \sigma = \frac{1}{2^n n!} \sum_{g \in \mathfrak{S}_{2n}} \text{Ad}_g(\sigma_0).$$

The second equality in (4.87) follows from the fact that the conjugation action of \mathfrak{S}_{2n} on $\text{FPFI}(\llbracket 1, 2n \rrbracket)$ is transitive, the orbit of each point being isomorphic to the semidirect product $\mathfrak{S}_n \ltimes \mathbb{Z}_2^n$.

If $\sigma \in \text{FPFI}(\llbracket 1, 2n \rrbracket)$, then there exists $h \in \mathfrak{S}_{2n}$ such that $\sigma = \text{Ad}_h(\sigma_0)$. Therefore,

$$(4.88) \quad \begin{aligned} \langle\langle \sigma, \tilde{\varsigma}_n \rangle\rangle &= \left\langle\left\langle \text{Ad}_h(\sigma_0), \frac{1}{2^n n!} \sum_{g \in \mathfrak{S}_{2n}} \text{Ad}_g(\sigma_0) \right\rangle\right\rangle = \left\langle\left\langle \sigma_0, \frac{1}{2^n n!} \sum_{g \in \mathfrak{S}_{2n}} \text{Ad}_{h^{-1}g} \sigma_0 \right\rangle\right\rangle \\ &= \sum_{\sigma \in \text{FPFI}(\llbracket 1, 2n \rrbracket)} \langle\langle \sigma_0, \sigma \rangle\rangle = X(X+2) \cdots (X+2(n-1)), \end{aligned}$$

where the last equality follows from Lemma 4.61. Combining (4.84), (4.86) and (4.88), one obtains

$$P_0^n \cap \mathring{A}_0^\wedge[0] = \langle \mathring{A}^\wedge(\vec{\emptyset}, \emptyset, \llbracket 1, 2n \rrbracket)[0], \varsigma_n \rangle = (X(X+2) \cdots (X+2(n-1))).$$

(b) Since O^n is generated by $X+2n$ (see Definition 4.56), the isomorphism (4.82) induces an isomorphism of $(\mathring{\mathcal{A}}_0^\wedge / (P_0^{n+1} + O^n)) [0]$ with the quotient of $\mathbb{C}[X]$ by the sum of its ideals $(X+2n)$ and $(X(X+2) \cdots (X+2n))$, which is equal to the ideal $(X+2n)$. \square

Lemma 4.63. *For any integer $r \geq 1$, the algebra homomorphism $j_r^{\text{LMO}} : \bigoplus_{k \geq 0} \mathring{\mathcal{A}}_k^\wedge \rightarrow \mathring{\mathcal{A}}_0^\wedge$ is homogeneous for the degrees $\deg - r \deg_{\text{cir}}$ for the source space and \deg for the target space.*

Proof. The results follows from (4.59). \square

Lemma 4.64. *For any integer $r \geq 1$ let $\theta_r \in \mathring{\mathcal{A}}_1^\wedge = \mathring{\mathcal{A}}^\wedge(\vec{\partial}, \{1\})$ denote the class of the Jacobi diagram consisting of r “parallel” chords, see Figure 4.28 for some examples.*

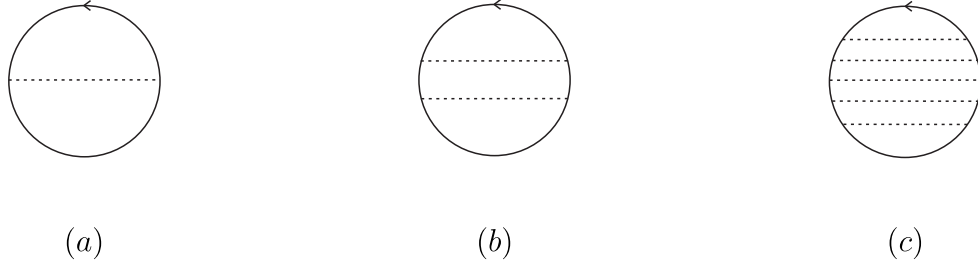

FIGURE 4.28. The elements $\theta_1, \theta_2, \theta_3 \in \mathring{\mathcal{A}}_1^\wedge$.

Then

$$(4.89) \quad j_r^{\text{LMO}}(\text{cs}^\nu \circ Z_{\mathcal{A}}(U^\pm))[0] = \frac{1}{r!} \left(\pm \frac{1}{2} \right)^r j_r^{\text{LMO}}(\theta_r) \in \mathring{\mathcal{A}}_0^\wedge[0],$$

where $Z_{\mathcal{A}}$ is the Kontsevich integral (see Theorem 3.37).

Proof. Notice that $\theta_r \in \mathring{\mathcal{A}}_1^\wedge[r]$, therefore, by Lemma 4.63, $j_r^{\text{LMO}}(\theta_r) \in \mathring{\mathcal{A}}_0^\wedge[0]$. Let $\mathbb{C}\mathring{\text{Jac}}(\vec{\partial}, \{1\})[r]$ be the subspace of $\mathbb{C}\mathring{\text{Jac}}(\vec{\partial}, \{1\})$ generated by pairs $\underline{D} = (D, \varphi, \text{cyc}_1)$ (see Definition 3.7) such that $\deg(\underline{D}) = \frac{1}{2}(|\text{triv}(D)| + |\partial D|) = r$, where $\text{triv}(D)$ (resp. ∂D) denotes the set of trivalent (resp. univalent) vertices of D , see (3.1). Then $\mathring{\mathcal{A}}_1^\wedge[r]$ is a quotient of $\mathbb{C}\mathring{\text{Jac}}(\vec{\partial}, \{1\})[r]$.

If $|\text{triv}(D)| \geq 1$, then $j_r^{\text{LMO}}([\underline{D}]) = 0$. Indeed, by Lemma 4.54, $j_r^{\text{LMO}}([\underline{D}]) = \frac{1}{r!} j_1^{\text{LMO}}([\underline{D}^{(r)}])$ and, by its definition, $\underline{D}^{(r)}$ is a sum of elements $\underline{E} = (E, \psi, \{\text{cyc}_{(1,i)}\}_{i \in [1,r]})$ of $\mathring{\text{Jac}}(\vec{\partial}, [1, r])$ with $\partial E \simeq \partial D$, see Definition 4.53. Since $|\partial D| < 2r$, each one of the maps $\psi : \partial E \rightarrow [1, r]$ is such that the fiber of at least one element has cardinality less or equal than 1, which implies $j_1^{\text{LMO}}(\underline{E}) = 0$ as $T_0 = T_1 = 1$. Therefore, $j_r^{\text{LMO}}([\underline{D}]) = 0$. Besides, we have

$$(4.90) \quad \begin{aligned} \text{cs}^\nu \circ Z_{\mathcal{A}}(U^\pm) &= \text{cs}^\nu \left(\text{cs}^\nu \left(\exp_{\#} \left(\pm \frac{1}{2} \theta_1 \right) \right) \right) \\ &= \exp_{\#} \left(\pm \frac{1}{2} \theta_1 + (\text{sum of connected diagrams with } \geq 1 \text{ trivalent vertices}) \right), \end{aligned}$$

where $\#$ denotes the product (connected sum)⁶ in $\mathring{\mathcal{A}}_1^\wedge$. We then have

$$\begin{aligned} j_r^{\text{LMO}}(\text{cs}^\nu \circ Z_{\mathcal{A}}(U^\pm)) &= \exp_{\#} \left(\pm \frac{1}{2} \theta_1 + (\text{sum of connected diagrams with } \geq 1 \text{ trivalent vertices}) \right) \\ &= j_r^{\text{LMO}} \left(\exp_{\#} \left(\pm \frac{1}{2} \theta_1 \right) \right) \end{aligned}$$

⁶Notice that the product $\#$ in $\mathring{\mathcal{A}}_1^\wedge = \mathring{\mathcal{A}}^\wedge(\vec{\partial}, \{1\})$ is the product induced by the composition in $\mathring{\mathcal{A}}^\wedge(\uparrow, \emptyset)$ using the continuous linear isomorphism $\mathring{\mathcal{A}}^\wedge(\uparrow, \emptyset) \simeq \mathring{\mathcal{A}}_1^\wedge$, see [41, Proposition 6.3].

Hence, by taking the degree 0 part in both sides of the above equation, using Lemma 4.63 and the fact that $\theta_1^{\#r} = \theta_r$, we obtain

$$\begin{aligned} j_r^{\text{LMO}}(\text{cs}^\nu \circ Z_{\mathcal{A}}(U^\pm)) [0] &= j_r^{\text{LMO}}\left(\exp_{\#}\left(\pm\frac{1}{2}\theta_1\right)\right) [0] = \sum_{k \geq 0} \frac{1}{k!} \left(\pm\frac{1}{2}\right)^k j_r^{\text{LMO}}(\theta_1^{\#k}) [0] \\ &= \frac{1}{r!} \left(\pm\frac{1}{2}\right)^r j_r^{\text{LMO}}(\theta_1^{\#r}) = \frac{1}{r!} \left(\pm\frac{1}{2}\right)^r j_r^{\text{LMO}}(\theta_r) \end{aligned}$$

which finishes the proof. \square

Lemma 4.65. *For any integer $r \geq 1$ we have*

$$(4.91) \quad j_r^{\text{LMO}}(\theta_r) = X(X+2) \cdots (X+2(r-1)) \in \mathring{\mathcal{A}}_0^\wedge[0],$$

where X denotes the dashed loop (as in Proposition 4.62).

Proof. We will use Lemma 4.54. Let us describe $\theta_r^{(r)}$ explicitly. Let us label the chords of θ_r from 1 to r and for each chord we label its endpoints with s and t .

Then we have a bijection $\{\text{endpoints of the } r \text{ chords}\} \simeq \llbracket 1, r \rrbracket \times \{s, t\}$. Let cyc be the induced cyclic order on $\llbracket 1, r \rrbracket \times \{s, t\}$ by this bijection and the cyclic order deduced from the diagrammatic representation of θ_r , for instance, if in Figure 4.28(b) we label the chords from top to bottom with 1 and 2 and from left to right with s and t , then the cyclic order cyc on $\llbracket 1, 2 \rrbracket \times \{s, t\}$ is given by $(1, s) \leq (2, s) \leq (2, t) \leq (1, t) \leq (1, s)$. Let $\text{Map}(\llbracket 1, r \rrbracket \times \{s, t\}, \llbracket 1, r \rrbracket)$ be the sets of maps $\varphi : \llbracket 1, r \rrbracket \times \{s, t\} \rightarrow \llbracket 1, r \rrbracket$. For such a φ let $\text{diag}(\varphi)$ be the class in $\mathring{\mathcal{A}}^\wedge(\vec{\emptyset}, \llbracket 1, r \rrbracket)$ of the Jacobi diagram $(\theta_r, \varphi, \{\text{cyc}_i\}_{i \in \llbracket 1, r \rrbracket})$ where cyc_i is the cyclic order on $\varphi^{-1}(i) \subset \llbracket 1, r \rrbracket \times \{s, t\}$ induced by cyc . Then we have

$$(4.92) \quad \theta_r^{(r)} = \sum_{\varphi} \text{diag}(\varphi) \in \mathring{\mathcal{A}}^\wedge(\vec{\emptyset}, \llbracket 1, r \rrbracket),$$

where the sum runs over the set $\text{Map}(\llbracket 1, r \rrbracket \times \{s, t\}, \llbracket 1, r \rrbracket)$.

We know that if φ is such that there is $c \in \llbracket 1, r \rrbracket$ with $|\varphi^{-1}(c)| \leq 1$, then $j_1^{\text{LMO}}(\text{diag}(\varphi)) = 0$ (because $T_0 = T_1 = 0$). Set

$$\text{Map}'(\llbracket 1, r \rrbracket \times \{s, t\}, \llbracket 1, r \rrbracket) := \{\varphi \in \text{Map}(\llbracket 1, r \rrbracket \times \{s, t\}, \llbracket 1, r \rrbracket) \mid \forall c \in \llbracket 1, r \rrbracket : |\varphi^{-1}(c)| \geq 2\}.$$

Then by Lemma 4.54 and (4.92), we have

$$(4.93) \quad j_r^{\text{LMO}}(\theta_r) = \frac{1}{r!} j_1^{\text{LMO}}(\theta_r^{(r)}) = \sum_{\varphi \in \text{Map}'(\llbracket 1, r \rrbracket \times \{s, t\}, \llbracket 1, r \rrbracket)} j_1^{\text{LMO}}(\text{diag}(\varphi)).$$

Consider the map

$$(4.94) \quad \Phi : \text{Map}'(\llbracket 1, r \rrbracket \times \{s, t\}, \llbracket 1, r \rrbracket) \longrightarrow \text{FPFI}(\llbracket 1, r \rrbracket \times \{s, t\})$$

given as follows. For $\varphi \in \text{Map}'(\llbracket 1, r \rrbracket \times \{s, t\}, \llbracket 1, r \rrbracket)$, we have $\sum_{c \in \llbracket 1, r \rrbracket} |\varphi^{-1}(c)| = 2r$, which implies that $|\varphi^{-1}(c)| = 2$ for any $c \in \llbracket 1, r \rrbracket$. Define $\Phi(\varphi) : \llbracket 1, r \rrbracket \times \{s, t\} \rightarrow \llbracket 1, r \rrbracket \times \{s, t\}$ by the condition $\varphi^{-1}(\varphi(x)) = \{x, \Phi(\varphi)(x)\}$ for all $x \in \llbracket 1, r \rrbracket \times \{s, t\}$.

Let $\sigma \in \text{FPFI}(\llbracket 1, r \rrbracket \times \{s, t\})$, let us compute the cardinality $|\Phi^{-1}(\sigma)|$. The quotient set $(\llbracket 1, r \rrbracket \times \{s, t\}) / \langle \sigma \rangle$ has cardinality r . Hence

$$(4.95) \quad |\text{Bij}((\llbracket 1, r \rrbracket \times \{s, t\}) / \langle \sigma \rangle, \llbracket 1, r \rrbracket)| = r!,$$

where $\text{Bij}((\llbracket 1, r \rrbracket \times \{s, t\}) / \langle \sigma \rangle, \llbracket 1, r \rrbracket)$ is the set of bijective maps from $(\llbracket 1, r \rrbracket \times \{s, t\}) / \langle \sigma \rangle$ to $\llbracket 1, r \rrbracket$. If $\varphi \in \Phi^{-1}(\sigma)$, then we have a commutative diagram

$$\begin{array}{ccc} \llbracket 1, r \rrbracket \times \{s, t\} & \longrightarrow & \frac{\llbracket 1, r \rrbracket \times \{s, t\}}{\langle \sigma \rangle} \\ & \searrow \varphi & \downarrow \bar{\varphi} \\ & & \llbracket 1, r \rrbracket, \end{array}$$

where $\bar{\varphi}$ is a bijection. One checks that the map $\varphi \mapsto \bar{\varphi}$ defines a bijective map $\Phi^{-1}(\sigma) \rightarrow \text{Bij}(\llbracket 1, r \rrbracket \times \{s, t\}) / \langle \sigma \rangle, \llbracket 1, r \rrbracket$. Therefore, by (4.95) we have

$$(4.96) \quad |\Phi^{-1}(\sigma)| = r!.$$

Let $\sigma_0 \in \text{FPFI}(\llbracket 1, r \rrbracket \times \{s, t\})$ defined by $\sigma_0(x, s) = (x, t)$ and $\sigma_0(x, t) = (x, s)$ for any $x \in \llbracket 1, r \rrbracket$. Recall from (4.64) in Definition 4.60 that for $\sigma \in \text{FPFI}(\llbracket 1, r \rrbracket \times \{s, t\})$

$$((\sigma_0, \sigma)) = \left| \frac{\llbracket 1, r \rrbracket \times \{s, t\}}{\langle \sigma_0, \sigma \rangle} \right|.$$

Let $\varphi \in \text{Map}'(\llbracket 1, r \rrbracket \times \{s, t\}, \llbracket 1, r \rrbracket)$ and let us compute $j_1^{\text{LMO}}(\text{diag}(\varphi))$. The chords in $\text{diag}(\varphi)$ connect the pairs $(x, \sigma_0(x))$ for $x \in \llbracket 1, r \rrbracket \times \{s, t\}$. Besides, $j_1^{\text{LMO}}(\text{diag}(\varphi))$ is obtained from $\text{diag}(\varphi)$ by connecting with chords (i.e., with T_2) pairs of univalent vertices lying on a circle and then erasing the circle (see Figure 4.27). Therefore, we are connecting the pairs $(x, \sigma(x))$ for $x \in \llbracket 1, r \rrbracket \times \{s, t\}$ where $\sigma = \Phi(\varphi)$. Since $\sigma = \Phi(\varphi)$ and σ_0 are involutions we have a bijection between the set of connected components of $j_1^{\text{LMO}}(\text{diag}(\varphi))$ and the quotient set $(\llbracket 1, r \rrbracket \times \{s, t\}) / \langle \sigma, \sigma_0 \rangle$. Such connected components are dashed circles, hence

$$(4.97) \quad j_1^{\text{LMO}}(\text{diag}(\varphi)) = X^{((\sigma_0, \Phi(\varphi)))} = \langle\langle \sigma_0, \Phi(\varphi) \rangle\rangle,$$

where $\langle\langle \cdot, \cdot \rangle\rangle$ is as in Definition 4.60(b). We conclude that

$$\begin{aligned} j_r^{\text{LMO}}(\theta_r) &= \frac{1}{r!} \sum_{\varphi \in \text{Map}'(\llbracket 1, r \rrbracket \times \{s, t\}, \llbracket 1, r \rrbracket)} j_1^{\text{LMO}}(\text{diag}(\varphi)) = \frac{1}{r!} \sum_{\varphi \in \text{Map}'(\llbracket 1, r \rrbracket \times \{s, t\}, \llbracket 1, r \rrbracket)} \langle\langle \sigma_0, \Phi(\varphi) \rangle\rangle \\ &= \frac{1}{r!} \sum_{\sigma \in \text{FPFI}(\llbracket 1, r \rrbracket \times \{s, t\})} |\Phi^{-1}(\sigma)| \langle\langle \sigma_0, \Phi(\varphi) \rangle\rangle = \sum_{\sigma \in \text{FPFI}(\llbracket 1, r \rrbracket \times \{s, t\})} \langle\langle \sigma, \sigma_0 \rangle\rangle \\ &= X(X+2) \cdots (X+2(r-1)). \end{aligned}$$

We have used (4.93) in the first equality, (4.97) in the second equality, the map (4.94) in the third equality, (4.96) in the fourth equality, and Lemma (4.61) in the last equality. \square

Proposition 4.66. *For any integer $r \geq 1$ we have*

$$(4.98) \quad j_r^{\text{LMO}}(\text{cs}^\nu \circ Z_{\mathcal{A}}(U^\pm))[0] = \frac{1}{r!} \left(\pm \frac{1}{2} \right)^r X(X+2) \cdots (X+2(r-1)),$$

where X denotes the dashed loop (as in Proposition 4.62).

Proof. The result follows from Lemmas 4.64 and 4.65. \square

Theorem 4.67. *The pair $(\mathfrak{c}(n), \bar{j}_n \circ \varphi_n \circ \bar{\text{cs}}^\nu \circ Z_{\mathcal{A}})$ is a Kirby structure.*

Proof. We need to show that the elements $\bar{j}_n \circ \varphi_n \circ \bar{\text{cs}}^\nu \circ Z_{\mathcal{A}}(U^\pm)$ of the algebra $\mathfrak{c}(n)$ are invertible (see Definition 2.83). This algebra is a complete $\mathbb{Z}_{\geq 0}$ -graded algebra, with its degree zero component $\mathfrak{c}(n)[0]$ being isomorphic to \mathbb{C} by Proposition 4.62(b). The said invertibilities are then equivalent to that of the images of the elements $(\bar{j}_n \circ \varphi_n \circ \bar{\text{cs}}^\nu \circ Z_{\mathcal{A}}(U^\pm))[0]$ in \mathbb{C} . Their images are, by Proposition 4.66, the classes of the polynomials $\frac{1}{n!(\pm 2)^n} X(X+2) \cdots (X+2(n-1))$ in $\mathbb{C}[X]/(X+2n)$ which are equal to $(\mp 1)^n$ and therefore invertible. \square

4.6. The algebras $\mathfrak{d}(n)$ and the morphisms $\text{pr}_n : \mathfrak{c}(n) \rightarrow \mathfrak{d}(n)$. We fix an integer $n \geq 1$. Let $\mathring{\mathcal{A}}_0^\wedge[n]$ denote the subspace of \mathcal{A}_0^\wedge consisting of elements of degree n and let $\mathring{\mathcal{A}}_0^\wedge[>n]$ denote the complete direct sum of all the components of all the $\mathring{\mathcal{A}}_0^\wedge[k]$ with $k > n$. Since $\mathring{\mathcal{A}}_0^\wedge$ is a complete graded algebra, this is a complete graded ideal of $\mathring{\mathcal{A}}_0^\wedge$.

Definition 4.68. Define the complete graded commutative algebra $\mathfrak{d}(n)$ as the quotient algebra

$$(4.99) \quad \mathfrak{d}(n) = \frac{\mathring{\mathcal{A}}_0^\wedge}{P_0^{n+1} + O^n + \mathring{\mathcal{A}}_0^\wedge[>n]}.$$

One checks that $\mathfrak{d}(n)$ is the direct sum of its components of degrees $\leq n$, and is therefore a graded commutative algebra.

Proposition 4.69. *Let $\text{pr}_n : \mathfrak{c}(n) \rightarrow \mathfrak{d}(n)$ denote the canonical projection. Then the pair $(\mathfrak{d}(n), \text{pr}_n \circ \bar{j}_n \circ \varphi_n \circ \bar{\mathfrak{c}}^{\mathcal{V}} \circ Z_{\mathcal{A}})$ is a Kirby structure.*

Proof. The result follows from Theorem 4.67 and Lemma 2.86(b). □

4.7. The equality $\mathfrak{c}(1) = \mathfrak{d}(1)$. In this subsection we show that the algebra homomorphism $\text{pr}_1 : \mathfrak{c}(1) \rightarrow \mathfrak{d}(1)$ is an isomorphism, which implies $\mathfrak{c}(1) = \mathfrak{d}(1)$.

Lemma 4.70. *Let x be a connected element in $\mathring{\text{Jac}}(\vec{\mathcal{O}}, \emptyset)$ of degree $m \geq 3$. Then, modulo AS, IHX and P_0^2 relations, the diagram x is equal to a linear combination $\sum_i x_i$ of elements $x_i \in \mathring{\text{Jac}}(\vec{\mathcal{O}}, \emptyset)$ of degree m such that each x_i has a bigon as a subdiagram, see Figure 4.29, in other words each x_i is a graph having a cycle of length 2.*



FIGURE 4.29. Local view of a bigon subdiagram, equivalently a cycle of length 2, in a Jacobi diagram.

Proof. Notice that x has a k -cycle with $2 \leq k \leq 2m$. That is, a closed path containing k trivalent vertices (and therefore k edges). Up to the AS relation we can suppose that x has the form shown in Figure 4.30.

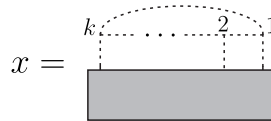

FIGURE 4.30. The diagram x has a k -cycle.

We prove by induction on k that, modulo AS, IHX and P_0^2 relations, the diagram x can be written as stated in the lemma. If $k = 2$, there is nothing to prove. Suppose $k = 3$, consider the instance of the P_0^2 relation show in Figure 4.31.

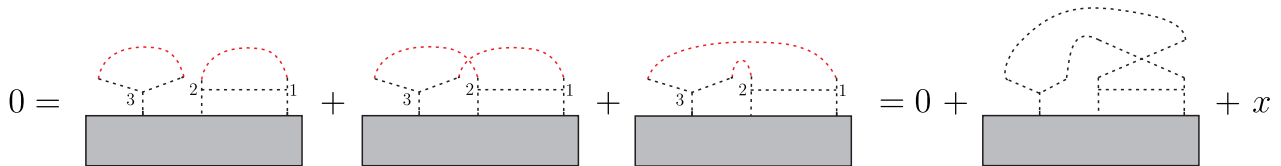

FIGURE 4.31. Instance of the P_0^2 relation. The grey part is as in Figure 4.30. The first diagram in the the second part of the equality is equal to 0 by the AS relation.

Then, using the IHX relation we have the equality shown in Figure 4.32.

The equality in Figure 4.32 implies that, modulo AS, IHX and P_0^2 relations, the diagram x can be written in terms of a diagram with a 2-cycle.

Let us assume $k \geq 4$. Consider the instance of the P_0^2 relation shown in Figure 4.33.

We then obtain the equations shown Figure 4.34.

The first diagram in the last part of the equations in Figure 4.34 has a 2-cycle while the second diagram has a $(k - 1)$ -cycle and the last diagram is x . It follows from this that the diagram x , modulo AS, IHX and P_0^2 relations, can be written as the linear combination of a diagram with a 2-cycle and a diagram with a $(k - 1)$ -cycle, we can apply the induction hypothesis to the latter. This completes the proof. □

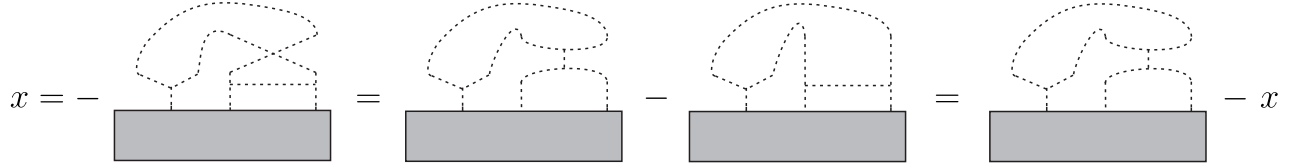

FIGURE 4.32. Using the IHX relation.

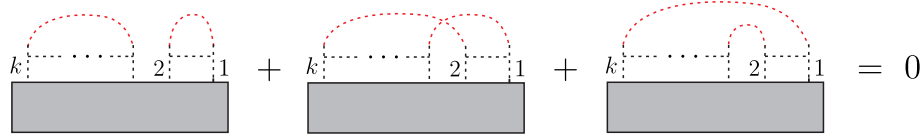

FIGURE 4.33. Instance of P_0^2 . Here the grey part is as in Figure 4.30. Hence, the last diagram in the left-hand of the equation is the diagram x .

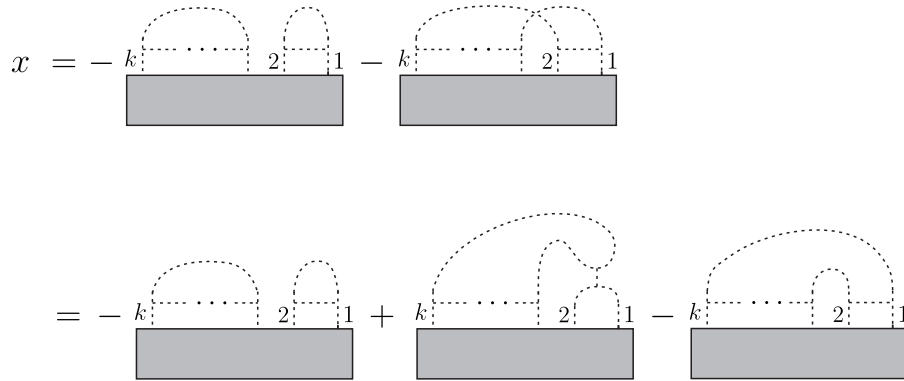

FIGURE 4.34. In the second equality we have used the IHX relation.

Lemma 4.71. For all $m \geq 2$ the quotient space $\frac{\mathcal{A}_0^\wedge}{P_0^2}[m]$ is equal to $\{0\}$.

Proof. We proceed by induction on $m \geq 2$. Let us consider the case $m = 2$. Let Θ , \ominus and \otimes denote the classes in \mathcal{A}_0^\wedge of the Jacobi diagrams shown in Figure 4.35 (a), (b) and (c) respectively. Let X denote the dashed loop as in Proposition 4.62.

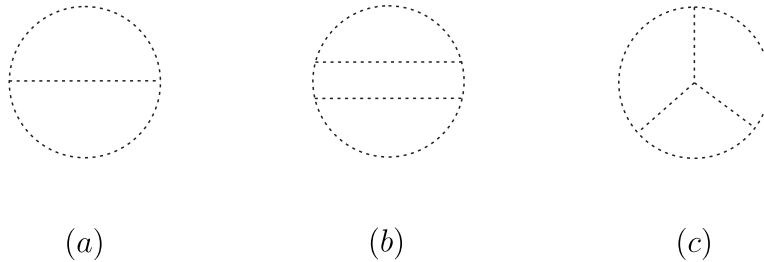

FIGURE 4.35. Some elements in \mathcal{A}_0^\wedge .

By the IHX and AS relations we have

$$(4.100) \quad \ominus = 2 \otimes.$$

One checks that

$$\mathcal{A}_0^\wedge[2] = \mathbb{C}[X] \cdot \text{Vect}_{\mathbb{C}}\{\Theta \cdot \Theta, \otimes\}.$$

FIGURE 4.36. Instance of P_0^2 . In the second equality we have used the AS relation.

An instance of the relation P_0^2 and the AS relation imply the equation shown in Figure 4.36.

From the equation in Figure 4.36 we deduce $\ominus = -\frac{1}{2} \otimes$ in $\mathring{\mathcal{A}}_0^\wedge/P_0^2$. Using this and (4.100) we obtain $\otimes = 0$ in $\mathring{\mathcal{A}}_0^\wedge/P_0^2$.

FIGURE 4.37. Instance of P_0^2 . In the second equality we have used the AS relation.

The instance of the relation P_0^2 shown in Figure 4.37 together with (4.100) imply $\Theta \cdot \Theta = -4 \otimes$ in $\mathring{\mathcal{A}}_0^\wedge/P_0^2$ and therefore $\Theta \cdot \Theta = 0$ in $\mathring{\mathcal{A}}_0^\wedge/P_0^2$. We deduce that $\frac{\mathring{\mathcal{A}}_0^\wedge}{P_0^2}[2] = \{0\}$.

Let us consider now the case $m \geq 3$. Let $x \in \mathring{\text{Jac}}(\vec{\mathcal{D}}, \emptyset)$ of degree m and which does not contain the dashed component X . We consider the two cases:

(i) The diagram x has at least two connected components. In this case we can write $x = x' \sqcup x''$ where x' is a connected component of x and $x'' = x \setminus x'$. Thus, $1 \leq \deg(x'), \deg(x'') \leq m - 1$ and $\deg(x') + \deg(x'') = m$. If $\deg(x') \geq 2$, then by inductive hypothesis $x' = 0$ in $\mathring{\mathcal{A}}_0^\wedge/P_0^2$, therefore $x = 0$ in $\mathring{\mathcal{A}}_0^\wedge/P_0^2$. If $\deg(x') = 1$, then $\deg(x'') = m - 1 \geq 2$. Thus $x'' = 0$ in $\mathring{\mathcal{A}}_0^\wedge/P_0^2$ and therefore $x = 0$ in $\mathring{\mathcal{A}}_0^\wedge/P_0^2$.

(ii) The diagram x has only one connected component. In this case by Lemma 4.70, we can suppose that x has the form shown in Figure 4.38.

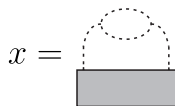

FIGURE 4.38. Form of x .

Consider the instance of the relation P_0^2 shown in Figure 4.39.

FIGURE 4.39. Instance of the relation P_0^2 . The grey part is the same as in Figure 4.38.

Let D denote the diagram with the Θ component in Figure 4.39. We have $\deg(D \setminus \Theta) = m - 1 \geq 2$, then by the inductive hypothesis $D \setminus \Theta = 0$ in $\mathring{\mathcal{A}}_0^\wedge/P_0^2$. It follows that $D = 0$ in $\mathring{\mathcal{A}}_0^\wedge/P_0^2$. Using this and the equation from Figure 4.39, we obtain $2x = 0$ and therefore $x = 0$ in $\mathring{\mathcal{A}}_0^\wedge/P_0^2$.

We conclude that $\frac{\mathring{\mathcal{A}}_0^\wedge}{P_0^2}[m] = \{0\}$ for any $m \geq 2$. □

Proposition 4.72. *The map $\text{pr}_1 : \mathfrak{c}(1) \rightarrow \mathfrak{d}(1)$ is an algebra isomorphism and therefore $\mathfrak{c}(1) = \mathfrak{d}(1)$.*

Proof. Consider the surjective algebra homomorphism $\tilde{\text{pr}}_1 : \mathfrak{c}(1) \rightarrow \mathfrak{e}(1)$ given by the composition

$$\mathfrak{c}(1) = \frac{\mathring{A}_0}{P_0^2 + O^1} \xrightarrow{\text{pr}_1} \mathfrak{d}(1) = \frac{\mathring{A}_0}{P_0^2 + O^1 + (\text{deg} > 1)} \simeq \frac{\mathcal{A}_0}{(\text{deg} > 1)} = \mathfrak{e}(1),$$

where the last isomorphism is given by Lemma 5.37. Recall that $\mathfrak{e}(1) = \mathfrak{e}(1)[0] \oplus \mathfrak{e}(1)[1]$ is a two dimensional \mathbb{C} -vector space where $\mathfrak{e}(1)[0]$ is spanned by the class in $\mathfrak{e}(1)$ of the empty Jacobi diagram (of degree 0) and $\mathfrak{e}(1)[1]$ is spanned by the class in $\mathfrak{e}(1)$ of the theta Jacobi diagram (of degree 1) Θ shown in Figure 4.35(a).

Let us study the restriction of the map $\tilde{\text{pr}}_1$ to the degree components $\mathfrak{c}(1)[m] = \frac{\mathring{A}_0[m]}{P_0^2[m] + O^1[m]}$ of $\mathfrak{c}(1)$ where the degree is given by half of the number of trivalent vertices. By Proposition 4.62, we have $\mathfrak{c}(1)[0] \simeq \mathbb{C}$ spanned by the class in $\mathfrak{c}(1)$ of the empty Jacobi diagram. We also have that $\mathfrak{c}(1)[1] \simeq \mathbb{C}$ is spanned by the class in $\mathfrak{c}(1)$ of the theta Jacobi diagram Θ . Thus, $\tilde{\text{pr}}_1 : \mathfrak{c}(1) \rightarrow \mathfrak{e}(1)$ induces isomorphisms $\mathfrak{c}(1)[0] \simeq \mathfrak{e}(1)[0]$ and $\mathfrak{c}(1)[1] \simeq \mathfrak{e}(1)[1]$. Besides, by Lemma 4.71, $\frac{\mathring{A}_0[m]}{P_0^2[m]} = \{0\}$ for any $m \geq 2$, hence $\mathfrak{c}(1)[m] = \{0\}$ for any $m \geq 2$. We conclude that the map $\tilde{\text{pr}}_1 : \mathfrak{c}(1) \rightarrow \mathfrak{e}(1)$ is an isomorphism and therefore $\text{pr}_1 : \mathfrak{c}(1) \rightarrow \mathfrak{d}(1)$ is too. \square

4.8. The families of 3-manifold invariants $\{\Omega_n^{\mathfrak{c}}\}_{n \geq 1}$ and $\{\Omega_n^{\mathfrak{d}}\}_{n \geq 1}$.

Theorem 4.73. *For any integer $n \geq 1$, there exist invariants of closed oriented 3-manifolds*

$$(4.101) \quad \Omega_n^{\mathfrak{c}} : 3\text{-Mfds} \longrightarrow \mathfrak{c}(n) \quad \text{and} \quad \Omega_n^{\mathfrak{d}} : 3\text{-Mfds} \longrightarrow \mathfrak{d}(n)$$

with values in the algebras $\mathfrak{c}(n)$ and $\mathfrak{d}(n)$, explicitly given by $\Omega_n^{\mathfrak{c}} := Z_{(\mathfrak{c}(n), \bar{j}_n \circ \varphi_n \circ \bar{\text{cs}}^\nu \circ Z_{\mathcal{A}})}$ and $\Omega_n^{\mathfrak{d}} := Z_{(\mathfrak{d}(n), \text{pr}_n \circ \bar{j}_n \circ \varphi_n \circ \bar{\text{cs}}^\nu \circ Z_{\mathcal{A}})}$. Moreover, these invariants are monoid homomorphisms and for any closed oriented 3-manifold Y we have $\text{pr}_n(\Omega_n^{\mathfrak{c}}(Y)) = \Omega_n^{\mathfrak{d}}(Y)$, where $\text{pr}_n : \mathfrak{c}(n) \rightarrow \mathfrak{d}(n)$ is the canonical projection.

Proof. By Theorem 4.67 and Proposition 4.69, for any $n \geq 1$, the pairs $(\mathfrak{c}(n), \bar{j}_n \circ \varphi_n \circ \bar{\text{cs}}^\nu \circ Z_{\mathcal{A}})$ and $(\mathfrak{d}(n), \text{pr}_n \circ \bar{j}_n \circ \varphi_n \circ \bar{\text{cs}}^\nu \circ Z_{\mathcal{A}})$ are Kirby structures, that is, they belong to the category \mathcal{KS} (see Definition 2.85). We can then apply the functor $\mathcal{KS} \rightarrow \mathcal{Inv}$ from Proposition 2.91 to obtain invariants of 3-manifolds $\Omega_n^{\mathfrak{c}} := Z_{(\mathfrak{c}(n), \bar{j}_n \circ \varphi_n \circ \bar{\text{cs}}^\nu \circ Z_{\mathcal{A}})}$ and $\Omega_n^{\mathfrak{d}} := Z_{(\mathfrak{d}(n), \text{pr}_n \circ \bar{j}_n \circ \varphi_n \circ \bar{\text{cs}}^\nu \circ Z_{\mathcal{A}})}$:

$$(4.102) \quad \Omega_n^{\mathfrak{c}} : 3\text{-Mfds} \longrightarrow \mathfrak{c}(n) \quad \text{and} \quad \Omega_n^{\mathfrak{d}} : 3\text{-Mfds} \longrightarrow \mathfrak{d}(n)$$

with values in the algebras $\mathfrak{c}(n)$ and $\mathfrak{d}(n)$, respectively. The last statement follows from Proposition 2.91. \square

Remark 4.74. The invariant $\Omega_n^{\mathfrak{d}} : 3\text{-Mfds} \longrightarrow \mathfrak{d}(n) \simeq \mathfrak{e}(n)$, is the one considered in [31, 41]. The algebra $\mathfrak{e}(n)$ will be introduced in Definition 5.35 and the isomorphism $\mathfrak{d}(n) \simeq \mathfrak{e}(n)$ is the one given in Lemma 5.37.

4.9. Equality of $\Omega_1^{\mathfrak{c}}$ and $\Omega_1^{\mathfrak{d}}$.

Corollary 4.75. *For any $Y \in 3\text{-Mfds}$, we have $\Omega_1^{\mathfrak{c}}(Y) = \Omega_1^{\mathfrak{d}}(Y)$.*

Proof. By Theorem 4.73 we have $\text{pr}_1(\Omega_1^{\mathfrak{c}}(Y)) = \Omega_1^{\mathfrak{d}}(Y)$ and by Proposition 4.72 $\mathfrak{c}(1) = \mathfrak{d}(1)$. Therefore $\Omega_1^{\mathfrak{c}}(Y) = \Omega_1^{\mathfrak{d}}(Y)$. \square

4.10. On the construction of the algebras $\mathfrak{c}(n)$. In this subsection we consider integers $m, n \geq 1$. By Lemma 4.63 the algebra homomorphism $j_n^{\text{LMO}} : \bigoplus_{k \geq 0} \mathring{A}_k^\wedge \rightarrow \mathring{A}_0^\wedge$ is homogeneous, therefore $j_n^{\text{LMO}}(P^{m+1} + L^{<2m} + (\text{CO}\mathring{A}^\wedge))$ is a graded subspace of \mathring{A}_0^\wedge .

If $J \subset \mathring{A}_0^\wedge$ is a graded ideal containing $j_n^{\text{LMO}}(P^{m+1} + L^{<2m} + (\text{CO}\mathring{A}^\wedge))$, then the map j_n^{LMO} induces an algebra homomorphism

$$(4.103) \quad \bar{j}_{n,m,J} : \mathfrak{b}(m) \longrightarrow \frac{\mathring{A}_0^\wedge}{J},$$

where $\mathfrak{b}(m)$ is as in Definition 4.32. Hence, by Lemma 2.86, the pair $(\mathring{A}_0^\wedge/J, \bar{j}_{n,m,J} \circ \varphi_n \circ \bar{\text{cs}}^\nu \circ Z_{\mathcal{A}})$ is a semi-Kirby structure. In particular, if $n = m$ and $J = P_0^{n+1} + O^n$ then $\mathring{A}_0^\wedge/J = \mathfrak{c}(n)$ (see Definition 4.57)

and the algebra homomorphism $\bar{j}_{n,n,J}$ is the algebra homomorphism \bar{j}_n in Proposition 4.59. Moreover, by Theorem 4.67, the pair $(\mathfrak{c}(n), \bar{j}_n \circ \varphi_n \circ \overline{\text{cs}}^\nu \circ Z_{\mathcal{A}})$ is a Kirby structure. We have the following.

Proposition 4.76. *For $m \neq n$ there is no graded ideal J of $\mathring{\mathcal{A}}^\wedge(\emptyset)$ containing $j_n^{\text{LMO}}(P^{m+1} + L^{2m} + (\text{CO}\mathring{\mathcal{A}}^\wedge))$ and such that the pair $(\mathring{\mathcal{A}}_0^\wedge/J, \bar{j}_{n,m,J} \circ \varphi_n \circ \overline{\text{cs}}^\nu \circ Z_{\mathcal{A}})$ is a Kirby structure.*

Proof. Suppose, contrary to our claim, that such a graded ideal J of $\mathring{\mathcal{A}}_0^\wedge$ exists. We consider two cases.

If $n < m$, the element θ_n (described in Lemma 4.64) belongs the ideal $L^{<2m}$. Using Lemma 4.64, we have

$$\begin{aligned} j_n^{\text{LMO}}(\text{cs}^\nu \circ Z_{\mathcal{A}}(U^\pm))[0] &= \frac{1}{n!} \left(\pm \frac{1}{2} \right)^n j_1^{\text{LMO}}(\theta_n^{(n)}) \in j_n^{\text{LMO}}(L^{<2m})[0] \\ &\subset j_n^{\text{LMO}}(P^{m+1} + L^{<2m} + (\text{CO}\mathring{\mathcal{A}}^\wedge))[0] \subset J[0]. \end{aligned}$$

Hence, the elements $\bar{j}_{n,m,J} \circ \varphi_n \circ \overline{\text{cs}}^\nu \circ Z_{\mathcal{A}}(U^\pm)[0]$, which are the classes of $j_n^{\text{LMO}}(\text{cs}^\nu \circ Z_{\mathcal{A}}(U^\pm))[0]$ in $\mathring{\mathcal{A}}_0^\wedge[0]/J[0]$, are zero. Therefore, the elements $\bar{j}_{n,m,J} \circ \varphi_n \circ \overline{\text{cs}}^\nu \circ Z_{\mathcal{A}}(U^\pm)$ are not invertible in $\mathring{\mathcal{A}}_0^\wedge/J$, that is, the pair $(\mathring{\mathcal{A}}^\wedge(\emptyset)/J, \bar{j}_{n,m,J} \circ \varphi_n \circ \overline{\text{cs}}^\nu \circ Z_{\mathcal{A}})$ is not a Kirby structure.

Now, let us assume $n > m$. In the proof of Proposition 4.59 we have seen that $j_n^{\text{LMO}}(L^{<2n}) = j_n^{\text{LMO}}((\text{CO}\mathring{\mathcal{A}}^\wedge)) = 0$ and the same argument used to show $j_n^{\text{LMO}}(P^{n+1}) \subset P_0^{n+1}$ works to show $j_n^{\text{LMO}}(P^{m+1})$ is a subset of P_0^{m+1} . Since $L^{<2n} \subset L^{<2m}$ (because $n > m$), then $j_n^{\text{LMO}}(L^{<2m}) = 0$. Besides, $P_0^{m+1} \subset P^{m+1}$ and the restriction of $j_n^{\text{LMO}} : \bigoplus_{k \geq 0} \mathring{\mathcal{A}}_k^\wedge \rightarrow \mathring{\mathcal{A}}_0^\wedge$ to $\mathring{\mathcal{A}}_0^\wedge$ is the identity, therefore $P_0^{m+1} = j_n^{\text{LMO}}(P_0^{m+1}) \subset j_n^{\text{LMO}}(P^{m+1})$. Thus, we have $j_n^{\text{LMO}}(P^{m+1}) = P_0^{m+1}$. To sum up,

$$P_0^{m+1} = j_n^{\text{LMO}}(P^{m+1} + L^{2m} + (\text{CO}\mathring{\mathcal{A}}^\wedge)) \subset J.$$

From this, it follows that $\mathring{\mathcal{A}}_0^\wedge[0] \cap P_0^{m+1} = P_0^{m+1}[0] \subset J[0]$. By Proposition 4.62(a), the ideal $P_0^{m+1}[0]$ is generated by $X(X+2) \cdots (X+2m)$. Consequently, the element $X(X+2) \cdots (X+2(n-1))$ belongs to $P_0^{m+1}[0] \subset J[0]$ (because $n > m$). Hence, by Proposition 4.66, the elements $j_n^{\text{LMO}}(\text{cs}^\nu \circ Z_{\mathcal{A}}(U^\pm))[0]$ belong to $J[0]$. Therefore, similarly to the case $n < m$, we conclude that the pair $(\mathring{\mathcal{A}}^\wedge(\emptyset)/J, \bar{j}_{n,m,J} \circ \varphi_n \circ \overline{\text{cs}}^\nu \circ Z_{\mathcal{A}})$ is not a Kirby structure. \square

5. ELIMINATION OF REDUNDANT INFORMATION AND THE LMO INVARIANT

We start this section by recalling in §5.1 the well-known coproduct map $\Delta_{\bigoplus_{k \geq 0} \mathring{\mathcal{A}}_k^\wedge}$ for the algebra $\bigoplus_{k \geq 0} \mathring{\mathcal{A}}_k^\wedge$, which endows it with a bialgebra structure (Proposition 5.4). Recall that the algebras $\mathfrak{b}(n)$, $\mathfrak{c}(n)$ and $\mathfrak{d}(n)$ (from §4.3, §4.5 and §4.6, respectively) are quotients of $\bigoplus_{k \geq 0} \mathring{\mathcal{A}}_k^\wedge$, we show that the above coproduct map induces coproduct maps $\Delta_{n,p}^{\mathfrak{b}} : \mathfrak{b}(n) \rightarrow \mathfrak{b}(p) \otimes \mathfrak{b}(n-p)$, $\Delta_{n,p}^{\mathfrak{c}} : \mathfrak{c}(n) \rightarrow \mathfrak{c}(p) \otimes \mathfrak{b}(n-p)$ and $\Delta_{n,p}^{\mathfrak{d}} : \mathfrak{d}(n) \rightarrow \mathfrak{d}(p) \otimes \mathfrak{d}(n-p)$ in §5.2, §5.3 and §5.4, respectively. We show in the same sections that $\Delta_{n,p}^{\mathfrak{b}}$ is a morphism of semi-Kirby structures (Proposition 5.26) and that $\Delta_{n,p}^{\mathfrak{c}}$ and $\Delta_{n,p}^{\mathfrak{d}}$ are morphisms of Kirby structures (Proposition 5.27 and Proposition 5.28, respectively). This allows us to show a compatibility between the family of invariants of 3-manifolds $\{\Omega_n^{\mathfrak{c}}\}_{n \geq 1}$ (resp. $\{\Omega_n^{\mathfrak{d}}\}_{n \geq 1}$) obtained in §4 (see Theorem 4.73) and the coproduct maps $\Delta_{n,p}^{\mathfrak{c}}$ (resp. $\Delta_{n,p}^{\mathfrak{d}}$), see Proposition 5.31. In §5.5, we consider a family of Kirby structures $\{\mathfrak{c}(n)\}_{n \geq 1}$ and Kirby morphisms $\Delta_{n,p}^{\mathfrak{c}} : \mathfrak{c}(n) \rightarrow \mathfrak{c}(p) \otimes \mathfrak{c}(n-p)$ (Proposition 5.36) and show it to be isomorphic to the family $\{\mathfrak{d}(n)\}_{n \geq 1}$ of Kirby structures (Lemma 5.37). To the family $\{\mathfrak{c}(n)\}_{n \geq 1}$ we associate the family of invariants $\{\Omega_n^{\mathfrak{c}}\}_{n \geq 1}$ of oriented closed 3-manifolds. One can prove that the new information given by $\Omega_n^{\mathfrak{c}}$ with respect to the previous $\Omega_k^{\mathfrak{c}}$ ($k < n$) is contained in the degree n part of $\Omega_n^{\mathfrak{c}}$, see Corollary 5.44. This allows us to unify the family of invariants $\{\Omega_n^{\mathfrak{c}}\}_{n \geq 1}$ into a single invariant: the LMO invariant Z^{LMO} , see §5.6. In §4.7, we prove that $\text{pr}_1 : \mathfrak{c}(1) \rightarrow \mathfrak{d}(1)$ is an isomorphism (see §4.6 for the definition of $\text{pr}_n : \mathfrak{c}(n) \rightarrow \mathfrak{d}(n)$), from which we derive the equality of invariants $\Omega_1^{\mathfrak{c}} = \Omega_1^{\mathfrak{d}}$. For $n \geq 2$, the map $\text{pr}_n : \mathfrak{c}(n) \rightarrow \mathfrak{d}(n)$ is surjective, but it is not known whether it is injective; in the case it is not, the invariant $\Omega_n^{\mathfrak{c}}$ may contain additional information with respect to $\Omega_n^{\mathfrak{d}}$.

5.1. A bialgebra structure on $\bigoplus_{k \geq 0} \hat{\mathcal{A}}_k^\wedge$.

5.1.1. *Coproduct on $\hat{\mathcal{A}}_k^\wedge$.* Let $k \geq 0$. Recall that the set $\mathring{\text{Jac}}(\vec{\emptyset}, \llbracket 1, k \rrbracket)$ consists of tuples of the form $\underline{D} = (D, \varphi, \{\text{cyc}_i\}_{i \in \llbracket 1, k \rrbracket})$ where D is a vertex-oriented univalent graph, $\varphi : \partial D \rightarrow \llbracket 1, k \rrbracket$ is a map and cyc_i is a cyclic order on $\varphi^{-1}(i)$ for each $i \in \llbracket 1, k \rrbracket$, see Definition 3.7.

Definition 5.1. Let $\underline{D} = (D, \varphi, \{\text{cyc}_i\}_{i \in \llbracket 1, k \rrbracket}) \in \mathring{\text{Jac}}(\vec{\emptyset}, \llbracket 1, k \rrbracket)$.

(a) For $A \subset \pi_0(D)$ we set

$$\underline{D}_A := \left(\bigsqcup_{x \in A} x, \varphi|_{\bigsqcup_{x \in A} \partial x}, \{\widetilde{\text{cyc}}_i\}_{i \in \llbracket 1, k \rrbracket} \right) \in \mathring{\text{Jac}}(\vec{\emptyset}, \llbracket 1, k \rrbracket),$$

where $\widetilde{\text{cyc}}_i$ is the restriction of cyc_i to $\varphi^{-1}(i) \cap \bigsqcup_{x \in A} \partial x$ for all $i \in \llbracket 1, k \rrbracket$.

(b) Define the linear map

$$(5.1) \quad \Delta_{\mathring{\text{Jac}}(\vec{\emptyset}, \llbracket 1, k \rrbracket)} : \mathbb{C}\mathring{\text{Jac}}(\vec{\emptyset}, \llbracket 1, k \rrbracket) \longrightarrow \mathbb{C}\mathring{\text{Jac}}(\vec{\emptyset}, \llbracket 1, k \rrbracket) \otimes \mathbb{C}\mathring{\text{Jac}}(\vec{\emptyset}, \llbracket 1, k \rrbracket),$$

by

$$\underline{D} \longmapsto \sum_{A \subset \pi_0(D)} \Delta_{\mathring{\text{Jac}}(\vec{\emptyset}, \llbracket 1, k \rrbracket)}(\underline{D}_A) \otimes \underline{D}_{\pi_0(D) \setminus A}$$

for any $\underline{D} \in \mathring{\text{Jac}}(\vec{\emptyset}, \llbracket 1, k \rrbracket)$. In other words $\Delta_{\mathring{\text{Jac}}(\vec{\emptyset}, \llbracket 1, k \rrbracket)}(\underline{D})$ is the linear combination in $\mathbb{C}\mathring{\text{Jac}}(\vec{\emptyset}, \llbracket 1, k \rrbracket) \otimes \mathbb{C}\mathring{\text{Jac}}(\vec{\emptyset}, \llbracket 1, k \rrbracket)$ obtained by considering all the possible ways of splitting the connected components of D into the two tensor factors. See Figure 5.1 for an example.

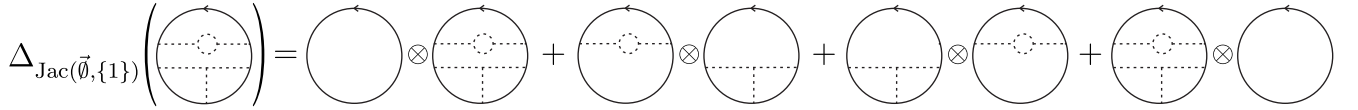

FIGURE 5.1. Image of an element in $\mathring{\text{Jac}}(\vec{\emptyset}, \{1\})$ under the map $\Delta_{\mathring{\text{Jac}}(\vec{\emptyset}, \{1\})}$.

One checks that the map (5.1) equips $\mathbb{C}\mathring{\text{Jac}}(\vec{\emptyset}, \llbracket 1, k \rrbracket)$ with a cocommutative coassociative coalgebra structure and that there is a unique continuous linear map $\Delta_{\hat{\mathcal{A}}_k^\wedge} : \hat{\mathcal{A}}_k^\wedge \rightarrow \hat{\mathcal{A}}_k^\wedge \hat{\otimes} \hat{\mathcal{A}}_k^\wedge$, which makes $\hat{\mathcal{A}}_k^\wedge$ into a coassociative coalgebra such that the projection $\mathbb{C}\mathring{\text{Jac}}(\vec{\emptyset}, \llbracket 1, k \rrbracket) \rightarrow \hat{\mathcal{A}}_k^\wedge$ is a coalgebra homomorphism.

Lemma 5.2 ([41, Proposition 6.9]). *Let $k \geq 0$. The image of $Z_A : \vec{\mathcal{T}}(\emptyset, \emptyset)_k \rightarrow \hat{\mathcal{A}}_k^\wedge$ (see Theorem 3.37) is contained in the set of group-like elements. That is, for any $L \in \vec{\mathcal{T}}(\emptyset, \emptyset)_k$ we have*

$$\Delta_{\hat{\mathcal{A}}_k^\wedge}(Z_A(L)) = Z_A(L) \hat{\otimes} Z_A(L) \in \hat{\mathcal{A}}_k^\wedge \hat{\otimes} \hat{\mathcal{A}}_k^\wedge.$$

5.1.2. Coproduct on $\bigoplus_{k \geq 0} \hat{\mathcal{A}}_k^\wedge$.

Lemma 5.3. *There is a unique cocommutative coassociative coalgebra structure on $\bigoplus_{k \geq 0} \hat{\mathcal{A}}_k^\wedge$ with coproduct*

$$(5.2) \quad \Delta_{\bigoplus_{k \geq 0} \hat{\mathcal{A}}_k^\wedge} : \bigoplus_{k \geq 0} \hat{\mathcal{A}}_k^\wedge \longrightarrow \bigoplus_{k \geq 0} \hat{\mathcal{A}}_k^\wedge \hat{\otimes} \bigoplus_{k \geq 0} \hat{\mathcal{A}}_k^\wedge$$

such that for any $k \geq 0$, the injection $\hat{\mathcal{A}}_k^\wedge \subset \bigoplus_{k' \geq 0} \hat{\mathcal{A}}_{k'}^\wedge$ is a coalgebra homomorphism.

Proof. The proof is immediate. □

5.1.3. Compatibility of coproduct and product of $\bigoplus_{k \geq 0} \mathring{\mathcal{A}}_k^\wedge$.

Proposition 5.4. *The map*

$$\Delta_{\bigoplus_{k \geq 0} \mathring{\mathcal{A}}_k^\wedge} : \bigoplus_{k \geq 0} \mathring{\mathcal{A}}_k^\wedge \longrightarrow \bigoplus_{k \geq 0} \mathring{\mathcal{A}}_k^\wedge \hat{\otimes} \bigoplus_{k \geq 0} \mathring{\mathcal{A}}_k^\wedge$$

from (5.2) is an algebra homomorphism. Therefore, $\bigoplus_{k \geq 0} \mathring{\mathcal{A}}_k^\wedge$ is a bialgebra.

Proof. One checks that the space $\bigoplus_{k \geq 0} \mathring{\text{CJac}}(\vec{\emptyset}, \llbracket 1, k \rrbracket)$, equipped with the product

$$\otimes_{\mathring{\text{Jac}}} : \mathring{\text{CJac}}(\vec{\emptyset}, \llbracket 1, k \rrbracket) \otimes \mathring{\text{CJac}}(\vec{\emptyset}, \llbracket 1, l \rrbracket) \longrightarrow \mathring{\text{CJac}}(\vec{\emptyset}, \llbracket 1, k \rrbracket \sqcup \llbracket 1, l \rrbracket) \simeq \mathring{\text{CJac}}(\vec{\emptyset}, \llbracket 1, k+l \rrbracket),$$

where the first map is as in Definition 3.13 and the second map is induced by the bijection $\llbracket 1, k \rrbracket \sqcup \llbracket 1, l \rrbracket \simeq \llbracket 1, k+l \rrbracket$ given by $x \mapsto x$ for $x \in \llbracket 1, k \rrbracket$ and $y \mapsto k+y$ for $y \in \llbracket 1, l \rrbracket$, is an associative (non-commutative) algebra. The fact that $\Delta_{\mathring{\text{Jac}}}$ is a morphism of algebras from this algebra to its tensor square follows from the equality

$$(\underline{D} \otimes_{\mathring{\text{Jac}}} \underline{E})_A = \left(\underline{D}_{A \cap \pi_0(D)} \right) \otimes_{\mathring{\text{Jac}}} \left(\underline{E}_{A \cap \pi_0(E)} \right)$$

for any $A \subset \pi_0(D) \sqcup \pi_0(E)$. The projection $\bigoplus_{k \geq 0} \mathring{\text{CJac}}(\vec{\emptyset}, \llbracket 1, k \rrbracket) \rightarrow \bigoplus_k \mathring{\mathcal{A}}_k^\wedge$ is compatible with the products and coproducts. The compatibility of the product and coproduct in its source then imply the same for the product and coproduct in the target. \square

Proposition 5.5 ([41, Proposition 10.3]). *The algebra automorphism cs^ν of the algebra $\bigoplus_{k \geq 0} \mathring{\mathcal{A}}_k^\wedge$ (see §4.1) is a bialgebra automorphism.*

Remark 5.6. Recall that the algebras $\mathfrak{s}(\mathbf{A})$ and \mathfrak{a} are defined as the quotient algebras of $\bigoplus_{k \geq 0} \mathring{\mathcal{A}}_k^\wedge$ by the ideals $(\text{KII}\mathring{\mathcal{A}}^\wedge) + (\text{CO}\mathring{\mathcal{A}}^\wedge)$ and $(\text{KII}^s\mathring{\mathcal{A}}^\wedge) + (\text{CO}\mathring{\mathcal{A}}^\wedge)$, respectively. We expect these ideals to be bialgebra ideals, so that $\mathfrak{s}(\mathbf{A})$ and \mathfrak{a} are bialgebras. Moreover, we expect that the algebra homomorphisms $\mu : \mathring{\mathfrak{K}}\mathfrak{r} \rightarrow \mathfrak{s}(\mathbf{A})$ and $\overline{cs}^\nu : \mathfrak{s}(\mathbf{A}) \rightarrow \mathfrak{a}$ to be bialgebra homomorphisms.

5.2. A semi-Kirby structure morphism $\Delta_{n,p}^b : \mathfrak{b}(n) \rightarrow \mathfrak{b}(p) \otimes \mathfrak{b}(n-p)$. Consider integers $n \geq 1$ and $p \in \llbracket 1, n-1 \rrbracket$.

5.2.1. Preliminaries on coproducts. Let $k, m \geq 0$ be integers. Recall from Definition 3.48 that the set $\mathring{\text{Jac}}(\vec{\emptyset}, \llbracket 1, k \rrbracket, \llbracket 1, m \rrbracket)$ consists of classes of tuples $(D, \varphi : \partial D \rightarrow \llbracket 1, k \rrbracket \sqcup \llbracket 1, m \rrbracket, \{\text{cyc}_s\}_{s \in \llbracket 1, k \rrbracket})$ where the image of φ contains $\llbracket 1, m \rrbracket$, the preimage of any element of $\llbracket 1, m \rrbracket$ has cardinality 1, and cyc_s is a cyclic order on $\varphi^{-1}(s)$ for any $s \in \llbracket 1, k \rrbracket$. There is an action of the symmetric group \mathfrak{S}_m on m letters on $\mathring{\text{Jac}}(\vec{\emptyset}, \llbracket 1, k \rrbracket, \llbracket 1, m \rrbracket)$ given by

$$\sigma \cdot (D, \varphi, \{\text{cyc}_s\}_{s \in \llbracket 1, k \rrbracket}) := (D, (\text{Id}_{\llbracket 1, k \rrbracket} \sqcup \sigma) \circ \varphi, \{\text{cyc}_s\}_{s \in \llbracket 1, k \rrbracket})$$

for any $\sigma \in \mathfrak{S}_m$ and $(D, \varphi, \{\text{cyc}_s\}_{s \in \llbracket 1, k \rrbracket}) \in \mathring{\text{Jac}}(\vec{\emptyset}, \llbracket 1, k \rrbracket, \llbracket 1, m \rrbracket)$.

Definition 5.7. We set

$$(5.3) \quad \mathring{\text{Jac}}(\vec{\emptyset}, \llbracket 1, k \rrbracket, m) := \frac{\mathring{\text{Jac}}(\vec{\emptyset}, \llbracket 1, k \rrbracket, \llbracket 1, m \rrbracket)}{\mathfrak{S}_m} \quad \text{and} \quad \mathring{\text{Jac}}(\vec{\emptyset}, \llbracket 1, k \rrbracket, \bullet) := \bigsqcup_{m \geq 0} \mathring{\text{Jac}}(\vec{\emptyset}, \llbracket 1, k \rrbracket, m).$$

Notice that $\mathring{\text{Jac}}(\vec{\emptyset}, \llbracket 1, k \rrbracket, 0) = \mathring{\text{Jac}}(\vec{\emptyset}, \llbracket 1, k \rrbracket, \emptyset) = \mathring{\text{Jac}}(\vec{\emptyset}, \llbracket 1, k \rrbracket)$, from now on we will use this identification. Moreover, we have a grading on $\mathring{\text{CJac}}(\vec{\emptyset}, \llbracket 1, k \rrbracket, \bullet)$ induced by \bullet .

Lemma 5.8. *The set $\mathring{\text{Jac}}(\vec{\emptyset}, \llbracket 1, k \rrbracket, \bullet)$ consists of tuples $(D, \partial D_a, \partial D_f, \varphi : \partial D_a \rightarrow \llbracket 1, k \rrbracket, \{\text{cyc}_s\}_{s \in \llbracket 1, k \rrbracket})$ where D is a vertex-oriented univalent graph, $\partial D = \partial D_a \sqcup \partial D_f$ is a partition, $\varphi : \partial D_a \rightarrow \llbracket 1, k \rrbracket$ is a map and cyc_s is a cyclic order on $\varphi^{-1}(s)$ for any $s \in \llbracket 1, k \rrbracket$.*

Proof. This is just a restatement of Definition 5.7. \square

From now on, for $\underline{D} = (D, \partial D_a, \partial D_f, \varphi : \partial D_a \rightarrow \llbracket 1, k \rrbracket, \{\text{cyc}_s\}_{s \in \llbracket 1, k \rrbracket}) \in \mathring{\text{Jac}}(\vec{\emptyset}, \llbracket 1, k \rrbracket, \bullet)$ we set $\pi_0(\underline{D}) := \pi_0(D)$ and $\partial \underline{D}_f := \partial D_f$.

Lemma 5.9. *For $\underline{D} \in \mathring{\text{Jac}}(\vec{\emptyset}, \llbracket 1, k \rrbracket, \bullet)$ and $A \subset \pi_0(\underline{D})$ we set*

$$\underline{D}_A := \left(\bigsqcup_{x \in A} x, (\partial D_a) \cap \bigsqcup_{x \in A} x, (\partial D_f) \cap \bigsqcup_{x \in A} x, \varphi|_{(\partial D_a) \cap \bigsqcup_{x \in A} x}, \{\text{cyc}_s^A\}_{s \in \llbracket 1, k \rrbracket} \right)$$

where cyc_s^A is the restriction to $\varphi^{-1}(s) \cap \bigsqcup_{x \in A} x$ of the cyclic order cyc_s . Then $\underline{D}_A \in \mathring{\text{Jac}}(\vec{\emptyset}, \llbracket 1, k \rrbracket, \bullet)$. If moreover $\underline{D} \in \mathring{\text{Jac}}(\vec{\emptyset}, \llbracket 1, k \rrbracket, 0)$ and $A \subset \pi_0(\underline{D})$, we have $\underline{D}_A \in \mathring{\text{Jac}}(\vec{\emptyset}, \llbracket 1, k \rrbracket, 0)$.

Proof. The result follows directly from the definitions. \square

Let $\underline{D} \in \mathring{\text{Jac}}(\vec{\emptyset}, \llbracket 1, k \rrbracket, \bullet)$, $A \subset \pi_0(\underline{D})$ and $\pi_0(\underline{D}) \setminus A$ the complement of A in $\pi_0(\underline{D})$. Then $\sum_{A \subset \pi_0(\underline{D})} \underline{D}_A \otimes \underline{D}_{\pi_0(\underline{D}) \setminus A} \in \mathbb{C} \mathring{\text{Jac}}(\vec{\emptyset}, \llbracket 1, k \rrbracket, \bullet) \otimes \mathbb{C} \mathring{\text{Jac}}(\vec{\emptyset}, \llbracket 1, k \rrbracket, \bullet)$.

Definition 5.10. Define the linear map

$$(5.4) \quad \Delta_{\mathring{\text{Jac}}(\vec{\emptyset}, \llbracket 1, k \rrbracket, \bullet)} : \mathbb{C} \mathring{\text{Jac}}(\vec{\emptyset}, \llbracket 1, k \rrbracket, \bullet) \longrightarrow \mathbb{C} \mathring{\text{Jac}}(\vec{\emptyset}, \llbracket 1, k \rrbracket, \bullet) \otimes \mathbb{C} \mathring{\text{Jac}}(\vec{\emptyset}, \llbracket 1, k \rrbracket, \bullet),$$

by

$$\underline{D} \longmapsto \xrightarrow{\Delta_{\mathring{\text{Jac}}(\vec{\emptyset}, \llbracket 1, k \rrbracket, \bullet)}} \sum_{A \subset \pi_0(\underline{D})} \underline{D}_A \otimes \underline{D}_{\pi_0(\underline{D}) \setminus A}$$

for any $\underline{D} \in \mathring{\text{Jac}}(\vec{\emptyset}, \llbracket 1, k \rrbracket, \bullet)$.

Lemma 5.11. *The map $\Delta_{\mathring{\text{Jac}}(\vec{\emptyset}, \llbracket 1, k \rrbracket, \bullet)}$ from (5.4) is compatible with grading of $\mathbb{C} \mathring{\text{Jac}}(\vec{\emptyset}, \llbracket 1, k \rrbracket, \bullet)$. In particular, it restricts to a map*

$$(5.5) \quad \Delta_{\mathring{\text{Jac}}(\vec{\emptyset}, \llbracket 1, k \rrbracket, 0)} : \mathbb{C} \mathring{\text{Jac}}(\vec{\emptyset}, \llbracket 1, k \rrbracket, 0) \longrightarrow \mathbb{C} \mathring{\text{Jac}}(\vec{\emptyset}, \llbracket 1, k \rrbracket, 0) \otimes \mathbb{C} \mathring{\text{Jac}}(\vec{\emptyset}, \llbracket 1, k \rrbracket, 0).$$

Proof. The proof is straightforward. \square

Under the identification $\mathring{\text{Jac}}(\vec{\emptyset}, \llbracket 1, k \rrbracket, 0) = \mathring{\text{Jac}}(\vec{\emptyset}, \llbracket 1, k \rrbracket, \emptyset) = \mathring{\text{Jac}}(\vec{\emptyset}, \llbracket 1, k \rrbracket)$, the two coproducts maps $\Delta_{\mathring{\text{Jac}}(\vec{\emptyset}, \llbracket 1, k \rrbracket, 0)}$ and $\Delta_{\mathring{\text{Jac}}(\vec{\emptyset}, \llbracket 1, k \rrbracket)}$ (from Definition 5.1 (b)) coincide.

Let $\underline{D} \in \mathring{\text{Jac}}(\vec{\emptyset}, \llbracket 1, k \rrbracket, \bullet)$. Recall from (4.42) that there is a map $\mathring{\text{Jac}} : \text{FPFI}(\partial \underline{D}_f) \rightarrow \mathring{\text{Jac}}(\vec{\emptyset}, \emptyset, \partial \underline{D}_f)$ (the set $\text{FPFI}(\partial \underline{D}_f)$ is equal to \emptyset if $|\partial \underline{D}_f|$ is odd). Hence, given $\sigma \in \text{FPFI}(\partial \underline{D}_f)$ we obtain an element

$$(5.6) \quad \langle \underline{D}, \mathring{\text{Jac}}(\sigma) \rangle \in \mathring{\text{Jac}}(\vec{\emptyset}, \llbracket 1, k \rrbracket, 0) = \mathring{\text{Jac}}(\vec{\emptyset}, \llbracket 1, k \rrbracket),$$

where $\langle \cdot, \cdot \rangle$ is the pairing (3.17) in Definition 3.50.

Definition 5.12. Let $\underline{D} \in \mathring{\text{Jac}}(\vec{\emptyset}, \llbracket 1, k \rrbracket, \bullet)$.

(a) Define the sets

$$\text{Set}_{\underline{D}} := \left\{ (A, \sigma, \sigma') \mid A \subset \pi_0(\underline{D}), \sigma \in \text{FPFI} \left(\partial \underline{D}_f \cap \bigsqcup_{x \in A} x \right), \sigma' \in \text{FPFI} \left(\partial \underline{D}_f \cap \bigsqcup_{x \in (\pi_0(\underline{D}) \setminus A)} x \right) \right\}$$

and

$$\widetilde{\text{Set}}_{\underline{D}} := \left\{ (\tilde{\sigma}, \tilde{A}) \mid \tilde{\sigma} \in \text{FPFI}(\partial \underline{D}_f), \tilde{A} \subset \pi_0(\langle \underline{D}, \mathring{\text{Jac}}(\tilde{\sigma}) \rangle) \right\}.$$

(b) Define the map

$$(5.7) \quad (l_{\underline{D}}, r_{\underline{D}}) : \text{Set}_{\underline{D}} \longrightarrow \mathring{\text{Jac}}(\vec{\emptyset}, \llbracket 1, k \rrbracket) \times \mathring{\text{Jac}}(\vec{\emptyset}, \llbracket 1, k \rrbracket), \quad (A, \sigma, \sigma') \longmapsto (l_{\underline{D}}(A, \sigma, \sigma'), r_{\underline{D}}(A, \sigma, \sigma')),$$

where $l_{\underline{D}}(A, \sigma, \sigma') := \langle \underline{D}_A, \mathring{\text{Jac}}(\sigma) \rangle$ and $r_{\underline{D}}(A, \sigma, \sigma') := \langle \underline{D}_{\pi_0(\underline{D}) \setminus A}, \mathring{\text{Jac}}(\sigma') \rangle$ for any $(A, \sigma, \sigma') \in \text{Set}_{\underline{D}}$.

(c) Define the map

$$(5.8) \quad (\tilde{l}_{\underline{D}}, \tilde{r}_{\underline{D}}) : \widetilde{\text{Set}}_{\underline{D}} \longrightarrow \mathring{\text{Jac}}(\vec{\emptyset}, \llbracket 1, k \rrbracket) \times \mathring{\text{Jac}}(\vec{\emptyset}, \llbracket 1, k \rrbracket), \quad (\tilde{\sigma}, \tilde{A}) \longmapsto (\tilde{l}_{\underline{D}}(A, \sigma, \sigma'), \tilde{r}_{\underline{D}}(A, \sigma, \sigma')),$$

where $\tilde{l}_D(\tilde{\sigma}, \tilde{A}) := \langle \underline{D}, \mathring{\text{Jac}}(\tilde{\sigma}) \rangle_{\tilde{A}}$ and $\tilde{r}_D(\tilde{\sigma}, \tilde{A}) := \langle \underline{D}, \mathring{\text{Jac}}(\tilde{\sigma}) \rangle_{\pi_0(\langle \underline{D}, \mathring{\text{Jac}}(\tilde{\sigma}) \rangle) \setminus \tilde{A}}$ for any $(\tilde{\sigma}, \tilde{A}) \in \widetilde{\text{Set}}_D$.

Notice that if in Definition 5.12 the number $|\partial \underline{D}_f|$ is odd, then $\text{Set}_D = \widetilde{\text{Set}}_D = \emptyset$.

Definition 5.13. Let U and V be finite sets and $f : U \rightarrow V$ be a surjective map.

(a) For $\tilde{\sigma} \in \text{FPFI}(U)$ let $\sim_{\tilde{\sigma}}$ be the finest equivalent relation on V such that $f(u) \sim_{\tilde{\sigma}} f(\tilde{\sigma}u)$. Explicitly, $v \sim_{\tilde{\sigma}} v'$ if and only if $v = v'$ or there exists $i \geq 0$ and $u_0, \dots, u_i \in U$ such that $v_0 := f(u_0)$, $v_1 := f(\tilde{\sigma}u_0) = f(u_1)$, \dots , $v_i := f(\tilde{\sigma}u_{i-1}) = f(u_i)$ and $v = v_0$ and $v' = v_i$.

(b) Define the sets

$$\text{Set}(f) := \left\{ (A, \sigma, \sigma') \mid A \subset V, \sigma \in \text{FPFI}(f^{-1}(A)), \sigma' \in \text{FPFI}(f^{-1}(V \setminus A)) \right\}$$

and

$$\widetilde{\text{Set}}(f) := \left\{ (\tilde{\sigma}, \tilde{A}) \mid \tilde{\sigma} \in \text{FPFI}(U), \tilde{A} \subset V / \sim_{\tilde{\sigma}} \right\}.$$

Recall that for a set E , we denote by \mathfrak{S}_E the group of permutations of E . For E and F finite sets there exists a unique operation

$$(5.9) \quad \mathfrak{S}_E \times \mathfrak{S}_F \rightarrow \mathfrak{S}_{E \sqcup F}$$

taking $(\alpha, \beta) \in \mathfrak{S}_E \times \mathfrak{S}_F$ to the unique permutation γ of $E \sqcup F$ such that $\gamma|_E = \alpha$ and $\gamma|_F = \beta$. We denote $\gamma := \alpha \sqcup \beta$ and call it the *disjoint union* of α and β .

Lemma 5.14. Let U and V be finite sets and $f : U \rightarrow V$ be a surjective map.

(a) To each $(A, \sigma, \sigma') \in \text{Set}(f)$ we associate the pair $(\tilde{\sigma}, \tilde{A})$ where $\tilde{\sigma} := \sigma \sqcup \sigma'$ and \tilde{A} is the image of A in $V / \sim_{\tilde{\sigma}}$ under the canonical projection $V \rightarrow V / \sim_{\tilde{\sigma}}$. Then $(\tilde{\sigma}, \tilde{A}) \in \widetilde{\text{Set}}(f)$ and the map

$$\Phi : \text{Set}(f) \longrightarrow \widetilde{\text{Set}}(f), \quad (A, \sigma, \sigma') \longmapsto (\tilde{\sigma}, \tilde{A})$$

is a bijection.

(b) There are involutions a and \tilde{a} of $\text{Set}(f)$ and $\widetilde{\text{Set}}(f)$, respectively defined by $a(A, \sigma, \sigma') := (V \setminus A, \sigma', \sigma)$ and $\tilde{a}(\tilde{\sigma}, \tilde{A}) := (\tilde{\sigma}, (V / \sim_{\tilde{\sigma}}) \setminus \tilde{A})$ for any $(A, \sigma, \sigma') \in \text{Set}(f)$ and $(\tilde{\sigma}, \tilde{A}) \in \widetilde{\text{Set}}(f)$. They are such that $\tilde{a} \circ \Phi = \Phi \circ a$.

Proof. (a) Since f is surjective, $U = f^{-1}(A) \sqcup f^{-1}(V \setminus A)$. One checks that the disjoint union operation (5.9) $\mathfrak{S}_{f^{-1}(A)} \times \mathfrak{S}_{f^{-1}(V \setminus A)} \rightarrow \mathfrak{S}_U$ induces a map

$$\text{FPFI}(f^{-1}(A)) \times \text{FPFI}(f^{-1}(V \setminus A)) \longrightarrow \text{FPFI}(U).$$

Thus, if $(A, \sigma, \sigma') \in \text{Set}(f)$ then $\sigma \sqcup \sigma' \in \text{FPFI}(U)$ and therefore $(\tilde{\sigma}, \tilde{A}) \in \widetilde{\text{Set}}(f)$. To show that Φ is bijective we define a map $\Psi : \widetilde{\text{Set}}(f) \rightarrow \text{Set}(f)$ and show that $\Phi \circ \Psi = \text{Id}_{\widetilde{\text{Set}}(f)}$ and $\Psi \circ \Phi = \text{Id}_{\text{Set}(f)}$.

For $(\tilde{\sigma}, \tilde{A}) \in \widetilde{\text{Set}}(f)$ we set $A \subset V$ equal to the preimage of \tilde{A} under the projection $V \rightarrow V / \sim_{\tilde{\sigma}}$ and $\sigma := \tilde{\sigma}|_{f^{-1}(A)}$ and $\sigma' := \tilde{\sigma}|_{f^{-1}(V \setminus A)}$. Notice that $A = \bigcup_{a \in V / \sim_{\tilde{\sigma}}} \hat{a}$ where \hat{a} is preimage of a under the projection $V \rightarrow V / \sim_{\tilde{\sigma}}$. That is, A is a union of orbits of $\sim_{\tilde{\sigma}}$. Since the orbits of $\sim_{\tilde{\sigma}}$ are unions of the images of orbits of $\tilde{\sigma}$, the preimages of the unions of orbits of $\sim_{\tilde{\sigma}}$ are unions of orbits of $\tilde{\sigma}$. Therefore, $f^{-1}(A)$ is stable under $\tilde{\sigma}$ which, since $\tilde{\sigma}$ is a permutation of U , implies that $f^{-1}(V \setminus A)$ is also stable under $\tilde{\sigma}$. Hence, $\sigma \in \text{FPFI}(f^{-1}(A))$ and $\sigma' \in \text{FPFI}(f^{-1}(V \setminus A))$ and therefore $(A, \sigma, \sigma') \in \text{Set}(f)$. This assignment defines the map $\Psi : \widetilde{\text{Set}}(f) \rightarrow \text{Set}(f)$.

We now proceed to show that $\Phi \circ \Psi = \text{Id}_{\widetilde{\text{Set}}(f)}$ and $\Psi \circ \Phi = \text{Id}_{\text{Set}(f)}$. Let $(\tilde{\sigma}, \tilde{A})$ in $\widetilde{\text{Set}}(f)$. Then $\Psi(\tilde{\sigma}, \tilde{A}) = (A, \sigma, \sigma')$ given as in the above paragraph so $\Phi \circ \Psi(\tilde{\sigma}, \tilde{A}) = \Phi(A, \sigma, \sigma') = (\tilde{\sigma}, \tilde{A})$. Here $\tilde{\sigma} = \sigma \sqcup \sigma'$, which is equal to $\tilde{\sigma}$ since σ and σ' are the restrictions of $\tilde{\sigma}$ to complementary subsets of U . Besides, \tilde{A} is the image $\text{Im}(A \subset V \rightarrow V / \sim_{\tilde{\sigma}} = V / \sim_{\tilde{\sigma}})$ but A is the preimage of \tilde{A} under the same map, which is surjective, and therefore $\tilde{A} = \tilde{A}$. We then conclude $\Phi \circ \Psi = \text{Id}_{\widetilde{\text{Set}}(f)}$.

Let $(A, \sigma, \sigma') \in \text{Set}(f)$. Then $\Phi(A, \sigma, \sigma') = (\tilde{\sigma}, \tilde{A})$ as in the statement of the lemma and $\Psi \circ \Phi(A, \sigma, \sigma') = \Psi(\tilde{\sigma}, \tilde{A}) = (\underline{A}, \underline{\sigma}, \underline{\sigma}')$. Here \underline{A} is the preimage of $\tilde{A} \subset V / \sim_{\tilde{\sigma}}$ by the projection $V \rightarrow V / \sim_{\tilde{\sigma}}$, while \tilde{A} is the image of A under the same projection. Since $\tilde{\sigma} \in \text{Perm}(U)$ preserves $f^{-1}(A)$, then A is a union of equivalence classes under $\sim_{\tilde{\sigma}}$, which implies that $\underline{A} = A$. Then $\underline{\sigma}$ and $\underline{\sigma}'$ are respectively the restrictions of $\tilde{\sigma}$ to $f^{-1}(\underline{A}) = f^{-1}(A)$ and $f^{-1}(V \setminus \underline{A}) = f^{-1}(V \setminus A)$, which are σ and σ' . Hence $\Psi \circ \Phi = \text{Id}_{\text{Set}(f)}$.

(b) The first statement is obvious. If $(A, \sigma, \sigma') \in \text{Set}(f)$, then $\Phi(A, \sigma, \sigma')$ is equal to $(\tilde{\sigma}, \tilde{A})$ given by (a). Then $\tilde{a} \circ \Phi(A, \sigma, \sigma') = \tilde{a}(\tilde{\sigma}, \tilde{A}) = (\tilde{\sigma}, (V / \sim_{\tilde{\sigma}}) \setminus \tilde{A})$. On the other hand, $\mathfrak{a}(A, \sigma, \sigma') = (V \setminus A, \sigma', \sigma)$. Then $\Phi \circ \mathfrak{a}(A, \sigma, \sigma') = \Phi(V \setminus A, \sigma', \sigma) = (\tilde{\sigma}, \tilde{B})$ where $\tilde{\sigma} := \sigma' \sqcup \sigma = \tilde{\sigma}$, and \tilde{B} is the image in $V / \sim_{\tilde{\sigma}} = V / \sim_{\tilde{\sigma}}$ of $V \setminus A \subset V$ under the canonical projection $V \rightarrow V / \sim_{\tilde{\sigma}} = V / \sim_{\tilde{\sigma}}$. Since A is a union of classes of $\sim_{\tilde{\sigma}}$, then $\tilde{B} = (V / \sim_{\tilde{\sigma}}) \setminus \text{Im}(A \subset V \rightarrow V / \sim_{\tilde{\sigma}}) = (V / \sim_{\tilde{\sigma}}) \setminus \tilde{A}$. Therefore $\Phi \circ \mathfrak{a}(A, \sigma, \sigma') = \tilde{a} \circ \Phi(A, \sigma, \sigma')$. \square

Lemma 5.15. For any $\underline{D} \in \mathring{\text{Jac}}(\vec{\emptyset}, \llbracket 1, k \rrbracket, \bullet)$ there is a bijection

$$(5.10) \quad \text{Bij}_{\underline{D}} : \text{Set}_{\underline{D}} \longrightarrow \widetilde{\text{Set}}_{\underline{D}}$$

given by $\text{Bij}_{\underline{D}}(A, \sigma, \sigma') = (\tilde{\sigma}, \tilde{A})$, where $\tilde{\sigma} := \sigma \sqcup \sigma'$ and \tilde{A} is the image of A in $\pi_0(\langle \underline{D}, \mathring{\text{Jac}}(\tilde{\sigma}) \rangle)$ under the canonical map $\pi_0(\underline{D}) \rightarrow \pi_0(\langle \underline{D}, \mathring{\text{Jac}}(\tilde{\sigma}) \rangle)$.

Proof. Let $\underline{D} \in \mathring{\text{Jac}}(\vec{\emptyset}, \llbracket 1, k \rrbracket, \bullet)$. Let $f : \partial \underline{D}_f \rightarrow \pi_0(\underline{D})$ be the map taking $x \in \partial \underline{D}_f$ to the unique $C \in \pi_0(\underline{D})$ such that $x \in C$. Using the notation of Definition 5.13, one checks that $\text{Set}_{\underline{D}} = \text{Set}(f)$ and $\widetilde{\text{Set}}_{\underline{D}} = \widetilde{\text{Set}}(f)$ and the map Bij identifies with the map Φ in Lemma 5.14. The result then follows from this lemma. \square

Lemma 5.16. For any $\underline{D} \in \mathring{\text{Jac}}(\vec{\emptyset}, \llbracket 1, k \rrbracket, \bullet)$ the diagram

$$(5.11) \quad \begin{array}{ccc} \text{Set}_{\underline{D}} & \xrightarrow{(l_{\underline{D}}, r_{\underline{D}})} & \mathring{\text{Jac}}(\vec{\emptyset}, \llbracket 1, k \rrbracket) \times \mathring{\text{Jac}}(\vec{\emptyset}, \llbracket 1, k \rrbracket) \\ \text{Bij}_{\underline{D}} \downarrow & \nearrow & \\ \widetilde{\text{Set}}_{\underline{D}} & & \end{array} \quad \begin{array}{c} \\ \\ (\tilde{l}_{\underline{D}}, \tilde{r}_{\underline{D}}) \end{array}$$

commutes.

Proof. Let $\underline{D} = (D, \partial D_a, \partial D_f, \varphi) \in \mathring{\text{Jac}}(\vec{\emptyset}, \llbracket 1, k \rrbracket, \bullet)$. We show first that the diagram

$$(5.12) \quad \begin{array}{ccc} \text{Set}_{\underline{D}} & \xrightarrow{l_{\underline{D}}} & \mathring{\text{Jac}}(\vec{\emptyset}, \llbracket 1, k \rrbracket) \\ \text{Bij}_{\underline{D}} \downarrow & \nearrow & \\ \widetilde{\text{Set}}_{\underline{D}} & & \end{array} \quad \begin{array}{c} \\ \\ \tilde{l}_{\underline{D}} \end{array}$$

commutes. Indeed, let $(A, \sigma, \sigma') \in \text{Set}_{\underline{D}}$, $\tilde{\sigma} := \sigma \sqcup \sigma'$, $\tilde{A} := \text{Im}(A \subset \pi_0(\underline{D}) \rightarrow \pi_0(\langle \underline{D}, \mathring{\text{Jac}}(\tilde{\sigma}) \rangle))$ and $\tilde{\underline{D}} := \langle \underline{D}, \mathring{\text{Jac}}(\tilde{\sigma}) \rangle$. Then $\tilde{\underline{D}} = (\tilde{D}, \partial \tilde{D}_a = \partial D_a, \partial \tilde{D}_f = \emptyset, \tilde{\varphi} = \varphi)$,

$$\underline{D}_A = \left(\bigsqcup_{x \in A} x, (\partial D_a) \cap \bigsqcup_{x \in A} x, (\partial D_f) \cap \bigsqcup_{x \in A} x, \varphi|_{(\partial D_a) \cap \bigsqcup_{x \in A} x} \right)$$

and

$$l_{\underline{D}}(A, \sigma, \sigma') = \langle \underline{D}_A, \mathring{\text{Jac}}(\sigma) \rangle = \left(\bigsqcup_{z \in B} z, (\partial D_a) \cap \bigsqcup_{z \in B} z, \emptyset, \varphi|_{(\partial D_a) \cap \bigsqcup_{z \in B} z} \right),$$

where $B := \text{Im}(A \subset \pi_0(\underline{D}) \rightarrow \pi_0(\langle \underline{D}, \mathring{\text{Jac}}(\sigma) \rangle))$. Here

$$\langle \underline{D}, \mathring{\text{Jac}}(\sigma) \rangle \in \mathring{\text{Jac}}(\vec{\emptyset}, \llbracket 1, k \rrbracket, |(\partial \underline{D}_f) \cap \bigsqcup_{x \in \pi_0(\underline{D}) \setminus A} x|)$$

is the Jacobi diagram obtained from \underline{D} by identifying the univalent vertices in $(\partial D_f) \cap \bigsqcup_{x \in A} x$ according to σ . Since $\tilde{\sigma} = \sigma \sqcup \sigma'$, then $B = \tilde{A}$. We also have $(\partial D_a) \cap \bigsqcup_{z \in B} z = (\partial D_a) \cap \bigsqcup_{x \in A} x$. Therefore,

$$\begin{aligned} \tilde{l}_{\underline{D}} \circ \text{Bij}_{\underline{D}}(A, \sigma, \sigma') &= \tilde{l}_{\underline{D}}(\tilde{\sigma}, \tilde{A}) = \tilde{D}_{\tilde{A}} = \left(\bigsqcup_{z \in \tilde{A}} z, (\partial \tilde{D}_a) \cap \bigsqcup_{z \in \tilde{A}} z, (\partial \tilde{D}_f) \cap \bigsqcup_{z \in \tilde{A}} z, \tilde{\varphi}|_{\partial \tilde{D}_a \cap \bigsqcup_{z \in \tilde{A}} z} \right) \\ &= \left(\bigsqcup_{z \in B} z, (\partial D_a) \cap \bigsqcup_{z \in B} z, \emptyset, \varphi|_{(\partial D_a) \cap \bigsqcup_{z \in B} z} \right) = l_{\underline{D}}(A, \sigma, \sigma'). \end{aligned}$$

We show now the commutativity of the diagram

$$(5.13) \quad \begin{array}{ccc} \text{Set}_{\underline{D}} & \xrightarrow{r_{\underline{D}}} & \mathring{\text{Jac}}(\vec{\emptyset}, \llbracket 1, k \rrbracket) \\ \text{Bij}_{\underline{D}} \downarrow & \nearrow \tilde{r}_{\underline{D}} & \\ \widetilde{\text{Set}}_{\underline{D}} & & \end{array}$$

Consider the involutions

$$\text{aut}_{\underline{D}} : \text{Set}_{\underline{D}} \longrightarrow \text{Set}_{\underline{D}}, \quad (A, \sigma, \sigma') \longmapsto (\pi_0(\underline{D})) \setminus A, \sigma', \sigma)$$

and

$$\widetilde{\text{aut}}_{\underline{D}} : \widetilde{\text{Set}}_{\underline{D}} \longrightarrow \widetilde{\text{Set}}_{\underline{D}}, \quad (\tilde{\sigma}, \tilde{A}) \longmapsto (\tilde{\sigma}, \pi_0(\langle \underline{D}, \mathring{\text{Jac}}(\tilde{\sigma}) \rangle) \setminus \tilde{A}).$$

One checks that

$$(5.14) \quad r_{\underline{D}} = l_{\underline{D}} \circ \text{aut}_{\underline{D}} \quad \text{and} \quad \tilde{r}_{\underline{D}} = \tilde{l}_{\underline{D}} \circ \widetilde{\text{aut}}_{\underline{D}}.$$

Besides, using the notations in the proof of Lemma 5.15, the maps $\text{Bij}_{\underline{D}}$, $\text{aut}_{\underline{D}}$ and $\widetilde{\text{aut}}_{\underline{D}}$ are respectively identified with the maps Φ , a and \tilde{a} in Lemma 5.14. It then follows from Lemma 5.14(b) that the diagram

$$(5.15) \quad \begin{array}{ccc} \text{Set}_{\underline{D}} & \xrightarrow{\text{Bij}_{\underline{D}}} & \widetilde{\text{Set}}_{\underline{D}} \\ \text{aut}_{\underline{D}} \downarrow & & \downarrow \widetilde{\text{aut}}_{\underline{D}} \\ \text{Set}_{\underline{D}} & \xrightarrow{\text{Bij}_{\underline{D}}} & \widetilde{\text{Set}}_{\underline{D}} \end{array}$$

commutes.

Diagram (5.13) corresponds to the exterior triangle in the diagram

$$(5.16) \quad \begin{array}{ccccc} & & \text{Bij}_{\underline{D}} & & \\ & & \xrightarrow{\quad} & & \\ \text{Set}_{\underline{D}} & \xrightarrow{\text{Bij}_{\underline{D}}} & \widetilde{\text{Set}}_{\underline{D}} & & \\ \text{aut}_{\underline{D}} \searrow & & \downarrow \widetilde{\text{aut}}_{\underline{D}} & & \\ \text{Set}_{\underline{D}} & \xrightarrow{\text{Bij}_{\underline{D}}} & \widetilde{\text{Set}}_{\underline{D}} & & \\ \downarrow r_{\underline{D}} & & \downarrow \tilde{r}_{\underline{D}} & & \\ & & \mathring{\text{Jac}}(\vec{\emptyset}, \llbracket 1, k \rrbracket) & & \end{array}$$

The inner square and inner triangles commute because of (5.15), (5.12) and (5.14). We deduce then the commutativity of Diagram (5.13). This completes the proof. \square

Definition 5.17. Define the linear map

$$(5.17) \quad \text{Pair}_{(\vec{\emptyset}, \llbracket 1, k \rrbracket)} : \mathring{\text{CJac}}(\vec{\emptyset}, \llbracket 1, k \rrbracket, \bullet) \longrightarrow \mathring{\text{CJac}}(\vec{\emptyset}, \llbracket 1, k \rrbracket)$$

by

$$\text{Pair}_{(\vec{\emptyset}, [1, k])}(\underline{D}) := \sum_{\sigma \in \text{FPFI}(\partial \underline{D}_f)} \langle \underline{D}, \mathring{\text{Jac}}(\sigma) \rangle$$

for any $\underline{D} \in \mathring{\text{Jac}}(\vec{\emptyset}, [1, k], \bullet)$. (Recall that by definition an empty sum is equal to 0.)

Proposition 5.18. *The diagram*

$$(5.18) \quad \begin{array}{ccc} \mathring{\text{CJac}}(\vec{\emptyset}, [1, k], \bullet) & \xrightarrow{\text{Pair}_{(\vec{\emptyset}, [1, k])}} & \mathring{\text{CJac}}(\vec{\emptyset}, [1, k]) \\ \Delta_{\mathring{\text{Jac}}(\vec{\emptyset}, [1, k], \bullet)} \downarrow & & \downarrow \Delta_{\mathring{\text{Jac}}(\vec{\emptyset}, [1, k])} \\ \mathring{\text{CJac}}(\vec{\emptyset}, [1, k], \bullet) \otimes \mathring{\text{CJac}}(\vec{\emptyset}, [1, k], \bullet) & \xrightarrow{\text{Pair}_{(\vec{\emptyset}, [1, k])}^{\otimes 2}} & \mathring{\text{CJac}}(\vec{\emptyset}, [1, k]) \otimes \mathring{\text{CJac}}(\vec{\emptyset}, [1, k]) \end{array}$$

commutes.

Proof. Let $\underline{D} \in \mathring{\text{Jac}}(\vec{\emptyset}, [1, k], \bullet)$, then

$$\begin{aligned} \Delta_{\mathring{\text{Jac}}(\vec{\emptyset}, [1, k])} \circ \text{Pair}_{(\vec{\emptyset}, [1, k])}(\underline{D}) &= \Delta_{\mathring{\text{Jac}}(\vec{\emptyset}, [1, k])} \left(\sum_{\tilde{\sigma} \in \text{FPFI}(\partial \underline{D}_f)} \langle \underline{D}, \mathring{\text{Jac}}(\tilde{\sigma}) \rangle \right) \\ &= \sum_{(\tilde{\sigma}, \tilde{A}) \in \widetilde{\text{Set}}_{\underline{D}}} \langle \underline{D}, \mathring{\text{Jac}}(\tilde{\sigma}) \rangle_{\tilde{A}} \otimes \langle \underline{D}, \mathring{\text{Jac}}(\tilde{\sigma}) \rangle_{\pi_0(\langle \underline{D}, \mathring{\text{Jac}}(\tilde{\sigma}) \rangle) \setminus \tilde{A}} = \sum_{(\tilde{\sigma}, \tilde{A}) \in \widetilde{\text{Set}}_{\underline{D}}} \tilde{l}_{\underline{D}}(\tilde{\sigma}, \tilde{A}) \otimes \tilde{r}_{\underline{D}}(\tilde{\sigma}, \tilde{A}) \\ &= \sum_{(\tilde{\sigma}, \tilde{A}) \in \widetilde{\text{Set}}_{\underline{D}}} l_{\underline{D}} \circ \text{Bij}_{\underline{D}}^{-1}(\tilde{\sigma}, \tilde{A}) \otimes r_{\underline{D}} \circ \text{Bij}_{\underline{D}}^{-1}(\tilde{\sigma}, \tilde{A}) = \sum_{(A, \sigma, \sigma') \in \text{Set}_{\underline{D}}} l_{\underline{D}}(A, \sigma, \sigma') \otimes r_{\underline{D}}(A, \sigma, \sigma') \\ &= \sum_{(A, \sigma, \sigma') \in \text{Set}_{\underline{D}}} \langle \underline{D}_A, \mathring{\text{Jac}}(\sigma) \rangle \otimes \langle \underline{D}_{\pi_0(\underline{D}) \setminus A}, \mathring{\text{Jac}}(\sigma') \rangle = \text{Pair}_{(\vec{\emptyset}, [1, k])}^{\otimes 2} \circ \Delta_{\mathring{\text{Jac}}(\vec{\emptyset}, [1, k], \bullet)}(\underline{D}). \end{aligned}$$

We have used Lemma 5.15 in the fourth equality and Lemma 5.16 in the fifth equality. \square

5.2.2. *An algebra homomorphism $\Delta_{n,p}^{\mathfrak{b}} : \mathfrak{b}(n) \rightarrow \mathfrak{b}(p) \otimes \mathfrak{b}(n-p)$.* Recall from Lemma 4.31 the graded ideal $P^{n+1} = \bigoplus_{k \geq 0} P_k^{n+1}$ of $\bigoplus_{k \geq 0} \hat{\mathcal{A}}_k$.

Definition 5.19. Define the category of *finitely fibered set diagrams* $\text{Set}\mathcal{D}$ as follows. The objects are sets. For A, B two objects, $\text{Set}\mathcal{D}(A, B)$ is the collection of set diagrams $A \xleftarrow{f} X \xrightarrow{f'} B$, where the map $f : X \rightarrow A$ has finite fibers. For objects A, B and C , the composition $\text{Set}\mathcal{D}(A, B) \times \text{Set}\mathcal{D}(B, C) \rightarrow \text{Set}\mathcal{D}(A, C)$ takes the pair $(A \xleftarrow{f} X \xrightarrow{f'} B, B \xleftarrow{g} Y \xrightarrow{g'} C)$ to the diagram $A \xleftarrow{\hat{f}} X \times_B Y \xrightarrow{\hat{g}'} C$, where $X \times_B Y := \{(x, y) \in X \times Y \mid f'(x) = g(y)\}$ and $\hat{f} : X \times_B Y \rightarrow A$ (resp. $\hat{g}' : X \times_B Y \rightarrow C$) is the composition $X \times_B Y \rightarrow X \xrightarrow{f} A$ (resp. $X \times_B Y \rightarrow Y \xrightarrow{g'} C$) where the first map is the canonical projection.

Lemma 5.20. *Let Vect be the category of \mathbb{C} -vector spaces. There is a functor $F : \text{Set}\mathcal{D} \rightarrow \text{Vect}$ taking an object A in $\text{Set}\mathcal{D}$ to the free vector space $\mathbb{C}A$ with basis A , and taking a morphism $A \xleftarrow{f} X \xrightarrow{f'} B$ in $\text{Set}\mathcal{D}(A, B)$ to the linear map $\mathbb{C}A \rightarrow \mathbb{C}B$ given by $a \mapsto \sum_{x \in f^{-1}(a)} f'(x)$ for any $a \in A$.*

Proof. The proof is straightforward. \square

Lemma 5.21. *If $A, B \in \text{Set}\mathcal{D}$, if $A \xleftarrow{f} X \xrightarrow{f'} B$ is in $\text{Set}\mathcal{D}(A, B)$ and if $\varphi : Y \rightarrow X$ is a set morphism with finite fibers, then $A \xleftarrow{f \circ \varphi} Y \xrightarrow{f' \circ \varphi} B$ belongs to $\text{Set}\mathcal{D}(A, B)$. If moreover $c \in \mathbb{Z}_{\geq 0}$ is such that for all $x \in X$, $|\varphi^{-1}(x)| = c$, then $F(A \xleftarrow{f \circ \varphi} Y \xrightarrow{f' \circ \varphi} B) = cF(A \xleftarrow{f} X \xrightarrow{f'} B)$.*

Proof. Since both $f : X \rightarrow A$ and $\varphi : Y \rightarrow X$ have finite fibers, so does $f \circ \varphi : Y \rightarrow X$. This implies the first statement of the lemma. If $|\varphi^{-1}(x)| = c$ for all $x \in X$, then

$$\begin{aligned} F(A \xleftarrow{f \circ \varphi} Y \xrightarrow{f \circ \varphi} B)(a) &= \sum_{y \in (f \circ \varphi)^{-1}(a)} (f' \circ \varphi)(y) = \sum_{y \in \varphi^{-1}(f^{-1}(a))} f'(\varphi(y)) = c \sum_{x \in f^{-1}(a)} f'(x) \\ &= cF(A \xleftarrow{f} X \xrightarrow{f} B)(a) \end{aligned}$$

for any $a \in A$. This proves the second statement of the lemma. \square

We apply the previous lemmas for sets of Jacobi diagrams as follows. For a finite set S , we denote by $\mathcal{P}_2(S)$ the set of two-element subsets of S . Let $k, m \geq 0$. Consider the set diagram

$$(5.19) \quad \mathring{\text{Jac}}(\vec{\emptyset}, [1, k], 2(m+1)) \xleftarrow{f_m} X_{m,m+1} \xrightarrow{f'_m} \mathring{\text{Jac}}(\vec{\emptyset}, [1, k], 2m),$$

where

$$X_{m,m+1} := \{(\underline{D}, \alpha) \mid \underline{D} \in \mathring{\text{Jac}}(\vec{\emptyset}, [1, k], 2(m+1)), \alpha \in \mathcal{P}_2(\partial \underline{D}_f)\},$$

and $f_m : X_{m,m+1} \rightarrow \mathring{\text{Jac}}(\vec{\emptyset}, [1, k], 2(m+1))$ is the projection $(\underline{D}, \alpha) \mapsto \underline{D}$, while $f'_m : X_{m,m+1} \rightarrow \mathring{\text{Jac}}(\vec{\emptyset}, [1, k], 2m)$ is the map taking (\underline{D}, α) to \underline{D}_α , which is obtained from \underline{D} by connecting the pairs of endpoints of \underline{D} corresponding to α . For any $\underline{D} \in \mathring{\text{Jac}}(\vec{\emptyset}, [1, k], 2(m+1))$, the set $\mathcal{P}_2(\partial \underline{D}_f)$ is finite, therefore the set diagram (5.19) is a morphism in $\text{SetD}(\mathring{\text{Jac}}(\vec{\emptyset}, [1, k], 2(m+1)), \mathring{\text{Jac}}(\vec{\emptyset}, [1, k], 2m))$. Denote by Ψ_m the image of this morphism by the functor F from Lemma 5.20, which is a vector space morphism

$$\Psi_m : \mathbb{C}\mathring{\text{Jac}}(\vec{\emptyset}, [1, k], 2(m+1)) \longrightarrow \mathbb{C}\mathring{\text{Jac}}(\vec{\emptyset}, [1, k], 2m).$$

Let $\text{Pair}_{(\vec{\emptyset}, [1, k], m)} : \mathbb{C}\mathring{\text{Jac}}(\vec{\emptyset}, [1, k], m) \rightarrow \mathbb{C}\mathring{\text{Jac}}(\vec{\emptyset}, [1, k])$ denote the restriction of the map $\text{Pair}_{(\vec{\emptyset}, [1, k])}$ from Definition 5.17 to $\mathring{\text{Jac}}(\vec{\emptyset}, [1, k], m)$.

Lemma 5.22. *For any $k, m \geq 0$, one has $\text{Pair}_{(\vec{\emptyset}, [1, k], 2m)} \circ \Psi_m = \binom{2(m+1)}{2} \text{Pair}_{(\vec{\emptyset}, [1, k], 2(m+1))}$.*

Proof. One defines a morphism in $\text{SetD}(\mathring{\text{Jac}}(\vec{\emptyset}, [1, k], 2m), \mathring{\text{Jac}}(\vec{\emptyset}, [1, k]))$ by the set diagram

$$\mathring{\text{Jac}}(\vec{\emptyset}, [1, k], 2m) \xleftarrow{g_m} X_m \xrightarrow{g'_m} \mathring{\text{Jac}}(\vec{\emptyset}, [1, k]),$$

where $X_m := \{(\underline{D}, \sigma) \mid \underline{D} \in \mathring{\text{Jac}}(\vec{\emptyset}, [1, k], 2m) \text{ and } \sigma \in \text{FPFI}(\partial \underline{D}_f)\}$, the map

$$g_m : X_m \longrightarrow \mathring{\text{Jac}}(\vec{\emptyset}, [1, k], 2m)$$

is the projection $(\underline{D}, \sigma) \mapsto \underline{D}$ and the map $g'_m : X_m \rightarrow \mathring{\text{Jac}}(\vec{\emptyset}, [1, k])$ takes (\underline{D}, σ) to $\langle \underline{D}, \mathring{\text{Jac}}(\sigma) \rangle$, see (5.6).

It follows easily that

$$(5.20) \quad F(\mathring{\text{Jac}}(\vec{\emptyset}, [1, k], 2m) \xleftarrow{g_m} X_m \xrightarrow{g'_m} \mathring{\text{Jac}}(\vec{\emptyset}, [1, k])) = \text{Pair}_{(\vec{\emptyset}, [1, k], 2m)},$$

where F is the functor from Lemma 5.20. Using the functoriality of F we have

$$\begin{aligned} \text{Pair}_{(\vec{\emptyset}, [1, k], 2m)} \circ \Psi_m &= F(\mathring{\text{Jac}}(\vec{\emptyset}, [1, k], 2m) \xleftarrow{g_m} X_m \xrightarrow{g'_m} \mathring{\text{Jac}}(\vec{\emptyset}, [1, k])) \\ &\quad \circ F(\mathring{\text{Jac}}(\vec{\emptyset}, [1, k], 2(m+1)) \xleftarrow{f_m} X_{m,m+1} \xrightarrow{f'_m} \mathring{\text{Jac}}(\vec{\emptyset}, [1, k], 2m)) \\ &= F(\mathring{\text{Jac}}(\vec{\emptyset}, [1, k], 2(m+1)) \xleftarrow{f_m} X_{m,m+1} \times_{\mathring{\text{Jac}}(\vec{\emptyset}, [1, k], 2m)} X_m \xrightarrow{g'_m} \mathring{\text{Jac}}(\vec{\emptyset}, [1, k])). \end{aligned}$$

Notice that $X_{m,m+1} \times_{\mathring{\text{Jac}}(\vec{\emptyset}, [1, k], 2m)} X_m \rightarrow X_{m+1}$ consists of the tuples $((\underline{D}, \alpha), (\underline{E}, \sigma))$ with

$$\underline{D} \in \mathring{\text{Jac}}(\vec{\emptyset}, [1, k], 2(m+1)), \quad \alpha \in \mathcal{P}_2(\partial \underline{D}_f), \quad \underline{E} \in \mathring{\text{Jac}}(\vec{\emptyset}, [1, k], 2m) \quad \text{and} \quad \sigma \in \text{FPFI}(\partial \underline{E}_f)$$

such that $\underline{D}_\alpha = f'_m((\underline{D}, \alpha)) = g_m(\underline{E}, \sigma) = \underline{E}$. Define $\varphi_m : X_{m,m+1} \times_{\mathring{\text{Jac}}(\vec{\emptyset}, [1, k], 2m)} X_m \rightarrow X_{m+1}$ by

$$((\underline{D}, \alpha), (\underline{E}, \sigma)) \longmapsto (\underline{D}, \sigma \sqcup \alpha).$$

We see at once that for any $x \in X_{m+1}$, we have $|\varphi^{-1}(x)| = \binom{2(m+1)}{2}$. Besides, for any $((\underline{D}, \alpha), (\underline{E}, \sigma)) \in X_{m,m+1} \times \mathring{\text{Jac}}(\vec{\varnothing}, \llbracket 1, k \rrbracket, 2m) X_m$ we have

$$g_{m+1} \circ \varphi_m((\underline{D}, \alpha), (\underline{E}, \sigma)) = g_{m+1}(\underline{D}, \sigma \sqcup \alpha) = \underline{D} = f_m(\underline{D}, \alpha) = \hat{f}_m((\underline{D}, \alpha), (\underline{E}, \sigma))$$

and

$$\begin{aligned} g'_{m+1} \circ \varphi_m((\underline{D}, \alpha), (\underline{E}, \sigma)) &= g'_{m+1}(\underline{D}, \sigma \sqcup \alpha) = \langle \underline{D}, \mathring{\text{Jac}}(\sigma \sqcup \alpha) \rangle = \langle \underline{D}_\alpha, \mathring{\text{Jac}}(\sigma) \rangle = \langle \underline{E}, \mathring{\text{Jac}}(\sigma) \rangle \\ &= g'_m(\underline{E}, \sigma) = \hat{g}'_m((\underline{D}, \alpha), (\underline{E}, \sigma)), \end{aligned}$$

that is, $g_{m+1} \circ \varphi_m = \hat{f}_m$ and $g'_{m+1} \circ \varphi_m = \hat{g}'_m$. Therefore, using Lemma 5.21, we obtain

$$\begin{aligned} F(\mathring{\text{Jac}}(\vec{\varnothing}, \llbracket 1, k \rrbracket, 2(m+1))) &\xleftarrow{\hat{f}_m} X_{m,m+1} \times_{\mathring{\text{Jac}}(\vec{\varnothing}, \llbracket 1, k \rrbracket, 2m)} X_{2m} \xrightarrow{\hat{g}'_m} \mathring{\text{Jac}}(\vec{\varnothing}, \llbracket 1, k \rrbracket) \\ &= F(\mathring{\text{Jac}}(\vec{\varnothing}, \llbracket 1, k \rrbracket, 2(m+1))) \xleftarrow{g_{m+1} \circ \varphi_m} X_{m,m+1} \times_{\mathring{\text{Jac}}(\vec{\varnothing}, \llbracket 1, k \rrbracket, 2m)} X_{2m} \xrightarrow{g'_{m+1} \circ \varphi_m} \mathring{\text{Jac}}(\vec{\varnothing}, \llbracket 1, k \rrbracket) \\ &= \binom{2(m+1)}{2} F(\mathring{\text{Jac}}(\vec{\varnothing}, \llbracket 1, k \rrbracket, 2(m+1))) \xleftarrow{g_{m+1}} X_{m+1} \xrightarrow{g'_{m+1}} \mathring{\text{Jac}}(\vec{\varnothing}, \llbracket 1, k \rrbracket) \\ &= \binom{2(m+1)}{2} \text{Pair}_{(\vec{\varnothing}, \llbracket 1, k \rrbracket, 2(m+1))}. \end{aligned}$$

This finishes the proof. \square

Corollary 5.23. *For all $k \geq 0$ and $m \geq 2$ we have $P_k^{m+1} \subset P_k^m$ and therefore $P_{m+1} \subset P_m$.*

Proof. Let $k \geq 0$. Let $[\] : \mathbb{C}\mathring{\text{Jac}}(\vec{\varnothing}, \llbracket 1, k \rrbracket) \rightarrow \hat{\mathcal{A}}_k^\wedge$ be the canonical projection. From the definition of $\text{Pair}_{(\vec{\varnothing}, \llbracket 1, k \rrbracket)}$ (see Definition 5.17) we have

$$(5.21) \quad P_k^m = [\text{Pair}_{(\vec{\varnothing}, \llbracket 1, k \rrbracket, 2m)}(\mathbb{C}\mathring{\text{Jac}}(\vec{\varnothing}, \llbracket 1, k \rrbracket, 2m))].$$

Using (5.21) and Lemma 5.22 we obtain $P_k^{m+1} \subset P_k^m$. The sum of these inclusions over $k \geq 0$ then gives $P^{m+1} \subset P^m$. \square

Proposition 5.24. *One has*

$$\Delta_{\mathcal{A}}(P^{n+1}) \subset P^{p+1} \otimes \mathcal{A} + \mathcal{A} \otimes P^{n-p+1},$$

where by simplicity of notation we set $\mathcal{A} := \bigoplus_{k \geq 0} \hat{\mathcal{A}}_k^\wedge$ and $P^{n+1} = \bigoplus_{k \geq 0} P_k^{n+1}$ is the graded ideal of \mathcal{A} from Lemma 4.31.

Proof. Let $k \geq 0$. Recall that the coproducts $\Delta_{\mathring{\text{Jac}}(\vec{\varnothing}, \llbracket 1, k \rrbracket, 0)}$ (from (5.5)) and $\Delta_{\mathring{\text{Jac}}(\vec{\varnothing}, \llbracket 1, k \rrbracket)}$ (from Definition 5.1(b)) coincide. Besides,

$$(5.22) \quad P_k^{n+1} = [\text{Pair}_{(\vec{\varnothing}, \llbracket 1, k \rrbracket)}(\mathbb{C}\mathring{\text{Jac}}(\vec{\varnothing}, \llbracket 1, k \rrbracket, 2(n+1)))],$$

where $[\] : \mathbb{C}\mathring{\text{Jac}}(\vec{\varnothing}, \llbracket 1, k \rrbracket) \rightarrow \hat{\mathcal{A}}_k^\wedge$ is the canonical projection.

Let $m \geq 0$, by Lemma 5.11, we have the inclusion

$$\Delta_{\mathring{\text{Jac}}(\vec{\varnothing}, \llbracket 1, k \rrbracket, \bullet)}(\mathbb{C}\mathring{\text{Jac}}(\vec{\varnothing}, \llbracket 1, k \rrbracket, m)) \subset \bigoplus_{0 \leq q \leq m} \mathbb{C}\mathring{\text{Jac}}(\vec{\varnothing}, \llbracket 1, k \rrbracket, q) \otimes \mathbb{C}\mathring{\text{Jac}}(\vec{\varnothing}, \llbracket 1, k \rrbracket, m-q).$$

By the commutativity of Diagram (5.18) we then have

$$\begin{aligned} &\Delta_{\mathring{\text{Jac}}(\vec{\varnothing}, \llbracket 1, k \rrbracket)}(\text{Pair}_{(\vec{\varnothing}, \llbracket 1, k \rrbracket)}(\mathbb{C}\mathring{\text{Jac}}(\vec{\varnothing}, \llbracket 1, k \rrbracket, m))) \\ &\subset \sum_{0 \leq q \leq m} \text{Pair}_{(\vec{\varnothing}, \llbracket 1, k \rrbracket)}(\mathbb{C}\mathring{\text{Jac}}(\vec{\varnothing}, \llbracket 1, k \rrbracket, q)) \otimes \text{Pair}_{(\vec{\varnothing}, \llbracket 1, k \rrbracket)}(\mathbb{C}\mathring{\text{Jac}}(\vec{\varnothing}, \llbracket 1, k \rrbracket, m-q)). \end{aligned}$$

The compatibility of the map $\Delta_{\mathring{\mathcal{A}}_k^\wedge}$, the map $\Delta_{\mathring{\text{Jac}}(\vec{\partial}, [1, k])}$ and the projection $[\] : \mathbb{C}\mathring{\text{Jac}}(\vec{\partial}, [1, k]) \rightarrow \mathring{\mathcal{A}}_k^\wedge$ imply

$$\begin{aligned} & \Delta_{\mathring{\mathcal{A}}_k^\wedge}([\text{Pair}_{(\vec{\partial}, [1, k])}(\mathbb{C}\mathring{\text{Jac}}(\vec{\partial}, [1, k], m))]) \\ & \subset \sum_{0 \leq q \leq m} [\text{Pair}_{(\vec{\partial}, [1, k])}(\mathbb{C}\mathring{\text{Jac}}(\vec{\partial}, [1, k], q))] \otimes [\text{Pair}_{(\vec{\partial}, [1, k])}(\mathbb{C}\mathring{\text{Jac}}(\vec{\partial}, [1, k], m - q))]. \end{aligned}$$

Specializing this inclusion for $m = 2(n + 1)$, using (5.22) and $[\text{Pair}_{(\vec{\partial}, [1, k])}(\mathbb{C}\mathring{\text{Jac}}(\vec{\partial}, [1, k], u))] = 0$ for u odd, one then obtains

$$\begin{aligned} \Delta_{\mathring{\mathcal{A}}_k^\wedge}(P_k^{n+1}) & \subset \sum_{2 \leq q \leq n-1} P_k^q \otimes P_k^{n+1-q} \\ & = P_k^2 \otimes P_k^{n-1} + \dots + P_k^p \otimes P_k^{n+1-p} + P_k^{p+1} \otimes P_k^{n-p} + \dots + P_k^{n-1} \otimes P_k^2. \end{aligned}$$

Besides, by Corollary 5.23, we have $P_k^{q+1} \subset P_k^q$ for any $q \geq 2$. We thus get

$$(5.23) \quad \Delta_{\mathring{\mathcal{A}}_k^\wedge}(P_k^{n+1}) \subset \mathring{\mathcal{A}}_k^\wedge \otimes P_k^{n+1-p} + P_k^{p+1} \otimes \mathring{\mathcal{A}}_k^\wedge.$$

The sum of these inclusions over $k \geq 0$ then implies

$$\Delta_{\mathcal{A}}(P^{n+1}) \subset P^{p+1} \otimes \mathcal{A} + \mathcal{A} \otimes P^{n-p+1}$$

which finishes the proof. \square

Proposition 5.25. *The coproduct of the algebra $\bigoplus_{k \geq 0} \mathring{\mathcal{A}}_k^\wedge$ induces a morphism of algebras*

$$\Delta_{n,p}^{\mathfrak{b}} : \mathfrak{b}(n) \rightarrow \mathfrak{b}(p) \otimes \mathfrak{b}(n-p).$$

Proof. Set $J(n) := L^{<2n} + P^{n+1} + (\text{CO}\mathring{\mathcal{A}}^\wedge) \subset \bigoplus_{k \geq 0} \mathring{\mathcal{A}}_k^\wedge$, then $J(n)$ is an ideal of $\bigoplus_{k \geq 0} \mathring{\mathcal{A}}_k^\wedge$ and $\mathfrak{b}(n)$ is the corresponding quotient. The statement then follows from the inclusion

$$\Delta_{\bigoplus_{k \geq 0} \mathring{\mathcal{A}}_k^\wedge}(J(n)) \subset J(p) \otimes \left(\bigoplus_{k \geq 0} \mathring{\mathcal{A}}_k^\wedge \right) + \left(\bigoplus_{k \geq 0} \mathring{\mathcal{A}}_k^\wedge \right) \otimes J(n-p).$$

This follows from the following inclusions

- (a) $\Delta_{\bigoplus_{k \geq 0} \mathring{\mathcal{A}}_k^\wedge}(P^{n+1}) \subset P^{p+1} \otimes \left(\bigoplus_{k \geq 0} \mathring{\mathcal{A}}_k^\wedge \right) + \left(\bigoplus_{k \geq 0} \mathring{\mathcal{A}}_k^\wedge \right) \otimes P^{n-p+1}$,
- (b) $\Delta_{\bigoplus_{k \geq 0} \mathring{\mathcal{A}}_k^\wedge}(L^{<2n}) \subset L^{<2p} \otimes \left(\bigoplus_{k \geq 0} \mathring{\mathcal{A}}_k^\wedge \right) + \left(\bigoplus_{k \geq 0} \mathring{\mathcal{A}}_k^\wedge \right) \otimes L^{<2(n-p)}$,
- (c) $\Delta_{\bigoplus_{k \geq 0} \mathring{\mathcal{A}}_k^\wedge}((\text{CO}\mathring{\mathcal{A}}^\wedge)) \subset (\text{CO}\mathring{\mathcal{A}}^\wedge) \otimes \left(\bigoplus_{k \geq 0} \mathring{\mathcal{A}}_k^\wedge \right) + \left(\bigoplus_{k \geq 0} \mathring{\mathcal{A}}_k^\wedge \right) \otimes (\text{CO}\mathring{\mathcal{A}}^\wedge)$.

The inclusion in (a) is given by Proposition 5.24. We now prove (b) and (c).

Recall from Definition 4.28 that $L^{<2n} = \bigoplus_{k \geq 0} L_k^{<2n}$ where $L_k^{<2n}$ is as in (4.28). Define

$$\mathring{\text{Jac}}^{<2n}(\vec{\partial}, [1, k]) := \{\underline{D} \in \mathring{\text{Jac}}(\vec{\partial}, [1, k]) \mid \text{there exists } a \in [1, k] \text{ with } m_a(\underline{D}) < 2n\},$$

where $m_a : \mathring{\text{Jac}}(\vec{\partial}, [1, k]) \rightarrow \mathbb{Z}_{\geq 0}$ is the map from Definition 3.9. Let $[\] : \mathbb{C}\mathring{\text{Jac}}(\vec{\partial}, [1, k]) \rightarrow \mathring{\mathcal{A}}_k^\wedge$ be the canonical projection. Then

$$(5.24) \quad L_k^{<2n} = [\mathbb{C}\mathring{\text{Jac}}^{<2n}(\vec{\partial}, [1, k])]^\wedge,$$

where $[\mathbb{C}\mathring{\text{Jac}}^{<2n}(\vec{\partial}, [1, k])]^\wedge$ is the complete graded subspace of $\mathring{\mathcal{A}}_k^\wedge$ generated by $[\mathbb{C}\mathring{\text{Jac}}^{<2n}(\vec{\partial}, [1, k])]$.

If $\underline{D} \in \mathring{\text{Jac}}^{<2n}(\vec{\partial}, [1, k])$ and $A \subset \pi_0(\underline{D})$, there exists $a \in [1, k]$ such that $m_a(\underline{D}) < 2n$. Then $m_a(\underline{D}_A) + m_a(\underline{D}_{\pi_0(\underline{D}) \setminus A}) = m_a(\underline{D}) < 2n$. Let now $p \in [1, n-1]$. Then either $m_a(\underline{D}_A) < 2p$ which implies

$\underline{D}_A \otimes \underline{D}_{\pi_0(\underline{D}) \setminus A} \in \mathbb{C}\mathring{\text{Jac}}^{<2p}(\vec{\emptyset}, [1, k]) \otimes \mathbb{C}\mathring{\text{Jac}}(\vec{\emptyset}, [1, k])$, or $m_a(\underline{D}_A) \geq 2p$ which implies $m_a(\underline{D}_{\pi_0(\underline{D}) \setminus A}) < 2(n-p)$. Therefore $\underline{D}_A \otimes \underline{D}_{\pi_0(\underline{D}) \setminus A} \in \mathbb{C}\mathring{\text{Jac}}(\vec{\emptyset}, [1, k]) \otimes \mathbb{C}\mathring{\text{Jac}}^{<2(n-p)}(\vec{\emptyset}, [1, k])$. It follows that

$$(5.25) \quad \begin{aligned} & \Delta_{\mathbb{C}\mathring{\text{Jac}}(\vec{\emptyset}, [1, k])}(\mathring{\text{Jac}}^{<2n}(\vec{\emptyset}, [1, k])) \\ & \subset \mathbb{C}\mathring{\text{Jac}}^{<2p}(\vec{\emptyset}, [1, k]) \otimes \mathbb{C}\mathring{\text{Jac}}(\vec{\emptyset}, [1, k]) + \mathbb{C}\mathring{\text{Jac}}(\vec{\emptyset}, [1, k]) \otimes \mathbb{C}\mathring{\text{Jac}}^{<2(n-p)}(\vec{\emptyset}, [1, k]). \end{aligned}$$

Then one has

$$\begin{aligned} \Delta_{\mathring{\mathcal{A}}_k}(L_k^{<2n}) &= \Delta_{\mathring{\mathcal{A}}_k}([\mathbb{C}\mathring{\text{Jac}}^{<2n}(\vec{\emptyset}, [1, k])]^\wedge) = ([]^\wedge \otimes []^\wedge) \circ \Delta_{\mathring{\text{Jac}}(\vec{\emptyset}, [1, k])}(\mathbb{C}\mathring{\text{Jac}}^{<2n}(\vec{\emptyset}, [1, k])) \\ &\subset ([]^\wedge \otimes []^\wedge)(\mathbb{C}\mathring{\text{Jac}}^{<2p}(\vec{\emptyset}, [1, k]) \otimes \mathbb{C}\mathring{\text{Jac}}(\vec{\emptyset}, [1, k]) + \mathbb{C}\mathring{\text{Jac}}(\vec{\emptyset}, [1, k]) \otimes \mathbb{C}\mathring{\text{Jac}}^{<2(n-p)}(\vec{\emptyset}, [1, k])) \\ &= L_k^{<2p} \otimes \mathring{\mathcal{A}}_k + \mathring{\mathcal{A}}_k \otimes L_k^{<2(n-p)}, \end{aligned}$$

where the first and last equality follows from (5.24), the second equality follows from the fact that $[] : \mathbb{C}\mathring{\text{Jac}}(\vec{\emptyset}, [1, k]) \rightarrow \mathring{\mathcal{A}}_k$ is a coalgebra morphism and the inclusion follows from (5.25). Therefore, we have

$$\Delta_{\mathring{\mathcal{A}}_k}(L_k^{<2n}) \subset L_k^{<2p} \otimes \mathring{\mathcal{A}}_k + \mathring{\mathcal{A}}_k \otimes L_k^{<2(n-p)}$$

for any $k \geq 0$, which by taking the direct sum over $k \geq 0$ implies the inclusion in (b).

We proceed to show (c). Recall from §4.2.1 that $(\text{CO}\mathring{\mathcal{A}}^\wedge) = \bigoplus_{k \geq 1} (\text{CO}\mathring{\mathcal{A}}_k^\wedge) \subset \bigoplus_{k \geq 0} \mathring{\mathcal{A}}_k^\wedge$ and $(\text{CO}\mathring{\mathcal{A}}_k^\wedge)$ is topologically spanned by elements of the form $\text{co}_k^A([\underline{D}]) - \text{proj}_{1, k-1}^A([\underline{D}])$ where

$$\underline{D} = (D, \varphi : \partial D \rightarrow [1, k], \{\text{cyc}_i\}_{i \in [1, k]}) \in \mathring{\text{Jac}}(\vec{\emptyset}, [1, k]).$$

By definition $\text{co}_k^A([\underline{D}]) = (-1)^{|\varphi^{-1}(1)|} [(D, \varphi, \{\text{cyc}_i\}_{i \in [2, k]} \sqcup \{\overline{\text{cyc}}_1\})]$, where $\overline{\text{cyc}}_1$ denotes the opposite cyclic order of cyc_1 on the set $\varphi^{-1}(1) \subset \partial D$. Set

$$(5.26) \quad \underline{D}' := (D, \varphi, \{\text{cyc}_i\}_{i \in [2, k]} \sqcup \{\overline{\text{cyc}}_1\}),$$

clearly $\pi_0(\underline{D}) = \pi_0(\underline{D}')$.

For each $A \subset \pi_0(\underline{D})$ we have

$$|\varphi^{-1}(1)| = |(\varphi|_{(\partial D) \cap \sqcup_{x \in A} x})^{-1}(1)| + |(\varphi|_{(\partial D) \cap \sqcup_{x \in \pi_0(\underline{D}) \setminus A} x})^{-1}(1)|.$$

Consequently,

$$\begin{aligned} & \Delta_{\mathring{\text{Jac}}(\vec{\emptyset}, [1, k])}((-1)^{|\varphi^{-1}(1)|} \underline{D}') \\ &= \sum_{A \subset \pi_0(\underline{D}')} \left((-1)^{|\varphi|_{(\partial D') \cap \sqcup_{x \in A} x})^{-1}(1)|} \underline{D}'_A \right) \otimes \left((-1)^{|\varphi|_{(\partial D') \cap \sqcup_{x \in \pi_0(\underline{D}') \setminus A} x})^{-1}(1)|} \underline{D}'_{\pi_0(\underline{D}') \setminus A} \right). \end{aligned}$$

where \underline{D}'_A and $\underline{D}'_{\pi_0(\underline{D}') \setminus A}$ are as in Definition 5.1.

According to the above and to the fact that $[] : \mathbb{C}\mathring{\text{Jac}}(\vec{\emptyset}, [1, k]) \rightarrow \mathring{\mathcal{A}}_k^\wedge$ is a coalgebra morphism we then obtain

$$\Delta_{\mathring{\mathcal{A}}_k^\wedge}(\text{co}_k^A([\underline{D}])) = \sum_{A \subset \pi_0(\underline{D})} \left(\text{co}_k^A([\underline{D}_A]) \right) \otimes \left(\text{co}_k^A([\underline{D}_{\pi_0(\underline{D}) \setminus A}]) \right).$$

Therefore,

$$\begin{aligned} & \Delta_{\mathring{\mathcal{A}}_k^\wedge} \left(\text{proj}_{1, k-1}^A([\underline{D}]) - \text{co}_k^A([\underline{D}]) \right) = \sum_{A \subset \pi_0(\underline{D})} [\underline{D}_A] \otimes [\underline{D}_{\pi_0(\underline{D}) \setminus A}] - \text{co}_k^A([\underline{D}_A]) \otimes [\underline{D}_{\pi_0(\underline{D}) \setminus A}] \\ & \quad + \text{co}_k^A([\underline{D}_A]) \otimes [\underline{D}_{\pi_0(\underline{D}) \setminus A}] - \text{co}_k^A([\underline{D}_A]) \otimes \text{co}_k^A([\underline{D}_{\pi_0(\underline{D}) \setminus A}]) \\ &= \sum_{A \subset \pi_0(\underline{D})} \left([\underline{D}_A] - \text{co}_k^A([\underline{D}_A]) \right) \otimes [\underline{D}_{\pi_0(\underline{D}) \setminus A}] + \sum_{A \subset \pi_0(\underline{D})} \text{co}_k^A([\underline{D}_A]) \otimes \left([\underline{D}_{\pi_0(\underline{D}) \setminus A}] - \text{co}_k^A([\underline{D}_{\pi_0(\underline{D}) \setminus A}]) \right) \\ & \quad \in (\text{CO}\mathring{\mathcal{A}}_k^\wedge) \otimes \mathring{\mathcal{A}}_k^\wedge + \mathring{\mathcal{A}}_k^\wedge \otimes (\text{CO}\mathring{\mathcal{A}}_k^\wedge). \end{aligned}$$

Hence,

$$\Delta_{\mathring{\mathcal{A}}_k^\wedge}((\text{CO}\mathring{\mathcal{A}}_k^\wedge)) \subset (\text{CO}\mathring{\mathcal{A}}_k^\wedge) \otimes \mathring{\mathcal{A}}_k^\wedge + \mathring{\mathcal{A}}_k^\wedge \otimes (\text{CO}\mathring{\mathcal{A}}_k^\wedge)$$

for any $k \geq 1$, which by taking the direct sum over $k \geq 1$ yields the inclusion in (c). \square

5.2.3. *The algebra homomorphism $\Delta_{n,p}^b : \mathfrak{b}(n) \rightarrow \mathfrak{b}(p) \otimes \mathfrak{b}(n-p)$ as a morphism of semi-Kirby structures.*

Proposition 5.26. *The map $\Delta_{n,p}^b : \mathfrak{b}(n) \rightarrow \mathfrak{b}(p) \otimes \mathfrak{b}(n-p)$ from Proposition 5.25 is a morphism of semi-Kirby structures.*

Proof. It follows from the fact that the map $Z_{\mathcal{A}}$ sends each element of $\vec{\mathcal{T}}(\emptyset, \emptyset)_k$ to a group-like element of $\mathring{\mathcal{A}}_k^\wedge$, see Lemma 5.2; from Proposition 5.5, and from the compatibility of $\Delta_{n,p}^b$ with $\Delta_{\oplus_{k \geq 0} \mathring{\mathcal{A}}_k^\wedge}$ (see Proposition 5.25) that we have a commutative the diagram

$$(5.27) \quad \begin{array}{ccc} \mathfrak{Kir} & \xrightarrow{\varphi_{n \circ \text{cs}^\nu \circ Z_{\mathcal{A}}} } & \mathfrak{b}(n) \\ \Delta_{\mathfrak{Kir}} \downarrow & & \downarrow \Delta_{n,p}^b \\ \mathfrak{Kir} \otimes \mathfrak{Kir} & \xrightarrow{(\varphi_p \circ \text{cs}^\nu \circ Z_{\mathcal{A}}) \otimes (\varphi_{n-p} \circ \text{cs}^\nu \circ Z_{\mathcal{A}})} & \mathfrak{b}(p) \otimes \mathfrak{b}(n-p). \end{array}$$

The facts that

- (a) the semi-Kirby structure on on the algebra $\mathfrak{b}(p) \otimes \mathfrak{b}(n-p)$ is given by the composed algebra homomorphism

$$\mathfrak{Kir} \xrightarrow{\Delta_{\mathfrak{Kir}}} \mathfrak{Kir} \otimes \mathfrak{Kir} \xrightarrow{(\varphi_p \circ \text{cs}^\nu \circ Z_{\mathcal{A}}) \otimes (\varphi_{n-p} \circ \text{cs}^\nu \circ Z_{\mathcal{A}})} \mathfrak{b}(p) \otimes \mathfrak{b}(n-p)$$

which follows from Lemma 2.87,

- (b) $\Delta_{n,p}^b$ is an algebra homomorphism (Proposition 5.25),
(c) the diagram (5.27) is commutative,

imply that $\Delta_{n,p}^b$ is a morphism of semi-Kirby structures. \square

5.3. **A Kirby structure morphism $\Delta_{n,p}^c : \mathfrak{c}(n) \rightarrow \mathfrak{c}(p) \otimes \mathfrak{c}(n-p)$.**

5.3.1. *An algebra homomorphism $\Delta_{n,p}^c : \mathfrak{c}(n) \rightarrow \mathfrak{c}(p) \otimes \mathfrak{c}(n-p)$.* Recall that $\mathfrak{c}(n) = \mathring{\mathcal{A}}_0^\wedge / (P_0^{n+1} + O^n)$, see Definition 4.57. Specializing the map (5.1) to $k = 0$ and restricting the map (5.2) to $k = 0$, we obtain maps

$$(5.28) \quad \Delta_{\mathring{\text{Jac}}(\vec{\emptyset}, \emptyset)} : \mathbb{C}\mathring{\text{Jac}}(\vec{\emptyset}, \emptyset) \longrightarrow \mathbb{C}\mathring{\text{Jac}}(\vec{\emptyset}, \emptyset) \otimes \mathbb{C}\mathring{\text{Jac}}(\vec{\emptyset}, \emptyset)$$

and

$$(5.29) \quad \Delta_{\mathring{\mathcal{A}}_0^\wedge} : \mathring{\mathcal{A}}_0^\wedge \longrightarrow \mathring{\mathcal{A}}_0^\wedge \otimes \mathring{\mathcal{A}}_0^\wedge.$$

These maps endow $\mathbb{C}\mathring{\text{Jac}}(\vec{\emptyset}, \emptyset)$ and $\mathring{\mathcal{A}}_0^\wedge$ with cocommutative coassociative coalgebra structures such that the projection $[\] : \mathbb{C}\mathring{\text{Jac}}(\vec{\emptyset}, \emptyset) \rightarrow \mathring{\mathcal{A}}_0^\wedge$ is a coalgebra morphism. The triple $(\mathring{\mathcal{A}}_0^\wedge, \otimes, \Delta_{\mathring{\mathcal{A}}_0^\wedge})$ is a bialgebra as it is both a subalgebra and a subcoalgebra of the bialgebra from Proposition 5.4. Besides, equation (5.23) (restricted to $k = 0$) implies that

$$(5.30) \quad \Delta_{\mathring{\mathcal{A}}_0^\wedge}(P_0^{n+1}) \subset P_0^{p+1} \otimes \mathring{\mathcal{A}}_0^\wedge + \mathring{\mathcal{A}}_0^\wedge \otimes P_0^{n-p+1}$$

for any $1 \leq p \leq n$.

Proposition 5.27. *The coproduct (5.29) of the algebra $\mathring{\mathcal{A}}_0^\wedge$ induces a morphism of algebras*

$$\Delta_{n,p}^c : \mathfrak{c}(n) \longrightarrow \mathfrak{c}(p) \otimes \mathfrak{c}(n-p).$$

Proof. The result follows from the following inclusions

- (a) $\Delta_{\mathring{A}_0^\wedge}(P_0^{n+1}) \subset P_0^{p+1} \otimes \mathring{A}_0^\wedge + \mathring{A}_0^\wedge \otimes P_0^{n-p+1}$,
- (b) $\Delta_{\mathring{A}_0^\wedge}(O^n) \subset O^p \otimes \mathring{A}_0^\wedge + \mathring{A}_0^\wedge \otimes O^{n-p}$.

The inclusion in (a) is given by (5.30). Let us show the inclusion in (b). Recall that O^n is the closed ideal of \mathring{A}_0^\wedge generated by $X + 2n$ where X denotes the dashed loop, see Definition 4.56. We have

$$\Delta_{\mathring{A}_0^\wedge}(X + 2n) = X \otimes \emptyset + \emptyset \otimes X + 2n = (X + 2p) \otimes \emptyset + \emptyset \otimes (X + 2(n-p)) \in O^p \otimes \mathring{A}_0^\wedge + \mathring{A}_0^\wedge \otimes O^{n-p},$$

which implies the inclusion in (b). \square

5.3.2. *The algebra homomorphism $\mathfrak{c}(n) \rightarrow \mathfrak{c}(p) \otimes \mathfrak{c}(n-p)$ as a morphism of Kirby structures.* By Theorem 4.67, for every integer $n \geq 1$, the pair $(\mathfrak{c}(n), \bar{j}_n \circ \varphi_n \circ \text{cs}^\nu \circ Z_A)$ is a Kirby structure (see Proposition 4.59). By Lemma 2.86, for all integers $n, p \geq 1$ with $n-p \geq 1$, the algebra $\mathfrak{c}(p) \otimes \mathfrak{c}(n-p)$ is endowed canonically with the semi-Kirby structure given by the composed algebra homomorphism

$$\mathfrak{Kir} \xrightarrow{\Delta_{\mathfrak{Kir}}} \mathfrak{Kir} \otimes \mathfrak{Kir} \xrightarrow{(\bar{j}_p \circ \varphi_p \circ \text{cs}^\nu \circ Z_A) \otimes (\bar{j}_{n-p} \circ \varphi_{n-p} \circ \text{cs}^\nu \circ Z_A)} \mathfrak{c}(p) \otimes \mathfrak{c}(n-p)$$

and therefore $\mathfrak{c}(p) \otimes \mathfrak{c}(n-p)$ is endowed with a Kirby structure.

Proposition 5.28. *The algebra morphism $\Delta_{n,p}^{\mathfrak{c}} : \mathfrak{c}(n) \rightarrow \mathfrak{c}(p) \otimes \mathfrak{c}(n-p)$ from Proposition 5.27 defines a morphism of Kirby structures*

$$\Delta_{n,p}^{\mathfrak{c}} : (\mathfrak{c}(n), \bar{j}_n \circ \varphi_n \circ \text{cs}^\nu \circ Z_A) \longrightarrow (\mathfrak{c}(p), \bar{j}_p \circ \varphi_p \circ \text{cs}^\nu \circ Z_A) \otimes (\mathfrak{c}(n-p), \bar{j}_{n-p} \circ \varphi_{n-p} \circ \text{cs}^\nu \circ Z_A).$$

Proof. We need to show that the diagram

$$(5.31) \quad \begin{array}{ccc} \mathfrak{Kir} & \xrightarrow{\bar{j}_n \circ \varphi_n \circ \text{cs}^\nu \circ Z_A} & \mathfrak{c}(n) \\ \Delta_{\mathfrak{Kir}} \downarrow & & \downarrow \Delta_{n,p}^{\mathfrak{c}} \\ \mathfrak{Kir} \otimes \mathfrak{Kir} & \xrightarrow{(\bar{j}_p \circ \varphi_p \circ \text{cs}^\nu \circ Z_A) \otimes (\bar{j}_{n-p} \circ \varphi_{n-p} \circ \text{cs}^\nu \circ Z_A)} & \mathfrak{c}(p) \otimes \mathfrak{c}(n-p) \end{array}$$

commutes. This diagram decomposes as

$$\begin{array}{ccccc} \mathfrak{Kir} & \xrightarrow{\varphi_n \circ \text{cs}^\nu \circ Z_A} & \mathfrak{b}(n) & \xrightarrow{\bar{j}_n} & \mathfrak{c}(n) \\ \Delta_{\mathfrak{Kir}} \downarrow & & \downarrow \Delta_{n,p}^{\mathfrak{b}} & & \downarrow \Delta_{n,p}^{\mathfrak{c}} \\ \mathfrak{Kir} \otimes \mathfrak{Kir} & \xrightarrow{(\varphi_p \circ \text{cs}^\nu \circ Z_A) \otimes (\varphi_{n-p} \circ \text{cs}^\nu \circ Z_A)} & \mathfrak{b}(p) \otimes \mathfrak{b}(n-p) & \xrightarrow{\bar{j}_p \otimes \bar{j}_{n-p}} & \mathfrak{c}(p) \otimes \mathfrak{c}(n-p). \end{array}$$

The square on the left is commutative by Proposition 5.26. The commutativity of the square on the right is exactly [31, Lemma 4.2], which finishes the proof. \square

5.4. **A Kirby structure morphism $\Delta_{n,p}^{\mathfrak{d}} : \mathfrak{d}(n) \rightarrow \mathfrak{d}(p) \otimes \mathfrak{d}(n-p)$.**

5.4.1. *An algebra homomorphism $\Delta_{n,p}^{\mathfrak{d}} : \mathfrak{d}(n) \rightarrow \mathfrak{d}(p) \otimes \mathfrak{d}(n-p)$.* Recall that $\mathfrak{d}(n) = \mathring{A}_0^\wedge / (P_0^{n+1} + O^n + (\text{deg} > n))$, see Definition 4.68.

Proposition 5.29. *The coproduct (5.29) of the algebra \mathring{A}_0^\wedge induces a morphism of algebras*

$$\Delta_{n,p}^{\mathfrak{d}} : \mathfrak{d}(n) \longrightarrow \mathfrak{d}(p) \otimes \mathfrak{d}(n-p).$$

Proof. The result follows from the following inclusions

- (a) $\Delta_{\mathring{A}_0^\wedge}(P_0^{n+1}) \subset P_0^{p+1} \otimes \mathring{A}_0^\wedge + \mathring{A}_0^\wedge \otimes P_0^{n-p+1}$,
- (b) $\Delta_{\mathring{A}_0^\wedge}(O^n) \subset O^p \otimes \mathring{A}_0^\wedge + \mathring{A}_0^\wedge \otimes O^{n-p}$,
- (c) $\Delta_{\mathring{A}_0^\wedge}(\mathring{A}_0^\wedge[> n]) \subset \mathring{A}_0^\wedge[> p] \otimes \mathring{A}_0^\wedge + \mathring{A}_0^\wedge \otimes \mathring{A}_0^\wedge[> n-p]$.

The inclusions in (a) and (b) were already proved in the proof of Proposition 5.27. For each $A \subset \pi_0(\underline{D})$ we have $\deg(\underline{D}) = \deg(\underline{D}_A) + \deg(\underline{D}_{\pi_0(\underline{D}) \setminus A})$, which implies that $\Delta_{\mathcal{A}_0^\wedge}$ is graded for the degree on \mathcal{A}_0^\wedge , this implies (c). \square

5.4.2. *The algebra homomorphism $\mathfrak{d}(n) \rightarrow \mathfrak{d}(p) \otimes \mathfrak{d}(n-p)$ as a morphism of Kirby structures.* By Proposition 4.69, for every integer $n \geq 1$, the pair $(\mathfrak{d}(n), \text{pr}_n \circ \bar{j}_n \circ \varphi_n \circ \overline{cs}^\nu \circ Z_{\mathcal{A}})$ is a Kirby structure. By Lemma 2.86, for all integers $n, p \geq 1$ with $n-p \geq 1$, the algebra $\mathfrak{d}(p) \otimes \mathfrak{d}(n-p)$ is endowed canonically with the semi-Kirby structure given by the composed algebra homomorphism

$$\mathfrak{Kir} \xrightarrow{\Delta_{\mathfrak{Kir}}} \mathfrak{Kir} \otimes \mathfrak{Kir} \xrightarrow{(\text{pr}_p \circ \bar{j}_p \circ \varphi_p \circ \overline{cs}^\nu \circ Z_{\mathcal{A}}) \otimes (\text{pr}_{n-p} \circ \bar{j}_{n-p} \circ \varphi_{n-p} \circ \overline{cs}^\nu \circ Z_{\mathcal{A}})} \mathfrak{d}(p) \otimes \mathfrak{d}(n-p)$$

and therefore $\mathfrak{d}(p) \otimes \mathfrak{d}(n-p)$ is endowed with a Kirby structure.

Proposition 5.30. *The algebra morphism $\Delta_{n,p}^\mathfrak{d} : \mathfrak{d}(n) \rightarrow \mathfrak{d}(p) \otimes \mathfrak{d}(n-p)$ from Proposition 5.29 defines a morphism of Kirby structures*

$$\Delta_{n,p}^\mathfrak{d} : (\mathfrak{d}(n), \bar{j}_n \circ \varphi_n \circ \overline{cs}^\nu \circ Z_{\mathcal{A}}) \longrightarrow (\mathfrak{d}(p), \bar{j}_p \circ \varphi_p \circ \overline{cs}^\nu \circ Z_{\mathcal{A}}) \otimes (\mathfrak{d}(n-p), \bar{j}_{n-p} \circ \varphi_{n-p} \circ \overline{cs}^\nu \circ Z_{\mathcal{A}}).$$

Proof. We need to show that the diagram

$$(5.32) \quad \begin{array}{ccc} \mathfrak{Kir} & \xrightarrow{\text{pr}_n \circ \bar{j}_n \circ \varphi_n \circ \overline{cs}^\nu \circ Z_{\mathcal{A}}} & \mathfrak{d}(n) \\ \Delta_{\mathfrak{Kir}} \downarrow & & \downarrow \Delta_{n,p}^\mathfrak{d} \\ \mathfrak{Kir} \otimes \mathfrak{Kir} & \xrightarrow{(\text{pr}_p \circ \bar{j}_p \circ \varphi_p \circ \overline{cs}^\nu \circ Z_{\mathcal{A}}) \otimes (\text{pr}_{n-p} \circ \bar{j}_{n-p} \circ \varphi_{n-p} \circ \overline{cs}^\nu \circ Z_{\mathcal{A}})} & \mathfrak{d}(p) \otimes \mathfrak{d}(n-p) \end{array}$$

commutes. This diagram decomposes as

$$\begin{array}{ccccc} \mathfrak{Kir} & \xrightarrow{\bar{j}_n \circ \varphi_n \circ \overline{cs}^\nu \circ Z_{\mathcal{A}}} & \mathfrak{c}(n) & \xrightarrow{\text{pr}_n} & \mathfrak{d}(n) \\ \Delta_{\mathfrak{Kir}} \downarrow & & \downarrow \Delta_{n,p}^\mathfrak{c} & & \downarrow \Delta_{n,p}^\mathfrak{d} \\ \mathfrak{Kir} \otimes \mathfrak{Kir} & \xrightarrow{(\bar{j}_p \circ \varphi_p \circ \overline{cs}^\nu \circ Z_{\mathcal{A}}) \otimes (\bar{j}_{n-p} \circ \varphi_{n-p} \circ \overline{cs}^\nu \circ Z_{\mathcal{A}})} & \mathfrak{c}(p) \otimes \mathfrak{c}(n-p) & \xrightarrow{\text{pr}_p \otimes \text{pr}_{n-p}} & \mathfrak{d}(p) \otimes \mathfrak{d}(n-p). \end{array}$$

The square on the left is the commutative diagram (5.31). The square on the right inserts in the diagram

$$(5.33) \quad \begin{array}{ccccc} \mathcal{A}_0^\wedge & & & & \\ \downarrow \Delta_{\mathcal{A}_0^\wedge} & \searrow & \mathfrak{c}(n) & \xrightarrow{\text{pr}_n} & \mathfrak{d}(n) \\ & & \downarrow \Delta_{n,p}^\mathfrak{c} & & \downarrow \Delta_{n,p}^\mathfrak{d} \\ & & \mathfrak{c}(p) \otimes \mathfrak{c}(n-p) & \xrightarrow{\text{pr}_p \otimes \text{pr}_{n-p}} & \mathfrak{d}(p) \otimes \mathfrak{d}(n-p) \\ & \nearrow & & & \\ \mathcal{A}_0^\wedge \otimes \mathcal{A}_0^\wedge & & & & \end{array}$$

where the diagonal maps are all canonical projections. In this diagram the two triangles, left square and exterior square are commutative by definition. This, together with the surjectivity of the projection $\mathcal{A}_0^\wedge \rightarrow \mathfrak{c}(n)$, imply the commutativity of the inner square, which finishes the proof. \square

Proposition 5.31. *For any $Y \in 3\text{-Mfd}$ s and integers $n, p \geq 1$ such that $n-p \geq 1$, one has:*

- (a) $\Omega_p^\mathfrak{c}(Y) \otimes \Omega_{n-p}^\mathfrak{c}(Y) = \Delta_{n,p}^\mathfrak{c}(\Omega_n^\mathfrak{c}(Y))$ (equality in $\mathfrak{c}(p) \otimes \mathfrak{c}(n-p)$).
- (b) $\Omega_p^\mathfrak{d}(Y) \otimes \Omega_{n-p}^\mathfrak{d}(Y) = \Delta_{n,p}^\mathfrak{d}(\Omega_n^\mathfrak{c}(Y))$ (equality in $\mathfrak{d}(p) \otimes \mathfrak{d}(n-p)$).

Proof. (a) (resp. (b)) follows by applying the functor $\mathcal{KS} \rightarrow \text{Inv}$ from Proposition 2.91 to the morphism of Kirby structures $\Delta_{n,p}^\mathfrak{c}$ (resp. $\Delta_{n,p}^\mathfrak{d}$). \square

5.5. The Kirby structure $\mathfrak{e}(n)$ and the invariant Ω_n^ϵ .

Definition 5.32. Define the set $\text{Jac}(\vec{\emptyset}, \emptyset)$ and the commutative complete graded algebra \mathcal{A}_0^\wedge similarly to $\text{Jac}(\vec{\emptyset}, \emptyset)$ and $\mathring{\mathcal{A}}_0^\wedge$ but without allowing the dashed loop. Let $\mathcal{A}_0^\wedge[n]$ denote the subspace of \mathcal{A}_0^\wedge consisting of elements of degree n and let $\mathcal{A}_0^\wedge[> n]$ denote the complete direct sum of all the $\mathcal{A}_0^\wedge[k]$ with $k > n$. Since \mathcal{A}_0^\wedge is a complete graded algebra, this is a complete graded ideal of \mathcal{A}_0^\wedge .

Definition 5.33. For integers $k, l \geq 0$, denote by $\mathring{\mathcal{A}}_0^\wedge[k]\{l\}$ the subspace of $\mathring{\mathcal{A}}_0^\wedge[k]$ spanned by classes of Jacobi diagrams with l dashed loops. This induces a bigrading on $\mathring{\mathcal{A}}_0^\wedge$.

Lemma 5.34. Let $\mathcal{A}_0^\wedge[X]$ be the polynomial algebra on X equipped with the bigrading such that for integers $k, l \geq 0$ the bidegree (k, l) part is given by $X^l \mathcal{A}_0^\wedge[k]$. Then there is a bigraded algebra isomorphism $\mathcal{A}_0^\wedge[X] \xrightarrow{\cong} \mathring{\mathcal{A}}_0^\wedge$ such that it restricts to the inclusion $\mathcal{A}_0^\wedge \subset \mathring{\mathcal{A}}_0^\wedge$ and takes X to the dashed loop.

Proof. The result is a direct verification. \square

Definition 5.35. Define the complete graded commutative algebra $\mathfrak{e}(n)$ as the quotient algebra

$$(5.34) \quad \mathfrak{e}(n) = \frac{\mathcal{A}_0^\wedge}{\mathcal{A}_0^\wedge[> n]}.$$

Similarly to $\mathfrak{d}(n)$, the algebra $\mathfrak{e}(n)$ is the direct sum of its components $\mathfrak{e}(n)[k]$ of degrees $0 \leq k \leq n$, and is therefore a graded commutative algebra.

One checks that the coproduct (5.29) induces a coproduct

$$(5.35) \quad \Delta_{\mathcal{A}_0^\wedge} : \mathcal{A}_0^\wedge \longrightarrow \mathcal{A}_0^\wedge \otimes \mathcal{A}_0^\wedge$$

on the algebra \mathcal{A}_0^\wedge and that $\Delta_{\mathcal{A}_0^\wedge}$ is an algebra homomorphism.

Proposition 5.36. The coproduct (5.35) of the algebra \mathcal{A}_0^\wedge induces a morphism of algebras

$$\Delta_{n,p}^\epsilon : \mathfrak{e}(n) \longrightarrow \mathfrak{e}(p) \otimes \mathfrak{e}(n-p).$$

Proof. One checks that $\Delta_{\mathcal{A}_0^\wedge}$ is graded for the degree deg on \mathcal{A}_0^\wedge (see similar argument in the proof of Proposition 5.29), which implies the inclusion $\Delta_{\mathcal{A}_0^\wedge}(\mathcal{A}_0^\wedge[> n]) \subset \mathcal{A}_0^\wedge[> p] \otimes \mathcal{A}_0^\wedge + \mathcal{A}_0^\wedge \otimes \mathcal{A}_0^\wedge[> n-p]$ and therefore the stated result. \square

The algebra morphism $\mathcal{A}_0^\wedge \rightarrow \mathring{\mathcal{A}}_0^\wedge$ (given by the inclusion) maps $\mathcal{A}_0^\wedge[> n]$ to $\mathring{\mathcal{A}}_0^\wedge[> n]$ for any integer $n \geq 0$, therefore it induces an algebra morphism $\mathfrak{e}(n) \rightarrow \mathfrak{d}(n)$.

Lemma 5.37 ([31, Lemma 3.3][41, Lemma 10.6]). For every integer $n \geq 1$ the algebra morphism $\mathfrak{e}(n) \rightarrow \mathfrak{d}(n)$ induced by the inclusion $\mathcal{A}_0^\wedge[> n] \subset \mathring{\mathcal{A}}_0^\wedge[> n]$ is an isomorphism.

Proof. The induced map $\mathcal{A}_0^\wedge \rightarrow \mathring{\mathcal{A}}_0^\wedge/O^n$ is an isomorphism of graded algebras therefore the algebra morphism $\mathfrak{e}(n) = \mathcal{A}_0^\wedge/\mathcal{A}_0^\wedge[> n] \rightarrow \mathring{\mathcal{A}}_0^\wedge/(O^n + \mathring{\mathcal{A}}_0^\wedge[> n])$ is an isomorphism. By [31, Lemma 3.3], $P_0^{n+1} \subset O^n + \mathring{\mathcal{A}}_0^\wedge[> n]$, hence the target space of this isomorphism is $\mathfrak{d}(n)$, which finishes the proof. \square

Proposition 5.38. For any integers $n, p \geq 1$ with $n - p \geq 1$, the diagram

$$\begin{array}{ccc} \mathfrak{d}(n) & \longleftarrow & \mathfrak{e}(n) \\ \Delta_{n,p}^\mathfrak{d} \downarrow & & \downarrow \Delta_{n,p}^\epsilon \\ \mathfrak{d}(p) \otimes \mathfrak{d}(n-p) & \longleftarrow & \mathfrak{e}(p) \otimes \mathfrak{e}(n-p) \end{array}$$

is commutative, where the horizontal maps are given by the isomorphisms from Lemma 5.37.

Proof. The diagram

$$\begin{array}{ccc} \mathcal{A}_0^\wedge & \longleftarrow & \mathcal{A}_0^\wedge \\ \Delta_{\mathcal{A}_0^\wedge} \downarrow & & \downarrow \Delta_{\mathcal{A}_0^\wedge} \\ \mathcal{A}_0^\wedge \otimes \mathcal{A}_0^\wedge & \longleftarrow & \mathcal{A}_0^\wedge \otimes \mathcal{A}_0^\wedge, \end{array}$$

where the horizontal maps are inclusions, is commutative, which implies the stated result. \square

Definition 5.39. For any integer $n \geq 1$ and any $Y \in 3\text{-Mfds}$ let $\Omega_n^\epsilon(Y)$ denote the image of $\Omega_n^\partial(Y)$ in $\epsilon(n)$ under the isomorphism $\mathfrak{d}(n) \simeq \epsilon(n)$ from Lemma 5.37. This defines a map $\Omega_n^\epsilon : 3\text{-Mfds} \rightarrow \epsilon(n)$.

Corollary 5.40. For any $Y \in 3\text{-Mfds}$ and integers $n, p \geq 1$ such that $n - p \geq 1$, one has $\Omega_p^\epsilon(Y) \otimes \Omega_{n-p}^\epsilon(Y) = \Delta_{n,p}^\epsilon(\Omega_n^\epsilon(Y))$ (equality in $\epsilon(p) \otimes \epsilon(n - p)$).

Proof. The result follows from the definition of Ω_i^ϵ and Propositions 5.38 and 5.31(b). \square

Recall that \mathcal{A}_0^\wedge is a graded algebra with $\mathcal{A}_0^\wedge[0] = \mathbb{C}$ (generated by the class of the empty Jacobi diagram). Therefore the same holds for each algebra $\epsilon(p)$ for $p \geq 0$.

Definition 5.41. (a) We denote by $\varepsilon_p : \epsilon(p) \rightarrow \mathbb{C}$ the projection on the degree 0 component, which is an algebra character.

(b) For every integer $n \geq 1$, let $\text{pr}_{n,n-1} : \epsilon(n) \rightarrow \epsilon(n - 1)$ be the projection induced by the inclusion $\mathcal{A}_0^\wedge[< n - 1] \subset \mathcal{A}_0^\wedge[< n]$.

Lemma 5.42. For any integer $n \geq 1$, the diagram

$$\begin{array}{ccc} \epsilon(n) & \xrightarrow{\Delta_{n,1}^\epsilon} & \epsilon(1) \otimes \epsilon(n - 1) \\ & \searrow \text{pr}_{n,n-1} & \downarrow \varepsilon_1 \otimes \text{Id}_{\epsilon(n-1)} \\ & & \epsilon(n - 1) \end{array}$$

is commutative.

Proof. Let $\varepsilon_{\mathcal{A}_0^\wedge} : \mathcal{A}_0^\wedge \rightarrow \mathbb{C}$ be the projection of \mathcal{A}_0^\wedge on its degree 0 component. One easily checks that $(\varepsilon_{\mathcal{A}_0^\wedge} \otimes \text{Id}_{\mathcal{A}_0^\wedge}) \circ \Delta_{\mathcal{A}_0^\wedge} = \text{Id}_{\mathcal{A}_0^\wedge}$, which, by projection, implies the stated commutativity. \square

Corollary 5.43. For any $Y \in 3\text{-Mfds}$ and integer $n \geq 2$, we have

$$\varepsilon_1(\Omega_1^\epsilon(Y))\Omega_{n-1}^\epsilon(Y) = \text{pr}_{n,n-1}(\Omega_n^\epsilon(Y)).$$

Proof. The result follows from Corollary 5.40 (with $p = 1$) and Lemma 5.42. \square

For any $Y \in 3\text{-Mfds}$, the value $\varepsilon_1(\Omega_1^\epsilon(Y))$ is given explicitly as follows (see [41, Lemma 10.11]):

$$(5.36) \quad \varepsilon_1(\Omega_1^\epsilon(Y)) = \begin{cases} |H_1(Y; \mathbb{Z})| & \text{if } Y \text{ is a } \mathbb{Q}\text{-homology sphere,} \\ 0 & \text{otherwise.} \end{cases}$$

Corollary 5.44. Let $Y \in 3\text{-Mfds}$ and $n \geq 1$ be an integer. For any positive integer k , let $\Omega_n^\epsilon(Y)[k] \in \epsilon(n)[k]$ denote the degree k part of $\Omega_n^\epsilon(Y) \in \epsilon(n)$, then for $1 \leq k < n$ we have

$$\Omega_n^\epsilon(Y)[k] = (\varepsilon_1(\Omega_1^\epsilon(Y)))^{n-k} \Omega_k^\epsilon(Y)[k].$$

Proof. Corollary 5.43 implies $\Omega_n^\epsilon(Y)[k] = (\varepsilon_1(\Omega_1^\epsilon(Y)))\Omega_{n-1}^\epsilon(Y)[k]$, then the result follows recursively. \square

5.6. The LMO invariant Z^{LMO} . Corollary 5.44 implies that for any $Y \in 3\text{-Mfds}$ all the information given by the collection $\{\Omega_n^\epsilon(Y)\}_{n \geq 1}$ is concentrated in the collection of degree n parts $\{\Omega_n^\epsilon(Y)[n]\}_{n \geq 1}$.

Definition 5.45. For any $Y \in 3\text{-Mfds}$ the *Le-Murakami-Ohtsuki invariant* (or *LMO invariant*) $Z^{\text{LMO}}(Y)$ of Y is given by

$$Z^{\text{LMO}}(Y) = 1 + \sum_{n \geq 1} \Omega_n^\epsilon(Y)[n] \in \mathcal{A}_0^\wedge.$$

By virtue of (5.36) and Corollary 5.44, we can consider the following variant of the LMO invariant for rational homology spheres.

Definition 5.46. Let $\mathbb{Q}\text{-HS}$ denote the set of homeomorphism classes of rational homology 3-spheres. Define the map $\tilde{Z}^{\text{LMO}} : \mathbb{Q}\text{-HS} \rightarrow \mathcal{A}_0^\wedge$ by

$$(5.37) \quad \tilde{Z}^{\text{LMO}}(Y) = 1 + \sum_{n \geq 1} \frac{\Omega_n^\epsilon(Y)[n]}{|H_1(Y; \mathbb{Z})|^n} \in \mathcal{A}_0^\wedge.$$

for any $Y \in \mathbb{Q}\text{-HS}$.

It follows from the definition, (5.36) and Corollary 5.44 that for any positive integer n and any $Y \in \mathbb{Q}\text{-HS}$, we have

$$(5.38) \quad \tilde{Z}^{\text{LMO}}(Y)[\leq n] = |H_1(Y; \mathbb{Z})|^{-n} \Omega_n^\epsilon(Y),$$

where $\tilde{Z}^{\text{LMO}}(Y)[\leq n]$ denotes the image of $\tilde{Z}^{\text{LMO}}(Y)$ under the projection $\mathcal{A}_0^\wedge \rightarrow \frac{\mathcal{A}_0^\wedge}{(\text{deg} > n)} = \epsilon(n)$.

Proposition 5.47. For any $Y \in 3\text{-Mfds}$ we have

$$\Delta_{\mathcal{A}_0^\wedge}(Z^{\text{LMO}}(Y)) = Z^{\text{LMO}}(Y) \otimes Z^{\text{LMO}}(Y) \in \mathcal{A}_0^\wedge \otimes \mathcal{A}_0^\wedge.$$

Proof. For any $k \geq 0$, there is an isomorphism $\epsilon(k)[k] \rightarrow \mathcal{A}_0^\wedge[k]$. Moreover, the coproduct $\Delta_{n,p}^\epsilon : \epsilon(n) \rightarrow \epsilon(p) \otimes \epsilon(n-p)$ induces a map $\epsilon(n)[n] \rightarrow \epsilon(p)[p] \otimes \epsilon(n-p)[n-p]$, which fits in the commutative diagram

$$\begin{array}{ccc} \epsilon(n)[n] & \longrightarrow & \epsilon(p)[p] \otimes \epsilon(n-p)[n-p] \\ \simeq \downarrow & & \downarrow \simeq \\ \mathcal{A}_0^\wedge[n] & \xrightarrow{(\text{pr}_p^{\mathcal{A}_0^\wedge} \otimes \text{pr}_{n-p}^{\mathcal{A}_0^\wedge}) \circ \Delta_{\mathcal{A}_0^\wedge}} & \mathcal{A}_0^\wedge[p] \otimes \mathcal{A}_0^\wedge[n-p] \end{array}$$

where $\text{pr}_i^{\mathcal{A}_0^\wedge} : \mathcal{A}_0^\wedge \rightarrow \mathcal{A}_0^\wedge[i]$ denotes the projection on the degree i component. By Corollary 5.40, $\Delta_{n,p}^\epsilon$ takes $\Omega_n^\epsilon(Y)[n]$ to $\Omega_p^\epsilon(Y)[p] \otimes \Omega_{n-p}^\epsilon(Y)[n-p]$, therefore $(\text{pr}_p^{\mathcal{A}_0^\wedge} \otimes \text{pr}_{n-p}^{\mathcal{A}_0^\wedge}) \circ \Delta_{\mathcal{A}_0^\wedge}$ takes $\Omega_n^\epsilon(Y)[n] \in \mathcal{A}_0^\wedge[n]$ to $\Omega_p^\epsilon(Y)[p] \otimes \Omega_{n-p}^\epsilon(Y)[n-p] \in \mathcal{A}_0^\wedge[p] \otimes \mathcal{A}_0^\wedge[n-p]$. Hence, $\Delta_{\mathcal{A}_0^\wedge}$ takes $\Omega_n^\epsilon(Y)[n] \in \mathcal{A}_0^\wedge[n]$ to $\sum_p \Omega_p^\epsilon(Y)[p] \otimes \Omega_{n-p}^\epsilon(Y)[n-p] \in \mathcal{A}_0^\wedge \otimes \mathcal{A}_0^\wedge$, which implies the result. \square

A similar result can be shown for the variant \tilde{Z}^{LMO} .

6. RELATION WITH THE AARHUS INTEGRAL

As stated in the introduction, there is an alternative approach for the definition of the LMO invariant for rational homology spheres based on a diagrammatic Gaussian integration: *Aarhus integral*. This approach was developed in [6, 7, 8]. The authors of these papers introduced a map $\mathring{A} : \mathbb{Q}\text{-HS} \rightarrow \mathcal{A}_0^\wedge$ and showed that for every positive integer n and any $Y \in \mathbb{Q}\text{-HS}$ the equality $\mathring{A}(Y)[\leq n] = \tilde{Z}^{\text{LMO}}(Y)[\leq n]$ holds. In this brief section we sketch this construction and this relation. Throughout this section let n be a non-negative integer.

6.1. The Aarhus integral. Let $\vec{\mathcal{L}}(\emptyset, \emptyset)^{\text{reg}}$ denote the set of *regular links*, that is, isotopy classes of framed oriented links whose linking matrix is invertible. This set decomposes as $\vec{\mathcal{L}}(\emptyset, \emptyset)^{\text{reg}} = \sqcup_{k \geq 0} \vec{\mathcal{L}}(\emptyset, \emptyset)_k^{\text{reg}}$, where $\vec{\mathcal{L}}(\emptyset, \emptyset)_k^{\text{reg}}$ consists of regular links with k connected components. Let Y be a 3-manifold with surgery presentation L , that is $Y \cong S_L^3$, it is well known that Y is a rational homology sphere if and only if L is a regular link.

Let S be a finite set. Define the complete vector space $\mathcal{B}(S) := \mathcal{A}^\wedge(\vec{\emptyset}, \emptyset, S)$ similarly to $\mathring{\mathcal{A}}^\wedge(\vec{\emptyset}, \emptyset, S)$ (see Definition 3.51) but without allowing the dashed loop. Then $\mathcal{B}(S)$ is a subalgebra of the commutative $\mathring{\mathcal{A}}^\wedge(\vec{\emptyset}, \emptyset, S)$ (with disjoint union as product). Moreover, there is an algebra isomorphism $\mathcal{B}(S)[X] \xrightarrow{\cong} \mathring{\mathcal{A}}^\wedge(\vec{\emptyset}, \emptyset, S)$ such that it restricts to the inclusion $\mathcal{B}(S) \subset \mathring{\mathcal{A}}^\wedge(\vec{\emptyset}, \emptyset, S)$ and takes X to the dashed loop.

An S -*strut* is a Jacobi diagram $s - s'$ without trivalent vertices and with two univalent vertices colored by elements $s, s' \in S$. The number of trivalent vertices defines a degree, denoted by *i-deg*, on the algebra $\mathcal{B}(S)$. For a non-negative integer k , let $\mathcal{B}(S)[\text{i-deg} = k]$ denote the *i-deg* = k part of $\mathcal{B}(S)$. We have that $\mathcal{B}(S)[\text{i-deg} = 0]$ is the polynomial algebra on S -struts. More precisely, the map $S \times S \rightarrow \mathcal{B}(S)[\text{i-deg} = 0]$ defined by $S \times S \ni (s, s') \mapsto s - s'$ is \mathfrak{S}_2 -invariant and $\mathcal{B}(S)[\text{i-deg} = 0] = \mathbb{C}[s - s' \mid (s, s') \in (S \times S)/\mathfrak{S}_2]$. Denote by $\mathcal{B}(S)^{\text{nostrut}}$ the subalgebra of $\mathcal{B}(S)$ consisting of elements with no S -struts⁷. The product map $\mathcal{B}(S)[\text{i-deg} = 0] \otimes \mathcal{B}(S)^{\text{nostrut}} \rightarrow \mathcal{B}(S)$ is an isomorphism.

Let us recall the diagrammatic version of the Poincaré-Birkhoff-Witt isomorphism. Let D be a Jacobi diagram on $(\vec{\emptyset}, \emptyset, C \sqcup \{s\})$ where C is a finite set and $s \notin C$. Consider the arithmetic mean of all the possible ways of gluing the s -colored univalent vertices of D to the interval \uparrow_s . This defines a map

$$(6.1) \quad \chi_s : \mathcal{A}^\wedge(\vec{\emptyset}, \emptyset, C \sqcup \{s\}) \longrightarrow \mathcal{A}^\wedge(\uparrow_s, \emptyset, C),$$

called *symmetrization map*. It is not difficult to show that the map (6.1) is well defined, but it is more laborious to show that it is a vector space isomorphism, see [2, Theorem 8]. Let \uparrow^S denote the oriented Brauer diagram consisting of $|S|$ copies of \uparrow . If $S = \{s_1, \dots, s_l\}$, define

$$\chi_S : \mathcal{B}(S) \longrightarrow \mathcal{A}^\wedge(\uparrow^S)$$

by $\chi_S = \chi_{s_l} \circ \dots \circ \chi_{s_1}$. The map χ_S is a vector space isomorphism called *formal PBW*. The inverse map of χ_S is denoted by $\sigma_S : \mathcal{A}^\wedge(\uparrow^S) \rightarrow \mathcal{B}(S)$.

Proposition 6.1 ([7, Thm. 3]). *The isomorphism $\chi_S : \mathcal{B}(S) \longrightarrow \mathcal{A}^\wedge(\uparrow^S)$ descends to a well defined isomorphism $\chi_S : \mathcal{B}^{\text{links}}(S) \longrightarrow \mathcal{A}^\wedge(\vec{\emptyset}, S)$, where $\mathcal{B}^{\text{links}}(S)$ is a quotient of $\mathcal{B}(S)$ by certain relations, called S -flavored link relations, see [7, §5.2]. Its inverse is denoted by $\sigma_S : \mathcal{A}^\wedge(\vec{\emptyset}, S) \rightarrow \mathcal{B}^{\text{links}}(S)$.*

Denote by $\langle \cdot, \cdot \rangle_S : \mathcal{B}(S) \otimes \mathcal{B}(S) \rightarrow \mathring{\mathcal{A}}_0^\wedge$ the specialization of the pairing (3.20).

Definition 6.2 ([7, Def. 2.7, Def 2.8]). (a) An element $G \in \mathcal{B}(S)$ is called *non-degenerate Gaussian in S* if it is of the form

$$(6.2) \quad G = P \sqcup \exp_{\sqcup} \left(\frac{1}{2} \sum_{x, y \in S} l_{x, y} x - y \right)$$

where $P \in \mathcal{B}(S)^{\text{nostrut}}$ and $\Lambda = (l_{x, y})_{x, y \in S}$ is an invertible symmetric matrix. Let $\mathcal{B}(S)^{\text{ndg}}$ the set of non-degenerate Gaussian elements in $\mathcal{B}(S)$.

- (b) An element $G \in \mathcal{B}^{\text{links}}(S)$ is called *non-degenerate Gaussian in S* if it has a pre-image in $\mathcal{B}(S)$ which is a non-degenerate Gaussian in S . Let $\mathcal{B}^{\text{links}}(S)^{\text{ndg}}$ the set of non-degenerate Gaussian elements in $\mathcal{B}^{\text{links}}(S)$.
- (c) Let $G \in \mathcal{B}(S)^{\text{ndg}}$ expressed as in (6.2) and let $\Lambda^{-1} = (l^{x, y})_{x, y \in S}$ be the inverse matrix of $\Lambda = (l_{x, y})_{x, y \in S}$. The *formal Gaussian integral of G* is the element in \mathcal{A}_0^\wedge given by

$$\int^{\text{FG}} G dS = \left\langle \exp_{\sqcup} \left(-\frac{1}{2} \sum_{x, y \in S} l^{x, y} x - y \right), P \right\rangle_S.$$

⁷In the literature, usually this kind of elements are called *S-substantial*.

This defines a map

$$(6.3) \quad \int^{\text{FG}} : \mathcal{B}(S)^{\text{ndg}} \rightarrow \mathcal{A}_0^\wedge.$$

Proposition 6.3 ([9, Prop. 2.2]). *Let $G, G' \in \mathcal{B}(S)^{\text{ndg}}$ such that their classes in $\mathcal{B}^{\text{links}}(S)^{\text{ndg}}$ are equal. Then $\int^{\text{FG}} G dS = \int^{\text{FG}} G' dS$. Therefore, there is a well defined map*

$$(6.4) \quad \int^{\text{FG}} : \mathcal{B}^{\text{links}}(S)^{\text{ndg}} \rightarrow \mathcal{A}_0^\wedge.$$

It can be shown that for $L \in \vec{\mathcal{I}}(\emptyset, \emptyset)^{\text{reg}}$, the element $\sigma_{\pi_0(L)} \circ \text{cs}^\nu \circ Z_{\mathcal{A}}(L) \in \mathcal{B}^{\text{links}}(\pi_0(L))$ belongs to $\mathcal{B}^{\text{links}}(\pi_0(L))^{\text{ndg}}$, see [6, Claim 1.10].

Theorem 6.4 ([7]). (a) *The map $\mathring{A}_0 : \vec{\mathcal{I}}(\emptyset, \emptyset)^{\text{reg}} \rightarrow \mathcal{A}_0^\wedge$ defined by*

$$L \mapsto \int^{\text{FG}} (\sigma_{\pi_0(L)} \circ \text{cs}^\nu \circ Z_{\mathcal{A}}(L)) d\pi_0(L)$$

is an isotopy invariant of links which is invariant under change of orientation and the Kirby move KII.

(b) *The map $\mathring{A} : \vec{\mathcal{I}}(\emptyset, \emptyset)^{\text{reg}} \rightarrow \mathcal{A}_0^\wedge$ defined by*

$$L \mapsto \mathring{A}_0(U^+)^{-\sigma_+(L)} \mathring{A}_0(U^-)^{-\sigma_-(L)} \mathring{A}_0(L)$$

is invariant under change of orientation and Kirby moves KI and KII. Here U^\pm denotes the unknots with ± 1 framing and $\sigma_\pm(L)$ denotes the number of \pm eigenvalues of the linking matrix of L .

(c) *Let Y be a rational homology sphere. The value $\mathring{A}(Y) := \mathring{A}(L) \in \mathcal{A}_0^\wedge$, where $L \in \vec{\mathcal{I}}(\emptyset, \emptyset)^{\text{reg}}$ is a surgery presentation of Y , is a homeomorphism invariant, called the Aarhus integral of Y . Therefore, there is a well defined map*

$$\mathring{A} : \mathbb{Q}\text{-HS} \rightarrow \mathcal{A}_0^\wedge.$$

6.1.1. *Relation with the LMO invariant.* Let Y be a rational homology sphere and denote by $\mathring{A}(Y)[\leq n]$ the image of $\mathring{A}(Y)$ under the projection $\mathcal{A}_0^\wedge \rightarrow \frac{\mathcal{A}_0^\wedge}{(\text{deg} > n)} = \epsilon(n)$. The following is one of the main results of [8] which gives the precise relation between the Aarhus integral and the LMO invariant.

Theorem 6.5 ([8]). *We have $\mathring{A}(Y)[\leq n] = |H^1(Y; \mathbb{Z})|^{-n} \Omega_n^\epsilon(Y)$ and therefore*

$$\mathring{A}(Y)[\leq n] = \tilde{Z}^{\text{LMO}}(Y)[\leq n].$$

INDEX OF NOTATIONS

$(P, S)_{\mathcal{A}}$, 55	$\mathring{A}_0^{\wedge}[\geq n]$, 111
(R) , 42	$\mathcal{A}_0^{\wedge}[\geq n]$, 131
$\Delta_{n,p}^b$, 126	$\mathring{A}_0^{\wedge}[n]$, 111
$\Delta_{n,p}^c$, 128	$\mathcal{A}_0^{\wedge}[n]$, 131
$\Delta_{n,p}^d$, 129	$\mathring{A}_0^{\wedge}[k]\{l\}$, 131
$\Delta_{n,p}^e$, 131	\mathcal{A}_0 , 99
Δ_{fir} , 42	$\mathfrak{b}(n)$, 94
$\Delta_{\bigoplus_{k \geq 0} \mathring{A}_k^{\wedge}}$, 117	$\mathcal{B}(S)$, 134
$\Delta_{\mathring{A}_k^{\wedge}}$, 117	$\mathcal{B}(S)[i\text{-deg} = k]$, 134
$\Delta_{\mathring{A}_0^{\wedge}}$, 128	$\mathcal{B}(S)^{\text{ndg}}$, 134
$\Delta_{\text{Jac}(\vec{\partial}, \emptyset)}$, 128	$b \circ_{\mathcal{B}r} a$, 13
$\Delta_{\mathcal{A}_0^{\wedge}}$, 131	$\mathcal{B}^{\text{links}}(S)$, 134
Ω_n^c , 115	$\mathcal{B}^{\text{links}}(S)^{\text{ndg}}$, 134
Ω_n^d , 115	$\mathcal{B}r$, 13
Ω_n^e , 132	$\underline{\mathcal{B}r}$, 13
χ_S , 134	br, 24
χ_s , 134	$\underline{\mathcal{B}r}'(X, Y)$, 12
$\circ_{\mathcal{A}}$, 57	$\vec{\mathcal{B}r}$, 14
$\circ_{\mathcal{X}}$, 46	br, 24
$\emptyset_{(P,S)}$, 54	$\underline{\text{br}}$, 25
J^{FG} , 135	$\underline{\mathcal{B}r}$, 15
$\langle R \rangle$, 40	$\mathfrak{c}(n)$, 104
$\langle \cdot, \cdot \rangle_S$, 134	$\text{can}_{S_{i_1} \dots S_{i_k}}^{S_1 \dots S_n}$, 6
$\mathring{A}(Y)[\leq n]$, 135	cap^k , 71
\mathring{A}_0 , 135	$\text{cap}_{\mathcal{A}}^k$, 71
ν , 64	$\text{cap}_{(+)(+-)}^{\mathcal{T}}$, 37
$\otimes_{\mathcal{A}}$, 55	$\text{cap}_{(-)(-+)}^{\mathcal{T}}$, 37
$\otimes_{\mathcal{X}}$, 46	$\text{cap}_{+((--)+)}^{\mathcal{T}}$, 38
$\pi_0(p, q, \sigma)$, 13	$\text{cap}_{+-}^{\mathcal{T}}$, 27
$\pi_0((p, q, \sigma), B)$, 14	$\text{cap}_{-((++)-)}^{\mathcal{T}}$, 38
σ_S , 134	$\text{cap}_{-+}^{\mathcal{T}}$, 27
ε_p , 132	cap_{+--+} , 73
\emptyset , 13	$(\text{cap}_{+--+})_{\mathcal{A}}$, 73
$\vec{\emptyset}$, 14	cap_{-+++} , 73
\mathfrak{S}_k , 93	$(\text{cap}_{-+++})_{\mathcal{A}}$, 73
$\{+, -\}^*$, 15	Cir(B, A), 7
$\{+, -\}^{(*)}$, 36	clos $_k$, 71
$\mathcal{B}(S)^{\text{nostrut}}$, 134	(CO \mathcal{X}), 48
3-Mfds, 23	(CO \mathcal{X}_k), 48
\mathfrak{a} , 74	(CO \mathring{A}^{\wedge}), 72
$\mathring{A}(P, S)$, 54	(CO \mathring{A}_k^{\wedge}), 72
$\mathring{A}(P, S, \Sigma)$, 69	$\text{co}^{\mathcal{A}}((P, a), S)$, 62
$\mathring{A}^{\wedge}(P, S)$, 54	$\text{co}^{\mathcal{A}}(P, (S, s))$, 58
$\mathring{A}^{\wedge}(P, S, \Sigma)$, 69	$\text{co}^{\mathcal{X}}(P, \bullet)$, 45
\mathring{A}_0^{\wedge} , 99	$\text{co}_k^{\mathcal{X}}$, 48
\mathcal{A}_0^{\wedge} , 131	

- $\text{co}^{\text{Jac}}((P, a), S)$, 62
 $\text{co}^{\text{Jac}}(P, (S, s_0))$, 58
 $\text{co}_{\mathcal{B}\vec{r}}$, 15
 co_i , 63
 $\text{co}_{\mathcal{P}a\vec{T}}$, 36
 $\text{co}_{\vec{T}}$, 26
 $\text{Comp}^{\mathcal{X}}(P, P')_{\bullet, \diamond}$, 44
 $\text{Comp}^A(P, P')_{S, S'}$, 57
 $\text{Comp}^{\text{Jac}}(P, P')_{S, S'}$, 57
 ComplGrVect , 55
 $\text{conc}_{k, l}$, 49
 $\text{CO}\vec{T}$, 27
 $\text{CO}\vec{T}_k$, 27
 $\overline{\text{cs}}^\nu$, 92
 cs^α , 71
 $\text{cs}_{P, k}^\alpha$, 71
 $\tilde{\text{cs}}_{P, k}^\alpha$, 71
 cs^ν , 72
 cs_{+-}^ν , 74
 cs_{-+}^ν , 74
 cup^k , 71
 cup_A^k , 71
 $\text{cup}_{(+ -)(+ -)}^{\vec{T}}$, 37
 $\text{cup}_{(- +)(- +)}^{\vec{T}}$, 37
 $\text{cup}_{+((- -)+)}^{\vec{T}}$, 38
 $\text{cup}_{+-}^{\vec{T}}$, 27
 $\text{cup}_{-((+ +)-)}^{\vec{T}}$, 38
 $\text{cup}_{-+}^{\vec{T}}$, 27
 cup_{+--+} , 73
 $(\text{cup}_{+--+})_A$, 73
 cup_{-++} , 73
 $(\text{cup}_{-++})_A$, 73
 $\mathfrak{d}(n)$, 111
 $\mathbb{D}\text{ia}\mathfrak{g}\text{Tr}$, 97
 $\text{dbl}_{\mathcal{B}\vec{r}}$, 15
 dbl_i , 59
 $\text{dbl}_{\mathcal{P}a\vec{T}}$, 36
 $\text{dbl}_{\vec{T}}$, 27
 $\text{dbl}_{\{+, -\}^*}$, 16
 $\text{dbl}_{\mathcal{X}}(P, A)(\bullet)$, 45
 $\text{dbl}_A((P, A), S)$, 59
 $\text{dbl}_{\text{Jac}}((P, A), S)$, 58
 $\text{deg}(\underline{D})$, 54
 deg_{cir} , 99
 $\epsilon(n)$, 131
 $\text{Eq}(U^+, U^-)$, 40
 $\text{FPFI}(X)$, 12
 i-deg , 134
 Id_w^A , 60
 $\text{Id}_w^{\mathcal{X}}$, 44
 Inv , 43
 $j^{T\bullet}$, 102
 \tilde{j}_n , 104
 \tilde{j}_n^{LMO} , 103
 $\tilde{j}_{n, m, J}$, 115
 Jac , 93
 $\text{Jac}(\vec{\emptyset}, \emptyset)$, 131
 $\text{Jac}(P, S)$, 53
 $\text{Jac}(P, S, \Sigma)$, 68
 $(\text{KII}\mathcal{X})$, 48
 $(\text{KII}\mathcal{X}_k)$, 48
 $(\text{KII}\hat{A}^\wedge)$, 72
 $(\text{KII}\hat{A}_k^\wedge)$, 72
 $(\text{KII}^s\hat{A}^\wedge)$, 74
 $(\text{KII}^s\hat{A}_k^\wedge)$, 74
 $\text{KIIData}_{\vec{T}}$, 28
 $\text{KIIData}_{\vec{T}, +-}$, 32
 $\text{KIIData}_{\vec{T}, -+}$, 32
 $\text{KIIMap}_{\vec{T}}^1$, 28
 $\text{KIIMap}_{\vec{T}}^2$, 28
 $\text{KIIMap}_{\vec{T}}$, 29
 $\widetilde{\text{KIIMap}}_{\vec{T}, +-}^1$, 30
 $\widetilde{\text{KIIMap}}_{\vec{T}, -+}^1$, 30
 $\widetilde{\text{KIIMap}}_{\vec{T}, +-}^2$, 31
 $\widetilde{\text{KIIMap}}_{\vec{T}, -+}^2$, 31
 $\text{KIIMap}_{\vec{T}}$, 35
 $\text{KIIMap}_{\mathcal{X}, k, +-}^1$, 47
 $\text{KIIMap}_{\mathcal{X}, k, -+}^1$, 47
 $\text{KIIMap}_{\mathcal{X}, k, +-}^2$, 48
 $\text{KIIMap}_{\mathcal{X}, k, -+}^2$, 48
 $\text{KIIMap}_{\hat{A}^\wedge, k, +-}^{s, 1}$, 73
 $\text{KIIMap}_{\hat{A}^\wedge, k, +-}^{s, 2}$, 73
 $\text{KIIMap}_{\hat{A}^\wedge, k, -+}^{s, 1}$, 73
 $\text{KIIMap}_{\hat{A}^\wedge, k, -+}^{s, 2}$, 73
 $\text{KIIMap}_{\hat{A}^\wedge, k, +-}^1$, 72
 $\text{KIIMap}_{\hat{A}^\wedge, k, +-}^2$, 72
 $\widetilde{\text{KIIMap}}_{\mathcal{P}a\vec{T}, +-}^i$, 37
 $\widetilde{\text{KIIMap}}_{\mathcal{P}a\vec{T}, -+}^i$, 37

- $\text{KII}\vec{T}$, 29
 $\text{KII}\vec{T}_k$, 39
 Kir , 40
 \mathfrak{Kir} , 42
 \mathfrak{Kir}_k , 42
 Kir_k , 40
 \mathcal{KS} , 43

 $L^{<2n}$, 93
 $L_k^{<r}$, 93
 $\text{Lk}(K, K')$, 20

 m_x , 54

 O^n , 104
 orb , 52
 orb_{cyc} , 53
 orb_{lin} , 53

 $\mathcal{P}(X)$, 6
 P^{n+1} , 93
 $P^{n+1}(P)_k$, 93
 $P^{n+1}(P, S)$, 93
 P_k^{n+1} , 93
 P_A , 55
 $\mathcal{Pa}\vec{T}$, 36
 $\mathcal{Pa}\vec{T}(\downarrow\uparrow)$, 37
 $\mathcal{Pa}\vec{T}$, 36
 $\text{Part}(X)$, 6
 $\mathcal{Part}(X, Y)$, 6
 PDISM , 52
 pr_n , 112
 $\text{pr}_{n, n-1}$, 132
 $\text{proj}_{1, k-1}^{\mathcal{X}}$, 48
 $\text{proj}_{P, S}^{\mathcal{X}}$, 46

 $\mathfrak{s}(\mathbf{A})$, 73
 $\mathfrak{s}(\mathbf{X})$, 50
 $(\mathfrak{s}(\mathbf{X}), \mu)$, 50

 $\mathfrak{s}(\mathbf{X})_k$, 50
 $\text{Set}\mathcal{D}$, 123
 Set_f , 44
 Set_f^* , 44
 SKS , 43
 $\text{Sym}_k(\mathbb{Z})$, 25

 $\vec{T}(\emptyset, \emptyset)^{\text{reg}}$, 134
 $\vec{T}(\emptyset, \emptyset)_k^{\text{reg}}$, 134
 $\mathbb{T}(A)$, 98
 $\vec{T}(P)$, 30
 $\vec{T}(P)_k$, 38
 \mathcal{T} , 23
 \vec{T} , 23
 \vec{T} , 25
 $\vec{T}(u, v)$, 25
 $\vec{T}(\emptyset, \emptyset)$, 25
 T^{LMO} , 98
 $\tau_{\bullet, \diamond}^{\text{Set}_f}$, 44
 $\tau^{\text{Vect}}(P, P')_{\bullet, \diamond}$, 44
 $\text{Tens}^A(P, P')_{S, S'}$, 55
 $\text{Tens}^{\mathcal{X}}(P, P')_{\bullet, \diamond}$, 44
 $\text{Tens}^{\text{Jac}}(P, P')_{S, S'}$, 55

 U^{\pm} , 21

 VectGp , 46

 $\mathcal{X}(P)_k$, 46
 $\mathcal{X}(P, \bullet)$, 44
 \mathcal{X}_k , 46

 \check{Z} , 72
 \check{Z}^{LMO} , 133
 Z^{LMO} , 133
 $\check{Z}^{\text{LMO}}(Y)[\leq n]$, 133
 $Z_A(\bullet)$, 64
 $Z_{\mathcal{X}, k}$, 50

REFERENCES

- [1] Daniel Altschüler and Laurent Freidel. On universal Vassiliev invariants. *Comm. Math. Phys.*, 170(1):41–62, 1995.
- [2] Dror Bar-Natan. On the Vassiliev knot invariants. *Topology*, 34(2):423–472, 1995.
- [3] Dror Bar-Natan. Non-associative tangles. In *Geometric topology (Athens, GA, 1993)*, volume 2 of *AMS/IP Stud. Adv. Math.*, pages 139–183. Amer. Math. Soc., Providence, RI, 1997.
- [4] Dror Bar-Natan. On associators and the Grothendieck-Teichmüller group. I. *Selecta Math. (N.S.)*, 4(2):183–212, 1998.
- [5] Dror Bar-Natan, Stavros Garoufalidis, Lev Rozansky, and Dylan P. Thurston. Wheels, wheeling, and the Kontsevich integral of the unknot. *Israel J. Math.*, 119:217–237, 2000.
- [6] Dror Bar-Natan, Stavros Garoufalidis, Lev Rozansky, and Dylan P. Thurston. The Aarhus integral of rational homology 3-spheres. I. A highly non trivial flat connection on S^3 . *Selecta Math. (N.S.)*, 8(3):315–339, 2002.
- [7] Dror Bar-Natan, Stavros Garoufalidis, Lev Rozansky, and Dylan P. Thurston. The Aarhus integral of rational homology 3-spheres. II. Invariance and universality. *Selecta Math. (N.S.)*, 8(3):341–371, 2002.
- [8] Dror Bar-Natan, Stavros Garoufalidis, Lev Rozansky, and Dylan P. Thurston. The århus integral of rational homology 3-spheres. III. Relation with the Le-Murakami-Ohtsuki invariant. *Selecta Math. (N.S.)*, 10(3):305–324, 2004.
- [9] Dror Bar-Natan and Ruth Lawrence. A rational surgery formula for the LMO invariant. *Israel J. Math.*, 140:29–60, 2004.
- [10] Dror Bar-Natan, Thang T. Q. Le, and Dylan P. Thurston. Two applications of elementary knot theory to Lie algebras and Vassiliev invariants. *Geom. Topol.*, 7:1–31, 2003.
- [11] Joan S. Birman and Xiao-Song Lin. Knot polynomials and Vassiliev’s invariants. *Invent. Math.*, 111(2):225–270, 1993.
- [12] Gerhard Burde, Heiner Zieschang, and Michael Heusener. *Knots*, volume 5 of *De Gruyter Studies in Mathematics*. De Gruyter, Berlin, extended edition, 2014.
- [13] Pierre Cartier. Construction combinatoire des invariants de Vassiliev-Kontsevich des nœuds. *C. R. Acad. Sci. Paris Sér. I Math.*, 316(11):1205–1210, 1993.
- [14] Dorin Cheptea, Kazuo Habiro, and Gwénaél Massuyeau. A functorial LMO invariant for Lagrangian cobordisms. *Geom. Topol.*, 12(2):1091–1170, 2008.
- [15] Dorin Cheptea and Thang T. Q. Le. A TQFT associated to the LMO invariant of three-dimensional manifolds. *Comm. Math. Phys.*, 272(3):601–634, 2007.
- [16] S. Chmutov, S. Duzhin, and J. Mostovoy. *Introduction to Vassiliev knot invariants*. Cambridge University Press, Cambridge, 2012.
- [17] Jonathan Comes and Victor Ostrik. On blocks of Deligne’s category $\underline{\text{Rep}}(S_t)$. *Adv. Math.*, 226(2):1331–1377, 2011.
- [18] P. Deligne. La catégorie des représentations du groupe symétrique S_t , lorsque t n’est pas un entier naturel. In *Algebraic groups and homogeneous spaces*, volume 19 of *Tata Inst. Fund. Res. Stud. Math.*, pages 209–273. Tata Inst. Fund. Res., Mumbai, 2007.
- [19] V. G. Drinfel’d. On quasitriangular quasi-Hopf algebras and on a group that is closely connected with $\text{Gal}(\overline{\mathbf{Q}}/\mathbf{Q})$. *Algebra i Analiz*, 2(4):149–181, 1990.
- [20] P. Freyd, D. Yetter, J. Hoste, W. B. R. Lickorish, K. Millett, and A. Ocneanu. A new polynomial invariant of knots and links. *Bull. Amer. Math. Soc. (N.S.)*, 12(2):239–246, 1985.
- [21] M. N. Gusarov. A new form of the Conway-Jones polynomial of oriented links. *Zap. Nauchn. Sem. Leningrad. Otdel. Mat. Inst. Steklov. (LOMI)*, 193:4–9, 161, 1991.
- [22] M. N. Gusarov. On the n -equivalence of knots and invariants of finite degree. *Zap. Nauchn. Sem. S.-Peterburg. Otdel. Mat. Inst. Steklov. (POMI)*, 208:152–173, 221–222, 1993.
- [23] Allen Hatcher. Notes on Basic 3-Manifold Topology. Available online at <https://pi.math.cornell.edu/hatcher/3M/3M.pdf>, 2007.

- [24] David M. Jackson and Iain Moffatt. *An introduction to quantum and Vassiliev knot invariants*. CMS Books in Mathematics/Ouvrages de Mathématiques de la SMC. Springer, Cham, 2019.
- [25] Vaughan F. R. Jones. A polynomial invariant for knots via von Neumann algebras. *Bull. Amer. Math. Soc. (N.S.)*, 12(1):103–111, 1985.
- [26] Louis H. Kauffman. New invariants in the theory of knots. *Astérisque*, (163-164):6, 137–219, 282 (1989), 1988. On the geometry of differentiable manifolds (Rome, 1986).
- [27] Robion Kirby. A calculus for framed links in S^3 . *Invent. Math.*, 45(1):35–56, 1978.
- [28] Maxim Kontsevich. Vassiliev’s knot invariants. In *I. M. Gelfand Seminar*, volume 16 of *Adv. Soviet Math.*, pages 137–150. Amer. Math. Soc., Providence, RI, 1993.
- [29] Thang Q. T. Le, Hitoshi Murakami, Jun Murakami, and Tomotada Ohtsuki. A three-manifold invariant derived from the universal Vassiliev-Kontsevich invariant. *Proc. Japan Acad. Ser. A Math. Sci.*, 71(6):125–127, 1995.
- [30] Thang T. Q. Le and Jun Murakami. Parallel version of the universal Vassiliev-Kontsevich invariant. *J. Pure Appl. Algebra*, 121(3):271–291, 1997.
- [31] Thang T. Q. Le, Jun Murakami, and Tomotada Ohtsuki. On a universal perturbative invariant of 3-manifolds. *Topology*, 37(3):539–574, 1998.
- [32] Thang Tu Quoc Le, Hitoshi Murakami, Jun Murakami, and Tomotada Ohtsuki. A three-manifold invariant via the Kontsevich integral. *Osaka J. Math.*, 36(2):365–395, 1999.
- [33] Tu Quoc Thang Le. The LMO invariant. Lecture notes from: “*Ecole d’Eté de Mathématiques: Invariants de noeuds et de variétés de dimension trois*”, <http://people.math.gatech.edu/letu/Papers/GRENOBLE1.pdf>, Institut Fourier, 1999.
- [34] Tu Quoc Thang Le and Jun Murakami. Representation of the category of tangles by Kontsevich’s iterated integral. *Comm. Math. Phys.*, 168(3):535–562, 1995.
- [35] Tu Quoc Thang Le and Jun Murakami. The universal Vassiliev-Kontsevich invariant for framed oriented links. *Compositio Math.*, 102(1):41–64, 1996.
- [36] G. I. Lehrer and R. B. Zhang. The Brauer category and invariant theory. *J. Eur. Math. Soc. (JEMS)*, 17(9):2311–2351, 2015.
- [37] W. B. R. Lickorish. A representation of orientable combinatorial 3-manifolds. *Ann. of Math. (2)*, 76:531–540, 1962.
- [38] W. B. Raymond Lickorish. *An introduction to knot theory*, volume 175 of *Graduate Texts in Mathematics*. Springer-Verlag, New York, 1997.
- [39] Ning Lu. A simple proof of the fundamental theorem of Kirby calculus on links. *Trans. Amer. Math. Soc.*, 331(1):143–156, 1992.
- [40] J. Murakami and T. Ohtsuki. Topological quantum field theory for the universal quantum invariant. *Comm. Math. Phys.*, 188(3):501–520, 1997.
- [41] Tomotada Ohtsuki. *Quantum invariants*, volume 29 of *Series on Knots and Everything*. World Scientific Publishing Co., Inc., River Edge, NJ, 2002. A study of knots, 3-manifolds, and their sets.
- [42] Sergey Piunikhin. Combinatorial expression for universal Vassiliev link invariant. *Comm. Math. Phys.*, 168(1):1–22, 1995.
- [43] V. V. Prasolov and A. B. Sossinsky. *Knots, links, braids and 3-manifolds*, volume 154 of *Translations of Mathematical Monographs*. American Mathematical Society, Providence, RI, 1997. An introduction to the new invariants in low-dimensional topology, Translated from the Russian manuscript by Sossinsky [Sosinskiĭ].
- [44] Józef H. Przytycki and Paweł Traczyk. Invariants of links of Conway type. *Kobe J. Math.*, 4(2):115–139, 1988.
- [45] N. Reshetikhin and V. G. Turaev. Invariants of 3-manifolds via link polynomials and quantum groups. *Invent. Math.*, 103(3):547–597, 1991.
- [46] N. Reshetikhin and V. G. Turaev. Invariants of 3-manifolds via link polynomials and quantum groups. *Invent. Math.*, 103(3):547–597, 1991.
- [47] N. Yu. Reshetikhin and V. G. Turaev. Ribbon graphs and their invariants derived from quantum groups. *Comm. Math. Phys.*, 127(1):1–26, 1990.

- [48] Dale Rolfsen. *Knots and links*, volume 7 of *Mathematics Lecture Series*. Publish or Perish, Inc., Houston, TX, 1990. Corrected reprint of the 1976 original.
- [49] Nikolai Saveliev. *Lectures on the topology of 3-manifolds*. De Gruyter Textbook. Walter de Gruyter & Co., Berlin, revised edition, 2012. An introduction to the Casson invariant.
- [50] Richard P. Stanley. *Enumerative combinatorics. Volume 1*, volume 49 of *Cambridge Studies in Advanced Mathematics*. Cambridge University Press, Cambridge, second edition, 2012.
- [51] V. G. Turaev. The Yang-Baxter equation and invariants of links. *Invent. Math.*, 92(3):527–553, 1988.
- [52] V. G. Turaev. Operator invariants of tangles, and R -matrices. *Izv. Akad. Nauk SSSR Ser. Mat.*, 53(5):1073–1107, 1135, 1989.
- [53] V. G. Turaev. Operator invariants of tangles, and R -matrices. *Izv. Akad. Nauk SSSR Ser. Mat.*, 53(5):1073–1107, 1135, 1989.
- [54] Vladimir G. Turaev. *Quantum invariants of knots and 3-manifolds*, volume 18 of *De Gruyter Studies in Mathematics*. De Gruyter, Berlin, 2016. Third edition [of MR1292673].
- [55] Vladimir G. Turaev. *Quantum invariants of knots and 3-manifolds*, volume 18 of *De Gruyter Studies in Mathematics*. De Gruyter, Berlin, third edition, 2016.
- [56] V. A. Vassiliev. Cohomology of spaces of knots. *Akad. Nauk SSSR Inst. Prikl. Mat. Preprint*, (91):29, 1990.
- [57] O. Ya. Viro, O. A. Ivanov, N.Yu. Netsvetaev, and V. M. Kharlamov. *Elementary Topology: Problem Textbook*. American Mathematical Society, 2008.
- [58] Andrew H. Wallace. Modifications and cobounding manifolds. *Canadian J. Math.*, 12:503–528, 1960.
- [59] Edward Witten. Quantum field theory and the Jones polynomial. *Comm. Math. Phys.*, 121(3):351–399, 1989.

IRMA (UMR 7501) ET DÉPARTEMENT DE MATHÉMATIQUES, UNIVERSITÉ DE STRASBOURG, 7 RUE RENÉ DESCARTES, 67084 STRASBOURG (FRANCE)

Email address: `b.enriquez@math.unistra.fr`

CENTER FOR GEOMETRY AND PHYSICS, INSTITUTE FOR BASIC SCIENCE (POSTECH CAMPUS) 79, JIGOK-RO 127 BEON-GIL, NAM-GU, POHANG-SI, GYEONGSANGBUK-DO, KOREA 37673

Email address: `andersonvera@ibs.re.kr`