

Divides with cusps and symmetric links

Sakumi Sugawara *

January 5, 2024

Abstract

A Divide with cusps is the image of a proper generic immersion from finite intervals and circles into a 2-disk which allows to have cusps. A divide with cusps is the generalization of the notion of the divide which is introduced by A'Campo. From a divide with cusps, we can define the associated link in S^3 . In this paper, we give the characterization of the link in S^3 which can be described as the associated link of a divide with cusps. In particular, we prove that every strongly invertible link and 2-periodic link can be described as the link of a divide with cusps.

1 Introduction

A divide is the image of a proper generic immersion from finite intervals and circles into a 2-disk. The notion of the divide is introduced by A'Campo as the tool to describe the real morsification of plane curve singularity and its generalization [AC1, AC2]. From a divide, we can define the associated link in S^3 by corresponding to the unit tangent vector of a divide. It is known that if a divide is constructed by the real morsification of a plane curve singularity, then the associated link is equivalent to the algebraic link of the curve singularity. There are some constraints for links that are described as the associated link of divides. For example, a divide link has fiberedness [AC2] and quasipositivity [Ka1]. Thus, there are not many links that can be described as the divide link. However, we can calculate the monodromy of the fibered link and the Seifert genus of a divide link from the combinatorial information of the divide. Therefore, a divide is a very nice tool to describe links. Recently, divides are applied to study 3-, 4-dimensional topology [FK, IN].

Divides have some generalizations, for example, oriented divides [GI2], free divides [GI1, IN], graph divides [Ka2], (ordered Morse) signed divides [CP, Co]. Divides are also generalized to immersed curves in a compact oriented surface [I]. In this paper, we deal with the divide with cusps, which is introduced by the author and Yoshinaga [SY]. A divide with cusps is the generalization of the divide that allows to have cusps. The notion of divide with cusps was introduced in the context of the handle decomposition of the complement of complexified real line arrangements. They proved that the Kirby diagram of the complement of a complexified real line arrangement is described as the associated link of a certain divide with cusps. From a divide with cusps, we can define the associated link in S^3 similarly to the original divide. However, cusps in the divides bring the associated link to having half twists. Thus, the associated link of divides with cusps may be complicated in general. In fact, there are non-fibered links that can

*Department of Mathematics, Graduate School of Science, Hokkaido University, North 10, West 8, Kita-ku, Sapporo 060-0810, JAPAN, E-mail: sugawara.sakumi.f5@elms.hokudai.ac.jp

MSC Classification: 57K10

Keywords: divides, divides with cusps, strongly invertible knots, periodic knots

be described as the associated link of divides with cusps. Therefore, the class of links which is described as the link of a divide with cusps is strictly larger than the class of links of original divides. In this paper, we discuss how large the class of links of divides with cusps is. We succeeded in giving the characterization of the links of divides with cusps. The following is the main theorem in this paper.

Theorem 1.1. *A link L in S^3 is described as the associated link of a divide with cusps if and only if there exists an involution j on S^3 which has a non-empty fixed point set such that $j(L) = L$.*

Here, an *involution* on S^3 means an orientation preserving self-diffeomorphism of S^3 satisfying $j^2 = id$ and $j \neq id$. Let us consider when $L = K$ is a knot. Then, K satisfies $j(K) = K$ if and only if K is either a strongly invertible knot or a 2-periodic knot. We have the following theorem as the special case of the main result.

Theorem 1.2. *A knot K is described as the associated link of a divide with cusps if and only if K is either a strongly invertible knot or 2-periodic knot.*

Couture proved that every strongly invertible link is described as the link of a signed divide [Co]. A signed divide can be considered as a divide with cusps. Equipping a negative sign to a double point corresponds to adding some cusps around the double point (Remark 4.6). Thus, our main result is the generalization of the Couture's result. However, the proof of our main result is based on the idea of Couture's result. In the proof, we construct a well-projection of a link to the disk and perform an appropriate isotopy to the link of a divide with cusps using this projection.

This paper is organized as follows. In Section 2, we introduce the theory of divides with cusps. In Section 3, we recall the symmetry and involutions on links. In Section 4, we prove the main theorem and give some examples, including torus knots and 2-bridge knots.

Acknowledgement. The author would like to thank Professor Masahiko Yoshinaga for the helpful discussions on this research. The author also would like to thank Professors Mikami Hirasawa, Tomomi Kawamura, and Makoto Sakuma for the discussions during the conference Branched Coverings, Degenerations, and Related Topics (March 2022, online). This work is supported by the JSPS KAKENHI Grant Number JP22KJ0114 and JP23H00081 (PI: Masahiko Yoshinaga).

2 Divides with cusps and associated links

Definition 2.1. Let X be a compact 1-dimensional manifold. A *divide with cusps* P is the image of a continuous map $\alpha : (X, \partial X) \rightarrow (D^2, \partial D^2)$ satisfying the following conditions (see Figure 1).

- (i) $\alpha^{-1}(\partial D^2) = \partial X$, the restriction $\alpha|_{\partial X}$ is injective, and P intersects to ∂D^2 transversely.
- (ii) There are finitely many points $p_1, \dots, p_s \in \text{Int}(X)$ such that α is an immersion on $X \setminus \{p_1, \dots, p_s\}$ and $\alpha(p_i)$ is a cusp of P . A cusp is not a self intersection.
- (iii) There are no singularities except for cusps and double points.

A 1-dimensional manifold X can be expressed as a disjoint union of finite intervals and circles $\bigsqcup_j I_j \sqcup \bigsqcup_k S_k$, where I_j is an interval and S_k is a circle.

Definition 2.2. The image of each connected component of X is called a *component* of a divide with cusps. The image $\alpha(I_j)$ of each interval is called a *interval component* and the image $\alpha(S_k)$ of each circle is called a *circle component*.

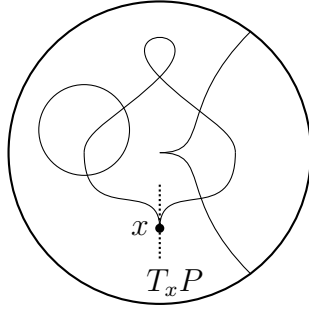

Figure 1: An example of a divide with cusps

Remark 2.3. A divide with cusps that has no cusps is called just a *divide*. This is nothing but a divide introduced by A'Campo [AC2].

We identify D^2 the unit disk in the complex plane $\{z \in \mathbb{C} \mid |z| \leq 1\}$, and fix the canonical orientation. Let $TD^2 \cong D^2 \times \mathbb{R}^2$ be the total space of the tangent bundle of D^2 . We identify the 3-sphere S^3 to the unit sphere $S(D^2)$ in TD^2 . Here,

$$S(D^2) = \{(x, v) \in TD^2 \mid |x|^2 + |v|^2 = 1\}.$$

Let $\pi : S(D^2) \rightarrow D^2$; $\pi(x, v) = x$ be the first projection. We define an involution $j : S(D^2) \rightarrow S(D^2)$ as $j(x, v) = (x, -v)$. It is clear that $\text{Fix}(j) = \partial D^2 \times \{0\}$.

Definition 2.4. Let P be a divide with cusps. Then, we define the associated link $L(P)$ in $S(D^2)$ as

$$L(P) = \{(x, v) \in S(D^2) \mid x \in P, v \in T_x P\}.$$

Remark 2.5. If $x \in \text{Int}P$, then there are two vectors $\pm v \in T_x P$ which are contained in $L(P)$. If $x \in \partial P$, then only $0 \in T_x P$ is contained in $L(P)$. The tangent vector is determined by the argument.

Remark 2.6. There is a natural tangent space $T_x P$ at a cusp. Cusps are corresponding to half twists in the link $L(P)$ locally (see Figure 2).

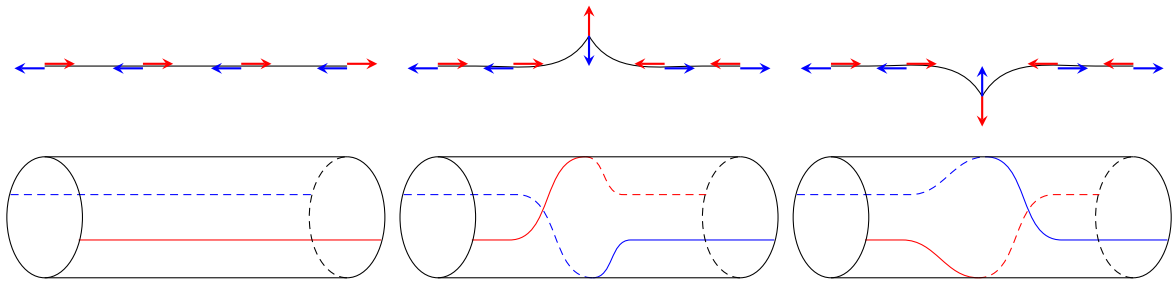

Figure 2: Smooth curve, upper cusp, lower cusp, and their links

We now introduce a method to describe a link diagram of the associated link of a divide with cusps. The method is based on the algorithm due to Hirasawa [Hi]. Let $V \cong D^2 \times S^1$ be a solid torus and (x, θ) be the coordinate ($x \in D^2$ and $-\pi \leq \theta \leq \pi$). Let \tilde{V} be the quotient space V / \sim by the equivalence relation $(x_1, \theta) \sim (x_2, \theta)$ (for $x_1, x_2 \in \partial D^2$) and $(x, -\pi) \sim (x, \pi)$ (for $x \in D^2$). Remark that \tilde{V} is homeomorphic to S^3 . The map $\phi : \tilde{V} \rightarrow S^3$ defined by $\phi(x, \theta) = (x, \sqrt{1 - |u|^2} \cdot e^{\sqrt{-1}\theta})$ gives a homeomorphism. Here, we consider S^3 as the unit sphere $S(D^2)$ in the tangent bundle TD^2 , and tangent space \mathbb{R}^2 as \mathbb{C} . The associated link can be drawn in \tilde{V} by pulling back by this homeomorphism.

Let P be a divide with cusps. By small perturbation, except for the neighborhood of cusps, we assume that P consists of segments with slope ± 1 except for the corners, which is considered as the smooth point where the angle turns 90 degrees quickly. Around a cusp, we perturb P so that the slope of the cusp is $\pm\infty$ (Figure 3). By perturbing P in this way, we can draw the link $L' = \phi^{-1}(L(P))$ in \tilde{V} . The link L' consists of linear segments.

The link diagram can be obtained by using the projection $p : (x, \theta) \mapsto x$. After a small perturbation for L' , we can draw the link diagram of L' as in Figure 4. Note that around maximal points, minimal points, and cusps, the angle of the tangent vector crosses $\pm\pi$. The link diagrams are locally given as in Figure 5.

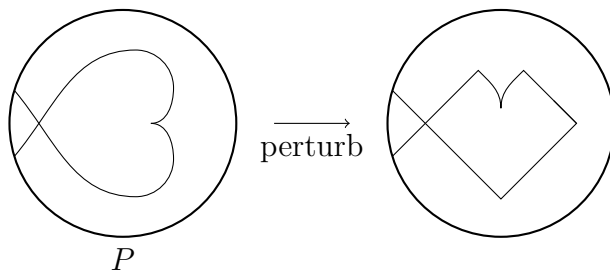

Figure 3: Perturbation of a divide with cusps

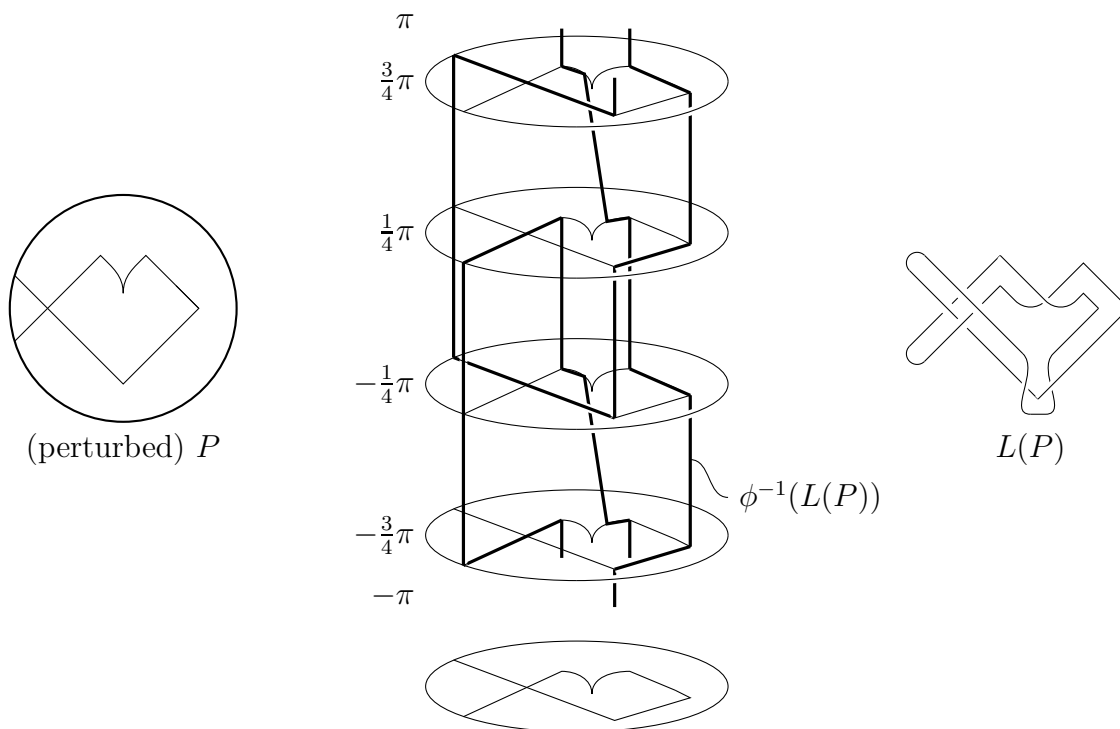

Figure 4: An example of the diagram of $L(P)$

Remark 2.7. There are moves of divides with cusps that do not change the isotopy type of the link $L(P)$ (Figure 6). We can check them by drawing diagrams.

3 Involutions on links

In this section, we review the symmetry of links and discuss the symmetry of the links of divide with cusps.

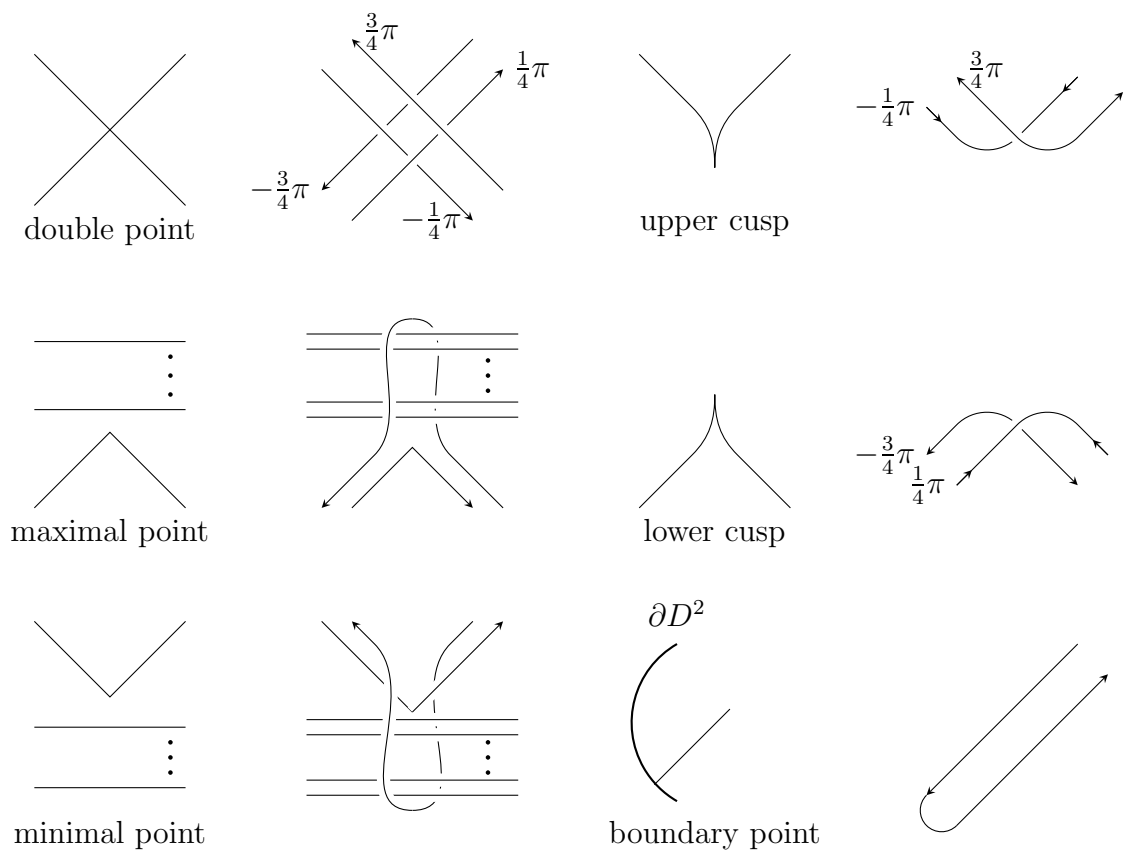

Figure 5: Local link diagrams of divides with cusps

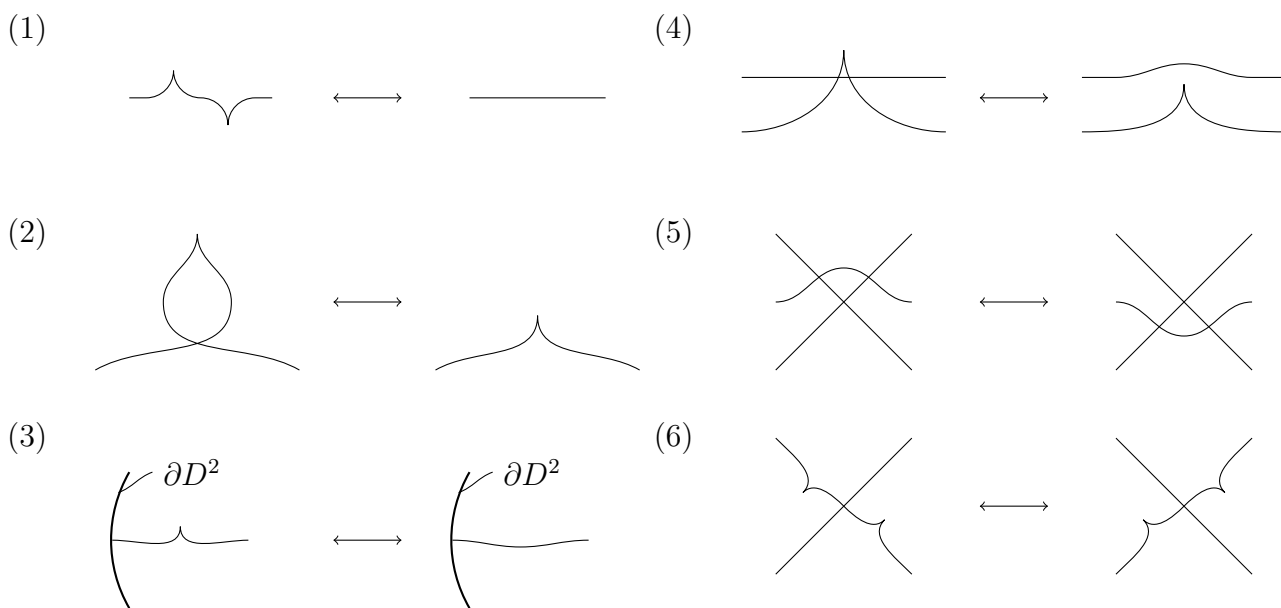

Figure 6: Moves of divides with cusps

Definition 3.1. Let L be an oriented link in S^3 . A link L is called a *strongly invertible link* if there exists an orientation preserving self-homeomorphism $j : S^3 \rightarrow S^3$ such that

- (i) $j^2 = id$ and $j \neq id$.
- (ii) The fixed point set $\text{Fix}(j)$ is non-empty set.
- (iii) $j(L) = L$, and the orientation of $j(L)$ is reversed by j .

We sometimes call the pair (L, j) a strongly invertible link.

See Figure 7 for examples of strongly invertible links. Remark that if L is a strongly invertible knot, then $\text{Fix}(j) \cap L$ is a set consisting of two points.

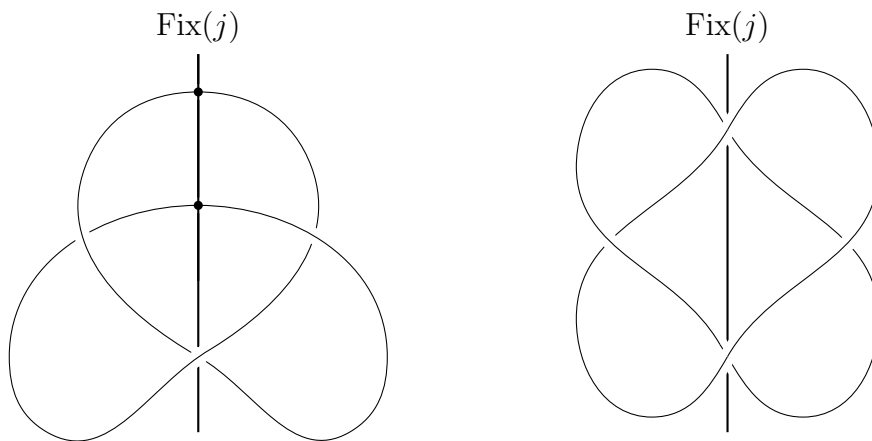

Figure 7: Examples of strongly invertible links

Definition 3.2. Let L be an oriented link in S^3 and p be a prime number. A link L is called *p-periodic* if there exists an orientation preserving self-homeomorphism $j : S^3 \rightarrow S^3$ such that

- (i) $j^p = id$ and $j^k \neq id$ for $1 \leq k \leq p - 1$.
- (ii) The fixed point set $\text{Fix}(j)$ is non-empty set.
- (iii) $j(L) = L$, and the orientation of $j(L)$ preserved by j .

We sometimes call the pair (L, j) is a p -periodic link.

See Figure 8 for the examples of p -periodic links. In this paper, we mainly deal with 2-periodic links.

Remark 3.3. By the resolved Smith's conjecture, it is known that if j is the orientation preserving self-homeomorphism of finite orders with non-empty fixed point sets, then the fixed point set is a trivial knot in S^3 [MB].

Definition 3.4. Let (L_i, j_i) be a pair of a link and an involution on S^3 such that $j_i(L_i) = L_i$ ($i = 1, 2$). We call (L_1, j_1) and (L_2, j_2) are *strongly equivalent* if there exists an isotopy $\varphi : S^3 \times [0, 1] \rightarrow S^3$ such that $\varphi_0 = id_{S^3}$, $\varphi_1(L_1) = L_2$ and $j_2 \circ \varphi_1 = \varphi_1 \circ j_1$. Here, $\varphi_t : S^3 \rightarrow S^3$ is defined as $\varphi_t(x) = \varphi(x, t)$. Moreover, if $j_1 = j_2 = j$ and $j \circ \varphi_t = \varphi_t \circ j$ for every $t \in [0, 1]$, then we call (L_1, j) and (L_2, j) are *j-isotopic*.

Remark 3.5. The moves noted in Remark 2.7 give j -isotopy for the associated links of divides with cusps.

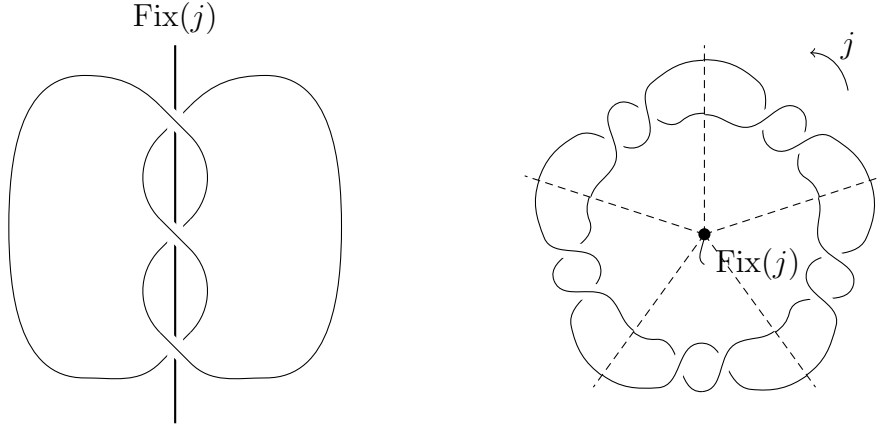

Figure 8: Examples of periodic links

From now on, we fix the involution $j : S(D^2) \rightarrow S(D^2); j(x, v) = (x, -v)$ defined as before. The following proposition is clear by the definition of the associated link of a divide with cusps.

Proposition 3.6. Let P be a divide with cusps. The associated link $L(P)$ satisfies $j(L(P)) = L(P)$.

More precisely, we have the following proposition by decomposing a divide into components. Let $P = P_1 \cup P_2 \cup \dots \cup P_m$ be a component decomposition of a divide.

Proposition 3.7. Let P_i be a component of a divide P . If P_i is an interval component, then the link $L(P_i)$ is a strongly invertible knot. If P_i is a circle component with odd cusps, then the link $L(P_i)$ is a 2-periodic knot. If P_i is a circle component with even cusps, then the link $L(P_i)$ is a 2-component link and it is either a strongly invertible link or a 2-periodic link.

Proof. We give proof only for the circle component case. The interval component case is proven similarly. Let P_i be a circle component with ℓ cusps. Let $S^1 = \{z \in \mathbb{C} \mid |z| = 1\}$ be a unit circle of a complex plane. The component P_i is described as the image of a continuous map $\bar{c} : S^1 \rightarrow P_i$ satisfying following conditions:

- The point $\bar{c}(1)$ is a smooth point.
- Each cusp point x_k is expressed as $x_k = \bar{c}(\zeta^k)$, where $\zeta = \exp(2\sqrt{-1}\pi/(\ell + 1))$.
- Define $c_k : A_k \rightarrow P_i$ as $c_k(z) = \bar{c}(z)$ for $1 \leq k \leq \ell + 1$. Then, c_k is an oriented smooth parametrization of a curve. Here A_k is the arc $\{z \in S^1 \mid \frac{2(k-1)\pi}{(\ell+1)} < \arg z < \frac{2k\pi}{(\ell+1)}\}$.

Let us define a partial parametrization of the link $\gamma_k^\pm : A_k \rightarrow L(P_i)$ for $1 \leq k \leq \ell + 1$ as

$$\gamma_k^\pm(z) = (c_k(z), \pm \frac{\sqrt{1 - |c_k(z)|^2}}{|\dot{c}_k(z)|} \cdot \dot{c}_k(z)).$$

Remark that $j(\gamma_k^\pm(z)) = \gamma_k^\mp(z)$. At this time, we have the oriented smooth parametrization of the link $L(P_i)$ as follows. Note that we can extend the parametrization to cusps smoothly.

At first, suppose that the number of cusps ℓ is odd. Let us define $\Gamma : S^1 \rightarrow L(P_i)$ as follows:

$$\Gamma(z) = \begin{cases} \gamma_k^+(z^2) & (z \in A_{2k+1} \text{ and } 0 \leq \arg z \leq \pi, z \in A_{2k} \text{ and } \pi \leq \arg z \leq 2\pi), \\ \gamma_k^-(z^2) & (z \in A_{2k} \text{ and } 0 \leq \arg z \leq \pi, z \in A_{2k+1} \text{ and } \pi \leq \arg z \leq 2\pi). \end{cases}$$

This gives an oriented parametrization of $L(P_i)$. By applying the involution, we have

$$j(\Gamma(z)) = \begin{cases} \gamma_k^-(z^2) & (z \in A_{2k+1} \text{ and } 0 \leq \arg z \leq \pi, z \in A_{2k} \text{ and } \pi \leq \arg z \leq 2\pi), \\ \gamma_k^+(z^2) & (z \in A_{2k} \text{ and } 0 \leq \arg z \leq \pi, z \in A_{2k+1} \text{ and } \pi \leq \arg z \leq 2\pi). \end{cases}$$

thus $j(\Gamma(z)) = \Gamma(-z)$. Since the correspondence $z \mapsto -z$ preserves the orientation, the associated link $L(P_i)$ is 2-periodic if the number of cusps is odd.

Next, suppose that the number of cusps ℓ is even. In this case, the link $L(P_i)$ consists of two components, and we denote by L_1 and L_2 . First, we give an oriented parametrization $\Gamma : S^1 \rightarrow L_1$ as follows.

$$\Gamma_1(z) = \begin{cases} \gamma_k^+(z) & (z \in A_{2k+1}) \\ \gamma_k^-(z) & (z \in A_{2k}) \end{cases}$$

Under fixing the orientation for L_1 , we can choose two orientations for another component L_2 . First, define an oriented parametrization $\Gamma_2 : S^1 \rightarrow L_2$ as follows.

$$\Gamma_2(t) = \begin{cases} \gamma_k^-(z) & (z \in A_{2k+1}) \\ \gamma_k^+(z) & (z \in A_{2k}) \end{cases}$$

Then, $j(\Gamma_1(z)) = \Gamma_2(z)$ and $j(\Gamma_2(z)) = \Gamma_1(z)$. Therefore, the orientation of the link $L(P_i)$ is preserved by the involution and thus it is a 2-periodic link.

The other oriented parametrization $\Gamma_2 : S^1 \rightarrow L_2$ is defined as follows.

$$\Gamma_2(t) = \begin{cases} \gamma_k^-(\bar{z}) & (z \in A_{2k+1}) \\ \gamma_k^+(\bar{z}) & (z \in A_{2k}) \end{cases}$$

Here, \bar{z} is the complex conjugation of z . This time, $j(\Gamma_1(z)) = \Gamma_2(\bar{z})$ and $j(\Gamma_2(z)) = \Gamma_1(\bar{z})$. Since the correspondence $z \mapsto \bar{z}$ reverses the orientation, the link $L(P_i)$ is a strongly invertible link. \square

Remark 3.8. As in the proof, from a circle component with even cusps, we can obtain either a 2-periodic link or a strongly invertible link. This depends on just the choice of the orientation of the associated link.

4 Main result and examples

In this section, we give the proof of the main theorem. The main theorem is the following.

Theorem 4.1. *A link L in S^3 is described as the associated link of a divide with cusps if and only if there exists an involution j on S^3 which has a non-empty fixed point set such that $j(L) = L$.*

The "only if" part is nothing but Proposition 3.6. Thus, it suffices to prove the following theorem.

Theorem 4.2. *Suppose that link L satisfies $j(L) = L$ for an involution j on S^3 with a non-empty fixed point set. Then, there exists a divide with cusps P such that $L(P)$ is j -isotopic to L .*

Proof. Let L be a link in S^3 identified with the sphere $S(D^2)$. Suppose that L satisfies $j(L) = L$ for the involution $j(x, v) = (x, -v)$. Let $P = \pi(L)$ be the image by the projection. We can generically suppose that P satisfies the following conditions.

- (i) The image P is a divide with no cusps, i.e., the union of the proper generic immersed curves.
- (ii) For each $x \in P \setminus \partial P$, L intersects to $\pi^{-1}(x)$ transversally.
- (iii) The restriction $\pi|_{L \cap \pi^{-1}(P_0)} : L \cap \pi^{-1}(P_0) \rightarrow P_0$ is a branched 2-fold covering ramified at ∂P_0 , where P_0 is obtained from P by removing its cross points.

Since $\text{Fix}(j) = \partial D^2 \times \{0\}$, a fixed point in the link L by the involution can be written as $(e^{\sqrt{-1}\theta}, 0) \in \text{Fix}(j) \cap L$. The unit tangent vector of L at this point can be expressed as $(0, e^{\sqrt{-1}\psi})$. By rotating around $\text{Fix}(j)$, we can assume that $\psi = \theta + \pi$. Therefore, by performing j -isotopy, we have that the link L coincides to $L(P)$ at the δ neighborhood $\{p \in D^2 \mid |p| \geq 1 - \delta\}$ of ∂D^2 for a sufficiently small value $\delta > 0$.

Next, we consider the neighborhood of the double point of P . Let $x \in P$ be a double point and D_δ be a disk centered at x with the radius δ . Let a_1, a_2, a_3 and a_4 be the intersection of P and ∂D_δ . We suppose that a_i 's are ordered counterclockwisely and $0 \leq \alpha_1 < \alpha_2 < \alpha_3 < \alpha_4 < 2\pi$, where $\alpha_i = \arg(a_i - x)$. We can assume that the intersection $P \cap D_\delta$ is the union of intervals $[a_1, a_3]$ and $[a_2, a_4]$. The link $L \cap \pi^{-1}(D_\delta)$ is expressed as $L \cap \pi^{-1}([a_1, a_3] \cup [a_2, a_4])$, and by moving j -isotopy, each component is described as follows ($i = 1, 2$).

$$L \cap \pi^{-1}([a_i, a_{i+2}]) = \{(x, \pm\theta_i) \mid x \in [a_i, a_{i+2}]\},$$

where $0 \leq \theta_1 < \theta_2 < \pi$. The link $L \cap \pi^{-1}(D_\delta)$ consists of four segments and each component can be parametrized as follows:

$$\gamma_i(s) = (sa_{i+2} + (1-s)a_i, \varepsilon\theta_i)$$

where $0 \leq s \leq 1$, $a_5 = a_1$, $a_6 = a_2$. The signature $\varepsilon = 1$ if $i = 1, 2$ and $\varepsilon = -1$ if $i = 3, 4$. Note that this parametrization may not agree with the original orientation of the link. Then, we can define a j -isotopy $\{\varphi_t\}_{t \in [0,1]}$ as follows.

$$\varphi_t(\gamma_i(s)) = ((sa_{i+2} + (1-s)a_i), (1-t)\varepsilon\theta_i + t\alpha_i)$$

It follows that $\varphi_0(\gamma_i(s)) = \gamma_i(s)$ and $\varphi_1(\gamma_i(s)) = (sa_{i+2} + (1-s)a_i, \alpha_i)$. Therefore, the link $L \cap \pi^{-1}(D_\delta)$ coincides with the divide link $L(P)$ up to j -isotopy (see Figure 4).

Let P' be the set obtained from P by removing all the δ -neighborhoods of crossing points and δ -neighborhood of ∂D^2 . The set P' is the union of finite embedded intervals and embedded circles. Let E be a connected component of P' and suppose that E is an interval. The link $L \cap \pi^{-1}(E)$ lives in the annulus $\pi^{-1}(E) \cong E \times S^1$ and $L \cap \pi^{-1}(E)$ coincides with $L(P')$ at the boundary $L \cap \pi^{-1}(\partial E)$.

Let Φ be a self homeomorphism of $\pi^{-1}(E)$ defined by a half twist of $\pi^{-1}(E)$. Then, there exists an integer n such that $L \cap \pi^{-1}(E)$ is equivalent to $\Phi^n(L(P) \cap \pi^{-1}(E))$. Bringing half twists to the link of a divide corresponds to adding cusps to the divide as noted in Remark 2.6. Let E' be the interval with the corresponding cusp added. Then, the link $L \cap \pi^{-1}(E)$ coincides with the associated link of $L(E')$. (see Figure 10)

When E is an embedded circle component, by a similar argument, it follows that the link $L \cap \pi^{-1}(E)$ coincides with the associated link of a divide with finite cusps added. Let \overline{P} be the resulting divide with cusps, obtained from P by adding finite cusps according to all the previous procedures. Then, the link L coincides with the associated link $L(\overline{P})$. \square

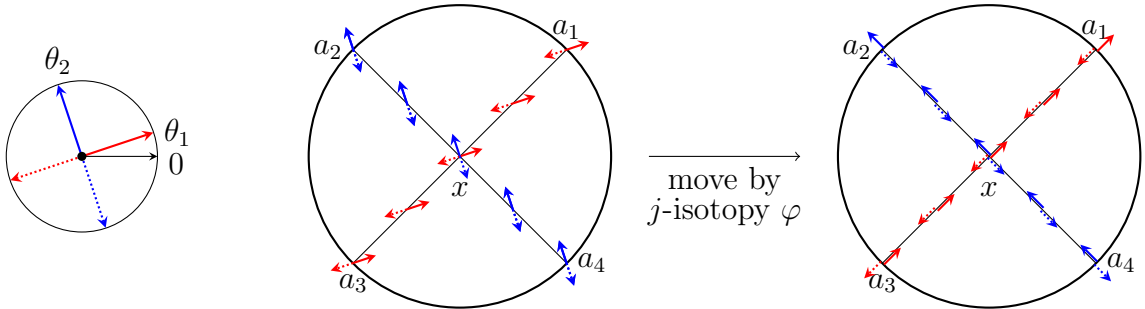

Figure 9: Around the double point

As the special cases of the result, we have the following corollaries by combining Proposition 3.7 and Theorem 4.1.

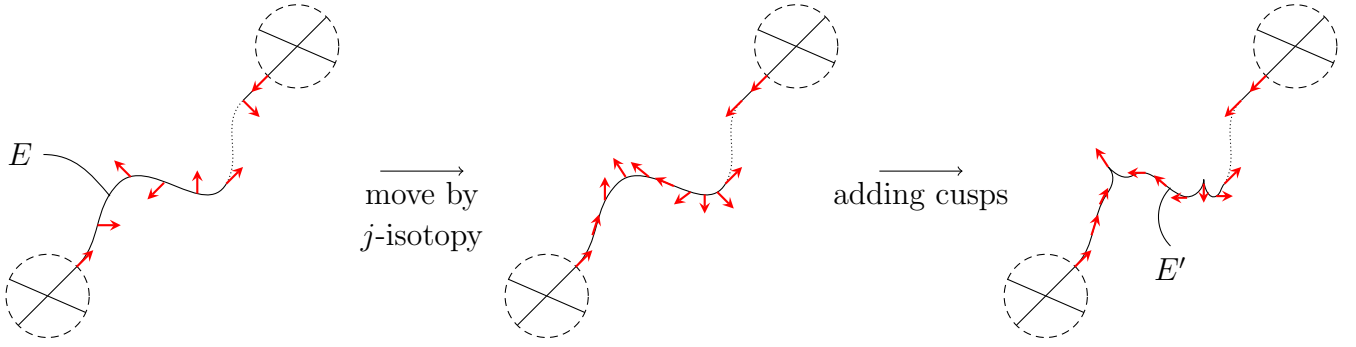

Figure 10: The interval component

Corollary 4.3. *Every strongly invertible link is described as the associated link of a divide with cusps. Particularly, it is the associated link of a divide with cusps consisting of interval components and circle components with even cusps.*

Corollary 4.4. *Every 2-periodic link is described as the associated link of a divide with cusps. Particularly, it is the associated link of a divide with cusps consisting of circle components.*

Let us consider the case where $L = K$ is a knot in S^3 . If a knot K satisfies $j(K) = K$, K is either a strongly invertible knot or a 2-periodic knot. Thus, we have the following theorem as the specialization of the main result.

Theorem 4.5. *A knot K is described as the associated link of a divide with cusps if and only if K is either a strongly invertible knot or 2-periodic knot.*

Remark 4.6. A signed divide, which is introduced by Couture [Co], can be considered as the special case of the divide with cusps. In fact, equipping a negative sign to a crossing point corresponds to adding some cusps. The rule of adding cusps is as in Figure 11. If we give a negative sign to a double point as in (1) in Figure 11, then the diagram of the associated link is locally drawn as in (2), applying Hirasawa's algorithm. It can be projected to the diagram in the plane as in (3) by a small perturbation. Here, we rotate the angle of the cylinder so that the branch of $-\pi/4$ is at the top. Moving by isotopy, it can be locally described as the associated link of a divide with cusps, by adding cusps appropriately around the double point as (4).

Couture proved that every strongly invertible link is described as the associated link of a signed divide ([Co], Proposition 1.10). Therefore, our main result is the generalization of this proposition.

Example 4.7. For $n \geq 1$, let $T(2, 2n + 1)$ be a $(2, 2n + 1)$ -torus knot. There are two involutions j_1, j_2 of S^3 such that $(T(2, 2n + 1), j_1)$ is strongly invertible and $(T(2, 2n + 1), j_2)$ is 2-periodic. Both links are described as the associated link of divides with cusps as in Figure 12.

Example 4.8. In [Sa], Sakuma gave some explicit descriptions of strongly invertible knots, and they are written as $I_1(\alpha_1, \dots, \alpha_n; c_1, \dots, c_n)$ and $I_2(a_1, \dots, a_n)$ (see Figure 13), where each α_i, c_i, a_i is a non-negative integer and a_i is even. By using this diagram, we can see that a divide with cusps whose link is such a strongly invertible knot is described in Figure 14 and 15.

A 2-bridge knot can be described by using this notation and it is known that a 2-bridge knot has exactly two symmetries such that it is strongly invertible (Proposition 3.6 in [Sa]). A 2-bridge knot is expressed as by using a Conway notation $C(a_1, \dots, a_n)$ for even numbers a_i . One of the strongly invertible knots defined by $C(a_1, \dots, a_n)$ is described in Figure 16, and the corresponding divide with cusps whose link is $C(a_1, \dots, a_n)$ is as in Figure 17.

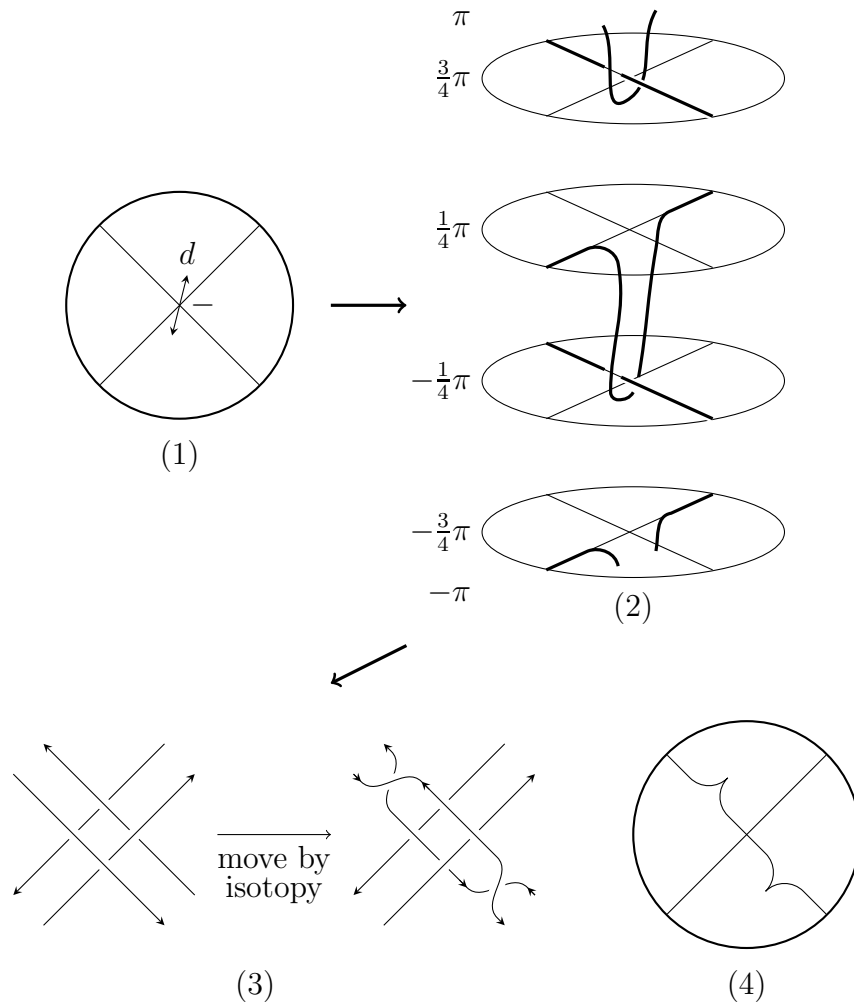

Figure 11: A negative sign of a signed divide and cusps in a divide with cusps

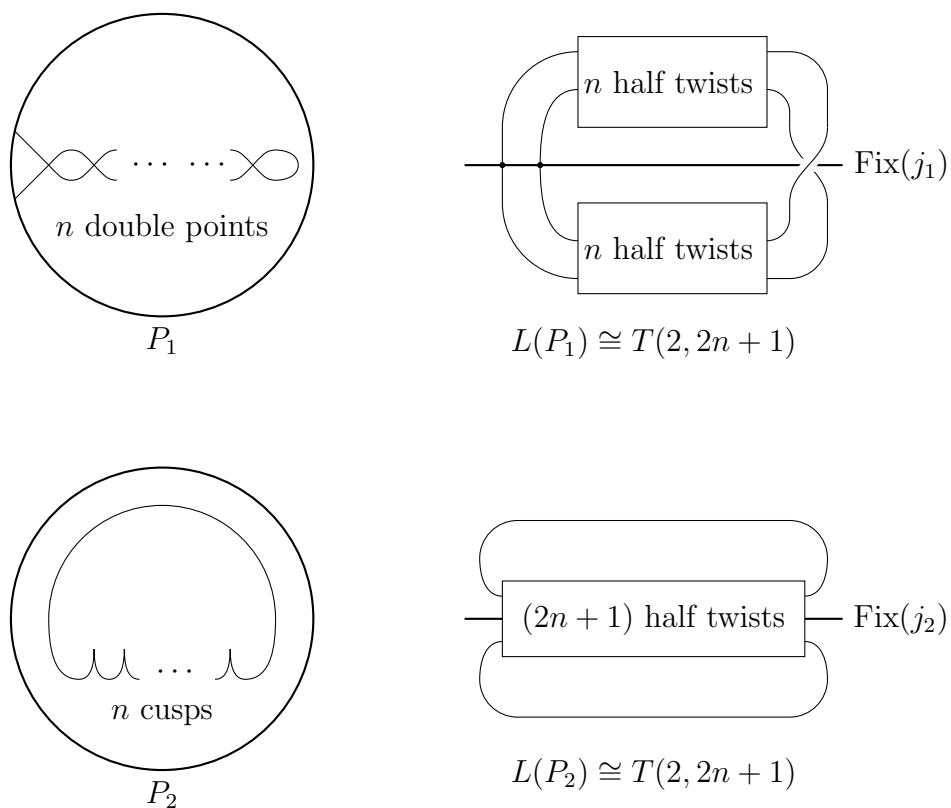

Figure 12: Two symmetries of the $(2, 2n + 1)$ -torus knot and divides with cusps

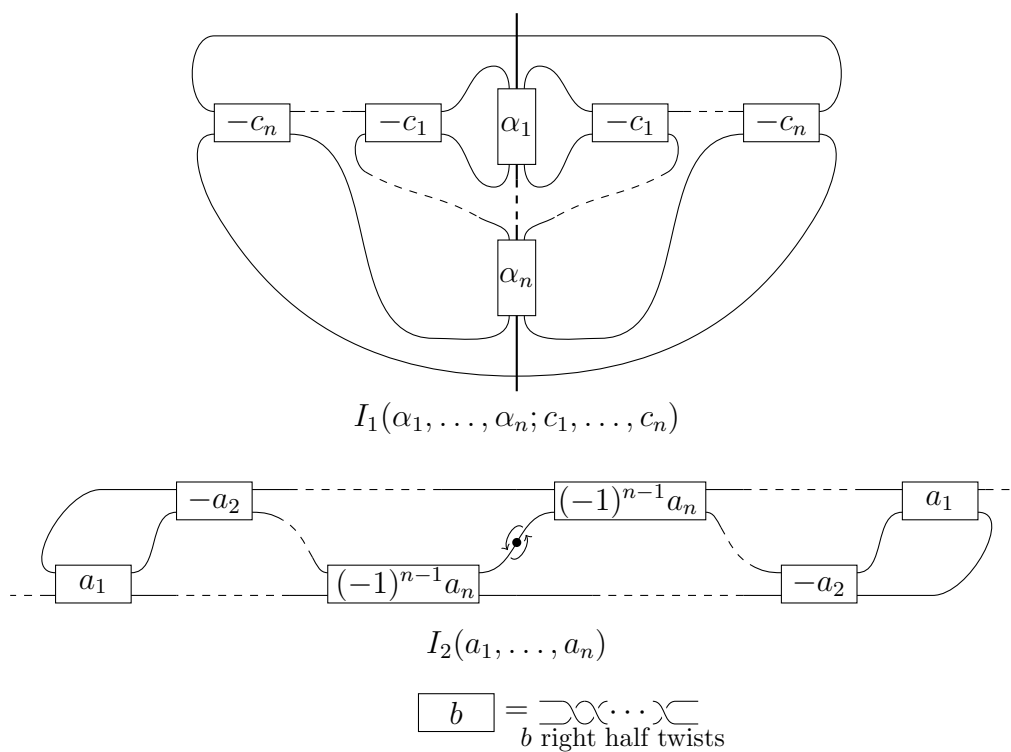

Figure 13: Knot diagrams of $I_1(\alpha_1, \dots, \alpha_n; c_1, \dots, c_n)$ and $I_2(a_1, \dots, a_n)$

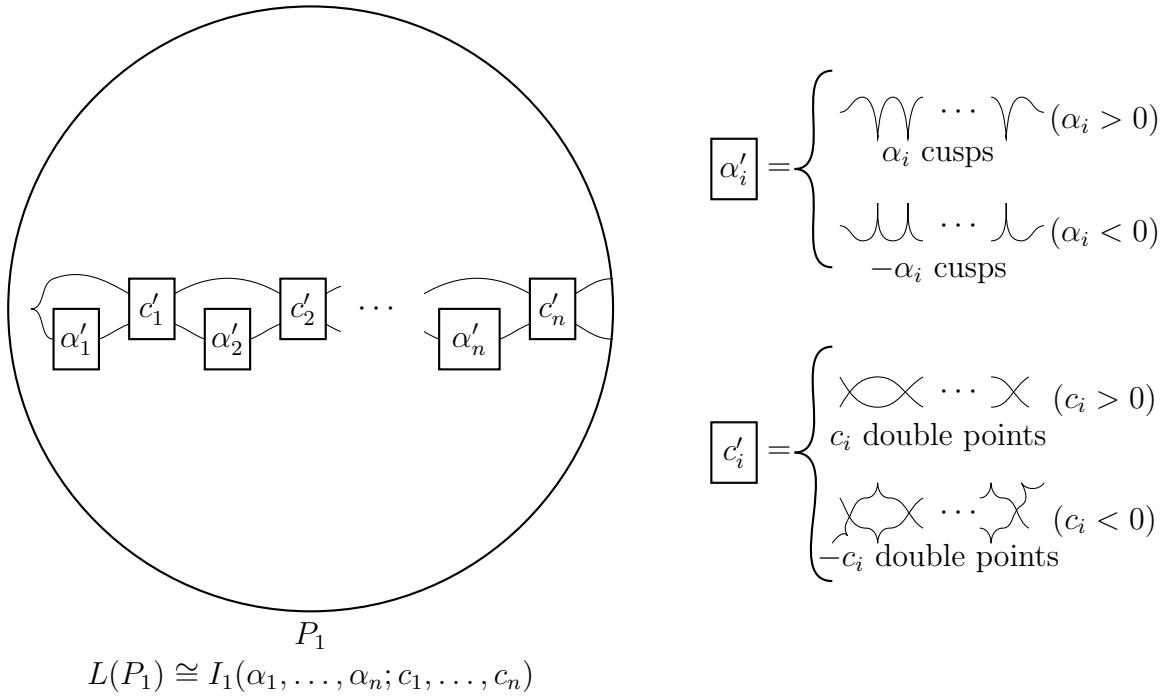

Figure 14: A divide whose associated link is $I_1(\alpha_1, \dots, \alpha_n; c_1, \dots, c_n)$

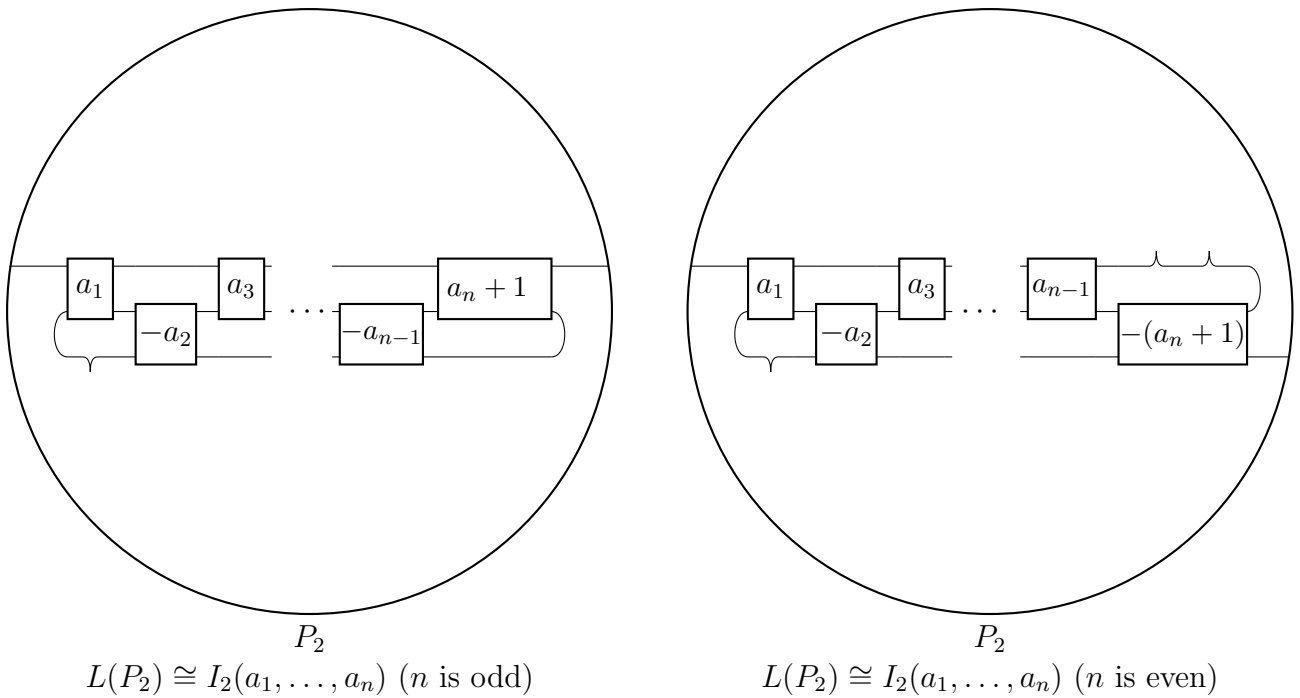

Figure 15: A divide whose associated link is $I_2(a_1, \dots, a_n)$

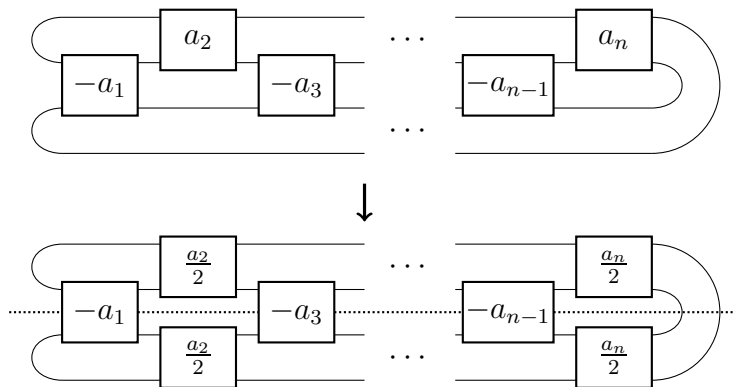

Figure 16: The diagram of a 2-bridge knot $C(a_1, \dots, a_n)$

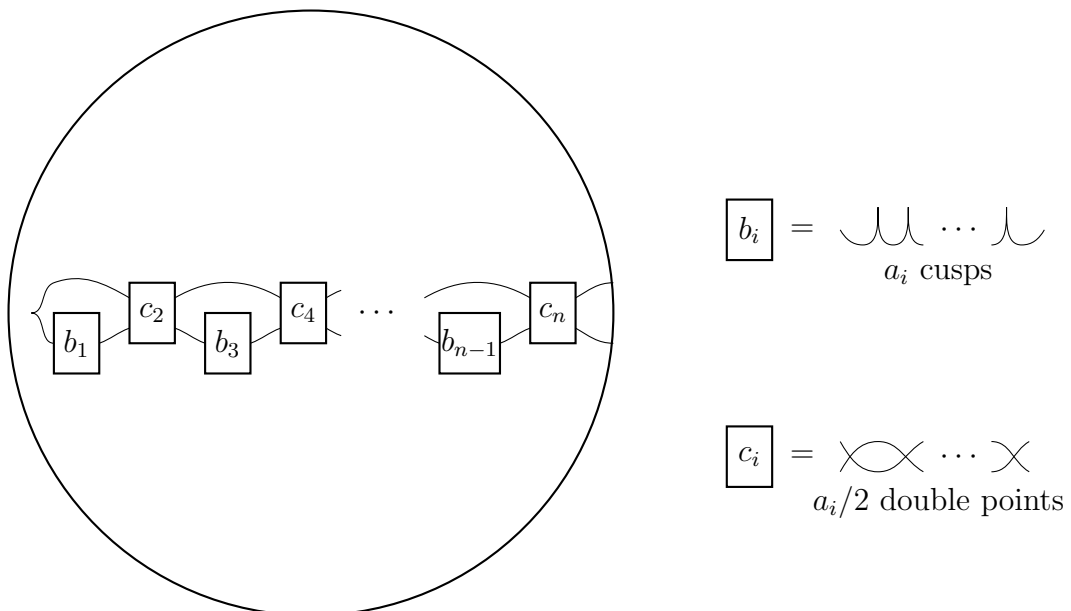

Figure 17: A divide with cusps whose link is $C(a_1, \dots, a_n)$

References

- [AC1] N. A'Campo, Real deformations and complex topology of plane curve singularities, *Ann. Fac. Sci. Toulouse* 8 (1999) 5-23.
- [AC2] N. A'Campo, Generic immersions of curves, knots, monodromy and Gordian number. *Inst. Hautes Études Sci. Publ. Math.* No. 88 (1998), 151-169 .
- [Co] O. Couture, Strongly invertible links and signed divides, *J. Topology*, **47** (2008), 316-150.
- [CP] O. Couture, B. Perron, Representative braids for links associated to plane immersed curves. *J. Knot Theory Ramifications* **9** (2000), no. 1, 1-30.
- [FK] R. Furutani, Y. Koda, Divides and hyperbolic volumes, preprint, arXiv:2306.12631
- [GI1] W. Gibson, M. Ishikawa, Links and Gordian numbers associated with generic immersions of intervals. *Topology Appl.* **123** (2002), no. 3, 609-636.
- [GI2] W. Gibson, M. Ishikawa, Links of oriented divides and fibrations in link exteriors. *Osaka J. Math.* **39** (2002), no. 3, 681-703.
- [Hi] M. Hirasawa, Visualization of A'Campo's fibered links and unknotting operation, *Topology Appl.* , **121** (2002) 287-304.
- [I] M. Ishikawa, Tangent circle bundles admit positive open book decompositions along arbitrary links, *Topology*, **43**, 2004, 215-232.
- [IN] M. Ishikawa, H. Naoe, Milnor fibration, A'Campo's divide and Turaev's shadow, Singularities-Kagoshima 2017, *Proceedings of the 5th Franco-Japanese-Vietnamese Symposium on Singularities*, World Scientific Publishing, 2020, 71-93.
- [Ka1] T. Kawamura, Quasipositivity of links of divides and free divides, *Topology. App.* , **125** (2002), 111-123.
- [Ka2] T. Kawamura, Links associated with generic immersions of graphs, *Algebr. Geom. Topol.* **4** (2004), 571-594.
- [MB] J.W. Morgan, H. Bass, The Smith Conjecture, New York, 1979, Pure Appl. Math., **112**, Academic Press, Orlando, FL, 1984.
- [Sa] M. Sakuma, On strongly invertible knots, Algebraic and topological theories (Kinosaki, 1984), 176-196, Kinokuniya, Tokyo, 1986.
- [SY] S. Sugawara, M. Yoshinaga, Divides with cusps and Kirby diagrams for line arrangements, *Topology Appl.* **313** (2022), Paper No. 107989