

# On Locally Identifying Coloring of Cartesian Product and Tensor Product of Graphs

Sriram Bhyravarapu<sup>1</sup>, Swati Kumari<sup>2</sup> and I. Vinod Reddy<sup>2</sup>

<sup>1</sup> The Institute of Mathematical Sciences, HBNI, Chennai, India  
 sriramb@imsc.res.in

<sup>2</sup> Department of Computer Science and Engineering, IIT Bhilai, India  
 swatik@iitbhilai.ac.in, vinod@iitbhilai.ac.in

**Abstract.** For a positive integer  $k$ , a proper  $k$ -coloring of a graph  $G$  is a mapping  $f : V(G) \rightarrow \{1, 2, \dots, k\}$  such that  $f(u) \neq f(v)$  for each edge  $uv \in E(G)$ . The smallest integer  $k$  for which there is a proper  $k$ -coloring of  $G$  is called chromatic number of  $G$ , denoted by  $\chi(G)$ . A *locally identifying coloring* (for short, lid-coloring) of a graph  $G$  is a proper  $k$ -coloring of  $G$  such that every pair of adjacent vertices with distinct closed neighborhoods has distinct set of colors in their closed neighborhoods. The smallest integer  $k$  such that  $G$  has a lid-coloring with  $k$  colors is called *locally identifying chromatic number* (for short, *lid-chromatic number*) of  $G$ , denoted by  $\chi_{lid}(G)$ .

In this paper, we study lid-coloring of Cartesian product and tensor product of two graphs. We prove that if  $G$  and  $H$  are two connected graphs having at least two vertices then (a)  $\chi_{lid}(G \square H) \leq \chi(G)\chi(H) - 1$  and (b)  $\chi_{lid}(G \times H) \leq \chi(G)\chi(H)$ . Here  $G \square H$  and  $G \times H$  denote the Cartesian and tensor products of  $G$  and  $H$  respectively. We also give exact values of lid-chromatic number of Cartesian product (resp. tensor product) of two paths, a cycle and a path, and two cycles.

## 1 Introduction

In this paper, we consider finite, undirected and simple graphs. For a graph  $G = (V, E)$ , the vertex set and edge set of  $G$  are denoted by  $V(G)$  and  $E(G)$  respectively. The neighborhood  $N(v)$  of a vertex  $v$  in a graph  $G$  is the set of vertices adjacent to  $v$  in  $G$  and  $N[v] = N(v) \cup \{v\}$  denotes closed neighborhood of  $v$ . For a positive integer  $k$ , a  $k$ -coloring of a graph  $G$  is a function  $f : V(G) \rightarrow \{1, 2, \dots, k\}$ . A  $k$ -coloring of a graph  $G$  is called proper  $k$ -coloring, if  $f(u) \neq f(v)$  for each edge  $uv$  of  $G$ . The chromatic number  $\chi(G)$  of a graph  $G$  is the minimum  $k$  for which there is a proper  $k$ -coloring of  $G$ . For a  $k$ -coloring  $f$  of a graph  $G$  and  $X \subseteq V(G)$ ,  $f(X) = \{f(v) \mid v \in X\}$ .

Given a graph  $G = (V, E)$  and a positive integer  $k$ , a proper  $k$ -coloring  $f$  is called a locally identifying coloring, if for every edge  $uv \in E(G)$  with  $N[u] \neq N[v]$ , we have  $f(N[u]) \neq f(N[v])$ . The smallest integer  $k$  such that there is a locally identifying coloring of  $G$  using  $k$  colors is called locally identifying chromatic number of  $G$  (or lid-chromatic number), denoted by  $\chi_{lid}(G)$ . In

this paper, we consider only connected graphs since the lid-chromatic number of a graph  $G$  is the maximum of the lid-chromatic numbers of its connected components.

Locally identifying coloring was introduced by Esperet et al. [1] in which they gave several bounds on lid-chromatic number for different families of graphs, such as planar graphs, subclasses of perfect graphs and graphs with bounded maximum degree. They proved that for any bipartite graph  $G$ ,  $\chi_{lid}(G) \leq 4$  and deciding whether the lid-chromatic number of a bipartite graph is 3 or 4 is an NP-complete problem. Foucaud et al. [2] showed that any graph  $G$  with maximum degree  $\Delta$  has a locally identifying coloring with at most  $2\Delta^2 - 3\Delta + 3$  colors. Goncalves et al. [3] showed that for any planar graph  $G$ ,  $\chi_{lid}(G) \leq 1280$ . They also proved that for any graph class of bounded expansion, the lid-chromatic number is bounded. Martins and Sampaio [5] obtained linear time algorithms to calculate the lid-chromatic number for some classes of graphs having few  $P_4$ 's. We now formally introduce the definitions of Cartesian product and tensor product of graphs.

**Definition 1 (Cartesian product [4]).** *Cartesian product  $G \square H$  of graphs  $G$  and  $H$  is a graph such that  $V(G \square H) = V(G) \times V(H) = \{(u, v) \mid u \in V(G), v \in V(H)\}$ , and two vertices  $(u_1, v_1)$  and  $(u_2, v_2)$  in  $G \square H$  are adjacent if and only if either  $u_1 = u_2$  and  $v_1 v_2 \in E(H)$  or  $v_1 = v_2$  and  $u_1 u_2 \in E(G)$ .*

**Definition 2 (Tensor product [4]).** *Tensor product  $G \times H$  of graphs  $G$  and  $H$  is a graph such that  $V(G \times H) = V(G) \times V(H)$  and two vertices  $(u_1, v_1)$  and  $(u_2, v_2)$  in  $G \times H$  are adjacent if and only if  $u_1 u_2 \in E(G)$  and  $v_1 v_2 \in E(H)$ .*

Notice that both Cartesian product and tensor product are commutative. That is for any two graphs  $G$  and  $H$  we have  $G \square H \cong H \square G$  and  $G \times H \cong H \times G$ .

Proper coloring has been well studied with respect to various graph products, whereas lid-coloring has not received enough attention. The chromatic number of the Cartesian product of two graphs  $G$  and  $H$  is equal to the maximum of chromatic numbers of  $G$  and  $H$  [6]. The chromatic number of the tensor product of two graphs  $G$  and  $H$  is at most the chromatic numbers of graphs  $G$  and  $H$  [7].

In this paper, we investigate the lid-chromatic number of Cartesian product and tensor product of graphs. In Section 3, we prove that if  $G$  and  $H$  are two connected graphs having at least two vertices, then  $\chi_{lid}(G \square H) \leq \chi(G)\chi(H) - 1$ . We give exact values of the lid-chromatic number of the Cartesian product of (a) a cycle and a path, and (b) two cycles.

In Section 4, we prove that if  $G$  and  $H$  are two connected graphs having at least two vertices then  $\chi_{lid}(G \times H) \leq \chi(G)\chi(H)$ . We also give exact values of the lid-chromatic number of the tensor product of (a) two paths, (b) a cycle and a path, and (c) two cycles.

## 2 Preliminaries

We use  $[k]$  to denote the set  $\{1, 2, \dots, k\}$ . For a positive integer  $n$ , we use  $P_n$  to denote a path on  $n$  vertices and  $C_n$  to denote a cycle on  $n$  vertices. Given

a graph  $G$  and a subset  $X \subseteq V(G)$ , we use  $G[X]$  to denote the subgraph of  $G$  induced by the vertices of  $X$ .

**Lemma 1** ([2]). *For a positive integer  $n$ , where  $n \geq 2$ , we have*

$$\chi_{lid}(P_n) = \begin{cases} 2 & \text{if } n = 2; \\ 3 & \text{if } n \text{ is odd}; \\ 4 & \text{if } n \text{ is even and } n \neq 2; \end{cases}$$

**Lemma 2** ([2]). *For a positive integer  $n$ , where  $n \geq 3$ , we have*

$$\chi_{lid}(C_n) = \begin{cases} 3 & \text{if } n = 3 \text{ or } n \equiv 0 \pmod{4}; \\ 5 & \text{if } n = 5 \text{ or } 7; \\ 4 & \text{otherwise}; \end{cases}$$

Next, we review some existing results from [1] that are used to prove some of our results.

**Lemma 3** ([1]). *If a connected graph  $G$  satisfies  $\chi_{lid}(G) \leq 3$ , then  $G$  is either a triangle or a bipartite graph.*

**Theorem 1** ([1]). *If  $G$  is a bipartite graph, then  $\chi_{lid}(G) \leq 4$ .*

**Theorem 2** ([1]). *For  $k \geq 4$ , a  $k$ -regular graph is 3-lid-colorable if and only if it is bipartite.*

**Theorem 3** ([1]). *If  $G$  and  $H$  are bipartite graphs without isolated vertices, then  $\chi_{lid}(G \square H) = 3$ .*

**Lemma 4** ([1]). *A connected graph  $G$  is 2-lid-colorable if and only if  $G$  has at most two vertices.*

Lid-coloring is not monotone under taking subgraphs that is if  $H$  is a subgraph of  $G$  then lid-chromatic number of  $H$  may be more than lid-chromatic number of  $G$ .

### 3 Cartesian product

In this section, we provide an upper bound on the lid-chromatic number of Cartesian product of two arbitrary graphs. Next, we give exact values of the lid-chromatic number of Cartesian product of (a) a cycle and a path, and (b) two cycles.

### 3.1 Cartesian product of two arbitrary graphs

**Lemma 5.** *Let  $G$  and  $H$  be two connected graphs having at least two vertices. If  $(u_1, v_1)$  and  $(u_2, v_2)$  are two adjacent vertices in  $G \square H$ , then we have  $N[(u_1, v_1)] \neq N[(u_2, v_2)]$ .*

*Proof.* Let  $(u_1, v_1)$  and  $(u_2, v_2)$  be two adjacent vertices in  $G \square H$ . Then we have either (a)  $u_1 = u_2$  and  $v_1 v_2 \in E(H)$  or (b)  $v_1 = v_2$  and  $u_1 u_2 \in E(G)$

**Case 1:**  $u_1 = u_2$  and  $v_1 v_2 \in E(H)$ .

As  $G$  is connected and  $|V(G)| \geq 2$ , there exists a vertex  $u_3 \in N(u_1)$ . It is easy to see that  $(u_1, v_1)(u_3, v_1) \in E(G \square H)$  and  $(u_2, v_2)(u_3, v_1) \notin E(G \square H)$ . That is  $(u_3, v_1) \in N[(u_1, v_1)]$  and  $(u_3, v_1) \notin N[(u_2, v_2)]$ . Hence,  $N[(u_1, v_1)] \neq N[(u_2, v_2)]$ .

**Case 2:**  $v_1 = v_2$  and  $u_1 u_2 \in E(G)$ .

The proof of this case is similar to the proof of Case 1. □

**Theorem 4.** *Let  $G$  and  $H$  be two connected graphs having at least two vertices. Then,  $\chi_{lid}(G \square H) \leq \chi(G)\chi(H)$ .*

*Proof.* Let  $\chi(G) = k_1 \geq 2$  and  $\chi(H) = k_2 \geq 2$ . Let  $f_G : V(G) \rightarrow [k_1]$  and  $f_H : V(H) \rightarrow [k_2]$  are proper colorings of  $G$  and  $H$  respectively. Using the colorings  $f_G$  and  $f_H$ , we construct a lid-coloring of  $G \square H$ . Define a coloring  $g : V(G \square H) \rightarrow [k_1] \times [k_2]$  such that for each  $(u, v) \in V(G \square H)$ ,  $g((u, v)) = (f_G(u), f_H(v))$ . Now, we show that  $g$  is a lid-coloring of  $G \square H$ .

Let  $(u_1, v_1)$  and  $(u_2, v_2)$  be two adjacent vertices of  $G \square H$ . We know that either (a)  $u_1 = u_2$  and  $v_1 v_2 \in E(H)$  or (b)  $v_1 = v_2$  and  $u_1 u_2 \in E(G)$

**Case 1:**  $u_1 = u_2$  and  $v_1 v_2 \in E(H)$ .

In this case  $g((u_1, v_1)) \neq g((u_1, v_2))$  because  $f_H(v_1) \neq f_H(v_2)$ . From Lemma 5, we know that  $N[(u_1, v_1)] \neq N[(u_1, v_2)]$  and  $(u_3, v_1) \in N[(u_1, v_1)] \setminus N[(u_1, v_2)]$ . Notice that  $g((u_3, v_1)) = (f_G(u_3), f_H(v_1))$ . It is easy to see that the color  $g((u_3, v_1))$  is not assigned to any vertex of  $N[(u_1, v_2)]$ . That is  $g(N[(u_1, v_1)]) \neq g(N[(u_1, v_2)])$ .

**Case 2:**  $v_1 = v_2$  and  $u_1 u_2 \in E(G)$ .

The proof of this case is similar to the proof of Case 1. □

The bound presented in the above theorem can be improved by merging two distinct color classes to a single color class.

**Corollary 1.** *Let  $G$  and  $H$  be two connected graphs having at least two vertices such that  $\chi(G) = k_1$  and  $\chi(H) = k_2$ . Then,  $\chi_{lid}(G \square H) \leq k_1 k_2 - 1$ .*

*Proof.* Let  $g$  be a lid-coloring of  $G \square H$  as defined in Theorem 4. We define a coloring  $f : V(G \square H) \rightarrow ([k_1] \times [k_2]) \setminus (k_1, k_2)$ . as follows.

$$f((u, v)) = \begin{cases} g((u, v)) & \text{if } g((u, v)) \neq (k_1, k_2); \\ (1, 1) & \text{if } g((u, v)) = (k_1, k_2); \end{cases}$$

We show that  $f$  is a lid-coloring of  $G \square H$ . Let  $e = (u_1, v_1)(u_2, v_2)$  be an arbitrary edge of  $G \square H$ . That is either (a)  $u_1 = u_2$  and  $v_1 v_2 \in E(H)$  or (b)  $v_1 = v_2$  and  $u_1 u_2 \in E(G)$ .

**Case 1:**  $u_1 = u_2$  and  $v_1 v_2 \in E(H)$ .

Let  $e = (u_1, v_1)(u_1, v_2)$  be an arbitrary edge of  $G \square H$ . If  $g((u_1, v_1))$  and  $g((u_1, v_2))$  is not equal to  $(k_1, k_2)$  then clearly  $f((u_1, v_1)) \neq f((u_1, v_2))$ . Suppose  $g((u_1, v_1)) = (k_1, k_2)$  and  $g((u_1, v_2)) = (k_1, p)$ , where  $p \neq k_2$ . Then  $f((u_1, v_1)) = (1, 1)$  and  $f((u_1, v_2)) = (k_1, p)$ . As  $k_1 \neq 1$ ,  $f((u_1, v_1)) \neq f((u_1, v_2))$ .

From Lemma 5, we know that  $N[(u_1, v_1)] \neq N[(u_1, v_2)]$ . If  $(k_1, k_2) \notin g(N[(u_1, v_1)] \cup N[(u_1, v_2)])$  then clearly we have  $f(N[(u_1, v_1)]) \neq f(N[(u_1, v_2)])$ . Suppose  $g((u_1, v_1)) = (k_1, k_2)$  and  $g((u_1, v_2)) = (k_1, p)$ , where  $p \neq k_2$ . Then  $f((u_1, v_1)) = (1, 1)$ ,  $f((u_1, v_2)) = (k_1, p)$ . As  $G$  is connected, there exists vertex  $u_3 \in V(G)$  such that  $u_1 u_3 \in E(G)$ . Clearly the vertex  $(u_3, v_1)$  is adjacent to  $(u_1, v_1)$  and not adjacent to  $(u_1, v_2)$ , and  $f((u_3, v_1)) = (q, k_2)$ , where  $q \neq k_1$ . Notice that the color  $(q, k_2) \in f(N[(u_1, v_1)]) \setminus f(N[(u_1, v_2)])$  as  $q \neq k_1$  and  $p \neq k_2$ .

Similarly, we can show that  $f(N[(u_1, v_1)]) \neq f(N[(u_1, v_2)])$  for the case when  $g((u_1, v_1))$  and  $g((u_1, v_2))$  not equal to  $(k_1, k_2)$  but  $(k_1, k_2) \in g(N[(u_1, v_1)] \cup N[(u_1, v_2)])$ .

**Case 2:**  $v_1 = v_2$  and  $u_1 u_2 \in E(G)$ .

The proof of this case is similar to the proof of Case 1. □

The bound given in the above corollary is sharp when  $G = C_3$  and  $H = C_4$  as  $\chi_{lid}(C_3 \square C_4) = 5$  (see Fig 2),  $\chi(C_3) = 3$  and  $\chi(C_4) = 2$ .

### 3.2 Cartesian product of a cycle and a path

Esperet et al. [1] showed that for any two bipartite graphs  $G$  and  $H$  without isolated vertices,  $\chi_{lid}(G \square H) = 3$ . As a corollary, we can see that the lid-chromatic number of Cartesian product of two paths is three.

Taking the work forward, we study lid-coloring of Cartesian product of a path and a cycle, and Cartesian product of two cycles.

**Theorem 5.** *For every pair of positive integers  $m$  and  $n$ , where  $m \geq 3$ ,  $n \geq 2$ , we have*

$$\chi_{lid}(C_m \square P_n) = \begin{cases} 5 & \text{if } m = 3 \text{ and } n \geq 2 \\ 4 & \text{if } m \text{ is odd, } m \geq 5 \text{ and } n \geq 2 \\ 3 & \text{if } m \text{ is even and } n \geq 2 \end{cases}$$

*Proof.* We divide the proof into three cases as described below.

**Case 1:** When  $m = 3$  and  $n \geq 2$ .

Let  $G = C_3 \square P_n$ ,  $V(C_3) = \{u_1, u_2, u_3\}$ ,  $V(P_n) = \{v_1, v_2, \dots, v_n\}$  and  $V(G) = \{(u_1, v_i), (u_2, v_i), (u_3, v_i) \mid i \in [n]\}$ . A 5-lid-coloring of  $C_3 \square P_n$  is illustrated in Fig 1a. Thus  $\chi_{lid}(C_3 \square P_n) \leq 5$ .

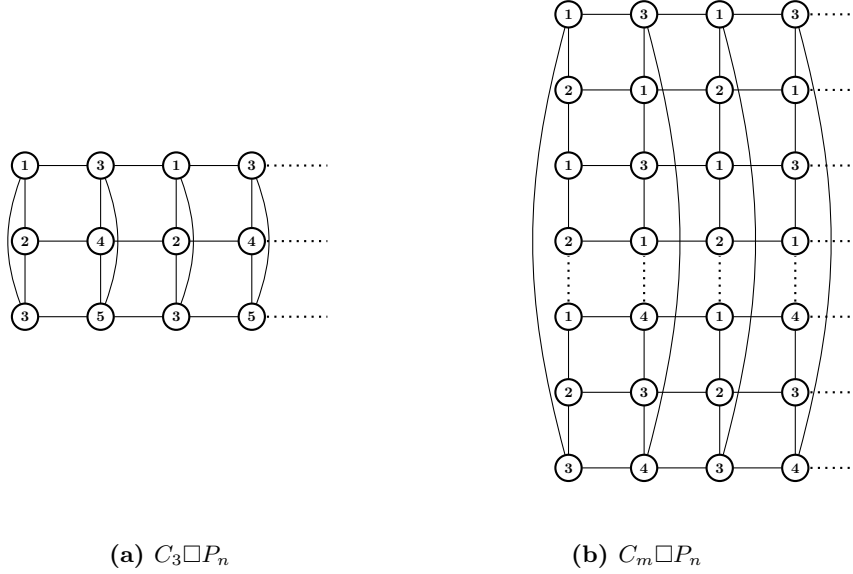

**Fig. 1** (a) A 5-lid coloring of  $C_3 \square P_n$  for  $n \geq 2$ , and (b) A 4-lid coloring of  $C_m \square P_n$ , when  $m$  is odd,  $m \geq 5$  and  $n \geq 2$ .

Next, we show that  $\chi_{lid}(G) \geq 5$ . Let  $X = \{(u_1, v_1), (u_2, v_1), (u_3, v_1)\}$ . Clearly the graph  $G[X]$  induced by vertices of  $X$ , is isomorphic to  $C_3$ , and hence  $\chi_{lid}(G) \geq 3$ . From Lemma 5, every pair of vertices  $u, v \in X$  have distinct closed neighborhoods. Hence, to maintain distinct set of colors in  $N[u]$  and  $N[v]$  at least two new colors must be assigned to the vertices of  $\{(u_1, v_2), (u_2, v_2), (u_3, v_2)\}$ . Therefore, any lid-coloring of  $G$  uses at least 5 colors. Thus  $\chi_{lid}(G) = 5$ .

**Case 2:** When  $m \geq 5$  is odd and  $n \geq 2$ .

A 4-lid coloring of  $C_m \square P_n$  is illustrated in Fig 1b. Hence,  $\chi_{lid}(C_m \square P_n) \leq 4$ . Suppose  $\chi_{lid}(C_m \square P_n) \leq 3$ . Then from Lemma 3,  $C_m \square P_n$  should be either a triangle or a bipartite graph, which is a contradiction. Hence,  $\chi_{lid}(C_m \square P_n) = 4$ .

**Case 3:** When  $m$  is even and  $n \geq 2$ .

Since  $C_m$  and  $P_n$  are bipartite, from Theorem 3, we get  $\chi_{lid}(C_m \square P_n) = 3$ . □

### 3.3 Cartesian product of two cycles

**Lemma 6.** For every positive integer  $n \geq 3$ , we have  $\chi_{lid}(C_3 \square C_n) = 5$ .

*Proof.* A 5-lid coloring of  $C_3 \square C_n$  is illustrated in Fig 2. By following the lines of Case 1 of Theorem 5 we can show that  $\chi_{lid}(C_3 \square C_n) \geq 5$ . Hence, we have  $\chi_{lid}(C_3 \square C_n) = 5$ . □

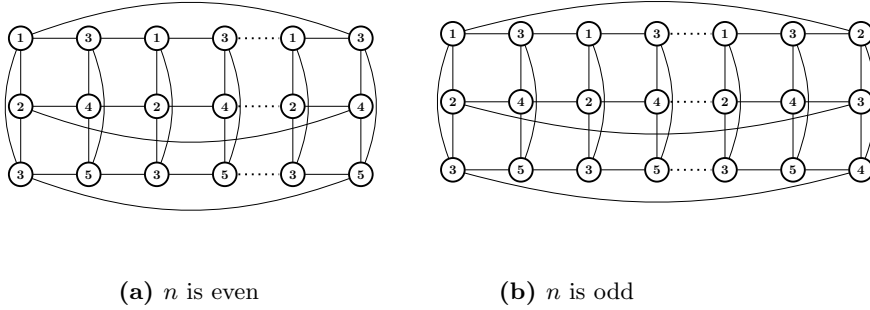

**Fig. 2** A 5-lid coloring of  $C_3 \square C_n$ .

**Lemma 7.** For every pair of even positive integers  $m$  and  $n$  such that  $3 \leq m \leq n$ , we have  $\chi_{lid}(C_m \square C_n) = 3$ .

*Proof.* The proof follows from Theorem 3 as both  $C_m$  and  $C_n$  are bipartite.

**Lemma 8.** If at least one of  $m$  and  $n$  is odd, then  $\chi_{lid}(C_m \square C_n) \geq 4$ .

*Proof.* Suppose that  $\chi_{lid}(C_m \square C_n) \leq 3$ . Then from Lemma 3,  $C_m \square C_n$  is either a triangle or a bipartite graph, which is a contradiction to the fact that  $C_m \square C_n$  is neither a triangle nor bipartite. Thus,  $\chi_{lid}(C_m \square C_n) \geq 4$ .  $\square$

**Lemma 9.** Let  $m \geq 5$  be an odd integer and  $n \geq 4$  be an even integer. Then  $\chi_{lid}(C_m \square C_n) = 4$ .

*Proof.* From Lemma 8 we know that  $\chi_{lid}(C_m \square C_n) \geq 4$ . A 4-lid coloring of  $C_m \square C_n$  is shown in Fig 3. Therefore, we get  $\chi_{lid}(C_m \square C_n) = 4$ .  $\square$

In the rest of this section, we show that  $\chi_{lid}(C_m \square C_n) = 4$  when both  $m \geq 3$  and  $n \geq 3$  are odd.

The following result of Sylvester plays a main role in our proofs.

**Lemma 10 ([8]).** Let  $m$  and  $n$  be two positive integers that are relatively prime. Then for every integer  $k \geq (n-1)(m-1)$ , there exist non-negative integers  $\alpha$  and  $\beta$  such that  $k = \alpha n + \beta m$ .

Suppose  $n = 4$  and  $m = 5$ , then from the above lemma any integer greater than or equal to 12 can be expressed as a linear combination of 4 and 5. From Lemma 7, we know that  $\chi_{lid}(C_4 \square C_4) = 3$ . However, in this section we work with a 4-lid coloring of  $C_4 \square C_4$  illustrated in Fig 4.

We also require a 4-lid-coloring of  $C_4 \square C_5$ ,  $C_5 \square C_4$  and  $C_5 \square C_5$  which are shown in the Fig 4.

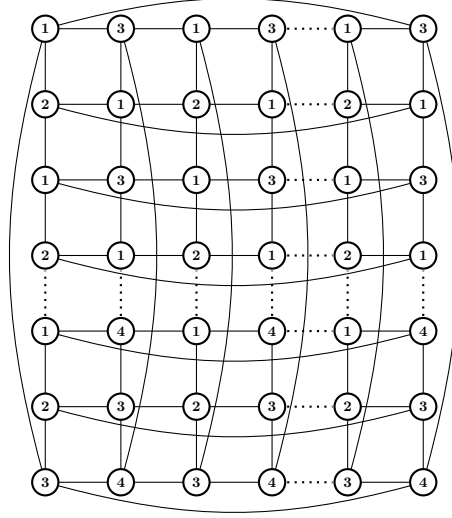

**Fig. 3** A 4-lid coloring of  $C_m \square C_n$ , where  $m(\geq 5)$  is odd and  $n$  is even.

**Lemma 11.** *Let  $m \geq 12$  and  $n \geq 12$  be two odd integers. Then  $\chi_{lid}(C_m \square C_n) = 4$ .*

*Proof.* From Lemma 10, every positive integer  $k \geq 12$  can be expressed as a linear combination of 4 and 5. We try to express  $C_m \square C_n$  in terms of the coloring of  $C_4 \square C_4$ ,  $C_4 \square C_5$ ,  $C_5 \square C_4$ , and  $C_5 \square C_5$ , which are illustrated in Fig 4. Towards this, we observe the following:

- the colors of the first and last columns of  $C_4 \square C_4$  and  $C_4 \square C_5$  are the same,
- the colors of the first two columns of  $C_5 \square C_4$  and  $C_5 \square C_5$  are the same,
- the colors of the first two rows of  $C_4 \square C_4$  and  $C_5 \square C_4$  are the same, and
- the colors of the first two rows of  $C_4 \square C_5$  and  $C_5 \square C_5$  are the same.

Therefore by selecting appropriate copies of  $C_4 \square C_4$ ,  $C_4 \square C_5$ ,  $C_5 \square C_4$  and  $C_5 \square C_5$ , we can obtain 4-lid coloring of  $C_m \square C_n$ . For the convenience of the reader we have showed a 4-lid-coloring of  $C_{13} \square C_{17}$  in Fig 5, which is obtained using  $C_4 \square C_4$ ,  $C_4 \square C_5$ ,  $C_5 \square C_4$  and  $C_5 \square C_5$ .  $\square$

Next, we show that  $\chi_{lid}(C_m \square C_n) = 4$  for all odd positive integers  $5 \leq m \leq n \leq 11$ .

**Lemma 12.** *Let  $5 \leq m \leq n \leq 11$  be two odd integers. Then  $\chi_{lid}(C_m \square C_n) = 4$ .*

*Proof.* From Lemma 8 we know that  $\chi_{lid}(C_m \square C_n) \geq 4$ . We have illustrated 4-lid colorings of  $C_m \square C_n$  for all  $m, n \in \{5, 7, 9, 11\}$  in Fig 4(d), Fig 9, Fig 10, Fig 11 and Fig 12.  $\square$



**Theorem 6.** For every pair of integers  $m$  and  $n$ , such that  $3 \leq m \leq n$ , we have

$$\chi_{lid}(C_m \square C_n) = \begin{cases} 5 & m = 3 \text{ and } n \geq 3; \\ 3 & m \text{ is even and } n \text{ is even}; \\ 4 & \text{otherwise.} \end{cases}$$

*Proof.* The proof of the theorem follows from the Lemmas 6, 7, 9, 11 and 12.  $\square$

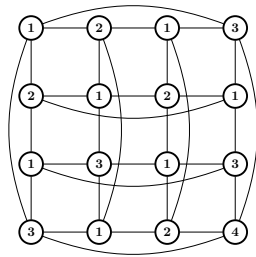

(a)  $C_4 \square C_4$

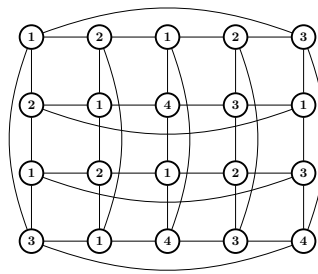

(b)  $C_4 \square C_5$

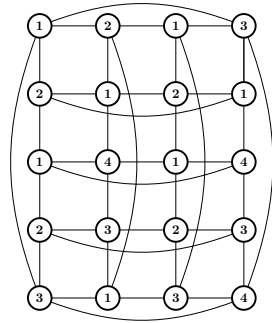

(c)  $C_5 \square C_4$

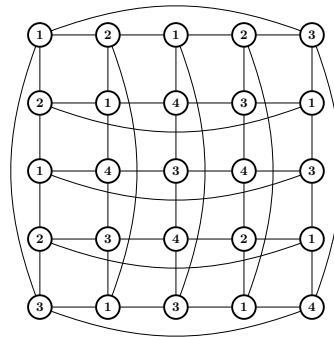

(d)  $C_5 \square C_5$

**Fig. 4** A 4-lid coloring of (a)  $C_4 \square C_4$ , (b)  $C_4 \square C_5$ , (c)  $C_5 \square C_4$  and (d)  $C_5 \square C_5$ .

## 4 Tensor product

In this section, we give an upper bound on lid-chromatic number of tensor product of two arbitrary graphs. Next, we give exact values of lid-chromatic number of tensor product of (a) two paths, (b) a cycle and a path, and (c) two cycles.

$C_4 \square C_4$	$C_4 \square C_4$	$C_4 \square C_4$	$C_4 \square C_5$
$C_4 \square C_4$	$C_4 \square C_4$	$C_4 \square C_4$	$C_4 \square C_5$
$C_5 \square C_4$	$C_5 \square C_4$	$C_5 \square C_4$	$C_5 \square C_5$

**Fig. 5** A 4-lid coloring of  $C_{13} \square C_{17}$ , which is obtained from the combination of copies of  $C_4 \square C_4$ ,  $C_4 \square C_5$ ,  $C_5 \square C_4$  and  $C_5 \square C_5$ .

#### 4.1 Tensor product of two arbitrary graphs

Let  $G$  and  $H$  be two graphs having at least two vertices. If both  $G$  and  $H$  have exactly two vertices then  $G \times H$  contains four vertices and we can find the lid-chromatic number of  $G \times H$  trivially. Therefore, in this section we assume that at least one of  $G$  or  $H$  contains at least three vertices.

**Lemma 13.** *Let  $G$  and  $H$  be two connected graphs such that either  $G$  or  $H$  has at least three vertices. If  $(u_1, v_1)$  and  $(u_2, v_2)$  are two adjacent vertices in  $G \times H$ , then we have  $N[(u_1, v_1)] \neq N[(u_2, v_2)]$ .*

*Proof.* Without loss generality, we assume that  $H$  has at least three vertices. Let  $(u_1, v_1)$  and  $(u_2, v_2)$  be two adjacent vertices of  $G \times H$ . We know that  $u_1 u_2 \in E(G)$  and  $v_1 v_2 \in E(H)$ . As  $H$  is connected and  $|V(H)| \geq 3$ , we have that degree of either  $v_1$  or  $v_2$  is at least two. Without loss of generality assume that degree of  $v_2$  is at least two and  $\{v_1, v_3\} \subseteq N(v_2)$ . Then it is easy to see that  $(u_1, v_3)(u_2, v_2) \in E(G \times H)$  and  $(u_1, v_3)(u_1, v_1) \notin E(G \times H)$ . That is  $(u_1, v_3) \in N[(u_2, v_2)]$  and  $(u_1, v_3) \notin N[(u_1, v_1)]$ .  $\square$

We call an edge  $e = uv$  of  $G \times H$  as *bad* with respect to a coloring  $g$  if  $N[u] \neq N[v]$  but  $g(N[u]) = g(N[v])$ , otherwise  $e$  is called *good*.

Let  $\chi(G) = k_1$  and  $\chi(H) = k_2$ . Let  $f_G : V(G) \rightarrow [k_1]$  and  $f_H : V(H) \rightarrow [k_2]$  are proper-colorings of  $G$  and  $H$  respectively. Define a coloring  $g : V(G \times H) \rightarrow [k_1] \times [k_2]$  such that for each  $(u, v) \in V(G \times H)$ ,  $g((u, v)) = (f_G(u), f_H(v))$ .

**Lemma 14.** *Let  $e = (u_1, v_1)(u_2, v_2)$  be an edge in  $G \times H$  and  $g$  be a coloring of  $G \times H$  as defined above. If  $e$  is bad with respect to  $g$  then  $g(N[(u_1, v_1)]) = g(N[(u_2, v_2)]) = \{g((u_1, v_1)), g((u_2, v_2))\} = \{(f_G(u_1), f_H(v_1)), (f_G(u_2), f_H(v_2))\}$ .*

*Proof.* We know from Lemma 13 that  $N[(u_1, v_1)] \neq N[(u_2, v_2)]$ . Since  $e$  is bad we have  $g(N[(u_1, v_1)]) = g(N[(u_2, v_2)])$ . Clearly,  $\{g((u_1, v_1)), g((u_2, v_2))\} \subseteq g(N[(u_1, v_1)])$  and  $\{g((u_1, v_1)), g((u_2, v_2))\} \subseteq g(N[(u_2, v_2)])$ . Suppose there exists a vertex  $(u, v) \in N[(u_1, v_1)]$  such that  $g((u, v))$  is different from both  $g((u_1, v_1))$  and  $g((u_2, v_2))$ . That is (a)  $f_G(u_1) \neq f_G(u)$  and  $f_H(v_1) \neq f_H(v)$ , and (b)  $f_G(u_2) \neq f_G(u)$  or  $f_H(v_2) \neq f_H(v)$ .

It is easy to see that if  $(u, v) \in N[(u_1, v_1)]$  then  $(u_2, v), (u, v_2) \in N[(u_1, v_1)]$ . If  $f_H(v_2) \neq f_H(v)$ , then  $(f_G(u_2), f_H(v)) \notin g(N[(u_2, v_2)])$  and if  $f_G(u_2) \neq f_G(u)$  then  $(f_G(u), f_H(v_2)) \notin g(N[(u_2, v_2)])$ . In both the cases we get a contradiction to the fact that edge  $e$  is bad with respect to the coloring  $g$ . Therefore, we have  $g(N[(u_1, v_1)]) = g(N[(u_2, v_2)]) = \{g((u_1, v_1)), g((u_2, v_2))\}$ .  $\square$

**Theorem 7.** *For any two connected graphs  $G$  and  $H$  such that either  $G$  or  $H$  has at least three vertices,  $\chi_{lid}(G \times H) \leq \chi(G)\chi(H)$ .*

*Proof.* Let  $\chi(G) = k_1$  and  $\chi(H) = k_2$ . Let  $f_G : V(G) \rightarrow [k_1]$  and  $f_H : V(H) \rightarrow [k_2]$  are proper-colorings of  $G$  and  $H$  respectively. Using the colorings  $f_G$  and  $f_H$ , we construct a lid-coloring of  $G \times H$  in two phases. In the first phase we define a coloring  $g : V(G \times H) \rightarrow [k_1] \times [k_2]$  such that for each  $(u, v) \in V(G \times H)$ ,  $g((u, v)) = (f_G(u), f_H(v))$ .

In the second phase we modify the coloring  $g$  to get a lid-coloring of  $G \times H$ . The idea behind the second phase coloring is as follows. If an edge  $e = (u_1, v_1)(u_2, v_2)$  is bad then from Lemma 14 we know that  $g(N[(u_1, v_1)]) = g(N[(u_2, v_2)]) = \{g((u_1, v_1)), g((u_2, v_2))\}$ . Consider the maximal connected subgraph  $J$  of  $G \times H$  induced by the colors  $g((u_1, v_1)), g((u_2, v_2))$  containing the vertices  $(u_1, v_1)$  and  $(u_2, v_2)$ . It is easy to see that  $J$  is bipartite and we know that every bipartite graph is 4-lid-colorable. Therefore, we color the subgraph  $J$  with four colors  $(f_G(u_1), f_H(v_1)), (f_G(u_2), f_H(v_2)), (f_G(u_1), f_H(v_2))$  and  $(f_G(u_2), f_H(v_1))$ . The second phase coloring  $f$  of  $G \times H$  is given in Algorithm 1. Next, we show that  $f$  is a lid-coloring of  $G \times H$ .

---

**Algorithm 1:** A lid-coloring of  $G \times H$ .

---

**Input:**  $G \times H$ ,  $f_G$ ,  $f_H$  and  $g$   
**Output:** A lid-coloring  $f$  of  $G \times H$

- 1  $S = \emptyset$ ,  $Q = V(G \times H)$ ,  $f((u, v)) = g((u, v))$  for all  $(u, v) \in V(G \times H)$
- 2 **if**  $(G \times H)[Q]$  has a bad edge  $e = (u_1, v_1)(u_2, v_2)$  w.r.t.  $g$  **then**
- 3      $f((u_1, v_1)) = (f_G(u_1), f_H(v_2))$
- 4      $f((u_2, v_2)) = (f_G(u_2), f_H(v_1))$
- 5      $S = S \cup (N[(u_1, v_1)] \cup N[(u_2, v_2)])$
- 6      $Q = Q \setminus S$
- 7 **return** (Coloring  $f$  of  $G \times H$ )

---

*Claim.*  $f$  is a proper-coloring of  $G \times H$ .

*Proof.* Let  $(u_1, v_1)$  and  $(u_2, v_2)$  be two adjacent vertices of  $G \times H$ . We know that  $u_1 u_2 \in E(G)$  and  $f_G(u_1) \neq f_G(u_2)$ . We have  $f((u_1, v_1)) = (f_G(u_1), -)$

and  $f((u_2, v_2)) = (f_G(u_2), -)$ . Since  $f_G(u_1) \neq f_G(u_2)$ , we get  $f((u_1, v_1)) \neq f((u_2, v_2))$ . Therefore  $f$  is a proper coloring of  $G \times H$ .  $\square$

Before proceeding to prove that  $f$  is a lid-coloring of  $G \times H$ , we classify the edges of  $G \times H$  into three categories as follows. An edge  $e$  in  $G \times H$  is called ‘fully updated’ if the colors of both its endpoints are changed by Algorithm 1. An edge  $e$  is called ‘partially updated’ if the color of only one endpoint of  $e$  is changed by Algorithm 1. If both endpoints of  $e$  are not changed by Algorithm 1 then we call the edge  $e$  a ‘non-updated’ edge.

*Claim.*  $f$  is a lid-coloring of  $G \times H$ .

*Proof.* We show that every edge  $e$  of  $G \times H$  is good with respect to coloring  $f$ .

**Case 1:**  $e$  is fully updated.

Let  $e = (u_1, v_1)(u_2, v_2)$ . Without loss of generality, assume that degree of  $(u_2, v_2)$  is at least two in  $G \times H$ . As  $e$  is a fully updated edge,  $e$  is bad with respect to  $g$ . That is,  $g(N[(u_1, v_1)]) = g(N[(u_2, v_2)]) = \{(f_G(u_1), f_H(v_1)), (f_G(u_2), f_H(v_2))\}$ . Algorithm 1 changes colors of  $(u_1, v_1)$  and  $(u_2, v_2)$  to  $(f_G(u_1), f_H(v_2))$  and  $(f_G(u_2), f_H(v_1))$  respectively. Also the colors of the vertices in the set  $(N[(u_1, v_1)] \cup N[(u_2, v_2)]) \setminus \{(u_1, v_1), (u_2, v_2)\}$  are not changed by Algorithm 1. Therefore,  $(f_G(u_1), f_H(v_1)) \notin f(N[(u_1, v_1)])$  as  $f_H(v_1) \neq f_H(v_2)$ . However,  $(f_G(u_1), f_H(v_1)) \in N[(u_2, v_2)]$ . Therefore,  $e$  is good with respect to  $f$ .

**Case 2:**  $e$  is partially updated.

Let  $e = (u_2, v_2)(u_3, v_3)$ . Without loss of generality assume that the color of  $(u_2, v_2)$  is updated by Algorithm 1. Then there exists an edge  $e' = (u_1, v_1)(u_2, v_2)$  which is fully updated. From Lemma 14 we know that  $g((u_1, v_1)) = g((u_3, v_3)) = (f_G(u_1), f_H(v_1)) = (f_G(u_3), f_H(v_3))$ .

Notice that  $(f_G(u_1), f_H(v_2)) \in f(N[(u_2, v_2)])$ . However, the color  $(f_G(u_1), f_H(v_2)) \notin N[(u_3, v_3)]$  as  $f_G(u_1) = f_G(u_3)$  and  $f_H(v_2) \neq f_H(v_3)$ . Therefore  $e$  is good with respect to  $f$ .

**Case 3:**  $e$  is non-updated.

Let  $e = (u_3, v_3)(u_4, v_4)$ . If Algorithm 1 doesn’t update any vertex from the set  $N[(u_3, v_3)] \cup N[(u_4, v_4)]$  then clearly  $e$  is good with respect to  $f$ .

Suppose, the color of a vertex  $(u_2, v_2) \in N((u_3, v_3))$  is updated by Algorithm 1. Then there exists an edge  $e' = (u_1, v_1)(u_2, v_2)$  which is fully updated. From Lemma 14 we know that  $g((u_1, v_1)) = g((u_3, v_3)) = (f_G(u_1), f_H(v_1)) = (f_G(u_3), f_H(v_3))$ .

Suppose that  $e$  is bad with respect to  $f$ . Then  $f((u_2, v_2)) = f((u_4, v_4)) = (f_G(u_2), f_H(v_1))$ . That is we have  $f((u_3, v_3)) = (f_G(u_1), f_H(v_1))$  and  $f((u_4, v_4)) = (f_G(u_2), f_H(v_1))$ , which is a contradiction as  $f_H(v_3) = f_H(v_4)$  and  $v_3v_4 \in E(H)$ . Therefore  $e$  is good with respect to  $f$ .

Hence the theorem.  $\square$

We can easily see that the bound given in the Theorem 7 is sharp for  $G = H = P_4$ .

## 4.2 Tensor product for two paths

We use the following known results on tensor products in our proofs.

**Lemma 15** ([4]). *Let  $G$  and  $H$  be two graphs. If  $G$  or  $H$  is bipartite then  $G \times H$  is bipartite.*

**Lemma 16** ([9]). *For two connected graphs  $G$  and  $H$ , the tensor product  $G \times H$  is connected if and only if either  $G$  or  $H$  is non-bipartite.*

**Lemma 17** ([9]). *If  $G$  and  $H$  are connected bipartite graphs then  $G \times H$  has exactly two components.*

**Theorem 8.** *For every pair of integers  $m \geq 2$  and  $n \geq 2$ , we have*

$$\chi_{lid}(P_m \times P_n) = \begin{cases} 2 & \text{if } m = 2 \text{ and } n = 2; \\ 4 & \text{if } m, n \geq 4 \text{ are even;} \\ 3 & \text{otherwise} \end{cases}$$

*Proof.* Let  $V(P_m) = \{u_1, u_2, \dots, u_m\}$ ,  $V(P_n) = \{v_1, v_2, \dots, v_n\}$  and  $V(P_m \times P_n) = \{(u_i, v_j) \mid i \in [m], j \in [n]\}$ .

**Case 1:** When  $m = 2$  and  $n = 2$ .

The graph  $P_2 \times P_2$  is a disjoint union of two  $P_2$ 's. Hence,  $\chi_{lid}(P_2 \times P_2) = 2$ .

**Case 2:** When  $m, n \geq 4$  are even.

Using Lemma 16 and Lemma 17 we can see that the graph  $P_m \times P_n$  is a disconnected graph having exactly two connected components. Let the two connected components be  $B_1$  and  $B_2$ , where  $V(B_1) = \{(u_i, v_j) \mid i + j \text{ is even}\}$  and  $V(B_2) = \{(u_i, v_j) \mid i + j \text{ is odd}\}$ . As  $m$  and  $n$  are even, both  $B_1$  and  $B_2$  contain exactly two vertices of degree one. The two degree one vertices in  $B_1$  are  $(u_1, v_1)$  and  $(u_m, v_n)$ .

Suppose,  $\chi_{lid}(B_1) = 3$  and let  $f$  be a 3-lid-coloring of  $B_1$ . It is easy to see that the distance between  $(u_1, v_1)$  and  $(u_m, v_n)$  is  $2q + 1$  for some  $q \in \mathbb{N}$ . We know  $\deg((u_1, v_1)) = \deg((u_m, v_n)) = 1$ . Thus, we have  $|f(N[(u_1, v_1)])| = 2$ . This implies that  $|f(N[(u_2, v_2)])| = 3$ , otherwise  $f(N[(u_1, v_1)]) = f(N[(u_2, v_2)])$ , contradicting the fact that  $f$  is a lid-coloring. Since  $|f(N[(u_2, v_2)])| = 3$ , and  $f$  is a 3-lid-coloring of  $B_1$  we get  $|f(N[(u, v)])| = 2$  for every  $(u, v) \in N((u_2, v_2))$ . Continuing this way, for all the vertices on any shortest path from  $(u_1, v_1)$  to  $(u_m, v_n)$ , we get  $|f(N[(u_m, v_n)])| = 3$ , which is not possible as  $\deg((u_m, v_n)) = 1$ . This contradicts the assumption that  $f$  is a 3-lid-coloring of  $B_1$ .

Thus  $\chi_{lid}(P_m \times P_n) \geq \chi_{lid}(B_1) \geq 4$ . As  $P_m \times P_n$  is a bipartite graph, from Theorem 1 we have  $\chi_{lid}(P_m \times P_n) \leq 4$ . Therefore, we have  $\chi_{lid}(P_m \times P_n) = 4$ .

**Case 3:** When  $m$  is odd and  $n \geq 2$ .

A 3-lid-coloring of  $P_m \times P_n$  is given in Fig. 6. Hence, we have  $\chi_{lid}(P_m \times P_n) \leq 3$ . From Lemma 4, we know that  $\chi_{lid}(P_m \times P_n) \geq 3$ . Altogether, we have  $\chi_{lid}(P_m \times P_n) = 3$ .  $\square$

**Case 4:** When  $m \geq 2$  and  $n$  is odd.

As the Cartesian product is commutative, this case is same as Case 3.

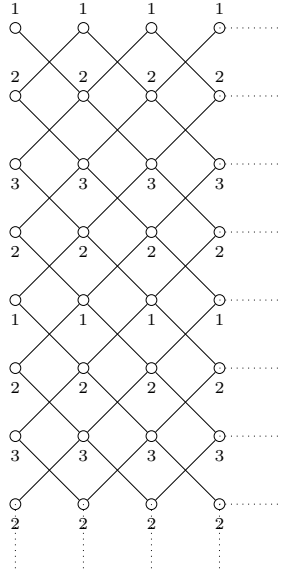

**Fig. 6** A 3-lid-coloring of  $P_m \times P_n$ .

### 4.3 Tensor product of a cycle and a path

**Theorem 9.** For every pair of integers  $m$  and  $n$ , where  $m \geq 3$ ,  $n \geq 2$ , we have

$$\chi_{lid}(C_m \times P_n) = \begin{cases} 3 & \text{if } m \geq 3 \text{ and } n \text{ is odd;} \\ 3 & \text{if } m \text{ is a multiple of 4 and } n \text{ is even;} \\ 4 & \text{otherwise} \end{cases}$$

*Proof.* Let  $V(C_m) = \{u_1, u_2, \dots, u_m\}$ ,  $V(P_n) = \{v_1, v_2, \dots, v_n\}$  and  $V(C_m \times P_n) = \{(u_i, v_j) \mid i \in [m], j \in [n]\}$ .

**Case 1:** When  $m \geq 3$  and  $n$  is odd.

A 3-lid-coloring of  $C_m \times P_n$  is given in Fig. 7. Hence,  $\chi_{lid}(C_m \times P_n) \leq 3$ . From Lemma 4, we know that  $\chi_{lid}(C_m \times P_n) \geq 3$ . Thus,  $\chi_{lid}(C_m \times P_n) = 3$ .

**Case 2:** When  $m$  is a multiple of 4 and  $n$  is even.

When  $n = 2$ , the graph  $C_m \times P_n$  is disconnected in which each connected component is a copy of  $C_m$ . Therefore,  $\chi_{lid}(C_m \times P_n) = \chi_{lid}(C_m)$ . From Lemma 2, we have  $\chi_{lid}(C_m \times P_n) = 3$ .

When  $n \geq 4$ , a 3-lid-coloring of  $C_m \times P_n$  is given in Fig. 8. Hence,  $\chi_{lid}(C_m \times P_n) \leq 3$ . From Lemma 4, we have  $\chi_{lid}(C_m \times P_n) \geq 3$ . Thus  $\chi_{lid}(C_m \times P_n) = 3$ .

**Case 3(a):** When  $m$  is not a multiple of 4, and both  $m$  and  $n$  are even.

When  $n = 2$ , from Lemma 2 we get  $\chi_{lid}(C_m \times P_n) = \chi_{lid}(C_m) = 4$ . The arguments are similar to the above case when  $n = 2$ .

Now, we deal with the case when  $n \geq 4$ . From Lemma 16 and Lemma 17 we get that the graph  $C_m \times P_n$  is a disconnected bipartite graph and contains exactly two connected components. Let the two connected components be  $B_1$  and  $B_2$ , where  $V(B_1) = \{(u_i, v_j) \mid i + j \text{ is even}\}$  and  $V(B_2) = \{(u_i, v_j) \mid i + j \text{ is odd}\}$ .

Suppose that  $\chi_{lid}(B_1) = 3$  and let  $f$  be a 3-lid-coloring of  $B_1$ . Consider a vertex  $(u_1, v_1)$ . We divide the proof into two cases based on the number colors used by  $f$  in the closed neighborhood of  $(u_1, v_1)$ .

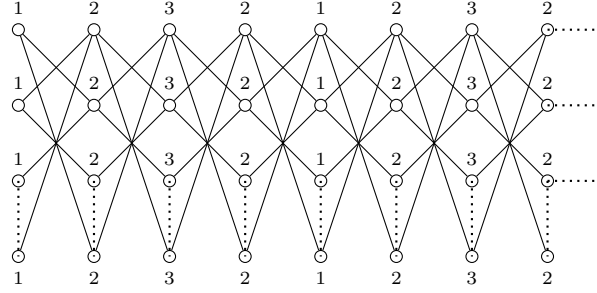

**Fig. 7** A 3-lid-coloring of  $C_m \times P_n$ , when  $n$  is odd, is obtained from the figure by selecting first  $m$  rows and  $n$  columns following the above pattern.

**Case (A):**  $|f(N[(u_1, v_1)])| = 2$ .

We know that  $N((u_1, v_1)) = \{(u_2, v_2), (u_m, v_2)\}$ . As  $f$  is a lid-coloring, we have  $|f(N[(u_2, v_2)])| = |f(N[(u_m, v_2)])| = 3$ . Next, we know that  $N((u_2, v_2)) = \{(u_1, v_1), (u_3, v_1), (u_1, v_3), (u_3, v_3)\}$ . Since  $|f(N[(u_2, v_2)])| = 3$ , and  $f$  is a 3-lid-coloring we have  $|f(N[(u, v)])| = 2$  for every  $(u, v) \in N((u_2, v_2))$ . Continuing the arguments this way, we get  $|f(N[(u_i, v_j)])| = 2$  when both  $i$  and  $j$  are odd and  $|f(N[(u_i, v_j)])| = 3$  when both  $i$  and  $j$  are even.

Since  $n - 1$  is odd, we have  $|f(N[(u_i, v_{n-1})])| = 2$ , for each  $i \in \{1, 3, \dots, m - 1\}$ . That is all the vertices in the set  $\{(u_i, v_{n-2}), (u_i, v_n) \mid i \in \{2, 4, \dots, m\}\}$  are assigned the same color by  $f$ . Since  $|f(N[(u_i, v_n)])| = 3$ , for each  $i \in \{2, 4, \dots, m - 2\}$  and  $N((u_i, v_n)) = \{(u_{i-1}, v_{n-1}), (u_{i+1}, v_{n-1})\}$ , therefore  $f((u_{i-1}, v_{n-1})) \neq f((u_{i+1}, v_{n-1}))$ .

As  $f$  is a 3-lid-coloring of  $B_1$ , we get that, all the vertices in the set  $\{(u_i, v_{n-1}) \mid i \in \{1, 5, 9, \dots, m - 1\}\}$  are assigned the same color by  $f$ . Similarly, all the vertices in the set  $\{(u_i, v_{n-1}) \mid i \in \{3, 7, \dots, m - 3\}\}$  are assigned the same color by  $f$ .

Combining all the above, we get  $f((u_1, v_{n-1})) = f((u_{m-1}, v_{n-1}))$ . We know that  $N((u_m, v_n)) = \{(u_1, v_{n-1}), (u_{m-1}, v_{n-1})\}$ , therefore we get  $|f(N[(u_m, v_n)])| = 2$ , which contradicts our assumption that  $|f(N[(u_i, v_j)])| = 3$  when both  $i$  and  $j$  are even. Therefore,  $f$  is not a 3-lid-coloring of  $B_1$ . Thus,  $\chi_{lid}(C_m \times P_n) \geq \chi_{lid}(B_1) \geq 4$ . As  $C_m \times P_n$  is bipartite, from Theorem 1 we know that for a  $\chi_{lid}(C_m \times P_n) \leq 4$ . Therefore, we have  $\chi_{lid}(C_m \times P_n) = 4$ .

**Case (B):**  $|f(N[(u_1, v_1)])| = 3$ .

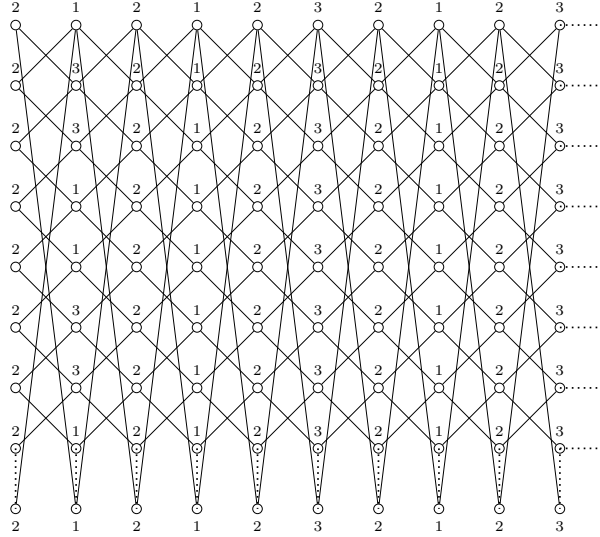

**Fig. 8** 3-lid-coloring of  $C_m \times P_n$ , when  $m$  is a multiple of 4 and  $n \geq 4$  is even, is obtained from the figure by selecting first  $m$  rows and  $n$  columns following the above pattern.

Following similar lines as proof of the above case, we can show that  $\chi_{lid}(C_m \times P_n) = 4$ .

**Case 3(b):** When  $m$  is odd and  $n$  is even.

The proof of this case is similar to the proof of Case 3(a). □

#### 4.4 Tensor product of two cycles

**Lemma 18.** *Let  $m$  and  $n$  be two integers such that  $3 \leq m \leq n$ . If at least one of  $m$  or  $n$  is even then  $\chi_{lid}(C_m \times C_n) = 3$ .*

*Proof.* In this case, at least one of  $C_m$  or  $C_n$  is bipartite and hence from Lemma 15  $C_m \times C_n$  is bipartite. From Theorem 2, we know that for  $k \geq 4$ , a  $k$ -regular graph is 3-lid-colorable if and only if it is bipartite. Since  $C_m \times C_n$  is a 4-regular bipartite graph, we have that  $\chi_{lid}(C_m \times C_n) = 3$ . □

For the rest of this section, we deal with the case where both  $m$  and  $n$  are odd. Thus from Lemma 3, we have that  $\chi_{lid}(C_m \times C_n) \geq 4$ .

**Lemma 19.** *Let  $m$  and  $n$  be two odd positive integers such that  $m \geq 9$  and  $n \geq 3$ . Then we have  $\chi_{lid}(C_m \times C_n) = 4$ .*



*Proof.* As  $m \geq 9$  is an odd integer, from Lemma 2 we know that  $\chi_{lid}(C_m) = 4$ . Let  $g$  be a 4-lid-coloring of  $C_m$ . We define a 4-lid-coloring  $f$  of  $C_m \times C_n$  as  $f(u, v) = g(u)$  for every  $(u, v) \in V(C_m \times C_n)$ . It is easy to see that  $f$  is a proper coloring of  $C_m \times C_n$ .

Consider two adjacent vertices  $(u_1, v_1)$  and  $(u_2, v_2)$ . From Lemma 13 we know that  $N[(u_1, v_1)] \neq N[(u_2, v_2)]$ . We have  $f(N[(u_1, v_1)]) = g(N[u_1])$  and  $f(N[(u_2, v_2)]) = g(N[u_2])$ . Since  $u_1 u_2 \in E(C_m)$  and  $N[u_1] \neq N[u_2]$ , we have  $g(N[u_1]) \neq g(N[u_2])$ . Therefore,  $f(N[(u_1, v_1)]) \neq f(N[(u_2, v_2)])$ . Hence,  $f$  is a 4-lid-coloring of  $C_m \times C_n$ .

**Lemma 20.**  $\chi_{lid}(C_m \times C_n) = 4$  for the pairs  $(m, n) \in \{(3, 7), (5, 5), (5, 7), (7, 7)\}$ .

*Proof.* From Lemma 3 we know that  $\chi_{lid}(C_m \times C_n) \geq 4$ . We have given a 4-lid-coloring of  $C_m \times C_n$  for  $(m, n) \in \{(3, 7), (5, 5), (5, 7), (7, 7)\}$  in Fig 14, Fig 15, Fig 16 and Fig 17 respectively.

**Lemma 21.**  $\chi_{lid}(C_3 \times C_3) = \chi_{lid}(C_3 \times C_5) = 5$ .

*Proof.* We have given a 5-lid-coloring of  $C_3 \times C_3$  and  $C_3 \times C_5$  in Fig 13. We found that  $\chi_{lid}(C_3 \times C_3) = \chi_{lid}(C_3 \times C_5) = 5$  by performing a tedious case by case analysis.

**Theorem 10.** For every pair of integers  $m$  and  $n$ , such that  $3 \leq m \leq n$ , we have

$$\chi_{lid}(C_m \times C_n) = \begin{cases} 5 & \text{if } m = 3 \text{ and } n \in \{3, 5\}; \\ 4 & \text{if } m = 3 \text{ and } n = 7; \\ 4 & \text{if } m \in \{5, 7\} \text{ and } n \in \{5, 7\}; \\ 4 & \text{if } m \geq 9, m \text{ is odd and } n \geq 3, n \text{ is odd}; \\ 3 & \text{otherwise} \end{cases}$$

*Proof.* The proof follows from the results of Lemmas 18, 19, 20, 21.

## References

1. Louis Esperet, Sylvain Gravier, Mickael Montassier, Pascal Ochem, and Aline Parreau. Locally identifying coloring of graphs. *The Electronic Journal of Combinatorics*, 19(2):40, 2012.
2. Florent Foucaud, Iiro Honkala, Tero Laihonen, Aline Parreau, and Guillem Perarnau. Locally identifying colourings for graphs with given maximum degree. *Discrete Mathematics*, 312(10):1832–1837, 2012.
3. Daniel Gonçalves, Aline Parreau, and Alexandre Pinlou. Locally identifying coloring in bounded expansion classes of graphs. *Discrete Applied Mathematics*, 161(18):2946–2951, 2013.
4. Richard Hammack, Wilfried Imrich, and Sandi Klavžar. *Handbook of product graphs*. CRC press, 2011.
5. Nicolas Martins and Rudini Sampaio. Locally identifying coloring of graphs with few P4s. *Theoretical Computer Science*, 707:69–76, 2018.

6. Gert Sabidussi. Graphs with given group and given graph-theoretical properties. *Canadian journal of mathematics*, 9:515–525, 1957.
7. Yaroslav Shitov. Counterexamples to hedetniemi’s conjecture. *Annals of Mathematics*, 190(2):663–667, 2019.
8. James J Sylvester. On subvariants, ie semi-invariants to binary quantics of an unlimited order. *American Journal of Mathematics*, 5(1):79–136, 1882.
9. Paul M Weichsel. The kronecker product of graphs. *Proceedings of the American mathematical society*, 13(1):47–52, 1962.

## 5 Appendix

### 5.1 Figures of Cartesian product of two cycles of odd length

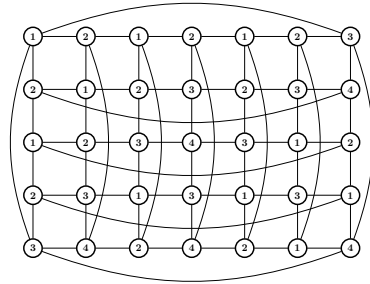

(a)  $C_5 \square C_7$

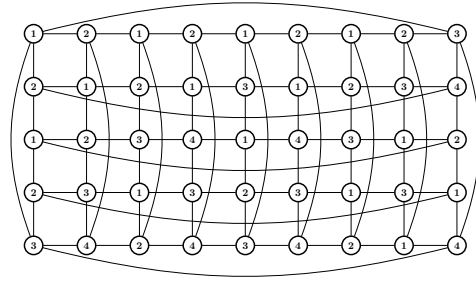

(b)  $C_5 \square C_9$

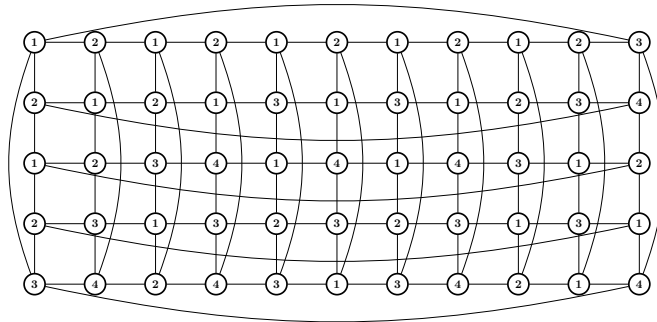

(c)  $C_5 \square C_{11}$

**Fig. 9** A 4-lid coloring of  $C_5 \square C_7$ ,  $C_5 \square C_9$  and  $C_5 \square C_{11}$ .

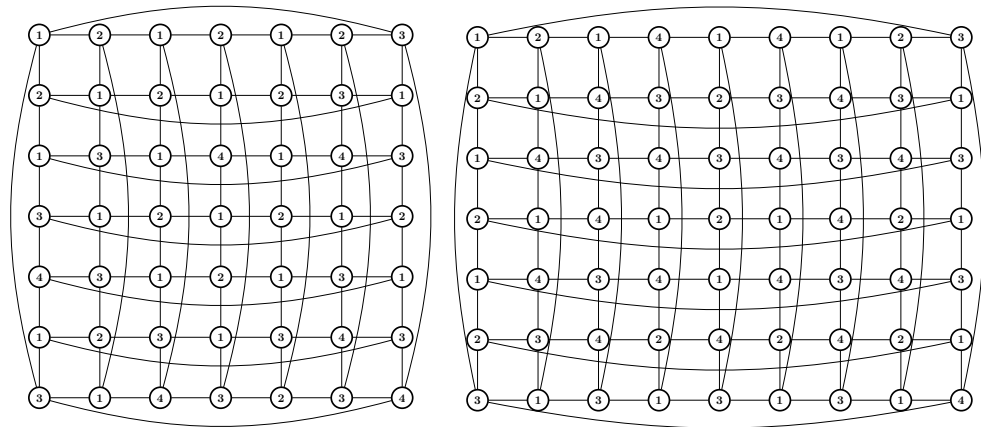

(a)  $C_7 \square C_7$

(b)  $C_7 \square C_9$

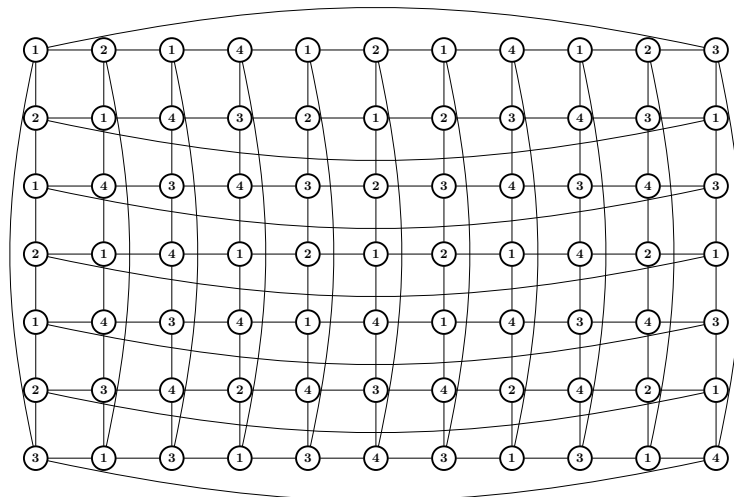

(c)  $C_7 \square C_{11}$

**Fig. 10** A 4-lid coloring of  $C_7 \square C_7$ ,  $C_7 \square C_9$  and  $C_7 \square C_{11}$ .

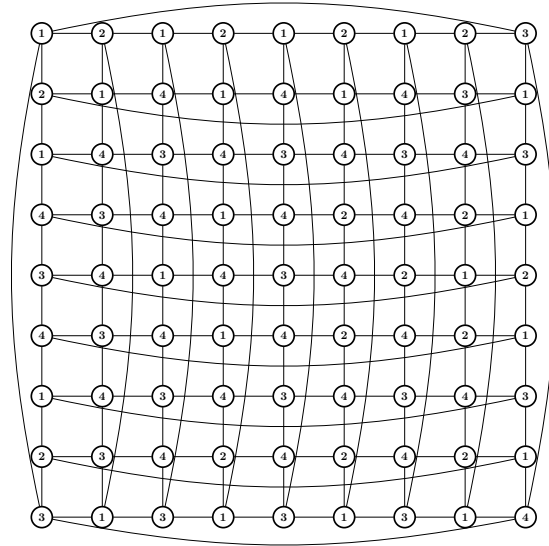

(a)  $C_9 \square C_9$

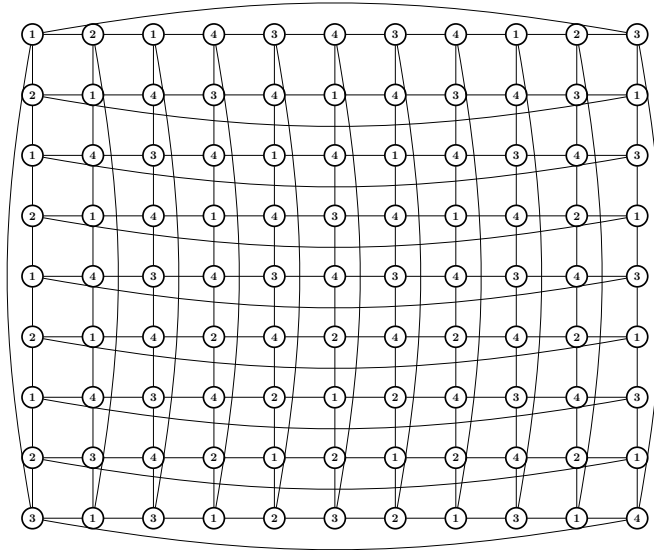

(b)  $C_9 \square C_{11}$

**Fig. 11** A 4-lid coloring of  $C_9 \square C_9$  and  $C_9 \square C_{11}$  .

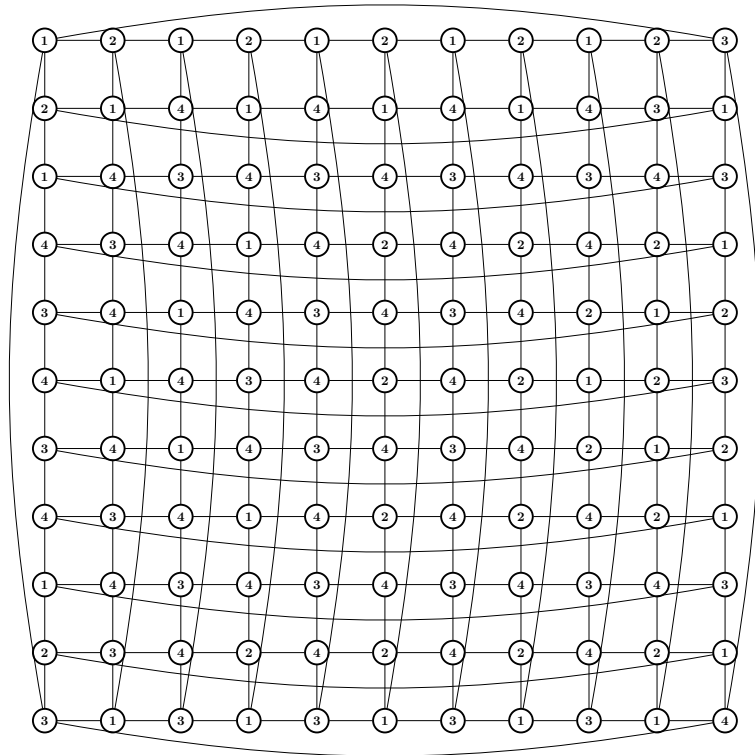

(a)  $C_{11} \square C_{11}$

**Fig. 12** A 4-lid coloring of  $C_{11} \square C_{11}$ .

5.2 Figure of tensor product of two cycles of odd length

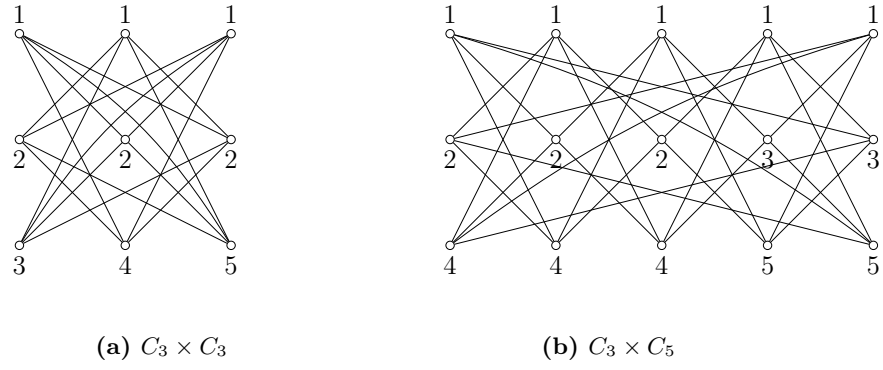

Fig. 13 A 5-lid-coloring of  $C_3 \times C_3$  and  $C_3 \times C_5$

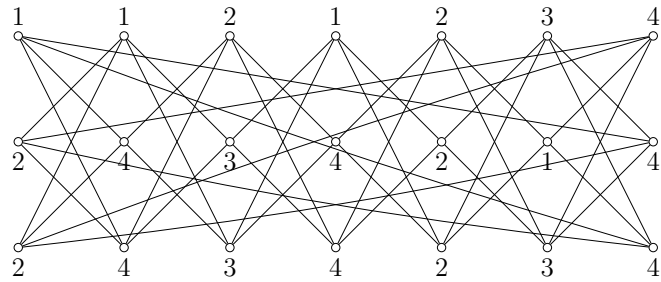
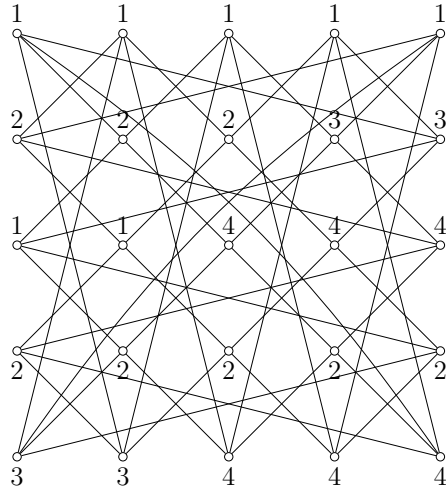
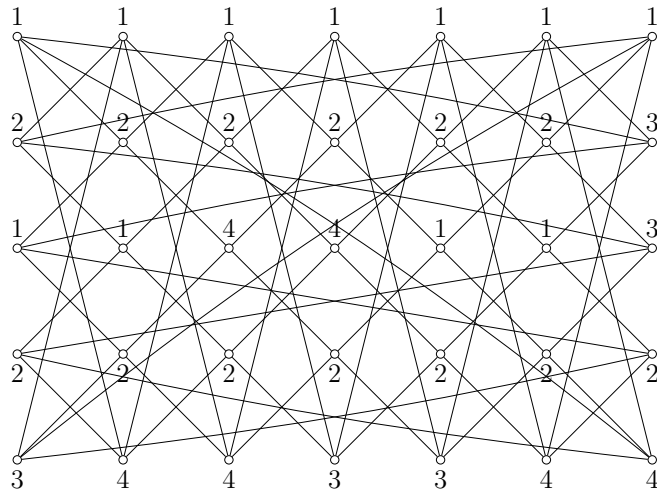

Fig. 14 A 4-lid-coloring of  $C_3 \times C_7$

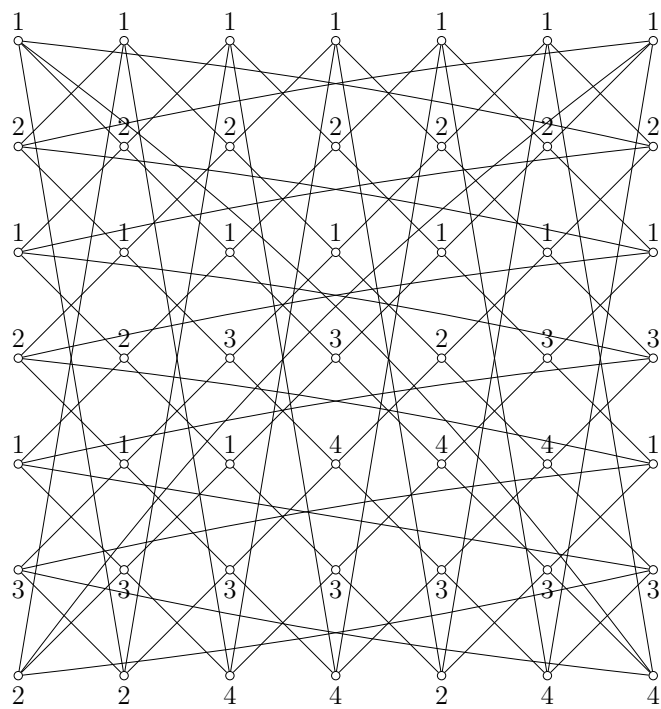

**Fig. 15**  $C_5 \times C_5$



**Fig. 16**  $C_5 \times C_7$





**Fig. 17**  $C_7 \times C_7$