





Stochastic Decision Petri Nets

Florian Wittbold¹, Rebecca Bernemann¹, Reiko Heckel², Tobias Heindel³, and Barbara König¹

¹ Universität Duisburg-Essen, Duisburg, Germany

² University of Leicester, UK

³ Heliix Technologies GmbH

Abstract. We introduce stochastic decision Petri nets (SDPNs), which are a form of stochastic Petri nets equipped with rewards and a control mechanism via the deactivation of controllable transitions. Such nets can be translated into Markov decision processes (MDPs), potentially leading to a combinatorial explosion in the number of states due to concurrency. Hence we restrict ourselves to instances where nets are either safe, free-choice and acyclic nets (SAFC nets) or even occurrence nets and policies are defined by a constant deactivation pattern. We obtain complexity-theoretic results for such cases via a close connection to Bayesian networks, in particular we show that for SAFC nets the question whether there is a policy guaranteeing a reward above a certain threshold is NP^{PP} -complete. We also introduce a partial-order procedure which uses an SMT solver to address this problem.

1 Introduction

State-based probabilistic systems are typically modelled as Markov chains [28], i.e., transition systems where transitions are annotated with probabilities. This admits an intuitive graphical visualization and efficient analysis techniques [17]. By introducing additional non-determinism, one can model a system where a player can make decisions, enriched with randomized choices. This leads to the well-studied model of Markov decision processes (MDPs) [6,15] and the challenge is to synthesize strategies that maximize the reward of the player.

In this paper we study stochastic systems enriched with a mechanism for decision making in the setting of concurrent systems. Whenever a system exhibits a substantial amount of concurrency, i.e., events that may potentially happen in parallel, compiling it down to a state-based system – such as an MDP – can result in a combinatorial state explosion and a loss in efficiency of MDP-based methods. We base our models on stochastic Petri nets [21], where Petri nets are a standard formalism for modelling concurrent systems, especially such systems where resources are generated and consumed. When considering the discrete-time semantics of such stochastic nets, it is conceptually easy to transform them into Markov chains, but this typically leads to a state space explosion.

There exist successful partial order methods for analyzing concurrent systems that avoid explicit interleavings and the enumeration of all reachable states. Instead, they work with partial orders – instead of total orders – of events. While

such techniques are well understood in the absence of random choices, leading for instance to methods such as unfoldings [14], there are considerable difficulties to reconcile probability and partial order. Progress has been made by the introduction of the concept of branching cells [1] that encapsulate independent choices, but to our knowledge there is no encompassing theory that provides off-the-shelf partial order methods for computing the probability of reaching a certain goal (e.g. marking a certain place) in a stochastic net.

The contributions of this paper are the introduction of a new model: stochastic decision Petri nets (SDPNs) and its connection to Markov decision processes (MDPs). The transformation of SDPNs into MDPs is relatively straightforward, but may lead to state space explosion, i.e., exponentially many markings, due to the concurrency inherent in the Petri net. This can make the computation of the optimal policy infeasible. We restrict ourselves to a subclass of nets which are safe, acyclic and free-choice (SAFC) and to constant policies and study the problem of determining a policy that guarantees a payoff above some bound. Our result is that the problem SAFC-POL of determining such a policy, despite the restrictions, is still NP^{PP} -complete. We reduce from the D-MAP problem for Bayesian networks [24] (in fact the two problems are interreducible under mild restrictions) and show the close connection of reasoning about stochastic Petri nets and Bayesian networks. Furthermore, for SAFC nets, there is a partial-order solution procedure via an SMT solver, for which we obtain encouraging runtime results. For the simpler free-choice occurrence nets, we obtain an NP-completeness result.

Note that the main body of the paper contains some proof sketches, while full proofs and an additional example can be found in the appendix.

2 Preliminaries

By \mathbb{N} we denote the natural numbers without 0, while \mathbb{N}_0 includes 0.

Given two sets X, Y we denote by $(X \rightarrow Y)$ the set of all functions from X to Y . Given a function $f: X \rightarrow \mathbb{N}_0$ or $f: X \rightarrow \mathbb{R}$ with X finite, we define $\|f\|_\infty = \max_{x \in X} f(x)$ and $\text{supp}(f) = \{x \in X \mid f(x) \neq 0\}$.

Complexity Classes: In addition to well-known complexity classes such as P and NP, our results also refer to PP (see [23]). This class is based on the notion of a probabilistic Turing machine, i.e., a non-deterministic Turing machine whose transition function is enriched with probabilities, which means that the acceptance function becomes a random variable. A language L lies in PP if there exists a probabilistic Turing machine M with polynomial runtime on all inputs such that a word $w \in L$ iff it is accepted with probability strictly greater than $1/2$. As probabilities we only allow numbers ρ that are efficiently computable, meaning that the i -th bit of ρ is computable in a time polynomial in i . (See [2] for a discussion on why such probabilistic Turing machines have equal expressivity with those based on fair coins, which is not the case if we allow arbitrary numbers.)

Given two complexity classes A, B and their corresponding machine models, by A^B we denote the class of languages that are solved by a machine of class

A , which is allowed to use an oracle answering yes/no-questions for a language $L \in B$ at no extra cost in terms of time or space complexity. In particular NP^{PP} denotes the class of languages that can be accepted by a non-deterministic Turing machine running in polynomial time that can query a black box oracle solving a problem in PP.

By Toda's theorem [27], a polynomial time Turing machine with a PP oracle (P^{PP}) can solve all problems in the polynomial hierarchy.

In order to prove hardness results we use the standard polynomial-time many-one reductions, denoted by $A \leq_p B$ for problems A, B (see [16]).

Stochastic Petri Nets: A stochastic Petri net [21] is given by a tuple $N = (P, T, \bullet(\cdot), (\cdot)^\bullet, \Lambda, m_0)$ where P and T are finite sets of places and transitions, $\bullet(\cdot), (\cdot)^\bullet : T \rightarrow (P \rightarrow \mathbb{N}_0)$ determine for each transition its pre-set and post-set including multiplicities, $\Lambda : T \rightarrow \mathbb{R}_{>0}$ defines the firing rates and $m_0 : P \rightarrow \mathbb{N}_0$ is the initial marking. By $\mathcal{M}(N)$ we denote the set of all markings of N , i.e., $\mathcal{M}(N) = (P \rightarrow \mathbb{N}_0)$.

We will only consider the discrete-time semantics of such nets. The firing rates determine stochastically which transition is fired in a marking where multiple transitions are enabled: When transitions $t_1, \dots, t_n \in T$ are enabled in a marking $m \in \mathcal{M}(N)$ (i.e., $\bullet t_i \leq m$ pointwise), then transition t_i fires with probability $\Lambda(t_i) / \sum_{j=1}^n \Lambda(t_j)$, resulting in a discrete step $m \xrightarrow{t_i} m' := m - \bullet t_i + t_i^\bullet$. In particular, the firing rates have no influence on the reachability set $\mathcal{R}(N) := \{m \in \mathcal{M}(N) \mid m_0 \rightarrow^* m\}$ but only define the probability of reaching certain places or markings. Defining “empty” transitions $m \rightarrow_\varepsilon m$ for markings $m \in \mathcal{R}(N)$ where no transition is enabled, such a stochastic Petri net can be interpreted as a Markov chain on the set of markings $\mathcal{M}(N)$.

This Markov chain thus generates a (continuous) probability space over sequences $(m_0, m_1, \dots) \in \mathcal{M}(N)^\omega$ where a sequence is called valid if m_0 is the initial marking of the Petri net and for a prefix (m_0, \dots, m_n) all cones $\{(m'_0, m'_1, \dots) \in \mathcal{M}(N)^\omega \mid \forall k = 0, \dots, n : m'_k = m_k\}$ have non-zero probability. We write $\mathcal{FS}(N) := \{\mu \in \mathcal{M}(N)^\omega \mid \mu \text{ is valid}\}$ to denote the set of valid sequences. We assume that no two transitions have the same pre- and postconditions to have a one-to-one-correspondence between valid sequences and firing sequences $\mu : (m_0 \xrightarrow{t_1} m_1 \xrightarrow{t_2} \dots)$.

For a firing sequence μ , we write $\mu^k : m_0 \xrightarrow{t_1} m_1 \xrightarrow{t_2} \dots \xrightarrow{t_k} m_k$ to denote the finite subsequence of the first k steps, $\text{len}(\mu) := \min\{k \in \mathbb{N} \mid t_k = \varepsilon\} - 1$, for its length, as well as

$$pl(\mu) := \bigcup_{n=0}^{\infty} \text{supp}(m_n) \quad tr(\mu) := \{t_n \mid n \in \mathbb{N}\} \setminus \{\varepsilon\}$$

to denote the set of places reached in μ (or, analogously, μ^k), and the set of fired transitions in μ (independent of their firing order), respectively.

We are, furthermore, interested in the following properties of Petri nets: A Petri net N as above is called

- *ordinary* iff all transitions require and produce at most one token in each place ($\|\bullet t\|_\infty, \|t\bullet\|_\infty \leq 1$ for all $t \in T$);
- *safe* iff it is ordinary and all reachable markings also only have at most one token in each place ($\|m\|_\infty \leq 1$ for all $m \in \mathcal{R}(N)$);
- *acyclic* iff the transitive closure \prec_N^+ of the causal relation \prec_N (with $p \prec_N t$ if $\bullet t(p) > 0$ and $t \prec_N p$ if $t\bullet(p) > 0$) is irreflexive;
- an *occurrence net* iff it is safe, acyclic, free of backward conflicts (all places have at most one predecessor transition, i.e., $|\{t \mid t\bullet(p) > 0\}| \leq 1$ for all $p \in P$) and self-conflicts (for $x \in P \cup T$, there exist no two distinct conflicting transitions $t, t' \in T$, i.e., transitions sharing preconditions, on which x is causally dependent, i.e., $t, t' \prec_N^+ x$), and the initial marking has no causal predecessors (for all $p \in P$ with $m_0(p) = 1$, we have $t\bullet(p) = 0$ for all $t \in T$);
- *free-choice* [13] iff it is ordinary and all transitions $t, t' \in T$ are either both enabled or disabled in all markings (i.e., $\bullet t = \bullet t'$ or $\text{supp}(\bullet t) \cap \text{supp}(\bullet t') = \emptyset$);
- φ -*bounded* (for $\varphi: \mathbb{N}_0 \rightarrow \mathbb{N}_0$) iff all its runs, starting from m_0 , have at most length $\varphi(|P| + |T|)$, i.e., iff $\text{len}(\mu) \leq \varphi(|P| + |T|)$ for all firing sequences $\mu \in \mathcal{FS}(N)$.

We will abbreviate the class of free-choice occurrence Petri nets as FCON, safe and acyclic free-choice nets as SAFC nets, and the class of φ -bounded Petri nets as $[\varphi]$ BPN. Note that $\text{FCON} \subseteq \text{SAFC}$ and also $\text{SAFC} \subseteq [\text{id}]$ BPN for the identity id .⁴

We also introduce some notation specifically for SAFC nets: As common in the analysis of safe Petri nets, we will interpret markings as well as pre- and postconditions of transitions as subsets of the set P of places rather than functions $P \rightarrow \{0, 1\} \subseteq \mathbb{N}_0$.

The set of maximal configurations will be denoted by $\mathcal{C}^\omega(N) := \{tr(\mu) \mid \mu \in \mathcal{FS}(N)\}$ and configurations by $\mathcal{C}(N) := \{tr(\mu^k) \mid \mu \in \mathcal{FS}(N), k \in \mathbb{N}_0\}$.

An important notion in the analysis of a (free-choice) net are branching cells (see also [8,1]). We will define a cell to be a subset of transitions $\mathbb{C} \subseteq T$ where all transitions $t \in \mathbb{C}$ share their preconditions and all $t' \in T \setminus \mathbb{C}$ share no preconditions with $t \in \mathbb{C}$. In other words, \mathbb{C} is an equivalence class of a relation \leftrightarrow on T defined by

$$\forall t, t' \in T : t \leftrightarrow t' \iff \bullet t = \bullet t'.$$

We will write $\mathbb{C}_t := [t]^{\leftrightarrow}$ to denote the equivalence class of transition $t \in T$ and $\bullet \mathbb{C} := \bigcup_{t \in \mathbb{C}} \bullet t$ as well as $\mathbb{C}^\bullet := \bigcup_{t \in \mathbb{C}} t^\bullet$ to denote the sets of pre- and postplaces of \mathbb{C} , respectively. The set of all cells of a net N is denoted by $BC(N)$.

Markov decision processes: A Markov decision process (MDP) is a tuple (S, A, δ, r, s_0) consisting of finite sets S, A of states and actions, a function $\delta: S \times A \rightarrow \mathcal{D}(S)$ of probabilistic transitions (where $\mathcal{D}(S)$ is the set of probability distributions on S), a reward function $r: S \times A \times S \rightarrow \mathbb{R}$ of rewards and an initial state $s_0 \in S$ (see also [6,15]).

⁴ Indeed, $[\text{id}]$ BPN contains any safe and acyclic Petri net, omitting the free-choice constraint.

A policy (or strategy) for an MDP is some function $\pi: S \rightarrow A$. It has been shown that such stationary deterministic policies can act optimally in such an (infinite-horizon) MDP setting (see also [15]). A policy gives rise to a Markov chain on the set of states with transitions $s \mapsto \delta(s, \pi(s)) \in \mathcal{D}(S)$. The associated probability space is $s_0 S^\omega$, the set of all infinite paths on S starting with s_0 , which – due to its uncountable nature – has to be dealt with using measure-theoretic concepts. As before we equip the probability space with a σ -algebra generated by all cones, i.e., all sets of words sharing a common prefix.

The value (or payoff) of a policy π is then given as the expectation of the (undiscounted) total reward (where $\mathbf{s}_i, i \in \mathbb{N}_0$ are random variables, mapping an infinite path to the i -th state, i.e., they represent the underlying Markov chain):

$$\mathbb{E} \left[\sum_{n \in \mathbb{N}_0} r(\mathbf{s}_n, \pi(\mathbf{s}_n), \mathbf{s}_{n+1}) \right].$$

To avoid infinite values, we have to assume that the sum is bounded.

The problem of finding an optimal policy $\pi: S \rightarrow A$ for a given MDP (S, A, δ, r, s_0) with finite state and action space is known to be solvable in polynomial time using linear programming [15,19].

Bayesian Networks: Bayesian networks are graphical models that give compact representations of discrete probability distributions, exploiting the (conditional) independence of random variables.

A (finite) probability space (Ω, \mathbb{P}) consists of a finite set Ω and a probability function $\mathbb{P}: \Omega \rightarrow [0, 1]$ such that $\sum_{\omega \in \Omega} \mathbb{P}(\omega) = 1$. A Bayesian network [25] is a tuple (X, Δ, P) where

- $X = (X_i)_{i=1, \dots, n}$ is a (finite) family of random variables $X_i: \Omega \rightarrow V_i$, where V_i is finite.
- $\Delta \subseteq \{1, \dots, n\} \times \{1, \dots, n\}$ is an acyclic relation that describes dependencies between the variables, i.e., its transitive closure Δ^+ is irreflexive. By $\Delta^i = \{j \mid (j, i) \in \Delta\}$ we denote the parents of node i according to Δ .
- $P = (P_i)_{i=1, \dots, n}$ is a family of probability matrices $P_i: \prod_{j \in \Delta^i} V_j \rightarrow \mathcal{D}(V_i)$, whose entries are given by $P_i(v_i \mid (v_j)_{j \in \Delta^i})$.

A probability function \mathbb{P} is consistent with such a Bayesian network whenever for $v = (v_i)_{i=1, \dots, n} \in \prod_{i=1}^n V_i$ we have

$$\mathbb{P}(X = v) = \prod_{i=1}^n P_i(v_i \mid (v_j)_{j \in \Delta^i}).$$

The size of a Bayesian network is not just the size of the graph, but the sum of the size of all its matrices (where the size of an $m \times n$ -matrix is $m \cdot n$). In particular, note that a node with k parents in a binary Bayesian network (i.e., with $|V_i| = 2$ for all i) is associated with a 2×2^k probability matrix.

Example 2.1. An example Bayesian network is given in Figure 1. There are four random variables (a, b, c, d) with codomain $\{0, 1\}$. The tables in the figure denote the conditional probabilities, for instance $P_d(0 | 01) = \mathbb{P}(X_d = 0 | X_a = 0, X_b = 1) = 1/6$, i.e., one records the probability that a random variable has a certain value, dependent on the value of its parents in the graph. The probability $\mathbb{P}(X = 0100) = \mathbb{P}(X_a = 0, X_b = 1, X_c = 0, X_d = 0)$ is obtained by multiplying $P_a(0) \cdot P_b(1) \cdot P_c(0 | 0) \cdot P_d(0 | 01) = 1/3 \cdot 1/2 \cdot 2/3 \cdot 1/6 = 1/54$.

We are interested in the following two problems for Bayesian networks (see also [24]):

- D-PR: Given the Bayesian network (X, Δ, P) and $E = \{X_{i_1}, \dots, X_{i_\ell}\} \subseteq X$, $e \in V_E := \prod_{j=1}^{\ell} V_{i_j}$ (the evidence) and a rational $p > 0$, does it hold that $\mathbb{P}(E = e) > p$? This problem is known to be PP-complete [20].
- D-MAP: Given a Bayesian network (X, Δ, P) , a rational number $p > 0$, disjoint subsets $E, F \subseteq X$,⁵ and evidence $e \in V_E$, does there exist $f \in V_F$ such that $\mathbb{P}(F = f, E = e) > p$, or, if $\mathbb{P}(E = e) \neq \emptyset$, equivalently, $\mathbb{P}(F = f | E = e) > p$ (by adapting the bound p). It is known that this problem, also known as maximum a-posteriori problem, is NP^{PP}-complete (see [20,11]).

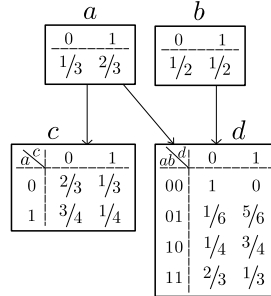

Fig. 1. A Bayesian Network

The corresponding proof in [24] also shows that the D-MAP problem remains NP^{PP}-complete if F only contains uniformly distributed ‘input’ nodes, i.e., nodes X_i with $\Delta^i = \emptyset$ and $P_i(x_i) = 1/|V_i|$, as well as $V_i = \{0, 1\}$ for all $i = 1, \dots, n$.

In particular, the following problem (where E, F are switched!) is still NP^{PP}-complete: Given a binary Bayesian network (X, Δ, P) (i.e., $V_i = \{0, 1\}$ for all i), a rational $p > 0$, disjoint subsets $E, F \subseteq X$ where F only contains uniformly distributed input nodes, as well as evidence $e \in V_E$, does there exist $f \in V_F$ such that $\mathbb{P}(E = e | F = f) > p$ (as $\mathbb{P}(F = f) = 1/2^{|F|}$ is independent of f and known due to uniformity)? We will, in the rest of this paper, refer to this modified problem as D-MAP instead of the original problem above.

Example 2.2 (D-MAP). Given the Bayesian Network in Figure 1 with $F = \{X_a\}$ (MAP variable), $E = \{X_c, X_d\}$, $e = (0, 1) \in V_c \times V_d$ (evidence) and $p = 1/3$, we ask whether $\exists f \in \{0, 1\}: \mathbb{P}(X_c = 0, X_d = 1 | X_a = f) > 1/3$. When choosing $f = 1 \in V_a$, the probability $\mathbb{P}(X_c = 0, X_d = 1 | X_a = 1) = 3/4 \cdot (1/2 \cdot 3/4 + 1/2 \cdot 1/3) = 13/32 > 1/3$ exceeds the bound. Note that to compute the value in this way, one has to sum up over all possible valuations of those variables that are neither evidence nor MAP variables, indicating that this is not a trivial task.

⁵ The variables contained in F are called MAP variables.

3 Stochastic decision Petri nets

We will enrich the definition of stochastic Petri nets to allow for interactivity, similar to how MDPs [6] extend the definition of Markov chains.

Definition 3.1. *A stochastic decision Petri net (SDPN) is a tuple $(P, T, \bullet(), ()^\bullet, A, m_0, C, R)$ where $(P, T, \bullet(), ()^\bullet, A, m_0)$ is a stochastic Petri net; $C \subseteq T$ is a set of controllable transitions; $R: \mathcal{P}(P) \rightarrow \mathbb{R}$ is a reward function.*

Here we describe the semantics of such SDPNs in a semi-formal way. The precise semantics is obtained by the encoding of SDPNs into MDPs in Section 4.

Given an SDPN, an external agent may in each step choose to manually deactivate any subset $D \subseteq C$ of controllable transitions (regardless of whether their preconditions are fulfilled or not). As such, if transitions $D \subseteq C$ are deactivated in marking $m \in \mathcal{M}(N)$, the SDPN executes a step according to the semantics of the stochastic Petri net $N_D = (P, T \setminus D, \bullet(), ()^\bullet, A_D, m_0)$ where the pre- and post-set functions and A_D are restricted accordingly.

For all rewarded sets $Q \in \text{supp}(R)$, the agent receives an “immediate” reward $R(Q)$ once all the places $p \in Q$ are reached at one point in the execution of the Petri net (although not necessarily simultaneously). In particular, any reward is only received once. Note that this differs from the usual definition of rewards as in MDPs, where a reward is received each time certain actions is taken in

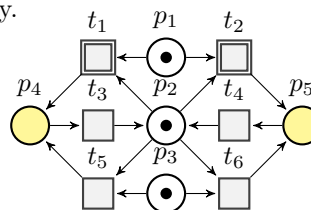

Fig. 2. Example SDPN

given states. However, logical formulae over reached places (such as “places p_1 and p_2 are reached without reaching place q ”) are more natural to represent by such one-time rewards instead of cumulative rewards.⁶ The framework can be extended to reward markings instead of places but at the cost of an exponential explosion, since to be able to compute the one-time step-wise rewards not only already reached places but already reached markings would have to be memorized. Note that a reward need not be positive.

More formally, given a firing sequence $\mu : m_0 \xrightarrow{t_1} m_1 \xrightarrow{t_2} \dots$, the agent receives a value or payoff of $V(\text{pl}(\mu))$ where $V(M) := \sum_{Q \subseteq M} R(Q)$.

Example 3.2. *As an example consider the SDPN in Figure 2. The objective is to mark both places coloured in yellow at some point in time (not necessarily at the same time). This can be described by a reward function R which assigns 1 to the set $\{p_4, p_5\}$ containing both yellow places and 0 to all other sets.*

The transitions with double borders (t_1, t_2) are controllable and it turns out that the optimal strategy is to deactivate both t_1 and t_2 first, in order to let t_5 or t_6 mark either of the two goal places before reaching the marking $(1, 1, 0, 0, 0)$ from which no information can be gained which of the two goal places have been marked. An optimal strategy thus has to have knowledge of already achieved sub-goals in terms of visited places. In this case, the strategy can deactivate one of the transitions (t_1, t_2) leading to the place already visited.

⁶ Firings of transitions can also easily be rewarded by adding an additional place.

Policies may be dependent on the current marking and the places accumulated so far. Now, for a given policy $\pi : \mathcal{M}(N) \times \mathcal{P}(P) \rightarrow \mathcal{P}(C)$, determining the set $\pi(m, Q) \subseteq C$ of deactivated transitions in marking m for the set Q of places seen so far, we consider the (continuous) probability space $m_0\mathcal{M}(N)^\omega$, describing the infinite sequence $m_0 \rightarrow_{t_1} m_1 \rightarrow_{t_2} \dots$ of markings generated by the Petri net under the policy π (i.e., if in step n the transitions $D_n := \pi(m_{n-1}, \bigcup_{k=0}^{n-2} \text{supp}(m_k))$ are deactivated).

Then we can consider the expectation of the random variable $V \circ pl$, i.e.,

$$\mathbb{V}^\pi := \mathbb{E}^\pi [V \circ pl],$$

over the probability space $m_0\mathcal{M}(N)^\omega$. We will call this the value of π and, if $\pi \equiv D \subseteq C$ is constant, simply write \mathbb{V}^D which we will call the value of D .

For the complexity analyses we assume that R is only stored on its support, e.g., as a set $R \subseteq \mathcal{P}(P) \times \mathbb{R}$ which we will interpret as a dictionary with entries $[Q : R(Q)]$ for some $Q \subseteq P$, as for many problems of interest the size of the support of the reward function can be assumed to be polynomially bounded w.r.t. to the set of places and transitions.

We consider the following problems for stochastic Petri nets, where we parameterize over a class \mathcal{N} of SDPNs and (for the second problem) over a class $\Psi \subseteq (\mathcal{M}(N) \times \mathcal{P}(P) \rightarrow \mathcal{P}(C))$ of policies:

- \mathcal{N} -VAL: Given a rational $p > 0$, a net $N \in \mathcal{N}$ and a policy $\pi \in \Psi$ for N , decide whether $\mathbb{V}^\pi > p$.
- \mathcal{N} -POL: Given a rational $p > 0$ and a net $N \in \mathcal{N}$, decide whether there exist a policy $\pi \in \Psi$ such that $\mathbb{V}^\pi > p$.

Although parameterized over sets of policies, we will omit Ψ if it is clear from the context (in fact we will restrict to constant policies from Section 5 onwards).

4 Stochastic decision Petri nets as Markov decision processes

We now describe how to transform an SDPN into an MDP, thus fixing the semantics of such nets. For unbounded Petri nets, the resulting MDP has an infinite state space, but we will restrict to the finite case later.

Definition 4.1. *Given an SDPN $N = (P, T, F, A, C, R, m_0)$ where m_0 is not the constant zero function, the MDP for N is defined as the tuple (S, A, δ, r, s_0) where*

- $S = \mathcal{R}(N) \times \mathcal{P}(P)$ (product of reachable markings and places collected),
- $A = \mathcal{P}(C)$ (sets of deactivated transition as actions),
- $\delta : (\mathcal{R}(N) \times \mathcal{P}(P)) \times \mathcal{P}(C) \rightarrow \mathcal{D}(\mathcal{R}(N) \times \mathcal{P}(P))$, with

$$\delta((m, Q), D)((m', Q')) := \begin{cases} p(m' \mid m, D) & \text{if } Q' = Q \cup \text{supp}(m), \\ 0 & \text{otherwise,} \end{cases}$$

where

$$p(m' \mid m, D) = \frac{\sum_{t \in \text{En}(m, D), m \rightarrow_t m'} \Lambda(t)}{\sum_{t \in \text{En}(m, D)} \Lambda(t)}$$

whenever $\text{En}(m, D) := \{t \in T \setminus D \mid \bullet t \leq m\} \neq \emptyset$. If $\text{En}(m, D) = \emptyset$, we set $p(m' \mid m, D) = 1$ if $m = m'$ and 0 if $m \neq m'$. That is, $p(m' \mid m, D)$ is the probability of reaching m' from m when transitions D are deactivated.

– $r: S \times A \times S \rightarrow \mathbb{R}$ (reward function) with

$$r((m, Q), D, (m', Q')) := \begin{cases} \sum_{Q \subseteq Y \subseteq Q'} R(Y) & \text{if } Q = \emptyset, \\ \sum_{Q \subsetneq Y \subseteq Q'} R(Y) & \text{if } Q \neq \emptyset. \end{cases}$$

– $s_0 = (m_0, \emptyset)$

The transition probabilities are determined as for regular stochastic Petri nets where we consider only the rates of those transitions that have not been deactivated and that can be fired for the given marking. If no transition is enabled, we stay at the current marking with probability 1.

Note that the reward for the places reached in a marking m is only collected when we fire a transition leaving m . This is necessary as in the very first step we also obtain the reward for the empty set, which might be non-zero, and due to the fact that the initial marking is assumed to be non-empty, this reward for the empty set is only collected once.

The following result shows that the values of policies $\pi: S \rightarrow A$ (note that these are exactly the policies for the underlying SDPN) over the MDP are equal to the ones over the corresponding SDPN.

Proposition 4.2. *Let $N = (P, T, F, \Lambda, C, R, m_0)$ be an SDPN and $M = (S, A, \delta, r, s_0)$ the corresponding MDP. For any policy $\pi: S \rightarrow A$, we have*

$$(\mathbb{V}^\pi =) \mathbb{E}^\pi [V \circ pl] = \mathbb{E}^\pi \left[\sum_{n \in \mathbb{N}_0} r(\mathbf{s}_n, \pi(\mathbf{s}_n), \mathbf{s}_{n+1}) \right]$$

where $(\mathbf{s}_n)_n$ is the Markov chain resulting from following policy π in M .

This provides an exact semantic for SDPNs via MDPs. Note, however, that for analysis purposes, even for safe Petri nets, the reachability set $\mathcal{R}(N)$ (as a subset of $\mathcal{P}(P)$) is generally of exponential size whence the transformation into an MDP can at best generally only yield algorithms of exponential worst-case-time. Hence, we will now restrict to specific subproblems and it will turn out that even with fairly severe restrictions to the type of net and the policies allowed, we obtain completeness results for complexity classes high in the polynomial hierarchy.

5 Complexity analysis for specific classes of Petri nets

For the remainder of this paper, we will consider the problem of finding optimal *constant* policies for certain classes of nets. In other words, the agent chooses *before* the execution of the Petri net which transitions to deactivate for its *entire* execution. For a net N , the policy space is thus given by

$$\Psi(N) = \{\pi : \mathcal{M}(N) \rightarrow \mathcal{P}(C) \mid \pi \equiv D \subseteq C\} \hat{=} \mathcal{P}(C).$$

Since one can non-deterministically guess the maximizing policy (there are only exponentially many) and compute its value, it is clear that the complexity of the policy optimization problem \mathcal{N} -POL is bounded by the complexity of the corresponding value problem \mathcal{N} -VAL as follows: If, for a given class \mathcal{N} of Petri nets, \mathcal{N} -VAL lies in the complexity class C , then \mathcal{N} -POL lies in NP^C .

We will now show the complexity of these problems for the three Petri net classes FCON, SAFC, and $[\varphi]$ BPN and work out the connection to Bayesian networks. In the following we will assume that all probabilities are efficiently computable, allowing us to simulate all probabilistic choices with fair coins.

5.1 Complexity of safe and acyclic free-choice decision nets

We will first consider the case of Petri nets where the length of runs is bounded.

Proposition 5.1. *For any polynomial φ , the problem $[\varphi]$ BPN-VAL is in PP. In particular, $[\varphi]$ BPN-POL is in NP^{PP} .*

Proof (sketch). Given a Petri net N , a policy π and a bound p , a PP-algorithm for $[\varphi]$ BPN-VAL can simulate the execution of the Petri net and calculate the resulting value, checking whether the expected value for π is greater than the pre-defined bound p . For this, we have to suitably adapt the threshold (with an affine function ψ) so that the probabilistic Turing machine accepts with probability greater than $1/2$ iff the reward for the given policy is strictly greater than p .

As the execution of the Petri net takes only polynomial time in the size of the Petri net (φ), this can be performed by a probabilistic Turing machine in polynomial time whence $[\varphi]$ BPN-VAL lies in PP.

Since a policy can be guessed in polynomial time, we can also infer that $[\varphi]$ BPN-POL is in NP^{PP} . \square

This easily gives us the following corollary for SAFC nets.

Corollary 5.2. *The problem SAFC-VAL is in PP and SAFC-POL in NP^{PP} .*

Proof. This follows directly from Proposition 5.1 and the fact that $\text{SAFC} \subseteq [\text{id}] \text{BPN}$. \square

Proposition 5.3. *The problem SAFC-POL is NP^{PP} -hard and, therefore, also NP^{PP} -complete.*

Proof (sketch). This can be proven via a reduction $\text{D-MAP} \leq_p \text{SAFC-POL}$, i.e., representing the modified D-MAP problem for Bayesian networks as a decision problem in safe and acyclic free-choice nets. NP^{PP} -completeness then follows together with Corollary 5.2. Note that we are using the restricted version of the D-MAP problem as explained in Section 2 (uniformly distributed input nodes, binary values).

We sketch the reduction via an example: we take the Bayesian network in Figure 1 and consider a D-MAP instance where $E = \{X_c, X_d\}$ (evidence, where we fix the values of c, d to be 0, 1), $F = \{X_a\}$ (MAP variables) and p is a threshold. That is, the question being asked for the Bayesian network is whether there exists a value x such that $\mathbb{P}(X_c = 0, X_d = 1 \mid X_a = x) > p$.

This Bayesian network is encoded into the SAFC net in Figure 3, where transitions with double borders are controllable and the yellow places give a reward of 1 when both are reached (not necessarily at the same time). Transitions either have an already indicated rate of 1 or the rate can be looked up in the corresponding matrix of the BN. The rate of a transition $t_{x_1 x_2 \rightarrow x_3}^i$ is the probability value $P_i(x_3 \mid x_1 x_2)$, where P_i is the probability matrix for $i \in \{a, b, c, d\}$.

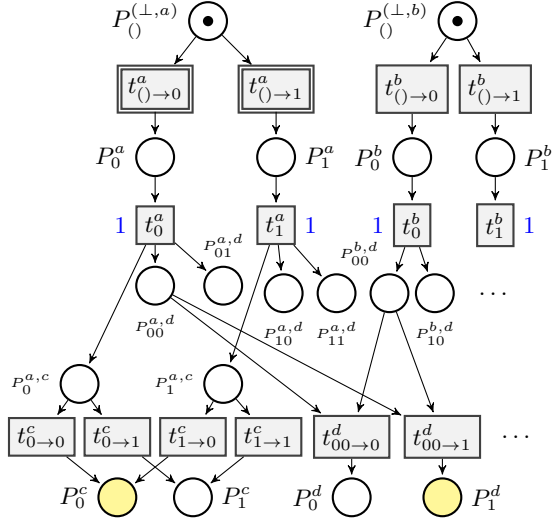

Fig. 3. SAFC net corresponding to BN in Figure 1

Intuitively the first level of transitions simulates the probability tables of P^a, P^b , the nodes without predecessors in the Bayesian network, where for instance the question of whether P_0^a or P_1^a are marked corresponds to the value of the random variable X_a associated with node a . Since X_a is a MAP variable, its two transitions are controllable. Note that enabling both transitions will never give a higher reward than enabling only one of them. (This is due to the fact that $\max\{x, y\} \geq p_1 \cdot x + p_2 \cdot y$ for $p_1, p_2 \geq 0$ with $p_1 + p_2 = 1$.)

The second level of transitions (each with rate 1) is inserted only to obtain a free-choice net by creating sufficiently many copies of the places in order to make all conflicts free-choice.

The third level of transitions simulates the probability tables of P^c, P^d , only to ensure the net being free-choice we need several copies. For instance, transition $t_{0 \to 0}^c$ consumes a token from place $P_0^{a,c}$, a place specifically created for the entry $P^c(c = 0 \mid a = 0)$ in the probability table of node c .

In the end the aim is to mark the places P_0^c and P_1^d , and we can find a policy (deactivating either $t_{() \to 0}^a$ or $t_{() \to 1}^a$) such that the probability of reaching both places exceeds p if and only if the D-MAP instance specified above has a solution.

This proof idea can be extended to more complex Bayesian networks, for a more formal proof see the appendix. \square

In fact, a reduction in the opposite direction (from Petri nets to Bayesian networks) is possible as well under mild restrictions, which shows that these problems are closely related.

Proposition 5.4. *For two given constants k, ℓ , consider the following problem: let N be a SAFC decision Petri net, where for each branching cell the number of controllable transitions is bounded by some constant k . Furthermore, given its reward function R , we assume that $|\cup_{Q \in \text{supp}(R)} Q| \leq \ell$. Given a rational number p , does there exist a constant policy π such that $\mathbb{V}^\pi > p$?*

This problem can be polynomially reduced to D-MAP.

Proof (sketch). We sketch the reduction, which is inspired by [8], via an example: consider the SAFC net in Figure 5, where the problem is to find a deactivation pattern such that the payoff exceeds p . We encode the net into a Bayesian network (Figure 4), resulting in an instance of the D-MAP problem.

We have four types of random variables: place variables ($X_p, p \in P$), which record which place is marked; transition variables ($X_{t_1}, X_{t_5}, X_{t_6}$), one for each controllable transition, which are the MAP variables; cell variables (X_{C_i} for $C_1 = \{t_1, t_2\}$, $C_2 = \{t_3, t_4\}$, $C_3 = \{t_5, t_6\}$) which are non-binary and which record which transition in the cell was fired or whether no transition was fired (ε); a reward variable (X_{rew}) such that $\mathbb{P}(X_{rew} = 1)$ equals the function ψ applied to the payoff. Note that we use the affine function ψ from the proof of Proposition 5.1 to represent rewards as probabilities in the interval $[0, 1]$. The threshold for the D-MAP instance is $\psi(p)$. Dependencies are based on the structure of the given SAFC net. For instance, X_{C_3} is dependent on X_{p_3}, X_{p_4} (since $\bullet C_3 = \{p_3, p_4\}$) and X_{t_5}, X_{t_6} (since t_5, t_6 are the controllable transitions in C_3).

Both the matrices of cell and place variables could become exponentially large, however this problem can be resolved easily by dividing the matrices into smaller ones and cascading them. Since the number of controllable transitions is bounded by k and the number of rewarded places by ℓ , they will not cause an exponential blowup of the corresponding matrix.

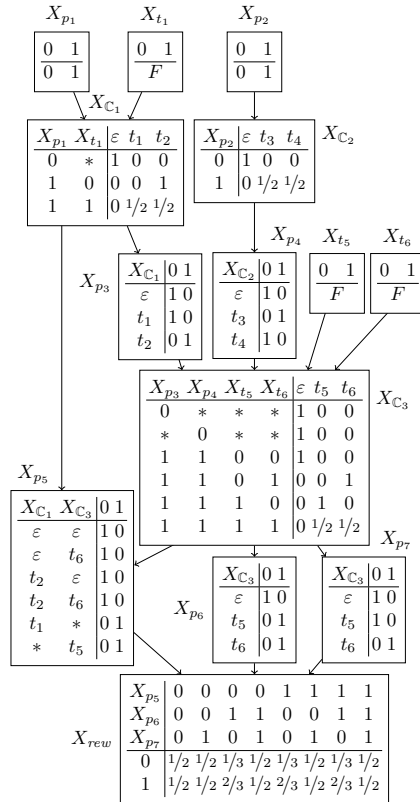

Fig. 4. Bayesian network obtained from the SAFC net in Figure 5 below. Entries $*$ are ‘don’t-care’ values.

\square

Corollary 5.5. *The problem SAFC-VAL is PP-hard and, therefore, also PP-complete.*

Proof. We note that using the construction in the proof of Proposition 5.3 with the set F of MAP variables being empty, we can reduce the D-PR problem for Bayesian networks to the SAFC-VAL problem, showing that SAFC-VAL is PP-hard. Using Corollary 5.2, this yields that SAFC-VAL is PP-complete. \square

Corollary 5.6. *For any polynomial $\varphi : \mathbb{N}_0 \rightarrow \mathbb{N}_0$ fulfilling $\varphi(n) \geq n$ for all $n \in \mathbb{N}_0$, the problem $[\varphi]$ BPN-VAL is PP-complete and $[\varphi]$ BPN-POL is NP^{PP} -complete.*

Proof. As any safe and acyclic free-choice net is an *id*-bounded net, it is, in particular, a φ -bounded net with φ as above, and we have $\text{SAFC-VAL} \leq_p [\varphi]\text{BPN-VAL}$ and $\text{SAFC-POL} \leq_p [\varphi]\text{BPN-POL}$. Propositions 5.1 and 5.3 as well as Corollary 5.5, therefore show that $[\varphi]\text{BPN-VAL}$ is PP-complete and $[\varphi]\text{BPN-POL}$ is NP^{PP} -complete. \square

5.2 Complexity of free-choice occurrence decision nets

Now we further restrict SAFC nets to occurrence nets, which leads to a substantial simplification. The main reason for this is the absence of backwards-conflicts, which means that each place is uniquely generated, making it easier to trace causality, i.e., there is a unique minimal configuration that generates each place.

Proposition 5.7. *The problem FCON-VAL is in P. In particular, FCON-POL is in NP.*

Proof (sketch). Determining the probability of reaching a set of places Q in an occurrence net amounts to multiplying the probabilities of the transitions on which the places in Q are causally dependent. This can be done for every set Q in the support of the reward function R , which enables us to determine the expected value in polynomial time, implying that FCON-VAL lies in P. By guessing a policy for an occurrence net with controllable transitions, we obtain that FCON-POL lies in NP. \square

Proposition 5.8. *The problem FCON-POL is NP-hard and, therefore, also NP-complete.*

Proof (sketch). To show NP-hardness we reduce 3-SAT (the problem of deciding the satisfiability of a propositional formula in conjunctive normal form with at most three literals per clause) to FCON-POL. Given a formula ψ , this is done by constructing a simple occurrence net with parallel controllable transitions, one for each atomic proposition ℓ in ψ . Then we define a reward function with polynomial support in such a way that the expected reward for the constructed net is larger or equal than the number of clauses iff the formula has a model. The correspondence between the model and the policy is such that transitions whose atomic propositions are evaluated as true are deactivated. \square

6 An algorithm for SAFC decision nets

Here we present a partial-order algorithm for solving the policy problem for SAFC (decision) nets. It takes such a net and converts it into a formula for an SMT solver. We will assume the following, which is also a requirement for occurrence nets:

Assumption 6.1. *For all places $p \in m_0$: $\bullet p := \{t \in T \mid p \in t^\bullet\} = \emptyset$.*

This is a mild assumption since any transition $t \in \bullet p$ for a place $p \in m_0$ in a safe and acyclic net has to be dead as all places can only be marked once.

We are now using the notion of (branching) cells, introduced in Section 2: The fact that the SDPN is safe, acyclic and free-choice ensures that choices in different cells are taken independently from another, so that the probability of a configuration $\tau \in \mathcal{C}(N)$ under a specific deactivation pattern $D \subseteq C$ is given by

$$\mathbb{P}^D(\text{tr} \supseteq \tau) = \prod_{t \in \tau} \frac{\chi_{T \setminus D}(t) \cdot \Lambda(t)}{\sum_{t \in \mathcal{C}_t \setminus D} \Lambda(t)} = \begin{cases} 0 & \text{if } \tau \cap D \neq \emptyset \\ \prod_{t \in \tau} \frac{\Lambda(t)}{\sum_{t' \in \mathcal{C}_t \setminus D} \Lambda(t')} & \text{otherwise} \end{cases}$$

where $\chi_{T \setminus D}$ is the characteristic function of $T \setminus D$ and $0/0$ is defined to yield 0.

The general idea of the algorithm is to rewrite the reward function $R : \mathcal{P}(P) \rightarrow \mathbb{R}$ on sets of places to a reward function on sets of transitions that yields a compact formula for computing the value \mathbb{V}^D for specific sets D (i.e., solving SAFC-VAL), that we can also use to solve the policy problem SAFC-POL via an SMT solver.

We first need some definitions:

Definition 6.2. *For a maximal configuration $\tau \in \mathcal{C}^\omega(N_D)$ for a given deactivation pattern $D \subseteq C$, we define its set of prefixes in $\mathcal{C}(N_D)$ to be*

$$\text{pre}^D(\tau) := \{\tau' \in \mathcal{C}(N_D) \mid \tau' \subseteq \tau\}$$

which corresponds to all configurations that can lead to the configuration τ . We also define the set of extensions of a configuration $\tau \in \mathcal{C}(N_D)$ in $\mathcal{C}^\omega(N_D)$, which corresponds to all maximal configurations that τ can lead to, as

$$\text{ext}^D(\tau) := \{\tau' \in \mathcal{C}^\omega(N_D) \mid \tau \subseteq \tau'\}.$$

Definition 6.3. *Let N be a Petri net with a reward function $R : \mathcal{P}(P) \rightarrow \mathbb{R}$ on places and a deactivation pattern D . A reward function $[R] : \mathcal{P}(T) \rightarrow \mathbb{R}$ on transitions is called consistent with R if for each firing sequence $\mu \in \mathcal{FS}(N_D)$:*

$$V(\text{pl}(\mu)) = \sum_{Q \subseteq \text{pl}(\mu)} R(Q) = \sum_{\tau \in \text{pre}^D(\text{tr}(\mu))} [R](\tau).$$

This gives us the following alternative method to determine the expected value for a net (with given policy D):

Lemma 6.4. *Using the setting of Definition 6.3, whenever $[R]$ is consistent with the reward function R and $[R](\tau) = 0$ for all $\tau \notin \mathcal{C}(N)$, the expected value for the net N under the constant policy D is:*

$$\mathbb{V}^D = \sum_{\tau \subseteq T} \mathbb{P}^D(\text{tr} \supseteq \tau) \cdot [R](\tau).$$

Note that $[R](\text{tr}(\mu)) := V(\text{pl}(\mu))$ for $\mu \in \mathcal{FS}(N)$ fulfills these properties trivially. However, rewarding only maximal configurations can lead, already in occurrence nets with some concurrency, to an exponential support (w.r.t. the size of the net and its reward function). The goal of our algorithm is to instead make use of the sum over the configurations by rewarding reached places immediately in the corresponding configuration, generating a function $[R]$ that fulfills the properties above and whose support remains of polynomial size in occurrence nets. Hence, we have some form of partial-order technique, in particular concurrent transitions receive the reward independently of each other (if the reward is not dependent on firing both of them).

The rewriting process is performed by iteratively ‘removing maximal cells’ and resembles a form of backward-search algorithm. First of all, \preceq_N^* (the reflexive and transitive closure of causality \prec_N) induces a partial order \sqsubseteq on the set $BC(N)$ of cells via

$$\forall \mathbb{C}, \mathbb{C}' \in BC(N) : \mathbb{C} \sqsubseteq \mathbb{C}' \iff \exists t \in \mathbb{C}, t' \in \mathbb{C}' : t \preceq_N^* t'.$$

Let all cells $(\mathbb{C}_1, \dots, \mathbb{C}_m)$ with $m = |BC(N)|$ be ordered conforming to \sqsubseteq , then we let N_k denote the Petri net consisting of places $P_k := P \setminus (\bigcup_{l > k} \mathbb{C}_l^\bullet) \cup (\bigcup_{l \leq k} \mathbb{C}_l^\bullet)$ (where the union with the post-sets is only necessary if backward-conflicts exist) and transitions $T_k := \bigcup_{l \leq k} \mathbb{C}_l$, the remaining components being accordingly restricted (note that the initial marking m_0 is still contained in P_k by Assumption 6.1). In particular, it holds that $N = N_m$ as well as $T_0 = \emptyset$ and $P_0 = \{p \in P \mid \forall t \in T : p \notin t^\bullet\}$.

Let N be a Petri net with deactivation pattern D , $\mu \in \mathcal{FS}(N_D)$ be a firing sequence and $k \in \{1, \dots, |BC(N)|\}$. We write $\text{tr}_{\leq k}(\mu) := \text{tr}(\mu) \cap T_k$ for the transitions in the first k cells and $\text{tr}_{> k}(\mu) := \text{tr}(\mu) \setminus T_k$ for the transitions in the cells after the k -th cell as well as $\text{pl}_{\leq k}(\mu) := m_0 \cup (\bigcup_{t \in \text{tr}_{\leq k}(\mu)} t^\bullet)$ for the places reached after all transitions in the first k cells were fired.

We will now construct auxiliary reward functions $R[k]$ that take pairs of a set of places ($U \subseteq P_k$) and of transitions ($V \subseteq T \setminus T_k$) as input and return a reward. Intuitively, $R[k](U, V)$ corresponds to the reward for reaching all places in U and then firing all transitions in V afterwards where reaching U ensures that all transitions in V can fire.

Starting with the reward function $R[m] : \mathcal{P}(P) \times \{\emptyset\} \rightarrow \mathbb{R}$, $(M, \emptyset) \mapsto R(M)$, we iteratively compute reward functions $R[k] : \mathcal{P}(P_k) \times \mathcal{P}(T \setminus T_k) \rightarrow \mathbb{R}$ for $k \geq 0$:

$$R[k](U, V) := \begin{cases} R[k+1](U, V) & \text{if } \mathbb{C}_{k+1} \cap V = \emptyset \\ \sum_{\substack{U' \cap t^\bullet \neq \emptyset \\ U = U' \setminus t^\bullet \cup t}} R[k+1](U', V \setminus \{t\}) & \text{if } \mathbb{C}_{k+1} \cap V = \{t\} \\ 0 & \text{otherwise} \end{cases}$$

The first case thus describes a scenario where no transition from the $(k+1)$ -th cell is involved while the second case sums up all rewards that are reached when some transition t in the cell has to be fired (that is, all rewards that are given when some of the places in t^\bullet are reached). We give non-zero values only to sets V that contain at most one transition of each cell and U has to contain the full pre-set of t of the transition t removed from V . This is done in order to ensure that in subsequent steps those transitions that generate t^\bullet are in the set to which we assign the reward. This guarantees that V is always a configuration of N after marking U while $R[k](U, V)$ is zero if the transitions in V cannot be fired after U . In this way, rewards are ultimately only given to configurations and to no other sets of transitions, enabling us later to compute the probabilities of those configurations.

And if N is an occurrence net, every entry in $R[k+1]$ produces at most one entry in $R[k]$, meaning that $\text{supp}(R[k]) \leq \text{supp}(R[k+1])$.

Now we can prove that the value of a firing sequence is invariant when rewriting the auxiliary reward functions as described above.

Proposition 6.5. *The auxiliary reward functions satisfy*

$$\sum_{V \subseteq \text{tr}_{>k}(\mu)} \sum_{U \subseteq \text{pl}_{\leq k}(\mu)} R[k](U, V) = \sum_{V \subseteq \text{tr}_{>k+1}(\mu)} \sum_{U \subseteq \text{pl}_{\leq k+1}(\mu)} R[k+1](U, V),$$

for $k \in \{0, \dots, |BC(N)| - 1\}$.

Hence, for every $\mu \in \mathcal{FS}(N)$

$$V(\text{pl}(\mu)) = \sum_{U \subseteq \text{pl}(\mu)} R[|BC(N)|](U, \emptyset) = \sum_{V \subseteq \text{tr}_{>k}(\mu)} \sum_{U \subseteq \text{pl}_{\leq k}(\mu)} R[k](U, V),$$

which means that we obtain a reward function on transitions consistent with R by defining $[R] : \mathcal{P}(T) \rightarrow \mathbb{R}$ as

$$[R](V) := \sum_{U \subseteq m_0} R[0](U, V).$$

This leads to the following corollary:

Corollary 6.6. *Given a net N and a deactivation pattern D , we can calculate the expected value*

$$\mathbb{V}^D = \mathbb{E}[V \circ \text{pl}] = \sum_{\tau \subseteq T} \prod_{t \in \tau} \frac{\chi_{T \setminus D}(t) \cdot \Lambda(t)}{\sum_{t' \in \mathbb{C}_t \setminus D} \Lambda(t')} [R](\tau).$$

Checking whether some deactivation pattern D exists such that this term is greater than some bound p can be checked by an SMT solver.

Note that, in contrast to the naive definition of $[R]$ only on maximal configurations, this algorithm constructs a reward function on configurations that, for occurrence nets, has a support with at most $\text{supp}(R)$ elements. For arbitrary SAFC nets, the support of $[R]$ might be of exponential size.

Example 6.7. We take the Petri net from Figure 5 as an example (where all transitions have firing rate 1). The reward function R is given in the table below. By using the inclusion-exclusion principle we ensure that one obtains reward 1 if one or both of the yellow places are marked at some point without ever marking the red place. The optimal strategy is obviously to only deactivate the one transition (t_6) which would mark the red place.

The net has three cells $\mathbb{C}_1 = \{t_1, t_2\}$, $\mathbb{C}_2 = \{t_3, t_4\}$, and $\mathbb{C}_3 = \{t_5, t_6\}$ where $\mathbb{C}_1, \mathbb{C}_2 \sqsubseteq \mathbb{C}_3$. As such, $R[3] = R$ with R below and obtain $R[2]$ (due to $P_2 = \{p_1, p_2, p_3, p_4, p_5\}$). In the next step, we get (by removing t_3 and t_4) $R[1]$ and finally $R[0]$, from which we can derive $[R]$, the reward function on transitions, as described above.

This allows us to write the value for a set D of deactivated transitions as follows (where if both $t_5, t_6 \in D$, we assume the last quotient to be zero)

$$\mathbb{V}^D = \frac{\chi_{T \setminus D}(t_1)}{\chi_{T \setminus D}(t_1) + 1} + \frac{1}{\chi_{T \setminus D}(t_1) + 1} \frac{1}{2} \frac{\chi_{T \setminus D}(t_5)}{\chi_{T \setminus D}(t_5) + \chi_{T \setminus D}(t_6)}$$

$R = [\{p_5\} : 1, \{p_6\} : 1, \{p_5, p_6\} : -1, \{p_5, p_7\} : -1, \{p_6, p_7\} : -1, \{p_5, p_6, p_7\} : 1]$
$R[2] = [(\{p_5\}, \emptyset) : 1, (\{p_3, p_4\}, \{t_5\}) : 1, (\{p_3, p_4, p_5\}, \{t_6\}) : -1]$
$R[1] = [(\{p_5\}, \emptyset) : 1, (\{p_2, p_3\}, \{t_3, t_5\}) : 1, (\{p_2, p_3, p_5\}, \{t_3, t_6\}) : -1]$
$R[0] = [(\{p_1\}, \{t_1\}) : 1, (\{p_1, p_2\}, \{t_2, t_3, t_5\}) : 1]$
$[R] = [\{t_1\} : 1, \{t_2, t_3, t_5\} : 1]$

Writing $x_i := \chi_{T \setminus D}(t_i) \in \{0, 1\}$, $i = 1, 5, 6$, the resulting inequality

$$\frac{x_1}{x_1 + 1} + \frac{1}{2} \frac{1}{x_1 + 1} \frac{x_5}{x_5 + x_6} > p$$

can now be solved by an SMT solver with Boolean variables x_1, x_5 , and x_6 (i.e., $x_1, x_5, x_6 \in \{0, 1\}$).

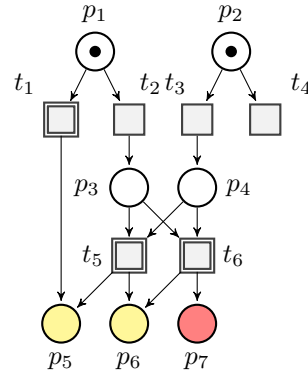

Fig. 5. A SAFC decision net. The goal is to mark one or both of the yellow places at some point without ever marking the red place.

Runtime results: To test the performance of our algorithm, we performed runtime tests on specific families of simple stochastic decision Petri nets, focussing on the impact of concurrency and backward-conflicts on its runtime. All families are based on a series of simple branching cells each containing two transitions, one controllable and one non-controllable, reliant on one place as a precondition. Each non-controllable transition marks a place to which we randomly assigned a reward according to a normal distribution (in particular, it can be negative). The families differ in how these cells are connected, testing performance with concurrency, backward-conflicts, and sequential problems, respectively (for a detailed overview of the experiments see Appendix D).

Rewriting the reward function (and, thus, solving the value problem) produced expected results: Runtimes on nets with many backward-conflicts are exponential while the rewriting of reward functions of occurrence nets exhibits a much better performance, reflecting its polynomial complexity.

To solve the policy problem based on the rewritten reward function, we compared the performances of naively calculating the values of each possible deactivation pattern with using an SMT solver (Microsoft’s z3, see also [12]). Tests showed a clear impact on the representation of the control variables (describing the deactivation set D) as booleans or as integers bounded by 0 and 1 with the latter showing a better performance. Furthermore, the runtime of solving the rewritten formula with an SMT solver showed a high variance on random reward values. Nonetheless, the results show the clear benefit of using the SMT solver on the rewritten formula in scenarios with a high amount of concurrency, with much faster runtimes than the brute force approach. In scenarios without concurrency, this benefit vanishes, and in scenarios with many backward-conflicts, the brute force approach is considerably faster than solving the rewritten function with an SMT solver. The latter effect can be explained by the rewritten reward function $[R]$ having an exponential support in this scenario.

All in all, the runtime results reflect the well-known drawbacks and benefits of most partial-order techniques, excelling in scenarios with high concurrency while having a reduced performance if there are backward- and self-conflicts.

7 Conclusion

We have introduced the formalism of stochastic decision Petri nets and defined its semantics via an encoding into Markov decision processes. It turns out that finding optimal policies for a model that incorporates concurrency, probability and decisions, is a non-trivial task. It is computationally hard even for restricted classes of nets and constant policies. However, we remark that workflow nets are often SAFC nets and a constant deactivation policy is not unreasonable, given that one cannot monitor and control a system all the time. We have also presented an algorithm for the studied subproblem, which we view as a step towards efficient partial-order techniques for stochastic (decision) Petri nets.

Related Work: Petri nets [26] are a well-known and widely studied model of concurrent systems based on consumption and generation of resources. Several

subclasses of Petri nets have received attention, among them free-choice nets [13] and occurrence nets, where the latter are obtained by unfolding Petri nets for verification purposes [14].

Our notion of stochastic decision Petri nets is an extension of the well-known model of stochastic Petri nets [21]. This model and a variety of generalizations are used for the quantitative analyses of concurrent systems. Stochastic Petri nets come in a continuous-time and in a discrete-time variant, as treated in this paper. That is, using the terminology of [28], we consider the corresponding Markov chain of jumps, while in the continuous-time case, firing rates determine not only the probability which transition fires next, but also how fast a transition will fire dependent on the marking. These firing times are exponentially distributed, a distribution that is memoryless, meaning that the probability of a transition firing is independent on its waiting time.

Our approach was motivated by extending the probabilistic model of stochastic Petri nets by a mechanism for decision making, as in the extension of Markov chains [28] to Markov decision processes (MDPs) [6]. Since the size of a stochastic Petri net might be exponentially smaller than the Markov chain that it generates, the challenge is to provide efficient methods for determining optimal strategies, preferably partial order methods that avoid the explicit representation of concurrent events in an interleaving semantics. Our complexity results show that the quest for such methods is non-trivial, but some results can be achieved by suitably restricting the considered Petri nets.

A different approach to include decision-making in Petri nets was described by Beccuti et al. as Markov decision Petri nets [5,4]. Their approach, based on a notion of well-formed Petri nets, distinguishes explicitly between a probabilistic part and a non-deterministic part of the Petri net as well as a set of components that control the transitions. They use such nets to model concurrent systems and obtain experimental results. In a similar vein, graph transformation systems – another model of concurrent systems into which Petri nets can be encoded – have been extended to probabilistic graph transformation systems, including decisions in the MDP sense [18]. The decision is to choose a set of rules with the same left-hand side graph and a match, then a randomized choice is made among these rules. Again, the focus is on modelling and to our knowledge neither of these approaches provides complexity results.

Another problem related to the ones considered in this paper is the computation of the expected execution time of a timed probabilistic Petri net as described in [22]. The authors treated timed probabilistic workflow nets (TPWNs) which assumes that every transition requires a fixed duration to fire, separate from the firing probability. They showed that approximating the expected time of a sound SAFC TPWN is $\#P$ -hard which is the functional complexity class corresponding to PP. While the problems studied in their paper and in our paper are different, the fact that both papers consider SAFC nets and obtain a $\#P$ - respectively PP-hardness result seems interesting and deserves further study.

Our complexity results are closely connected with the analysis of Bayesian networks [25], which are a well-known graphical formalism to represent condi-

tional dependencies among random variables and can be employed to reason about and compactly represent probability distributions. The close relation between Bayesian networks and occurrence nets was observed in [8], which gives a Bayesian network semantics for occurrence nets, based on the notion of branching cells from [1] that were introduced in order to reconcile partial order methods – such as unfoldings – and probability theory. We took inspiration from this reduction in Proposition 3 and another of our reductions (Proposition 5.3) – encoding Petri nets as Bayesian networks – is a transformation going into the other direction, from Bayesian networks to SAFC nets.

In our own work [9,7] we considered a technique for uncertainty reasoning, combining both Petri nets and Bayesian networks, albeit in a rather different setting. There we considered Petri nets with uncertainty, where one has only probabilistic knowledge about the current marking of the net. In this setting Bayesian networks are used to compactly store this probabilistic knowledge and the main challenge is to update respectively rewrite Bayesian networks representing such knowledge whenever the Petri net fires.

Future Work: As future work we plan to consider more general classes of Petri nets, lifting some of the restrictions imposed in this paper. In particular, it would be interesting to extend the method from Section 6 to nets that allow infinite runs. Furthermore, dropping the free-choice requirement is desirable, but problematic. While the notion of branching cells does exist for stochastic nets (see [1,8]), it does not accurately reflect the semantics of stochastic nets (see e.g. the discussion on confusion in the introduction of [8]).

As already detailed in the introduction, partial-order methods for analyzing probabilistic systems, modelled for instance by stochastic Petri nets, are in general poorly understood. Hence, it would already be a major result to obtain scalable methods for computing payoffs values for a stochastic net without decisions, but with a high degree of concurrency.

In addition we plan to use the encoding of Petri nets into Bayesian networks from [8] (on which we based the proof of Proposition 5.4) and exploit it to analyze such nets by using dedicated methods for reasoning on Bayesian networks.

Naturally, it would be interesting to extend analysis techniques in such a way that they can deal with uncertainty and derive policies when we have only partial knowledge, as in partially observable Markov decision process (POMDPs), first studied in [3]. However, this seems complex, given the fact that determining the best strategy for POMDPs is a non-trivial problem in itself [10].

Similarly, it is interesting to introduce a notion of time as in continuous-time Markov chains [28], enabling us to compute expected execution times as in [22].

Last but not least, our complexity analysis and algorithm focus on finding optimal constant policies. A natural step would be to instead consider the problem of finding optimal positional strategies as defined in Chapter 3, which is the focus of most works on Markov decision processes (see for example [10]).

References

1. Samy Abbes and Albert Benveniste. True-concurrency probabilistic models: branching cells and distributed probabilities for event structures. *Information and Computation*, 204(2):231–274, 2006.
2. Sanjeev Arora and Boaz Barak. *Computational Complexity: A Modern Approach*. Cambridge University Press, 2009.
3. Karl Johan Astrom. Optimal control of Markov decision processes with incomplete state estimation. *J. Math. Anal. Applic.*, 10:174–205, 1965.
4. Marco Beccuti, Elvio Gilberto Amparore, Susanna Donatelli, Dimitri Scheftelowitzsch, Peter Buchholz, and Giuliana Franceschinis. Markov decision Petri nets with uncertainty. In *Prof. of EPEW '15*, volume 9272 of *LNCS*, pages 177–192. Springer, 2015.
5. Marco Beccuti, Giuliana Franceschinis, and Serge Haddad. Markov decision Petri net and Markov decision well-formed net formalisms. In *Petri Nets and Other Models of Concurrency*, volume 4546 of *LNCS*, pages 43–62. Springer, 2007.
6. Richard Bellman. A Markovian decision process. *Journal of mathematics and mechanics*, 6(5):679–684, 1957.
7. Rebecca Bernemann, Benjamin Cabrera, Reiko Heckel, and Barbara König. Uncertainty reasoning for probabilistic Petri nets via Bayesian networks. In *Proc. of FSTTCS '20*, volume 182 of *LIPICs*, pages 38:1–38:17. Schloss Dagstuhl – Leibniz Center for Informatics, 2020.
8. Roberto Bruni, Hernán C. Melgratti, and Ugo Montanari. Bayesian network semantics for Petri nets. *Theor. Comput. Sci.*, 807:95–113, 2020.
9. Benjamin Cabrera, Tobias Heindel, Reiko Heckel, and Barbara König. Updating probabilistic knowledge on Condition/Event nets using Bayesian networks. In *Proc. of CONCUR '18*, volume 118 of *LIPICs*, pages 27:1–27:17. Schloss Dagstuhl – Leibniz Center for Informatics, 2018.
10. Anthony R. Cassandra. *Exact and Approximate Algorithms for Markov Decision Processes*. PhD thesis, Brown University, USA, 1998.
11. Cassio P. de Campos. New complexity results for MAP in Bayesian networks. In *Proc. of IJCAI '11*, pages 2100–2106. IJCAI/AAAI, 2011.
12. Leonardo de Moura and Nikolaj Bjørner. Z3: An efficient SMT solver. In *Proc. of TACAS '08*, pages 337–340. Springer, 2008.
13. Jörg Desel and Javier Esparza. *Free choice Petri nets*. Number 40 in Cambridge Tracts in Theoretical Computer Science. Cambridge University Press, 1995.
14. Javier Esparza and Keijo Heljanko. *Unfoldings: A Partial Order Approach to Model Checking*. Springer, 2008.
15. E.A. Feinberg and A. Shwartz, editors. *Handbook of Markov Decision Processes*. Kluwer, Boston, MA, 2002.
16. M. R. Garey and D. S. Johnson. *Computers and Intractability*. Freeman, 1979.
17. Charles Grinstead and Laurie Snell. Markov chains. In *Introduction to Probability*, chapter 11, pages 405–470. American Mathematical Society, second edition, 1997.
18. Christian Krause and Holger Giese. Probabilistic graph transformation systems. In *Proc. of ICGT '12*, volume 7562 of *LNCS*, pages 311–325. Springer, 2012.
19. Michael L. Littman, Thomas L. Dean, and Leslie Pack Kaelbling. On the complexity of solving Markov decision problems. In *Proc. of UAI '95*, pages 394–402. Morgan Kaufmann, 1995.
20. Michael L. Littman, Stephen M. Majercik, and Toniann Pitassi. Stochastic boolean satisfiability. *Journal of Automated Reasoning*, 27(3):251–296, 2001.

21. Marco Ajmone Marsan. Stochastic Petri nets: an elementary introduction. In *Advances in Petri Nets 1989*, volume 424 of *LNCS*, pages 1–29. Springer, 1989.
22. Philipp J. Meyer, Javier Esparza, and Philip Offtermatt. Computing the expected execution time of probabilistic workflow nets. In *Proc. of TACAS '19*, volume 11428 of *LNCS*, pages 154–171. Springer, 2019.
23. Christos H. Papadimitriou. *Computational complexity*. Addison-Wesley, 1994.
24. James D. Park and Adnan Darwiche. Complexity results and approximation strategies for MAP explanations. *Journal of Artificial Intelligence Research*, 21:101–133, 2004.
25. Judea Pearl. *Causality: Models, Reasoning, and Inference*. Cambridge University Press, 2000.
26. Wolfgang Reisig. *Petri Nets: An Introduction*. EATCS Monographs on Theoretical Computer Science. Springer-Verlag, Berlin, Germany, 1985.
27. Seinosuke Toda. PP is as hard as the polynomial-time hierarchy. *SIAM Journal on Computing*, 20(5):865–877, 1991.
28. Anders Tolver. An introduction to Markov chains. *Department of Mathematical Sciences, University of Copenhagen*, 2016.

A Proofs and Additional Material for §4 (Stochastic decision Petri nets as Markov decision processes)

Proposition 4.2. *Let $N = (P, T, F, \Lambda, C, R, m_0)$ be an SDPN and $M = (S, A, \delta, r, s_0)$ the corresponding MDP. For any policy $\pi : S \rightarrow A$, we have*

$$(\mathbb{V}^\pi =) \mathbb{E}^\pi [V \circ pl] = \mathbb{E}^\pi \left[\sum_{n \in \mathbb{N}_0} r(\mathbf{s}_n, \pi(\mathbf{s}_n), \mathbf{s}_{n+1}) \right]$$

where $(\mathbf{s}_n)_n$ is the Markov chain resulting from following policy π in M .

Proof. Consider a sequence of states s_1, \dots, s_n , $n \in \mathbb{N}_0$ of the MDP where $s_i = (m_i, Q_i)$, $m_i \in \mathcal{R}(N)$, $Q_i \subseteq P$. Using the notation of Definition 4.1 we obtain

$$\begin{aligned} & \mathbb{P}^\pi(\mathbf{s}_1 = s_1, \dots, \mathbf{s}_n = s_n) \\ &= \prod_{k=1}^n \delta(s_{k-1}, \pi(s_{k-1}))(s_k) \\ &= \begin{cases} \prod_{k=1}^n p(m_k | m_{k-1}, \pi(s_{k-1})) & \text{if for all } k = 1, \dots, n : Q_k = \bigcup_{i=0}^{k-1} \text{supp}(m_i), \\ 0 & \text{otherwise} \end{cases} \\ &= \begin{cases} \mathbb{P}^\pi((m_1, \dots, m_n)) & \text{if for all } k = 1, \dots, n : Q_k = \bigcup_{i=0}^{k-1} \text{supp}(m_i), \\ 0 & \text{otherwise} \end{cases} \end{aligned}$$

where $\mathbb{P}^\pi((m_1, \dots, m_n))$ is the probability of the sequence (m_1, \dots, m_n) in the Petri net N under policy π .

The result can then be seen from the following equations

$$\begin{aligned} & \mathbb{E}^\pi \left[\sum_{n \in \mathbb{N}} r(\mathbf{s}_{n-1}, \pi(\mathbf{s}_{n-1}), \mathbf{s}_n) \right] \\ &= \lim_{n \rightarrow \infty} \mathbb{E}^\pi \left[\sum_{k=1}^n r(\mathbf{s}_{k-1}, \pi(\mathbf{s}_{k-1}), \mathbf{s}_k) \right] \\ &= \lim_{n \rightarrow \infty} \sum_{s_1, \dots, s_n \in S} \mathbb{P}^\pi(\mathbf{s}_1 = s_1, \dots, \mathbf{s}_n = s_n) \sum_{k=1}^n r(s_{k-1}, \pi(s_{k-1}), s_k) \\ &= \lim_{n \rightarrow \infty} \sum_{m_1, \dots, m_n \in \mathcal{M}(N)} \mathbb{P}^\pi((m_0, \dots, m_n)) \sum_{Q \subseteq \bigcup_{k=0}^n \text{supp}(m_k)} R(Q) \\ &= \lim_{n \rightarrow \infty} \sum_{M \subseteq P} \mathbb{P}^\pi(pl_{\leq n} = M) \sum_{Q \subseteq M} R(Q) \\ &= \sum_{M \subseteq P} \mathbb{P}^\pi(pl = M) \sum_{Q \subseteq M} R(Q) \\ &= \mathbb{E}^\pi [V \circ pl] \end{aligned}$$

where we use in the first equation that the random variables

$$\mathbf{r}_n := \sum_{k=1}^n r(\mathbf{s}_{k-1}, \pi(\mathbf{s}_{k-1}), \mathbf{s}_k)$$

are uniformly bounded by construction. \square

Example A.1. We consider the Petri net from Example 3.2 and spell out its corresponding MDP (see Figure 6).

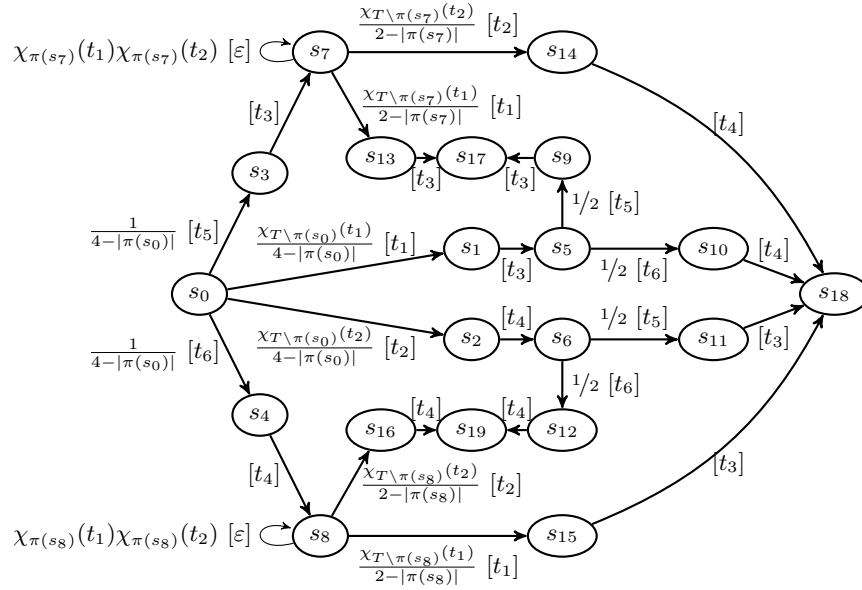

Fig. 6. MDP from example Petri net

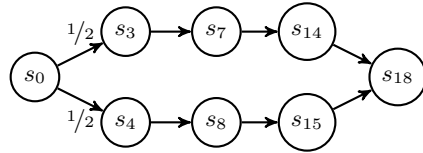

Fig. 7. Markov chain of optimal strategy in MDP for example Petri net.

We note that the reachability graph of the net consists of ten markings:

$$m_0 = \begin{pmatrix} 1 \\ 1 \\ 0 \\ 0 \end{pmatrix}, \quad m_1 = \begin{pmatrix} 0 \\ 1 \\ 1 \\ 0 \end{pmatrix}, \quad m_2 = \begin{pmatrix} 0 \\ 0 \\ 1 \\ 1 \end{pmatrix}, \quad m_3 = \begin{pmatrix} 1 \\ 0 \\ 0 \\ 0 \end{pmatrix}, \quad m_4 = \begin{pmatrix} 1 \\ 0 \\ 0 \\ 1 \end{pmatrix},$$

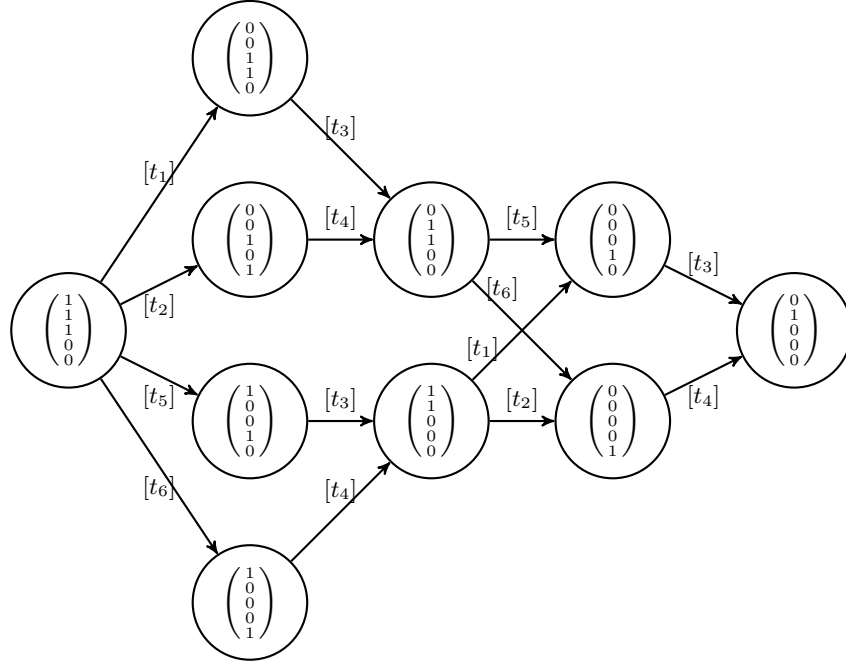

Fig. 8. Reachability graph of example Petri net (Example 3.2)

$$m_5 = \begin{pmatrix} 0 \\ 1 \\ 1 \\ 0 \\ 0 \end{pmatrix}, \quad m_6 = \begin{pmatrix} 1 \\ 1 \\ 0 \\ 0 \\ 0 \end{pmatrix}, \quad m_7 = \begin{pmatrix} 0 \\ 0 \\ 0 \\ 1 \\ 0 \end{pmatrix}, \quad m_8 = \begin{pmatrix} 0 \\ 0 \\ 0 \\ 0 \\ 1 \end{pmatrix}, \quad m_9 = \begin{pmatrix} 0 \\ 1 \\ 0 \\ 0 \\ 0 \end{pmatrix}$$

(see also Figure 8). Firing rates are constant: $\Lambda \equiv 1$. The corresponding MDP has twenty states:

$$\begin{aligned} s_0 &= (m_0, \emptyset), s_1 = (m_1, M^{-,-}), s_2 = (m_2, M^{-,-}), s_3 = (m_3, M^{-,-}), \\ s_4 &= (m_4, M^{-,-}), s_5 = (m_5, M^{+,-}), s_6 = (m_5, M^{-,+}), s_7 = (m_6, M^{+,-}), \\ s_8 &= (m_6, M^{-,+}), s_9 = (m_7, M^{+,-}), s_{10} = (m_8, M^{+,-}), s_{11} = (m_7, M^{-,+}), \\ s_{12} &= (m_8, M^{-,+}), s_{13} = (m_7, M^{+,-}), s_{14} = (m_8, M^{+,-}), s_{15} = (m_7, M^{-,+}), \\ s_{16} &= (m_8, M^{-,+}), s_{17} = (m_9, M^{+,-}), s_{18} = (m_9, M^{+,+}), s_{19} = (m_9, M^{-,+}), \end{aligned}$$

(see also Figure 6) where $M^{-,-} = \{p_1, p_2, p_3\}$ signifies that none of the places p_4 and p_5 have been reached previously, $M^{+,-} = \{p_1, p_2, p_3, p_4\}$ and $M^{-,+} = \{p_1, p_2, p_3, p_5\}$ that p_4 or p_5 were reached, respectively, and $M^{+,+} = \{p_1, p_2, p_3, p_4, p_5\}$ that both were reached (and, thus, the reward received).

As previously remarked for the Petri net, in this MDP, the optimal strategy is to deactivate both t_1 and t_2 in s_0 and then activate only whichever transition leads to the place that was not yet visited, yielding the Markov chain in Figure 7.

B Proofs and Additional Material for §5 (Complexity analysis for specific classes of Petri nets)

Proposition 5.1. *For any polynomial φ , the problem $[\varphi]$ BPN-VAL is in PP. In particular, $[\varphi]$ BPN-POL is in NP^{PP} .*

Proof. We give a PP-algorithm that solves $[\varphi]$ BPN-VAL, i.e., given a $[\varphi]$ -bounded stochastic Petri net N and a lower bound $p \in \mathbb{R}$, determine whether the expected value of the net is greater than p .

As, by definition, the length of runs of the net N is bounded by $\varphi(|T| + |P|)$, each run either terminates after a polynomial number of steps. Hence we can simulate the net with a probabilistic Turing machine and whenever the run terminates, we can determine the value for this run.

Hence the main difficulty is the following: A probabilistic Turing machine can check whether a given property is satisfied in more than half of all runs of the algorithm. As such, it could, for example, easily check whether, in more than half of all runs of the Petri net, its value (or payoff) is greater than a pre-defined threshold. Our goal, however, is to check whether the *expected value* of the total reward is greater than a threshold.

We show that this can also be checked in polynomial time. We calculate

$$V_{\min} := \sum_{Q \in \text{supp}(R^-)} R(Q)$$

where R^- is the negative part of the reward function R (i.e., V_{\min} is the sum of all negative rewards), and similarly

$$V_{\max} := \sum_{Q \in \text{supp}(R^+)} R(Q)$$

where R^+ is the positive part of R .

As any reward can only be granted once, the value of any run of the Petri net (and, in particular, its value \mathbb{V}) lies in $[V_{\min}, V_{\max}]$. If $p \notin [V_{\min}, V_{\max}]$, we can, therefore, already safely output that $\mathbb{V} > p$ is true (if $p < V_{\min}$) or false (if $p > V_{\max}$).

If $p \in [V_{\min}, V_{\max}]$, we define an affine linear transformation

$$\psi: \mathbb{R} \rightarrow \mathbb{R}, x \mapsto \frac{x - V_{\min}}{V_{\max} - V_{\min}}$$

which maps any possible value to a number in $[0, 1]$, and define $\tilde{p} := \psi(p) \in [0, 1]$.

The probabilistic Turing machine can then simulate a run μ of the Petri net and calculate the total value for its execution which can be done in polynomial time by definition of $[\varphi]$ BPN. Then, the linear transformation ψ is applied to the value V_μ which yields $\rho_\mu = \psi(V_\mu) \in [0, 1]$. Assume for now that we terminate with probability ρ_μ with success and otherwise with a failure. This ensures that the algorithm terminates with probability greater than \tilde{p} if and only if the value

$\psi(V(pl(\mu)))$ of the run μ is greater than $\tilde{p} = \psi(p)$, which is equivalent to the value \mathbb{V} being greater than p . In more detail:

$$\begin{aligned} \tilde{p} &< \sum_{\mu} \mathbb{P}(\mu) \cdot \rho_{\mu} = \sum_{\mu} \mathbb{P}(\mu) \cdot \psi(V(pl(\mu))) = \mathbb{E}[\psi(V(pl(\mu)))] \\ \Leftrightarrow \psi(p) &< \psi\left(\sum_{\mu} \mathbb{P}(\mu) \cdot V(pl(\mu))\right) = \psi(\mathbb{E}[V(pl(\mu))]) \\ \Leftrightarrow p &< \sum_{\mu} \mathbb{P}(\mu) \cdot V(pl(\mu)) = \mathbb{E}[V(pl(\mu))] = \mathbb{V} \end{aligned}$$

where we use that ψ is a strictly monotone affine linear function (and thus, in particular, commutes with expected values).

Note however that it should be the case that a word is in the language iff the PP machine accepts it with probability strictly greater than $1/2$.

To adapt the threshold accordingly, we define

$$\sigma := (1/2 - \tilde{p}) / (|1/2 - \tilde{p}| + 1/2),$$

and insert an additional step before simulating the net:

If $\sigma < 0$, the algorithm outputs false with probability $-\sigma$ (and continues its execution otherwise), and if $\sigma \geq 0$, the algorithm outputs true with probability σ (and continues its execution otherwise). This ensures that the probability of reaching a success in the rest of the algorithm has to be at least \tilde{p} instead of $1/2$.

This can be seen as follows, where p_S denotes the probability of success for the rest of the execution:

– $\tilde{p} > 1/2$, which implies $\sigma < 0$: then the success probability is $(1 + \sigma)p_S$ and we have

$$\frac{1}{2} < (1 + \sigma)p_S \iff \frac{1}{2} < \left(1 + \frac{1/2 - \tilde{p}}{\tilde{p}}\right)p_S \iff \frac{1}{2} < \frac{1}{2\tilde{p}}p_S \iff \tilde{p} < p_S$$

– $\tilde{p} \leq 1/2$, which implies $\sigma \geq 0$: then the success probability is $\sigma + (1 - \sigma)p_S$ and we have

$$\begin{aligned} \frac{1}{2} < \sigma + (1 - \sigma)p_S &\iff \frac{1}{2} < \frac{1/2 - \tilde{p}}{1 - \tilde{p}} + \left(1 - \frac{1/2 - \tilde{p}}{1 - \tilde{p}}\right)p_S \iff \\ &\frac{1/2 \cdot (1 - \tilde{p})}{1 - \tilde{p}} < \frac{1/2 - \tilde{p}}{1 - \tilde{p}} + \frac{(1 - \tilde{p}) - (1/2 - \tilde{p})}{1 - \tilde{p}}p_S \iff \\ &\frac{1/2 \cdot \tilde{p}}{1 - \tilde{p}} < \frac{1/2}{1 - \tilde{p}}p_S \iff \tilde{p} < p_S, \end{aligned}$$

which concludes the proof. \square

Proposition 5.3. *The problem SAFC-POL is NP^{PP} -hard and, therefore, also NP^{PP} -complete.*

Proof. We show NP^{PP} -hardness by reduction of the NP^{PP} -hard D-MAP problem for Bayesian networks (see also Section 2) to the SAFC-POL problem for (safe and acyclic free-choice) decision Petri nets.

As such, we are given a Bayesian network $((X_1, \dots, X_n), \Delta, P)$, disjoint sets $E, F \subseteq X$ of evidence and MAP variables, evidence $e \in E$, and a threshold $p \in [0, 1]$. To prove NP^{PP} -hardness of SAFC-POL, we construct an instance of the SAFC-POL problem such that

$$\max_{D \subseteq C} \mathbb{V}^D > p \quad \Leftrightarrow \quad \max_{f \in V_F} \mathbb{P}(E = e \mid F = f) > p.$$

The idea behind the construction is to simulate the computation in the Bayesian network by a SAFC net N . More intuition for this proof is given in the proof sketch in the main body of the paper.

We define the set of places P of N to contain all places of the form

- p_v^i for $i \in \{1, \dots, n\}, v \in \{0, 1\}$ (places representing the fact that the random variable of node i has value v), as well as
- $p_{\tilde{v}}^{(j,i)}$ for $i \in \{1, \dots, n\}, \tilde{v} \in \{0, 1\}^{\Delta^i}$, and $j \in \Delta^i$ if $\Delta^i \neq \emptyset$ and $j = \perp$ otherwise (auxiliary places, ensuring the fact that the net is free-choice).

Similarly, its transition set T contains two types of transitions:

- transitions $t_{\tilde{v} \rightarrow v}^i$ for $i \in \{1, \dots, n\}, \tilde{v} \in \prod_{j \in \Delta^i} \{0, 1\}$, and $v \in \{0, 1\}$ with firing rates $\Lambda(t_{\tilde{v} \rightarrow v}^i) = P_i(v \mid \tilde{v})$ (transitions simulating the probabilistic choices in the Bayesian network),
- transitions t_v^i for $v \in \{0, 1\}$ with firing rate 1 (auxiliary transitions).

All in all, this amounts to $2 + \max(1, |\Delta^i|) \cdot 2^{|\Delta^i|} \in \mathcal{O}(n \cdot 2^{|\Delta^i|})$ places and $2 + 2 \cdot 2^{|\Delta^i|} \in \mathcal{O}(2^{|\Delta^i|})$ transitions for each $i \in \{1, \dots, n\}$. As the matrices P_i of the Bayesian network contain $2^{|\Delta^i|+1}$ entries (hence the size of the input is already exponential in the $|\Delta^i|$), this SAFC-net is thus of polynomial size in the size of the network.

The initial marking then puts one token in precisely each place $p_0^{(\perp, j)}$ and the flow relation is defined as follows (all values not given are 0):

$$\begin{aligned} \bullet(t_v^i)(p_v^i) &= 1 \\ (t_v^j) \bullet(p_{\tilde{v}}^{(j,i)}) &= 1 \\ \bullet(t_{\tilde{v} \rightarrow v}^i)(p_{\tilde{v}}^{(j,i)}) &= 1 \\ (t_{\tilde{v} \rightarrow v}^i) \bullet(p_v^i) &= 1 \end{aligned}$$

Note that the only direct (free-choice) conflicts exist between transitions of the form $t_{\tilde{v} \rightarrow v}^i$ for different values v but equal \tilde{v} and i . Intuitively, these conflicts simulate the probabilistic decision of choosing a value v for the random variable X_i in the Bayesian network when given the parent values \tilde{v} . In this sense, the places p_v^i being marked in the execution of the net can be understood as the

variable X_i taking the value v in this simulation of the Bayesian network. The transitions t_v^i then forward this signal to the child nodes in the network by duplicating the token in p_v^i to the places $p_{\tilde{v}}^{(i,j)}$ which can be seen as the input from node i to the node j for the decision when \tilde{v} are all parent values in node j . For our construction, this duplication step is necessary to ensure that the net remains free-choice (removing the duplication and directly feeding places p_v^i into transitions $t_{\tilde{v} \rightarrow v'}^j$ would yield a smaller correct but non-free-choice net).

Now, for the given evidence $e \in V_E$, we define the reward function as

$$R(Q) = \begin{cases} 1 & \text{if } Q = \{p_{e_i}^i \mid X_i \in E\}, \\ 0 & \text{otherwise,} \end{cases}$$

such that the reward is only received if all the places corresponding to e are marked and the value thus represents the probability of reaching all these places.

Finally, we encode the MAP-variables F in the controllable transitions by defining

$$C = \{t_{() \rightarrow v}^i \mid X_i \in F, v \in \{0, 1\}\}$$

where we use the fact that F only contains input nodes.

By construction, the resulting net is an SAFFC net and can be constructed in polynomial time from the Bayesian network (as well as evidence and MAP variables). Furthermore, we have for all $f \in V_F$ that

$$\mathbb{V}^{D_f} = \mathbb{P}(E = e \mid F = f)$$

for $D_f := \{t_{() \rightarrow g_i}^i \mid X_i \in F, g_i \in \{0, 1\} \setminus \{f_i\}\}$, i.e., the set D_f that deactivates all transitions that would mark a place corresponding to a value $g_i \in \{0, 1\} \setminus \{f_i\}$ for X_i that differs from f_i , hence ensuring that all places corresponding to f are marked (with probability 1).

As such, if

$$\max_{f \in V_F} \mathbb{P}(E = e \mid F = f) > p,$$

we also have

$$\max_{D \subseteq C} \mathbb{V}^D > p.$$

On the other hand, we note that the maximal value \mathbb{V}^D has to be reached for a set D that deactivates all but one transition for all two-element sets of $\{t_{() \rightarrow v}^i \mid v \in \{0, 1\}\}$ for $i \in \{1, \dots, n\}$.

To see this, note that clearly deactivating both transitions will not maximize the probability of reaching the goal places. Assume that $F = F' \uplus \{\bar{f}\}$ and for node \bar{f} we activate both transitions. However, this cannot result in a higher reward, due to the fact that ⁷

$$\max_{b \in \{0, 1\}} \mathbb{P}(E = e \mid F' = f, \bar{f} = b)$$

⁷ Note that since the input nodes are uniformly distributed, the denominators are always non-zero.

$$\begin{aligned}
&= \mathbb{P}(E = e \mid F' = f, \bar{f} = 0) \vee \mathbb{P}(E = e \mid F' = f, \bar{f} = 1) \\
&= \frac{\mathbb{P}(E = e, \bar{f} = 0 \mid F' = f)}{\mathbb{P}(\bar{f} = 0 \mid F' = f)} \vee \frac{\mathbb{P}(E = e, \bar{f} = 1 \mid F' = f)}{\mathbb{P}(\bar{f} = 1 \mid F' = f)} \\
&\geq \mathbb{P}(\bar{f} = 0 \mid F' = f) \cdot \frac{\mathbb{P}(E = e, \bar{f} = 0 \mid F' = f)}{\mathbb{P}(\bar{f} = 0 \mid F' = f)} + \\
&\quad \mathbb{P}(\bar{f} = 1 \mid F' = f) \cdot \frac{\mathbb{P}(E = e, \bar{f} = 1 \mid F' = f)}{\mathbb{P}(\bar{f} = 1 \mid F' = f)} \\
&= \mathbb{P}(E = e, \bar{f} = 0 \mid F' = f) + \mathbb{P}(E = e, \bar{f} = 1 \mid F' = f) \\
&= \mathbb{P}(E = e \mid F' = f)
\end{aligned}$$

where the latter would be the reward that this policy gives us. The inequality above holds since $\max\{x, y\} \geq p_1 \cdot x + p_2 \cdot y$ for $p_1, p_2 \geq 0$ with $p_1 + p_2 = 1$.

Hence, defining $f_D \in D_F$ by $(f_D)_i := v$ for the unique $v \in \{0, 1\}$ with $t_{() \rightarrow v}^i \notin D$, we have that

$$\mathbb{V}^D = \mathbb{P}(E = e \mid F = f_D).$$

Therefore, also if

$$\max_{D \subseteq C} \mathbb{V}^D > p,$$

we have

$$\max_{f \in V_F} \mathbb{P}(E = e \mid F = f) > p$$

and vice versa.

All in all, this shows that the D-MAP problem can be reduced to the SAFC-POL problem in polynomial time with the same threshold $p \in [0, 1]$. \square

Proposition 5.4. *For two given constants k, ℓ , consider the following problem: let N be a SAFC decision Petri net, where for each branching cell the number of controllable transitions is bounded by some constant k . Furthermore, given its reward function R , we assume that $|\cup_{Q \in \text{supp}(R)} Q| \leq \ell$. Given a rational number p , does there exist a constant policy π such that $\mathbb{V}^\pi > p$?*

This problem can be polynomially reduced to D-MAP.

Proof. Given a net $N = (P, T, \bullet(), ()^\bullet, \Lambda, m_0, C, R)$ satisfying the restrictions and a threshold p we construct a D-MAP problem as follows:

First, we define a Bayesian network (X, Δ, P) with a set of random variables of the form:

- X_p for $p \in P$ (variables representing the presence of a token in each place)
- X_t for $t \in C$ (variables representing whether a controllable transition is activated)
- $X_{\mathbb{C}}$ for every branching cell \mathbb{C} (cf. Section 2) and finally
- X_{rew} as the only evidence variable in E

The subscripts (p, t, \mathbb{C}, rew) correspond to the nodes of the Bayesian network.

Second, we clarify which variables/nodes are dependent on one another:

- $\Delta^p = \{\mathbb{C} \in BC(N) \mid p \in \mathbb{C}^\bullet\}$
- $\Delta^t = \emptyset$
- $\Delta^C = \bullet\mathbb{C} \cup (C \cap \mathbb{C})$
- $\Delta^{rew} = \cup_{Q \in \text{supp}(R)} Q$

To complete the description of the Bayesian network, we now specify the probability matrices.

- For nodes representing controllable transitions ($X_t, t \in C$) we have no predecessor variables, hence they are all input nodes. These are the MAP variables F and will later be set to a specific boolean value according to the chosen policy π , when solving the D-MAP problem. As required by the considered variant of the D-MAP problem, we assume that they are uniformly distributed.
- For random variables representing places (X_p), whenever $\Delta_p = \emptyset$, we set $P_p(1) = 1$ if $p \in m_0$ and 0 otherwise. If p is in the post-set of a transition let $\Delta^p = \{\mathbb{C}_1, \dots, \mathbb{C}_n\}$. Keep in mind that cell variables as non-binary variables return a transition or ε . We define, for $t_j \in \mathbb{C}_j \cup \{\varepsilon\}$:

$$P_p(1 \mid t_1 \dots t_n) = \bigvee_{j \in \{1 \dots n\}} [p \in t_j^\bullet]$$

The binary operator $[p \in t^\bullet]$ returns 1 if place p is in the post set of transition t and 0 otherwise. If $t = \varepsilon$, the value is also 0.

Furthermore $P_p(0 \mid t_1 \dots t_n) = 1 - P_p(1 \mid t_1 \dots t_n)$.

- For a cell variable $X_{\mathbb{C}}$, let $\Delta^{\mathbb{C}} = \{p_1, \dots, p_m, t_1, \dots, t_k\}$, $v_i, u_j \in \{0, 1\}$ where $i \in \{1, \dots, m\}$, $j \in \{1, \dots, k\}$. That is v_i tells us if place p_i is marked and u_j specifies if transition $t_j \in C$ is activated. Let

$$Act(\mathbb{C}, u) = \{t \in \mathbb{C} \mid t \notin C \vee (t \in C \wedge \exists j (t = t_j \wedge u_j = 1))\}$$

be the set of transitions that are activated in \mathbb{C} (since they are either not controllable or controllable and activated). Now for every $t \in \mathbb{C}$ we have:

$$P_{\mathbb{C}}(t \mid v_1 \dots v_m u_1 \dots u_k) = \frac{\Lambda(t)}{\sum_{t' \in Act(\mathbb{C}, u)} \Lambda(t')}$$

if $v_1 \dots v_m = 1 \dots 1$ and $t \in Act(\mathbb{C}, u)$. The value is 0 otherwise. Instead:

$$P_{\mathbb{C}}(\varepsilon \mid v_1 \dots v_m u_1 \dots u_k) = 1 - \sum_{t \in \mathbb{C}} P_{\mathbb{C}}(t \mid v_1 \dots v_m u_1 \dots u_k),$$

in particular the value is 1 if $v_1 \dots v_m \neq 1 \dots 1$.

- For the reward node, we make use of the affine linear transformation ψ introduced in the proof of Proposition 5.1, using the lower and upper bounds V_{\min}, V_{\max} in order to represent the rewards as probabilities (mapping to $[0, 1]$). As already mentioned above, we also have to adapt the threshold p

to $\tilde{p} := \psi(p)$. Let $\Delta^{rew} = \{p_1, \dots, p_m\}$ and $v_i \in \{0, 1\}$, $i \in \{1, \dots, m\}$ binary values indicating whether p_i will be marked. Furthermore let $P_v = \{p_i \mid v_i = 1\}$ the corresponding set of marked places. Then

$$P_{rew}(1 \mid v_1 \dots v_m) = \psi \left(\sum_{\substack{Q \in \text{supp}(R) \\ Q \subseteq P_v}} R(Q) \right)$$

$$P_{rew}(0 \mid v_1 \dots v_m) = 1 - P_{rew}(1 \mid v_1 \dots v_m)$$

In order to completely define the D-MAP instance, we fix the evidence variables to $E = \{X_{rew}\}$ with $e = 1 \in V_e = \{0, 1\}$, the MAP variables to $F = \{X_t \mid t \in C\}$ and the threshold to \tilde{p} .

This D-MAP instance has a solution if there is a deactivation pattern $f \in V_F$ such that $\mathbb{P}(X_{rew} = 1 \mid F = f) > \tilde{p}$. Assuming that UC is the set of all functions⁸ $u: BC(N) \rightarrow T \cup \{\varepsilon\}$ such that $u(\mathbb{C}) = \varepsilon \vee u(\mathbb{C}) \in \mathbb{C}$, we ask – by evaluating the Bayesian network – whether there exists $f: C \rightarrow \{0, 1\}$ such that

$$\tilde{p} < \sum_{u \in UC} \sum_{v: P \rightarrow \{0,1\}} \prod_{p \in P} P_p(v(p) \mid (u(\mathbb{C}))_{\mathbb{C} \in \Delta^p}) \cdot \prod_{\mathbb{C} \in BC} P_{\mathbb{C}}(u(\mathbb{C}) \mid (v(p))_{p \in \Delta^{\mathbb{C}} \cap P}, (f(t))_{t \in \Delta^{\mathbb{C}} \cap C}) \cdot P_{rew}(1 \mid (v(p))_{p \in \Delta^{rew}})$$

We observe that for a given u, v , the product equals 0, unless v satisfies: $v(p) = 1$ iff $p \in m_0$ or there exists $t \in T$ such that $(p \in t^\bullet \wedge u(\mathbb{C}) = t)$, i.e., p is either initial or is generated by a transition that was fired. We denote this specific v by $v[u]$ and the term above becomes:

$$\sum_{u \in UC} \prod_{\mathbb{C} \in BC} P_{\mathbb{C}}(u(\mathbb{C}) \mid (v[u](p))_{p \in \Delta^{\mathbb{C}} \cap P}, (f(t))_{t \in \Delta^{\mathbb{C}} \cap C}) \cdot \psi \left(\sum_{\substack{Q \in \text{supp}(R) \\ Q \subseteq P_{v[u]}}} R(Q) \right)$$

$$= \psi \left(\sum_{u \in UC} \prod_{\mathbb{C} \in BC} P_{\mathbb{C}}(u(\mathbb{C}) \mid (v[u](p))_{p \in \Delta^{\mathbb{C}} \cap P}, (f(t))_{t \in \Delta^{\mathbb{C}} \cap C}) \cdot \sum_{\substack{Q \in \text{supp}(R) \\ Q \subseteq P_{v[u]}}} R(Q) \right)$$

This equality is true since ψ commutes with expected values (cf. proof of Proposition 5.1). Note that $P_{v[u]} = m_0 \cup (u[BC(N)] \setminus \{\varepsilon\})^\bullet$.

Due to the fact that ψ is strictly monotone, this value in turn is larger than or equal to $\tilde{p} = \psi(p)$ iff

$$p < \sum_{u \in UC} \prod_{\mathbb{C} \in BC} P_{\mathbb{C}}(u(\mathbb{C}) \mid (v[u](p))_{p \in \Delta^{\mathbb{C}} \cap P}, (f(t))_{t \in \Delta^{\mathbb{C}} \cap C}) \cdot \sum_{\substack{Q \in \text{supp}(R) \\ Q \subseteq P_{v[u]}}} R(Q)$$

Now we observe that any maximal configuration $\tau \in \mathcal{C}^\omega(N_D)$ (where $D = f^{-1}(\{0\})$) can be represented by a function $u: BC(N) \rightarrow T \cup \{\varepsilon\}$ defined as

⁸ These functions choose which transition is fired in each cell. We have to sum over all these functions to determine the probability.

$u(\mathbb{C}) = t$ if $\mathbb{C} \cap \tau = \{t\}$ and ε otherwise. This function u clearly satisfies $u(\mathbb{C}) = \varepsilon \vee u(\mathbb{C}) \in \mathbb{C}$.

Vice versa, given such a function u it only corresponds to a configuration $\tau = u[BC(N)] \setminus \{\varepsilon\}$ if the places in the initial marking and those generated by transitions in τ can cover every $\bullet\tau$, i.e., every transition in τ is enabled. In other words: $\bullet t \subseteq P_{v[u]}$ for all $t \in \tau$. Assume that $t \in \mathbb{C}$. If the inclusion $\bullet\mathbb{C} = \bullet t \subseteq P_{v[u]}$ does not hold, by definition:

$$P_{\mathbb{C}}(u(\mathbb{C}) \mid (v[u](p))_{p \in \Delta^c \cap P}, (f(t))_{t \in \Delta^c \cap C}) = 0,$$

which means that such summands disappear.

Furthermore, if u does correspond to a configuration τ , we have that

$$\mathbb{P}(tr = \tau) = \prod_{\mathbb{C} \in BC} P_{\mathbb{C}}(u(\mathbb{C}) \mid (v[u](p))_{p \in \Delta^c \cap P}, (f(t))_{t \in \Delta^c \cap C}),$$

that is, the probability of a configuration is obtained by multiplying the probability that its transitions ‘win’ against the other transitions in their cells, taking deactivated transitions into account.

Summarizing, this means that we check the inequality:

$$p < \sum_{\tau \in \mathcal{C}^\omega(N_D)} \mathbb{P}(tr = \tau) \cdot \sum_{\substack{Q \in \text{supp}(R) \\ Q \subseteq m_0 \cup \tau^\bullet}} R(Q) = \mathbb{E}[V \circ pl],$$

that is, we add up the rewards for each configuration, weighted by its probability, which is exactly the answer to the SAF-C-POL problem.

We give some additional intuition for this construction:

In the reduction above, it is apparent that there are only two types of variables that have matrix entries unequal to 0 or 1: variables representing cells and the reward variable. Cell variables are responsible for choosing and returning the transition firing in that specific cell according to the enabled transitions and their respective firing rates. All other variables (apart from the aforementioned reward variable) simply forward these information by adequately setting which places are marked or empty.

Because we work with acyclic Petri nets, there will be a final marking, in which no further transitions can fire. This implies that we will reach a point in time, where all places involved in a reward function have either been marked at least once or will never be marked. We can take note of this information by introducing a final reward marking consisting of bits for each of these places representing whether it was ever marked or always empty. By choosing a policy π , the transition probabilities in the cell variables are manipulated in order to fit the firing rates and therefore also how likely it is to reach each possible final reward marking.

Finally, given a policy π we obtain how probable each final reward marking is and we simply have to multiply this with the respective reward, which is already coded into the reward variable (albeit fit to the $[0, 1]$ interval) and sum up these

products. This is achieved through matrix multiplication in the BN and results in the expected reward for policy π .

Hence, if the policy problem for the SAFC net has a solution for bound p , the D-MAP problem also has a solution for bound \tilde{p} .

Finally, while the size of the graph underlying the Bayesian network is linear in the size of the Petri net, note that the size of the Bayesian network itself, i.e., the sum of the size of its matrices, could still be exponential. In particular, this occurs for random variables of type X_C or X_p , for which the number of parents is unbounded. Both corresponding types of nodes can easily be split up by cascading multiple variables with only two input variables, where the sum of the size of the matrices is only linear, giving us a polynomial reduction.

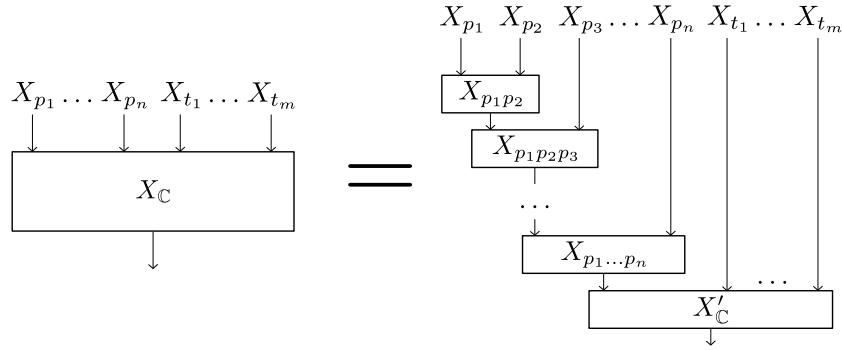

For the splitting of cell variables X_C we remember intermediate results of whether the places seen so far are all marked, basically by implementing a binary \wedge -operator. The matrix corresponding to the random variable $X_{p_1 \dots p_j}$ is denoted by $P_{p_1 \dots p_j}$ and we denote the matrix corresponding to X'_C by P'_C . We define:

$$P_{p_1 \dots p_i}(1 | y_1 y_2) = y_1 \wedge y_2 \quad y_i = \{0, 1\}$$

$$P'_C(t | v u_1 \dots u_m) = \begin{cases} P_C(t | \overbrace{1 \dots 1}^n u_1 \dots u_m) & , \text{ if } v = 1 \\ 0 & , \text{ otherwise} \end{cases}$$

$$P'_C(\varepsilon | v u_1 \dots u_m) = 1 - \sum_{t \in C} P'_C(t | v u_1 \dots u_m)$$

The last node is given the information whether all places are marked, checks which controllable transitions are activated and returns the entries of the original matrix P_C .

We now argue why this construction is correct: we define the probability function specified by the new network (on the right-hand side) by $\bar{\mathbb{P}}$ and the one by the original network (on the left-hand side) by \mathbb{P} . Then we have, given $t \in C \cup \{\varepsilon\}$:

$$\bar{\mathbb{P}}(X'_C = t | X_{p_1} = y_1, \dots, X_{p_n} = y_n, X_{t_1} = u_1, \dots, X_{t_m} = u_m)$$

$$= \sum_{w: \{2, \dots, n\} \rightarrow \{0,1\}} P'_C(t \mid w(n) u_1 \dots u_m) \cdot \prod_{j=3}^n P_{p_1 \dots p_j}(w(j) \mid w(j-1) y_j) \cdot P_{p_1 p_2}(w(2) \mid y_1 y_2)$$

Here w is a function that assigns (boolean) values to the intermediate wires. The product under the sum is only non-zero if $w(n) = 1$, due to the definition of P'_C , and – by induction – $w(j) = 1$ for all other indices j , otherwise the matrix entry of $P_{p_1 \dots p_j}$ equals 0. Hence, the above sum simplifies to

$$\begin{aligned} & P'_C(t \mid 1 u_1 \dots u_m) \cdot \prod_{j=3}^n P_{p_1 \dots p_j}(1 \mid 1 y_j) \cdot P_{p_1 p_2}(1 \mid y_1 y_2) \\ &= \begin{cases} P_C(t \mid 1 \dots 1 u_1 \dots u_m) & \text{if } y_1 = \dots = y_n = 1 \\ 0 & \text{otherwise} \end{cases} \\ &= P_C(t \mid y_1 \dots y_n u_1 \dots u_m) \\ &= \mathbb{P}(X'_C = t \mid X_{p_1} = y_1, \dots, X_{p_n} = y_n, X_{t_1} = u_1, \dots, X_{t_m} = u_m) \end{aligned}$$

Similarly, when splitting a place variable X_p , we save intermediate results on whether the transitions chosen and fired by the parent cells mark p . Therefore, here we produce a cascade with the binary \vee -operator.

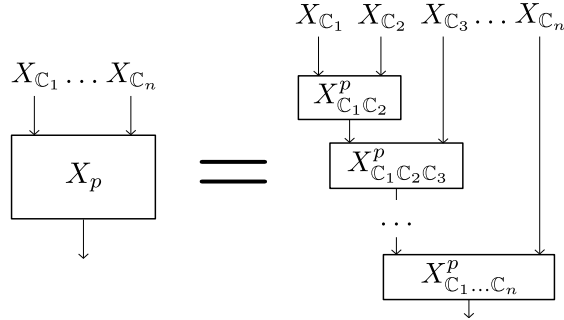

The probability matrix associated with $X_{C_1 \dots C_\ell}^p$ is denoted by $P_{C_1 \dots C_\ell}^p$ and we define:

$$\begin{aligned} P_{C_1 C_2}^p(1 \mid t_1 t_2) &= [p \in t_1^\bullet] \vee [p \in t_2^\bullet] \\ P_{C_1 \dots C_\ell}^p(1 \mid y t) &= y \vee [p \in t^\bullet] \end{aligned}$$

The correctness argument is analogous to the one above.

The fact that there are always at most k controllable transitions for each cell \mathbb{C} and the reward refers to at most ℓ places, all possible combinations can be encoded into the probability matrices for X_C and X_{rew} , which does not cause an exponential blowup. □

Proposition 5.7. *The problem FCON-VAL is in P. In particular, FCON-POL is in NP.*

Proof. To show that FCON-VAL is in P, we explain how to compute the value of a free-choice occurrence net without any controllable decisions. First we notice that

$$\begin{aligned}
\mathbb{V} &= \mathbb{E}[V \circ pl] = \sum_{\mu \in \mathcal{FS}(N)} \mathbb{P}(\mu) \cdot V(pl(\mu)) = \sum_{M \subseteq P} \mathbb{P}(pl = M) \cdot V(M) \\
&= \sum_{M \subseteq P} \mathbb{P}(pl = M) \cdot \sum_{Q \subseteq M} R(Q) = \sum_{M \subseteq P} \sum_{Q \subseteq M} (\mathbb{P}(pl = M) \cdot R(Q)) \\
&= \sum_{Q \subseteq M \subseteq P} (\mathbb{P}(pl = M) \cdot R(Q)) = \sum_{Q \subseteq P} \left(\sum_{Q \subseteq M \subseteq P} \mathbb{P}(pl = M) \right) \cdot R(Q) \\
&= \sum_{Q \subseteq P} \mathbb{P}(pl \supseteq Q) \cdot R(Q) = \sum_{Q \in \text{supp}(R)} \mathbb{P}(pl \supseteq Q) \cdot R(Q)
\end{aligned}$$

In particular, since R has polynomial support, it suffices to show that we can compute $\mathbb{P}(pl \supseteq Q)$ in polynomial time for any $Q \subseteq P$ which is exactly the probability of reaching at least all places $p \in Q$ (not necessarily simultaneously).

Now, as we are dealing with an occurrence net, we have that reaching $p \in P$ is equivalent to firing all transitions on which p is causally dependent. So let $T' = \{t \in T \mid \exists q \in Q: t \prec_N q\}$ be the set of transitions that are causes of places in Q . If two transitions $t, t' \in T'$ are now in conflict (which can be checked in polynomial time), the probability of reaching Q is zero. Otherwise, due to the net being free-choice, we can multiply the local firing probabilities of all transitions in T' to obtain the probability of reaching Q in polynomial time.

All in all, this procedure can be used to calculate \mathbb{V} whence FCON-VAL is in P.

That FCON-POL lies in NP follows from the fact that, given an occurrence net with controllable transitions, we can guess a policy in polynomial time and then solve the resulting FCON-VAL instance again in polynomial time. \square

Proposition 5.8. *The problem FCON-POL is NP-hard and, therefore, also NP-complete.*

Proof. We show NP-hardness by a polynomial reduction from 3-SAT to FCON-POL.

It is well-known that SAT, the problem of deciding whether a given propositional formula ψ is satisfiable, is NP-complete [23]. Its variant 3-SAT is still NP-complete, where the propositional formula ψ is in conjunctive normal form with exactly three literals per clause, i.e., $\psi = \bigwedge_{i \in I} (\ell_1^i \vee \ell_2^i \vee \ell_3^i)$, where $\ell_j^i \in \{x, \neg x \mid x \in \mathcal{X}\}$ for a set of atomic propositions $\mathcal{X} = \{x_1, \dots, x_n\}$.

Assume that we are given a 3-SAT instance, i.e., a propositional formula $\psi = \bigwedge_{i \in I} (\ell_1^i \vee \ell_2^i \vee \ell_3^i)$ where $\ell_j^i \in \{x, \neg x \mid x \in \mathcal{X}\}$ for a set of propositional formulas \mathcal{X} . Based on ψ we construct a free-choice occurrence SDPN N as follows:

- $P = \{p_x, q_x \mid x \in \mathcal{X}\}, T = \{t_x \mid x \in \mathcal{X}\}$, where $\bullet t_x(p_x) = 1$ and $\bullet t_x(p) = 0$ if $p \neq p_x$. Similarly $t_x \bullet(q_x) = 1$ and 0 for all other places. Furthermore $\Lambda \equiv 1$ (all rates are equal to 1) and $m_0(p_x) = 1, m_0(q_x) = 0$ for all $x \in \mathcal{X}$.
In other words, the net consists of $n = |\mathcal{X}|$ separate subnets, each with a single transition t_x that transfers a token from an input place p_x into an output place q_x . This construction can be performed in polynomial time in n and obviously results in a free-choice occurrence net.
- $C = T$, i.e., all transitions are controllable.

Now, only the reward function, which is central to this result, remains to be constructed. For this, we note that a place q_x for an atomic proposition $x \in \mathcal{X}$ is reached if and only if the transition t_x is not deactivated. We use this observation to encode the propositional formula ψ given above into a reward function as a formula on deactivated transitions t_x .

The reward function is constructed as follows: For each positive literal $\ell_j^i = x \in \mathcal{X}$, we define a reward function as

$$R_x : \mathcal{P}(P) \rightarrow \mathbb{R}, Q \mapsto \begin{cases} 1 & \text{if } Q = \emptyset, \\ -1 & \text{if } Q = \{q_x\}, \\ 0 & \text{otherwise,} \end{cases}$$

and for negative literals $\ell_j^i = \neg x$ for some $x \in \mathcal{X}$ as

$$R_{\neg x} : \mathcal{P}(P) \rightarrow \mathbb{R}, Q \mapsto \begin{cases} 1 & \text{if } Q = \{q_x\}, \\ 0 & \text{otherwise.} \end{cases}$$

Intuitively, this interprets x being true as not reaching q_x which in turn, due to the construction of the underlying net, is equivalent to t_x being deactivated. This gives us for sets $D \subseteq C = T$ of deactivated transitions and a literal $\ell_j^i \in \{x, \neg x \mid x \in \mathcal{X}\}$ the corresponding value function

$$V_{\ell_j^i}^D(M) = \sum_{Q \subseteq M} R_x(Q) = \begin{cases} 1 & \text{if } \ell_j^i = x \text{ and } q_x \notin M \text{ or } \ell_j^i = \neg x \text{ and } q_x \in M, \\ 0 & \text{otherwise,} \end{cases}$$

and, thus, using the interpretation that x is true iff $t_x \in D$, we obtain the expected reward (expectation of the random variable $V_{\ell_j^i}^D$ for the constant policy D)

$$\mathbb{V}_{\ell_j^i}^D = \begin{cases} 1 & \text{if } \ell_j^i \text{ is true,} \\ 0 & \text{if } \ell_j^i \text{ is false.} \end{cases}$$

In order to extend this construction to clauses $c^i = \ell_1^i \vee \ell_2^i \vee \ell_3^i$, we define a disjunction operator as follows:

$$(R_1 \vee R_2)(Q) := R_1(Q) + R_2(Q) - \sum_{Q_1 \cup Q_2 = Q} R_1(Q_1) \cdot R_2(Q_2).$$

This gives us for the corresponding value function

$$\begin{aligned}
(V_1 \vee V_2)(M) &= \sum_{Q \subseteq M} (R_1 \vee R_2)(Q) \\
&= \sum_{Q \subseteq M} (R_1(Q) + R_2(Q) - \sum_{Q_1 \cup Q_2 = Q} R_1(Q_1) \cdot R_2(Q_2)) \\
&= \sum_{Q \subseteq M} R_1(Q) + \sum_{Q \subseteq M} R_2(Q) - \sum_{Q \subseteq M} \sum_{Q_1 \cup Q_2 = Q} R_1(Q_1) \cdot R_2(Q_2) \\
&= V_1(M) + V_2(M) - \left(\sum_{Q \subseteq M} R_1(Q) \right) \left(\sum_{Q \subseteq M} R_2(Q) \right) \\
&= V_1(M) + V_2(M) - V_1(M) \cdot V_2(M)
\end{aligned}$$

which for binary rewards (i.e., rewards whose corresponding value function has a value space of $\{0, 1\}$) can be written as the maximum of $V_1(M)$ and $V_2(M)$, yielding

$$\mathbb{V}_{c^i}^D := \mathbb{V}_{\ell_1^i}^D \vee \mathbb{V}_{\ell_2^i}^D \vee \mathbb{V}_{\ell_3^i}^D = \max\{\mathbb{V}_{\ell_1^i}^D, \mathbb{V}_{\ell_2^i}^D, \mathbb{V}_{\ell_3^i}^D\} = \begin{cases} 1 & \text{if } c^i \text{ is true,} \\ 0 & \text{if } c^i \text{ is false.} \end{cases}$$

To prove that the disjunction $R_1 \vee R_2$ can be computed in polynomial time, we emphasize that, if the supports of R_1 and R_2 are polynomial in size (which they clearly are), the sum $\sum_{Q_1 \cup Q_2 = Q} R_1(Q_1) \cdot R_2(Q_2)$ only adds a polynomial number of non-zero elements. In fact, viewing R_1 and R_2 as dictionaries or partial functions taking on only their non-zero values, we can construct $R_1 \vee R_2$ by simply iterating over the supports of R_1 and R_2 , adding entries in $R_1 \vee R_2$ if necessary.

Finally, with a construction of a reward function for clauses in mind, we define the reward function of the Petri net as

$$R(Q) := \sum_{i \in I} R_{c^i}(Q),$$

where R_{c^i} is the reward function constructed for clause c^i , whence

$$\mathbb{V}^D = \sum_{i \in I} \mathbb{V}_{c^i}^D.$$

This construction gives us a bijection $\Phi : (\mathcal{X} \rightarrow \{0, 1\}) \rightarrow \mathcal{P}(C)$, mapping assignments $\mathcal{A} : \mathcal{X} \rightarrow \{0, 1\}$ to sets $D_{\mathcal{A}} = \Phi(\mathcal{A}) := \{t_x \in T \mid \mathcal{A}(x) = 1\}$ of deactivated transitions, satisfying

$$\mathcal{A} \text{ is a model for } \psi = \bigwedge_{i \in I} c^i \iff \mathbb{V}^{D_{\mathcal{A}}} \geq |I| \iff \mathbb{V}^{D_{\mathcal{A}}} > |I| - 1.$$

This shows that the propositional formula $\bigwedge_{i \in I} c^i$ is satisfiable if and only if there exists a policy $D \subseteq C$ such that $\mathbb{V}^{D_{\mathcal{A}}} > |I| - 1$, proving the reduction 3-SAT \leq_p FCON-POL and, thus, the NP-hardness of FCON-POL.

The result that FCON-POL lies in NP has been shown in Proposition 5.7. \square

C Proofs and Additional Material for §6 (An algorithm for SAFC decision nets)

Lemma 6.4. *Using the setting of Definition 6.3, whenever $[R]$ is consistent with the reward function R and $[R](\tau) = 0$ for all $\tau \notin \mathcal{C}(N)$, the expected value for the net N under the constant policy D is:*

$$\mathbb{V}^D = \sum_{\tau \subseteq T} \mathbb{P}^D(tr \supseteq \tau) \cdot [R](\tau).$$

Proof.

$$\begin{aligned} \mathbb{V}^D &= \sum_{\mu \in \mathcal{FS}(N_D)} \mathbb{P}^D(\mu) \sum_{Q \subseteq pl(\mu)} R(Q) \\ &= \sum_{\mu \in \mathcal{FS}(N_D)} \mathbb{P}^D(\mu) \sum_{\tau' \in \text{pre}^D(tr(\mu))} [R](\tau') \\ &= \sum_{\tau \in \mathcal{C}^\omega(N_D)} \mathbb{P}^D(tr = \tau) \sum_{\tau' \in \text{pre}^D(\tau)} [R](\tau') \\ &= \sum_{\tau \in \mathcal{C}^\omega(N_D)} \mathbb{P}^D(tr = \tau) \sum_{\tau' \in \text{ext}^D(\tau')} [R](\tau') \\ &= \sum_{\tau \in \mathcal{C}^\omega(N_D)} \sum_{\tau' \in \text{ext}^D(\tau')} \mathbb{P}^D(tr = \tau) \cdot [R](\tau') \\ &= \sum_{\tau' \in \mathcal{C}(N_D)} \sum_{\tau \in \text{ext}^D(\tau')} \mathbb{P}^D(tr = \tau) \cdot [R](\tau') \\ &= \sum_{\tau' \in \mathcal{C}(N_D)} \mathbb{P}^D(tr \supseteq \tau') \cdot [R](\tau'), \\ &= \sum_{\tau' \in \mathcal{P}(T)} \mathbb{P}^D(tr \supseteq \tau') \cdot [R](\tau'), \end{aligned}$$

where we use that $\tau \in \text{pre}^D(\tau')$ if and only if $\tau' \in \text{ext}^D(\tau)$ for (maximal) configurations $\tau' \in \mathcal{C}^\omega(N_D)$ and $\tau \in \mathcal{C}(N_D)$. Furthermore, we rely on the fact that $\mathbb{P}^D(tr \supseteq \tau') = \sum_{\tau \in \text{ext}^D(\tau')} \mathbb{P}^D(tr = \tau)$ for $\tau' \in \mathcal{C}(N_D)$ and $\mathbb{P}^D(tr \supseteq \tau') = 0$ for $\tau' \in \mathcal{C}(N) \setminus \mathcal{C}(N_D)$. \square

Proposition 6.5. *The auxiliary reward functions satisfy*

$$\sum_{V \subseteq tr_{>k}(\mu)} \sum_{U \subseteq pl_{\leq k}(\mu)} R[k](U, V) = \sum_{V \subseteq tr_{>k+1}(\mu)} \sum_{U \subseteq pl_{\leq k+1}(\mu)} R[k+1](U, V),$$

for $k \in \{0, \dots, |BC(N)| - 1\}$.

Hence, for every $\mu \in \mathcal{FS}(N)$

$$V(pl(\mu)) = \sum_{U \subseteq pl(\mu)} R[|BC(N)|](U, \emptyset) = \sum_{V \subseteq tr_{>k}(\mu)} \sum_{U \subseteq pl_{\leq k}(\mu)} R[k](U, V),$$

which means that we obtain a reward function on transitions consistent with R by defining $[R] : \mathcal{P}(T) \rightarrow \mathbb{R}$ as

$$[R](V) := \sum_{U \subseteq m_0} R[0](U, V).$$

Proof. Note that, due to safety of the net, we have

$$pl_{\leq k+1}(\mu) = \begin{cases} pl_{\leq k}(\mu) \dot{\cup} t^\bullet & \text{if } t \in tr(\mu) \cap \mathbb{C}_{k+1} \neq \emptyset, \\ pl_{\leq k}(\mu) & \text{if } tr(\mu) \cap \mathbb{C}_{k+1} = \emptyset. \end{cases}$$

As such, if $tr(\mu) \cap \mathbb{C}_{k+1} = \emptyset$, i.e., no transition from the $(k+1)$ -th cell fired in the sequence μ , we have

$$\sum_{V \subseteq tr_{>k}(\mu)} \sum_{U \subseteq pl_{\leq k}(\mu)} R[k](U, V) = \sum_{V \subseteq tr_{>k+1}(\mu)} \sum_{U \subseteq pl_{\leq k+1}(\mu)} R[k+1](U, V)$$

If, on the other hand, $t \in tr(\mu) \cap \mathbb{C}_{k+1}$ is the unique transition from \mathbb{C}_{k+1} that fired in μ , we have

$$\begin{aligned} & \sum_{V \subseteq tr_{>k}(\mu)} \sum_{U \subseteq pl_{\leq k}(\mu)} R[k](U, V) \\ &= \sum_{V \subseteq tr_{>k}(\mu) \setminus \{t\}} \sum_{U \subseteq pl_{\leq k}(\mu)} (R[k](U, V) + R[k](U, V \cup \{t\})) \\ &= \sum_{V \subseteq tr_{>k+1}(\mu)} \sum_{U \subseteq pl_{\leq k}(\mu)} \left(R[k+1](U, V) + \sum_{\substack{U' \cap t^\bullet \neq \emptyset \\ U=U' \setminus t^\bullet \cup t^\bullet}} R[k+1](U', V) \right) \\ &= \sum_{V \subseteq tr_{>k+1}(\mu)} \left(\sum_{U \subseteq pl_{\leq k}(\mu)} R[k+1](U, V) + \sum_{\substack{U \cap t^\bullet \neq \emptyset \\ U \setminus t^\bullet \cup t^\bullet \subseteq pl_{\leq k}(\mu)}} R[k+1](U, V) \right) \\ &= \sum_{V \subseteq tr_{>k+1}(\mu)} \left(\sum_{U \subseteq pl_{\leq k}(\mu)} R[k+1](U, V) + \sum_{\substack{U \subseteq pl_{\leq k+1}(\mu) \\ U \cap t^\bullet \neq \emptyset}} R[k+1](U, V) \right) \\ &= \sum_{V \subseteq tr_{>k+1}(\mu)} \sum_{U \subseteq pl_{\leq k}(\mu)} \left(R[k+1](U, V) + \sum_{\emptyset \neq O \subseteq t^\bullet} R[k+1](U \cup O, V) \right) \\ &= \sum_{V \subseteq tr_{>k+1}(\mu)} \sum_{U \subseteq pl_{\leq k}(\mu) \dot{\cup} t^\bullet} R[k+1](U, V) \\ &= \sum_{V \subseteq tr_{>k+1}(\mu)} \sum_{U \subseteq pl_{\leq k+1}(\mu)} R[k+1](U, V). \end{aligned}$$

□

Corollary 6.6. *Given a net N and a deactivation pattern D , we can calculate the expected value*

$$\mathbb{V}^D = \mathbb{E}[V \circ pl] = \sum_{\tau \subseteq T} \prod_{t \in \tau} \frac{\chi_{T \setminus D}(t) \cdot \Lambda(t)}{\sum_{t' \in \mathcal{C}_t \setminus D} \Lambda(t')} [R](\tau).$$

Proof. Lemma 6.4 gives us

$$\mathbb{V}^D = \sum_{\tau \subseteq T} \mathbb{P}^D(tr \supseteq \tau) \cdot [R](\tau)$$

as $[R]$ is consistent with the reward function R .

We also observe that

$$\mathbb{P}^D(tr \supseteq \tau) = \prod_{t \in \tau} \frac{\Lambda(t)}{\sum_{t' \in \mathcal{C}_t \setminus D} \Lambda(t')}$$

for $\tau \in \mathcal{C}(N_D)$ since the probability of a configuration can be determined by multiplying the probabilities of all its transitions, where the probability of a transition is its normalized rate, where the normalization is performed wrt. to all other deactivated transitions in the cell \mathcal{C}_t of t .

Hence, the equality above can be extended to:

$$\begin{aligned} \mathbb{V}^D &= \sum_{\tau \in \mathcal{C}(N_D)} \prod_{t \in \tau} \frac{\Lambda(t)}{\sum_{t' \in \mathcal{C}_t \setminus D} \Lambda(t')} \cdot [R](\tau) \\ &= \sum_{\tau \in \mathcal{C}(N)} \prod_{t \in \tau} \frac{\chi_{T \setminus D}(t) \Lambda(t)}{\sum_{t' \in \mathcal{C}_t \setminus D} \Lambda(t')} [R](\tau) \\ &= \sum_{\tau \subseteq T} \prod_{t \in \tau} \frac{\chi_{T \setminus D}(t) \Lambda(t)}{\sum_{t' \in \mathcal{C}_t \setminus D} \Lambda(t')} [R](\tau) \end{aligned}$$

where we use that $[R](\tau) = 0$ for all $\tau \in \mathcal{P}(T) \setminus \mathcal{C}(N)$. □

D Runtime results

We performed runtime tests on three families of SAFC-SDPNs, each with a simple generation procedure with randomly chosen rewards and with a clear focus on either concurrency, high degree of self- and backward-conflicts, and absence of both, respectively.

The first family \mathcal{N}_1 consists of Petri nets with n concurrent simple branching cells, each with one initially marked place on which two transitions depend. One of these transitions is not controllable and leads to a place with a random reward sampled according to the standard normal distribution. The other transition is controllable but marks no place. Formally, a net of this family is thus given by $P = \{p_1, \dots, p_{2n}\}, T = (t_1, \dots, t_{2n})$ with $\bullet t_{2k-1} = \bullet t_{2k} = \{p_{2k-1}\}$ and

$t_{2k-1}^\bullet = \{p_{2k}\}, t_{2k}^\bullet = \emptyset$ for $k = 1, \dots, n$, $m_0 = \{p_{2k-1} \mid k = 1, \dots, n\}$, $\Lambda \equiv 1$, $C = \{t_{2k} \mid k = 1, \dots, n\}$, and R only non-zero for $\{p_{2k}\}$ (randomly generated according to standard normal distribution) for $k = 1, \dots, n$ (see also Figure 9). Generating these nets with random rewards for each (post-)place as well as a random bound p for the policy problem (also sampled according to the standard normal distribution) allows for a variety of nets and problems (some of which might not be solvable) to test our algorithms with a focus on its performance on highly concurrent nets. While the optimal strategy for each of these nets is to deactivate any transition that is in a cell with a positively rewarded place and activate all others, the random generation ensures that this optimal strategy results in different optimal sets D of deactivated transitions. Note, however, that the corresponding MDP of these nets will have an exponential size due to the $2^n \cdot n!$ possible firing sequences.

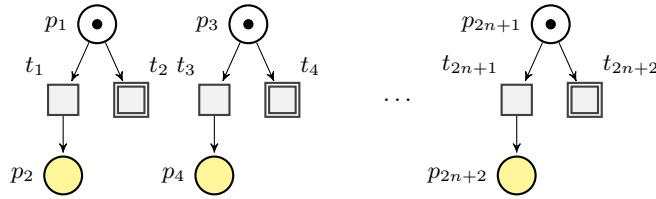

Fig. 9. The family \mathcal{N}_1 of free-choice occurrence SDPNs with a high amount concurrency. Yellow places yellow are being rewarded (or punished).

The second family \mathcal{N}_2 consists, similar to \mathcal{N}_1 , of n branching cells. However, the post-place of one cell is set to be the initial place of the next cell, resulting in a sequential line of branching cells of the same type as above. Formally, a net of this family is thus given by $P = \{p_1, \dots, p_{n+1}\}, T = (t_1, \dots, t_{2n})$ with $^\bullet t_{2k-1} = ^\bullet t_{2k} = \{p_k\}$ and $t_{2k-1}^\bullet = \{p_{k+1}\}, t_{2k}^\bullet = \emptyset$ for $k = 1, \dots, n$, $m_0 = \{p_1\}$, $\Lambda \equiv 1$, $C = \{t_{2k} \mid k = 1, \dots, n\}$, and R only non-zero for $\{p_k\}$ (randomly generated according to standard normal distribution) for $k = 2, \dots, n + 1$ (see also Figure 10). Finding an optimal strategy for these nets is a bit more intricate as in \mathcal{N}_1 since firing the controllable transition in any of these cells results in no reward for all subsequent cells.

The third and final family \mathcal{N}_3 also consists of n branching cells as the ones above. However, both transitions of one cell mark the initial place of the next cell (while, again, only the non-controllable transition marks the rewarded place). This ensures that all cells are fired (as in the concurrent family \mathcal{N}_1) but in sequence and, most importantly, with all but the first initial place having backward-conflicts. Formally, a net of this family is thus given by $P = \{p_1, \dots, p_{2n}\}, T = (t_1, \dots, t_{2n})$ with $^\bullet t_{2k-1} = ^\bullet t_{2k} = \{p_{2k-1}\}$ and $t_{2k-1}^\bullet = \{p_{2k}, p_{2k+1}\}, t_{2k}^\bullet = \{p_{2k+1}\}$ for $k = 1, \dots, n$, $m_0 = \{p_1\}$, $\Lambda \equiv 1$, $C = \{t_{2k} \mid k = 1, \dots, n\}$, and R only non-zero for $\{p_{2k}\}$ (randomly generated according to standard normal distribution) for $k = 1, \dots, n$ (see also Figure 11).

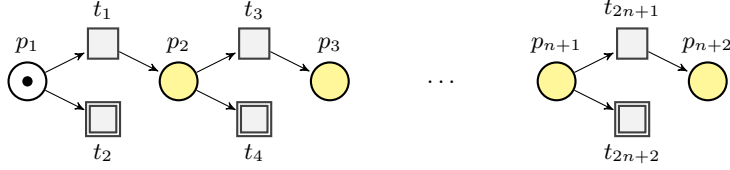

Fig. 10. The family \mathcal{N}_2 family of free-choice occurrence SDPNs. Yellow places are being rewarded (or punished).

While an optimal strategy for this family of nets is the same as for the first one, deactivating exactly all controllable transitions in cells with positively rewarded places, the backward-conflicts result in an exponentially sized rewritten reward function $[R]$ on the transitions with each of the 2^n possible configurations being rewarded.

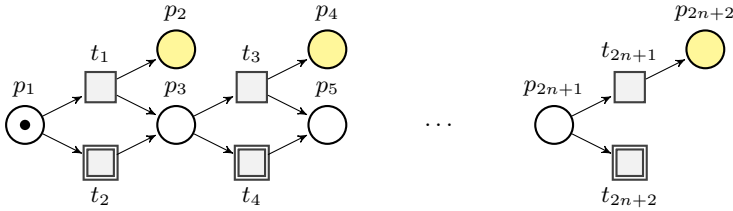

Fig. 11. The family \mathcal{N}_3 of safe and acyclic free-choice SDPNs with backward-/self-conflicts. Yellow places are being rewarded (or punished).

For each of these families, we performed runtime tests on 25 randomly generated nets (i.e., reward values) for each n (as long as it was feasible). The tables and graphs below show the runtimes for the rewriting algorithm (i.e., solving the value problem), and solving the policy problem (again with randomly generated bound according to the standard normal distribution) both by iterating over all possible deactivation sets (brute force) or by using the z3 SMT solver.

The runtimes of solving the value problem or rewriting the reward function using the algorithm as described in Section 6 are as expected (see Figure 12): For the family \mathcal{N}_3 containing many backward-conflicts (in particular, a family of non-occurrence nets), the runtimes rise exponentially with the amount of branching cells (see also Table 3) while the algorithm performs much better on both families of free-choice occurrence nets \mathcal{N}_1 and \mathcal{N}_2 and, in particular, independent of the amount of concurrency present (in contrast to the expected time of solving the value problem using the corresponding MDP which would grow exponentially for family \mathcal{N}_1). Furthermore, it is noteworthy that the performance of the rewriting algorithm mainly depends on the net structure, not on the randomly generated

reward values which is reflected by the relatively small variance (see Tables 1, 2 and 3).

Size	Median	Mean	St.Dev.	90% quantile
1	0	0.40	0.49	1
2	2	2.04	0.20	2
3	6	6.12	0.32	7
4	14	14.28	0.53	15
5	28	28.24	2.10	31
6	49	48.72	1.76	50
7	79	79.16	1.93	80
8	121	121.68	2.28	123
9	179	179.24	2.90	183
10	247	247.28	8.25	257
11	338	339.40	7.98	350
12	464	461.88	9.62	474
13	604	600.76	12.09	614
14	764	761.60	14.35	777
15	971	970.32	7.59	978
16	1196	1190.56	16.57	1208
17	1476	1471.68	21.47	1497
18	1799	1795.56	20.33	1817
19	2136	2145.96	46.15	2213
20	2589	2594.56	38.30	2640
21	3072	3069.04	30.38	3100
22	3632	3621.68	38.97	3665
23	4238	4230.68	30.44	4257
24	4956	4937.44	51.32	4985
25	5703	5698.40	53.57	5738

Table 1. Runtime results of the reward rewriting algorithm for family \mathcal{N}_1 in ms.

Turning our attention to the performance of solving the policy problem based on the rewritten reward function, we notice first and foremost that, in all three families, using an SMT solver produces highly varying runtimes. This can be seen in both the standard deviations as seen in Tables 4, 5, and 6, as well as in the boxplot diagrams in Figures 14, 15, and 16.

Boxplots are often used graphical representation to represent statistical results where, here, the ‘box’ describes the quartiles (i.e., 25%-quantile to 75%-quantile) with the yellow bar signifying the median. The whiskers have a maximal size of 1.5-times the length of the box (being smaller if no other values are present) and outliers (i.e., values outside of the maximal whisker length) are marked as circles.

Taking a look at the results for the highly concurrent family \mathcal{N}_1 , we notice immediately that while using the brute force approach of comparing the values for all deactivation patterns produces exponential runtimes as expected, using

Size	Median	Mean	St.Dev.	90% quantile
1	0	0.36	0.48	1
2	2	2.00	0.00	2
3	6	5.76	0.43	6
4	13	13.00	0.28	13
5	25	25.16	1.62	26
6	42	42.56	1.58	43
7	69	69.20	2.68	71
8	104	103.44	2.77	106
9	149	149.20	4.24	154
10	210	209.48	4.60	216
11	284	283.56	4.05	289
12	378	377.12	6.36	383
13	486	483.96	10.17	494
14	612	610.20	9.62	621
15	757	759.28	23.27	770
16	931	927.96	9.15	938
17	1133	1145.88	57.85	1189
18	1362	1362.92	27.37	1402
19	1632	1621.60	19.12	1639
20	1922	1916.00	18.51	1936
21	2260	2252.72	20.29	2269
22	2625	2618.68	28.96	2651
23	3140	3104.12	359.93	3299
24	3544	3535.00	44.97	3582
25	4061	4065.24	43.59	4118

Table 2. Runtime results of the reward rewriting algorithm for family \mathcal{N}_2 in ms.

Size	Median	Mean	St.Dev.	90% quantile
1	0	0.44	0.50	1
2	2	2.32	0.55	3
3	8	7.92	0.27	8
4	22	22.44	1.42	23
5	52	52.24	1.58	53
6	121	135.32	28.71	190
7	263	262.16	5.41	271
8	583	587.48	20.51	614
9	1281	1283.52	21.44	1314
10	2772	2762.00	29.15	2790
11	6018	6018.56	43.54	6069
12	13193	14144.36	1821.25	17375
13	41182	41155.08	478.37	41672
14	90170	90159.60	795.00	91114

Table 3. Runtime results of the reward rewriting algorithm for family \mathcal{N}_3 in ms.

the SMT solver has a much lower runtime where, despite growing variance, even the worst-case runtime seems to be polynomial apart from rare outliers (which are still much more performant than the brute force approach; see Table 4 and Figure 14). While this example is restricted to the simplest of concurrent SDPNs, this clearly reflects the strength of partial-order techniques to deal with concurrency where solving the corresponding MDP would necessarily produce exponential runtimes.

The results for family \mathcal{N}_2 which lacks all concurrency but is still an occurrence net shows the extremely high variance in the runtime of the SMT solver (see Table 5 or Figure 15). As mentioned in the description of the family \mathcal{N}_2 above, finding an optimal deactivation pattern in this scenario is much more intricate than for the other two families and while, in the best case, the SMT solver is much faster than the brute force approach, most notably the unusually low median for $n = 13$, it can also take a multitude longer in the ‘more difficult’ scenarios.

Finally, while the results for family \mathcal{N}_1 showed the benefits of partial-order techniques, the results for family \mathcal{N}_3 reflect their drawbacks. Note that the rewritten reward function $[R]$ on configurations already has an exponential support (w.r.t. n) which not only leads to a longer computation time of the value, explaining the much higher runtime of the brute force approach. The exponential support also results in a much more complex SMT expression, the effect of which being that the z3 solver can only find answers efficiently for very small n as can be seen in Table 6 and Figure 16.

Size	Brute Force				SMT Solver			
	Median	Mean	St.Dev.	90%	Median	Mean	St. Dev.	90%
1	0	0.00	0.00	0	4	4.20	0.40	5
2	0	0.64	3.14	0	5	4.68	0.73	5
3	0	0.60	2.94	0	5	5.00	0.89	6
4	0	1.52	4.44	4	5	5.92	2.28	8
5	15	8.88	7.73	16	5	6.56	2.35	10
6	15	12.96	5.67	16	6	7.88	2.83	12
7	31	30.28	4.58	33	8	9.60	5.36	15
8	63	65.24	6.03	78	9	12.04	7.66	21
9	149	148.76	8.02	157	8	10.52	5.95	18
10	337	336.96	7.32	344	6	9.28	5.67	20
11	780	774.00	16.96	791	10	16.12	13.01	29
12	1701	1695.00	20.39	1718	9	13.20	10.71	24
13	3759	3748.76	43.43	3796	8	18.36	18.04	49
14	8264	8250.76	79.50	8331	7	14.12	12.10	31
15					10	15.20	15.17	38
16					10	18.84	20.87	45
17					10	21.88	21.46	54
18					15	32.00	33.81	85
19					9	28.24	29.26	82
20					22	39.68	38.46	99
21					10	98.20	283.86	204
22					15	90.64	241.91	157
23					15	24.36	21.66	53
24					21	227.88	602.75	230
25					11	39.08	61.17	99

Table 4. Runtime results of solving the policy problem for family \mathcal{N}_1 based on its rewritten reward function in ms.

Size	Brute Force				SMT Solver			
	Median	Mean	St. Dev.	90%	Median	Mean	St. Dev.	90%
1	0	0.04	0.20	0	3	3.24	0.81	4
2	0	0.24	0.43	1	4	3.88	0.52	4
3	1	0.64	0.48	1	4	4.68	0.93	6
4	2	2.00	0.00	2	6	8.72	5.35	18
5	6	5.60	0.49	6	10	14.92	12.64	33
6	14	14.72	1.22	15	37	52.48	50.65	114
7	35	35.44	1.13	36	68	166.88	187.83	477
8	86	85.92	1.41	87	104	335.16	476.87	1207
9	199	198.88	5.57	206	518	3064.64	4734.68	9352
10	605	602.56	87.71	709	1506	6250.28	7470.27	14787
11	1440	1415.28	101.87	1562	1291	10406.56	13460.78	32612
12	2725	2824.12	248.15	3182	24194	28207.96	34708.02	62627
13	6392	6301.04	360.13	6703	31	27871.40	48568.88	80423
14	14295	14354.60	507.15	14898	23752	80045.08	110595.76	285170
15	32547	32540.48	923.48	33695	94357	242712.04	386185.05	880569

Table 5. Runtime results of solving the policy problem for family \mathcal{N}_2 based on its rewritten reward function in ms.

Size	Brute Force				SMT Solver			
	Median	Mean	St. Dev.	90%	Median	Mean	St. Dev.	90%
1	0	0.64	3.14	0	7	7.15	1.46	8
2	0	1.96	5.19	10	9	9.95	5.13	18
3	15	9.24	7.66	16	33	61.4	61.10	163
4	32	36.40	6.98	48	237	724.25	915.76	1683
5	160	160.64	11.89	175				
6	634	637.80	16.86	653				
7	2675	2677.64	17.46	2702				
8	11441	11453.40	68.32	11543				
9	49029	52364.28	4530.39	59670				

Table 6. Runtime results of solving the policy problem for family \mathcal{N}_3 based on its rewritten reward function in ms.

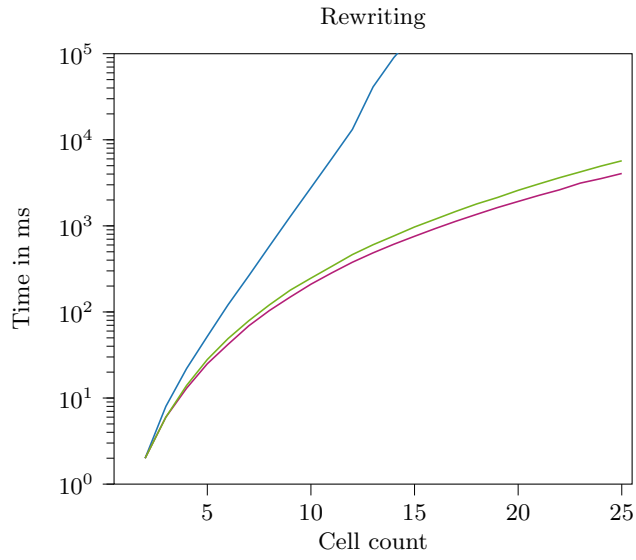

Fig. 12. Runtime of the rewriting of the reward function on \mathcal{N}_1 (green), \mathcal{N}_2 (red), and \mathcal{N}_3 (blue).

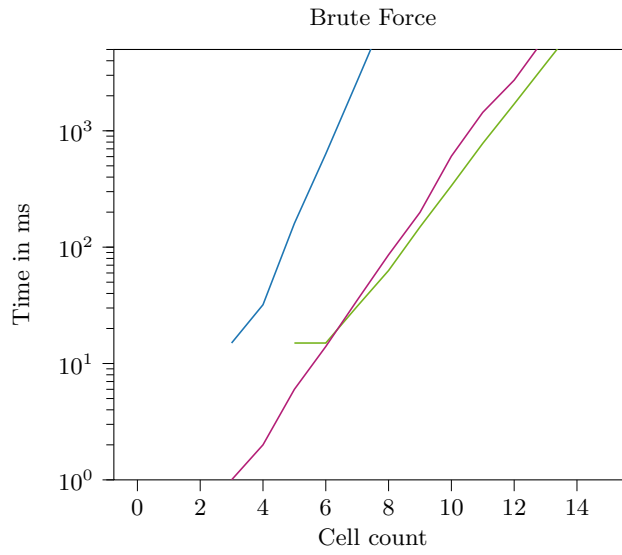

Fig. 13. Runtime of the solving the policy problem by brute force (iterating over all possible deactivation patterns) on \mathcal{N}_1 (green), \mathcal{N}_2 (red), and \mathcal{N}_3 (blue).

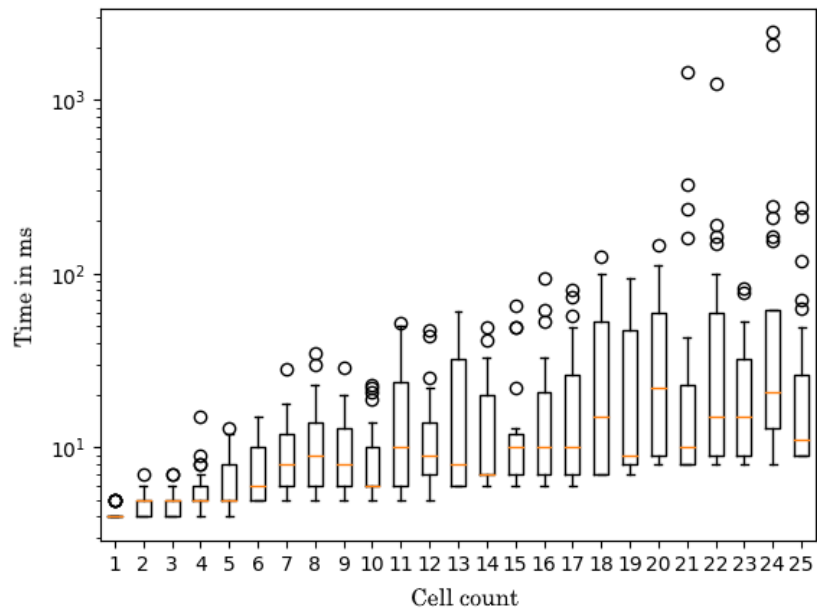

Fig. 14. Runtime of the solving the policy problem using the z3 SMT solver on the rewritten reward function on \mathcal{N}_1 .

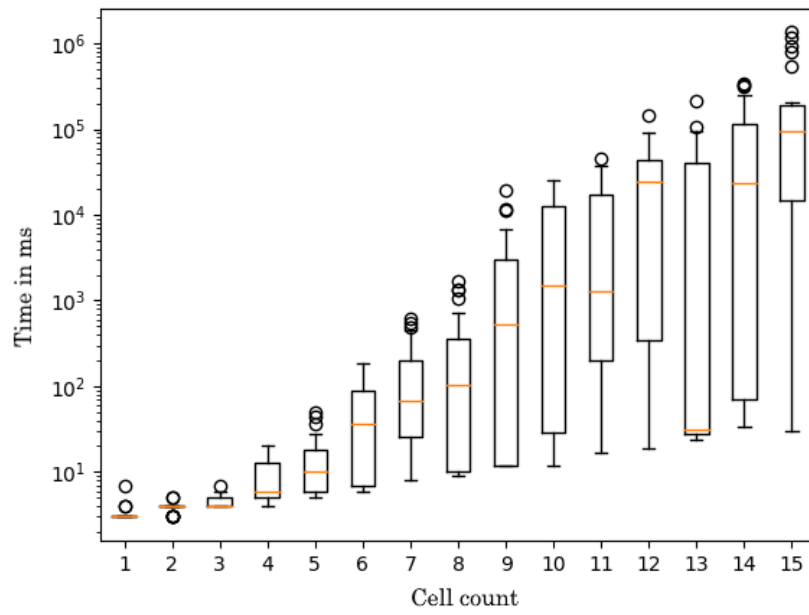

Fig. 15. Runtime of the solving the policy problem using the z3 SMT solver on the rewritten reward function on \mathcal{N}_2 .

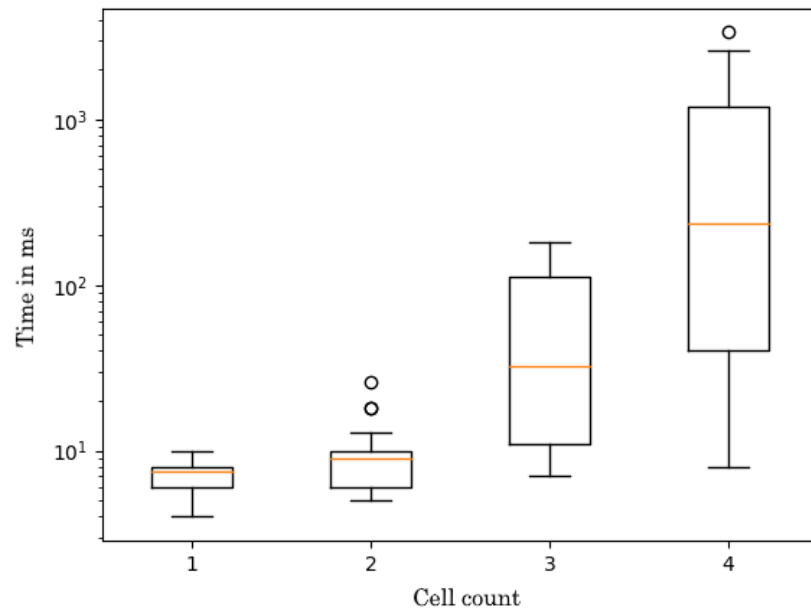

Fig. 16. Runtime of the solving the policy problem using the z3 SMT solver on the rewritten reward function on \mathcal{N}_3 .