

Degree-3 planar graphs as topological minors of wall graphs in polynomial time

Antoine Amarilli   

LTCI, Télécom Paris, Institut Polytechnique de Paris, France

Abstract

In this note, we give a proof of the fact that we can efficiently find degree-3 planar graphs as topological minors of sufficiently large wall graphs. The result is needed as an intermediate step to fix a proof in my PhD thesis [1].

2012 ACM Subject Classification Mathematics of computing → Discrete mathematics

Keywords and phrases Planar graph, topological minor, wall graph

1 Introduction and related work

In this note, we explain how, given a degree-3 planar graph, we can find it as a topological minor of a wall graph, and do so efficiently, i.e., in polynomial time. This result is needed as an intermediate step to fix a proof in my PhD thesis [1]. Here is the formal statement of the result:

► **Theorem 1.1.** *Given as input any degree-3 planar graph G with n vertices, we can compute in time $O(n^{10})$ a wall graph H of size $O(n^4)$ by $O(n^4)$ and an embedding of G as a topological minor of H .*

Note that, in this result, we make no effort to optimize the degree of the polynomial.

The proof presented here uses the well-known fact [6, 3] that planar graphs can be drawn in linear time on a grid with integer coordinates. Specifically, it works by starting from the drawing and adjusting it to obtain the embedding.

Related work. An alternative route to show Theorem 1.1 was pointed out to us in [8] after we posted a first version of this note. Specifically, it is shown in [7] that we can embed an input planar graph of maximal degree 4 into a grid in linear time, and the *grid embedding* computed in [7] is a topological embedding (satisfying additional properties). The embedding can then be converted to a topological embedding into a wall graph, thanks to the fact that the input graph is degree-3. This proof method is different from the one which we present in this note; further, it would achieve a better bound, and is arguably simpler.

Similar results to Theorem 1.1 are already known to embed planar graphs as minors of grid graphs [5, Result 1.5], but we are not aware of a discussion of the complexity of this process. In particular, the proof in [5] does not seem easy to adapt to a polynomial-time process, as it involves, e.g., the computation of Hamiltonian circuits.

Theorem 1.1 is not related to the celebrated theorem by Chekuri and Chuzhoy [2], which shows that we can embed a grid in any graph with sufficiently large but polynomial treewidth. In our result, the graph that we embed is an arbitrary planar degree-3 graph, but importantly the target of the embedding is always a wall graph. This is why we are also able to show a deterministic PTIME bound, whereas the algorithm of [2] runs in randomized PTIME.

Acknowledgements. I am grateful to Pierre Bourhis, Mikaël Monet, and Pierre Senellart for discussions about the problem, in particular I warmly thank Mikaël Monet for proofreading the note in detail, identifying some problems, and discussing possible solutions.

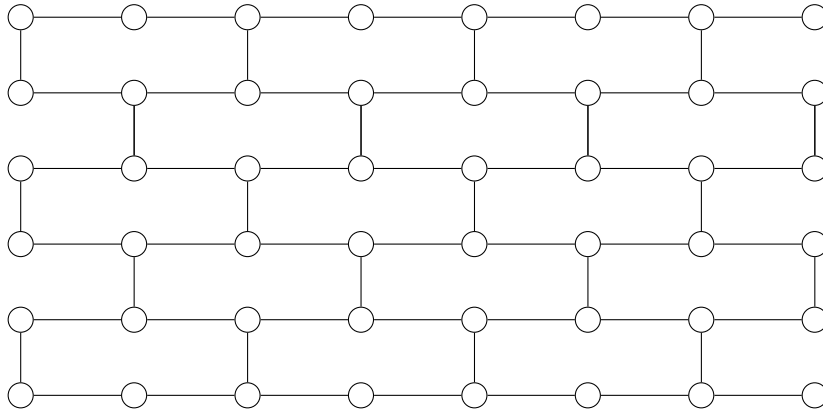

■ **Figure 1** The (6, 8)-wall

2 Preliminaries and result statement

An (undirected) *graph* $G = (V, E)$ consists of a set of *vertices* V and a set of *edges* E which are pairs of distinct vertices that are said to be *adjacent*. The graph is *degree-3* if the *degree* of each vertex, i.e., the number of edges in which it appears, is at most 3. The graph is *planar* if it can be drawn on the plane without edge crossings. A *path* connecting $u \in V$ and $v \in V$ in G is a sequence of vertices $u = w_1, \dots, w_n = v$ such that w_i and w_{i+1} are adjacent for all $1 \leq i \leq n$. The *inner vertices* of the path are w_2, \dots, w_{n-1} : there may be none if the *length* n of the path is 0 (i.e., $u = v$) or 1 (i.e., u and v are adjacent and the path directly takes that edge).

We define *wall graphs* following [4]. For integers r and s , the (r, s) -*wall* is the graph $W_{r,s}$ with vertices $\{(i, j) \mid 1 \leq i \leq r, 1 \leq j \leq s\}$ and edges $\{(i, j), (i, j+1)\} \mid 1 \leq i \leq r, 1 \leq j < s\}$ and $\{(i, j), (i + (-1)^{i+j}, j)\} \mid 1 \leq i < r, 1 \leq j \leq s\}$. An example wall graph is given on Figure 1. Note that wall graphs are always degree-3 and planar.

A (*topological*) *embedding* of a graph $G = (V, E)$ into a graph $H = (V', E')$ consists of an injective function $f: V \rightarrow V'$ and a function g mapping each edge $\{u, v\}$ of E to a path $g(\{u, v\})$ in H connecting $f(u)$ and $f(v)$ such that all these paths are vertex-disjoint, i.e., for any two edges $\{u, v\}$ and $\{u', v'\}$ of E , the set of inner vertices of the paths $g(\{u, v\})$ and $g(\{u', v'\})$ are disjoint.

Our goal is to show Theorem 1.1. The proof proceeds in three steps. Some of the details are a bit tedious, and the goal of this note is to make them precise, but the overall strategy is rather simple.

First, we use the result of [6] to obtain in linear time a drawing of the input graph with integer coordinates. The idea will be to convert this to an embedding in a sufficiently large wall graph, by scaling up the drawing. We also show some geometric lemmas on the drawing to bound how close the elements of the drawing can be: how close can a vertex be to a segment to which it does not belong, and how close two segments sharing a common endpoint can be when they are sufficiently far away from the common endpoint.

Second, we explain how edges can be translated to paths in the wall graph, by showing that any straight line between points with integer coordinates can be “approximated” by a path in a wall graph which “stays close” to the line.

Third, we use the approximate paths to transform the drawing of the graph into something that resembles a topological embedding except that the paths may overlap close to their endpoints.

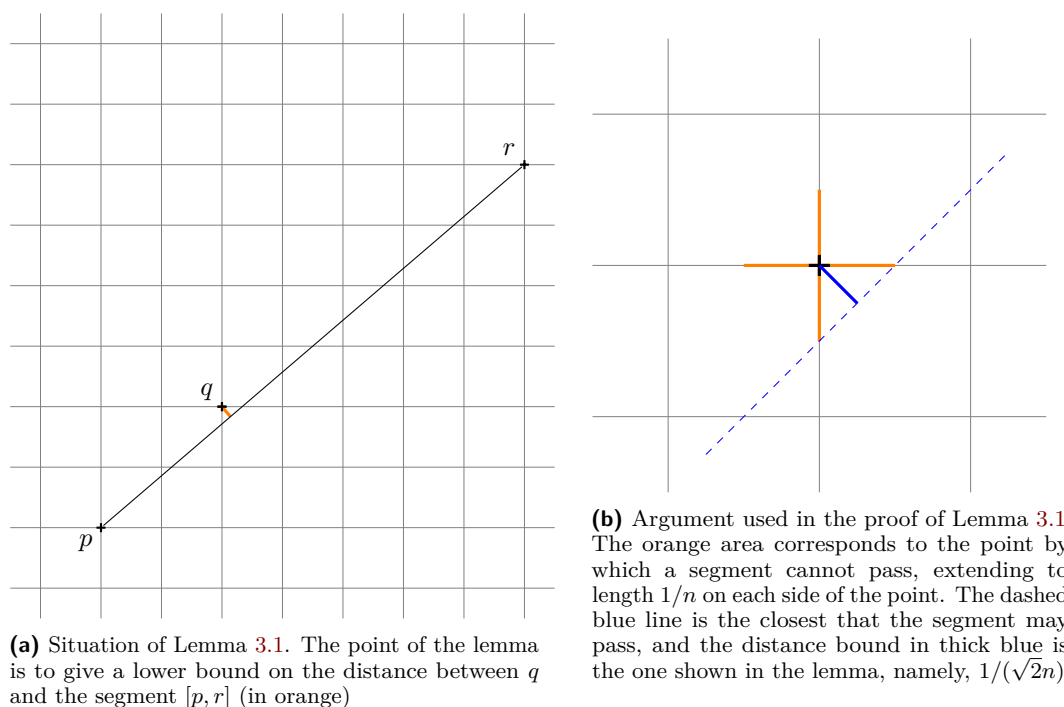

■ **Figure 2** Illustrations for Lemma 3.1

Fourth, we explain how to modify the embedding close to the vertices to fix this problem.

3 Drawing the input graph G and showing lemmas about the drawing

Given the input graph $G = (V, E)$, let n be its number of vertices. The problem is trivial if $n \leq 2$, so we assume $n \geq 3$. We know by the work of Schnyder [6] that we can compute in linear time a *straight line embedding* of G in the $n - 2$ by $n - 2$ grid. This implies that we have an injective *drawing function* $\delta: V \rightarrow \{0, \dots, n - 1\}^2$ mapping each vertex $u \in V$ to a point with integer coordinates in this range, so that the edges do not cross, i.e., for any two edges $e = \{u, v\}$ and $e' = \{u', v'\} \in E$ with $e \neq e'$, the segments $[\delta(u), \delta(v)]$ and $[\delta(u'), \delta(v')]$ do not cross (except that they may share the same endpoints if some vertices among u, v, u' , and v' are equal).

We will want to replace the segments of the drawing by paths in a suitable wall graph. To do this and ensure that the paths do not intersect, it will be important to understand some properties of the drawing. First, we must understand how close a segment between points with integer coordinates can pass by another point with integer coordinates which is not on the segment. For this, we show a lemma:

► **Lemma 3.1.** *Let p, q, r be pairwise distinct points with integer coordinates between 0 and $n - 1$. Assume that the point q is not on the segment $[p, r]$. Then the distance between q and the segment $[p, r]$ is at least $\frac{1}{\sqrt{2}n}$.*

The lemma is illustrated as Figure 2a.

Proof. If the segment is parallel to one of the axes, then the result is trivial because its distance to points with integer coordinates not in the segment is clearly at least 1, hence at

least $\frac{1}{\sqrt{2n}}$. Hence, we assume that the segment is not parallel to any axis, hence the first coordinates of p and r are different, and the second coordinates of p and r are also different.

We first show the following claim (*): for all points of the segment $[p, r]$ having exactly one integer coordinate in the range $\{0, \dots, n\}$, the difference between the other coordinate and the nearest integer is at least $1/n$.

Indeed, let (a, b) and (c, d) be the respective coordinates of p and r . The points in the segment are those with coordinates $(a + x(c - a), b + x(d - b))$ for $0 \leq x \leq 1$. Assume that some coordinate is integer, say the first, then $a + x(c - a)$ is an integer, say e . Hence, $x = \frac{e-a}{c-a}$, recalling that $c \neq a$, where a and e and c are integers in $\{0, \dots, n-1\}$. Then the second coordinate is $b + x(d - b)$. This can be expressed as a fraction with integer numerator and with denominator $c - a$, which is an integer of absolute value at most n . Hence, if the value of the second coordinate is not an integer, its distance to the nearest integer is at least $1/n$. The same argument applies if we exchange the role of the first and second coordinates. This establishes claim (*) above.

Now, we use convexity. Considering the point q , the segment does not go via that point, so considering all points with one integer coordinate matching that of q and the other integer coordinate differing from the coordinate of q by strictly less than $1/n$, we know that the segment cannot go via these points. So the closest the segment can go is $\frac{1}{\sqrt{2}} \times \frac{1}{n}$ (see Figure 2b for an illustration), concluding the proof. \blacktriangleleft

Second, we need to understand how close two segments with integer coordinates that share a common endpoint can be from one another. Of course, close to the endpoint, they can be arbitrarily close; but we need to show that they are sufficiently far away once we are sufficiently far from the common endpoint. For this, let us define the notion of *box*:

► **Definition 3.2.** *Given a point p and length $\epsilon > 0$, the box of radius ϵ centered on p is the square region with center p and sides 2ϵ .*

We can then claim:

► **Lemma 3.3.** *Let p, q, r be pairwise distinct points with integer coordinates, and consider the segments $[p, q]$ and $[p, r]$. We assume that $[p, q]$ and $[p, r]$ are not collinear, so p is their only intersection.*

Let $\epsilon > 0$, and consider the box of radius ϵ centered on p . Let q' and r' be arbitrary points of $[p, q]$ and $[p, r]$ respectively such that both are outside the box. Then the distance between q' and r' is at least $\frac{\epsilon}{2n^2}$.

We illustrate the lemma in Figure 3. We need a simple auxiliary claim to show the result.

▷ **Claim 3.4.** Consider a triangle p, q'', r'' , where the angles on q'' and on r'' are acute. Let q be a point of the ray with direction (p, q'') starting at q'' and let r be a point on the ray with direction (p, r'') starting at r'' . Then the distance between q and r is greater than or equal to the distance between q'' and r'' .

The claim is illustrated on Figure 4. Let us prove it:

Proof. We first reduce to the case where $q = q''$. This step is illustrated on Figure 4. Consider the line (q'', r'') . Up to swapping the points q and q'' with r and r'' , without loss of generality we can assume that the distance of point q to that line is no greater than the distance of point r to that line.

Let r' the intersection with (p, r) of the parallel line to (q'', r'') . It is immediate (e.g., by Thales's theorem) that the distance between q and r' is no smaller than the distance between

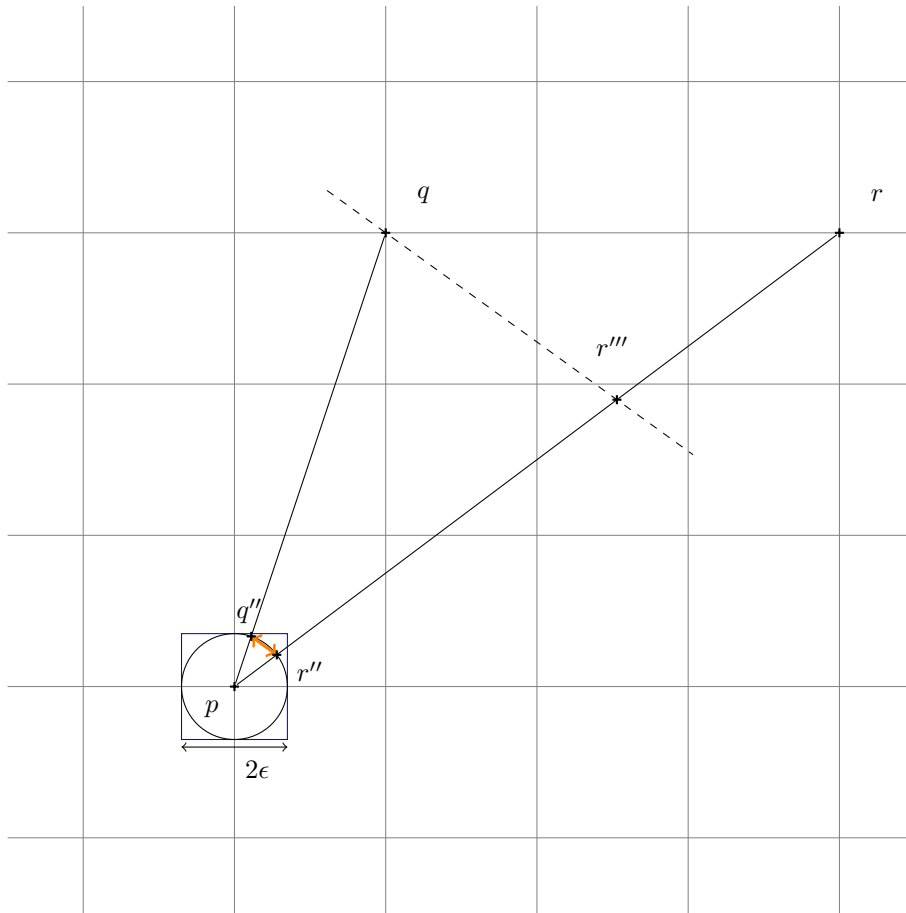

■ **Figure 3** Illustration of Lemma 3.3. The lemma is shown by establishing a lower bound on the orange distance, depending on the size of the box (in blue).

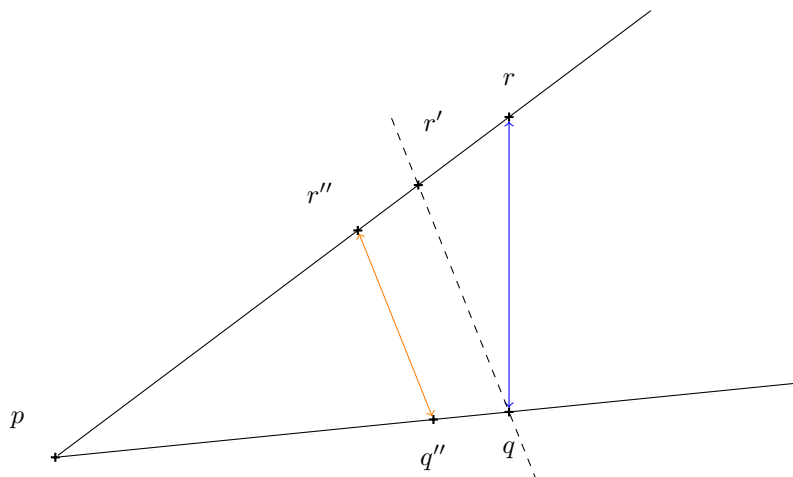

■ **Figure 4** Illustration of Claim 3.4: the distance in blue is greater than or equal to the distance in orange, provided the angles on r'' and q'' are acute. We also illustrate the first step of the proof.



q'' and r'' . Further, considering the triangle p, q, r' , the angles on q and r' in that triangle are respectively equal to the angles on q'' and r'' on the original triangle, so they are also acute; further the point r is still on the ray starting at r' with direction (p, r') . Hence, it suffices to study the case where $q = q''$. (This case is not illustrated.)

Now, in this case, since the angle on r'' is acute, we know that the projection of q'' on (p, r'') is in the segment $[p, r'']$. This means that, letting r' be this projection, and moving along the ray starting at r' with direction (p, r') , the distance to q'' is not decreasing. Doing so, we first encounter r'' and then r , so we conclude that indeed the distance between q'' and r'' is no greater than the distance between $q = q''$ and r . ◀

We now prove Lemma 3.3:

Proof of Lemma 3.3. Let q'' and r'' be the points on $[p, q]$ and $[p, r]$ respectively at distance ϵ from p . These two points are inside the box. As the triangle p, q'', r'' is isosceles, the angles on q'' and r'' must be acute. Thus, to show the bounds on points p' and q' as in the lemma statement, by Claim 3.4 it suffices to show the claim on the distance between q'' and r'' .

First, up to exchanging q and r if necessary, we assume that the line parallel to (q'', r'') going through q intersects the line (p, r) within the segment $[p, r]$. Let r''' be the intersection point. Considering the point q and the segment $[p, r]$, we have by Lemma 3.1 a lower bound of $\frac{1}{\sqrt{2n}}$ on the distance between q and $[p, r]$, translating to the same lower bound on the distance between q and the point r''' which belongs to $[p, r]$.

We now use Thales's theorem to show that the ratio between the lengths of $[p, q'']$ and $[p, q]$ is the same as the ratio between the lengths of $[q'', r'']$ and $[q, r''']$. From the lower bound of Lemma 3.1, letting x be the distance between p and q , we have:

$$\frac{\epsilon}{x} \leq d\sqrt{2n}$$

We deduce:

$$d \geq \frac{\epsilon}{x\sqrt{2n}}$$

Now, $x \leq \sqrt{2n}$ given the range of coordinates, so we deduce:

$$d \geq \frac{\epsilon}{2n^2}$$

Thus, we have shown our lower bound on the distance between q'' and r'' , which as we had argued implies a lower bound on point q' and r' as in the lemma statement. ◀

4 Approximating lines with paths

Our idea is to start from the drawing function defined in the previous section and transform it to a topological embedding into a sufficiently large wall graph. To do this, we will first argue how each straight line segment in the drawing can be transformed to a path in a wall graph which stays sufficiently close to the line. Formally, we show:

► **Lemma 4.1.** *Let r, s be two integers, and consider two distinct integer points (i, j) and (i', j') that are vertices of the (r, s) -wall $W_{r,s}$, with $1 \leq i, i' \leq r$ and $1 \leq j, j' \leq s$. Consider the segment $[(i, j), (i', j')]$. Then we can construct in $O(r \times s)$ a simple path from (i, j) to (i', j') in $W_{r,s}$ such that, for each traversed vertex, its distance to the segment is at most 2.*

The lemma is illustrated on Figure 5.

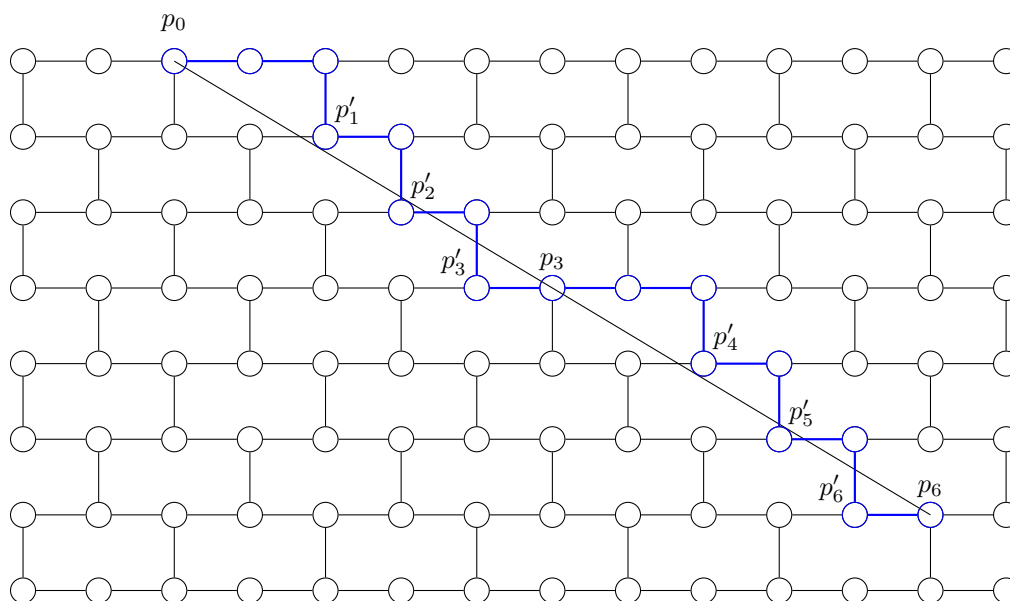

■ **Figure 5** Approximating a segment by a path in a wall graph. The points p_i are equal to p'_i unless otherwise written.

Proof. The claim is immediate if the segment is horizontal, i.e., $i = i'$, so we focus on the case of a non-horizontal segment. Up to swapping both points, we assume that $i' > i$. We consider points p_0, \dots, p_n with $n = i' - i$, i.e., $n > 0$, defined in the following way: p_0 is (i, j) , and for $k > 0$ the point p_k is some point of the wall graph with first coordinate $i + k$ which is at minimal distance of the point π_k of the segment having this first coordinate, i.e., having ordinate value $i + k$ (pay attention to the fact that the point (x, y) is at row x , i.e., ordinate value x , and column y , i.e., abscissa y). In particular, we must have $p_n = (i', j')$, and the distance of each p_k to π_k is only due to the second coordinate, and it is at most $1/2$.

We now modify slightly our choice of the points p_1, \dots, p_n to obtain points p'_1, \dots, p'_n and ensure that the latter points have an incident vertical edge pointing up, i.e., if $p_k = (i'', j'')$, we want to make sure that the vertex is adjacent to $(i'' - 1, j'')$. This is the case of every other vertex on each row, so it can be enforced by replacing each point p_i not satisfying the condition by a left or right neighbor p'_i which does, i.e., incrementing or decrementing the first component. (It may be the case that only one of these two options is possible if we are close to the borders of the wall.) Specifically, we choose the neighbor which is closest to the segment. In so doing, the distance of the intermediate points to the segment becomes at most 1, achieved in the case where $\pi_k = p_k$ and p_k is not suitable (see the case of p_3 on Figure 5).

It suffices now to design a path in the wall graph that successively visits the points $p_0 = p'_0, \dots, p'_n, p_n$ (the last step being one single edge, or no edge if $p_n = p'_n$). We do so inductively: from a vertex p'_k , we first change the second component to be that of p'_{k+1} while keeping the first component unchanged, then we increase the second component (traversing the edge whose existence is guaranteed by the choice of p'_{k+1} relative to p_{k+1}). The only exceptional case is the last: if the node p_n reached is not a segment endpoint but a left or right neighbor, we finish by traversing the requisite edge. It is clear that this definition ensures that the path is simple. The path is illustrated again in Figure 5.

What is more, the distance of this path to the segment is at most 2. Indeed, consider

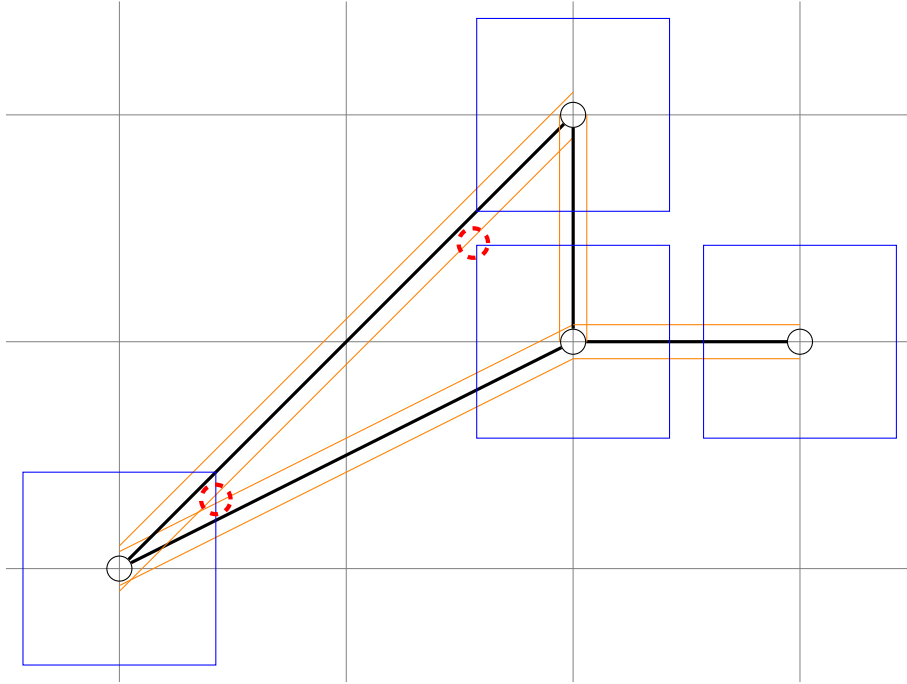

■ **Figure 6** Illustration of the global construction. We consider a box B_v'' centered on every vertex v (in blue), and a distance margin $M_{u,v}$ around every segment $[u, v]$ corresponding to an edge $\{u, v\}$ (in orange). We choose the box sizes to guarantee several things: (i) the boxes do not overlap; (ii) the margins around two different segments with the same endpoint do not intersect outside of the box of this endpoint (using Lemma 3.3, see dashed red circle near the bottom left of figure); (iii) a box cannot intersect with the distance margin around a segment unless its vertex is an endpoint of that segment (using Lemma 3.1, see dashed red circle in the middle of figure). This guarantees that the path approximations that stay close to each edge (Lemma 4.1) cannot intersect except within each of the boxes.

any choice of $k > 0$, and let us study how far away the path from p'_{k-1} to p'_k strays from the segment. The segment connects π_{k-1} to π_k , and we know that the first coordinate of p'_{k-1} and π'_{k-1} is $i + k - 1$ and the first coordinate of p'_k and π'_k is $i + k$. So the segment is at distance at most 1 to any point in the wall graph whose first coordinate is $i + k - 1$ or $i + k$ and whose second coordinate is between that of π_{k-1} and that of π_k . But we know the path from p'_{k-1} to p'_k visits only points satisfying these conditions except that the second coordinate of p'_{k-1} and of p'_k may each differ by at most 1 for that of π_{k-1} and of π_k . So in total the distance of the visited vertices to the segment is at most $1 + 1 = 2$. This bound of 2 holds for the path from p_0 to p'_n , and the last edge added in case $p'_n \neq p_n$ is not a problem because then we are clearly at distance ≤ 1 from the segment. This concludes the proof. ◀

5 Scaling up the drawing

Let us recall what we showed in Section 3. Let us fix a box size $\epsilon := \frac{1}{4n}$. We will consider boxes B_v of radius ϵ centered on each vertex (recall Definition 3.2), and then scale up the drawing. For the scale-up, define the scale factor $\sigma := 40n^3$. Take the drawing function δ defined in Section 3, and multiply it by σ . We can now consider the (r, s) -wall graph $W_{r,s}$ with $r = \sigma(n - 2)$ and $s = \sigma(n - 2)$. The vertices of the drawing correspond to points of the

wall graph that are multiples of σ .

For each vertex v , we will consider the box B'_v centered on v obtained from the box B_v after scaling up, whose radius is $\sigma\epsilon = 10n^2$. We will also consider a larger box B''_v centered on v with radius $\sigma\epsilon + 2$. We will finally consider, for every segment $[u, v]$ corresponding to an edge $\{u, v\}$, the *margin* $M_{u,v}$ at distance 2 around $[u, v]$, consisting of all points at Euclidean distance ≤ 2 from the segment. See Figure 6 for a summary of the situation. We make four claims:

- (i) For any two distinct vertices $u \neq v$, the boxes B''_u and B''_v for u and v do not intersect. This is because $2\sigma\epsilon + 4 < \sigma$.
- (ii) For any two segments $[u, v]$ and $[u, w]$ corresponding to edges $\{u, v\}$ and $\{u, w\}$ sharing one vertex endpoint u , the margins $M_{u,v}$ and $M_{u,w}$ do not intersect except inside the larger box B''_u of u . This is intuitively obtained by scaling up the bound from Lemma 3.3. Specifically, consider any point x in $M_{u,v} \cap M_{u,w}$. By definition, x is at distance ≤ 2 from both $[u, v]$ and $[u, w]$, and the projections v' and w' of x on $[u, v]$ and $[u, w]$ respectively are then at distance ≤ 4 by the triangle inequality. Now, scaling up the bound from Lemma 3.3, we know that any two points respectively on segments $[u, v]$ and $[u, w]$ which are both outside the box B'_u must be at distance at least $\frac{\sigma\epsilon}{2n^2}$, i.e., at least 5. Thus, at least one of the projections v' and w' must be inside the smaller box B'_u . Now, remember that the point x is at distance at most 2 from that projection, so we conclude that x is inside the larger box B''_u , which concludes.
- (iii) For any segment $[u, v]$ of the drawing and point w different from u and v , the box B''_w does not contain any point of the margin $M_{u,v}$ of $[u, v]$. This is obtained by scaling up the bound from Lemma 3.1. Specifically, considering the point w and the segment $[u, v]$, we know that the distance between w and $[u, v]$ is at least $\frac{\sigma}{\sqrt{2n}}$, which is at least $20n^2$. Now, the points of the box B''_w are at distance $\leq \sqrt{2} \times (\epsilon\sigma + 2)$ from w , i.e., at distance $\leq \sqrt{2} \times (10n^2 + 2)$. Further, the points of the margin are at distance ≤ 2 from the segment. Now, we have $\sqrt{2} \times (10n^2 + 2) + 2 < 20n^2$ because $\sqrt{2} < 1.5$ and $n \geq 1$, so we conclude that the box B''_w and margin do not intersect.
- (iv) For two segments that do not share any endpoints, their margins do not intersect. Indeed, the segments do not intersect (this uses the fact that there are no edge crossings), and the distance between each endpoint pair is at least σ , hence, at least 5. (Note that, for any two segments that do not intersect, the minimum of the distance from one segment to another can always be achieved by taking one endpoint of one of the segments.)

In summary, after scaling up, we obtain a situation similar to Figure 6. The vertices are at points whose coordinates are multiples of the integer σ , and considering the box B''_w of each vertex w , and the margin $M_{u,v}$ at distance 2 around each segment $[u, v]$, then (i) the boxes are pairwise disjoint; (ii) the margins of two segments sharing an endpoint intersect only within the box of that endpoint; (iii) the box on a vertex only intersects with the margins of the segments where this vertex occurs; (iv) two margins of segments that do not share an endpoint do not intersect.

Now, compute in polynomial time with Lemma 4.1 a path for each edge, that connects the endpoints of the edge (i.e., the vertices) while staying at distance at most 2 from the segment that represents the edge, i.e., staying in the margin of the segment corresponding to the edge. The total time to compute these paths can be upper bounded by the total grid size, which is $O(n^8)$, times the number of paths, which is $O(n^2)$, hence an upper bound of $O(n^{10})$.

We know that the path for each segment remains in the margin at distance 2 of that segment. We now claim that the paths of two segments can only share some intermediate vertices if the segments share an endpoint v , and that then the shared intermediate vertices are within the box B_v'' of that endpoint. Indeed, if the segments do not share any endpoints then their margins do not intersect by (iv), and as the paths are contained within the margins, they also share no vertices in that case. Now, if the segments share an endpoint v , the margins only intersect within B_v'' by (ii), hence the same is true of the paths.

Thus, the only remaining part is to fix the embedding by changing the paths within the boxes. We can do so for each box independently, as the boxes are disjoint by (i), and by (iii) the box B_v'' centered on a vertex v does not contain any vertex for paths corresponding to edges that do not involve v .

6 Making the paths disjoint within the boxes

For each vertex v of the graph, let G_v be the subgraph induced by the vertices of the box B_v'' of radius $\sigma\epsilon + 2$ centered on v . Note that, because the coordinates of the box centers are multiples of the even integer σ and the box radius $\sigma\epsilon + 2$ is an even integer, we know that G_v is isomorphic to a $(2\sigma\epsilon + 4, 2\sigma\epsilon + 4)$ -wall graph. For each edge $e = \{u, v\}$, let u_e and v_e be respectively the last and first vertices of the path from u to v which are in the boxes B_u'' and B_v'' respectively, and let P_e be the subpath starting just after u_e and finishing just before v_e .

We know that the paths P_e and $P_{e'}$ for two distinct edges e and e' do not intersect, because these paths are outside the boxes of the vertex endpoints, they are within the margin of the segment so cannot enter any other box by (iii), and they cannot be within the margin of any other segment by (ii) and (iv).

So let us now fix the rest of the paths, which are within the boxes. Consider the paths from a vertex u to the vertices of the form u_e that are just before the paths P_e . There are at most 3 such vertices, because the graph is degree-3. See Figure 7 to understand why the paths from u to these three vertices may intersect. So we change completely these paths, in the process possibly also changing the image of the vertex v in the embedding to be another vertex of the box.

Let us state what we need:

► **Lemma 6.1.** *For any (r, s) -wall graph $W_{r,s}$ with $r \geq 1$ and $s \geq 2$, given three distinct vertices p, q, r , we can compute in time $O(r \times s)$ a vertex x of $W_{r,s}$ and three vertex-disjoint paths between x and p , and x and q , and x and r .*

Proof. As $s \geq 2$, the graph is connected. Find in linear time an arbitrary simple path from p to q . If r is in the path, take $x = r$, which concludes. Otherwise, find in linear time an arbitrary simple path from r to p , and stop as soon as it encounters a vertex of the previous path (which may be p, q , or an intermediate vertex of that path). Take the encountered vertex to be x , and the three vertex-disjoint paths connecting x and p , x and q , and x and r , are then easy to find. ◀

Thus, for each vertex v , we consider the box B_v'' and the graph G_v . If v has strictly less than 2 neighbors, there is nothing to do. If v has two neighbors, letting v_1 and v_2 be the last vertices before the paths P_{e_1} and P_{e_2} corresponding to the edge, we set the image of v to be v_1 and pick an arbitrary simple path from v_1 to v_2 in G_v . If v has three neighbors, we use Lemma 6.1 to find the image of v and the paths. This process is in linear time in each box, so in time $O(n^8)$ overall where n is the number of graph vertices.

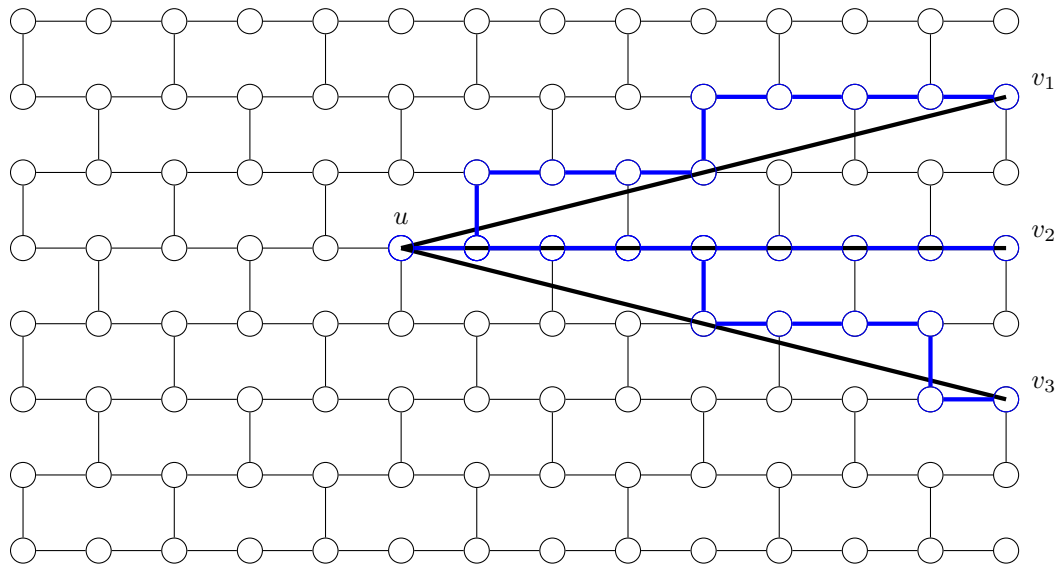

■ **Figure 7** Choosing a vertex of the wall graph to embed the vertex u of the graph with three neighbors w_1, w_2, w_3 such that the last vertices in the box in the paths approximating the edges $\{u, w_1\}$ and $\{u, w_2\}$ and $\{u, w_3\}$ are v_1 and v_2 and v_3 . We show in black the beginning of the segments $[u, w_1]$ and $[u, w_2]$ and $[u, w_3]$, and show in blue the paths given by Lemma 4.1, which overlap. To fix the issue we simply connect v_1 and v_2 and v_3 as explained in the text and choose our target vertex for u accordingly.

We have explained how to fix the embedding inside the boxes to ensure that there are no intersections inside the boxes, and there are no intersections outside the boxes, so this concludes the computation of the embedding and concludes the proof of Theorem 1.1.

References

- 1 Antoine Amarilli. *Leveraging the structure of uncertain data*. PhD thesis, Télécom ParisTech, 2016.
- 2 Chandra Chekuri and Julia Chuzhoy. Polynomial bounds for the grid-minor theorem. *Journal of the ACM (JACM)*, 63(5), 2016.
- 3 Marek Chrobak and Thomas H. Payne. A linear-time algorithm for drawing a planar graph on a grid. *Information Processing Letters*, 54(4), 1995.
- 4 Feodor F. Dragan, Fedor V. Fomin, and Petr A. Golovach. Spanners in sparse graphs. *Journal of Computer and System Sciences (JCSS)*, 77(6), 2011.
- 5 Neil Robertson, Paul Seymour, and Robin Thomas. Quickly excluding a planar graph. *Journal of Combinatorial Theory, Series B*, 62(2), 1994.
- 6 Walter Schnyder. Embedding planar graphs on the grid. In *Proc. SODA*, 1990.
- 7 Roberto Tamassia and Ioannis G. Tollis. Planar grid embedding in linear time. *IEEE Transactions on circuits and systems*, 36(9), 1989.
- 8 user67422 (<https://csttheory.stackexchange.com/users/67422/user67422>). Embedding degree-3 planar graphs as topological minors in wall graphs in polynomial time. Theoretical Computer Science Stack Exchange. URL: <https://csttheory.stackexchange.com/q/52489>, arXiv:<https://csttheory.stackexchange.com/q/52489>.