

# AFFINE GORDON–BENDER–KNUTH IDENTITIES FOR CYLINDRIC SCHUR FUNCTIONS

JISUN HUH, JANG SOO KIM, CHRISTIAN KRATTENTHALER, AND SOICHI OKADA

**ABSTRACT.** The Gordon–Bender–Knuth identities are determinant formulas for the sum of Schur functions of partitions with bounded height, which have interesting combinatorial consequences such as connections between standard Young tableaux of bounded height, lattice walks in a Weyl chamber, and noncrossing matchings. In this paper we prove an affine analog of the Gordon–Bender–Knuth identities, which are determinant formulas for the sum of cylindric Schur functions. We also study combinatorial aspects of these identities. As a consequence we obtain an unexpected connection between cylindric standard Young tableaux and  $r$ -noncrossing and  $s$ -nonnesting matchings.

## 1. INTRODUCTION

Schur functions  $s_\lambda$ , indexed by partitions  $\lambda$ , are an extensively studied class of symmetric functions which play an important role in many areas of mathematics including geometry, representation theory and combinatorics. They form a basis of the space of symmetric functions and the Jacobi–Trudi formulas

$$(1.1) \quad s_\lambda = \det(h_{\lambda_i - i + j}), \quad s_{\lambda'} = \det(e_{\lambda_i - i + j})$$

give a way to express Schur functions in terms of complete homogeneous symmetric functions  $h_\lambda$  and elementary symmetric functions  $e_\lambda$ , where  $\lambda'$  denotes the conjugate of the partition  $\lambda$ .

It is well known [27, Corollary 7.13.8] that the sum of all Schur functions  $s_\lambda(\mathbf{x})$  in the variables  $\mathbf{x} = (x_1, x_2, \dots)$  has the following simple product formula:

$$\sum_{\lambda} s_\lambda(\mathbf{x}) = \frac{1}{\prod_i (1 - x_i) \prod_{i < j} (1 - x_i x_j)}.$$

About half a century ago, Gordon [14] and Bender and Knuth [1] found a formula for the sum of  $s_\lambda$  for all partitions  $\lambda$  such that the length  $\ell(\lambda)$  of  $\lambda$  is bounded. Using the Jacobi–Trudi formulas (1.1) and the involution exchanging  $s_\lambda$  and  $s_{\lambda'}$ , we can state their formulas as follows.

**Theorem 1.1** (The Gordon–Bender–Knuth identities [1, 14]). *For a nonnegative integer  $h$ ,*

$$(1.2) \quad \sum_{\lambda: \ell(\lambda) \leq 2h+1} s_{\lambda'}(\mathbf{x}) = \sum_{k \geq 0} e_k(\mathbf{x}) \det_{1 \leq i, j \leq h} (f_{-i+j}(\mathbf{x}) - f_{i+j}(\mathbf{x})),$$

$$(1.3) \quad \sum_{\lambda: \ell(\lambda) \leq 2h} s_{\lambda'}(\mathbf{x}) = \det_{1 \leq i, j \leq h} (f_{-i+j}(\mathbf{x}) + f_{i+j-1}(\mathbf{x})),$$

where

$$(1.4) \quad f_k(\mathbf{x}) = \sum_{n \in \mathbb{Z}} e_n(\mathbf{x}) e_{n+k}(\mathbf{x}).$$

We now review some combinatorial consequences of the Gordon–Bender–Knuth identities. Precise definitions will be given in the next section.

---

2010 *Mathematics Subject Classification.* Primary 05E05; Secondary 05A15 05A19.

*Key words and phrases.* cylindric tableau, Schur function, set partition.

Let  $\text{SYT}_n(h)$  denote the set of standard Young tableaux of size  $n$  with height at most  $h$ . Extracting the coefficients of  $x_1 \cdots x_n$  in (1.2) and (1.3) Gessel [10] obtained the following formula.

**Corollary 1.2** (Gessel [10]). *For an integer  $h \geq 0$ , we have*

$$(1.5) \quad \sum_{n \geq 0} |\text{SYT}_n(2h+1)| \frac{x^n}{n!} = \exp(x) \det_{1 \leq i, j \leq h} (I_{-i+j}(2x) - I_{i+j}(2x)),$$

$$(1.6) \quad \sum_{n \geq 0} |\text{SYT}_n(2h)| \frac{x^n}{n!} = \det_{1 \leq i, j \leq h} (I_{-i+j}(2x) + I_{i+j-1}(2x)),$$

where  $I_\alpha(x)$  is the modified Bessel function given by

$$(1.7) \quad I_\alpha(x) = \sum_{\ell \geq 0} \frac{(x/2)^{2\ell+|\alpha|}}{\ell! (\ell + |\alpha|)!}.$$

Using (1.5) and a result of Grabiner and Magyar [16] on lattice walks in a Weyl chamber, Zeilberger [29] showed that  $|\text{SYT}_n(2h+1)|$  is equal to the number of walks of length  $n$  from  $\mathbf{0}$  to  $\mathbf{0}$  in the region  $\{(x_1, \dots, x_h) : x_1 \geq \dots \geq x_h \geq 0\}$  using steps in  $\{\mathbf{0}, \pm \varepsilon_1, \dots, \pm \varepsilon_h\}$ , where  $\mathbf{0} \in \mathbb{Z}^h$  is the origin and the  $\varepsilon_i$ ,  $1 \leq i \leq h$ , are the standard basis vectors. Eu et al. [8] proved a similar result for  $|\text{SYT}_n(2h)|$ .

In their seminal paper [3], Chen, Deng, Du, Stanley, and Yan found a bijection between set partitions and vacillating tableaux. Combining their result restricted to (partial) matchings and Zeilberger's result, one obtains

$$(1.8) \quad |\text{SYT}_n(2h+1)| = |\text{NC}_n(h+1)|,$$

where  $\text{NC}_n(k)$  is the set of  $k$ -noncrossing matchings on  $[n] = \{1, \dots, n\}$ . Chen et al. [3] also showed the interesting symmetry

$$(1.9) \quad |\text{NCNN}_n(r, s)| = |\text{NCNN}_n(s, r)|,$$

where  $\text{NCNN}_n(r, s)$  is the set of  $r$ -noncrossing and  $s$ -nonnesting matchings on  $[n]$ .

Since taking the transpose of a standard Young tableau interchanges its height and width, (1.8) and (1.9) imply that the number of standard Young tableaux of size  $n$  with width at most  $2w+1$  is equal to the number of  $(w+1)$ -noncrossing (or  $(w+1)$ -nonnesting) matchings on  $[n]$ . Observing the above results one might naively guess that the set of standard Young tableaux of size  $n$  with height at most  $2h+1$  and width at most  $2w+1$  may be equinumerous with  $\text{NCNN}_n(h+1, w+1)$ . However, this is easily seen to be false because there is no such standard Young tableau if  $n > (2h+1)(2w+1)$ , whereas  $\text{NCNN}_n(h+1, w+1)$  is always nonempty, for instance, it contains the matching consisting only of singletons. Therefore a natural question is: What is the "correct" set of standard Young tableaux of size  $n$  that is equinumerous with  $\text{NCNN}_n(h+1, w+1)$ ?

In this paper we prove the following theorem, which answers the question above (see Section 2 for precise definitions).

**Theorem 1.3.** *The number of  $(2h+1, 2w+1)$ -cylindric standard Young tableaux of size  $n$  is equal to the number of  $(h+1)$ -noncrossing and  $(w+1)$ -nonnesting matchings on  $[n]$ .*

The discovery of Theorem 1.3 was somewhat unexpected. The original motivation of this paper was to find a bijective proof of a seemingly unrelated result of Mortimer and Prellberg [23] on lattice walks in a triangular region and bounded Motzkin paths. We discovered Theorem 1.3 as a generalization of their result. More details on the motivation will be given in Section 2.4.

The cylindric standard Young tableaux in Theorem 1.3 are a subclass of cylindric semistandard Young tableaux, which were first introduced by Gessel and Krattenthaler [11]. Besides their own combinatorial

properties, cylindric semistandard Young tableaux also have interesting applications in geometry. For instance, Bertram, Ciocan-Fontanine, and Fulton [2] showed that quantum Kostka numbers are counted by certain cylindric semistandard Young tableaux.

As is well known, the Schur function  $s_\lambda(\mathbf{x})$  is the generating function for semistandard Young tableaux of shape  $\lambda$ . In his study of quantum Schubert calculus, Postnikov [26] introduced cylindric skew Schur functions, which are generating functions for cylindric semistandard Young tableaux. He showed that if we expand a cylindric skew Schur function in terms of Schur functions, then the coefficients are 3-point Gromov–Witten invariants. Cylindric skew Schur functions were further studied by McNamara [22] and Lee [21].

The cylindric Schur function  $s_{\lambda[h,w]}(\mathbf{x})$  can be defined as the generating function for semistandard Young tableaux of a cylindric shape  $\lambda[h, w]$ . Here  $\lambda[h, w]$  is the set of cells in all translations  $\lambda + (kh, -kw)$ ,  $k \in \mathbb{Z}$ , of the Young diagram of a partition  $\lambda$ , where two cells  $(i, j)$  and  $(i', j')$  are identified if  $(i, j) = (i', j') + (kh, -kw)$  for some  $k \in \mathbb{Z}$ . The transpose  $\lambda[h, w]'$  of the cylindric shape  $\lambda[h, w]$  can be defined in the usual way that changes each cell  $(i, j)$  to  $(j, i)$ . We note that our definition of a cylindric Schur function is equivalent to Postnikov's [26] although the notation is slightly different.

Using the idea of Gessel and Krattenthaler [11] we prove the following Jacobi–Trudi-type formula for cylindric Schur functions. This formula was also stated in [26, (11)] without proof.

**Theorem 1.4.** *For positive integers  $h$  and  $w$  and a partition  $\lambda$  with  $\ell(\lambda) \leq h$  and  $\lambda_1 - \lambda_h \leq w$ , we have*

$$(1.10) \quad s_{\lambda[h,w]'}(\mathbf{x}) = \sum_{\substack{k_1, \dots, k_h \in \mathbb{Z} \\ k_1 + \dots + k_h = 0}} \det_{1 \leq i, j \leq h} \left( e_{\lambda_i - i + j + (h+w)k_i}(\mathbf{x}) \right).$$

We now state the main result in this paper, which is an affine analog of the Gordon–Bender–Knuth identities (Theorem 1.1), using the following affine analogs of the function  $f_k(\mathbf{x})$  in (1.4):

$$\begin{aligned} F_{r,N}(\mathbf{x}) &= \sum_{k \in \mathbb{Z}} f_{r+Nk}(\mathbf{x}) = \sum_{k \in \mathbb{Z}} \sum_{n \in \mathbb{Z}} e_n(\mathbf{x}) e_{n+r+Nk}(\mathbf{x}), \\ \bar{F}_{r,N}(\mathbf{x}) &= \sum_{k \in \mathbb{Z}} (-1)^k f_{r+Nk}(\mathbf{x}) = \sum_{k \in \mathbb{Z}} \sum_{n \in \mathbb{Z}} (-1)^k e_n(\mathbf{x}) e_{n+r+Nk}(\mathbf{x}). \end{aligned}$$

**Theorem 1.5** (The affine Gordon–Bender–Knuth identities). *For positive integers  $h$  and  $w$ , we have*

$$(1.11) \quad \sum_{\lambda \in \text{Par}(2h+1, w)} s_{\lambda[2h+1, w]'}(\mathbf{x}) = \sum_{k \geq 0} e_k(\mathbf{x}) \det_{1 \leq i, j \leq h} \left( F_{-i+j, 2h+1+w}(\mathbf{x}) - F_{i+j, 2h+1+w}(\mathbf{x}) \right),$$

$$(1.12) \quad \sum_{\lambda \in \text{Par}(2h, w)} s_{\lambda[2h, w]'}(\mathbf{x}) = \det_{1 \leq i, j \leq h} \left( \bar{F}_{-i+j, 2h+w}(\mathbf{x}) + \bar{F}_{i+j-1, 2h+w}(\mathbf{x}) \right),$$

where  $\text{Par}(m, w)$  is the set of partitions  $\lambda$  with  $\ell(\lambda) \leq m$  and  $\lambda_1 - \lambda_m \leq w$ .

The rest of this paper is organized as follows. In Section 2 we give basic definitions and the motivation of this paper. In Section 3 we explain why Theorem 1.5 is an affine analog of Theorem 1.1 and state variations of the affine Gordon–Bender–Knuth identities. In Section 4 we prove the affine Gordon–Bender–Knuth identities. In Section 5 we introduce a systematic approach to give another proof of the affine Gordon–Bender–Knuth identities. Using this approach we also prove the variations of the affine Gordon–Bender–Knuth identities. In Section 6 we prove the Jacobi–Trudi-type identity (Theorem 1.4) for cylindric Schur functions. We also give a combinatorial interpretation for the right-hand side of the affine Gordon–Bender–Knuth identities (1.11) and (1.12) in terms of up-down tableaux. In Section 7 we state combinatorial consequences of the affine Gordon–Bender–Knuth identities and prove Theorem 1.3 and its variations. In Section 8 we give a bijective proof of the special case  $h = 1$  of some variations of Theorem 1.3.

## 2. PRELIMINARIES

In this section we give basic definitions and some properties of cylindric tableaux. We then give the original motivation of this paper.

**2.1. Matchings.** A *(partial) matching* on  $[n]$  is a set partition of  $[n]$  into blocks of size one or two. The element in a singleton is called a *fixed point* and a pair  $(i, j)$  of integers  $i < j$  that are contained in a block of size two is called an *arc*.

**Definition 2.1.** Let  $k$  be a positive integer. A *k-crossing* is a set of  $k$  arcs  $(i_1, j_1), \dots, (i_k, j_k)$  such that  $i_1 < \dots < i_k < j_1 < \dots < j_k$ . A *k-nesting* is a set of  $k$  arcs  $(i_1, j_1), \dots, (i_k, j_k)$  such that  $i_1 < \dots < i_k < j_k < \dots < j_1$ . We say that a matching is *k-noncrossing* (resp. *k-nonnesting*) if it does not have any *k-crossing* (resp. *k-nesting*).

We denote by  $\text{NCNN}_n(r, s)$  the set of  $r$ -noncrossing and  $s$ -nonnesting matchings on  $[n]$ .

**2.2. Tableaux.** A *partition* of a nonnegative integer  $n$  is a weakly decreasing sequence  $\lambda = (\lambda_1, \lambda_2, \dots, \lambda_k)$  of positive integers, called *parts*, such that  $\sum_{i \geq 1} \lambda_i = n$ . This also includes the empty partition  $()$ , denoted by  $\emptyset$ . If  $\lambda$  is a partition of  $n$  into  $k$  parts, we write  $|\lambda| = n$  and  $\ell(\lambda) = k$  and say that  $\lambda$  has *size*  $n$  and *length*  $k$ . We denote by  $\text{Par}$  the set of all partitions. It is often convenient to identify a partition  $(\lambda_1, \lambda_2, \dots, \lambda_k)$  with the infinite sequence  $(\lambda_1, \lambda_2, \dots, \lambda_k, 0, 0, \dots)$ . Using this convention we define  $\lambda_i = 0$  for  $i > \ell(\lambda)$ .

The *Young diagram* of a partition  $\lambda = (\lambda_1, \lambda_2, \dots, \lambda_k)$  is the set  $\{(i, j) : 1 \leq i \leq k, 1 \leq j \leq \lambda_i\}$ . Each element  $(i, j)$  in a Young diagram is called a *cell*. The Young diagram of  $\lambda$  is visualized as a left-justified array of unit square cells with  $\lambda_i$  cells in the  $i$ -th row,  $i = 1, 2, \dots, k$ , from top to bottom. We identify  $\lambda$  with its Young diagram. The *conjugate* (or *transpose*)  $\lambda'$  of a partition  $\lambda$  is the partition whose Young diagram is given by  $\{(j, i) : (i, j) \in \lambda\}$ . For two partitions  $\lambda$  and  $\mu$  we write  $\mu \subseteq \lambda$  to mean that the Young diagram of  $\mu$  is contained in that of  $\lambda$ . If  $\mu \subseteq \lambda$ , the *skew shape*  $\lambda/\mu$  is the set-theoretic difference  $\lambda - \mu$  of the Young diagrams of  $\lambda$  and  $\mu$ . Each partition  $\lambda$  is also considered as a skew shape  $\lambda/\emptyset$ .

A *tableau* of shape  $\lambda/\mu$  is a filling of the cells in  $\lambda/\mu$  with positive integers. For a tableau  $T$  of shape  $\lambda = (\lambda_1, \lambda_2, \dots)$ , the *size*, *height*, and *width* are defined to be  $|\lambda|$ ,  $\ell(\lambda)$ , and  $\lambda_1$ , respectively. A *semistandard Young tableau* (SSYT) (resp. *row-strict tableau* (RST)) is a tableau in which the entries along rows (resp. columns) are weakly increasing and the entries along columns (resp. rows) are strictly increasing. A *standard Young tableau* (SYT) is a semistandard Young tableau (or equivalently, row-strict tableau) whose entries are the integers  $1, 2, \dots, n$ , where  $n$  is the size of the tableau.

**Definition 2.2.** An SSYT (resp. RST)  $T$  is  $(h, w)$ -*cylindric* if  $T$  has at most  $h$  rows and  $T \cup (T + (h, -w))$  is an SSYT (resp. RST) of a valid skew shape, where  $T + (h, -w)$  is the SSYT (resp. RST) obtained by shifting  $T$  by  $h$  units down and  $w$  units to the left (see Figure 1).

**Definition 2.3.** Let  $\text{Par}(h, w)$  denote the set of partitions  $\lambda$  with  $\ell(\lambda) \leq h$  and  $\lambda_1 - \lambda_h \leq w$ . For  $\lambda \in \text{Par}(h, w)$ , we denote by  $\text{CSSYT}(\lambda; h, w)$  (resp.  $\text{CRST}(\lambda; h, w)$ ) the set of all  $(h, w)$ -cylindric SSYTs (resp. RSTs) of shape  $\lambda$ . Let

$$\text{CSSYT}(h, w) = \bigcup_{\lambda \in \text{Par}(h, w)} \text{CSSYT}(\lambda; h, w), \quad \text{CRST}(h, w) = \bigcup_{\lambda \in \text{Par}(h, w)} \text{CRST}(\lambda; h, w).$$

We also denote by  $\text{CSYT}_n(h, w)$  the set of  $(h, w)$ -cylindric standard Young tableaux of size  $n$ .

Note that for a partition  $\lambda$  with  $\ell(\lambda) \leq h$ , we have  $\text{CSSYT}(\lambda; h, w) = \emptyset$  unless  $\lambda_1 - \lambda_h \leq w$  because if  $\lambda_1 - \lambda_h > w$ , then  $T \cup (T + (h, -w))$  is not of a skew shape.

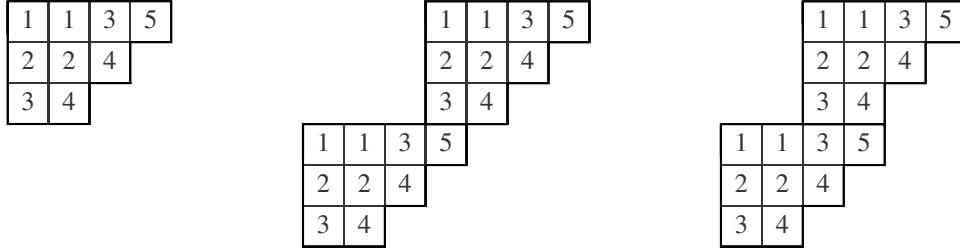

FIGURE 1. The SSYT  $T$  on the left is  $(3, 3)$ -cylindric but not  $(3, 2)$ -cylindric because the tableau in the middle is an SSYT but the tableau on the right is not an SSYT. Moreover,  $T$  is not  $(3, 1)$ -cylindric because  $T \cup (T + (3, -1))$  is not of a skew shape.

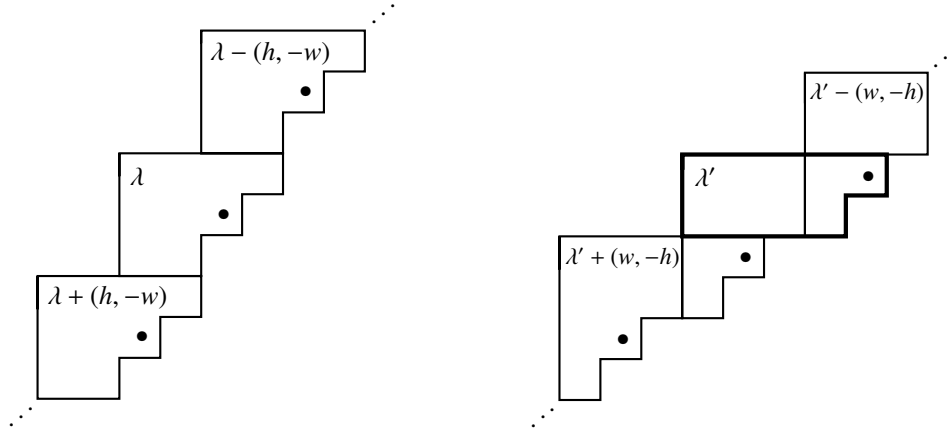

FIGURE 2. The  $(3, 2)$ -cylindric shape  $\lambda[3, 2]$  of  $\lambda = (4, 3, 2)$  is shown on the left. Its transpose  $\lambda[3, 2]'$  is shown on the right, where the  $(3, 2)$ -transpose  $\text{tr}(\lambda; 3, 2)$  of  $\lambda$  is drawn with thick boundary. The cells with dots are identified by the relation  $\sim$ .

**Definition 2.4.** Let  $h$  and  $w$  be positive integers. For  $\lambda \in \text{Par}(h, w)$ , the  $(h, w)$ -cylindric shape  $\lambda[h, w]$  is defined by

$$\lambda[h, w] = \{(i, j) + (kh, -kw) : (i, j) \in \lambda, k \in \mathbb{Z}\} / \sim$$

with the relation  $(i, j) \sim (i', j')$  if and only if  $(i, j) = (i', j') + (kh, -kw)$  for some  $k \in \mathbb{Z}$ . The *transpose*  $\lambda[h, w]'$  of  $\lambda[h, w]$  is defined by  $\lambda[h, w]' = \{[(j, i)] : [(i, j)] \in \lambda[h, w]\}$ , where  $[(i, j)]$  is the equivalence class containing  $(i, j)$ . See Figure 2. The  $(h, w)$ -transpose  $\text{tr}(\lambda; h, w)$  of  $\lambda$  is defined by

$$\text{tr}(\lambda; h, w) = \{(i, j) : [(i, j)] \in \lambda[h, w]', 1 \leq i \leq w\}.$$

By definition one can easily see that  $\lambda[h, w]' = \text{tr}(\lambda; h, w)[w, h]$ . The map  $\lambda \mapsto \text{tr}(\lambda; h, w)$  is essentially the same as the map  $\Psi$  due to Goodman and Wenzl [13, p. 253].

One can naturally identify an  $(h, w)$ -cylindric SSYT (or RST)  $T$  of shape  $\lambda$  with a filling of the cylindrical shape  $\lambda[h, w]$  by filling each cell  $(i', j') \in [(i, j)]$  with the same entry in  $(i, j)$ . Then the transpose  $T'$  and the  $(h, w)$ -transpose  $\text{tr}(T; h, w)$  are defined in the obvious way as shown in Figure 3.

**Proposition 2.5.** Let  $h$  and  $w$  be positive integers. Then the map  $T \mapsto \text{tr}(T; h, w)$  is a bijection from  $\text{CRST}(h, w)$  to  $\text{CSSYT}(w, h)$  (and also from  $\text{CSSYT}(h, w)$  to  $\text{CRST}(w, h)$ ). Moreover, for  $\lambda \in \text{Par}(h, w)$ , this map induces a bijection from  $\text{CRST}(\lambda; h, w)$  to  $\text{CSSYT}(\text{tr}(\lambda; h, w); w, h)$  and also a bijection from

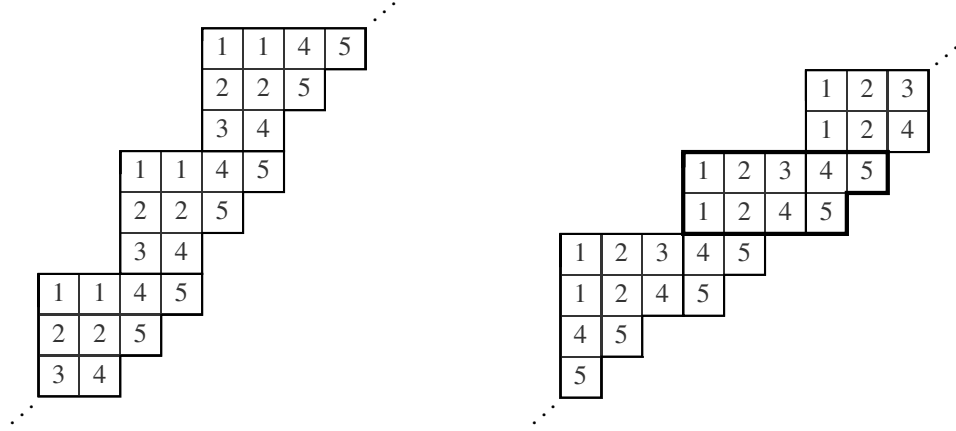

FIGURE 3. The left diagram shows a  $(3, 2)$ -cylindric SSYT  $T$  of shape  $\lambda = (4, 3, 2)$  identified with a filling of the cylindric shape  $\lambda[3, 2]$ . The right diagram shows the transpose  $T'$  as a filling of  $\lambda[3, 2]'$  and the  $(3, 2)$ -transpose  $\text{tr}(T; 3, 2)$  of  $T$  whose shape is  $\text{tr}(\lambda; 3, 2) = (5, 4)$  drawn with thick boundary.

$\text{CSYT}_n(h, w)$  to  $\text{CSYT}_n(w, h)$ . In particular, we have

$$|\text{CSYT}_n(h, w)| = |\text{CSYT}_n(w, h)|.$$

*Proof.* This is immediate from the construction of the map  $T \mapsto \text{tr}(T; h, w)$ .  $\square$

**2.3. Symmetric functions.** In this paper we shall be concerned with the following symmetric functions in the variables  $\mathbf{x} = (x_1, x_2, \dots)$ . For a symmetric function  $f(\mathbf{x})$  we will often omit the variables and simply write  $f$ .

The  $n$ -th complete homogeneous symmetric function  $h_n(\mathbf{x})$  and the  $n$ -th elementary symmetric function  $e_n(\mathbf{x})$  are defined by

$$h_n(\mathbf{x}) = \sum_{i_1 \leq i_2 \leq \dots \leq i_n} x_{i_1} x_{i_2} \cdots x_{i_n}, \quad e_n(\mathbf{x}) = \sum_{i_1 < i_2 < \dots < i_n} x_{i_1} x_{i_2} \cdots x_{i_n},$$

respectively. We set  $h_0(\mathbf{x}) = e_0(\mathbf{x}) = 1$  and define  $h_n(\mathbf{x})$  and  $e_n(\mathbf{x})$  to be zero for  $n < 0$ . For any integer sequence  $\alpha = (\alpha_1, \alpha_2, \dots, \alpha_k)$ , we define  $h_\alpha(\mathbf{x}) = h_{\alpha_1}(\mathbf{x}) h_{\alpha_2}(\mathbf{x}) \cdots h_{\alpha_k}(\mathbf{x})$  and  $e_\alpha(\mathbf{x}) = e_{\alpha_1}(\mathbf{x}) e_{\alpha_2}(\mathbf{x}) \cdots e_{\alpha_k}(\mathbf{x})$ .

The following notation will be used frequently in this paper.

**Definition 2.6.** For integers  $r \in \mathbb{Z}$  and  $N > 0$  we define

$$\begin{aligned} f_r(\mathbf{x}) &= \sum_{i \in \mathbb{Z}} e_i(\mathbf{x}) e_{i+r}(\mathbf{x}), \\ F_{r,N}(\mathbf{x}) &= \sum_{k \in \mathbb{Z}} f_{r+Nk}(\mathbf{x}), \\ \overline{F}_{r,N}(\mathbf{x}) &= \sum_{k \in \mathbb{Z}} (-1)^k f_{r+Nk}(\mathbf{x}). \end{aligned}$$

Note that  $f_r(\mathbf{x}) = f_{-r}(\mathbf{x})$ ,  $F_{r,N}(\mathbf{x}) = F_{-r,N}(\mathbf{x})$ ,  $\overline{F}_{r,N}(\mathbf{x}) = \overline{F}_{-r,N}(\mathbf{x})$ , and

$$\lim_{N \rightarrow \infty} F_{r,N}(\mathbf{x}) = \lim_{N \rightarrow \infty} \overline{F}_{r,N}(\mathbf{x}) = f_r(\mathbf{x}).$$

For any tableau  $T$ , let  $\mathbf{x}^T = x_1^{\alpha_1} x_2^{\alpha_2} \cdots$ , where  $\alpha_i$  is the number of  $i$ 's in  $T$ . For a partition  $\lambda$ , the *Schur function*  $s_\lambda(\mathbf{x})$  is defined by

$$s_\lambda(\mathbf{x}) = \sum_T \mathbf{x}^T,$$

where the sum is over all semistandard Young tableaux  $T$  of shape  $\lambda$ .

**Definition 2.7.** Let  $h$  and  $w$  be positive integers and let  $\lambda \in \text{Par}(h, w)$ . The  $(h, w)$ -cylindric Schur function  $s_{\lambda[h, w]}(\mathbf{x})$  of shape  $\lambda[h, w]$  is defined by

$$s_{\lambda[h, w]}(\mathbf{x}) = \sum_{T \in \text{CSSYT}(\lambda; h, w)} \mathbf{x}^T.$$

By definition we have

$$\lim_{w \rightarrow \infty} s_{\lambda[h, w]}(\mathbf{x}) = s_\lambda(\mathbf{x}).$$

Recall that each tableau  $T \in \text{CSSYT}(\lambda; h, w)$  can be understood as a filling of the cylindrical shape  $\lambda[h, w]$ . Therefore our definition of a cylindric Schur function is equivalent to that of Postnikov [26].

For our purpose it is more convenient to deal with  $s_{\lambda[h, w]'}(\mathbf{x})$ , which is a  $(w, h)$ -cylindric Schur function. The following proposition shows that  $s_{\lambda[h, w]'}(\mathbf{x})$  is the generating function for cylindric row-strict tableaux.

**Proposition 2.8.** *Let  $h$  and  $w$  be positive integers and  $\lambda \in \text{Par}(h, w)$ . Then we have*

$$s_{\lambda[h, w]'}(\mathbf{x}) = \sum_{T \in \text{CRST}(\lambda; h, w)} \mathbf{x}^T.$$

*Proof.* Since  $\lambda[h, w]' = \text{tr}(\lambda; h, w)[w, h]$ , we have

$$s_{\lambda[h, w]'}(\mathbf{x}) = \sum_{T \in \text{CSSYT}(\text{tr}(\lambda; h, w); w, h)} \mathbf{x}^T.$$

On the other hand, by the map in Proposition 2.5,

$$\sum_{T \in \text{CRST}(\lambda; h, w)} \mathbf{x}^T = \sum_{T \in \text{CSSYT}(\text{tr}(\lambda; h, w); w, h)} \mathbf{x}^T.$$

Combining the above two equations gives the proposition.  $\square$

The *quantum Kostka numbers*  $K_{\lambda[h, w]}^\alpha$  are defined by

$$s_{\lambda[h, w]}(\mathbf{x}) = \sum_{\alpha} K_{\lambda[h, w]}^\alpha \mathbf{x}^\alpha,$$

where the sum is over all sequences  $\alpha = (\alpha_1, \alpha_2, \dots)$  of nonnegative integers. By Proposition 2.8,  $K_{\lambda[h, w]'}^\alpha$  is the number of elements  $T \in \text{CRST}(\lambda; h, w)$  in which the number of  $i$ 's is equal to  $\alpha_i$  for all  $i \geq 1$ . There is another description of  $K_{\lambda[h, w]'}^\alpha$  in terms of lattice paths.

**Proposition 2.9.** *Let  $h$  and  $w$  be positive integers,  $\lambda$  a partition in  $\text{Par}(h, w)$ , and  $\alpha = (\alpha_1, \alpha_2, \dots)$  a sequence of nonnegative integers. Then  $K_{\lambda[h, w]'}^\alpha$  equals the number of paths in  $\mathbb{Z}^h$  from the origin to  $(\lambda_1, \dots, \lambda_h)$  and staying in the region*

$$\{(x_1, x_2, \dots, x_h) : x_1 \geq x_2 \geq \cdots \geq x_h \geq x_1 - w\},$$

where the  $i$ -th step is a vector with  $\alpha_i$  coordinates equal to 1 and  $h - \alpha_i$  coordinates equal to 0.

*Proof.* We obtain the proposition by reading the vectors of row lengths of the subtableaux containing all entries at most  $i$  for  $i = 0, 1, \dots$ . For example, the  $(2, 3)$ -cylindric row-strict tableau in the right diagram of Figure 3 corresponds to the lattice path

$$(0, 0) \rightarrow (1, 1) \rightarrow (2, 2) \rightarrow (3, 2) \rightarrow (4, 3) \rightarrow (5, 4).$$

The property that the tableau is  $(h, w)$ -cylindric translates into the property that the lattice walk is in the given region.  $\square$

**2.4. Motivation.** In this subsection we give the original motivation of this paper. We first need some definitions.

**Definition 2.10.** Let  $T_n(m)$  denote the set of walks  $p$  of length  $n$  from  $(0, 0)$  to any point in  $\mathbb{Z}^2$  consisting of steps in  $\{(1, 0), (0, 1), (-1, -1)\}$  such that  $p$  is contained in the triangular region  $\{(x_1, x_2) \in \mathbb{R}^2 : m \geq x_1 \geq x_2 \geq 0\}$ .

**Definition 2.11.** A *Motzkin path of length  $n$*  is a path from  $(0, 0)$  to  $(n, 0)$  consisting of *up steps*  $(1, 1)$ , *down steps*  $(1, -1)$ , and *horizontal steps*  $(1, 0)$  that never goes below the  $x$ -axis. The *height* of a Motzkin path is the largest  $y$ -coordinate of a point in it. We denote by  $\text{Mot}_n(h)$  the set of Motzkin paths of length  $n$  with height at most  $h$ .

In 2015 Mortimer and Prellberg [23] proved the following intriguing combinatorial identity using the kernel method:

$$(2.1) \quad |T_n(2h + 1)| = |\text{Mot}_n(h)|.$$

The original motivation of this paper was to find a bijective proof of (2.1). First let us consider the limiting case  $h \rightarrow \infty$ , i.e.,

$$(2.2) \quad |T_n(\infty)| = |\text{Mot}_n(\infty)|.$$

Each  $p = (p_0, \dots, p_n) \in T_n(\infty)$  can be identified with the sequence  $(\lambda^0, \dots, \lambda^n)$  of partitions with at most 3 rows, where  $\lambda^0 = \emptyset$  and  $\lambda^i$  is obtained from  $\lambda^{i-1}$  by adding a cell to the first (resp. second and third) row if  $p_i$  is  $(1, 0)$  (resp.  $(0, 1)$  and  $(-1, -1)$ ). This sequence of partitions is in turn naturally identified with a standard Young tableau of size  $n$  with height at most 3; see the proof of Theorem 8.1 for more details. On the other hand, there is a simple and well-known bijection between  $\text{Mot}_n(\infty)$  and the set of 2-noncrossing matchings on  $[n]$ . Therefore (2.2) is equivalent to

$$|\text{SYT}_n(3)| = |\text{NC}_n(2)|,$$

where  $\text{SYT}_n(3)$  is the set of standard Young tableaux of size  $n$  with height at most 3 and  $\text{NC}_n(2)$  is the set of 2-noncrossing matchings on  $[n]$ .

It is not hard to check that the bijection between  $T_n(\infty)$  and  $\text{SYT}_n(3)$  induces a bijection between  $T_n(2w + 1)$  and  $\text{SYT}_n(3, 2w + 1)$ .<sup>1</sup> On the other hand, the bijection between Motzkin paths and 2-noncrossing matchings also implies  $|\text{Mot}_n(w)| = |\text{NCNN}_n(2, w + 1)|$ . Therefore we can restate Mortimer and Prellberg's result (2.1) as follows:

$$|\text{SYT}_n(3, 2w + 1)| = |\text{NCNN}_n(2, w + 1)|.$$

This led the authors to an unexpected discovery of the following identity, which was stated as Theorem 1.3 in the introduction:

$$(2.3) \quad |\text{SYT}_n(2h + 1, 2w + 1)| = |\text{NCNN}_n(h + 1, w + 1)|.$$

Interestingly, both sides of (2.3) have generating functions already known in the literature [9, 15] in disguised forms using walks in an alcove. Therefore proving the above identity amounts to proving the equality between the two generating functions. After some computer experiments we further discovered more general symmetric function identities (Theorem 1.5), which turned out to be an affine analog of the Gordon–Bender–Knuth identities.

<sup>1</sup>Elizalde [7] also found this bijection independently.



## 3. AFFINE GORDON–BENDER–KNUTH IDENTITIES AND THEIR VARIATIONS

In this section we explain why Theorem 1.5 is an affine analog of Theorem 1.1. We then present variations of the affine Gordon–Bender–Knuth identities. We also present useful lemmas to prove these identities.

Note that by (1.1), the Gordon–Bender–Knuth identities (Theorems 1.1) can be restated as follows:

$$(3.1) \quad \sum_{\lambda: \ell(\lambda) \leq 2h+1} \det_{1 \leq i, j \leq 2h+1} (e_{\lambda_{i-i+j}}) = \sum_{k \geq 0} e_k \det_{1 \leq i, j \leq h} (f_{-i+j} - f_{i+j}),$$

$$(3.2) \quad \sum_{\lambda: \ell(\lambda) \leq 2h} \det_{1 \leq i, j \leq 2h} (e_{\lambda_{i-i+j}}) = \det_{1 \leq i, j \leq h} (f_{-i+j} + f_{i+j-1}).$$

Similarly, by (1.10), which will be proved later in Section 6, the affine Gordon–Bender–Knuth identities (Theorem 1.5) can be restated as follows:

$$(3.3) \quad \sum_{\lambda \in \text{Par}(2h+1, w)} \sum_{\substack{k_1, \dots, k_{2h+1} \in \mathbb{Z} \\ k_1 + \dots + k_{2h+1} = 0}} \det_{1 \leq i, j \leq 2h+1} (e_{\lambda_{i-i+j+(2h+w+1)k_i}}) = \sum_{k \geq 0} e_k \det_{1 \leq i, j \leq h} (F_{-i+j, 2h+w+1} - F_{i+j, 2h+w+1}),$$

$$(3.4) \quad \sum_{\lambda \in \text{Par}(2h, w)} \sum_{\substack{k_1, \dots, k_{2h} \in \mathbb{Z} \\ k_1 + \dots + k_{2h} = 0}} \det_{1 \leq i, j \leq 2h} (e_{\lambda_{i-i+j+(2h+w)k_i}}) = \det_{1 \leq i, j \leq h} (\bar{F}_{-i+j, 2h+w} + \bar{F}_{i+j-1, 2h+w}).$$

We will give two proofs of Theorem 1.5 of this form in Sections 4 and 5.

**3.1. The affine symmetric group and the dot action.** Here we explain why we call the identities (3.3) and (3.4) the *affine* Gordon–Bender–Knuth identities. Let  $V = \mathbb{R}^m$  be the Euclidean space with the standard inner product  $\langle \cdot, \cdot \rangle$  and the standard orthonormal basis  $\varepsilon_1, \dots, \varepsilon_m$ . Then  $\Phi^+ = \{\varepsilon_i - \varepsilon_j : 1 \leq i < j \leq m\}$  forms a positive system of the root system of type  $A_{m-1}$ . The symmetric group  $\mathfrak{S}_m$  acts on  $V$  by permuting the coordinates. The dot action of  $\mathfrak{S}_m$  on  $V$  is introduced by

$$\sigma \cdot \lambda = \sigma(\lambda + \delta) - \delta,$$

where  $\delta = (m-1, m-2, \dots, 1, 0)$ . If we put

$$C = \{\lambda \in V : \langle \lambda + \delta, \alpha \rangle > 0 \text{ for all } \alpha \in \Phi^+\},$$

called the *open fundamental Weyl chamber*, then the closure  $\bar{C}$  is a fundamental domain of the dot action and

$$C \cap \mathbb{Z}_{\geq 0}^m = \{\lambda \in \text{Par} : \ell(\lambda) \leq m\}$$

is the set of all partitions of length at most  $m$ . Then the left-hand sides of (3.1) and (3.2) can be written as

$$\sum_{\lambda \in C \cap \mathbb{Z}_{\geq 0}^m} \sum_{\sigma \in \mathfrak{S}_m} \text{sgn}(\sigma) e_{\sigma \cdot \lambda}(\mathbf{x}),$$

where  $m = 2h+1$  or  $2h$ . Now consider the affine symmetric group  $\widetilde{\mathfrak{S}}_m$ , which is defined as the semidirect product  $\mathfrak{S}_m \ltimes Q_m^\vee$  of  $\mathfrak{S}_m$  with the coroot lattice

$$Q_m^\vee = \{k = (k_1, \dots, k_m) \in \mathbb{Z}^m : k_1 + \dots + k_m = 0\}.$$

We put  $N = m + w$ . Then  $\widetilde{\mathfrak{S}}_m$  acts on  $V$  via the  $N$ -dilated dot action given by

$$(\sigma, k) \cdot \lambda = \sigma(\lambda + Nk + \delta) - \delta$$

for  $\sigma \in \mathfrak{S}_m$  and  $k \in Q_m^\vee$ . If we put

$$A = \{\lambda \in V : 0 < \langle \lambda + \delta, \alpha \rangle < N \text{ for all } \alpha \in \Phi^+\},$$

called the *fundamental alcove*, then the closure  $\bar{A}$  is a fundamental domain of the  $N$ -dilated dot action, and

$$A \cap \mathbb{Z}_{\geq 0}^m = \{\lambda \in \text{Par} : \ell(\lambda) \leq m, \lambda_1 - \lambda_m \leq w\}.$$

We denote this set by  $\text{Par}(m, w)$ . Hence the left-hand sides of (3.3) and (3.4) are written as

$$\sum_{\lambda \in A \cap \mathbb{Z}_{\geq 0}^m} \sum_{\bar{\sigma} \in \tilde{\mathfrak{S}}_m} \text{sgn}(\bar{\sigma}) e_{\bar{\sigma}, \lambda}(\mathbf{x}),$$

where the sign character  $\text{sgn}$  on  $\tilde{\mathfrak{S}}_m$  is defined by  $\text{sgn}(\sigma, k) = \text{sgn}(\sigma)$ . In this sense, (3.3) and (3.4) are an affine analog of the Gordon–Bender–Knuth identities. Moreover, in the limit  $w \rightarrow \infty$ , Theorem 1.5 (the affine Gordon–Bender–Knuth identities) becomes Theorem 1.1 (the Gordon–Bender–Knuth identities).

**3.2. Variations of affine Gordon–Bender–Knuth identities.** As is noted in [28, Section 7], one can deduce the following character identities from the Gordon–Bender–Knuth identities (Theorem 1.1) by specializing  $\mathbf{x}$  to  $\mathbf{x}_n = (x_1, \dots, x_n, 0, \dots)$ :

$$\sum_{\lambda \subseteq (s^n)} s_\lambda(x_1, \dots, x_n) = (x_1 \cdots x_n)^{s/2} \cdot \text{so}_{((s/2)^n)}^B(x_1, \dots, x_n),$$

where  $\text{so}_{((s/2)^n)}^B(x_1, \dots, x_n)$  is the irreducible character of the Lie algebra  $\mathfrak{so}_{2n+1}$  corresponding to a rectangle  $((s/2)^n) = (s/2, \dots, s/2)$ . In this viewpoint, we give several variations of the affine Gordon–Bender–Knuth identities. First we state the “symplectic” case.

**Theorem 3.1.** *Let  $h$  and  $w$  be positive integers. For a partition  $\lambda$  with length  $\leq 2h$  and  $\lambda_1 - \lambda_{2h} \leq w$ , we define*

$$(3.5) \quad c_{2h,w}^\pm(\lambda) = \begin{cases} 1 & \text{if } \lambda_{2i-1} = \lambda_{2i} \text{ for all } 1 \leq i \leq h, \\ \pm 1 & \text{if } \lambda_1 - \lambda_{2h} = w \text{ and } \lambda_{2i} = \lambda_{2i+1} \text{ for all } 1 \leq i \leq h-1, \\ 0 & \text{otherwise.} \end{cases}$$

Then we have

$$(3.6) \quad \sum_{\lambda \in \text{Par}(2h,w)} \sum_{k \in Q_{2h}^\vee} c_{2h,w}^+(\lambda) \det_{1 \leq i, j \leq 2h} (e_{\lambda_i - i + j + (2h+w)k_i}) = \det_{1 \leq i, j \leq h} (\bar{F}_{-i+j, 2h+w} - \bar{F}_{i+j, 2h+w}),$$

$$(3.7) \quad \sum_{\lambda \in \text{Par}(2h,w)} \sum_{k \in Q_{2h}^\vee} c_{2h,w}^-(\lambda) \det_{1 \leq i, j \leq 2h} (e_{\lambda_i - i + j + (2h+w)k_i}) = \det_{1 \leq i, j \leq h} (F_{-i+j, 2h+w} - F_{i+j, 2h+w}).$$

In the limit  $w \rightarrow \infty$ , Equation (3.6) gives us

$$\sum_{\substack{\lambda_1 \leq 2h \\ \lambda: \text{even}}} s_\lambda = \det_{1 \leq i, j \leq h} (f_{-i+j} - f_{i+j}),$$

where a partition  $\lambda$  is called *even* if all parts are even, and

$$\sum_{\lambda \subseteq ((2s)^n): \text{even}} s_\lambda(x_1, \dots, x_n) = (x_1 \cdots x_n)^s \cdot \text{sp}_{(s^n)}(x_1, \dots, x_n).$$

(See [28, (7.2), Corollary 7.4(b)].)

Next we state the “even orthogonal” case. We define  $\det A = 1$  for an empty matrix and

$$e = \sum_{i \geq 0} e_i, \quad \bar{e} = \sum_{i \geq 0} (-1)^i e_i.$$

**Theorem 3.2.** *For a partition  $\lambda$  of length  $\leq m$  such that  $\lambda_1 - \lambda_m \leq w$ , we define*

$$(3.8) \quad d_{m,w}^\pm(\lambda) = \begin{cases} 1 & \text{if } \lambda_1, \dots, \lambda_m \in 2\mathbb{Z}, \\ \pm 1 & \text{if } \lambda_1, \dots, \lambda_m \in 2\mathbb{Z} + 1, \\ 0 & \text{otherwise.} \end{cases}$$

For integers  $h \geq 1$  and  $w \geq 1$ , we have

$$\begin{aligned} \sum_{\lambda \in \text{Par}(2h,w)} \sum_{k \in Q_{2h}^{\vee}} d_{2h,w}^+(\lambda) \det_{1 \leq i, j \leq 2h} (e_{\lambda_i - i + j + (2h+w)k_i}) &= \frac{1}{2} \det_{1 \leq i, j \leq h} (\bar{F}_{-i+j, 2h+w} + \bar{F}_{i+j-2, 2h+w}), \\ \sum_{\lambda \in \text{Par}(2h,w)} \sum_{k \in Q_{2h}^{\vee}} d_{2h,w}^-(\lambda) \det_{1 \leq i, j \leq 2h} (e_{\lambda_i - i + j + (2h+w)k_i}) &= e \cdot \bar{e} \det_{1 \leq i, j \leq h-1} (F_{-i+j, 2h+w} - F_{i+j, 2h+w}), \\ \sum_{\lambda \in \text{Par}(2h+1,w)} \sum_{k \in Q_{2h+1}^{\vee}} d_{2h+1,w}^+(\lambda) \det_{1 \leq i, j \leq 2h+1} (e_{\lambda_i - i + j + (2h+1+w)k_i}) &= e \det_{1 \leq i, j \leq h} (F_{-i+j, 2h+1+w} - F_{i+j-1, 2h+1+w}), \\ \sum_{\lambda \in \text{Par}(2h+1,w)} \sum_{k \in Q_{2h+1}^{\vee}} d_{2h+1,w}^-(\lambda) \det_{1 \leq i, j \leq 2h+1} (e_{\lambda_i - i + j + (2h+1+w)k_i}) &= \bar{e} \det_{1 \leq i, j \leq h} (\bar{F}_{-i+j, 2h+1+w} + \bar{F}_{i+j-1, 2h+1+w}). \end{aligned}$$

In the limit  $w \rightarrow \infty$ , we obtain

$$\begin{aligned} \sum_{\substack{\lambda: \lambda_1 \leq 2h+1 \\ \lambda'_1, \dots, \lambda'_{2h+1}: \text{even}}} s_{\lambda}(\mathbf{x}) + \sum_{\substack{\lambda: \lambda_1 \leq 2h+1 \\ \lambda'_1, \dots, \lambda'_{2h+1}: \text{odd}}} s_{\lambda}(\mathbf{x}) &= \frac{1}{2} \det_{1 \leq i, j \leq h} (f_{-i+j}(\mathbf{x}) + f_{i+j-2}(\mathbf{x})), \\ \sum_{\substack{\lambda: \lambda_1 \leq 2h+1 \\ \lambda'_1, \dots, \lambda'_{2h+1}: \text{even}}} s_{\lambda}(\mathbf{x}) - \sum_{\substack{\lambda: \lambda_1 \leq 2h+1 \\ \lambda'_1, \dots, \lambda'_{2h+1}: \text{odd}}} s_{\lambda}(\mathbf{x}) &= e(\mathbf{x}) \cdot \bar{e}(\mathbf{x}) \det_{1 \leq i, j \leq h-1} (f_{-i+j}(\mathbf{x}) - f_{i+j}(\mathbf{x})), \\ \sum_{\substack{\lambda: \lambda_1 \leq 2h \\ \lambda'_1, \dots, \lambda'_{2h}: \text{even}}} s_{\lambda}(\mathbf{x}) + \sum_{\substack{\lambda: \lambda_1 \leq 2h \\ \lambda'_1, \dots, \lambda'_{2h}: \text{odd}}} s_{\lambda}(\mathbf{x}) &= e(\mathbf{x}) \det_{1 \leq i, j \leq h} (f_{-i+j}(\mathbf{x}) - f_{i+j-1}(\mathbf{x})), \\ \sum_{\substack{\lambda: \lambda_1 \leq 2h \\ \lambda'_1, \dots, \lambda'_{2h}: \text{even}}} s_{\lambda}(\mathbf{x}) - \sum_{\substack{\lambda: \lambda_1 \leq 2h \\ \lambda'_1, \dots, \lambda'_{2h}: \text{odd}}} s_{\lambda}(\mathbf{x}) &= \bar{e}(\mathbf{x}) \det_{1 \leq i, j \leq h} (f_{-i+j}(\mathbf{x}) + f_{i+j-1}(\mathbf{x})). \end{aligned}$$

If we specialize the variables of symmetric functions to  $\mathbf{x}_n = (x_1, \dots, x_n)$ , we can derive (see [25, Theorem 2.3 (3)])

$$\begin{aligned} \sum_{\substack{\lambda \subseteq ((2s)^n) \\ \lambda'_1, \dots, \lambda'_{2s}: \text{even}}} s_{\lambda}(\mathbf{x}_n) + \sum_{\substack{\lambda \subseteq ((2s)^n) \\ \lambda'_1, \dots, \lambda'_{2s}: \text{odd}}} s_{\lambda}(\mathbf{x}_n) &= (x_1 \cdots x_n)^s \left( \text{so}_{(s^n)}^+(\mathbf{x}_n) + \text{so}_{(s^n)}^-(\mathbf{x}_n) \right), \\ \sum_{\substack{\lambda \subseteq ((2s)^n) \\ \lambda'_1, \dots, \lambda'_{2s}: \text{even}}} s_{\lambda}(\mathbf{x}_n) - \sum_{\substack{\lambda \subseteq ((2s)^n) \\ \lambda'_1, \dots, \lambda'_{2s}: \text{odd}}} s_{\lambda}(\mathbf{x}_n) &= (-1)^n (x_1 \cdots x_n)^s \left( \text{so}_{(s^n)}^+(\mathbf{x}_n) - \text{so}_{(s^n)}^-(\mathbf{x}_n) \right), \end{aligned}$$

where  $s$  is a positive integer or half-integer and  $\text{so}_{(s^n)}^{\pm}(x_1, \dots, x_n)$  denotes the irreducible character of the even orthogonal Lie algebra  $\mathfrak{so}_{2n}$  with highest weight  $(s, \dots, s, \pm s)$ .

We will prove Theorems 3.1 and 3.2 in Section 5.

**3.3. Formulas on Pfaffians.** For the rest of this section we present some known results, which will be used later to prove the theorems in this section. Throughout this paper whenever a formula is given for the matrix  $A = (A_{i,j})$  in  $\text{Pf } A$  it is assumed that  $A$  is skew-symmetric and  $A_{i,j}$  is defined by the formula for  $i < j$ . For a matrix  $M$ , its transpose is denoted by  $M^t$ .

**Definition 3.3.** Let  $A = (a_{i,j})_{i \in I, j \in J}$  be a matrix and let  $R = (r_1, \dots, r_p)$  and  $S = (s_1, \dots, s_q)$  be sequences of row and column indices respectively. We define

$$A_S^R = (a_{r_i, s_j})_{1 \leq i \leq p, 1 \leq j \leq q}.$$

We also define  $(r_1, \dots, r_p) \sqcup (r'_1, \dots, r'_p) = (r_1, \dots, r_p, r'_1, \dots, r'_p)$ .

The minor summation formula of Ishikawa and Wakayama is the following.

**Theorem 3.4** ([19, Theorem 1]). *Let  $m$  and  $p$  be positive integers and  $M = (M_{i,j})_{1 \leq i \leq m, 1 \leq j \leq p}$  any  $m \times p$  matrix.*

(1) *If  $m$  is even and  $A = (a_{r,s})_{1 \leq r,s \leq p}$  is any  $p \times p$  skew-symmetric matrix, then we have*

$$\sum_K \text{Pf}(A_K^K) \det(M_K^{[m]}) = \text{Pf}(M A M^t) = \text{Pf} \left( \sum_{1 \leq i < j \leq m} \left( \sum_{r,s=1}^p a_{r,s} M_{i,r} M_{j,s} \right) \right),$$

where  $K = (k_1, \dots, k_m)$  runs over all increasing sequences  $1 \leq k_1 < \dots < k_m \leq p$  of integers and  $[m] = (1, 2, \dots, m)$ .

(2) *If  $m$  is odd and  $A = (a_{r,s})_{0 \leq r,s \leq p}$  is any  $(p+1) \times (p+1)$  skew-symmetric matrix, then we have*

$$\sum_K \text{Pf}(A_{(0) \sqcup K}^{(0) \sqcup K}) \det(M_K^{[m]}) = \text{Pf} \left( \begin{cases} \sum_{r=1}^p a_{0,r} M_{j,r} & \text{if } i = 0 \\ \sum_{r,s=1}^p a_{r,s} M_{i,r} M_{j,s} & \text{if } i > 0 \end{cases} \right),$$

where  $K = (k_1, \dots, k_m)$  runs over all increasing sequences  $1 \leq k_1 < \dots < k_m \leq p$  of integers.

We note that Theorem 3.4 is also valid in the limiting case  $p = \infty$  provided that the limits of both sides exist.

For convenience, we state the special case where  $A$  is the skew-symmetric matrix with all 1's above the diagonal. It should be noted that  $\text{Pf}_{1 \leq i < j \leq 2p}(1) = 1$  for all  $p$ .

**Corollary 3.5** ([24, Theorem 3]). *Let  $m$  and  $p$  be positive integers and  $M = (M_{i,j})_{1 \leq i \leq m, 1 \leq j \leq p}$  any  $m \times p$  matrix.*

(1) *If  $m$  is even, then we have*

$$\sum_K \det M_K^{[m]} = \text{Pf} \left( \sum_{1 \leq i < j \leq m} \left( \sum_{1 \leq r < s \leq p} (M_{i,r} M_{j,s} - M_{i,s} M_{j,r}) \right) \right),$$

where  $K = (k_1, \dots, k_m)$  runs over all increasing sequences  $1 \leq k_1 < \dots < k_m \leq p$  of integers.

(2) *If  $m$  is odd, then we have*

$$\sum_K \det M_K^{[m]} = \text{Pf} \left( \begin{cases} \sum_{1 \leq r \leq p} M_{j,r} & \text{if } i = 0 \\ \sum_{1 \leq r < s \leq p} (M_{i,r} M_{j,s} - M_{i,s} M_{j,r}) & \text{if } i > 0 \end{cases} \right),$$

where  $K = (k_1, \dots, k_m)$  runs over all increasing sequences  $1 \leq k_1 < \dots < k_m \leq p$  of integers.

The following identity between a Pfaffian and a determinant is due to Gordon [14, Lemma 1].

**Lemma 3.6** ([14, Lemma 1]). *If  $z_i$  ( $i \in \mathbb{Z}$ ) satisfy  $z_{-i} = -z_i$ , then we have*

$$(3.9) \quad \text{Pf}_{1 \leq i, j \leq 2h}(z_{j-i}) = \det_{1 \leq i, j \leq h} (z_{|j-i|+1} + z_{|j-i|+3} + z_{|j-i|+5} + \dots + z_{i+j-1}).$$

It is convenient to rewrite the determinant above into the following form. Equation (3.10) was used in the proof of [28, Theorem 7.1(a)].

**Corollary 3.7.** *If  $z_i$  ( $i \in \mathbb{Z}$ ) satisfy  $z_{-i} = -z_i$ , then we have*

$$(3.10) \quad \text{Pf}_{1 \leq i, j \leq 2h}(z_{j-i}) = \det_{1 \leq i, j \leq h} \left( \sum_{s=0}^{2 \min(i,j)-2} (-1)^s (z_{i+j-1-s} - z_{i+j-2-s}) \right)$$

$$(3.11) \quad = \det_{1 \leq i, j \leq h} \left( \sum_{s=0}^{2 \min(i,j)-2} (z_{i+j-1-s} + z_{i+j-2-s}) \right)$$



Let  $\alpha = (\alpha_1, \dots, \alpha_m) = (\beta_{t+1}, \dots, \beta_m, \beta_1, \dots, \beta_t)$ . By (4.6), we have  $\alpha \in Y$ .

Observe that  $\det(e_{\mu_i+Nk_i+j}) = \det(e_{\beta_i+j}) = \det(e_{\alpha_i+j})$  because cyclically shifting indices of an  $m \times m$  matrix does not change its determinant when  $m$  is odd. Thus to prove (4.1) it suffices to show that the map  $(\mu, k) \mapsto \alpha$  is a bijection from  $X$  to  $Y$ .

Suppose  $\alpha \in Y$ . Let  $q$  and  $t$  be the unique integers satisfying  $\sum_{i=1}^m \lfloor \alpha_i/N \rfloor = qm + t$  and  $0 \leq t < m$ . Let  $\beta = (\alpha_{m-t+1}, \dots, \alpha_m, \alpha_1, \dots, \alpha_{m-t})$ . Finally, define  $(\mu, k)$  using (4.4) and (4.5). It is easy to check that the map  $\alpha \mapsto (\mu, k)$  is the desired inverse map.  $\square$

**Lemma 4.2.** *Let  $m$  and  $N$  be positive integers such that  $m < N$  and  $m$  is even. Then*

$$\sum_{\substack{\mu_1, \dots, \mu_m \in \mathbb{Z} \\ \mu_1 > \dots > \mu_m \\ \mu_1 - \mu_m < N}} \sum_{\substack{k_1, \dots, k_m \in \mathbb{Z} \\ k_1 + \dots + k_m = 0}} \det_{1 \leq i, j \leq m} (e_{\mu_i + Nk_i + j}) = \sum_{\substack{\alpha_1, \dots, \alpha_m \in \mathbb{Z} \\ R_N(\alpha_1) > \dots > R_N(\alpha_m)}} (-1)^{\sum_{i=1}^m \lfloor \alpha_i/N \rfloor} \det_{1 \leq i, j \leq m} (e_{\alpha_i + j}).$$

*Proof.* This can be proved by the same arguments in the proof of Lemma 4.1. The only difference is that if  $(\mu, k)$  corresponds to  $\alpha$ , then  $\det(e_{\mu_i + Nk_i + j}) = \det(e_{\beta_i + j}) = (-1)^t \det(e_{\alpha_i + j})$  because cyclically shifting indices of an  $m \times m$  matrix changes the sign of its determinant when  $m$  is even. Since  $(-1)^t = (-1)^{\sum_{i=1}^m \lfloor \alpha_i/N \rfloor - qm} = (-1)^{\sum_{i=1}^m \lfloor \alpha_i/N \rfloor}$ , we obtain the desired formula.  $\square$

By Lemma 4.1 with  $m = 2h + 1$ ,  $\mu_i = \lambda_i - i$  and  $N = 2h + w + 1$ , (3.3) is restated as follows.

**Theorem 4.3.** *For nonnegative integers  $h$  and  $N$  with  $N > 2h + 1$ , we have*

$$\sum_{\substack{\alpha_1, \dots, \alpha_{2h+1} \in \mathbb{Z} \\ R_N(\alpha_1) > \dots > R_N(\alpha_{2h+1})}} \det_{1 \leq i, j \leq 2h+1} (e_{\alpha_i + j}) = \sum_{k \geq 0} e_k \det_{1 \leq i, j \leq h} (F_{-i+j, N} - F_{i+j, N}).$$

Similarly, by Lemma 4.2 with  $m = 2h$ ,  $\mu_i = \lambda_i - i$  and  $N = 2h + w$ , we can restate (3.4) as follows.

**Theorem 4.4.** *For positive integers  $h$  and  $N$  with  $N > 2h$ , we have*

$$\sum_{\substack{\alpha_1, \dots, \alpha_{2h} \in \mathbb{Z} \\ R_N(\alpha_1) > \dots > R_N(\alpha_{2h})}} (-1)^{\sum_{i=1}^{2h} \lfloor \alpha_i/N \rfloor} \det_{1 \leq i, j \leq 2h} (e_{\alpha_i + j}) = \det_{1 \leq i, j \leq h} (\bar{F}_{-i+j, N} + \bar{F}_{i+j-1, N}).$$

In the next two subsections we prove Theorems 4.3 and 4.4. Our approach is similar to that in Stembridge's proof of the Gordon–Bender–Knuth identities [28, Theorem 7.1].

**4.2. Proof of Theorem 4.3.** Let  $h$  and  $N$  be nonnegative integers satisfying  $N > 2h + 1$ . Throughout this subsection we denote  $e = \sum_{k \geq 0} e_k$  and  $E$  is the  $1 \times (2h + 1)$  matrix whose entries are all equal to  $e$ .

For two integers  $i$  and  $j$ , we define

$$d_N(i, j) = \sum_{\substack{m, n \in \mathbb{Z} \\ R_N(m-i) > R_N(n-j)}} e_m e_n - \sum_{\substack{m, n \in \mathbb{Z} \\ R_N(m-i) < R_N(n-j)}} e_m e_n.$$

By definition,  $d_N(j, i) = -d_N(i, j)$  and  $d_N(i, i) = 0$ . For a nonnegative integer  $n$ , let  $D_N(n)$  denote the  $n \times n$  skew-symmetric matrix given by

$$D_N(n) = (d_N(i, j))_{i, j=1}^n.$$

We will prove the following three identities:

$$(4.7) \quad \sum_{\substack{\alpha_1, \dots, \alpha_{2h+1} \in \mathbb{Z} \\ R_N(\alpha_1) > \dots > R_N(\alpha_{2h+1})}} \det_{1 \leq i, j \leq 2h+1} (e_{\alpha_i + j}) = \text{Pf} \begin{pmatrix} 0 & E \\ -E^t & D_N(2h+1) \end{pmatrix},$$

$$(4.8) \quad \text{Pf} \begin{pmatrix} 0 & E \\ -E^t & D_N(2h+1) \end{pmatrix} = e \text{Pf}_{1 \leq i, j \leq 2h} (F_{j-i-1, N} - F_{j-i+1, N}),$$

$$(4.9) \quad \text{Pf} \left( F_{j-i-1,N} - F_{j-i+1,N} \right) = \det \left( F_{-i+j,N} - F_{i+j,N} \right).$$

Recall that  $F_{r,N} = \sum_{k \in \mathbb{Z}} f_{r+Nk}$  (Definition 2.6).

*Proof of (4.7).* By taking the transpose we can rewrite the left-hand side of (4.7) as

$$(4.10) \quad \sum_{N > r_1 > \dots > r_{2h+1} \geq 0} \sum_{k_1, \dots, k_{2h+1} \in \mathbb{Z}} \det_{1 \leq i, j \leq 2h+1} (e_{k_j N + r_j + i}) = \sum_{1 \leq r_1 < \dots < r_{2h+1} \leq N} (-1)^{\binom{2h+1}{2}} \det_{1 \leq i, j \leq 2h+1} \left( \sum_{k \in \mathbb{Z}} e_{kN+i+r_j-1} \right).$$

Let  $M = (M_{i,j})_{1 \leq i \leq 2h+1, 1 \leq j \leq N}$  be the matrix whose  $(i, j)$  entry is  $M_{i,j} = \sum_{k \in \mathbb{Z}} e_{kN+i+j-1}$ . Note that for  $1 \leq j \leq 2h+1$ , we have  $\sum_{1 \leq r \leq N} M_{j,r} = \sum_{1 \leq r \leq N} \sum_{k \in \mathbb{Z}} e_{kN+r+j-1} = \sum_{l \in \mathbb{Z}} e_l = e$ , and for  $1 \leq i < j \leq 2h+1$ ,

$$\sum_{1 \leq r < s \leq N} (M_{i,r} M_{j,s} - M_{i,s} M_{j,r}) = \sum_{1 \leq r < s \leq N} \sum_{k, l \in \mathbb{Z}} (e_{kN+i+r-1} e_{lN+j+s-1} - e_{kN+i+s-1} e_{lN+j+r-1}) = -d_N(i, j).$$

Thus by Corollary 3.5 with  $n = 2h+1$  and  $p = N$ , the right-hand side of (4.10) equals

$$(-1)^h \text{Pf} \begin{pmatrix} 0 & E \\ -E^t & -D_N(2h+1) \end{pmatrix} = \text{Pf} \begin{pmatrix} 0 & E \\ -E^t & D_N(2h+1) \end{pmatrix},$$

as desired.  $\square$

*Proof of (4.8).* Let  $A$  be the matrix in the left-hand side of (4.8). In the matrix  $A$  subtract row/column  $i-1$  from row/column  $i$  for  $i = 2h+2, 2h+1, \dots, 2$ . Then the resulting matrix is of the form

$$\begin{pmatrix} 0 & e & 0 \\ -e & * & * \\ 0 & * & B \end{pmatrix},$$

where  $B = (B_{i,j})_{1 \leq i, j \leq 2h}$  is the matrix whose  $(i, j)$ -entry is

$$B_{i,j} = d_N(i, j) - d_N(i-1, j) - d_N(i, j-1) + d_N(i-1, j-1).$$

Since  $\text{Pf } A = e \text{ Pf } B$ , it remains to show that  $B_{i,j} = F_{j-i-1,N} - F_{j-i+1,N}$ .

We claim that

$$(4.11) \quad d_N(i, j) - d_N(i-1, j) = 2 \sum_{m, n \in \mathbb{Z}} \chi(R_N(m-i) = N-1) e_m e_n - F_{j-i,N} - F_{j-i+1,N}.$$

To prove the claim note that  $d_N(i, j) - d_N(i-1, j) = P - Q$ , where

$$\begin{aligned} P &= \sum_{m, n \in \mathbb{Z}} \left( \chi(R_N(m-i) > R_N(n-j)) - \chi(R_N(m-i+1) > R_N(n-j)) \right) e_m e_n, \\ Q &= \sum_{m, n \in \mathbb{Z}} \left( \chi(R_N(m-i) < R_N(n-j)) - \chi(R_N(m-i+1) < R_N(n-j)) \right) e_m e_n. \end{aligned}$$

One can easily check that the coefficient of  $e_m e_n$  in  $P$  is equal to

$$\begin{aligned} &\chi(R_N(m-i) = N-1 \neq R_N(n-j)) - \chi(R_N(m-i) = R_N(n-j) \neq N-1) \\ &= \chi(R_N(m-i) = N-1) - \chi(R_N(m-i) = R_N(n-j)). \end{aligned}$$

Thus

$$P = \sum_{m, n \in \mathbb{Z}} \chi(R_N(m-i) = N-1) e_m e_n - \sum_{m, n \in \mathbb{Z}} \chi(R_N(m-i) = R_N(n-j)) e_m e_n,$$

and similarly,

$$Q = \sum_{m, n \in \mathbb{Z}} \chi(R_N(m-i+1) = R_N(n-j)) e_m e_n - \sum_{m, n \in \mathbb{Z}} \chi(R_N(m-i) = N-1) e_m e_n.$$

Since

$$\sum_{m,n \in \mathbb{Z}} \chi(R_N(m-i) = R_N(n-j)) e_m e_n = \sum_{m \in \mathbb{Z}} \sum_{k \in \mathbb{Z}} e_m e_{kN+m+j-i} = \sum_{k \in \mathbb{Z}} f_{kN+j-i} = F_{j-i,N},$$

$P - Q$  is equal to the right-hand side of (4.11), and we obtain the claim.

By (4.11) we have

$$B_{i,j} = (-F_{j-i,N} - F_{j-i+1,N}) - (-F_{j-i-1,N} - F_{j-i,N}) = F_{j-i-1,N} - F_{j-i+1,N},$$

and the proof is completed.  $\square$

*Proof of (4.9).* If  $z_i = F_{i-1,N} - F_{i+1,N}$ , then

$$z_{|j-i|+1} + z_{|j-i|+3} + \cdots + z_{i+j-1} = F_{|j-i|,N} - F_{i+j,N} = F_{j-i,N} - F_{i+j,N}.$$

Thus (4.9) follows from Lemma 3.6.  $\square$

By (4.7), (4.8) and (4.9), we obtain Theorem 4.3.

**4.3. Proof of Theorem 4.4.** Let  $h$  and  $N$  be nonnegative integers satisfying  $N > 2h$ . For two integers  $i$  and  $j$ , we define

$$\bar{d}_N(i, j) = \sum_{\substack{m,n \in \mathbb{Z} \\ R_N(m-i) > R_N(n-j)}} (-1)^{\lfloor (m-i)/N \rfloor + \lfloor (n-j)/N \rfloor} e_m e_n - \sum_{\substack{m,n \in \mathbb{Z} \\ R_N(m-i) < R_N(n-j)}} (-1)^{\lfloor (m-i)/N \rfloor + \lfloor (n-j)/N \rfloor} e_m e_n.$$

By definition,  $\bar{d}_N(j, i) = -\bar{d}_N(i, j)$  and  $\bar{d}_N(i, i) = 0$ .

**Lemma 4.5.** *For any integers  $i, j \in \mathbb{Z}$  with  $i \leq j$ , we have*

$$\bar{d}_N(i, j) = \sum_{r=-j+i+1}^{j-i} \bar{F}_{r,N} = \sum_{r \in \mathbb{Z}: r \leq j-i} \bar{F}_{r,N} - \sum_{r \in \mathbb{Z}: r \leq i-j} \bar{F}_{r,N}.$$

*Proof.* If  $j = i$ , then both sides of the equation are equal to zero. Thus, by induction on  $j - i$ , it suffices to show that, for  $i < j$ , we have

$$\bar{d}_N(i, j) - \bar{d}_N(i, j-1) = \bar{F}_{-j+i+1,N} + \bar{F}_{j-i,N} = \bar{F}_{j-i-1,N} + \bar{F}_{j-i,N}.$$

Using the definition of  $\bar{d}_N(i, j)$ , we have

$$\bar{d}_N(i, j) - \bar{d}_N(i, j-1) = \sum_{m,n \in \mathbb{Z}} (-1)^{\lfloor (m-i)/N \rfloor + \lfloor (n-j)/N \rfloor} a_{m,n}(i, j) e_m e_n,$$

where

$$\begin{aligned} a_{m,n}(i, j) &= \chi(R_N(m-i) > R_N(n-j)) - \chi(R_N(m-i) < R_N(n-j)) \\ &\quad - (-1)^{\chi(R_N(n-j)=N-1)} (\chi(R_N(m-i) > R_N(n-j+1)) - \chi(R_N(m-i) < R_N(n-j+1))). \end{aligned}$$

On the other hand,

$$\begin{aligned} \bar{F}_{j-i,N} &= \sum_{k \in \mathbb{Z}} (-1)^k f_{kN+j-i} = \sum_{k \in \mathbb{Z}} (-1)^k \sum_{m \in \mathbb{Z}} e_m e_{m+kN+j-i} \\ &= \sum_{m,n \in \mathbb{Z}} (-1)^{(n-m-j+i)/N} \chi(R_N(m-i) = R_N(n-j)) e_m e_n. \end{aligned}$$

Note that if  $R_N(m-i) = R_N(n-j)$ , then

$$(-1)^{(n-m-j+i)/N} = (-1)^{(n-j)-(m-i)/N} = (-1)^{\lfloor (n-j)/N \rfloor - \lfloor (m-i)/N \rfloor} = (-1)^{\lfloor (m-i)/N \rfloor + \lfloor (n-j)/N \rfloor}.$$



Thus

$$\bar{F}_{j-i-1,N} + \bar{F}_{j-i,N} = \sum_{m,n \in \mathbb{Z}} (-1)^{\lfloor (m-i)/N \rfloor + \lfloor (n-j)/N \rfloor} b_{m,n}(i, j) e_m e_n,$$

where

$$b_{m,n}(i, j) = \chi(R_N(m-i) = R_N(n-j)) + (-1)^{\chi(R_N(n-j) = N-1)} \left( \chi(R_N(m-i) = R_N(n-j+1)) \right).$$

By considering the two cases  $R_N(n-j) = N-1$  and  $R_N(n-j) \neq N-1$  separately, one can easily check that  $a_{m,n}(i, j) = b_{m,n}(i, j)$  for all  $m, n \in \mathbb{Z}$ , which proves the lemma.  $\square$

*Proof of Theorem 4.4.* We claim that

$$(4.12) \quad \sum_{\substack{\alpha_1, \dots, \alpha_{2h} \in \mathbb{Z} \\ R_N(\alpha_1) > \dots > R_N(\alpha_{2h})}} (-1)^{\sum_{i=1}^{2h} \lfloor \alpha_i / N \rfloor} \det_{1 \leq i, j \leq 2h} (e_{\alpha_i + j}) = \text{Pf}_{1 \leq i, j \leq 2h} (\bar{d}_N(i, j)).$$

To see this we rewrite the left-hand side of (4.12) as

$$\sum_{N > r_1 > \dots > r_{2h} \geq 0} \det_{1 \leq i, j \leq 2h} \left( \sum_{k \in \mathbb{Z}} (-1)^k e_{kN + r_j + i} \right) = \sum_{1 \leq r_1 < \dots < r_{2h} \leq N} (-1)^{\binom{2h}{2}} \det_{1 \leq i, j \leq 2h} \left( \sum_{k \in \mathbb{Z}} (-1)^k e_{kN + i + r_j - 1} \right).$$

Then as in the proof of (4.7) we obtain (4.12) using Corollary 3.5 with  $n = 2h$ ,  $p = N$ , and  $M_{i,j} = \sum_{k \in \mathbb{Z}} (-1)^k e_{kN + i + j - 1}$ .

Now let  $z_i = \sum_{r \leq i} \bar{F}_{r,N} - \sum_{r \leq -i} \bar{F}_{r,N}$ . Then, by Lemma 4.5 and (3.10), we have

$$\text{Pf}_{1 \leq i, j \leq 2h} (\bar{d}_N(i, j)) = \text{Pf}_{1 \leq i, j \leq 2h} (z_{j-i}) = \det_{1 \leq i, j \leq h} \left( \sum_{s=0}^{2 \min(i,j)-2} (-1)^s (z_{i+j-1-s} - z_{i+j-2-s}) \right).$$

Using the fact  $z_k - z_{k-1} = \bar{F}_{k,N} + \bar{F}_{-k+1,N} = \bar{F}_{k,N} + \bar{F}_{k-1,N}$ , the above determinant is

$$\det_{1 \leq i, j \leq h} (\bar{F}_{j-i,N} + \bar{F}_{i+j-1,N}).$$

This is in agreement with Theorem 4.4.  $\square$

## 5. A SYSTEMATIC APPROACH TO THE AFFINE GORDON–BENDER–KNUTH IDENTITIES

In this section we give another proof of the affine Gordon–Bender–Knuth identities by developing a general method which converts a sum of determinants into a Pfaffian. Using this approach we also prove the variations of the affine Gordon–Bender–Knuth identities.

**5.1. General framework.** Recall that, for positive integers  $m$  and  $w$ , we denote by  $\text{Par}(m, w)$  the set of partitions of length at most  $m$  satisfying  $\lambda_1 - \lambda_m \leq w$ . In this subsection, we consider a summation of the form

$$\sum_{\lambda \in \text{Par}(m, w)} \sum_{\substack{k_1, \dots, k_m \in \mathbb{Z} \\ k_1 + \dots + k_m = 0}} u(\lambda) \det_{1 \leq i, j \leq m} (e_{\lambda_i - i + j + Nk_i}),$$

where  $N = m + w$  and  $u$  is a statistic on  $\text{Par}(m, w)$ , and give a Pfaffian formula for the summation under certain conditions.

Let  $\text{Par}(m)$  be the set of partitions of length at most  $m$ . To such a partition  $\lambda$ , we associate the sequence  $I_m(\lambda)$  given by

$$I_m(\lambda) = (\lambda_m + 1, \lambda_{m-1} + 2, \dots, \lambda_1 + m).$$

Then the correspondence  $\lambda \mapsto I_m(\lambda) = (i_1, \dots, i_m)$  gives a bijection from  $\text{Par}(m)$  to the set of increasing sequences of positive integers of length  $m$ , and  $\lambda \in \text{Par}(m, w)$  if and only if  $i_1 < \dots < i_m < i_1 + N$ .

Recall the notation in Definition 3.3. For brevity we also define  $A^K := A_K^K$ . Recall that  $R_N(t)$  is the remainder of  $t$  when divided by  $N$  so that  $0 \leq R_N(t) \leq N - 1$ .

**Proposition 5.1.** *Let  $m$  and  $w$  be positive integers and put  $N = m + w$ . Let  $u : \text{Par}(m, w) \rightarrow \mathbb{Z}$  be a statistic on  $\text{Par}(m, w)$ . Let  $p$  be a nonnegative integer such that  $p + m$  is even. Suppose that  $A$  is a skew-symmetric matrix with rows/columns indexed by the totally ordered set  $\{0_1 < 0_2 < \cdots < 0_p < 1 < 2 < \cdots\}$  satisfying the following three conditions:*

(i) *For  $\lambda \in \text{Par}(m, w)$ , we have*

$$\text{Pf } A^{I_0 \sqcup I_m(\lambda)} = u(\lambda),$$

where  $I_0 = (0_1, 0_2, \dots, 0_p)$ .

(ii) *For an increasing sequence  $(i_1, \dots, i_m)$  of positive integers such that  $i_m - i_1 > N$ , we have*

$$\text{Pf } A^{I_0 \sqcup (i_1 + N, i_2, \dots, i_{m-1}, i_m - N)} = \text{Pf } A^{I_0 \sqcup (i_1, i_2, \dots, i_m)}.$$

(iii) *For an increasing sequence  $(i_1, \dots, i_m)$  of positive integers such that  $i_k \equiv i_l \pmod{N}$  for some  $k < l$ , we have*

$$\text{Pf } A^{I_0 \sqcup (i_1, \dots, i_m)} = 0.$$

Then we have

$$\sum_{\lambda \in \text{Par}(m, w)} \sum_{\substack{k_1, \dots, k_m \in \mathbb{Z} \\ k_1 + \dots + k_m = 0}} u(\lambda) \det_{1 \leq i, j \leq m} (e_{\lambda_i - i + j + Nk_i}) = \text{Pf}(T_p A T_p^t),$$

where  $T_p$  is the following matrix with rows indexed by  $\{0_1, \dots, 0_p, 1, 2, \dots, m\}$  and columns indexed by  $\{0_1, \dots, 0_p, 1, 2, \dots\}$ :

$$(5.1) \quad T_p = \begin{pmatrix} \mathbf{I}_p & O \\ O & (e_{j-i})_{1 \leq i \leq m, j \geq 1} \end{pmatrix}.$$

Here  $\mathbf{I}_p$  stands for the identity matrix of size  $p$ .

In order to prove this proposition, we use the affine symmetric group  $\widetilde{\mathfrak{S}}_m$  and its dot action on  $V = \mathbb{R}^m$ . Recall the notation in Section 3.1. We put

$$\begin{aligned} M &= \{\lambda \in V : \langle \lambda + \delta, \alpha \rangle \notin N\mathbb{Z} \text{ for all } \alpha \in \Phi^+\}, \\ A &= \{\lambda \in V : 0 < \langle \lambda + \delta, \alpha \rangle < N \text{ for all } \alpha \in \Phi^+\}. \end{aligned}$$

Note that the fundamental alcove  $A$  satisfies  $A \cap \mathbb{Z}_{\geq 0}^m = \text{Par}(m, w)$ . It is known [18, Proposition 4.3] that for any  $\mu \in M$ , there exist unique  $\tilde{\sigma} = (\sigma, k) \in \widetilde{\mathfrak{S}}_m$  and  $\lambda \in A$  such that  $\mu = \tilde{\sigma} \cdot \lambda = \sigma(\lambda + Nk + \delta) - \delta$ .

**Lemma 5.2.** *Let  $m$  and  $w$  be positive integers and let  $N = m + w$ . There is a bijection  $\Phi$  from*

$$X = \{(\lambda, k) \in \text{Par}(m, w) \times \mathcal{Q}_m^\vee : \lambda_i + m - i + Nk_i \geq 0 \text{ for all } i\}$$

to

$$Y = \{\mu \in \text{Par}(m) : R_N(\mu_i + m - i), 1 \leq i \leq m, \text{ are distinct}\}$$

such that, if  $\Phi(\lambda, k) = \mu$ , then

$$\det_{1 \leq i, j \leq m} (e_{\lambda_i - i + j + Nk_i}) = \text{sgn}(\tilde{\sigma}) \det_{1 \leq i, j \leq m} (e_{\mu_i - i + j}),$$

where  $\tilde{\sigma} = (\sigma, k) \in \widetilde{\mathfrak{S}}_m$  is the unique element satisfying  $\tilde{\sigma} \cdot \mu \in A$ .

*Proof.* Let  $(\lambda, k) \in X$ . Since  $\lambda_i + m - i + Nk_i \geq 0$  for all  $1 \leq i \leq m$ , there is a unique partition  $\mu \in \text{Par}(m)$  such that  $\mu = \sigma \cdot (\lambda + Nk) = (\sigma, k) \cdot \lambda$  for some permutation  $\sigma \in \mathfrak{S}_m$ . We define  $\Phi(\lambda, k) = \mu$ . Observe that  $R_N(\lambda_i + m - i + Nk_i) = R_N(\lambda_i + m - i)$ ,  $1 \leq i \leq m$ , are all distinct because  $\lambda \in \text{Par}(m, w)$  implies that  $0 < \lambda_i + m - i - (\lambda_j + m - j) \leq \lambda_1 + m - 1 - \lambda_m < N$  for  $1 \leq i < j \leq m$ . Hence,  $R_N(\mu_i + m - i)$ ,  $1 \leq i \leq m$ , are also distinct and we obtain that  $\Phi$  is a map from  $X$  to  $Y$ . Moreover, since  $\mu + \delta = \sigma(\lambda + Nk + \delta)$ , we have  $\det(e_{\lambda_i - i + j + Nk_i}) = \text{sgn}(\sigma) \det(e_{\mu_i - i + j})$ .

It remains to show that  $\Phi$  is bijective. To do this we construct its inverse. Let  $\mu \in Y$ . Since  $\mu \in Y \subseteq M$ , we see that  $\mu$  is uniquely expressed as  $\mu = \tilde{\sigma} \cdot \lambda = \sigma \cdot (\lambda + Nk)$  with  $\tilde{\sigma} = (\sigma, k) \in \tilde{\mathfrak{S}}_m$  and  $\lambda \in A$ . We define  $\Psi(\mu) = (\lambda, k)$  and claim that  $(\lambda, k) \in X$ . By the constructions of the maps  $\Phi$  and  $\Psi$ , the claim implies  $\Psi = \Phi^{-1}$ . Since  $\mu$  is a partition and  $\lambda + Nk + \delta$  is a rearrangement of  $\mu + \delta$ , we have  $\lambda_i + m - i + Nk_i \geq 0$  for all  $1 \leq i \leq m$ . Moreover, since  $\lambda \in A$ , we have  $\lambda_1 - \lambda_m \leq w$ . Thus to prove the claim it suffices to show that  $\lambda$  is a partition. Since  $\lambda$  is an increasing sequence, it suffices to show that  $\lambda_m \geq 0$ . Assume  $\lambda_m < 0$  to the contrary. Combining  $\lambda_m < 0$  and  $\lambda_m + Nk_m \geq 0$  (the inequality  $\lambda_i + m - i + Nk_i \geq 0$  for  $i = m$ ), we obtain  $k_m \geq 1$ . Now it follows from  $\sum_{i=1}^m k_i = 0$  that there exists an index  $j$  such that  $k_j \leq -1$ . Since  $\lambda \in A$ , we have  $\langle \lambda + \delta, \varepsilon_1 - \varepsilon_m \rangle = \lambda_1 + m - 1 - \lambda_m < N$ . Thus, by using  $\lambda_m < 0$ , we have  $\lambda_j + m - j \leq \lambda_1 + m - 1 < \lambda_m + N < N$ . This implies  $\lambda_j + m - j + Nk_j < 0$ , which is a contradiction. Hence  $\lambda$  is a partition and the proof completes.  $\square$

We use the above lemma to prove Proposition 5.1.

*Proof of Proposition 5.1.* We extend the statistic  $u$  on  $\text{Par}(m, w)$  to  $\tilde{u} : \text{Par}(m) \rightarrow \mathbb{Z}$  by

$$\tilde{u}(\mu) = \begin{cases} \text{sgn}(\tilde{\sigma})u(\lambda) & \text{if } \mu \in Y, \\ 0 & \text{otherwise,} \end{cases}$$

where  $Y$  is the subset of  $\text{Par}(m)$  given in Lemma 5.2 and  $\tilde{\sigma} \in \tilde{\mathfrak{S}}_m$  and  $\lambda \in \text{Par}(m, w)$  are determined by  $\mu = \tilde{\sigma} \cdot \lambda$ . Then it follows from Lemma 5.2 that

$$(5.2) \quad \sum_{\lambda \in \text{Par}(m, w)} \sum_{k \in Q_m^v} u(\lambda) \det(e_{\lambda_i - i + j + Nk_i}) = \sum_{\mu \in \text{Par}(m)} \tilde{u}(\mu) \det(e_{\mu_i - i + j}).$$

We shall show that, for all  $\mu \in \text{Par}(m)$ ,

$$(5.3) \quad \tilde{u}(\mu) = \text{Pf } A^{I_0 \sqcup I_m(\mu)}.$$

We write  $I_m(\mu) = (i_1, \dots, i_m)$ . If  $\mu \notin Y$ , then  $i_p \equiv i_q \pmod{N}$  for some  $p < q$ , hence Condition (iii) implies  $\text{Pf } A^{I_0 \sqcup I_m(\mu)} = 0 = \tilde{u}(\mu)$ . We assume  $\mu \in Y$  and proceed by induction on  $i_m - i_1$ . If  $i_m - i_1 < N$ , then  $\mu \in A$  and  $\tilde{u}(\mu) = u(\mu)$ . So by Condition (i), we obtain  $\text{Pf } A^{I_0 \sqcup I_m(\mu)} = \tilde{u}(\mu)$ .

Suppose that  $i_m - i_1 > N$ . Let  $(j_1, \dots, j_m)$  be the rearrangement of  $(i_1 + N, i_2, \dots, i_{m-1}, i_m - N)$  in increasing order and  $\tau \in \mathfrak{S}_m$  the permutation achieving this rearrangement. Let  $\nu$  be the partition such that  $I_m(\nu) = (j_1, \dots, j_m)$ . Then  $\nu = (\tau, -\theta) \cdot \mu$ , where  $\theta = \varepsilon_1 - \varepsilon_m$ . By using Condition (ii) and the alternating property of Pfaffian, we have  $\text{Pf } A^{I_0 \sqcup I_m(\mu)} = \text{sgn}(\tau) \text{Pf } A^{I_0 \sqcup I_m(\nu)}$ . Since  $j_1 = \min\{i_1 + N, i_2, i_m - N\} > i_1$  and  $j_m = \max\{i_1 + N, i_{m-1}, i_m - N\} < i_m$ , we see  $j_m - j_1 < i_m - i_1$ . By applying the induction hypothesis to  $\nu$ , we have  $\text{Pf } A^{I_0 \sqcup I_m(\nu)} = \text{sgn}(\tilde{\rho})u(\lambda)$ , where  $\lambda \in A$  and  $\nu = \tilde{\rho} \cdot \lambda$ . On the other hand, since  $\mu = (\tau, -\theta)^{-1} \cdot \nu = (\tau^{-1}, \theta) \cdot (\tilde{\rho} \cdot \lambda) = ((\tau^{-1}, \theta)\tilde{\rho}) \cdot \lambda$ , we have  $\tilde{u}(\mu) = \text{sgn}(\tau^{-1}) \text{sgn}(\tilde{\rho})u(\lambda)$ , or equivalently  $\text{sgn}(\tilde{\rho})u(\lambda) = \text{sgn}(\tau)\tilde{u}(\mu)$ . Combining these we obtain

$$\text{Pf } A^{I_0 \sqcup I_m(\mu)} = \text{sgn}(\tau) \text{Pf } A^{I_0 \sqcup I_m(\nu)} = \text{sgn}(\tau) \text{sgn}(\tilde{\rho})u(\lambda) = \text{sgn}(\tau) \text{sgn}(\tau)\tilde{u}(\mu) = \tilde{u}(\mu),$$

which completes the proof of (5.3).

Now, by (5.2) and (5.3), we have

$$\sum_{\lambda \in \text{Par}(m, w)} \sum_{k \in Q_m^v} u(\lambda) \det(e_{\lambda_i - i + j + Nk_i}) = \sum_{\mu \in \text{Par}(m)} \text{Pf } A^{I_0 \sqcup I_m(\mu)} \det(e_{\mu_i - i + j}).$$

For an increasing subsequence  $K$  of  $I_0 \sqcup (1, 2, \dots)$  of length  $p + m$ , we have

$$\det(T_p)_K^{[m]} = \begin{cases} \det_{1 \leq i, j \leq m} (e_{\mu_i - i + j}) & \text{if } K = I_0 \sqcup I_m(\mu) \text{ for some } \mu \in \text{Par}(m), \\ 0 & \text{otherwise.} \end{cases}$$

Hence we have

$$\sum_{\lambda \in \text{Par}(m, w)} \sum_{k \in Q_m^{\vee}} u(\lambda) \det_{1 \leq i, j \leq m} (e_{\lambda_i - i + j + Nk_i}) = \sum_K \text{Pf } A_K^K \det(T_p)_K^{[m]},$$

where  $K$  runs over all increasing subsequences of  $I_0 \sqcup (1, 2, \dots)$  of length  $p + m$ . The desired result follows from the minor-summation formula (Theorem 3.4).  $\square$

**5.2. Proof of the affine Gordon–Bender–Knuth identities.** We apply Proposition 5.1 to prove Theorem 1.5. We introduce a skew-symmetric matrix  $A$  that satisfies the conditions in Proposition 5.1 for the statistic  $b$  on  $\text{Par}(m, w)$  defined by  $b(\lambda) = 1$  for any  $\lambda \in \text{Par}(m, w)$ .

**Lemma 5.3.** *Let  $m$  and  $w$  be positive integers and put  $N = m + w$ .*

(1) *Suppose that  $m = 2h + 1$  is odd. Let  $\beta_p$  ( $p \in \mathbb{Z}$ ) be the sequence defined by*

$$\beta_p = \begin{cases} 2k + 1 & \text{if } p = kN + r, \text{ where } k, r \in \mathbb{Z} \text{ and } 0 < r < N, \\ 2k & \text{if } p = kN, \text{ where } k \in \mathbb{Z}, \end{cases}$$

*and  $B = (B_{r,s})$  the skew-symmetric matrix with rows/columns indexed by nonnegative integers whose  $(r, s)$  entry,  $0 \leq r < s$ , is given by*

$$B_{r,s} = \begin{cases} 1 & \text{if } r = 0, \\ \beta_{s-r} & \text{if } r \geq 1. \end{cases}$$

*Then  $B$  satisfies the three conditions in Proposition 5.1 for the statistic  $b$  and  $p = 1$ .*

(2) *Suppose that  $m = 2h$  is even. Let  $\bar{\beta}_p$  ( $p \in \mathbb{Z}$ ) be the sequence defined by*

$$\bar{\beta}_p = \begin{cases} (-1)^k & \text{if } p = kN + r, \text{ where } k, r \in \mathbb{Z} \text{ and } 0 < r < N, \\ 0 & \text{if } p = kN, \text{ where } k \in \mathbb{Z}, \end{cases}$$

*and  $\bar{B} = (\bar{B}_{r,s})$  the skew-symmetric matrix with rows/columns indexed by positive integers whose  $(r, s)$  entry is given by  $\bar{B}_{r,s} = \bar{\beta}_{s-r}$ . Then  $\bar{B}$  satisfies the three conditions in Proposition 5.1 for the statistic  $b$  with  $p = 0$ .*

*Proof.* Let  $I = (i_1, \dots, i_m)$  be an increasing sequence of positive integers.

(1) For the first condition (i) of Proposition 5.1 it suffices to show that if  $i_m - i_1 < N$ , then  $\text{Pf } B^{(0) \sqcup I} = 1$ . Since  $i_m - i_1 < L$  implies that  $0 < i_l - i_k < N$  for any  $0 \leq k < l \leq m$ , where  $i_i = 0$ , we see that  $B^{(0) \sqcup I}$  is the skew-symmetric matrix with all 1's above the diagonal. So we have  $\text{Pf } B^{(0) \sqcup I} = 1$ . For the second condition (ii) suppose that  $i_m - i_1 > N$  and let  $J = (i_1 + N, i_2, \dots, i_{m-1}, i_m - N)$ . By noting  $\beta_{p+N} = \beta_p + 2$ , we have

$$B_{r+N,s} = B_{r,s} - 2, \quad B_{r+N,s-N} = B_{r,s} - 4, \quad B_{r,s-N} = B_{r,s} - 2.$$

Hence, the matrix  $B^{(0) \sqcup J}$  is obtained from  $B^{(0) \sqcup I}$  by adding the 0-th row/column multiplied by  $-2$  to the first row/column and adding the 0-th row/column multiplied by  $2$  to the  $n$ -th row/column, and we have  $\text{Pf } B^{(0) \sqcup J} = \text{Pf } B^{(0) \sqcup I}$ . For the third condition (iii) suppose  $i_l - i_k = cN$ . Since  $B_{r+cN,s} = B_{r,s} - 2c$ , we see that the 0-th,  $k$ -th and  $l$ -th rows of  $B^{(0) \sqcup J}$  are linearly dependent, so we have  $\text{Pf } B^{(0) \sqcup J} = 0$ .

(2) The first condition (i) can be proved similarly as in (1). For (ii) suppose  $i_m - i_1 > N$  and  $J = (i_1 + N, i_2, \dots, i_{m-1}, i_m - N)$ . Since  $\bar{\beta}_{p+N} = -\bar{\beta}_p$ , we have

$$\bar{B}_{r+N,s} = -\bar{B}_{r,s}, \quad \bar{B}_{r+N,s-N} = \bar{B}_{r,s}, \quad \bar{B}_{r,s-N} = -\bar{B}_{r,s}.$$

Hence, by multiplying the first row/column of  $\bar{B}^J$  by  $-1$  and the  $m$ -th row/column by  $-1$ , we obtain  $\text{Pf } \bar{B}^J = (-1)^2 \text{Pf } \bar{B}^I = \text{Pf } \bar{B}^I$ . For the last condition (iii), suppose  $i_l - i_k = cN$ . Since  $\bar{B}_{r+cN,s} = (-1)^c \bar{B}_{r,s}$ , we see that the  $k$ -th and  $l$ -th rows of  $\bar{B}^I$  are proportional to each other, hence we have  $\text{Pf } \bar{B}^I = 0$ .  $\square$

Now by applying Proposition 5.1 to the skew-symmetric matrices introduced in Lemma 5.3 and then by using Gordon-type identities (3.10) and (3.9), we can complete the proof of Theorem 1.5.

*Proof of Theorem 1.5.* First we prove (3.4) (the even case  $m = 2h$ ). By applying Proposition 5.1 to the statistic  $b(\lambda) = 1$  ( $\lambda \in \text{Par}(m, w)$ ) and the skew-symmetric matrix  $\bar{B}$  given in Lemma 5.3 (2), we have

$$\sum_{\lambda \in \text{Par}(2h, w)} \sum_{k \in Q_{2h}^y} \det_{1 \leq i, j \leq 2h} (e_{\lambda_i - i + j + Nk_i}) = \text{Pf} (T_0 \bar{B} T_0^t),$$

where  $T_0 = (e_{j-i})_{1 \leq i \leq m, j \geq 1}$  as given in (5.1). The  $(i, j)$  entry of  $T_0 \bar{B} T_0^t$  equals

$$\sum_{r, s \geq 1} e_{r-i} \bar{\beta}_{s-r} e_{s-j} = \sum_{p \in \mathbb{Z}} \bar{\beta}_p f_{p-j+i}.$$

If we put  $z_r = \sum_{p \in \mathbb{Z}} \bar{\beta}_p f_{p-r}$ , then we have

$$\sum_{\lambda \in \text{Par}(2h, w)} \sum_{k \in Q_{2h}^y} \det_{1 \leq i, j \leq m} (e_{\lambda_i - i + j + Nk_i}) = \text{Pf} (z_{j-i}) = \det_{1 \leq i, j \leq h} \left( \sum_{s=0}^{2 \min(i, j) - 2} (-1)^s (z_{i+j-1-s} - z_{i+j-2-s}) \right),$$

where the last equality follows from (3.10). Since we have

$$\bar{\beta}_p - \bar{\beta}_{p-1} = \begin{cases} (-1)^k & \text{if } p = Nk \text{ or } Nk + 1, \\ 0 & \text{otherwise,} \end{cases}$$

we obtain

$$(5.4) \quad z_r - z_{r-1} = \sum_{p \in \mathbb{Z}} (\bar{\beta}_p - \bar{\beta}_{p-1}) f_{p-r} = \sum_{k \in \mathbb{Z}} (-1)^k (f_{kN-r} + f_{kN+1-r}) = \bar{F}_{-r, N} + \bar{F}_{1-r, N} = \bar{F}_{r, N} + \bar{F}_{r-1, N}.$$

Thus

$$\sum_{s=0}^{2 \min(i, j) - 2} (-1)^s (z_{i+j-1-s} - z_{i+j-2-s}) = \bar{F}_{i+j-1, N} + \bar{F}_{|i-j|, N} = \bar{F}_{i+j-1, N} + \bar{F}_{j-i, N}.$$

This completes the proof of (3.4).

Next we prove (3.3) (the odd case  $m = 2h + 1$ ). By applying Proposition 5.1 to the skew-symmetric matrix  $B$  given in Lemma 5.3 (1), we have

$$\sum_{\lambda \in \text{Par}(2h+1, w)} \sum_{k \in Q_{2h+1}^y} \det_{1 \leq i, j \leq 2h+1} (e_{\lambda_i - i + j + Nk_i}) = \text{Pf} (T_1 B T_1^t),$$

where  $T_1$  is given in (5.1). If we put  $e = \sum_{i \geq 0} e_i$  and  $w_r = \sum_{p \in \mathbb{Z}} \beta_p f_{p-r}$ , then the  $(i, j)$  entry  $Q_{i, j}$ ,  $0 \leq i < j \leq m$ , of  $T_1 B T_1^t$  is given by

$$Q_{i, j} = \begin{cases} e & \text{if } i = 0, \\ w_{j-i} & \text{if } i \geq 1. \end{cases}$$

By subtracting row/column  $i - 1$  from row/column  $i$  for  $i = m, m - 1, \dots, 2$ , and then expanding the resulting Pfaffian along row/column 0, we obtain

$$\text{Pf} (T_1 B T_1^t) = e \cdot \text{Pf}_{2 \leq i < j \leq n} (w_{j-i} - w_{j-i-1} - w_{j-i+1} + w_{j-i}).$$

Since we have

$$\beta_p - \beta_{p-1} = \begin{cases} 1 & \text{if } R_N(p) = 0 \text{ or } 1, \\ 0 & \text{otherwise,} \end{cases}$$

by a similar computation as in (5.4) we have  $w_r - w_{r-1} = F_{r,N} + F_{r-1,N}$  and  $w_r - w_{r-1} - w_{r+1} + w_r = F_{r-1,N} - F_{r+1,N}$ . Now, by applying (3.9) with  $z_r = F_{r-1} - F_{r+1}$ , we complete the proof of (3.3).  $\square$

**5.3. Proof of variations of affine Gordon–Bender–Knuth identities.** In this subsection we prove the variations of affine Gordon–Bender–Knuth identities in Theorems 3.1 and 3.2. The idea of the proof is the same as that of Theorem 1.5, so we shall only provide a sketch.

First we prove the symplectic version (Theorem 3.1). The following lemma gives a skew-symmetric matrix that satisfies the conditions in Proposition 5.1 for the statistic  $c_{2h,w}^\pm$  given by (3.5).

**Lemma 5.4.** *Let  $m = 2h$  be a positive even integer and  $w$  a positive integer, and put  $N = 2h + w$ . We define the sequences  $\gamma_p^+$  and  $\gamma_p^-$  ( $p \in \mathbb{Z}$ ) by*

$$\gamma_p^+ = \begin{cases} (-1)^k & \text{if } p = kN + 1 \text{ or } kN + (N - 1), \text{ where } k \in \mathbb{Z}, \\ 0 & \text{otherwise,} \end{cases}$$

$$\gamma_p^- = \begin{cases} 1 & \text{if } p = kN + 1, \text{ where } k \in \mathbb{Z}, \\ -1 & \text{if } p = kN + (N - 1), \text{ where } k \in \mathbb{Z}, \\ 0 & \text{otherwise.} \end{cases}$$

Let  $C^+ = (C_{r,s}^+)$  (resp.  $C^- = (C_{r,s}^-)$ ) be the skew-symmetric matrix with row/columns indexed by positive integers whose  $(r, s)$  entry,  $r < s$ , is given by  $C_{r,s}^+ = \gamma_{s-r}^+$  (resp.  $C_{r,s}^- = \gamma_{s-r}^-$ ). Then the matrix  $C^+$  (resp.  $C^-$ ) satisfies the conditions in Proposition 5.1 for the statistic  $c_{m,w}^+$  (resp.  $c_{m,w}^-$ ) with  $p = 0$ .

*Proof.* We only prove the first part  $\text{Pf}(C^\pm)^{I_m(\lambda)} = c_{m,w}^\pm(\lambda)$  for  $\lambda \in \text{Par}(m, w)$ . (Since  $\gamma_{p+N}^+ = -\gamma_p^+$  and  $\gamma_{p+N}^- = \gamma_p^-$ , the other parts can be proved in exactly the same way as in the proof of Lemma 5.3 (1).)

Let  $M^\pm = (m_{i,j}^\pm)_{1 \leq i, j \leq N}$  be the skew-symmetric matrix with entries given by

$$m_{i,j}^\pm = \begin{cases} 1 & \text{if } j = i + 1, \\ \pm 1 & \text{if } i = 1 \text{ and } j = N, \\ 0 & \text{otherwise.} \end{cases}$$

Then we have  $(C^\pm)^{I_m(\lambda)} = (M^\pm)^{I_m(\lambda^0)}$ , where  $\lambda^0 = (\lambda_1 - \lambda_m, \lambda_2 - \lambda_m, \dots, \lambda_{m-1} - \lambda_m, 0)$ . By using [25, Lemma 3.4 (3)], we obtain  $\text{Pf}(C^\pm)^{I_m(\lambda)} = c_{m,w}^\pm(\lambda)$ .  $\square$

*Proof of Theorem 3.1.* By Proposition 5.1 and Lemma 5.4 with  $m = 2h$  and  $N = 2h + w$ , we obtain

$$\sum_{\lambda \in \text{Par}(2h, w)} \sum_{k \in Q_{2h}^v} c_{m,w}^\pm(\lambda) \det_{1 \leq i, j \leq 2h} (e_{\lambda_i - i + j + Nk_i}) = \text{Pf}(T_0 C^\pm T_0^t) = \text{Pf}(v_{j-i}^\pm),$$

where  $v_r^+ = \overline{F}_{r-1, N} - \overline{F}_{r+1, N}$  and  $v_r^- = F_{r-1, N} - F_{r+1, N}$ . Then the proof is completed by applying (3.9).  $\square$

We turn to the proof of Theorem 3.2. Recall that the statistics  $d_{m,w}^+$  and  $d_{m,w}^-$  on  $\text{Par}(m, w)$  (see (3.8)) are given by

$$d_{m,w}^\pm(\lambda) = \begin{cases} 1 & \text{if } \lambda \text{ is even,} \\ \pm 1 & \text{if } \lambda \text{ is odd,} \\ 0 & \text{otherwise,} \end{cases}$$

where a partition is called *even* (resp. *odd*) if all its parts  $\lambda_1, \dots, \lambda_m$  are even (resp. odd).

**Lemma 5.5.** *Let  $m$  be a positive integer and  $w$  a positive even integer, and put  $N = m + w$ .*

- (1) *Suppose that  $m = 2h$  is even and define a sequence  $\delta_p^+$  ( $p \in \mathbb{Z}$ ) by*

$$\delta_p^+ = \begin{cases} (-1)^k & \text{if } p \text{ is odd and } p = kN + r, \text{ where } k, r \in \mathbb{Z} \text{ and } 0 < r < N, \\ 0 & \text{if } p \text{ is even.} \end{cases}$$

*Let  $D^+ = (D_{r,s}^+)$  be the skew-symmetric matrix with rows/columns indexed by  $\{1, 2, \dots\}$  whose  $(r, s)$  entry is given by  $D_{r,s}^+ = \delta_{s-r}^+$ . Then  $D^+$  satisfies the conditions ( $p = 0$ ) of Proposition 5.1 for the statistic  $2^{h-1} \cdot d_{2h,w}^+$ .*

- (2) *Suppose that  $m = 2h$  is even and define a sequence  $\delta_p^-$  ( $p \in \mathbb{Z}$ ) by*

$$\delta_p^- = \begin{cases} 2k + 1 & \text{if } p \text{ is odd and } p = kN + r, \text{ where } k, r \in \mathbb{Z} \text{ and } 0 < r < N, \\ 0 & \text{if } p \text{ is even.} \end{cases}$$

*Let  $D^- = (D_{r,s}^-)$  be the skew-symmetric matrix with rows/columns indexed by  $\{0, 0', 1, 2, \dots\}$  whose entries are given by*

$$D_{0,0'}^- = 0, \quad D_{0,s}^- = 1, \quad D_{0',s}^- = (-1)^{s-1}, \quad D_{r,s}^- = \delta_{s-r}^-,$$

*where  $r, s \geq 1$ . Then  $D^-$  satisfies the conditions ( $p = 2$ ) of Proposition 5.1 for the statistic  $2^h \cdot d_{2h,w}^-$ .*

- (3) *Suppose that  $m = 2h + 1$  is odd and define a sequence  $\delta_p^+$  ( $p \in \mathbb{Z}$ ) by*

$$\delta_p^+ = \begin{cases} kN' + \lceil r/2 \rceil & \text{if } p = kN + r, \text{ where } k, r \in \mathbb{Z} \text{ and } 0 < r < N, \\ kN' & \text{if } p = kN, \text{ where } k \in \mathbb{Z}, \end{cases}$$

*where  $N' = (N + 1)/2$  and  $\lceil x \rceil$  is the smallest integer greater than or equal to  $x$ . Let  $D^+ = (D_{r,s}^+)$  be the skew-symmetric matrix with row/columns indexed by  $\{0, 1, 2, \dots\}$  whose entries are given by*

$$D_{0,s}^+ = 1, \quad D_{r,s}^+ = \delta_{s-r}^+,$$

*where  $r, s \geq 1$ . Then  $D^+$  satisfies the conditions ( $p = 1$ ) of Proposition 5.1 for the statistic  $d_{2h+1,w}^+$ .*

- (4) *Suppose that  $m = 2h + 1$  is odd and define a sequence  $\delta_p^-$  ( $p \in \mathbb{Z}$ ) by*

$$\delta_p^- = (-1)^{p+1} \delta_p^+ = \begin{cases} (-1)^{p+1} (kN' + \lceil r/2 \rceil) & \text{if } p = kN + r, \text{ where } k, r \in \mathbb{Z} \text{ and } 0 < r < N, \\ (-1)^{p+1} kN' & \text{if } p = kN, \text{ where } k \in \mathbb{Z}. \end{cases}$$

*Let  $D^- = (D_{r,s}^-)$  be the skew-symmetric matrix with row/columns indexed by  $\{0, 1, 2, \dots\}$  whose entries are given by*

$$D_{0,s}^- = (-1)^{s-1}, \quad D_{r,s}^- = \delta_{s-r}^-,$$

*where  $r, s \geq 1$ . Then  $D^-$  satisfies the conditions ( $p = 1$ ) of Proposition 5.1 for the statistic  $d_{2h+1,w}^-$ .*

For example, if  $N = 7$ , then the sequences  $\delta^+$  and  $\delta^-$  defined in (3) and (4) are as follows:

$p$	$\dots$	-9	-8	-7	-6	-5	-4	-3	-2	-1	0	1	2	3	4	5	6	7	8	9	10	$\dots$
$\delta_p^+$	$\dots$	-5	-5	-4	-3	-3	-2	-2	-1	-1	0	1	1	2	2	3	3	4	5	5	6	$\dots$
$\delta_p^-$	$\dots$	-5	5	-4	3	-3	2	-2	1	-1	0	1	-1	2	-2	3	-3	4	-5	5	-6	$\dots$

*Proof.* (1) We only show that  $\text{Pf}(D^+)^{I_m(\lambda)} = d_{m,w}^+(\lambda)$  if  $\lambda \in \text{Par}(m, w)$ . (Since  $\delta_{p+N}^+ = -\delta_p^+$ , the proof of the other parts is the same as Lemma 5.3 (1).) If  $\lambda$  is neither even nor odd, then there is an index  $k$  such that  $i_k \equiv i_{k+1} \pmod{2}$ , where  $I_m(\lambda) = (i_1, \dots, i_m)$ . We can see that the  $k$ -th row of  $D_{I_m(\lambda)}^+$  is the same as the  $(k+1)$ -st row, hence we have  $\text{Pf}(D^+)^{I_m(\lambda)} = 0$ . If  $\lambda$  is even or odd, then the  $(i, j)$  entry,  $i < j$ , of  $(D^+)^{I_m(\lambda)}$  is equal to 1 if  $j - i \equiv 1 \pmod{2}$  and 0 otherwise. By performing elementary row/column operations and using the expansion of Pfaffian, we obtain  $\text{Pf}(D^+)^{I_m(\lambda)} = 2^{m/2-1}$ .

(2) The first condition on  $\text{Pf}(D^-)^{I_m(\lambda)}$  for  $\lambda \in \text{Par}(m, w)$  is checked by an argument similar to that of (1). The second and the third conditions can be proved by using the relation  $\delta_{p+N}^- = \delta_p^- + 1 - (-1)^p$ .

(3) In order to prove  $\text{Pf}(D^+)^{I_m(\lambda)} = d_{m,w}^+(\lambda)$  for  $\lambda \in \text{Par}(m, w)$ , we note the relation

$$\delta_q^+ - \delta_p^+ = \lceil q/2 \rceil - \lceil p/2 \rceil.$$

If  $\lambda$  is neither even nor odd, then there is an index  $k$  such that  $i_k \equiv i_{k+1} \pmod{2}$ , where  $I_m(\lambda) = (i_1, \dots, i_m)$ . We can use the above relation to see that the 0-th,  $k$ -th and  $(k+1)$ -st rows are linearly dependent, hence we have  $\text{Pf}(D^+)^{I_m(\lambda)} = 0$ . If  $\lambda$  is even or odd, then by using the above relation we can perform the row/column operations to transform the skew-symmetric matrix  $(D^+)^{I_m(\lambda)}$  to the skew-symmetric matrix  $M = (M_{i,j})_{0 \leq i, j \leq m}$  with entries  $M_{i,j}$ ,  $i < j$ , given by

$$M_{i,j} = \begin{cases} 1 & \text{if } i = 0 \text{ and } j = 1, \\ 1 & \text{if } i = 1 \text{ and } j \text{ is even,} \\ (-1)^{j-i-1} & \text{if } i \geq 2, \\ 0 & \text{otherwise.} \end{cases}$$

Hence by expanding along the 0-th row/column, we see

$$\text{Pf}(D^+)^{I_m(\lambda)} = \text{Pf } M = \text{Pf}_{2 \leq i < j \leq m} \left( (-1)^{j-i-1} \right) = 1,$$

where we used [19, Lemma 7] in the last equality. Therefore we have  $\text{Pf}(D^+)^{I_m(\lambda)} = d_{2h+1,w}^+(\lambda)$ .

Using the relation  $\delta_{p+N}^+ = \delta_p^+ + N'$ , we can prove that  $D^+$  satisfies the second and the third conditions.

(4) The proof is the same as (3) up to a sign, so we omit it.  $\square$

*Proof of Theorem 3.2.* (1) By applying Proposition 5.1 to the skew-symmetric matrix  $D^+$  given in Lemma 5.5 (1), we have

$$2^{h-1} \sum_{\lambda \in \text{Par}(2h,w)} \sum_{k \in Q_{2h}^+} d_{2h,w}^+(\lambda) \det_{1 \leq i, j \leq 2h} \left( e_{\lambda_i - i + j + Nk_i} \right) = \text{Pf} \left( T_0 D^+ T_0^t \right) = \text{Pf}_{1 \leq i < j \leq 2h} \left( v_{j-i}^+ \right),$$

where  $v_r^+ = \sum_{k \in \mathbb{Z}} \delta_k^+ f_{-k+r}$ . Since  $\delta_p^+ - \delta_{p-2}^+ = 2(-1)^k$  if  $p = kN + 1$  and 0 otherwise, we obtain  $v_1^+ = \overline{F}_{0,N}$  and  $v_r^+ - v_{r-2}^+ = 2\overline{F}_{r-1,N}$ . Hence by using (3.12), we have

$$\text{Pf}_{1 \leq i < j \leq 2h} \left( v_{j-i}^+ \right) = \det \left( \begin{array}{cc} \overline{F}_{0,N} & (2\overline{F}_{j-1,N})_{2 \leq j \leq h} \\ (2\overline{F}_{i-1,N})_{2 \leq i \leq h} & (2\overline{F}_{i+j-2,N} + 2\overline{F}_{|j-i|,N})_{2 \leq i, j \leq h} \end{array} \right) = 2^{h-2} \det_{1 \leq i, j \leq h} \left( \overline{F}_{-i+j,N} + \overline{F}_{i+j-2,N} \right).$$

(2) By applying Proposition 5.1 to the skew-symmetric matrix  $D^-$  given in Lemma 5.5 (2), we have

$$2^{h-1} \sum_{\lambda \in \text{Par}(2h,w)} \sum_{k \in Q_{2h}^-} d_{2h,w}^-(\lambda) \det_{1 \leq i, j \leq 2h} \left( e_{\lambda_i - i + j + Nk_i} \right) = \text{Pf} \left( T_2 D^- T_2^t \right).$$

Here the entries  $Q_{i,j}$  ( $i, j \in \{0, 0', 1, \dots, m\}$  and  $i < j$ ) of the matrix  $T_2 D^- T_2^t$  are given by

$$Q_{0,0'} = 0, \quad Q_{0,j} = e, \quad Q_{0',j} = (-1)^{j-1} \overline{e}, \quad Q_{i,j} = \sum_{p \in \mathbb{Z}} \delta_p^- f_{-p+j-i},$$

where  $i, j \geq 1$ . In the last Pfaffian, we subtract the row/column  $i-2$  from the row/column  $i$  for  $i = m, m-1, \dots, 3$ , and then add the row/column  $0'$  to the row/column 0. Then by expanding the resulting Pfaffian along the row/column 0, we see that

$$\text{Pf} \left( T_2 D^- T_2^t \right) = 2e\overline{e} \text{Pf}_{1 \leq i, j \leq 2h-2} \left( v_{j-i}^- - v_{j-i-2}^- - v_{j-i+2}^- + v_{j-i}^- \right),$$



where  $v_r^- = \sum_{p \in \mathbb{Z}} \delta_p^- f_{-p+j-i}$ . Since  $\delta_p^- - \delta_{p-2}^- = 2$  if  $p = kN + 1$  and 0 otherwise, we have  $v_r^- - v_{r-2}^- = 2F_{r-1, N}$ . Now by using (3.9), we can obtain the desired identity.

(3) By using Proposition 5.1 and a computation similar to the proof of (3.4), we have

$$\sum_{\lambda \in \text{Par}(2h+1, w)} \sum_{k \in Q_{2h+1}^\vee} d_{2h+1, w}^+(\lambda) \det_{1 \leq i, j \leq 2h+1} (e_{\lambda_i - i + j + Nk_i}) = e \cdot \text{Pf}_{2 \leq i, j \leq 2h+1} (v_{j-i}^+ - v_{j-i-1}^+ - v_{j-i+1}^+ + v_{j-i}^+).$$

Since we have

$$\delta_p^+ - \delta_{p-1}^+ - \delta_{p+1}^+ + \delta_p^+ = \begin{cases} 1 & \text{if } p = Nk + r, \text{ where } k, r \in \mathbb{Z} \text{ such that } 0 < r < N \text{ and } r \text{ is odd,} \\ -1 & \text{if } p = Nk + r, \text{ where } k, r \in \mathbb{Z} \text{ such that } 0 < r < N \text{ and } r \text{ is even,} \\ 0 & \text{otherwise,} \end{cases}$$

we see

$$v_r^+ - v_{r-1}^+ - v_{r+1}^+ + v_r^+ = \sum_{t=1}^{N-1} (-1)^t F_{r+t, N},$$

where we note that  $N$  is even and  $F_{r+N, N} = F_{r, N}$ . Then we can complete the proof by applying (3.11).

(4) The proof is similar to that of (3). In this case, we use the relation

$$\delta_p^+ + \delta_{p-1}^+ + \delta_{p+1}^+ + \delta_p^+ = \begin{cases} (-1)^k & \text{if } p = Nk + r, \text{ where } k, r \in \mathbb{Z} \text{ and } 0 < r < N, \\ 0 & \text{otherwise,} \end{cases}$$

and the formula (3.10). □

## 6. CYLINDRIC ROW-STRICT TABLEAUX AND UP-DOWN TABLEAUX

In this section we prove the Jacobi–Trudi formula for cylindric Schur functions (Theorem 1.4). We also give combinatorial interpretations of the right-hand sides of the affine Gordon–Bender–Knuth identities (1.11) and (1.12) using up-down tableaux.

**6.1. Cylindric row-strict tableaux.** By Proposition 2.8, Theorem 1.4 is equivalent to the following theorem.

**Theorem 6.1.** *For positive integers  $h$  and  $w$  and a partition  $\lambda \in \text{Par}(h, w)$ , we have*

$$\sum_{T \in \text{CRST}(\lambda; h, w)} \mathbf{x}^T = \sum_{\substack{k_1, \dots, k_h \in \mathbb{Z} \\ k_1 + \dots + k_h = 0}} \det_{1 \leq i, j \leq h} (e_{\lambda_i - i + j + (h+w)k_i}(\mathbf{x})).$$

*Proof.* We first show that the right-hand side is the generating function for certain families of non-intersecting lattice paths. In order to see this, we place ourselves in the setting of Section 9 in [11]. Namely, we consider the graph with vertices being the points in the integer plane  $\mathbb{Z}^2$ , and with edges being horizontal edges  $(i-1, j) \rightarrow (i, j)$  and vertical edges  $(i, j-1) \rightarrow (i, j)$ . We define the weight of vertical edges to be 1 and the weight of a horizontal edge  $e$  from  $(i-1, j)$  to  $(i, j)$  to be  $\omega(e) := x_{i+j}$ . By definition the weight  $\omega(P)$  of a path  $P$  is the product of the weight of all its edges, and the weight  $\omega(\mathbf{P})$  of a family  $\mathbf{P} = (P_1, P_2, \dots, P_k)$  of paths is  $\prod_{i=1}^k \omega(P_i)$ . Now, given  $T \in \text{CRST}(\lambda; w, h)$ , we convert it into a family  $\mathbf{P} = (P_1, P_2, \dots, P_h)$  of paths in the graph, by mapping the  $i$ -th row of  $T$  to the path  $P_i$  from  $(-i+1, i-1)$  to  $(\lambda_i - i + 1, \infty)$  such that the weights of the horizontal steps are indexed by the entries in that row. For example, see Figure 5 for the family of paths corresponding to the tableau in Figure 4.

The property of  $T$  having weak increase of entries along columns translates into the property of  $\mathbf{P}$  being non-intersecting, and the property of  $T$  being  $(h, w)$ -cylindric translates into the property that the shift of  $P_1$  by  $(-h-w, h+w)$  does not intersect  $P_h$  (and, thus, also not any of the other paths). In Figure 5, this shift of  $P_1$  is indicated by the dotted path.

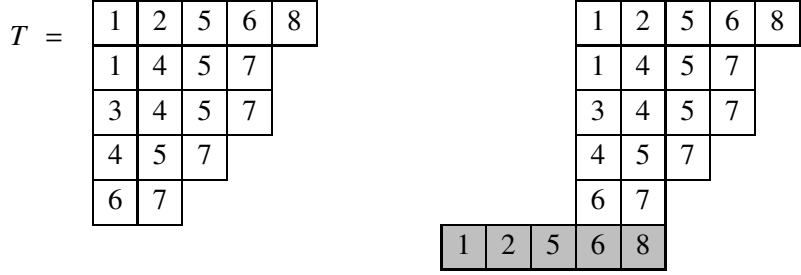

FIGURE 4. The left diagram shows a row-strict tableau  $T \in \text{CRST}(\lambda; h, w)$  for  $\lambda = (5, 4, 4, 3, 2)$ ,  $h = 5$ , and  $w = 3$ . The right diagram shows  $T$  together with a copy of its first row translated by  $(h, -w)$ .

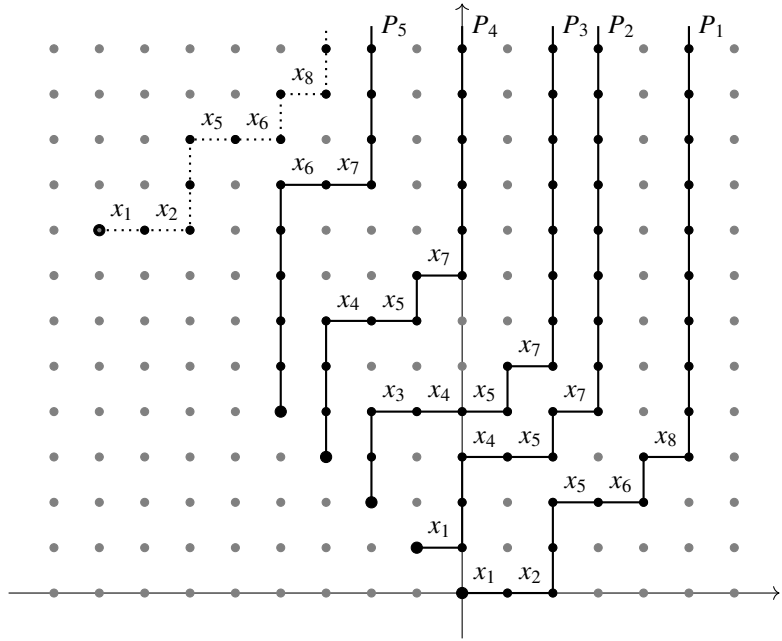

FIGURE 5. The family  $\mathbf{P} = (P_1, P_2, P_3, P_4, P_5)$  of paths corresponding to the tableau  $T$  in Figure 4. The shift of  $P_1$  is indicated by the dotted path.

Therefore the right-hand side equals the generating function  $\sum_{\mathbf{P}} \omega(\mathbf{P})$  for these families  $\mathbf{P}$  of non-intersecting lattice paths. As explained in [11, Sec. 9] this generating function is equal to

$$\sum_{\substack{k_1, \dots, k_h \in \mathbb{Z} \\ k_1 + \dots + k_h = 0}} \det_{1 \leq i, j \leq h} \left( e_{\lambda_i - i + j + (h+w)k_i}(\mathbf{x}) \right),$$

which completes the proof. □

*Remark 6.2.* The  $(h, w)$ -cylindric standard Young tableaux of size  $n$  can be seen as lattice paths in  $\mathbb{Z}^h$  starting at zero, consisting of positive unit steps in coordinate directions, and staying in the region

$$\{(x_1, x_2, \dots, x_h) : x_1 \geq x_2 \geq \dots \geq x_h \geq x_1 - w\}.$$

If the end point is also given, say  $(\lambda_1, \lambda_2, \dots, \lambda_h)$ , then there is a formula which gives the number of such paths due to Filaseta [9] (which turned out to be a special case of the more general formula for the number

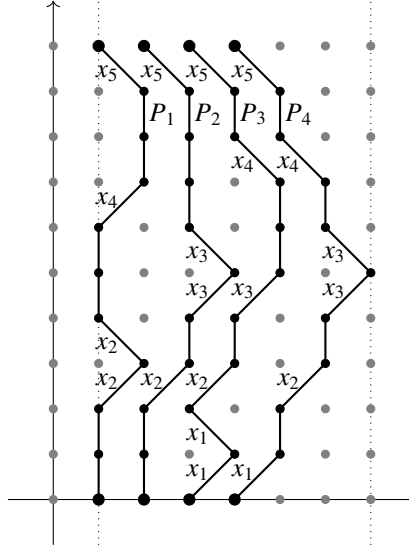

FIGURE 6. An example of a family  $\mathbf{P} = (P_1, P_2, P_3, P_4)$  of non-intersecting paths.

of random walks in Weyl chambers due to Gessel and Zeilberger [12]). Using this formula, we get

$$(6.1) \quad |\text{SYT}_n(h, w)| = \sum_{\substack{\lambda \in \text{Par}(h, w) \\ |\lambda| = n}} \sum_{\substack{k_1, \dots, k_h \in \mathbb{Z} \\ k_1 + \dots + k_h = 0}} n! \det_{1 \leq i, j \leq h} \left( \frac{1}{(\lambda_i - i + j + (h + w)k_i)!} \right).$$

This is also obtained by taking the coefficients of  $x_1 \cdots x_n$  in both sides of the equation in Theorem 6.1.

**6.2. Up-down tableaux.** Note that there is a combinatorial meaning to the left-hand sides of the affine Gordon–Bender–Knuth identities (1.11) and (1.12) in terms of cylindric semistandard Young tableaux. For the rest of this section we give combinatorial interpretations of their right-hand sides using up-down tableaux, which are sequences of partitions satisfying certain conditions. In this subsection we only consider the simplest case (1.11) with  $w$  odd. The other cases will be covered in the next subsection.

Following the setting of [20, Sec. 2], we consider lattice paths in the plane integer lattice with steps from the set

$$(6.2) \quad S = \{(i, j) \rightarrow (i, j + 1), (i, 2j - 2) \rightarrow (i + 1, 2j - 1), (i, 2j - 1) \rightarrow (i - 1, 2j) : i, j \in \mathbb{Z}\}.$$

In words, the set of steps consists of vertical steps  $s_v$  north, forward diagonal steps  $s_f$  northeast from even height to odd height, and backward diagonal steps  $s_b$  northwest from odd height to even height. Throughout this subsection and the next, when we say ‘lattice path’ or simply ‘path’ we always mean a lattice path with steps from the set  $S$ . Several such lattice paths are displayed in Figure 6.

We define the weight  $\omega(s_v)$  of a vertical step  $s_v$  to be 1, the weight  $\omega(s_f)$  of a forward diagonal step  $s_f$  from  $(i, 2j - 2)$  to  $(i + 1, 2j - 1)$  to be  $x_j$ , and the weight  $\omega(s_b)$  of a backward diagonal step from  $(i, 2j - 1)$  to  $(i - 1, 2j)$  to be also  $x_j$ . The weight of a path equals the product of the weights of its steps.

Let  $L(u \rightarrow v)$  denote the set of lattice paths from  $u$  to  $v$ . Let  $L(a, b; u \rightarrow v)$  denote the set of  $P \in L(u \rightarrow v)$  such that every point  $(i, 2j)$  of even height in  $P$  satisfies  $a \leq i \leq b$ . Note that if  $P \in L(a, b; (r, 0) \rightarrow (s, 2n))$  for some integers  $r, s$  with  $a \leq r, s \leq b$ , then every point  $(i, 2j + 1)$  of odd height in  $P$  always satisfies  $a \leq i \leq b + 1$ .

**Lemma 6.3.** *For positive integers  $i, j, N$  and  $n$  with  $1 \leq i, j < N$ , we have*

$$(6.3) \quad F_{-i+j, 2N+2}(x_1, \dots, x_n) - F_{i+j, 2N+2}(x_1, \dots, x_n) = \sum_{P \in L(1, N; (i, 0) \rightarrow (j, 2n))} \omega(P).$$

*Proof.* Since

$$(6.4) \quad \sum_{P \in L((a, 0) \rightarrow (b, 2n))} \omega(P) = \sum_{k \in \mathbb{Z}} e_k(x_1, \dots, x_n) e_{b-a+k}(x_1, \dots, x_n) = f_{b-a}(x_1, \dots, x_n),$$

we can rewrite (6.3) as follows:

$$(6.5) \quad \sum_{\substack{k \in \mathbb{Z}, \varepsilon \in \{-1, +1\} \\ P \in L((\varepsilon i + k(2N+2), 0) \rightarrow (j, 2n))}} \varepsilon \omega(P) = \sum_{P \in L(1, N; (i, 0) \rightarrow (j, 2n))} \omega(P).$$

We will prove (6.5) by constructing a sign-reversing involution, say  $\varphi$ , on the set

$$\mathcal{B} := \left( \bigcup_{k \in \mathbb{Z}} \bigcup_{\varepsilon \in \{-1, +1\}} L((\varepsilon i + k(2N+2), 0) \rightarrow (j, 2n)) \right) \setminus L(1, N; (i, 0) \rightarrow (j, 2n)),$$

where the sign of  $P \in L((\varepsilon i + k(2N+2), 0) \rightarrow (j, 2n))$  is defined to be  $\varepsilon$ .

Let  $P \in \mathcal{B}$ . Then there is at least one point  $(x, y)$  in  $P$  such that  $x \in \{0, N+1\}$  and  $y$  is even. Choose such a point  $(x, y)$  with maximal  $y$ . We let  $P'$  be the portion of  $P$  from its starting point up to  $(x, y)$  and  $P''$  the portion from  $(x, y)$  up to  $P$ 's end point. Then we define  $\varphi(P) = \mathfrak{R}(P')P''$ , where  $\mathfrak{R}$  means the modified reflection from [20, Proof of (1.1)]. To be specific, beginning from  $P$ 's starting point up to  $(x, y)$ , we group steps in pairs. If a pair consists of two vertical steps then we leave them invariant, as well as if the pair consists of a forward diagonal step followed by a backward diagonal step. If a pair consists of a forward diagonal step followed by a vertical step, then we replace this pair by the pair consisting of a vertical step followed by a backward diagonal step, and vice versa.

Since the map  $\varphi$  leaves the portion of the path after  $(x, y)$  invariant, twofold application of  $\varphi$  will bring us back to  $P$ . Thus, the map  $\varphi$  is indeed an involution. To see that  $\varphi$  is sign-reversing suppose that the starting point of  $P$  is  $(\varepsilon i + k(2N+2), 0)$  so that the sign of  $P$  is  $\varepsilon$ . Then the starting point of  $\varphi(P)$  is  $(-\varepsilon i - k(2N+2), 0)$  (resp.  $(-\varepsilon i + (1-k)(2N+2), 0)$ ) if  $x = 0$  (resp.  $x = N+1$ ). Thus the sign of  $\varphi(P)$  is always  $-\varepsilon$ . Furthermore, the map  $\varphi$  is clearly weight-preserving. This completes the proof of (6.5).  $\square$

**Definition 6.4.** An  $(h, w)$ -up-down tableau is a sequence  $(\lambda^0, \lambda^1, \dots, \lambda^{2n})$  of partitions of length at most  $h$  satisfying the following properties:

- (i)  $\emptyset = \lambda^0 \subseteq \lambda^1 \supseteq \lambda^2 \subseteq \lambda^3 \supseteq \lambda^4 \subseteq \dots \subseteq \lambda^{2n-1} \supseteq \lambda^{2n} = \emptyset$ ;
- (ii) each pair  $(\lambda^{i-1}, \lambda^i)$  differs by a vertical strip (that is, by a collection of cells which contains at most one cell in each row),  $i = 1, 2, \dots, 2n$ ;
- (iii) each  $\lambda^{2i}$  has at most  $w$  columns,  $i = 1, 2, \dots, n$ .

Let  $\text{UD}_n(h, w)$  denote the set of  $(h, w)$ -up-down tableaux  $(\lambda^0, \lambda^1, \dots, \lambda^{2n})$ . For  $T = (\lambda^0, \lambda^1, \dots, \lambda^{2n}) \in \text{UD}_n(h, w)$ , we define its weight by

$$\omega(T) = \prod_{i=1}^n x_i^{-|\lambda^{2i-2}| + 2|\lambda^{2i-1}| - |\lambda^{2i}|}.$$

Note that  $-|\lambda^{2i-2}| + 2|\lambda^{2i-1}| - |\lambda^{2i}|$  is the sum of the differences in sizes of  $(\lambda^{2i-2}, \lambda^{2i-1})$  and of  $(\lambda^{2i-1}, \lambda^{2i})$ .

**Theorem 6.5.** *For positive integers  $h, w$  and  $n$ ,*

$$(6.6) \quad \det_{1 \leq i, j \leq h} \left( F_{-i+j, 2h+2w+2}(x_1, \dots, x_n) - F_{i+j, 2h+2w+2}(x_1, \dots, x_n) \right) = \sum_{T \in \text{UD}_n(h, w)} \omega(T).$$



**6.3. Marked up-down tableaux.** In this subsection we consider the right-hand sides of the affine Gordon-Bender-Knuth identities (1.11) with  $w$  even and (1.12) using marked up-down tableaux. We will use the terminology defined in the previous subsection. We need some more definitions.

**Definition 6.7.** A  $1$ -branch point of a lattice path  $P$  is a point  $(1, 2j - 1)$  such that  $P$  passes through  $(1, 2j - 2)$ ,  $(1, 2j - 1)$  and  $(1, 2j)$ . For an integer  $N > 1$ , an  $N$ -branch point of a lattice path  $P$  is a point  $(N + 1, 2j - 1)$  such that  $P$  passes through  $(N, 2j - 2)$ ,  $(N + 1, 2j - 1)$  and  $(N, 2j)$ .

For an integer  $t \geq 1$ , a  $t$ -marked lattice path is a pair  $(P, M)$  of a lattice path  $P$  and a set  $M$  of  $t$ -branch points of  $P$ . For integers  $t_1, t_2 \geq 1$ , a  $(t_1, t_2)$ -marked lattice path is a triple  $(P, M_1, M_2)$ , where  $P$  is a lattice path and  $M_i$  is a set of  $t_i$ -branch points of  $P$  for  $i = 1, 2$ .

For a  $t$ -branch point  $u$  of height  $2j - 1$ , we define its weight by

$$\omega(u) = \begin{cases} x_j & \text{if } t = 1, \\ -1/x_j & \text{if } t > 1. \end{cases}$$

We also define

$$\omega(P, M) = \omega(P)\omega(M), \quad \omega(P, M_1, M_2) = \omega(P)\omega(M_1)\omega(M_2),$$

where  $\omega(M) = \prod_{u \in M} \omega(u)$ .

A marked lattice path may be considered as a lattice path in which some branch points are marked. Note that the weight of a marked lattice path also contains the sign, which is the product of  $-1$  for each marked  $t$ -branch point for  $t > 1$ .

Recall that  $L(u \rightarrow v)$  is the set of lattice paths from  $u$  to  $v$  and  $L(a, b; u \rightarrow v)$  is the set of  $P \in L(u \rightarrow v)$  such that every point  $(i, 2j)$  of even height in  $P$  satisfies  $a \leq i \leq b$ . Let  $L(a^*, b; u \rightarrow v)$  denote the set of  $a$ -marked lattice paths  $(P, M)$  with  $P \in L(a, b; u \rightarrow v)$ . The sets  $L(a, b^*; u \rightarrow v)$  and  $L(a^*, b^*; u \rightarrow v)$  are defined similarly.

**Lemma 6.8.** For positive integers  $i, j, N$  and  $n$  with  $1 \leq i, j < N$ , we have

$$(6.8) \quad F_{-i+j, 2N+1}(x_1, \dots, x_n) - F_{i+j, 2N+1}(x_1, \dots, x_n) = \sum_{(P, M) \in L(1, N^*; (i, 0) \rightarrow (j, 2n))} \omega(P, M),$$

$$(6.9) \quad \bar{F}_{-i+j, 2N+1}(x_1, \dots, x_n) + \bar{F}_{i+j-1, 2N+1}(x_1, \dots, x_n) = \sum_{(P, M) \in L(1^*, N; (i, 0) \rightarrow (j, 2n))} \omega(P, M),$$

$$(6.10) \quad \bar{F}_{-i+j, 2N}(x_1, \dots, x_n) + \bar{F}_{i+j-1, 2N}(x_1, \dots, x_n) = \sum_{(P, M_1, M_2) \in L(1^*, N^*; (i, 0) \rightarrow (j, 2n))} \omega(P, M_1, M_2).$$

*Proof.* By (6.4), we can rewrite the identities as follows:

$$(6.11) \quad \sum_{\substack{k \in \mathbb{Z}, \varepsilon \in \{-1, +1\} \\ P \in L((\varepsilon i + k(2N+1), 0) \rightarrow (j, 2n))}} \varepsilon \omega(P) = \sum_{(P, M) \in L(1, N^*; (i, 0) \rightarrow (j, 2n))} \omega(P, M),$$

$$(6.12) \quad \sum_{\substack{k \in \mathbb{Z}, \varepsilon \in \{-1, +1\} \\ P \in L((\varepsilon(i-1/2)+1/2+k(2N+1), 0) \rightarrow (j, 2n))}} (-1)^k \omega(P) = \sum_{(P, M) \in L(1^*, N; (i, 0) \rightarrow (j, 2n))} \omega(P, M),$$

$$(6.13) \quad \sum_{\substack{k \in \mathbb{Z}, \varepsilon \in \{-1, +1\} \\ P \in L((\varepsilon(i-1/2)+1/2+k(2N), 0) \rightarrow (j, 2n))}} (-1)^k \omega(P) = \sum_{(P, M_1, M_2) \in L(1^*, N^*; (i, 0) \rightarrow (j, 2n))} \omega(P, M_1, M_2).$$

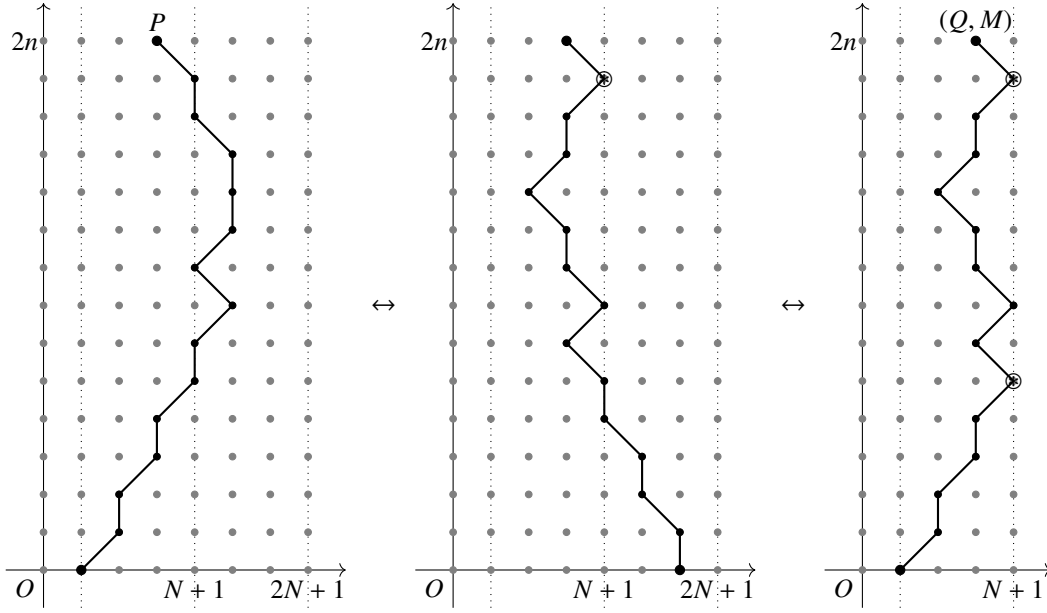

FIGURE 8. An example of a path  $P \in L(1, 2N; (i, 0) \rightarrow (j, 2n))$  and its corresponding  $N$ -marked path  $(Q, M) \in L(1, N^*; (i, 0) \rightarrow (j, 2n))$  with  $N = 3, i = 1, j = 2$  and  $n = 7$ . Each  $N$ -branch point is indicated by  $\otimes$ .

For the identity (6.11) we proceed similarly as in the proof of Lemma 6.3 by constructing a sign-reversing involution using the point  $(x, y)$  in  $P$  with  $x \in \{0, 2N + 1\}$  and  $y$  even, if such a point exists. This will give

$$(6.14) \quad \sum_{\substack{k \in \mathbb{Z}, \varepsilon \in \{-1, +1\} \\ P \in L((\varepsilon i + k(2N+1), 0) \rightarrow (j, 2n))}} \varepsilon \omega(P) = \sum_{P \in L(1, 2N; (i, 0) \rightarrow (j, 2n))} \omega(P) - \sum_{P \in L(1, 2N; (2N+1-i, 0) \rightarrow (j, 2n))} \omega(P).$$

Now let  $P \in L(1, 2N; (i, 0) \rightarrow (j, 2n)) \cup L(1, 2N; (2N + 1 - i, 0) \rightarrow (j, 2n))$ . We will construct an  $N$ -marked path  $(Q, M) \in L(1, N^*; (i, 0) \rightarrow (j, 2n))$  as follows.

First let  $(Q, M) = (P, \emptyset)$ . We will modify  $(Q, M)$  repeatedly until it becomes an element in  $L(1, N^*; (i, 0) \rightarrow (j, 2n))$ . If  $(Q, M) \in L(1, N^*; (i, 0) \rightarrow (j, 2n))$ , then there is nothing to do. Otherwise, choose the largest even integer  $y$  such that  $(N + 1, y)$  is a point in  $Q$ . Then  $Q$  must pass through all points  $(N + 1, y), (N + 1, y + 1)$  and  $(N, y + 2)$ . Let  $Q'$  be the portion of  $Q$  from its starting point up to  $(N + 1, y)$  and  $Q''$  the portion from  $(N, y + 2)$  up to  $Q$ 's end point, i.e.,  $Q = Q' s_y s_b Q''$ . Then we update  $Q$  with  $\mathfrak{R}(Q') s_f s_b Q''$  and add the point  $(N + 1, y + 1)$  to the set  $M$ . Repeating this process eventually gives  $(Q, M) \in L(1, N^*; (i, 0) \rightarrow (j, 2n))$ . For example, see Figure 8. It is easy to see that the map  $P \mapsto (Q, M)$  is a weight-preserving bijection from  $L(1, 2N; (i, 0) \rightarrow (j, 2n)) \cup L(1, 2N; (2N + 1 - i, 0) \rightarrow (j, 2n))$  to  $L(1, N^*; (i, 0) \rightarrow (j, 2n))$ . This shows that the right-hand sides of (6.11) and (6.14) are equal, completing the proof of (6.11).

The identity (6.12) can be proved similarly as (6.11). We first construct a sign-reversing involution using the point  $(x, y)$  in  $P$  with  $x \in \{-N, N + 1\}$  and  $y$  even, if such a point exists. This will give

$$\sum_{\substack{k \in \mathbb{Z}, \varepsilon \in \{-1, +1\} \\ P \in L((\varepsilon(i-1/2) + 1/2 + k(2N+1), 0) \rightarrow (j, 2n))}} (-1)^k \omega(P) = \sum_{P \in L(1-N, N; (i, 0) \rightarrow (j, 2n))} \omega(P) + \sum_{P \in L(1-N, N; (1-i, 0) \rightarrow (j, 2n))} \omega(P).$$

For each  $P \in L(1 - N, N; (i, 0) \rightarrow (j, 2n)) \cup L(1 - N, N; (1 - i, 0) \rightarrow (j, 2n))$ , we can construct  $(Q, M) \in L(1^*, N; (i, 0) \rightarrow (j, 2n))$  as follows. Let  $(Q, M) = (P, \emptyset)$ . If  $(Q, M) \in L(1^*, N; (i, 0) \rightarrow (j, 2n))$ , then there is nothing to do. Otherwise, choose the largest even integer  $y$  such that  $(0, y)$  is a point in  $Q$ . Then  $Q$  must pass

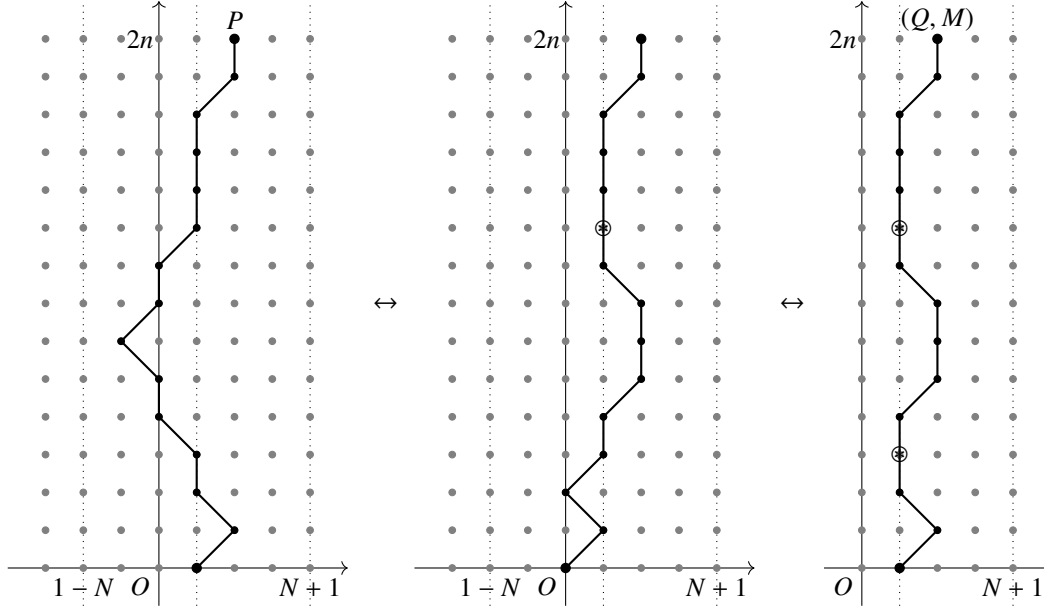

FIGURE 9. An example of a path  $P \in L(1-N, N; (i, 0) \rightarrow (j, 2n))$  and its corresponding 1-marked path  $(Q, M) \in L(1^*, N; (i, 0) \rightarrow (j, 2n))$  with  $N = 3, i = 1, j = 2$ , and  $n = 7$ . Each 1-branch point is indicated by  $\oplus$ .

through all points  $(0, y), (1, y+1)$  and  $(1, y+2)$ . Let  $Q'$  be the portion of  $Q$  from its starting point up to  $(0, y)$  and  $Q''$  the portion from  $(1, y+2)$  up to  $Q$ 's end point. Then we update  $Q$  with  $\mathfrak{R}(Q')_{s_v, s_v} Q''$  and add the point  $(1, y+1)$  to the set  $M$ . Repeating this process eventually gives  $(Q, M) \in L(1^*, N; (i, 0) \rightarrow (j, 2n))$ . An example is given in Figure 9. Again, the map  $P \mapsto (Q, M)$  is a weight-preserving bijection from  $L(1-N, N; (i, 0) \rightarrow (j, 2n)) \cup L(1-N, N; (1-i, 0) \rightarrow (j, 2n))$  to  $L(1^*, N; (i, 0) \rightarrow (j, 2n))$ , and we obtain (6.12).

For the last identity (6.13) we do not need a sign-reversing involution. Instead, we construct  $(Q, M_1, M_2) \in L(1^*, N^*; (i, 0) \rightarrow (j, 2n))$  directly from  $P \in L((\varepsilon(i-1/2) + 1/2 + k(2N), 0) \rightarrow (j, 2n))$ . To do this, as before, we first set  $(Q, M_1, M_2) = (P, \emptyset, \emptyset)$ . If  $(Q, M_1, M_2) \in L(1^*, N^*; (i, 0) \rightarrow (j, 2n))$ , then we are done. Otherwise, find the largest even  $y$  such that  $(0, y)$  or  $(N+1, y)$  is a point in  $Q$ . Then we modify  $Q$  by the same method as above and add  $(1, y+1)$  to  $M_1$  (resp.  $(N+1, y+1)$  to  $M_2$ ) if  $(0, y)$  (resp.  $(N+1, y)$ ) is a point of  $Q$ . This proves (6.13).  $\square$

Now we define marked up-down tableaux.

**Definition 6.9.** An  $(h^*, w)$ -up-down tableau (resp.  $(h, w^*)$ -up-down tableau) is a pair  $(T, M)$  of an  $(h, w)$ -up-down tableau  $T = (\lambda^0, \lambda^1, \dots, \lambda^{2n})$  and a subset  $M \subseteq \{1, 2, \dots, n\}$  such that if  $j \in M$  then  $\lambda_h^{2j-1} = 0$  (resp.  $\lambda_1^{2j-1} = w+1$ ). An  $(h^*, w^*)$ -up-down tableau is a triple  $(T, M_1, M_2)$  of an  $(h, w)$ -up-down tableau  $T = (\lambda^0, \lambda^1, \dots, \lambda^{2n})$  and subsets  $M_1, M_2 \subseteq \{1, 2, \dots, n\}$  such that if  $j \in M_1$  then  $\lambda_h^{2j-1} = 0$ , and if  $j \in M_2$  then  $\lambda_1^{2j-1} = w+1$ .

One can consider an  $(h^*, w)$ -up-down tableau as an  $(h, w)$ -up-down tableau  $(\lambda^0, \lambda^1, \dots, \lambda^{2n})$  in which each last zero part  $\lambda_h^{2j-1} = 0$ , if exists, may be marked.

We define  $\text{UD}_n(h^*, w)$  to be the set of  $(h^*, w)$ -up-down tableaux  $(T, M)$  with  $T \in \text{UD}_n(h, w)$ . The sets  $\text{UD}_n(h, w^*)$  and  $\text{UD}_n(h^*, w^*)$  are defined similarly. For  $(T, M_1) \in \text{UD}_n(h^*, w)$ ,  $(T, M_2) \in \text{UD}_n(h, w^*)$  and



$(T, M_1, M_2) \in \text{UD}_n(h^*, w^*)$ , we define their weights by

$$\begin{aligned}\omega(T, M_1) &= \omega(T) \prod_{j \in M_1} x_j, \\ \omega(T, M_2) &= \omega(T) \prod_{j \in M_2} \left(-\frac{1}{x_j}\right), \\ \omega(T, M_1, M_2) &= \omega(T) \prod_{j \in M_1} x_j \prod_{j \in M_2} \left(-\frac{1}{x_j}\right).\end{aligned}$$

**Theorem 6.10.** *For positive integers  $h, w$  and  $n$ ,*

$$(6.15) \quad \det_{1 \leq i, j \leq h} \left( F_{-i+j, 2h+2w+1}(x_1, \dots, x_n) - F_{i+j, 2h+2w+1}(x_1, \dots, x_n) \right) = \sum_{(T, M) \in \text{UD}_n(h, w^*)} \omega(T, M),$$

$$(6.16) \quad \det_{1 \leq i, j \leq h} \left( \bar{F}_{-i+j, 2h+2w+1}(x_1, \dots, x_n) + \bar{F}_{i+j-1, 2h+2w+1}(x_1, \dots, x_n) \right) = \sum_{(T, M) \in \text{UD}_n(h^*, w)} \omega(T, M),$$

$$(6.17) \quad \det_{1 \leq i, j \leq h} \left( \bar{F}_{-i+j, 2h+2w}(x_1, \dots, x_n) + \bar{F}_{i+j-1, 2h+2w}(x_1, \dots, x_n) \right) = \sum_{(T, M_1, M_2) \in \text{UD}_n(h^*, w^*)} \omega(T, M_1, M_2).$$

*Proof.* This can be proved by similar arguments as in the proof of Theorem 6.5 using Lemma 6.8. The only thing that needs careful thought is whether the chosen intersection point  $(x, y)$  is a  $t$ -branch point of some path for  $t \in \{1, h+w\}$ . This never happens because we have chosen the intersection point  $(x, y)$  with  $y$  maximal. To see this, suppose that  $(x, y)$  is a common point of  $P_r$  and  $P_s$ , and  $(x, y)$  is a 1-branch point of  $P_r$ . Then  $(x, y) = (1, 2j-1)$  for some  $j$ , and  $P_r$  passes through  $(1, 2j-2)$  and  $(1, 2j)$  as well. Recalling the step set (6.2), the only possible steps starting from  $(1, 2j-1)$  are the vertical step and the backward diagonal steps. Thus  $P_s$  must pass through  $(1, 2j)$  or  $(0, 2j)$ . However, since  $(x, y)$  is chosen to be the intersection point with  $y$  maximal,  $P_s$  does not pass through  $(1, 2j)$ , and since  $P_s \in L(1, h+w; u \rightarrow v)$  for some points  $u$  and  $v$ , it does not pass through  $(0, 2j)$ . This is a contradiction and therefore  $(x, y)$  is not a 1-branch point of any path. Similarly, it is not an  $(h+w)$ -branch point. Therefore the ‘‘Lindström–Gessel–Viennot’’ switching works.  $\square$

As consequences of Theorem 6.10 we obtain combinatorial interpretations for the right-hand sides of the affine Gordon-Bender-Knuth identities (1.11) with  $w$  even and (1.12). Note that these combinatorial interpretations use up-down tableaux without marking.

**Corollary 6.11.** *The coefficient of  $x_1^{m_1} x_2^{m_2} \dots x_n^{m_n}$  in*

$$\sum_{k \geq 0} e_k(\mathbf{x}) \det_{1 \leq i, j \leq h} \left( F_{-i+j, 2h+2w+1}(\mathbf{x}) - F_{i+j, 2h+2w+1}(\mathbf{x}) \right)$$

*equals the number of  $(h, w)$ -up-down tableaux  $(\lambda^0, \lambda^1, \dots, \lambda^{2n})$  satisfying that for  $i = 1, 2, \dots, n$ ,*

$$-|\lambda^{2i-2}| + 2|\lambda^{2i-1}| - |\lambda^{2i}| = \begin{cases} m_i \text{ or } m_i - 1 & \text{if } \lambda_1^{2i-1} \leq w \text{ and not } \lambda_1^{2i-2} = \lambda_1^{2i-1} = \lambda_1^{2i} = w, \\ m_i & \text{if } \lambda_1^{2i-2} = \lambda_1^{2i-1} = \lambda_1^{2i} = w, \\ m_i - 1 & \text{if } \lambda_1^{2i-1} = w + 1. \end{cases}$$

*Proof.* By (6.15), the coefficient in question is equal to  $\sum_{(T, M) \in X} (-1)^{|M|}$ , where  $X$  is the set of  $(T, M) \in \text{UD}_n(h, w^*)$  with  $T = (\lambda^0, \lambda^1, \dots, \lambda^{2n})$  such that

$$-|\lambda^{2i-2}| + 2|\lambda^{2i-1}| - |\lambda^{2i}| = \begin{cases} m_i \text{ or } m_i - 1 & \text{if } i \notin M, \\ m_i \text{ or } m_i + 1 & \text{if } i \in M. \end{cases}$$

Given  $T$  and  $i$ , if  $\lambda_1^{2i-1} = w + 1$ , then there are two cases  $i \notin M$  or  $i \in M$ . These two cases are canceled each other when  $-|\lambda^{2i-2}| + 2|\lambda^{2i-1}| - |\lambda^{2i}| = m_i$ . Thus, we only need to consider the case that  $-|\lambda^{2i-2}| + 2|\lambda^{2i-1}| - |\lambda^{2i}| \in \{m_i + 1, m_i - 1\}$  when  $\lambda_1^{2i-1} = w + 1$ . If  $\lambda_1^{2i-1} \leq w$ , then we always have  $i \notin M$ , and there are two cases  $-|\lambda^{2i-2}| + 2|\lambda^{2i-1}| - |\lambda^{2i}| \in \{m_i, m_i - 1\}$ . Moreover, the case that  $-|\lambda^{2i-2}| + 2|\lambda^{2i-1}| - |\lambda^{2i}| = m_i + 1$  with  $\lambda_1^{2i-1} = w + 1$  is canceled with the case  $-|\lambda^{2i-2}| + 2|\lambda^{2i-1}| - |\lambda^{2i}| = m_i - 1$  with  $\lambda_1^{2i-2} = \lambda_1^{2i-1} = \lambda_1^{2i} = w$ . Therefore we obtain the corollary.  $\square$

**Corollary 6.12.** *The coefficient of  $x_1^{m_1} x_2^{m_2} \cdots x_n^{m_n}$  in*

$$\det_{1 \leq i, j \leq h} (\overline{F}_{-i+j, 2h+2w+1}(\mathbf{x}) + \overline{F}_{i+j-1, 2h+2w+1}(\mathbf{x}))$$

*equals the number of  $(h, w)$ -up-down tableaux  $(\lambda^0, \lambda^1, \dots, \lambda^{2n})$  that satisfy the following properties for  $i = 1, 2, \dots, n$ :*

$$-|\lambda^{2i-2}| + 2|\lambda^{2i-1}| - |\lambda^{2i}| = \begin{cases} m_i & \text{if } \lambda_h^{2i-1} \geq 1, \\ m_i \text{ or } m_i - 1 & \text{if } \lambda_h^{2i-1} = 0. \end{cases}$$

*Proof.* This is an immediate consequence of (6.16).  $\square$

**Corollary 6.13.** *The coefficient of  $x_1^{m_1} x_2^{m_2} \cdots x_n^{m_n}$  in*

$$\det_{1 \leq i, j \leq h} (\overline{F}_{-i+j, 2h+2w}(\mathbf{x}) + \overline{F}_{i+j-1, 2h+2w}(\mathbf{x}))$$

*equals  $A - B$ , where  $A$  (resp.  $B$ ) is the number of  $(h, w)$ -up-down tableaux  $(\lambda^0, \lambda^1, \dots, \lambda^{2n})$  that satisfy the following properties:*

(i) *for  $i = 1, 2, \dots, n$ ,*

$$-|\lambda^{2i-2}| + 2|\lambda^{2i-1}| - |\lambda^{2i}| = \begin{cases} m_i & \text{if } \lambda_h^{2i-1} \neq 0 \text{ and } \lambda_1^{2i-1} \neq w + 1, \\ m_i \text{ or } m_i + 1 & \text{if } \lambda_h^{2i-1} \neq 0 \text{ and } \lambda_1^{2i-1} = w + 1, \\ m_i \text{ or } m_i - 1 & \text{if } \lambda_h^{2i-1} = 0 \text{ and } \lambda_1^{2i-1} \neq w + 1, \\ m_i - 1 \text{ or } m_i + 1 & \text{if } \lambda_h^{2i-1} = 0 \text{ and } \lambda_1^{2i-1} = w + 1; \end{cases}$$

(ii) *there are an even (resp. odd) number of integers  $i = 1, 2, \dots, n$  satisfying  $-|\lambda^{2i-2}| + 2|\lambda^{2i-1}| - |\lambda^{2i}| = m_i + 1$ .*

*Proof.* By (6.17), the coefficient in question is equal to  $\sum_{(T, M_1, M_2) \in X} (-1)^{|M_2|}$ , where  $X$  is the set of  $(T, M_1, M_2) \in \text{UD}_n(h^*, w^*)$  with  $T = (\lambda^0, \lambda^1, \dots, \lambda^{2n})$  such that

$$-|\lambda^{2i-2}| + 2|\lambda^{2i-1}| - |\lambda^{2i}| = \begin{cases} m_i & \text{if } i \notin M_1 \text{ and } i \notin M_2, \\ m_i + 1 & \text{if } i \notin M_1 \text{ and } i \in M_2, \\ m_i - 1 & \text{if } i \in M_1 \text{ and } i \notin M_2, \\ m_i & \text{if } i \in M_1 \text{ and } i \in M_2. \end{cases}$$

Now fix  $T$  and  $i$  and consider the following four cases. For brevity let  $L = -|\lambda^{2i-2}| + 2|\lambda^{2i-1}| - |\lambda^{2i}|$ .

- (1) If  $\lambda_h^{2i-1} \neq 0$  and  $\lambda_1^{2i-1} \neq w + 1$ , then  $i \notin M_1$  and  $i \notin M_2$ . Thus  $L = m_i$ .
- (2) If  $\lambda_h^{2i-1} \neq 0$  and  $\lambda_1^{2i-1} = w + 1$ , then  $i \notin M_1$  and ( $i \notin M_2$  or  $i \in M_2$ ). Thus  $L \in \{m_i, m_i + 1\}$ .
- (3) If  $\lambda_h^{2i-1} = 0$  and  $\lambda_1^{2i-1} \neq w + 1$ , then ( $i \notin M_1$  or  $i \in M_1$ ) and  $i \notin M_2$ . Thus  $L \in \{m_i, m_i - 1\}$ .
- (4) If  $\lambda_h^{2i-1} = 0$  and  $\lambda_1^{2i-1} = w + 1$ , then ( $i \notin M_1$  or  $i \in M_1$ ) and ( $i \notin M_2$  or  $i \in M_2$ ). Thus  $L \in \{m_i - 1, m_i, m_i + 1\}$ . The case  $L = m_i$  occurs twice when ( $i \notin M_1$  or  $i \in M_2$ ) and ( $i \in M_1$  or  $i \in M_2$ ), which are canceled each other. Therefore we only need to consider the cases  $L \in \{m_i - 1, m_i + 1\}$ .

Therefore we obtain the corollary.  $\square$

## 7. CYLINDRIC STANDARD YOUNG TABLEAUX AND NONCROSSING AND NONNESTING MATCHINGS

In this section we present combinatorial results derived from the affine Gordon–Bender–Knuth identities (Theorem 1.5). We first need to define vacillating tableaux.

**Definition 7.1.** An  $(h, w)$ -vacillating tableau is a sequence  $(\lambda^0, \lambda^1, \dots, \lambda^n)$  of partitions that satisfies the following conditions

- (i)  $\lambda^0 = \lambda^n = \emptyset$ ;
- (ii) the partitions  $\lambda^{i-1}$  and  $\lambda^i$  differ by at most one cell,  $i = 1, 2, \dots, n$ ;
- (iii) each  $\lambda^i$  has at most  $h$  rows and at most  $w$  columns,  $i = 1, 2, \dots, n$ .

Let  $\text{VT}_n(h, w)$  denote the set of  $(h, w)$ -vacillating tableaux  $(\lambda^0, \lambda^1, \dots, \lambda^n)$ .

Suppose  $T = (\lambda^0, \lambda^1, \dots, \lambda^n) \in \text{VT}_n(h, w)$ . Then we can identify each  $\lambda^i$  as an  $h$ -tuple of integers, which is an element in  $\mathbb{Z}^h$ . Using this identification we will also consider  $T$  as a walk of length  $n$  from  $\mathbf{0}$  to  $\mathbf{0}$  consisting of steps in  $\{\pm \varepsilon_i : i \in [h]\} \cup \{\mathbf{0}\}$  staying in the region

$$(7.1) \quad \{(x_1, \dots, x_h) \in \mathbb{Z}^h : w \geq x_1 \geq \dots \geq x_h \geq 0\}.$$

We define  $\text{VT}_n(h, w^*)$  (resp.  $\text{VT}_n(h^*, w)$ ) to be the set of walks in  $\text{VT}_n(h, w)$  such that a zero step can never (resp. only) occur on the hyperplane  $x_1 = w$  (resp.  $x_h = 0$ ). We also define  $\text{VT}'_n(h, w)$  to be the set of walks in  $\text{VT}_n(h, w)$  such that a zero step can only occur on the hyperplane  $x_h = 0$  or  $x_1 = w$  but not both. For  $p \in \text{VT}'_n(h, w)$ , let  $z(p)$  denote the number of zero steps on the hyperplane  $x_1 = w$ .

Taking the coefficients of  $x_1 x_2 \cdots x_n$  in both sides of the affine Gordon–Bender–Knuth identities gives the following corollary.

**Corollary 7.2.** For positive integers  $h, w$  and  $n$ , we have

$$(7.2) \quad |\text{CSYT}_n(2h + 1, 2w + 1)| = |\text{VT}_n(h, w)|,$$

$$(7.3) \quad |\text{CSYT}_n(2h + 1, 2w)| = |\text{VT}_n(h, w^*)|,$$

$$(7.4) \quad |\text{CSYT}_n(2h, 2w + 1)| = |\text{VT}_n(h^*, w)|,$$

$$(7.5) \quad |\text{CSYT}_n(2h, 2w)| = \sum_{T \in \text{VT}'_n(h, w)} (-1)^{z(T)}.$$

*Proof.* For the first identity (7.2), we take the coefficients of  $x_1 x_2 \cdots x_n$  in both sides of (1.11) with  $w$  replaced by  $2w + 1$ . By Proposition 2.8, the coefficient from the left-hand side is  $|\text{CSYT}_n(2h + 1, 2w + 1)|$ . By Corollary 6.6, the coefficient from the right-hand side is equal to the number of  $(h, w)$ -up-down tableaux  $(\lambda^0, \lambda^1, \dots, \lambda^{2n})$  such that each subsequence  $\lambda^{2i-2} \subseteq \lambda^{2i-1} \supseteq \lambda^{2i}$  satisfies one of the following:

- (1)  $\lambda^{2i-2}$  and  $\lambda^{2i}$  differ by one cell and  $\lambda^{2i-1} = \lambda^{2i-2} \cup \lambda^{2i}$  (in other words,  $\lambda^{2i-1}$  is the larger partition between  $\lambda^{2i-2}$  and  $\lambda^{2i}$ );
- (2)  $\lambda^{2i-2} = \lambda^{2i-1} = \lambda^{2i}$ .

At this point, we see that the odd-indexed partitions  $\lambda^{2i-1}$  are redundant. If we suppress them, then the sequence  $(\lambda^0, \lambda^2, \dots, \lambda^{2n})$  is an  $(h, w)$ -vacillating tableau. Thus the coefficient is equal to  $|\text{VT}_n(h, w)|$ , and we obtain (7.2).

For the identity (7.3), consider the coefficient of  $x_1 x_2 \cdots x_n$  in the right-hand side of (1.11) with  $w$  replaced by  $2w$ . By Corollary 6.11, this is equal to the number of  $(h, w)$ -up-down tableaux  $(\lambda^0, \lambda^1, \dots, \lambda^{2n})$  such that each subsequence  $\lambda^{2i-2} \subseteq \lambda^{2i-1} \supseteq \lambda^{2i}$  satisfies one of the following:

- (1)  $\lambda_1^{2i-1} \leq w$ , not  $\lambda_1^{2i-2} = \lambda_1^{2i-1} = \lambda_1^{2i} = w$ ,  $\lambda^{2i-2}$  and  $\lambda^{2i}$  differ by one cell, and  $\lambda^{2i-1} = \lambda^{2i-2} \cup \lambda^{2i}$ ;
- (2)  $\lambda_1^{2i-1} < w$  and  $\lambda^{2i-1} = \lambda^{2i-1} = \lambda^{2i}$ ;
- (3)  $\lambda_1^{2i-2} = \lambda_1^{2i-1} = \lambda_1^{2i} = w$  and  $\lambda^{2i-2}$  and  $\lambda^{2i}$  differ by one cell, and  $\lambda^{2i-1} = \lambda^{2i-2} \cup \lambda^{2i}$ ;

$$(4) \lambda_1^{2i-1} = w + 1 \text{ and } \lambda^{2i-2} = \lambda^{2i-1} = \lambda^{2i}.$$

In fact, case (4) never happens. Since the remaining cases give  $(\lambda^0, \lambda^2, \dots, \lambda^{2n}) \in \text{VT}_n(h, w^*)$ , we obtain (7.3). The third identity (7.4) can be proved similarly.

Finally, for the identity (7.5), we need some additional arguments. Consider the coefficient of  $x_1 x_2 \cdots x_n$  in the right-hand side of (1.12) with  $w$  replaced by  $2w$ . By Corollary 6.13, this is equal to  $A - B$ , where  $A$  (resp.  $B$ ) is the number of  $(h, w)$ -up-down tableaux  $(\lambda^0, \lambda^1, \dots, \lambda^{2n})$  such that each subsequence  $\lambda^{2i-2} \subseteq \lambda^{2i-1} \supseteq \lambda^{2i}$  satisfies one of the following:

- (1)  $\lambda_h^{2i-1} \neq 0$ ,  $\lambda_1^{2i-1} \neq w + 1$ ,  $\lambda^{2i-2}$  and  $\lambda^{2i}$  differ by one cell, and  $\lambda^{2i-1} = \lambda^{2i-2} \cup \lambda^{2i}$ ;
- (2)  $\lambda_h^{2i-1} \neq 0$ ,  $\lambda_1^{2i-1} = w + 1$ ,  $\lambda^{2i-2}$  and  $\lambda^{2i}$  differ by one cell, and  $\lambda^{2i-1} = \lambda^{2i-2} \cup \lambda^{2i}$ ;
- (3)  $\lambda_h^{2i-1} \neq 0$ ,  $\lambda_1^{2i-1} = w + 1$ , and  $\lambda^{2i-2} = \lambda^{2i}$  is obtained from  $\lambda^{2i-1}$  by deleting one cell in the first row;
- (4)  $\lambda_h^{2i-1} = 0$ ,  $\lambda_1^{2i-1} \neq w + 1$ ,  $\lambda^{2i-2}$  and  $\lambda^{2i}$  differ by one cell, and  $\lambda^{2i-1} = \lambda^{2i-2} \cup \lambda^{2i}$ ;
- (5)  $\lambda_h^{2i-1} = 0$ ,  $\lambda_1^{2i-1} \neq w + 1$ , and  $\lambda^{2i-2} = \lambda^{2i-1} = \lambda^{2i}$ ;
- (6)  $\lambda_h^{2i-1} = 0$ ,  $\lambda_1^{2i-1} = w + 1$ , and  $\lambda^{2i-2} = \lambda^{2i}$  is obtained from  $\lambda^{2i-1}$  by deleting one cell in the first row;
- (7)  $\lambda_h^{2i-1} = 0$ ,  $\lambda_1^{2i-1} = w + 1$ , and  $\lambda^{2i-2} = \lambda^{2i-1} = \lambda^{2i}$ ,

where the total number of occurrences of cases (3) and (6) is even (resp. odd). As before, cases (2) and (7) never happen because  $\lambda_1^{2i-2}, \lambda_1^{2i} \leq w$ . Case (5) with  $\lambda_1^{2i-1} = w$  is canceled with case (6). The remaining cases give  $(\lambda^0, \lambda^2, \dots, \lambda^{2n}) \in \text{VT}'_n(h, w)$ . More precisely, cases (1) and (4) correspond to the case that  $\lambda^{2i-2}$  and  $\lambda^{2i}$  differ by one cell, case (3) corresponds to the case that  $\lambda^{2i-2} = \lambda^{2i}$  with  $\lambda_h^{2i} \neq 0$  and  $\lambda_1^{2i} = w$ , and case (5) with  $\lambda_1^{2i-1} \leq w - 1$  corresponds to the case that  $\lambda^{2i-2} = \lambda^{2i}$  with  $\lambda_h^{2i} = 0$  and  $\lambda_1^{2i} \neq w$ . Thus  $A - B$  is equal to the right-hand side of (7.5), which completes the proof.  $\square$

Vacillating tableaux are closely related to matchings. To see the connection we need the following definition.

**Definition 7.3.** Let  $k$  be a positive integer. A  $(k + 1/2)$ -crossing is a set of  $k$  arcs  $(i_1, j_1), \dots, (i_k, j_k)$  and a fixed point  $s$  such that  $i_1 < \cdots < i_k < s < j_1 < \cdots < j_k$ . A  $(k + 1/2)$ -nesting is a set of  $k$  arcs  $(i_1, j_1), \dots, (i_k, j_k)$  and a fixed point  $s$  such that  $i_1 < \cdots < i_k < s < j_k < \cdots < j_1$ . We say that a matching is  $(k + 1/2)$ -noncrossing (resp.  $(k + 1/2)$ -nonnesting) if it does not have any  $t$ -crossing (resp.  $t$ -nesting) for  $t \geq k + 1/2$ .

Note that a matching is  $(k + 1/2)$ -noncrossing if and only if it has neither a  $(k + 1/2)$ -noncrossing nor a  $(k + 1)$ -noncrossing.

For an integer  $n$  and integers or half-integers  $r$  and  $s$ , we denote by  $\text{NCNN}_n(r, s)$  the set of  $r$ -noncrossing and  $s$ -nonnesting matchings on  $[n]$ .

**Definition 7.4.** Define  $\text{NCNN}'_n(h + 1, w + 1)$  to be the set of matchings in  $\text{NCNN}_n(h + 1, w + 1)$  in which every fixed point  $v$  satisfies one of the following conditions:

- $v$  is not contained in any  $(h + 1/2)$ -crossing and any  $(w + 1/2)$ -nesting,
- $v$  is contained in both an  $(h + 1/2)$ -crossing and a  $(w + 1/2)$ -nesting.

For  $M \in \text{NCNN}'_n(h + 1, w + 1)$ , let  $z(M)$  be the number of fixed points in  $M$  that are contained in both an  $(h + 1/2)$ -crossing and a  $(w + 1/2)$ -nesting.

The following lemma gives a connection between  $\text{NCNN}_n(h + 1, w + 1)$  and  $\text{VT}_n(h, w)$ .

**Lemma 7.5.** Let  $h, w$  and  $n$  be positive integers. There is a bijection  $\phi : \text{NCNN}_n(h + 1, w + 1) \rightarrow \text{VT}_n(h, w)$  such that if  $\phi(M) = T = (\lambda^0, \lambda^1, \dots, \lambda^n)$ , then the following hold:

- $i$  is a fixed point of  $M$  if and only if the  $i$ -th step of  $T$  is a zero step, i.e.,  $\lambda^{i-1} = \lambda^i$ ,
- $i$  is a fixed point of  $M$  contained in an  $(h + 1/2)$ -crossing if and only if the  $i$ -th step of  $T$  is a zero step not on the hyperplane  $x_h = 0$ , i.e.,  $\lambda^{i-1} = \lambda^i$  and  $\lambda_h^i > 0$ ,

- $i$  is a fixed point of  $M$  contained in a  $(w + 1/2)$ -nesting if and only if the  $i$ -th step of  $T$  is a zero step on the hyperplane  $x_1 = w$ , i.e.,  $\lambda^{i-1} = \lambda^i$  and  $\lambda_1^i = w$ .

*Proof.* Consider the bijection due to Chen et al. [3, Section 5] between complete matchings and oscillating tableaux, which are vacillating tableaux without zero steps. We can extend this map to partial matchings and vacillating tableaux by doing nothing when we encounter a fixed point. It is straightforward to check that this bijection satisfies the given conditions.  $\square$

*Example 7.6.* Let  $n = 3$ ,  $h = 1$ , and  $w = 1$ . Then  $\text{NCNN}_n(h + 1, w + 1/2) = \text{NCNN}_n(h + 1/2, w + 1)$  has three elements, namely,  $\emptyset$ ,  $\{(1, 2)\}$ ,  $\{(2, 3)\}$ , where we only consider the arcs and omit the fixed points. Here,  $\{(1, 3)\}$  is the only forbidden matching. The corresponding lattice paths of length 3 in  $\{1 \geq x_1 \geq 0\}$  are  $(0, 0, 0, 0)$ ,  $(0, 1, 0, 0)$ , and  $(0, 0, 1, 0)$ . Note that  $(0, 1, 1, 0)$  is not allowed because a zero step is used when  $x_1 = 1$ .

The following proposition is an immediate consequence of Lemma 7.5.

**Proposition 7.7.** *We have*

$$(7.6) \quad |\text{NCNN}_n(h + 1, w + 1)| = |\text{VT}_n(h, w)|,$$

$$(7.7) \quad |\text{NCNN}_n(h + 1, w + 1/2)| = |\text{VT}_n(h, w^*)|,$$

$$(7.8) \quad |\text{NCNN}_n(h + 1/2, w + 1)| = |\text{VT}_n(h^*, w)|,$$

$$(7.9) \quad \sum_{M \in \text{NCNN}'_n(h+1, w+1)} (-1)^{z(M)} = \sum_{T \in \text{VT}'_n(h, w)} (-1)^{z(T)}.$$

By Corollary 7.2 and Proposition 7.7, we obtain the following corollary.

**Corollary 7.8.** *For positive integers  $h, w$  and  $n$ , we have*

$$(7.10) \quad |\text{CSYT}_n(2h + 1, 2w + 1)| = |\text{NCNN}_n(h + 1, w + 1)|,$$

$$(7.11) \quad |\text{CSYT}_n(2h + 1, 2w)| = |\text{NCNN}_n(h + 1, w + 1/2)|,$$

$$(7.12) \quad |\text{CSYT}_n(2h, 2w + 1)| = |\text{NCNN}_n(h + 1/2, w + 1)|,$$

$$(7.13) \quad |\text{CSYT}_n(2h, 2w)| = \sum_{M \in \text{NCNN}'_n(h+1, w+1)} (-1)^{z(M)}.$$

In the next section we will show that (7.10) and (7.11) reduce to Mortimer and Prellberg's result [23] if  $h = 1$ . We will also give a bijective proof of (7.12) and (7.13) for  $h = 1$ . Find a bijective proof for the general case would be very interesting.

**Problem 7.9.** Find a bijective proof of Corollary 7.8 for general  $h$  and  $w$ .

Recall the modified Bessel function  $I_r(x)$  given in (1.7). We define its affine analogs as follows:

$$I_{r,N}(x) = \sum_{k \in \mathbb{Z}} I_{r+Nk}(x) = \sum_{k \in \mathbb{Z}} \sum_{\ell \geq 0} \frac{(x/2)^{2\ell + |r+Nk|}}{\ell! (\ell + |r+Nk|)!},$$

$$\bar{I}_{r,N}(x) = \sum_{k \in \mathbb{Z}} (-1)^k I_{r+Nk}(x) = \sum_{k \in \mathbb{Z}} (-1)^k \sum_{\ell \geq 0} \frac{(x/2)^{2\ell + |r+Nk|}}{\ell! (\ell + |r+Nk|)!}.$$

The following corollary of Theorem 1.5 is an affine version of the Gessel identities (1.5) and (1.6).

**Corollary 7.10.** *We have*

$$(7.14) \quad \sum_{n \geq 0} |\text{CSYT}_n(2h + 1, w)| \frac{x^n}{n!} = \exp(x) \det_{1 \leq i, j \leq h} (I_{-i+j, 2h+w+1}(2x) - I_{i+j, 2h+w+1}(2x)),$$

$$(7.15) \quad \sum_{n \geq 0} |\text{CSYT}_n(2h, w)| \frac{x^n}{n!} = \det_{1 \leq i, j \leq h} (\bar{I}_{-i+j, 2h+w}(2x) + \bar{I}_{i+j-1, 2h+w}(2x)).$$

*Proof.* By Proposition 2.8, equating the coefficients of  $x_1 \cdots x_n$  in Theorem 1.5 gives the corollary.  $\square$

*Remark 7.11.* By (7.2) and (7.14), we obtain a formula for the generating function for  $(h, w)$ -vacillating tableaux. As explained at the beginning of this section, these objects are lattice walks in the region (7.1), which is a dilated alcove of type  $\tilde{C}_h$ . Enumeration of lattice walks in an alcove has been studied by Gessel and Zeilberger [12] and Grabiner [15, Theorem 3.1]. The identity (7.14) (using  $|\text{VT}_n(h, w)|$ ) with  $w$  replaced by  $2w + 1$  can also be obtained from their results.

*Remark 7.12.* Corollaries 7.8 and 7.10 give a formula for the generating function for  $|\text{NCNN}_n(r, s)|$  except for the case  $r = h + 1/2$  and  $s = w + 1/2$ . It would be interesting to find a formula for the generating function for  $|\text{NCNN}_n(h + 1/2, w + 1/2)|$ .

## 8. MORTIMER AND PRELLBERG'S RESULT AND BIJECTIVE PROOFS

In this section we consider the special case  $h = 1$  of Corollary 7.8. We show that if  $h = 1$  then the first two identities (7.10) and (7.11) are equivalent to a result of Mortimer and Prellberg [23] whose bijective proof has been given by Courtiel, Elvey Price, and Marcovici [5]. We then give a bijective proof of the last two identities (7.12) and (7.13) for  $h = 1$ .

Recall  $T_n(m)$  and  $\text{Mot}_n(h)$  defined in Definitions 2.10 and 2.11. We consider the following three subsets of  $\text{Mot}_n(w)$ :

$$\text{Mot}'_n(w) = \{p \in \text{Mot}_n(w) : p \text{ has no horizontal step on the line } x_2 = w\},$$

$$\text{Mot}^1_n(w) = \{p \in \text{Mot}_n(w) : \text{every horizontal step of } p \text{ lies on the line } x_2 = 0\},$$

$$\text{Mot}^2_n(w) = \{p \in \text{Mot}_n(w) : \text{every horizontal step of } p \text{ lies on the line } x_2 = 0 \text{ or } x_2 = w\}.$$

A Motzkin path without horizontal steps is called a *Dyck path*. A *Dyck prefix* is a sequence of points that can be extended to a Dyck path. Let  $\text{DP}_n(w)$  denote the set of Dyck prefixes of length  $n$  contained in the region  $\{(x_1, x_2) \in \mathbb{R}^2 : 0 \leq x_2 \leq w\}$ . We now give an equivalent statement of Corollary 7.8 for  $h = 1$ .

**Theorem 8.1.** *For positive integers  $w$  and  $n$ ,*

$$(8.1) \quad |T_n(2w + 1)| = |\text{Mot}_n(w)|,$$

$$(8.2) \quad |T_n(2w)| = |\text{Mot}'_n(w)|,$$

$$(8.3) \quad |\text{DP}_n(2w + 1)| = |\text{Mot}^1_n(w)|,$$

$$(8.4) \quad |\text{DP}_n(2w)| = \sum_{p \in \text{Mot}^2_n(w)} (-1)^{k(p)},$$

where  $k(p)$  is the number of horizontal steps of  $p$  on the line  $x_2 = w$ .

*Proof.* First, we give a bijection from  $\text{SYT}_n(3, w)$  to  $T_n(w)$ . Let  $T \in \text{SYT}_n(3, w)$ . Then the corresponding path  $p = (p_0, \dots, p_n) \in T_n(w)$  is constructed as follows. Let  $p_0 = (0, 0)$ . For  $i \in [n]$ , define  $p_i$  by

$$p_i = \begin{cases} p_{i-1} + (1, 0) & \text{if } i \text{ is in the first row of } T, \\ p_{i-1} + (0, 1) & \text{if } i \text{ is in the second row of } T, \\ p_{i-1} + (-1, -1) & \text{if } i \text{ is in the third row of } T. \end{cases}$$

It is easy to check that the map  $T \mapsto p$  is a bijection from  $\text{SYT}_n(3, w)$  to  $T_n(w)$ .

Second, we give a bijection from  $\text{SYT}_n(2, w)$  to  $\text{DP}_n(w)$  in a similar way. For  $T \in \text{SYT}_n(2, w)$ , the corresponding path  $p = (p_0, \dots, p_n) \in \text{DP}_n(w)$  is defined by  $p_0 = (0, 0)$  and

$$p_i = \begin{cases} p_{i-1} + (1, 1) & \text{if } i \text{ is in the first row of } T, \\ p_{i-1} + (1, -1) & \text{if } i \text{ is in the second row of } T, \end{cases}$$

for  $i \in [n]$ . It is also easy to check that the map  $T \mapsto p$  is a bijection  $\text{SYT}_n(2, w)$  to  $\text{DP}_n(w)$ .

Third, we find a bijection from  $\text{NCNN}_n(2, w + 1)$  to  $\text{Mot}_n(w)$ . This is in fact a well-known bijection from noncrossing matchings to Motzkin paths. Let  $M \in \text{NCNN}_n(2, w + 1)$ . Recall that  $i$  is a fixed point of  $M$  if  $i$  is not connected to any integer by an arc. An integer  $i \in [n]$  is called an *opener* (resp. *closer*) of  $M$  if it is connected to  $j$  by an arc for some  $j > i$  (resp.  $j < i$ ). Since  $M$  does not have any 2-crossings, it is determined by its openers, closers, and fixed points. Therefore we can construct the corresponding Motzkin path  $p = (p_0, \dots, p_n)$  as follows. Let  $p_0 = (0, 0)$  and for  $i \in [n]$  define

$$p_i = \begin{cases} p_{i-1} + (1, 1) & \text{if } i \text{ is an opener of } M, \\ p_{i-1} + (1, -1) & \text{if } i \text{ is a closer of } M, \\ p_{i-1} + (1, 0) & \text{if } i \text{ is a fixed point of } M. \end{cases}$$

Since  $M$  does not have a  $(w + 1)$ -nesting, the Motzkin path  $p$  stays in the region  $\{(x_1, x_2) \in \mathbb{R}^2 : 0 \leq x_2 \leq w\}$ . One can easily check that the map  $M \mapsto p$  is a bijection from  $\text{NCNN}_n(2, w + 1)$  to  $\text{Mot}_n(w)$ .

Similarly one can check that the same map  $M \mapsto p$  also induces a bijection from  $\text{NCNN}_n(2, w + 1/2)$  to  $\text{Mot}'_n(w)$ , a bijection from  $\text{NCNN}_n(1 + 1/2, w + 1)$  to  $\text{Mot}^1_n(w)$  and a bijection from  $\text{NCNN}'_n(2, w + 1)$  to  $\text{Mot}^2_n(w)$ . Moreover, if  $M \in \text{NCNN}'_n(2, w + 1)$  corresponds to  $p \in \text{Mot}^2_n(w)$ , then  $z(M) = k(p)$ .

Applying the above bijections to Corollary 7.8 with  $h = 1$ , we immediately obtain the desired identities.  $\square$

The identities (8.1) and (8.2) were first proved by Mortimer and Prellberg [23] using the kernel method. Recently, Courtiel, Elvey Price, and Marcovici [5] found a bijective proof of these two identities. For the rest of this section we give a bijective proof of (8.3) and (8.4). To simplify the right side of (8.4), we need the following definition and lemma.

**Definition 8.2.** For  $p = (p_0, p_1, \dots, p_n) \in \text{Mot}^2_n(w)$ , a horizontal step  $p_{j+1} - p_j$  is called *special* if one of the following conditions holds:

- $p_{j+1} - p_j$  lies on the line  $x_2 = w$ ,
- $p_{j+1} - p_j$  lies on the line  $x_2 = 0$ ,  $(p_0, p_1, \dots, p_j) \in \text{Mot}^1_j(w)$  with even number of horizontal steps, and there is an integer  $i$  with  $j < i < n$  such that  $(p_{j+1}, p_{j+2}, \dots, p_{i+1})$  is a (translated) Dyck prefix from  $(j + 1, 0)$  to  $(i + 1, w)$ .

We define

$$\text{Mot}^3_n(w) = \{p \in \text{Mot}^2_n(w) : p \text{ has no special horizontal step}\}$$

so that  $\text{Mot}^3_n(w) \subseteq \text{Mot}^1_n(w)$ .

**Lemma 8.3.** For positive integers  $w$  and  $n$ ,

$$|\text{Mot}^3_n(w)| = \sum_{p \in \text{Mot}^2_n(w)} (-1)^{k(p)},$$

where  $k(p)$  is the number of horizontal steps of  $p$  on the line  $x_2 = w$ .

*Proof.* For  $p \in \text{Mot}^2_n(w)$ , we define  $\text{sgn}(p) = (-1)^{k(p)}$ . It suffices to find a sign-reversing involution  $\phi$  on  $\text{Mot}^2_n(w)$  whose fixed points are exactly those in  $\text{Mot}^3_n(w)$ .

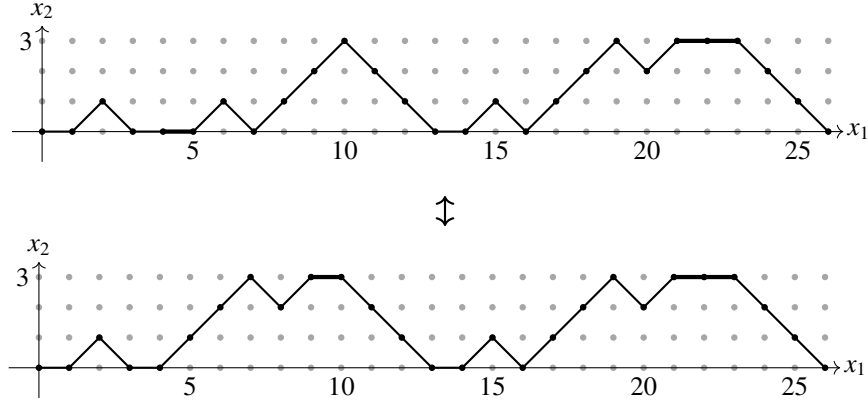

FIGURE 10. An example of the involution  $\phi$  on  $\text{Mot}_{26}^2(3)$ . The thick horizontal lines indicate the special horizontal steps.

Let  $p \in \text{Mot}_n^2(w)$ . If  $p \in \text{Mot}_n^3(w)$ , then define  $\phi(p) = p$ . Otherwise, we can find the smallest integer  $j$  with  $0 \leq j < n$  such that  $p_{j+1} - p_j$  is special. Suppose that the first special horizontal step  $p_{j+1} - p_j$  lies on the line  $x_2 = w$ . Then we can find the largest integer  $i$  with  $0 \leq i < j$  such that  $(p_i, p_{i+1}, \dots, p_j)$  is a (translated) Dyck prefix. Define  $\phi(p) = (p_0, \dots, p_i, r(p_j), r(p_{j-1}), \dots, r(p_{i+1}), p_{j+1}, \dots, p_n)$ , where  $r$  is the reflection about the point  $((j-i+1)/2, w/2)$ . Then  $q = \phi(p)$  has the first special horizontal step  $q_{i+1} - q_i$  on the line  $x_2 = 0$  and  $k(q) = k(p) - 1$ . Now suppose that  $p$  has the first special horizontal step  $p_{j+1} - p_j$  on the line  $x_2 = 0$ . Then  $(p_0, p_1, \dots, p_j) \in \text{Mot}_j^1(w)$  with even number of horizontal steps, and we can find the smallest integer  $i$  with  $j < i < n$  such that  $(p_{j+1}, p_{j+2}, \dots, p_{i+1})$  is a translated Dyck prefix from  $(j+1, 0)$  to  $(i+1, w)$ . Define  $\phi(p) = (p_0, \dots, p_j, r(p_i), r(p_{i-1}), \dots, r(p_{j+1}), p_{i+1}, \dots, p_n)$ , where  $r$  is the reflection about the point  $((i-j+1)/2, w/2)$ . In this case  $q = \phi(p)$  has the first special horizontal step  $q_{i+1} - q_i$  on the line  $x_2 = w$  and  $k(q) = k(p) + 1$ . One can easily check that  $\phi$  is an involution, which completes the proof.  $\square$

Figure 10 shows an example of the involution  $\phi$  defined in the proof of Lemma 8.3.

By Lemma 8.3, the identity (8.4) is equivalent to  $|\text{DP}_n(2w)| = |\text{Mot}_n^3(w)|$ . To prove (8.3) and (8.4), we adopt a bijection from the set of bounded Dyck prefixes to the set of bounded grand Dyck paths due to Dershowitz.

A *grand Dyck path* of length  $n$  is an  $(L, S)$ -walks from  $(0, 0)$  to  $(n, (1 + (-1)^{n+1})/2)$ , where  $L = \mathbb{R}^2$  and  $S = \{(1, 1), (1, -1)\}$ . Let  $\text{GD}_n(w)$  denote the set of grand Dyck paths of length  $n$  staying in the region

$$\left\{ (x_1, x_2) \in \mathbb{R}^2 : -\left\lfloor \frac{w}{2} \right\rfloor \leq x_2 \leq \left\lfloor \frac{w+1}{2} \right\rfloor \right\}.$$

Using the viewpoint of the adjacency matrices of path graphs, Cigler [4] derived that

$$|\text{DP}_n(w)| = |\text{GD}_n(w)| = \sum_{j \in \mathbb{Z}} (-1)^j \binom{n}{\lfloor \frac{n+(w+2)j}{2} \rfloor}.$$

Recently, Gu and Prodinger [17] and Dershowitz [6] found simple bijections between  $\text{DP}_n(w)$  and  $\text{GD}_n(w)$  independently. Here, we briefly introduce Dershowitz's bijection.

Let  $p$  be an  $(L, S)$ -walk from  $(0, 0)$  to  $(n, m)$ , where  $L = \mathbb{R}^2$  and  $S = \{(1, 1), (1, -1)\}$ . For an integer  $k$ , the *TA representation of  $p$  relative to  $k$*  is the word  $r_1 r_2 \cdots r_n$ , where  $r_i$  is the letter  $T$  (resp.  $A$ ) if the  $i$ -th step of  $p$  moves towards (resp. away from) the line  $x_2 = k$ . Note that any  $(L, S)$ -walk (whose starting point is  $(0, 0)$ ) is uniquely determined by its TA representation. Now let  $p \in \text{DP}_n(w)$ . Suppose that  $r_1 r_2 \cdots r_n$  is the TA representation of  $p$  relative to  $\lceil h(p)/2 \rceil - 1/2$ , where  $h(p)$  is the largest  $x_2$ -coordinate of the points in



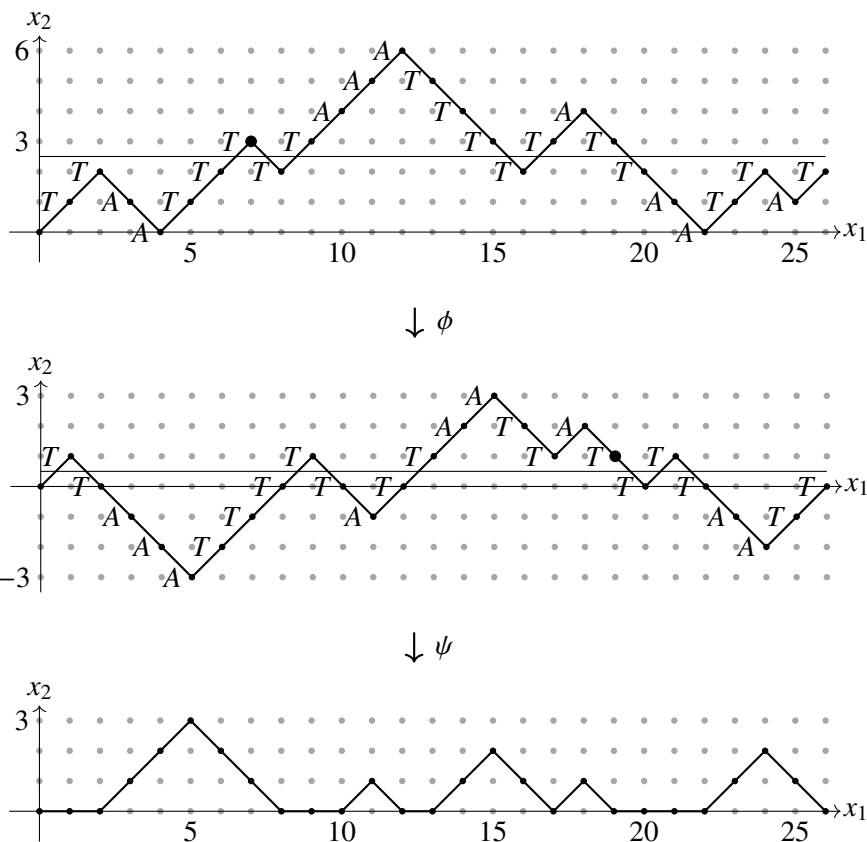

FIGURE 11. An example of the bijection between  $DP_{26}(6)$  and  $Mot_{26}^3(3)$ .

$p$ . Let  $j$  be the smallest integer such that the height of the ending point of the  $j$ -th step of  $p$  equals  $\lfloor h/2 \rfloor$ . Then define  $\phi(p)$  to be the  $(L, S)$ -walk whose  $TA$  representation relative to  $1/2$  is  $r_{j+1}r_{j+2} \cdots r_n r_j r_{j-1} \cdots r_1$ . Dershowitz [6] showed that  $\phi : DP_n(w) \rightarrow GD_n(w)$  is a bijection.

Our last ingredient is a map  $\psi : GD_n(w) \rightarrow Mot_n^1(w)$ . For  $p = (p_0, p_1, \dots, p_n) \in GD_n(w)$ , define  $\psi(p) = (q_0, q_1, \dots, q_n)$ , where

$$q_i = \begin{cases} p_i + (0, -1) & \text{if } p_i \text{ is above the line } x_2 = 1/2, \\ -p_i & \text{otherwise,} \end{cases}$$

for  $i = 0, 1, \dots, n$ . One can easily see that  $\psi : GD_n(2w + 1) \rightarrow Mot_n^1(w)$  and  $\psi : GD_n(2w) \rightarrow Mot_n^3(w)$  are bijections. Combining the maps  $\phi$  and  $\psi$  completes the proof of (8.3) and (8.4). Figure 11 shows examples of the maps  $\phi : DP_{26}(6) \rightarrow GD_{26}(6)$  and  $\psi : GD_{26}(6) \rightarrow Mot_{26}^3(3)$ .

REFERENCES

[1] E. A. Bender and D. E. Knuth. Enumeration of plane partitions. *J. Combinatorial Theory Ser. A*, 13:40–54, 1972.  
 [2] A. Bertram, I. Ciocan-Fontanine, and W. Fulton. Quantum multiplication of Schur polynomials. *J. Algebra*, 219(2):728–746, 1999.  
 [3] W. Y. C. Chen, E. Y. P. Deng, R. R. X. Du, R. P. Stanley, and C. H. Yan. Crossings and nestings of matchings and partitions. *Trans. Amer. Math. Soc.*, 359(4):1555–1575 (electronic), 2007.  
 [4] J. Cigler. Some remarks and conjectures related to lattice paths in strips along the x-axis. *Preprint*, arXiv:1501.04750v6.

- [5] J. Courtiel, A. Elvey Price, and I. Marcovici. Bijections between walks inside a triangular domain and Motzkin paths of bounded amplitude. *Electron. J. Combin.*, 28(2):Paper No. 2.6, 44, 2021.
- [6] N. Dershowitz. Between Broadway and the Hudson: a bijection of corridor paths. *J. Integer Seq.*, 24(2):Art. 21.2.8, 19, 2021.
- [7] S. Elizalde. Walks in simplices, cylindric tableaux, and asymmetric exclusion processes. To appear in *Séminaire Lotharingien de Combinatoire*.
- [8] S.-P. Eu, T.-S. Fu, J. T. Hou, and T.-W. Hsu. Standard Young tableaux and colored Motzkin paths. *J. Combin. Theory Ser. A*, 120(7):1786–1803, 2013.
- [9] M. Filaseta. A new method for solving a class of ballot problems. *J. Combin. Theory Ser. A*, 39(1):102–111, 1985.
- [10] I. M. Gessel. Symmetric functions and P-recursive functions. *J. Combin. Theory Ser. A*, 53(2):257–285, 1990.
- [11] I. M. Gessel and C. Krattenthaler. Cylindric partitions. *Trans. Amer. Math. Soc.*, 349(2):429–479, 1997.
- [12] I. M. Gessel and D. Zeilberger. Random walk in a Weyl chamber. *Proc. Amer. Math. Soc.*, 115(1):27–31, 1992.
- [13] F. M. Goodman and H. Wenzl. Littlewood-Richardson coefficients for Hecke algebras at roots of unity. *Adv. Math.*, 82(2):244–265, 1990.
- [14] B. Gordon. Notes on plane partitions. V. *J. Combinatorial Theory Ser. B*, 11:157–168, 1971.
- [15] D. J. Grabiner. Random walk in an alcove of an affine Weyl group, and non-colliding random walks on an interval. *J. Combin. Theory Ser. A*, 97(2):285–306, 2002.
- [16] D. J. Grabiner and P. Magyar. Random walks in Weyl chambers and the decomposition of tensor powers. *J. Algebraic Combin.*, 2(3):239–260, 1993.
- [17] N. S. S. Gu and H. Prodinger. Combinatorics on lattice paths in strips. *European J. Combin.*, 94:Paper No. 103310, 14, 2021.
- [18] J. E. Humphreys. *Reflection groups and Coxeter groups*, volume 29 of *Cambridge Studies in Advanced Mathematics*. Cambridge University Press, Cambridge, 1990.
- [19] M. Ishikawa and M. Wakayama. Minor summation formula of Pfaffians. *Linear and Multilinear Algebra*, 39(3):285–305, 1995.
- [20] C. Krattenthaler. Oscillating tableaux and nonintersecting lattice paths. *J. Statist. Plann. Inference*, 54(1):75–85, 1996.
- [21] S. J. Lee. Positivity of cylindric skew Schur functions. *J. Combin. Theory Ser. A*, 168:26–49, 2019.
- [22] P. McNamara. Cylindric skew Schur functions. *Adv. Math.*, 205(1):275–312, 2006.
- [23] P. R. G. Mortimer and T. Prellberg. On the number of walks in a triangular domain. *Electron. J. Combin.*, 22(1):Paper 1.64, 15, 2015.
- [24] S. Okada. On the generating functions for certain classes of plane partitions. *J. Combin. Theory Ser. A*, 51(1):1–23, 1989.
- [25] S. Okada. Applications of minor summation formulas to rectangular-shaped representations of classical groups. *J. Algebra*, 205(2):337–367, 1998.
- [26] A. Postnikov. Affine approach to quantum Schubert calculus. *Duke Math. J.*, 128(3):473–509, 2005.
- [27] R. P. Stanley. *Enumerative Combinatorics. Vol. 2*, volume 62 of *Cambridge Studies in Advanced Mathematics*. Cambridge University Press, Cambridge, 1999. With a foreword by Gian-Carlo Rota and appendix 1 by Sergey Fomin.
- [28] J. R. Stembridge. Nonintersecting paths, Pfaffians, and plane partitions. *Adv. Math.*, 83(1):96–131, 1990.
- [29] D. Zeilberger. The number of ways of walking in  $x_1 \geq \dots \geq x_k \geq 0$  for  $n$  days, starting and ending at the origin, where at each day you may either stay in place or move one unit in any direction, equals the number of  $n$ -cell standard Young tableaux with  $\leq 2k + 1$  rows. *The Personal Journal of Shalosh B. Ekhad and Doron Zeilberger*, 2007.

DEPARTMENT OF MATHEMATICS, AJOU UNIVERSITY, SUWON, REPUBLIC OF KOREA

*Email address:* hyunyjia@ajou.ac.kr

DEPARTMENT OF MATHEMATICS, SUNGKYUNKWAN UNIVERSITY, SUWON, REPUBLIC OF KOREA

*Email address:* jangsookim@skku.edu

FAKULTÄT FÜR MATHEMATIK, UNIVERSITÄT WIEN, OSKAR-MORGENSTERN-PLATZ 1, A-1090 VIENNA, AUSTRIA.

*Email address:* Christian.Krattenthaler@univie.ac.at

GRADUATE SCHOOL OF MATHEMATICS, NAGOYA UNIVERSITY, FURO-CHO, CHIKUSA-KU, NAGOYA 464-8602, JAPAN

*Email address:* okada@math.nagoya-u.ac.jp