ON BISIMILARITY FOR QUASI-DISCRETE CLOSURE SPACES

VINCENZO CIANCIA, DIEGO LATELLA, MIEKE MASSINK, AND ERIK P. DE VINK

Istituto di Scienza e Tecnologie dell'Informazione "A. Faedo", Consiglio Nazionale delle Ricerche,
Pisa, Italy
e-mail address: Vincenzo.Ciancia@cnr.it

Istituto di Scienza e Tecnologie dell'Informazione "A. Faedo", Consiglio Nazionale delle Ricerche,
Pisa, Italy
e-mail address: Diego.Latella@cnr.it

Istituto di Scienza e Tecnologie dell'Informazione "A. Faedo", Consiglio Nazionale delle Ricerche,
Pisa, Italy
e-mail address: Mieke.Massink@cnr.it

Department of Mathematics and Computer Science, Eindhoven University of Technology, Eindhoven,
The Netherlands
e-mail address: evink@win.tue.nl

ABSTRACT. Closure spaces, a generalisation of topological spaces, have shown to be a convenient theoretical framework for spatial model checking. The closure operator of closure spaces and quasi-discrete closure spaces induces a notion of neighborhood akin to that of topological spaces that build on open sets. For closure models and quasi-discrete closure models, in this paper we present three notions of bisimilarity that are logically characterised by corresponding modal logics with spatial modalities: (i) CM-bisimilarity for closure models (CMs) is shown to generalise Topo-bisimilarity for topological models. CM-bisimilarity corresponds to equivalence with respect to the infinitary modal logic IML that includes the modality \mathcal{N} for "being near". (ii) CMC-bisimilarity, with CMC standing for CM-bisimilarity *with converse*, refines CM-bisimilarity for quasi-discrete closure spaces, carriers of quasi-discrete closure models. Quasi-discrete closure models come equipped with two closure operators, \vec{C} and \overleftarrow{C} , stemming from the binary relation underlying closure and its converse. CMC-bisimilarity, is captured by the infinitary modal logic IMLC including two modalities, $\vec{\mathcal{N}}$ and $\overleftarrow{\mathcal{N}}$, corresponding to the two closure operators. (iii) CoPa-bisimilarity on quasi-discrete closure models, which is weaker than CMC-bisimilarity, is based on the notion of *compatible paths*. The logical counterpart of CoPa-bisimilarity is the infinitary modal logic ICRL with modalities $\vec{\zeta}$ and $\overleftarrow{\zeta}$ whose semantics relies on forward and backward paths, respectively. It is shown that CoPa-bisimilarity for quasi-discrete closure models relates to divergence-blind stuttering equivalence for Kripke structures.

Key words and phrases: Spatial bisimilarity; Spatial logic; Closure spaces; Quasi-discrete closure spaces; Stuttering equivalence.

The research leading to this publication was partially supported by the MUR Projects PRIN 2017FTXR7S, "IT-MaTTeS", PRIN 2020TL3X8X "T-LADIES", and partially funded by the European Union - Next Generation EU - Italian MUR Project PNRR PRI ECS 00000017 "THE - Tuscany Health Ecosystem".

1. INTRODUCTION

In the well-known topological interpretation of modal logic, a point in space satisfies the formula $\diamond \Phi$ whenever it belongs to the *topological closure* of the set $\llbracket \Phi \rrbracket$ of all the points satisfying formula Φ (see e.g. [BB07]). The approach goes back to Tarski and McKinsey [MT44] who proposed topological spaces and their interior operator as the fundamental basis for reasoning about space. However, the idempotence property of topological closure renders topological spaces to be too restrictive for specific applications. For instance, discrete structures useful for certain representations of space, like general graphs or adjacency graphs, including 2D and 3D images, cannot be captured topologically. To that purpose, a more liberal notion of space, namely that of *closure spaces* (CSs), has been proposed in the literature [Smy95, Gal03]. Closure spaces do not require idempotence of the closure operator (see [Gal03] for an in-depth treatment of the subject).

For an interpretation of modal logic using CSs, [CLLM14, CLLM16] introduced the *Spatial Logic for Closure Spaces* (SLCS) that includes the modality of the surround operator \mathcal{S} . A point x satisfies $\Phi_1 \mathcal{S} \Phi_2$ if it lays in a set $A \subseteq \llbracket \Phi_1 \rrbracket$ while the external border of A consists of points satisfying Φ_2 , i.e. the point x lays in an area satisfying Φ_1 which is surrounded by points satisfying Φ_2 . A model checking algorithm has been proposed in [CLLM14, CLLM16] that has been implemented in the tool `topochecker` [CGG⁺18, CGL⁺15] and, more recently, in `VoxLogicA` [BCLM19b], a tool specialised for spatial model-checking digital images, that can be modelled as *adjacency spaces*, a special case of closure spaces.

The logic and the above mentioned model checkers have been applied to several case studies [CLLM16, CGL⁺15, CGG⁺18] including a declarative approach to medical image analysis [BCLM19b, BCLM19a, BBC⁺20, BBC⁺21]. An encoding of the discrete Region Connection Calculus RCC8D of [RLG13] into the collective variant of SLCS has been proposed in [CLM19]. The logic has also inspired other approaches to spatial reasoning in the context of signal temporal logic and system monitoring [NBBL22, NBC⁺18] and in the verification of cyber-physical systems [TKG17].

A key question, when reasoning about modal logics and their models, is the relationship between logical equivalences and notions of bisimilarity defined on their underlying models. This is important because the existence of such bisimilarities, and their logical characterisation, makes it possible to exploit minimisation procedures for bisimilarity for the purpose of efficient model-checking — and spatial models are notoriously large. For instance, in [CGL⁺23] an encoding of a class of closure spaces into labelled transition systems has been proposed such that two points in space are bisimilar — for an appropriate notion of spatial bisimilarity — if and only if their images in the associated labelled transition system are Branching equivalent. Thus, model-checking a formula of the logic characterising spatial bisimilarity can be safely performed on a model that has been minimised using efficient tools for Branching equivalence.

In the present paper we study three different notions of bisimilarity for closure models (CMs), i.e. models based on CSs, and their associated logics. The first one is *CM-bisimilarity*, that is an adaptation for closure models of classical Topo-bisimilarity for topological models as defined in [BB07]. Actually, CM-bisimilarity is an instantiation to closure models of monotonic bisimulation on neighborhood models [BBEY17, Han03]. In fact, it is defined using the monotonic interior operator of closure models, thus making closure models an instantiation of monotonic neighborhood models. We show that CM-bisimilarity is logically

characterised by an infinitary extension of the modal logic where \diamond is the only modality, that we call Infinitary Modal Logic IML.

We show that, for *quasi-discrete* closure models (QdCMs), i.e. closure models where every point has a minimal neighbourhood, a more intuitive, and simpler, definition of CM-bisimilarity can be given directly in terms of the closure operator — instead of the interior operator. Such a definition is reminiscent of the definition of strong bisimilarity for transition systems. The direct use of the closure operator in the definition of CM-bisimilarity simplifies several proofs.

We then present a refinement of CM-bisimilarity, specialised for *quasi-discrete* closure models. In *quasi-discrete* closure spaces, the closure of a set of points — and also its interior — can be expressed using an underlying binary relation. This gives rise to both a *direct* closure and interior of a set, and a *converse* closure and interior, the latter being obtained using the converse of the binary relation. In turn, this induces a refined notion of bisimilarity, *CM-bisimilarity with converse*, abbreviated as CMC-bisimilarity, which is shown to be strictly stronger than CM-bisimilarity.

It is worth noting that, in the context of space, and in particular when dealing with notions of directionality (e.g. one-way roads, public area gates), it is essential to be able to distinguish between the concept of “reaching” and that of “being reached”. For instance, one might be interested to express the fact that, from a certain location, via a safe corridor, a rescue area can be reached (forward reachability) that cannot be reached by (backward reachability) smoke generated in another area. This kind of situations have no obvious counterpart in the temporal domain, where there can be more than one future, like in the case of branching-time logics, but there is typically only one, fixed past, i.e. the one that has occurred.¹

We also present a closure-based definition for CMC-bisimilarity, originally proposed in [CLMV20], that resembles *Strong Back-and-Forth bisimilarity* proposed by De Nicola, Montanari, and Vaandrager in [DMV90]. In order to capture CMC-bisimilarity logically, we extend IML with the converse of its unary modal operator and show that the resulting logic IMLC characterises CMC-bisimilarity. We recall here that in [CLMV20] a minimisation algorithm for CMC-bisimulation and the related tool `MiniLogicA` have been proposed as well.

CM-bisimilarity and CMC-bisimilarity play an important role as they are counterparts of classical Topo-bisimilarity. On the other hand, they turn out to be rather strong when one has intuitive relations on space in mind like — e.g. reachability, or adjacency, of areas of points with specific features — that may be useful when dealing with models representing images.

Let us consider, as an example, the image of a maze shown in Figure 1a. In the image, walls are represented in black and the exit area, situated at the border of the image, is shown in green; the floor is represented in white. Suppose we want to know whether, starting from a given point in the maze — for instance one of those shown in blue in the picture — one can reach the exit area. In other words, we are interested in those paths in the picture, starting in blue points, leading to green points *passing only* through white points. In [CLMV21] we introduced the notion of spatial Path-bisimilarity. Essentially, two points are Path-bisimilar if (they satisfy the same set of atomic proposition letters and) for every path starting in one of the two points, there is a path starting in the other point such that the end-points of

¹There are a few exceptions to this interpretation of past-tense operators, e.g. [KR97, Sti93].

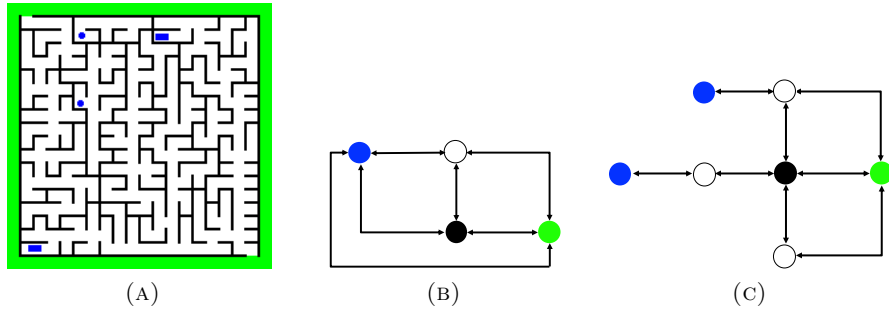

FIGURE 1. A maze (1a), its Path-minimal model (1b), and its CoPa-minimal models (1c). In the maze, there are two exit gates, one at the top-left corner and the other one in the bottom-right corner.

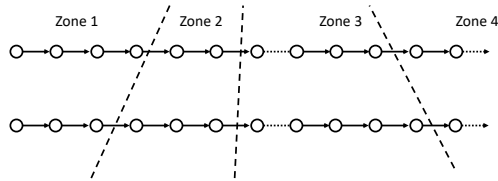

FIGURE 2. Zones of compatible paths.

the two paths are Path-bisimilar. This is illustrated in more detail in Figure 1. Figure 1b shows the minimal model for the maze shown in Figure 1a according to Path-bisimilarity. We see that all blue points are equivalent — they all collapse to a single blue point in the minimal model — and so are all white points. In other words, we are unable to distinguish those blue (white) points from which one can reach an exit from those from which one cannot, due to the (black) walls. This is not satisfactory; as we said before, we would like to differentiate the blue points (also) on the basis of whether they can reach an exit, considering the presence of walls. We are then looking for a notion of equivalence that is not only based on reachability, but also takes the structure of paths into consideration. Reachability should not be unconditional, i.e. the relevant paths should share some common structure. For that purpose, we resort to a notion of “mutual compatibility” between relevant paths that essentially requires each of them to be composed by a sequence of non-empty “zones”. The total number of zones in each of the paths must be the same, while the zones may be of arbitrary (but not zero) length. Each element of one path in a given zone is required to be related by the bisimulation relation to all the elements in the corresponding zone in the other path, as illustrated in Figure 2.

This idea of compatibility of paths gives rise to the third notion of bisimulation, namely *Compatible Path bisimulation*, or CoPa-bisimulation for short, which is strictly stronger than Path-bisimilarity and, for quasi-discrete closure models, strictly weaker than CMC-bisimilarity.

The minimal model, according to CoPa-bisimilarity, for the image of the maze shown in Figure 1a, is shown Figure 1c. It is worth noting that this model distinguishes the blue points from which one can reach green ones passing only by white points from those from which one cannot. Similarly, white points through which an exit can be reached from a blue

point (without passing through a black point) are distinguished both from those that cannot be reached from blue points and from those through which no green point can be reached. Finally, we note that the CoPa-minimal model also shows that there is no white area that does not contain a blue region from which a green exit cannot be reached (i.e. a completely white area surrounded by walls).

We provide a logical characterisation of CoPa-bisimilarity by means of the *Infinitary Compatible Reachability Logic* (ICRL). This logic involves the modalities of forward and backward *conditional* reachability, $\vec{\zeta}$ and $\overleftarrow{\zeta}$. The notion of CoPa-bisimulation is reminiscent of that of Stuttering Equivalence for Kripke Structures, going back to [BCG88], although in a different context and with different definitions as well as underlying notions. We show the coincidence of CoPa-bisimilarity and an adaptation to the QdCMs setting of Divergence-blind Stuttering Equivalence [GJKW17].

The present paper builds upon ideas and notions originally presented by the authors in [CLMV20, CLMV21, CLMV22a]. In particular, this paper contains all the proofs of the results presented in [CLMV22a]. Furthermore, an alternative, more intuitive, definition of CoPa-bisimilarity is proposed that is based on an explicit notion of path compatibility. Finally, several additional results relating our notions with those in the literature are proved as well.

Contributions. Summarising, in this paper we present three notions of bisimilarity that are logically characterised by corresponding modal logics with spatial modalities:

- CM-bisimilarity for closure models (CMs) which generalises Topo-bisimilarity for topological models. CM-bisimilarity corresponds to equivalence with respect to the infinitary modal logic IML that includes the proximity modality \mathcal{N} standing for “being near”.
- CMC-bisimilarity which refines CM-bisimilarity for quasi-discrete closure spaces, carriers of quasi-discrete closure models. CMC-bisimilarity, is captured by the infinitary modal logic IMLC including two proximity modalities, $\vec{\mathcal{N}}$ and $\overleftarrow{\mathcal{N}}$, corresponding to the forward and backward closure operators, respectively.
- CoPa-bisimilarity on quasi-discrete closure models based on the notion of *compatible paths* and which is weaker than CMC-bisimilarity. The logical counterpart of CoPa-bisimilarity is the infinitary modal logic ICRL with conditional reachability modalities $\vec{\zeta}$ and $\overleftarrow{\zeta}$ whose semantics relies on forward and backward paths, respectively. It is shown that CoPa-bisimilarity for quasi-discrete closure models relates to divergence-blind stuttering equivalence for Kripke structures.

Further related work. Our work is also inspired by spatial logics (see [BB07] for an extensive overview), including seminal work dating back to Tarski and McKinsey in the forties of the previous century. The work on *spatial model checking* for logics with reachability originated in [CLLM16], which includes a comparison to the work of Aiello on spatial *until* operators (see e.g. [Aie02]). In [Aie03], Aiello envisaged practical applications of topological logics with *until* to minimisation of images. Recent work in [CGL⁺23] builds on and extends that vision taking CoPa-bisimilarity as a suitable equivalence for spatial minimisation.

In [LPS20, LPS21] the spatial logic SLCS is studied from a model-theoretic perspective. In particular, in [LPS20] the authors are focused on issues of expressivity of SLCS in relation to topological connectedness and separation. In [LPS21] it is shown that the logic admits finite models for a sub-class of neighbourhood models, namely the class of quasi-discrete neighbourhood models, both for topological paths and for quasi-discrete ones — which

consist of an enumeration of points — whereas it does not enjoy the finite model property for general neighbourhood models, regardless of the kind of paths considered.

The work in [BCG⁺22] and in [LQ21] introduces bisimulation relations that characterise spatial logics with reachability in polyhedral models and in simplicial complexes, respectively. It will be interesting future work to apply the minimisation techniques we present here to such relevant classes of models.

Spatial analysis based on QdCMs is also related to work on qualitative reasoning about spatial entities (see [CR08] and references therein), also known as QSR (Qualitative Spatial Reasoning). This is a very active area of research in which the theory of topology and that of closure spaces play a important role. Prominent examples of that area are the region connection calculi (RCC), such as the discrete space variant RCC8D. As mentioned before, an embedding of the latter in the collective variant of SLCS was presented recently in [CLM19]. Such embedding enables the application of spatial model checking of RCC8D via the spatial model checker `VoxLogicA` [BCLM19b].

In [HKP09], coalgebraic bisimilarity is developed for a general kind of models, generalising the topological ones, known as Neighbourhood Frames. At the moment, the notions of path and reachability are not part of the framework (that is, bisimilarity in neighbourhood semantics is based on a one-step relation), thus the results therein, although more general than the theory of CSs, cannot be directly reused in the work we present in this paper.

In the Computer Science literature, other kinds of spatial logics have been proposed that typically describe situations in which modal operators are interpreted *syntactically* against the *structure of agents* in a process calculus. We refer to [CG00, CC03] for some classical examples. Along the same lines, a recent example is given in [TPGN15], concerning model checking of security aspects in cyber-physical systems, in a spatial context based on the idea of bigraphical reactive systems introduced by Milner [Mil09]. A bigraph consists of two graphs: a place graph, i.e. a forest defined over a set of nodes which is intended to represent entities and their locality in terms of a containment structure, and a link graph, a hypergraph composed over the same set of nodes representing arbitrary linking among those entities. The QdCMs that are the topic of the present paper, instead, address space from a topological point of view rather than viewing space as a containment structure for spatial entities.

Structure. The paper is organised as follows: Preliminary notions and definitions can be found in Section 2, while Section 3 is devoted to CM-bisimilarity and the logic IML. Section 4 deals with CMC-bisimulation and the logic IMLC. Next, Section 5 addresses CoPa-bisimilarity together with the logic ICRL. Section 6 presents conclusions and open questions for future work. An additional proof is shown in the appendix.

2. PRELIMINARIES

This section introduces relevant notions, concepts, and the notation that are used in the sequel. In particular, we recall the notions of closure space and quasi-discrete closure space, paths in such spaces, and closure models.

Given a set X , $|X|$ denotes the cardinality of X and $\mathcal{P}(X)$ denotes the powerset of X ; for $Y \subseteq X$ we use \overline{Y} to denote $X \setminus Y$, i.e. the complement of Y with respect to X . For $x_0, \dots, x_\ell \in X$, we let $(x_i)_{i=0}^\ell$ denote the sequence $(x_0, \dots, x_\ell) \in X^{\ell+1}$. For $m_1, m_2 \in \mathbb{N}$, with \mathbb{N} the set of natural numbers, we use $[m_1; m_2]$ to denote the set $\{n \in \mathbb{N} \mid m_1 \leq n \leq m_2\}$

and $[m_1; m_2)$ to denote $\{n \in \mathbb{N} \mid m_1 \leq n < m_2\}$. The sets $(m_1; m_2]$ and $(m_1; m_2)$ are defined in a similar way. For a function $f : X \rightarrow Y$ and $A \subseteq X$ and $B \subseteq Y$ we have $f(A) = \{f(a) \mid a \in A\}$ and $f^{-1}(B) = \{a \mid f(a) \in B\}$, respectively. We let $\mathbf{range}(f)$ denote the range $f(X)$ of f . The *restriction* of f to A will be denoted by $f|_A$, as usual. For a binary relation $R \subseteq X \times X$, we use R^{-1} to denote the converse relation $\{(x_1, x_2) \mid (x_2, x_1) \in R\}$.

Our framework for modelling space is based on the notion of *Čech Closure Space* [Če66], CS for short, also known as *pre-topological space*, that provides a convenient common framework for the study of several kinds of spatial models, including models of both discrete and continuous space [SW07]. We briefly recall several definitions and results on CSs, most of which are borrowed from [Gal03].

Definition 2.1 (Closure Space). A *closure space*, CS for short, is a pair (X, \mathcal{C}) where X is a set (of *points*) and $\mathcal{C} : \mathcal{P}(X) \rightarrow \mathcal{P}(X)$ is a function, referred to as the closure operator, satisfying the following axioms:

- (1) $\mathcal{C}(\emptyset) = \emptyset$;
- (2) $A \subseteq \mathcal{C}(A)$ for all $A \subseteq X$;
- (3) $\mathcal{C}(A_1 \cup A_2) = \mathcal{C}(A_1) \cup \mathcal{C}(A_2)$ for all $A_1, A_2 \subseteq X$. •

A closure operator \mathcal{C} is monotone: if $A_1 \subseteq A_2$ then $\mathcal{C}(A_2) = \mathcal{C}(A_1 \cup A_2) = \mathcal{C}(A_1) \cup \mathcal{C}(A_2)$, hence $\mathcal{C}(A_1) \subseteq \mathcal{C}(A_2)$. It is also worth pointing out that topological spaces coincide with the sub-class of CSs for which the closure operator is idempotent, i.e.

- (4) $\mathcal{C}(\mathcal{C}(A)) = \mathcal{C}(A)$, for all $A \subseteq X$.

Axioms (1)–(4) are commonly known as the Kuratowski closure axioms for topological spaces, after K. Kuratowski, who first formalised them [Kur22].

The *interior* operator $\mathcal{I} : \mathcal{P}(X) \rightarrow \mathcal{P}(X)$ of CS (X, \mathcal{C}) is the dual of the closure operator and is given by $\mathcal{I}(A) = \overline{\mathcal{C}(\overline{A})}$ for $A \subseteq X$. It holds that $\mathcal{I}(X) = X$, $\mathcal{I}(A) \subseteq A$, and $\mathcal{I}(A_1 \cap A_2) = \mathcal{I}(A_1) \cap \mathcal{I}(A_2)$. Like the closure operator, the interior operator is monotone. A *neighborhood* of a point $x \in X$ is any set $A \subseteq X$ such that $x \in \mathcal{I}(A)$. A *minimal neighborhood* of a point $x \in X$ is a neighborhood A of x such that $A \subseteq A'$ for any other neighborhood A' of x .

We have occasion to use the following property of closure spaces (see also Corollary 14.B.7 in [Če66]).

Lemma 2.2. *Let (X, \mathcal{C}) be a CS. For $x \in X$, $A \subseteq X$, it holds that $x \in \mathcal{C}(A)$ iff $U \cap A \neq \emptyset$ for each neighborhood U of x .*

Proof. Suppose $x \in X$ and $A \subseteq X$ satisfy $x \in \mathcal{C}(A)$. Let U be a neighborhood of x . Thus $x \in \mathcal{I}(U)$. Working towards a contradiction, assume $U \cap A = \emptyset$. Then $A \subseteq \overline{U}$ and $\mathcal{C}(A) \subseteq \mathcal{C}(\overline{U})$ by monotonicity of \mathcal{C} . Hence $\overline{\mathcal{C}(A)} \supseteq \overline{\mathcal{C}(\overline{U})}$, i.e. $\overline{\mathcal{C}(A)} \supseteq \mathcal{I}(U)$, and therefore $\mathcal{C}(A) \cap \mathcal{I}(U) = \emptyset$. However, $x \in \mathcal{C}(A)$ and $x \in \mathcal{I}(U)$, thus $x \in \mathcal{C}(A) \cap \mathcal{I}(U)$.

Suppose $x \in X$ and $A \subseteq X$ satisfy $x \notin \mathcal{C}(A)$. Then $x \in \overline{\mathcal{C}(A)} = \mathcal{I}(\overline{A})$. Note that $\overline{A} \cap A = \emptyset$, thus, \overline{A} is a neighborhood of x disjoint of A . □

In the sequel we will mainly work with quasi-discrete closure spaces, rather than closure spaces in general.

Definition 2.3 (Quasi-discrete closure space). A *quasi-discrete closure space*, QdCS for short, is a CS (X, \mathcal{C}) such that any of the following equivalent conditions holds:

- (1) each $x \in X$ has a minimal neighborhood;

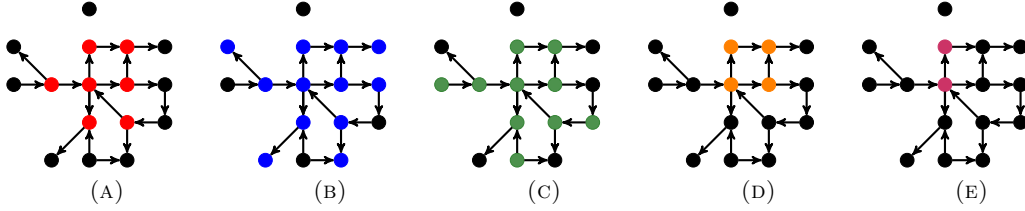

FIGURE 3. Given a closure space $(X, \vec{\mathcal{C}})$ and a set $A \subseteq X$, shown in red in Fig. 3a, $\vec{\mathcal{C}}(A)$ is shown in blue in Fig. 3b, $\vec{\mathcal{C}}(A)$ is shown in green in Fig. 3c, $\vec{\mathcal{I}}(A)$ is shown in orange in Fig. 3d, and $\vec{\mathcal{I}}(A)$ is shown in magenta in Fig. 3e.

(2) for each $A \subseteq X$ it holds that $\mathcal{C}(A) = \bigcup_{x \in A} \mathcal{C}(\{x\})$. •

Given a relation $R \subseteq X \times X$, let the function $\mathcal{C}_R : \mathcal{P}(X) \rightarrow \mathcal{P}(X)$ be such that

$$\mathcal{C}_R(A) = A \cup \{x \in X \mid \exists a \in A: (a, x) \in R\}$$

for all $A \subseteq X$. It is easy to see that, for any relation R , the function \mathcal{C}_R satisfies all the axioms of Definition 2.1 and so (X, \mathcal{C}_R) is a CS.

As a consequence, for directed and undirected graphs, the edge relation gives rise to a QdCS. It follows from condition 3 of Definition 2.1 that every finite closure space is quasi-discrete.

The following theorem is a standard result in the theory of CSs [Gal03].

Theorem 2.4. *A CS (X, \mathcal{C}) is quasi-discrete iff there is a relation $R \subseteq X \times X$ such that $\mathcal{C} = \mathcal{C}_R$. □*

In the sequel, whenever a CS (X, \mathcal{C}) is quasi-discrete, we use $\vec{\mathcal{C}}$ to denote \mathcal{C}_R , and, consequently, $(X, \vec{\mathcal{C}})$ to denote the closure space, abstracting from the specification of the relation R underlying the closure operator, when such a specification is not necessary. Moreover, we let $\vec{\mathcal{C}}$ denote $\mathcal{C}_{R^{-1}}$. In the QdCS $(X, \vec{\mathcal{C}})$ of Figure 3a a set $A \subseteq X$ is shown in red. $\vec{\mathcal{C}}(A)$ and $\vec{\mathcal{C}}(A)$ are shown in blue and in green in Figure 3b and Figure 3c, respectively.

Regarding the interior operator \mathcal{I} , the notations $\vec{\mathcal{I}}$ and $\vec{\mathcal{I}}$ are defined in the obvious way: $\vec{\mathcal{I}}A = \vec{\mathcal{C}}(\overline{A})$ and $\vec{\mathcal{I}}A = \vec{\mathcal{C}}(\overline{A})$. Again, with reference to the example of Figure 3, $\vec{\mathcal{I}}(A)$ and $\vec{\mathcal{I}}(A)$ are shown in orange and in magenta in Figure 3d and Figure 3e, respectively.

It is worth noting that, for any QdCS (X, \mathcal{C}_R) and $A \subseteq X$ we have that

$$\vec{\mathcal{I}}(A) = A \setminus \{x \in X \mid \exists a \in \overline{A}: (a, x) \in R\},$$

and, similarly,

$$\vec{\mathcal{I}}(A) = A \setminus \{x \in X \mid \exists a \in \overline{A}: (x, a) \in R\}.$$

Clearly, for a symmetric relation R on X the closure operators $\vec{\mathcal{C}}$ and $\vec{\mathcal{C}}$ coincide, as do $\vec{\mathcal{I}}$ and $\vec{\mathcal{I}}$. Finally, we will often use the simplified notation $\vec{\mathcal{C}}(x)$ for $\vec{\mathcal{C}}(\{x\})$, and similarly for $\vec{\mathcal{C}}(x)$, $\vec{\mathcal{I}}(x)$ and $\vec{\mathcal{I}}(x)$.

The following lemma relates the operators $\vec{\mathcal{C}}$ and $\vec{\mathcal{I}}$ (and, symmetrically, $\vec{\mathcal{C}}$ and $\vec{\mathcal{I}}$).

Lemma 2.5. *Let (X, \vec{C}) be a QdCS. Then $\vec{C}(x) \subseteq A$ iff $x \in \vec{I}(A)$ and $\vec{C}(x) \subseteq A$ iff $x \in \vec{I}(A)$, for all $x \in X$ and $A \subseteq X$.*

Proof. We have the following derivation:

$$\begin{aligned}
& x \in \vec{I}(A) \\
\Leftrightarrow & \quad [\text{Def. of } \vec{I}; \text{ Set Theory}] \\
& x \notin \vec{C}(\bar{A}) \\
\Leftrightarrow & \quad [\text{Def. of } \vec{C}] \\
& x \notin \bar{A} \text{ and there is no } \bar{a} \in \bar{A} \text{ such that } (\bar{a}, x) \in R \\
\Leftrightarrow & \quad [\text{Logic}] \\
& x \in A \text{ and for all } x' \in X, \text{ if } (x', x) \in R \text{ then } x' \in A \\
\Leftrightarrow & \quad [\text{Set Theory}] \\
& \vec{C}(x) \subseteq A.
\end{aligned}$$

Symmetrically we obtain $x \in \vec{I}(A)$ if and only if $\vec{C}(x) \subseteq A$. □

In the theory of closure spaces, *paths* play a fundamental role. As in topology, they are defined as *continuous functions* from appropriate *index spaces* to the relevant closure spaces.

Definition 2.6 (Continuous function). Function $f : X_1 \rightarrow X_2$ is a *continuous function* from (X_1, \mathcal{C}_1) to (X_2, \mathcal{C}_2) if and only if for all sets $A \subseteq X_1$ we have $f(\mathcal{C}_1(A)) \subseteq \mathcal{C}_2(f(A))$. •

Definition 2.7 (Index space). An *index space* is a connected² CS (I, \mathcal{C}) equipped with a total order $\leq \subseteq I \times I$ that has a bottom element. •

Definition 2.8 (Path). A *path* in CS (X, \mathcal{C}) is a continuous function from an index space (I, \mathcal{C}') to (X, \mathcal{C}) . •

In the context of QdCSs it is sufficient to use $(\mathbb{N}, \mathcal{C}_{\text{succ}})$ as index space, where **succ** is the *successor relation* $\{(m, n) \in \mathbb{N} \mid n = m + 1\}$.

The following lemma states some useful properties of the closure operator as well as of paths.

Lemma 2.9. *For a QdCS (X, \vec{C}) it holds for all $A \subseteq X$ and $x_1, x_2 \in X$ that:*

- (i) $x_1 \in \vec{C}(\{x_2\})$ if and only if $x_2 \in \vec{C}(\{x_1\})$;
- (ii) $\vec{C}(A) = \{x \mid x \in X \text{ and exists } a \in A \text{ such that } a \in \vec{C}(\{x\})\}$;
- (iii) π is a path over X if and only if for all $j \neq 0$ the following holds: $\pi(j) \in \vec{C}(\pi(j-1))$.

Proof. We prove only item (iii) of the lemma, the proof of the other points being straightforward. We show that π is a path over (X, \vec{C}) if and only if, for all $j \neq 0$, we have $\pi(j) \in \vec{C}(\pi(j-1))$. Suppose π is a path over (X, \vec{C}) ; the following derivation proves the assert:

²Given CS (X, \mathcal{C}) , $A \subseteq X$ is *connected* if it is *not* the union of two non-empty separated sets. Two subsets $A_1, A_2 \subseteq X$ are called *separated* if $A_1 \cap \mathcal{C}(A_2) = \emptyset = \mathcal{C}(A_1) \cap A_2$. CS (X, \mathcal{C}) is *connected* if X is connected.



FIGURE 4. A CS (X, \mathcal{C}_R) where $X = \{x_1, x_2, x_3\}$ and $R = \{(x_1, x_2), (x_2, x_3)\}$; we have that $(x_1, x_1, x_1, x_2, x_2, x_2, x_3, x_3)$ is a forward path from x_1 and $(x_3, x_3, x_2, x_1, x_1, x_1, x_1)$ is a backward path from x_3 .

$$\begin{aligned}
& \pi(j) \\
\in & \quad [\text{Set Theory}] \\
& \{\pi(j-1), \pi(j)\} \\
= & \quad [\text{Definition of } \pi(N) \text{ for } N \subseteq \mathbb{N}] \\
& \pi(\{j-1, j\}) \\
= & \quad [\text{Definition of } \mathcal{C}_{\text{succ}}] \\
& \pi(\mathcal{C}_{\text{succ}}(\{j-1\})) \\
\subseteq & \quad [\text{Continuity of } \pi] \\
& \vec{\mathcal{C}}(\pi(j-1))
\end{aligned}$$

For proving the converse we have to show that for all sets $N \subseteq \mathbb{N} \setminus \{0\}$ we have $\pi(\mathcal{C}_{\text{succ}}(N)) \subseteq \vec{\mathcal{C}}(\pi(N))$. By definition of $\mathcal{C}_{\text{succ}}$ we have that $\mathcal{C}_{\text{succ}}(N) = N \cup \{j \mid j-1 \in N\}$ and so $\pi(\mathcal{C}_{\text{succ}}(N)) = \pi(N) \cup \pi(\{j \mid j-1 \in N\})$. By the second axiom of closure, we have $\pi(N) \subseteq \vec{\mathcal{C}}(\pi(N))$. We show that $\pi(\{j \mid j-1 \in N\}) \subseteq \vec{\mathcal{C}}(\pi(N))$ as well. Take any j such that $j-1 \in N$; we have $\{\pi(j-1)\} \subseteq \pi(N)$ since $j-1 \in N$, and, by monotonicity of $\vec{\mathcal{C}}$ it follows that $\vec{\mathcal{C}}(\{\pi(j-1)\}) \subseteq \vec{\mathcal{C}}(\pi(N))$. Consequently, since $\pi(j) \in \vec{\mathcal{C}}(\pi(j-1))$ by hypothesis, we also get $\pi(j) \in \vec{\mathcal{C}}(\pi(N))$. Since this holds for all elements of the set $\{j \mid j-1 \in N\}$ we also have $\pi(\{j \mid j-1 \in N\}) \subseteq \vec{\mathcal{C}}(\pi(N))$. \square

For the purposes of the present paper, it is actually sufficient to consider only *finite* paths over QdCSs, i.e. continuous functions having $[0; \ell]$ as a domain, for some $\ell \in \mathbb{N}$. For such paths, it is convenient to introduce some notation and terminology. Given a QdCS $(X, \vec{\mathcal{C}})$ and a path $\pi : [0; \ell] \rightarrow X$, we call ℓ the *length* of π and often use the tuple notation $(x_i)_{i=0}^{\ell}$, where $x_i = \pi(i)$ for all $i \in [0; \ell]$. More precisely, on the basis of Lemma 2.9(iii), we say that $(x_i)_{i=0}^{\ell}$ is a *forward path from* x_0 if $x_{i+1} \in \vec{\mathcal{C}}(x_i)$ for $i \in [0; \ell)$ and, similarly, we say that it is a *backward path from* x_0 if $x_{i+1} \in \vec{\mathcal{C}}(x_i)$ for $i \in [0; \ell)$. An example of forward and backward paths is shown in Figure 4. In the sequel, we avoid to specify “from” which point a (forward / backward) starts, when this does not cause confusion.

Given forward paths $\pi' = (x'_i)_{i=0}^{\ell'}$ and $\pi'' = (x''_i)_{i=0}^{\ell''}$, with $x'_{\ell'} = x''_0$, the *concatenation* $\pi' \cdot \pi''$ of π' with π'' is the path $\pi : [0; \ell' + \ell''] \rightarrow X$ from x'_0 , such that $\pi(i) = \pi'(i)$ if $i \in [0; \ell']$ and $\pi(i) = \pi''(i - \ell')$ if $i \in [\ell'; \ell' + \ell'']$; concatenation for backward paths is defined similarly. For a path $\pi = (x_i)_{i=0}^n$ and $k \in [0, n]$ we define the k -shift operator $_ \uparrow k$ as follows: $\pi \uparrow k = (x_{j+k})_{j=0}^{n-k}$; furthermore, a (*non-empty*) *prefix* of π is a path $\pi \upharpoonright [0, k]$, for some $k \in [0; n]$. We let FPaths^{F} denote the set of all finite forward paths of $(X, \vec{\mathcal{C}})$.

We fix a set AP of *atomic proposition letters*, that we will refer to in the following sections.

Definition 2.10 (Closure model). A *closure model*, CM for short, is a tuple $\mathcal{M} = (X, \mathcal{C}, \mathcal{V})$, with (X, \mathcal{C}) a CS, and $\mathcal{V} : \text{AP} \rightarrow \mathcal{P}(X)$ the (atomic proposition letters) valuation function, assigning to each $p \in \text{AP}$ the set of points where p holds. •

A *quasi-discrete closure model* (QdCM for short) is a CM $(X, \vec{\mathcal{C}}, \mathcal{V})$ where $(X, \vec{\mathcal{C}})$ is a QdCS. For a closure model $\mathcal{M} = (X, \mathcal{C}, \mathcal{V})$ we often write $x \in \mathcal{M}$ when $x \in X$. Similarly, we speak of paths in \mathcal{M} meaning paths in (X, \mathcal{C}) .

3. BISIMILARITY FOR CLOSURE MODELS

In this section, we introduce the first notion of spatial bisimilarity that we consider, namely Closure Model bisimilarity, CM-bisimilarity for short, for which we also provide a logical characterisation. The definition of CM-bisimilarity is an instantiation to CMs of monotonic bisimulation on neighborhood models [BBEY17, Han03]. Consequently, it is defined using the interior operator.

Definition 3.1 (CM-bisimilarity). Given a CM $\mathcal{M} = (X, \mathcal{C}, \mathcal{V})$, a symmetric relation $B \subseteq X \times X$ is called a *CM-bisimulation* for \mathcal{M} if for all $x_1, x_2 \in X$ such that $B(x_1, x_2)$ the following holds:

- (1) $x_1 \in \mathcal{V}(p)$ if and only if $x_2 \in \mathcal{V}(p)$, for all $p \in \text{AP}$.
- (2) If $x_1 \in \mathcal{I}(S_1)$ for a subset $S_1 \subseteq X$, then for some subset $S_2 \subseteq X$ it holds that
 - (i) $x_2 \in \mathcal{I}(S_2)$ and (ii) for each $s_2 \in S_2$ exists $s_1 \in S_1$ such that $B(s_1, s_2)$.

Two points $x_1, x_2 \in X$ are called CM-bisimilar in \mathcal{M} if $B(x_1, x_2)$ for some CM-bisimulation B for \mathcal{M} . Notation, $x_1 \equiv_{\text{CM}}^{\mathcal{M}} x_2$. •

Example 3.2. Consider the closure model \mathcal{M} depicted in Figure 5 where $\mathcal{M} = (X, \mathcal{C}, \mathcal{V})$ with $X = \{x_1, x_2, x_3, y_1, y_2, z_2, t_1, t_2, t_3, u_1, u_2, v_1, v_2, v_3\}$, \mathcal{C} as induced by the binary relation as depicted in the figure, and with atomic propositions *red*, *blue*, and *green* and valuation function \mathcal{V} satisfying $\mathcal{V}(\text{red}) = \{x_1, x_2, x_3, v_1, v_2, v_3\}$, $\mathcal{V}(\text{blue}) = \{y_1, y_2, z_2, t_2\}$, and $\mathcal{V}(\text{green}) = \{y_3, u_1, u_2, t_1, t_3\}$.

The relation $B_{12} = \{(x_1, x_2), (x_2, x_1)\}$ is a CM-bisimulation relation relating x_1 and x_2 . E.g., for the set $S_1 = \{x_1, y_1\}$ satisfying $x_1 \in \{x_1, y_1\} = \mathcal{I}(S_1)$ we can choose $S_2 = \{x_2\}$ to match S_1 . Similarly, the relation $B_{13} = \{(x_1, x_3), (x_3, x_1)\}$ is a CM-bisimulation relation relating x_1 and x_3 despite the green color $\mathcal{V}^{-1}(\{y_3\})$ of y_3 .

Also the points v_1 and v_3 are CM-bisimilar, but both v_1 and v_3 are not CM-bisimilar to v_2 . The set $S_1 = \{t_1, u_1, v_1\}$ has v_1 in its interior. The smallest set S_2 such that $v_2 \in \mathcal{I}(S_2)$ is $\{t_2, u_2, v_2\}$. However, for $t_2 \in \mathcal{I}(S_2)$ there exists no counterpart in S_1 .

We will show that CM-bisimilarity is characterized by an infinitary modal logic called IML. In the present spatial context the classical modality \diamond is interpreted as a *proximity* modality, and it is denoted by \mathcal{N} standing for being “near”. The definition of IML below is taken from [CLMV20].

Definition 3.3 (IML). The abstract language of the modal logic IML is given by

$$\Phi ::= p \mid \neg\Phi \mid \bigwedge_{i \in I} \Phi_i \mid \mathcal{N}\Phi$$

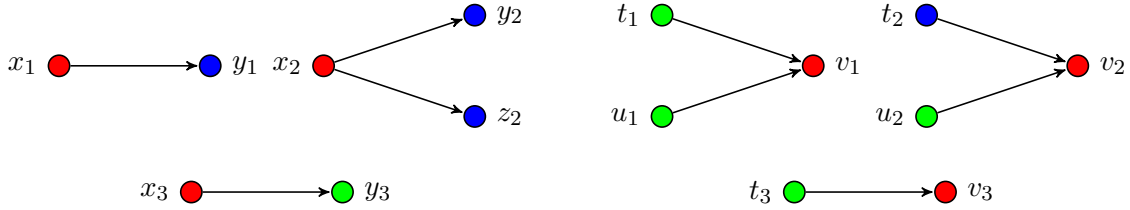

FIGURE 5. x_1 , x_2 , and x_3 CM-bisimilar; v_1 and v_3 not CM-bisimilar to v_2

where p ranges over AP and I ranges over an appropriate collection of index sets.

The satisfaction relation for IML with respect to a given CM $\mathcal{M} = (X, \mathcal{C}, \mathcal{V})$ with point x is recursively defined on the structure of Φ as follows:

$$\begin{aligned}
\mathcal{M}, x \models_{\text{IML}} p & \quad \text{iff } x \in \mathcal{V}(p) \\
\mathcal{M}, x \models_{\text{IML}} \neg \Phi & \quad \text{iff } \mathcal{M}, x \not\models_{\text{IML}} \Phi \text{ does not hold} \\
\mathcal{M}, x \models_{\text{IML}} \bigwedge_{i \in I} \Phi_i & \quad \text{iff } \mathcal{M}, x \models_{\text{IML}} \Phi_i \text{ for all } i \in I \\
\mathcal{M}, x \models_{\text{IML}} \mathcal{N}\Phi & \quad \text{iff } x \in \mathcal{C}(\llbracket \Phi \rrbracket^{\mathcal{M}})
\end{aligned}$$

with $\llbracket \Phi \rrbracket^{\mathcal{M}} = \{x \in X \mid \mathcal{M}, x \models_{\text{IML}} \Phi\}$. •

Example 3.4. As a simple illustration of the above definition, in the CM of Figure 5 it holds that $\llbracket \text{blue} \rrbracket = \{y_1, y_2, z_2, t_2\}$. Hence $\mathcal{C}(\llbracket \text{blue} \rrbracket) = \llbracket \text{blue} \rrbracket \cup \{v_2\}$. Therefore we have that $v_2 \models \mathcal{N}\text{blue}$ and $v_1, v_3 \not\models \mathcal{N}\text{blue}$.

The logic IML induces an equivalence on the carrier of a CM in the usual way.

Definition 3.5 (IML-equivalence). For a CM \mathcal{M} , the relation $\simeq_{\text{IML}}^{\mathcal{M}} \subseteq X \times X$ is defined by

$$x_1 \simeq_{\text{IML}}^{\mathcal{M}} x_2 \quad \text{iff } \mathcal{M}, x_1 \models_{\text{IML}} \Phi \Leftrightarrow \mathcal{M}, x_2 \models_{\text{IML}} \Phi, \text{ for all } \Phi \in \text{IML}. \quad \bullet$$

We establish coincidence of CM-bisimilarity and IML-equivalence in two steps. First we prove that IML-equivalence $\simeq_{\text{IML}}^{\mathcal{M}}$ includes CM-bisimilarity $\rightleftharpoons_{\text{CM}}^{\mathcal{M}}$.

Lemma 3.6. For all points x_1, x_2 in a CM \mathcal{M} , if $x_1 \rightleftharpoons_{\text{CM}}^{\mathcal{M}} x_2$ then $x_1 \simeq_{\text{IML}}^{\mathcal{M}} x_2$.

Proof. We proceed by induction on the structure of Φ to show that $x_1 \models \Phi$ implies $x_2 \models \Phi$ when $x_1 \rightleftharpoons_{\text{CM}}^{\mathcal{M}} x_2$ for $x_1, x_2 \in X$, where we only consider the case for $\mathcal{N}\Phi$, the others being straightforward, and we refrain from writing the superscript \mathcal{M} for the sake of readability.

So, suppose $x_1, x_2 \in X$ such that $x_1 \rightleftharpoons_{\text{CM}}^{\mathcal{M}} x_2$ and $x_1 \models \mathcal{N}\Phi$. By definition of satisfaction for IML, we have that $x_1 \in \mathcal{C}(\llbracket \Phi \rrbracket)$. Equivalently, by Lemma 2.2, every neighborhood of x_1 intersects $\llbracket \Phi \rrbracket$. Now, let S_2 be a neighborhood of x_2 . Since $x_1 \rightleftharpoons_{\text{CM}}^{\mathcal{M}} x_2$, for some neighborhood S_1 of x_1 it holds that for each point $s_1 \in S_1$ a CM-bisimilar point s_2 in S_2 exists, i.e. $s_1 \rightleftharpoons_{\text{CM}}^{\mathcal{M}} s_2$. Let $x'_1 \in S_1 \cap \llbracket \Phi \rrbracket$ and $x'_2 \in S_2$ be such that $x'_1 \rightleftharpoons_{\text{CM}}^{\mathcal{M}} x'_2$. Since $x'_1 \in \llbracket \Phi \rrbracket$, we have $x'_1 \models \Phi$, and because $x'_1 \rightleftharpoons_{\text{CM}}^{\mathcal{M}} x'_2$, also $x'_2 \models \Phi$ by induction hypothesis. As $x'_2 \in S_2 \cap \llbracket \Phi \rrbracket$, $S_2 \cap \llbracket \Phi \rrbracket$ is non-empty. Again with appeal to Lemma 2.2 we obtain $x_2 \in \mathcal{C}(\llbracket \Phi \rrbracket)$, i.e. $x_2 \models \mathcal{N}\Phi$, as was to be verified. □

In order to obtain an inclusion into the other direction, we follow the argument as in [BBEY17] and introduce the auxiliary notion of a characteristic formula for a point in a CM.

Lemma 3.7. For a CM \mathcal{M} , it holds that $\simeq_{\text{IML}}^{\mathcal{M}}$ is a CM-bisimulation for \mathcal{M} .

Proof. Suppose $\mathcal{M} = (X, \mathcal{C}, \mathcal{V})$. For $x, y \in X$, the IML-formula $\delta_{x,y}$ is such that it evaluates to **true** if $x \simeq_{\text{IML}} y$ and otherwise $\delta_{x,y}$ is such that $x \models \delta_{x,y}$ and $y \models \neg\delta_{x,y}$. For a point x of \mathcal{M} its characteristic formula $\chi(x)$ is then given by $\chi(x) = \bigwedge_{y \in X} \delta_{x,y}$. It can be straightforwardly verified that (i) $x \models \chi(x)$, (ii) $y \models \chi(x)$ iff $x \simeq_{\text{IML}} y$, and (iii) $S \subseteq \llbracket \bigvee_{s \in S} \chi(s) \rrbracket$ for all $S \subseteq X$. Also, for a point x of \mathcal{M} and IML-formula Φ it holds that

$$x \in \mathcal{I}[\Phi] \quad \text{iff} \quad x \models \neg\mathcal{N}\neg\Phi. \quad (3.1)$$

To see this, observe that $\overline{\llbracket \Phi \rrbracket} = \llbracket \neg\Phi \rrbracket$. Consequently, $x \in \mathcal{I}[\Phi]$ iff $x \notin \mathcal{C}[\overline{\llbracket \Phi \rrbracket}]$ iff $x \notin \mathcal{C}[\llbracket \neg\Phi \rrbracket]$ iff $x \not\models \mathcal{N}\neg\Phi$ iff $x \models \neg\mathcal{N}\neg\Phi$.

Assume $x_1 \simeq_{\text{IML}} x_2$. We check that the two conditions of Definition 3.1 are fulfilled. As to the first condition, let $p \in \text{AP}$. Because $x_1 \simeq_{\text{IML}} x_2$, we have $x_1 \models p$ iff $x_2 \models p$, thus $x_1 \in \mathcal{V}(p)$ iff $x_2 \in \mathcal{V}(p)$.

As to the second condition, if $S_1 \subseteq X$ is a neighborhood of x_1 , i.e. $x_1 \in \mathcal{I}(S_1)$, we put $S_2 = \{s_2 \mid \exists s_1 \in S_1: s_1 \simeq_{\text{IML}} s_2\}$. Clearly, for $s_2 \in S_2$, $s_1 \in S_1$ exists such that $s_1 \simeq_{\text{IML}} s_2$. Therefore, it suffices to verify that S_2 is a neighborhood of x_2 , i.e. $x_2 \in \mathcal{I}(S_2)$.

Put $\Phi = \bigvee_{s_1 \in S_1} \chi(s_1)$. To see that $S_2 = \llbracket \Phi \rrbracket$ we argue as follows:

Case $S_2 \subseteq \llbracket \Phi \rrbracket$: For $s_2 \in S_2$ we can choose $s_1 \in S_1$ such that $s_1 \simeq_{\text{IML}} s_2$. Since $s_1 \models \chi(s_1)$ by property (i) above, also $s_1 \models \Phi$. Thus $s_2 \models \Phi$, since $s_1 \simeq_{\text{IML}} s_2$.

Case $\llbracket \Phi \rrbracket \subseteq S_2$: If $s \models \Phi$, then $s \models \chi(s_1)$ for some $s_1 \in S_1$. Thus $s \simeq_{\text{IML}} s_1$ for some $s_1 \in S_1$ by property (ii) above and $s \in S_2$. This proves that $S_2 = \llbracket \Phi \rrbracket$.

We continue to verify that $x_2 \in \mathcal{I}(S_2)$. It holds that $x_1 \models \neg\mathcal{N}\neg\Phi$. To see this, note that $S_1 \subseteq \llbracket \Phi \rrbracket$ by property (iii) above. Now, S_1 is a neighborhood of x_1 . Hence $x_1 \in \mathcal{I}(S_1) \subseteq \mathcal{I}[\llbracket \Phi \rrbracket]$ and $x_1 \models \neg\mathcal{N}\neg\Phi$ by Equation 3.1. Now, since $x_1 \simeq_{\text{IML}} x_2$ it follows that $x_2 \models \neg\mathcal{N}\neg\Phi$. Therefore, $x_2 \in \mathcal{I}[\llbracket \Phi \rrbracket]$ again by Equation 3.1. Thus $x_2 \in \mathcal{I}(S_2)$, because $S_2 = \llbracket \Phi \rrbracket$. \square

Summarising the above, we have the following correspondence result of CM-bisimilarity vs. IML-equivalence.

Theorem 3.8. *IML-equivalence $\simeq_{\text{IML}}^{\mathcal{M}}$ coincides with CM-bisimilarity $\rightleftharpoons_{\text{CM}}^{\mathcal{M}}$, for every CM \mathcal{M} .*

Proof. Lemma 3.6 yields $\rightleftharpoons_{\text{CM}}^{\mathcal{M}} \subseteq \simeq_{\text{IML}}^{\mathcal{M}}$. Lemma 3.7 yields $\simeq_{\text{IML}}^{\mathcal{M}} \subseteq \rightleftharpoons_{\text{CM}}^{\mathcal{M}}$. \square

An obvious consequence of Theorem 3.8 follows.

Corollary 3.9. *For all QdCMs \mathcal{M} , $\rightleftharpoons_{\text{CM}}^{\mathcal{M}}$ is an equivalence relation.*

Remark 3.10. The notion of CM-bisimilarity as given by Definition 3.1 is the natural generalisation to closure models of the notion of Topo-bisimilarity for topological models [BB07]. The latter models are similar to closure models except that the underlying set is equipped with the open sets of a topology rather than the closed sets derived from a closure operator. We note that a topological space (X, τ) gives rise to a closure space with idempotent closure operator \mathcal{C}_τ . Therefore, a topological model (X, τ, \mathcal{V}) can be seen as a closure model $(X, \mathcal{C}_\tau, \mathcal{V})$. For a topological model the definition of a Topo-bisimulation of [BB07] and Definition 3.1 coincide, i.e. a relation B on X is a Topo-bisimulation if and only if it is a CM-bisimulation. However, closure spaces are more general than topological spaces. As we anticipated in Section 2, it holds that a closure operator induces a topology if and only if it is idempotent, cf. [Če66, Gal03]. Hence, not every closure space is a topological space and not every closure model is a topological model.

4. CMC-BISIMILARITY FOR QDCMS

Definition 3.1 of the previous section defines CM-bisimilarity of a closure model in terms of its interior operator \mathcal{I} . In the case of QdCMs, an alternative formulation can be given that uses the closure operator explicitly and directly, as we will see below. This formulation exploits the symmetric nature of the operators in such models.

Definition 4.1. Given a QdCM $\mathcal{M} = (X, \vec{\mathcal{C}}, \mathcal{V})$, a symmetric relation $B \subseteq X \times X$ is a CM-bisimulation for \mathcal{M} if, whenever $B(x_1, x_2)$, the following holds:

- (1) for all $p \in \mathbf{AP}$ we have $x_1 \in \mathcal{V}(p)$ if and only if $x_2 \in \mathcal{V}(p)$;
- (2) for all x'_1 such that $x_1 \in \vec{\mathcal{C}}(x'_1)$ exists x'_2 such that $x_2 \in \vec{\mathcal{C}}(x'_2)$ and $B(x'_1, x'_2)$. •

The above definition is justified by the next lemma.

Lemma 4.2. *Let $\mathcal{M} = (X, \vec{\mathcal{C}}, \mathcal{V})$ be a QdCM and $B \subseteq X \times X$ a relation. It holds that B is a CM-bisimulation according to Definition 3.1 if and only if B is a CM-bisimulation according to Definition 4.1.*

Proof. (if) Assume that B is a CM-bisimulation in the sense of Definition 3.1. Let $x_1, x_2 \in X$ such that $B(x_1, x_2)$. We verify condition (2) of Definition 4.1: Let $x'_1 \in X$ such that $x_1 \in \vec{\mathcal{C}}(x'_1)$. Hence $x'_1 \in \vec{\mathcal{C}}(x_1)$, by Lemma 2.9(i). For $S_2 = \vec{\mathcal{C}}(x_2)$ we have $x_2 \in \vec{\mathcal{I}}(S_2)$ by Lemma 2.5. By condition (2) of Definition 3.1, with the roles of x_1 and x_2 , and of S_1 and S_2 interchanged, a subset $S_1 \subseteq X$ exists such that $x_1 \in \vec{\mathcal{I}}(S_1)$ and, for each $s_1 \in S_1$, $s_2 \in S_2$ exists such that $(s_1, s_2) \in B$. In particular, there is $x'_2 \in S_2 = \vec{\mathcal{C}}(x_2)$ such that $B(x'_1, x'_2)$. Thus $x'_2 \in X$ exists such that $x_2 \in \vec{\mathcal{C}}(x'_2)$ and $B(x'_1, x'_2)$.

(only if) Assume that B is a closure-based CM-bisimulation in the sense of Definition 4.1. Let $x_1, x_2 \in X$ be such that $B(x_1, x_2)$. We verify condition (2) of Definition 3.1. Suppose subset $S_1 \subseteq X$ is such that $x_1 \in \vec{\mathcal{I}}(S_1)$. By Lemma 2.5 we have $\vec{\mathcal{C}}(x_1) \subseteq S_1$. Let $S_2 = \vec{\mathcal{C}}(x_2)$. Then $x_2 \in \vec{\mathcal{I}}(S_2)$, again by Lemma 2.5. By condition (2) of Definition 4.1, for each $x'_2 \in \vec{\mathcal{C}}(x_2)$ a point $x'_1 \in \vec{\mathcal{C}}(x_1)$ exists such that $B(x'_1, x'_2)$. Since $S_2 = \vec{\mathcal{C}}(x_2)$ and $\vec{\mathcal{C}}(x_1) \subseteq S_1$, it follows that for each $s_2 \in S_2$ and there is $s_1 \in S_1$ such that $B(s_1, s_2)$. □

As noted above, when dealing with QdCMs, we can exploit the symmetric nature of the operators involved. Recall that, whenever \mathcal{M} is quasi-discrete, there are actually two interior functions, namely $\vec{\mathcal{I}}(S)$ and $\overleftarrow{\mathcal{I}}(S)$. It is then natural to use both functions for the definition of a notion of CM-bisimilarity specifically designed for QdCMs, namely *CM-bisimilarity with converse*, CMC-bisimilarity for short, presented below.

Definition 4.3 (CMC-bisimilarity). Given QdCM $\mathcal{M} = (X, \vec{\mathcal{C}}, \mathcal{V})$, a symmetric relation $B \subseteq X \times X$ is a CMC-bisimulation for \mathcal{M} if, whenever $B(x_1, x_2)$, the following holds:

- (1) for all $p \in \mathbf{AP}$ we have $x_1 \in \mathcal{V}(p)$ if and only if $x_2 \in \mathcal{V}(p)$;
- (2) for all $S_1 \subseteq X$ such that $x_1 \in \vec{\mathcal{I}}(S_1)$ there is $S_2 \subseteq X$ such that $x_2 \in \vec{\mathcal{I}}(S_2)$ and for all $s_2 \in S_2$, there is $s_1 \in S_1$ with $B(s_1, s_2)$;
- (3) for all $S_1 \subseteq X$ such that $x_1 \in \overleftarrow{\mathcal{I}}(S_1)$ there is $S_2 \subseteq X$ such that $x_2 \in \overleftarrow{\mathcal{I}}(S_2)$ and for all $s_2 \in S_2$, there is $s_1 \in S_1$ with $B(s_1, s_2)$.

Two points $x_1, x_2 \in X$ are called CMC-bisimilar in \mathcal{M} , if $B(x_1, x_2)$ for some CMC-bisimulation B for \mathcal{M} . Notation, $x_1 \rightleftharpoons_{\text{CMC}}^{\mathcal{M}} x_2$. •

For a QdCM \mathcal{M} , as for CM-bisimilarity, we have that CMC-bisimilarity is a CMC-bisimulation itself, viz. the largest CMC-bisimulation for \mathcal{M} , thus including each CMC-bisimulation for \mathcal{M} .

Also for CMC-bisimilarity, a formulation directly in terms of closures is possible³.

Definition 4.4. Given a QdCM $\mathcal{M} = (X, \vec{\mathcal{C}}, \mathcal{V})$, a symmetric relation $B \subseteq X \times X$ is a CMC-bisimulation for \mathcal{M} if, whenever $B(x_1, x_2)$, the following holds:

- (1) for all $p \in \text{AP}$ we have $x_1 \in \mathcal{V}(p)$ if and only if $x_2 \in \mathcal{V}(p)$;
- (2) for all $x'_1 \in \vec{\mathcal{C}}(x_1)$ there is $x'_2 \in \vec{\mathcal{C}}(x_2)$ such that $B(x'_1, x'_2)$;
- (3) for all $x'_1 \in \vec{\mathcal{C}}(x_1)$ there is $x'_2 \in \vec{\mathcal{C}}(x_2)$ such that $B(x'_1, x'_2)$. •

The next lemma shows the interchangeability of Definitions 4.3 and 4.4. The proof is essentially the same as that of Lemma 4.2.

Lemma 4.5. *Let $\mathcal{M} = (X, \vec{\mathcal{C}}, \mathcal{V})$ be a QdCM and $B \subseteq X \times X$ a relation. It holds that B is a CMC-bisimulation according to Definition 4.3 if and only if B is a CMC-bisimulation according to Definition 4.4. □*

Example 4.6. From the definitions of CM-bisimulation and CMC-bisimulation it can be immediately observed that in a closure model based on a quasi-discrete closure two points that are CMC-bisimilar are also CM-bisimilar. The reverse does not hold in general. In Figure 5, the points x_1 and x_2 on the one hand and the point x_3 on the other hand are CM-bisimilar, but not CMC-bisimilar. E.g., the points $y_1 \in \vec{\mathcal{C}}(x_1)$ and $y_2 \in \vec{\mathcal{C}}(x_2)$ do not have a match in $\vec{\mathcal{C}}(x_3) = \{x_3, y_3\}$.

Remark 4.7. Definition 4.4 was proposed originally in [CLMV20], in a slightly different form, and resembles the notion of (strong) back-and-forth bisimulation of [DMV90], in particular for the presence of condition (3).

In order to provide a logical characterisation of CMC-bisimilarity, we extend IML with a “converse” of its modal operator. The resulting logic is called *Infinitary Modal Logic with Converse* IMLC, a logic including the two spatial proximity modalities $\vec{\mathcal{N}}$, expressing forward “near”, and $\tilde{\mathcal{N}}$, expressing backward “near”.

Definition 4.8 (IMLC). The abstract language of IMLC is defined as follows:

$$\Phi ::= p \mid \neg\Phi \mid \bigwedge_{i \in I} \Phi_i \mid \vec{\mathcal{N}}\Phi \mid \tilde{\mathcal{N}}\Phi$$

where p ranges over AP and I ranges over an appropriate collection of index sets. The satisfaction relation with respect to a QdCM \mathcal{M} , point $x \in \mathcal{M}$, and IMLC formula Φ is defined recursively on the structure of Φ as follows:

$$\begin{aligned} \mathcal{M}, x \models_{\text{IMLC}} p & \Leftrightarrow x \in \mathcal{V}(p) \\ \mathcal{M}, x \models_{\text{IMLC}} \neg\Phi & \Leftrightarrow \mathcal{M}, x \not\models_{\text{IMLC}} \Phi \text{ does not hold} \\ \mathcal{M}, x \models_{\text{IMLC}} \bigwedge_{i \in I} \Phi_i & \Leftrightarrow \mathcal{M}, x \models_{\text{IMLC}} \Phi_i \text{ for all } i \in I \\ \mathcal{M}, x \models_{\text{IMLC}} \vec{\mathcal{N}}\Phi & \Leftrightarrow x \in \vec{\mathcal{C}}(\llbracket \Phi \rrbracket^{\mathcal{M}}) \\ \mathcal{M}, x \models_{\text{IMLC}} \tilde{\mathcal{N}}\Phi & \Leftrightarrow x \in \tilde{\mathcal{C}}(\llbracket \Phi \rrbracket^{\mathcal{M}}) \end{aligned}$$

with $\llbracket \Phi \rrbracket^{\mathcal{M}} = \{x \in X \mid \mathcal{M}, x \models_{\text{IMLC}} \Phi\}$. •

³The notion characterized by Definition 4.4 is called \mathcal{C} -bisimulation in [CLMV21]

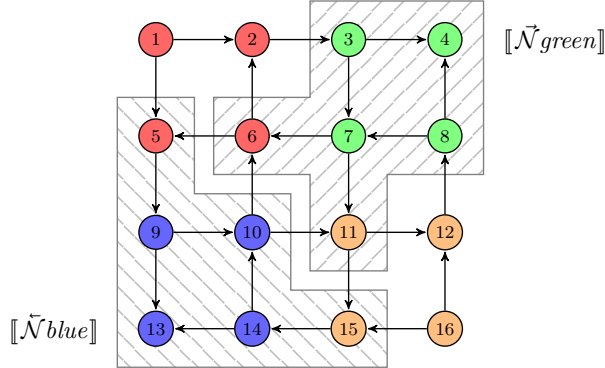
FIGURE 6. Points satisfying $\vec{\mathcal{N}}green$ and $\vec{\mathcal{N}}blue$.

Example 4.9. Consider the QdCM given in Figure 6 where states 1,2, 5, and 6 satisfy *red*, states 3,4, 7, and 8 satisfy *green*, states 9, 10, 13, and 14 satisfy *blue*, and states 11,12, 15, and 16 satisfy *orange*. The closure operator is as usual for directed graphs. The hatched upper-right area contains the states satisfying $\vec{\mathcal{N}}green$, the hatched lower-left area the states satisfying $\vec{\mathcal{N}}blue$, i.e.

$$\begin{aligned} \llbracket \vec{\mathcal{N}}green \rrbracket &= \{3, 4, 6, 7, 8, 11\} \\ \llbracket \vec{\mathcal{N}}blue \rrbracket &= \{5, 9, 10, 13, 14, 15\}. \end{aligned}$$

Equivalence for the logic IMLC is defined as usual.

Definition 4.10 (IMLC-equivalence). For a QdCM \mathcal{M} , the relation $\simeq_{\text{IMLC}}^{\mathcal{M}} \subseteq X \times X$ is defined by

$$x_1 \simeq_{\text{IMLC}}^{\mathcal{M}} x_2 \quad \text{iff} \quad \mathcal{M}, x_1 \models_{\text{IMLC}} \Phi \Leftrightarrow \mathcal{M}, x_2 \models_{\text{IMLC}} \Phi, \text{ for all } \Phi \in \text{IMLC}. \quad \bullet$$

Next we formulate two lemmas which are used to prove that CMC-bisimilarity and IMLC-equivalence coincide.

Lemma 4.11. For all points x_1, x_2 in QdCM \mathcal{M} , if $x_1 \equiv_{\text{CMC}}^{\mathcal{M}} x_2$ then $x_1 \simeq_{\text{IMLC}}^{\mathcal{M}} x_2$.

Proof. The proof is similar to that of Lemma 3.6. Let $\mathcal{M} = (X, \vec{\mathcal{C}}, \mathcal{V})$. We verify, by induction on the structure of the formula Φ , that $x_1 \models \Phi$ if and only if $x_2 \models \Phi$ for $x_1, x_2 \in X$ such that $x_1 \equiv_{\text{CMC}}^{\mathcal{M}} x_2$. We only cover the case for $\vec{\mathcal{N}}\Phi$.

For the case of $\vec{\mathcal{N}}\Phi$ we will exploit condition (2) of Definition 4.4. Suppose $x_1 \equiv_{\text{CMC}}^{\mathcal{M}} x_2$ and $x_1 \models \vec{\mathcal{N}}\Phi$. Then $x_1 \in \vec{\mathcal{C}}[\llbracket \Phi \rrbracket]$ by Definition 4.8. Thus exists $x'_1 \in X$ such that $x'_1 \models \Phi$ and $x_1 \in \vec{\mathcal{C}}(x'_1)$. By Lemma 2.9(i), we also have $x'_1 \in \vec{\mathcal{C}}(x_1)$. Since $x'_1 \in \vec{\mathcal{C}}(x_1)$ and $x_1 \equiv_{\text{CMC}}^{\mathcal{M}} x_2$ we obtain, from condition (2) of Definition 4.4, that $x'_2 \in \vec{\mathcal{C}}(x_2)$ exists such that $x'_1 \equiv_{\text{CMC}}^{\mathcal{M}} x'_2$. From $x'_1 \models \Phi$ we derive $x'_2 \models \Phi$ by induction hypothesis for Φ . Therefore, $x'_2 \in \llbracket \Phi \rrbracket$, $x_2 \in \vec{\mathcal{C}}(x'_2)$ by Lemma 2.9(i), and thus $x_2 \in \vec{\mathcal{C}}[\llbracket \Phi \rrbracket]$, which implies $x_2 \models \vec{\mathcal{N}}\Phi$. \square

For what concerns the other direction, i.e. going from IMLC-equivalence to CMC-bisimilarity, we show, as in the previous section, that logic equivalence is a bisimulation.

Lemma 4.12. For a QdCM \mathcal{M} , $\simeq_{\text{IMLC}}^{\mathcal{M}}$ is a CMC-bisimulation for \mathcal{M} .

Proof. Let $\mathcal{M} = (X, \vec{\mathcal{C}}, \mathcal{V})$. Define, for points $x, y \in X$, the IMLC-formula $\delta_{x,y}$ as the formula **true** if $x \simeq_{\text{IMLC}}^{\mathcal{M}} y$ and, otherwise, as a formula $\delta_{x,y}$ such that $x \models \delta_{x,y}$ and $y \models \neg \delta_{x,y}$.

Next, put $\chi(x) = \bigwedge_{y \in X} \delta_{x,y}$. Note, for $x, y \in X$, it holds that $y \in \llbracket \chi(x) \rrbracket$ if and only if $x \simeq_{\text{IMLC}} y$. In particular, $x \in \llbracket \chi(x) \rrbracket$.

In order to verify that \simeq_{IMLC} is a CMC-bisimulation we check the conditions of Definition 4.4. Suppose $x_1 \simeq_{\text{IMLC}} x_2$ for $x_1, x_2 \in X$; (i) clearly, $x_1 \in \mathcal{V}(p)$ iff $x_2 \in \mathcal{V}(p)$ since $x_1 \models p$ iff $x_2 \models p$. (ii) let $x'_1 \in \vec{\mathcal{C}}(x_1)$. Since $x_1 \in \vec{\mathcal{C}}(x'_1)$, by Lemma 2.9(i), and $x'_1 \in \llbracket \chi(x'_1) \rrbracket$ it holds that $x_1 \models \vec{\mathcal{N}}\chi(x'_1)$. By assumption also $x_2 \models \vec{\mathcal{N}}\chi(x'_1)$. Hence, for some $x'_2 \in X$ we have $x_2 \in \vec{\mathcal{C}}(x'_2)$ and $x'_2 \in \llbracket \chi(x'_1) \rrbracket$. Thus $x'_2 \in \vec{\mathcal{C}}(x_2)$ and $x'_1 \simeq_{\text{IMLC}} x'_2$. (iii) similar to (ii). \square

With the two lemmas above in place, we can establish the correspondence of CMC-bisimilarity and IMLC-equivalence.

Theorem 4.13. *For a QdCM \mathcal{M} it holds that $\simeq_{\text{IMLC}}^{\mathcal{M}}$ coincides with $\rightleftharpoons_{\text{CMC}}^{\mathcal{M}}$.*

Proof. On the one hand, $\rightleftharpoons_{\text{CMC}}^{\mathcal{M}} \subseteq \simeq_{\text{IMLC}}^{\mathcal{M}}$ by Lemma 4.11. On the other hand, $\simeq_{\text{IMLC}}^{\mathcal{M}} \subseteq \rightleftharpoons_{\text{CMC}}^{\mathcal{M}}$ by Lemma 4.12. \square

The following statement is an obvious consequence of Theorem 4.13.

Corollary 4.14. *For all QdCMs \mathcal{M} , $\rightleftharpoons_{\text{CMC}}^{\mathcal{M}}$ is an equivalence relation.*

Remark 4.15. Previous work of Ciancia et al. concerns (various iterations of) the Spatial Logic for Closure Spaces (SLCS) that is based on the *surrounded* operator \mathcal{S} and the *reachability* operator ρ , see e.g. [CLMV21, CLMV20, BCLM19b, CLLM16]. A point x satisfies $\Phi_1 \mathcal{S} \Phi_2$ if it lays in an area whose points satisfy Φ_1 , and that is delimited, i.e. surrounded, by points that satisfy Φ_2 . The point x satisfies $\rho \Phi_1[\Phi_2]$ if there is a path starting in x that *reaches* a point satisfying Φ_1 and whose intermediate points—if any—satisfy Φ_2 .

In [BCLM19b] it has been shown that the operator \mathcal{S} can be derived from the logical operator ρ . More specifically, $\Phi_1 \mathcal{S} \Phi_2$ is equivalent to $\Phi_1 \wedge \neg \rho(\neg(\Phi_1 \vee \Phi_2))[\neg \Phi_2]$. Furthermore, for QdCMs, the operator ρ gives rise to a pair of operators, namely $\vec{\rho}$, coinciding with ρ , and its ‘converse’ $\bar{\rho}$, meaning that a point x *can be reached from* a point satisfying Φ_1 via a path whose intermediate points—if any—satisfy Φ_2 . It is easy to see that, for such spaces, $\vec{\mathcal{N}}\Phi$ and $\bar{\mathcal{N}}\Phi$ are equivalent to $\vec{\rho}\Phi[\text{false}]$ and $\bar{\rho}\Phi[\text{false}]$, respectively, and that $\vec{\rho}\Phi_1[\Phi_2]$ is equivalent to a suitable (possibly) infinite disjunction of nested formulas using only conjunction and the IMLC $\vec{\mathcal{N}}$ proximity operator, involving Φ_1 and Φ_2 ; similarly $\bar{\rho}\Phi_1[\Phi_2]$ is equivalent to a formula using only conjunction and the IMLC $\bar{\mathcal{N}}$ operator. Thus, on QdCMs, IMLC and ISLCS—the infinitary version of SLCS [CLMV21]—share the same expressive power. The interested reader is referred to [CLMV22b].

5. CoPA-BISIMILARITY FOR QdCM

CM-bisimilarity, and its refinement CMC-bisimilarity, are a fundamental starting point for the study of spatial bisimulations due to their strong link with Topo-bisimulation. However, CM and CMC-bisimilarity are rather strong, i.e. fine-grained, notions of equivalence regarding their use for reasoning about general properties of space. For instance, in the QdCM given in Figure 7 (with points at the border satisfying the atomic proposition *green* and inner points satisfying atomic proposition *red*), point 13 in the center is *not* CMC-bisimilar to any other red point around it. This is because CMC-bisimilarity is based on reachability “in one step”, so to speak, as can be seen from Definition 4.4. This, in turn, provides CMC-bisimilarity with the ability to distinguish points based on their distance to a set that can be characterized by

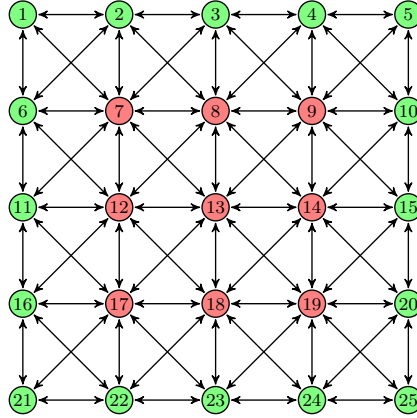

FIGURE 7. Red midpoint 13 not CMC-bisimilar to red points around it.

an IMLC-formula. This is inconsistent with the wish to consider in this model, for instance, all red points to be spatially equivalent. Along the same lines, one could desire to identify all ‘green’ points at the border as well as all inner ‘red’ points, obtaining a model of two points only, a ‘green’ one and a ‘red’.

In order to overcome the ‘counting’ capability of CMC-bisimilarity, one may think of considering *paths* instead of single ‘steps’. In fact in [CLMV21] we introduced such a bisimilarity, called Path-bisimilarity. This bisimilarity requires that, in order for two points to be bisimilar, for every path starting from one point, there must be a path starting from the other point having bisimilar end-points. However, as we discussed in Section 1, Path-bisimilarity is too weak. In particular because no constraints are put on intermediate points.

In order to come to a more constraining definition, hence a notion of bisimulation weaker than CMC-bisimulation, a deeper insight into the structure of a path is desirable as well as some, relatively high-level, requirements regarding paths. For this purpose we resort to a form of compatibility between paths that essentially requires each of them to be composed of non-empty, adjacent and interrelated ‘zones’.

Informally, two such paths under consideration should share the same structure as in Figure 2. We see that (i) both paths can be seen as comprised of corresponding zones—the number of such zones in each path being equal and positive, (ii) points in corresponding zones are bisimilar, although (iii) the length of corresponding zones—and thus of the two paths—may be different.

We first formalise the notion of compatibility of paths in a quasi-discrete closure model.

Definition 5.1 (Path-compatibility). Given QdCM $\mathcal{M} = (X, \vec{\mathcal{C}}, \mathcal{V})$ and $B \subseteq X \times X$ a relation. Two forward (respectively backward) paths $\pi_1 = (x'_i)_{i=0}^\ell$ and $\pi_2 = (x''_j)_{j=0}^m$ in \mathcal{M} are called *compatible* with respect to B in \mathcal{M} if, for some $N > 0$, two total monotone surjections $f : [0; \ell] \rightarrow [1; N]$ and $g : [0; m] \rightarrow [1; N]$ exist such that $B(x'_i, x''_j)$ for all indices $i \in [0; \ell]$ and $j \in [0; m]$ satisfying $f(i) = g(j)$.

The functions f and g are referred to as *matching functions*. Note that both the number N and functions f and g need not be unique. The minimal number $N > 0$ for which matching functions exist is defined to be the number of zones of the two paths π_1 and π_2 .

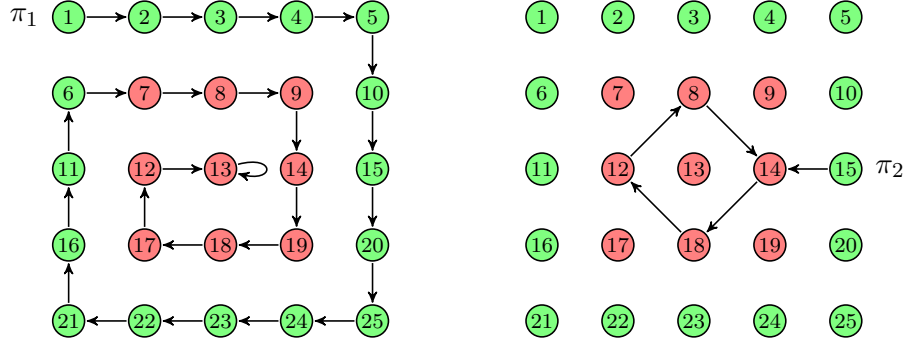

FIGURE 8. F-compatible path for points 1 and 15

It is easy to see that, whenever two paths are compatible, for any pair of matching function f and g the following holds, by virtue of monotonicity and surjectivity: $f(0) = 1$ and $g(0) = 1$ and $f(\ell) = g(m)$. Hence $B(x'_0, x''_0)$ and $B(x'_\ell, x''_m)$. Thus, for paths that are compatible with respect to the relation involved, the start and end points are related.

Example 5.2. With reference to the QdCM \mathcal{M} given in Figure 7, let us consider forward path π_1 of length 27 starting in point 1 and forward path π_2 of length 10 starting in point 15, as indicated in Figure 8. In more detail,

$$\begin{aligned} \pi_1 &= (1, 2, 3, 4, 5, 10, 15, 20, 25, 24, 23, 22, 21, \\ &\quad 16, 11, 6, 7, 8, 9, 14, 19, 18, 17, 12, 13, 13, 13, 13) \\ \pi_2 &= (15, 14, 18, 12, 8, 14, 18, 12, 8, 14, 18) \end{aligned}$$

The paths are compatible. Possible matching functions are $f : [0; 27] \rightarrow [1; 2]$ and $g : [0; 10] \rightarrow [1; 2]$ where $f(i) = 1$ for $0 \leq i \leq 15$, $f(i) = 2$ for $16 \leq i \leq 27$ and $g(0) = 1$ and $g(j) = 2$ for $1 \leq j \leq 10$. Thus ‘green’ states are in zone 1, ‘red’ states are in zone 2.

The above notion of compatibility give rise to what is called *Compatible Path bisimilarity* or *CoPa-bisimilarity* as defined below.

Definition 5.3 (CoPa-bisimilarity). Let QdCM $\mathcal{M} = (X, \vec{\mathcal{C}}, \mathcal{V})$ be given. A symmetric relation $B \subseteq X \times X$ is a *CoPa-bisimulation* for \mathcal{M} if, whenever $B(x_1, x_2)$ for points $x_1, x_2 \in X$, the following holds:

- (1) $x_1 \in \mathcal{V}(p)$ iff $x_2 \in \mathcal{V}(p)$ for all $p \in \text{AP}$.
- (2) For each forward path π_1 from x_1 there exists a compatible forward path π_2 from x_2 with respect to B in \mathcal{M} .
- (3) For each backward path π_1 from x_1 there exists a compatible backward path π_2 from x_2 with respect to B in \mathcal{M} .

Two points $x_1, x_2 \in X$ are called *CoPa-bisimilar* in \mathcal{M} if $B(x_1, x_2)$ for some CoPa-bisimulation B for \mathcal{M} . Notation, $x_1 \rightleftharpoons_{\text{CoPa}}^{\mathcal{M}} x_2$. •

Example 5.4. To see that, e.g., the points 7 and 13 in the closure model \mathcal{M} of Figure 7 are CoPa-bisimilar, we consider the relation $B = (\mathcal{V}(\text{green}) \times \mathcal{V}(\text{green})) \cup (\mathcal{V}(\text{red}) \times \mathcal{V}(\text{red})) \subseteq X \times X$, among others relating 7 and 13. We see that in \mathcal{M} , all pairs of ‘green’ points and all pairs of ‘red’ points are related by B .

- (i) Suppose $B(x_1, x_2)$ for two points x_1 and x_2 . Then $x_1 \in \mathcal{V}(p)$ iff $x_2 \in \mathcal{V}(p)$ by definition

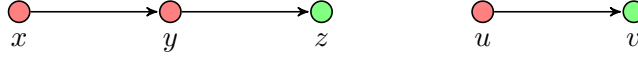
FIGURE 9. $x \rightleftharpoons_{\text{CoPa}} u$ and $x \not\rightleftharpoons_{\text{CMC}} u$.

of \mathcal{V} and B .

(ii) Suppose $B(x_1, x_2)$ for two points x_1 and x_2 . We only treat the case where x_1 is the point 13 in the middle and x_2 is not; the other cases are similar and/or simpler. Let $\pi_1 = (x'_i)_{i=0}^\ell$ be a forward path in \mathcal{M} starting from x_1 . The path π_1 shows an alternation of red and green points, not necessarily strict, starting from red. We construct a path π_2 with the same alternation of color. Choose $x_r \in \vec{\mathcal{C}}(x_2) \setminus \{13\}$ such that $\mathcal{V}(x_r) = \text{red}$ and $x_g \in \vec{\mathcal{C}}(x_r)$ such that $\mathcal{V}(x_g) = \text{green}$. We define the forward path $\pi_2 = (x''_j)_{j=0}^\ell$ in \mathcal{M} , of the same length as π_1 , as follows: $x''_0 = x_2$ and for $j \in (0; \ell]$, $x''_j = x_g$ if $x'_j \in \mathcal{V}(\text{green})$ and $x''_j = x_r$ if $x'_j \in \mathcal{V}(\text{red})$. Note that π_2 is a forward path from x_2 in \mathcal{M} indeed, by choice of the points x_r and x_g . To check the compatibility of π_1 and π_2 with respect to the relation B we choose as matching functions $f, g : [0; \ell] \rightarrow [1; \ell + 1]$ satisfying $f(i) = i+1$ and $g(j) = j+1$ for $0 \leq i, j \leq \ell$. Clearly, if $f(i) = g(j)$ then $i = j$, from which $\mathcal{V}(x'_i) = \mathcal{V}(x''_j)$ and $B(x'_i, x''_j)$ follow.

(iii) Compatibility of backward paths for x_1 and x_2 can be checked in a similar way.

In [CLMV22a] a definition of CoPa-bisimilarity has been presented that is different from Definition 5.3. In the Appendix, we recall the definition given in [CLMV22a] and we show that it is equivalent to Definition 5.3. We prefer the latter since it better conveys the intuitive notion of the “zones” in the relevant paths.

The next lemma captures the fact that CMC-bisimilarity is included in CoPa-bisimilarity.

Lemma 5.5. $\rightleftharpoons_{\text{CMC}}^{\mathcal{M}} \subseteq \rightleftharpoons_{\text{CoPa}}^{\mathcal{M}}$ for every QdCM \mathcal{M} .

Proof. Suppose $\mathcal{M} = (X, \mathcal{C}, \mathcal{V})$ is a QdCM. Let x_1 and x_2 be two points of \mathcal{M} such that $B(x_1, x_2)$ for some CMC-bisimulation $B \subseteq X \times X$. We check the conditions for the symmetric relation B to be a CoPa-bisimulation.

(i) Clearly, since B is a CMC-bisimulation, $x_1 \in \mathcal{V}(p)$ iff $x_2 \in \mathcal{V}(p)$ for all $p \in \text{AP}$.

(ii) Let $\pi_1 = (x'_i)_{i=0}^\ell$ be a forward path from x_1 . Define a path $\pi_2 = (x''_j)_{j=0}^\ell$ in \mathcal{M} from x_2 as follows: $x''_0 = x_2$ and $x''_{j+1} \in X$ is such that $x''_{j+1} \in \vec{\mathcal{C}}(x''_j)$ and $B(x'_{j+1}, x''_{j+1})$ for $0 < j \leq \ell$. This is possible because B is a CMC-bisimulation. Then π_2 is a forward path from x_2 . Moreover, the pair of functions $f, g : [0; \ell] \rightarrow [1; \ell + 1]$ with $f(i) = i+1$ and $g(j) = j+1$ for $0 \leq i, j \leq \ell$, show that π_1 and π_2 are compatible.

(iii) Similar to case (ii). \square

The converse of Lemma 5.5 does not hold. With reference to the quasi-discrete closure model in Figure 9 for which $\mathcal{V}(\text{red}) = \{x, y, u\}$ and $\mathcal{V}(\text{green}) = \{z, v\}$, it is easy to see that the symmetric closure of the relation $B = \{(x, u), (y, u), (z, v)\}$ is a CoPa-bisimulation, and so $x \rightleftharpoons_{\text{CoPa}} u$. However, there is no relation B such that $x \rightleftharpoons_{\text{CMC}} u$, because there is a green point in $\vec{\mathcal{C}}(u)$ whereas no green point belongs to the $\vec{\mathcal{C}}(x)$.

More formally, in order to check that for every forward path $\pi_1 = (x'_i)_{i=0}^\ell$ from u a compatible path $\pi_2 = (x''_j)_{j=0}^m$ from x exists, we reason as follows, considering two cases:

Case 1: If $\text{range}(\pi_1) = \{u\}$ we choose π_2 such that $\text{range}(\pi_2) = \{x\}$. The constant mappings $f : [0; \ell] \rightarrow \{1\}$ and $g : [0; m] \rightarrow \{1\}$ are matching functions for π_1 and π_2 .

Case 2: Otherwise, for some $k > 0$, $x'_i = v$ for all $i \geq k$. Put $m = \ell + 1$, $x''_0 = x$, $x''_1 = y$, and $x''_j = z$ for $j \geq 2$. Now, $f : [0; \ell] \rightarrow [1; 2]$ such that $f(i) = 1$ for $0 \leq i < k$, $f(i) = 2$ for $k \leq i \leq \ell$ and $g : [0; \ell + 1] \rightarrow [1; 2]$ such that $g(j) = 1$ for $0 \leq j \leq k$, $g(j) = 2$ for $k < j \leq \ell + 1$ are matching functions.

Although $x \rightleftharpoons_{\text{CoPa}} u$, we have that $x \not\equiv_{\text{CMC}} u$. In fact, we have $u \models \tilde{N}green$ whereas $x \not\models \tilde{N}green$ and therefore, by Theorem 4.13, the point u is not CMC-bisimilar to the point x .

One can argue that CoPa-bisimilarity for QdCSs is conceptually the same as Divergence-blind Stuttering Equivalence for Kripke structures, DBS-equivalence for short. We recall the definition of DBS-equivalence from [GJKW17] below:

Definition 5.6 (Definition 2.2 of [GJKW17]). Let $K = (S, \text{AP}, \rightarrow, L)$ be a Kripke structure. A symmetric relation $R \subseteq S \times S$ is a DBS-equivalence if and only if, for all $s, t \in S$ such that $R(s, t)$:

- (1) $L(s) = L(t)$, and
- (2) for all $s' \in S$, if $s \rightarrow s'$, then there are $t_0, \dots, t_k \in S$ for some $k \in \mathbb{N}$ such that $t_0 = t$, $R(s, t_i)$, $t_i \rightarrow t_{i+1}$ for all $i < k$, and $R(s', t_k)$.

We say that two states $s, t \in S$ are DBS-equivalent if and only if there is a DBS-equivalence relation R such that $R(s, t)$. •

Taking the specific structure of closure spaces into account, as well as the back-and-forth aspect of such spaces, the standard definition of DBS-equivalence can be rearranged for QdCMs as follows.

Definition 5.7 (DBS-bisimilarity for QdCMs). Let $\mathcal{M} = (X, \vec{\mathcal{C}}, \mathcal{V})$ be a QdCM. A symmetric relation $B \subseteq X \times X$ is called a DBS-bisimulation for QdCM \mathcal{M} if whenever $B(x_1, x_2)$ for points $x_1, x_2 \in X$, the following holds:

- (1) $x_1 \in \mathcal{V}(p)$ if and only if $x_2 \in \mathcal{V}(p)$ for all $p \in \text{AP}$.
- (2) For all $x'_1 \in \vec{\mathcal{C}}(x_1)$ exist $n \geq 0$ and $y_0, \dots, y_n \in X$ such that $y_0 = x_2$, $y_{i+1} \in \vec{\mathcal{C}}(y_i)$ and $B(x_1, y_i)$ for $0 \leq i < n$, and $B(x'_1, y_n)$.
- (3) For all $x'_1 \in \vec{\mathcal{C}}(x_1)$ exist $n \geq 0$ and $y_0, \dots, y_n \in X$ such that $y_0 = x_2$, $y_{i+1} \in \vec{\mathcal{C}}(y_i)$ and $B(x_1, y_i)$ for $0 \leq i < n$, and $B(x'_1, y_n)$.

Two points $x_1, x_2 \in X$ are called DBS-bisimilar in \mathcal{M} , if $B(x_1, x_2)$ for some DBS-bisimulation B for \mathcal{M} . Notation, $x_1 \rightleftharpoons_{\text{DBS}}^{\mathcal{M}} x_2$. •

It holds that CoPa-bisimilarity and DBS-bisimilarity coincide. We split the proof of this into two lemmas.

Lemma 5.8. *For each QdCM \mathcal{M} it holds that $\rightleftharpoons_{\text{CoPa}}^{\mathcal{M}} \subseteq \rightleftharpoons_{\text{DBS}}^{\mathcal{M}}$.*

Proof. A CoPa-bisimulation $B \subseteq X \times X$ is a DBS-bisimulation as well:

- (i) The first requirement of Definition 5.7 is immediate.
- (ii) In order to verify the second requirement of Definition 5.7, suppose $B(x_1, x_2)$ and $x'_1 \in \vec{\mathcal{C}}(x_1)$. We note that $\pi_1 = (x_1, x'_1)$ is a forward path from x_1 in \mathcal{M} . Since $B(x_1, x_2)$ and B is a CoPa-bisimulation, a forward path $\pi_2 = (x''_j)_{j=0}^m$ from x_2 exists that is compatible to π_1 with respect to B . So, $x''_{j+1} \in \vec{\mathcal{C}}(x''_j)$ for $0 \leq j < m$. Let $N > 0$ and $f : [0; 1] \rightarrow [1; N]$, $g : [0; m] \rightarrow [1; N]$ be matching functions for π_1 and π_2 .

Proof. Let $\mathcal{M} = (X, \mathcal{C}, \mathcal{V})$ be a QdCM. We show that a DBS-bisimulation $B \subseteq X \times X$ for \mathcal{M} is a CoPa-bisimulation for \mathcal{M} as well. We verify the three requirements of Definition 5.3.

(i) Clearly, if $B(x_1, x_2)$ for two points $x_1, x_2 \in X$ we have $x_1 \in \mathcal{V}(p)$ iff $x_2 \in \mathcal{V}(p)$ for all $p \in \text{AP}$ by definition of a DBS-bisimulation.

(ii) To see that the second requirement for a CoPa-bisimulation is met, we prove the following claim by induction on ℓ_1 : (*Claim*) For all $\ell_1 \geq 0$, if $B(x_1, x_2)$ for two points $x_1, x_2 \in X$ and π_1 is a forward path of length ℓ_1 from x_1 in \mathcal{M} , then a forward path π_2 from x_2 in \mathcal{M} exists that is compatible with π_1 with respect to B .

Base, $\ell_1 = 0$: The path π_1 consists of x_1 only. The path π_2 consisting of x_2 only, is a forward path from x_2 that is compatible to π_1 with respect to B .

Induction step, $\ell_1 > 0$: Put $x'_1 = \pi_1(1)$. We have $x'_1 \in \vec{\mathcal{C}}(x_1)$ since π_1 is a forward path. Because B is a DBS-bisimulation and $B(x_1, x_2)$, exist $n \geq 0$ and $y_0, \dots, y_n \in X$ such that $y_0 = x_2$, $y_{i+1} \in \vec{\mathcal{C}}(y_i)$ and $B(x_1, y_i)$ for $0 \leq i < n$, and $B(x'_1, y_n)$. We split the path π_1 into the subpaths π'_1 and π''_1 where π'_1 is the restriction of π_1 to $[0; 1]$, i.e. $\pi'_1 = \pi_1|_{[0; 1]}$, and π''_1 is the 1-shift of π_1 , i.e. $\pi''_1 b = \pi_1 \uparrow 1$. Then $\pi'_2 = (y_i)_{i=0}^n$ is a forward path in \mathcal{M} from x_2 that is compatible with respect to B with the path $\pi'_1 = (x_1, x'_1)$ from x_1 . The subpath π''_1 in \mathcal{M} is of length $\ell_1 - 1$ and is a forward path from x'_1 . Since $B(x'_1, y_n)$, by induction hypothesis a path π''_2 from y_n exists that is compatible with π''_1 with respect to B . Let the path $\pi_2 = \pi'_2 \cdot \pi''_2$ be the concatenation of the forward paths π'_2 and π''_2 . Then π_2 is a forward path in \mathcal{M} from x_2 that is compatible with $\pi'_1 \cdot \pi''_1 = \pi_1$ with respect to B .

(iii) Similar to case (ii). \square

In order to provide a logical characterisation of CoPa-bisimilarity, we replace the proximity modalities $\vec{\mathcal{N}}$ and $\check{\mathcal{N}}$ in IMLC by the (forward and backward) conditional reachability modalities $\vec{\zeta}$ and $\check{\zeta}$ to obtain the Infinitary Compatible Reachability Logic, or ICRL for short.

Definition 5.10 (ICRL). The abstract language of ICRL is defined as follows:

$$\Phi ::= p \mid \neg \Phi \mid \bigwedge_{i \in I} \Phi_i \mid \vec{\zeta} \Phi_1[\Phi_2] \mid \check{\zeta} \Phi_1[\Phi_2]$$

where p ranges over AP and I ranges over a collection of index sets. The satisfaction relation with respect to a QdCM \mathcal{M} , point $x \in \mathcal{M}$, and ICRL formula Φ is defined recursively on the structure of Φ as follows:

$$\begin{aligned} \mathcal{M}, x \models_{\text{ICRL}} p &\Leftrightarrow x \in \mathcal{V}(p) \\ \mathcal{M}, x \models_{\text{ICRL}} \neg \Phi &\Leftrightarrow \mathcal{M}, x \not\models_{\text{ICRL}} \Phi \text{ does not hold} \\ \mathcal{M}, x \models_{\text{ICRL}} \bigwedge_{i \in I} \Phi_i &\Leftrightarrow \mathcal{M}, x \models_{\text{ICRL}} \Phi_i \text{ for all } i \in I \\ \mathcal{M}, x \models_{\text{ICRL}} \vec{\zeta} \Phi_1[\Phi_2] &\Leftrightarrow \text{a forward path } (x_i)_{i=0}^\ell \text{ from } x \text{ exists such that} \\ &\quad \mathcal{M}, x_\ell \models_{\text{ICRL}} \Phi_1, \text{ and } \mathcal{M}, x_j \models_{\text{ICRL}} \Phi_2 \text{ for } j \in [0, \ell) \\ \mathcal{M}, x \models_{\text{ICRL}} \check{\zeta} \Phi_1[\Phi_2] &\Leftrightarrow \text{a backward path } (x_i)_{i=0}^\ell \text{ from } x \text{ exists such that} \\ &\quad \mathcal{M}, x_\ell \models_{\text{ICRL}} \Phi_1, \text{ and } \mathcal{M}, x_j \models_{\text{ICRL}} \Phi_2 \text{ for } j \in [0, \ell) \quad \bullet \end{aligned}$$

Informally, x satisfies $\vec{\zeta} \Phi_1[\Phi_2]$ if it satisfies Φ_1 , or it satisfies Φ_2 and there is a point satisfying Φ_1 that can be reached from x via a path whose intermediate points, if any, satisfy Φ_2 . Similarly, x satisfies $\check{\zeta} \Phi_1[\Phi_2]$ if it satisfies Φ_1 , or it satisfies Φ_2 and there is a point satisfying Φ_1 from which x can be reached via a path whose intermediate points, if any, satisfy Φ_2 .

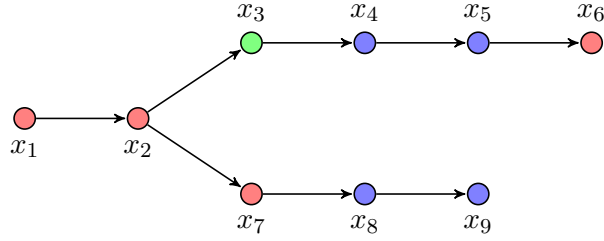

FIGURE 12

Example 5.11. Consider the QdCM \mathcal{M} depicted in Figure 12. With respect to \mathcal{M} we have, for example, that $\vec{\zeta}_{red}[red]$ is satisfied by x_1, x_2, x_6 , and x_7 , $\vec{\zeta}_{red}[blue]$ is satisfied by x_1, x_2, x_4, x_5, x_6 , and x_7 , $\vec{\zeta}(\vec{\zeta}_{red}[blue])[\neg blue]$ is satisfied by $x_1, x_2, x_3, x_4, x_5, x_6$, and x_7 , $\neg(\vec{\zeta}(\vec{\zeta}_{red}[blue])[\neg blue])$ is satisfied by x_8 , and x_9 , and $\vec{\zeta}_{red}[blue]$ is satisfied by x_1, x_2, x_6, x_7, x_8 , and x_9 .

Also for ICRL we introduce a notion of equivalence.

Definition 5.12 (ICRL-equivalence). Given a QdCM $\mathcal{M} = (X, \mathcal{C}, \mathcal{V})$, the relation $\simeq_{\text{ICRL}}^{\mathcal{M}} \subseteq X \times X$ is defined by

$$x_1 \simeq_{\text{ICRL}}^{\mathcal{M}} x_2 \text{ iff } \mathcal{M}, x_1 \models_{\text{ICRL}} \Phi \Leftrightarrow \mathcal{M}, x_2 \models_{\text{ICRL}} \Phi, \text{ for all } \Phi \in \text{ICRL}.$$

•

We first check that CoPa-bisimulation respects ICRL-equivalence.

Lemma 5.13. For x_1, x_2 in QdCM \mathcal{M} , if $x_1 \rightleftharpoons_{\text{CoPa}}^{\mathcal{M}} x_2$ then $x_1 \simeq_{\text{ICRL}}^{\mathcal{M}} x_2$. \square

Proof. Let $\mathcal{M} = (X, \mathcal{C}, \mathcal{V})$ be a QdCM. We verify that for all $x_1, x_2 \in X$ such that $x_1 \rightleftharpoons_{\text{CoPa}} x_2$ and $x_1 \models \Phi$ implies $x_2 \models \Phi$, by induction on the structure of Φ in ICRL. We only cover the case $\vec{\zeta}\Phi_1[\Phi_2]$. The proof for the case $\zeta\Phi_1[\Phi_2]$ is similar, while that for the other cases is straightforward.

Let x_1 and x_2 be two points of \mathcal{M} such that $x_1 \rightleftharpoons_{\text{CoPa}} x_2$. Suppose $x_1 \models \vec{\zeta}\Phi_1[\Phi_2]$. Let $\pi_1 = (x'_i)_{i=0}^{k_1}$ be a forward path from x_1 satisfying $\pi_1(k_1) \models \Phi_1$ and $\pi_1(i) \models \Phi_2$ for $0 \leq i < k_1$. Since $x_1 \rightleftharpoons_{\text{CoPa}} x_2$, a forward path $\pi_2 = (x''_i)_{i=0}^{k_2}$ from x_2 exists that is compatible with π_1 with respect to $\rightleftharpoons_{\text{CoPa}}$. Let, for appropriate $N > 0$, $f : [0; k_1] \rightarrow [1; N]$ and $g : [0; k_2] \rightarrow [1; N]$ be matching functions for π_1 and π_2 . Without loss of generality, $g^{-1}(\{N\}) = \{k_2\}$. Since $f(k_1) = g(k_2) = N$, we have $\pi_1(k_1) \rightleftharpoons_{\text{CoPa}} \pi_2(k_2)$. Thus $\pi_2(k_2) \models \Phi_1$ by induction hypothesis. Moreover, if $0 \leq j < k_2$, then $g(j) < N$ by assumption and $f(i) = g(j)$ and $\pi_1(i) \rightleftharpoons_{\text{CoPa}} \pi_2(j)$ for some i , $0 \leq i < k_1$. Since $\pi_1(i) \models \Phi_2$ it follows that $\pi_2(j) \models \Phi_2$ by induction hypothesis. Therefore path π_2 witnesses $x_2 \models \vec{\zeta}\Phi_1[\Phi_2]$. \square

The converse of Lemma 5.13 stating that ICRL-equivalent points are CoPa-bisimilar, is given below.

Lemma 5.14. For a QdCM \mathcal{M} , \simeq_{ICRL} is a CoPa-bisimulation for \mathcal{M} . \square

Proof. Let \mathcal{M} be a quasi-discrete closure model. We check that \simeq_{ICRL} satisfies requirement (ii) of Definition 5.3. Requirement (i) is immediate; requirement (iii) can be verified, with appropriate auxiliary definitions, similar to requirement (ii).

Let, for points $x, y \in X$, the ICRL-formula $\delta_{x,y}$ be such that $\delta_{x,y}$ is **true** if $x \simeq_{\text{ICRL}} y$, and $x \models \delta_{x,y}$ and $y \models \neg\delta_{x,y}$ if $x \not\simeq_{\text{ICRL}} y$. Put $\chi(x) = \bigwedge_{y \in X} \delta_{x,y}$. As before, for points $x, y \in X$, it holds that $x \models \chi(y)$ iff $x \simeq_{\text{ICRL}} y$.

Let the function $\text{zones} : \text{FPaths}^{\text{F}} \rightarrow \mathbb{N}$ be such that, for a forward path $\pi = (x_i)_{i=0}^n$,

$$\begin{aligned} \text{zones}(\pi) &= 1 && \text{if } n = 0 \\ \text{zones}(\pi) &= \text{zones}(\pi') && \text{if } n > 0 \text{ and } x_0 \simeq_{\text{ICRL}} x_1 \\ \text{zones}(\pi) &= \text{zones}(\pi') + 1 && \text{if } n > 0 \text{ and } x_0 \not\simeq_{\text{ICRL}} x_1 \end{aligned}$$

where $\pi' = (x_i)_{i=1}^n$. A forward path π is said to have n zones, if $\text{zones}(\pi) = n$.

Claim For all $k \geq 1$, for all $x_1, x_2 \in X$, if $x_1 \simeq_{\text{ICRL}} x_2$ and π_1 is a forward path from x_1 of k zones, then a forward path π_2 from x_2 exists that is compatible to π_1 with respect to \simeq_{ICRL} . The claim is proven by induction on k .

Base case, $k = 1$: If $x_1 \simeq_{\text{ICRL}} x_2$ and $\pi_1 = (x'_i)_{i=0}^n$ is a forward path from x_1 of 1 zone, then $x_1 \simeq_{\text{ICRL}} x'_i$ for $0 \leq i \leq n$. Let π_2 be the forward path consisting of x_2 only. Since $x_1 \simeq_{\text{ICRL}} x_2$, also $x_2 \simeq_{\text{ICRL}} x'_i$ for $0 \leq i \leq n$. Hence, π_2 is compatible with π_1 with respect to \simeq_{ICRL} .

Induction step, $k+1$: Suppose $x_1 \simeq_{\text{ICRL}} x_2$ and $\pi_1 = (x'_i)_{i=0}^n$ is a forward path from x_1 of $k+1$ zones. So, let $m > 0$ be such that $x_1 \simeq_{\text{ICRL}} x'_i$ for $0 \leq i < m$ and $x_1 \not\simeq_{\text{ICRL}} x'_m$. Then it holds that $x_1 \models \vec{\zeta}\chi(x'_m)[\chi(x_1)]$. Since $x_2 \simeq_{\text{ICRL}} x_1$ also $x_2 \models \vec{\zeta}\chi(x'_m)[\chi(x_1)]$. Thus, a forward path π' from x_2 exists such that $\pi'(\ell) \models \chi(x'_m)$ and $\pi'(j) \models \chi(x_1)$ for $0 \leq j < \ell$. We have that $x'_m \simeq_{\text{ICRL}} \pi'(\ell)$ —because $\pi'(\ell) \models \chi(x'_m)$ —and the forward path $\pi_1[m; n]$ from x'_m has k zones. By induction hypothesis exists a forward path π'' from $\pi(\ell)$ that is compatible to $\pi'_1[m; n]$. Then the path $\pi' \cdot \pi''$, the concatenation of π' and π'' , is a forward path from x_2 that is compatible with the path π_1 .

Requirement (ii) of Definition 5.3 follows directly from the claim. We conclude that \simeq_{ICRL} is a CoPa-bisimulation, as was to be shown. \square

The correspondence between ICRL-equivalence and CoPa-bisimilarity is summarized by the following theorem.

Theorem 5.15. *For every QdCM \mathcal{M} it holds that ICRL-equivalence $\simeq_{\text{ICRL}}^{\mathcal{M}}$ coincides with CoPa-bisimilarity $\simeq_{\text{CoPa}}^{\mathcal{M}}$.*

Proof. Direct from Lemma 5.5 and Lemma 5.14. \square

6. CONCLUSIONS

In this paper we have studied three bisimilarities for closure spaces, namely (i) *Closure Model bisimilarity* (CM-bisimilarity), (ii) its specialisation for QdCMs, namely *CM-bisimilarity with converse* (CMC-bisimilarity), and (iii) *Compatible Paths bisimilarity* (CoPa-bisimilarity), a conditional form of Path-bisimilarity. For each bisimilarity we introduced a spatial logic and we proved that the associated logical equivalence coincides with the relevant bisimilarity.

CM-bisimilarity is a generalisation for CMs of classical Topo-bisimilarity for topological spaces. CMC-bisimilarity takes into consideration the fact that, in QdCMs, there is a notion of “direction” given by the binary relation underlying the closure operator. This can be exploited in order to obtain an equivalence—namely CMC-bisimilarity—that, for QdCMs, refines CM-bisimilarity. In several applications, e.g. image analysis, weaker notions, such as spatial conditional reachability, are more appropriate. This notion cannot be captured

conveniently using CM-bisimilarity or CMC-bisimilarity since both relations are too strong, in the sense that they can “count” the number of single closure steps. To capture such weaker notion we introduce CoPa-bisimilarity, a stronger version of Path-bisimilarity — first proposed in [CLMV21] — but weaker than CMC-bisimilarity. CoPa-bisimilarity expresses path “compatibility” in a way that resembles the concept of Stuttering Equivalence for Kripke Structures [BCG88]. We have proven that CoPa-bisimilarity coincides with (an adaptation to closure models of) Divergence-blind Stuttering Equivalence [GJKW17].

The practical relevance of the study presented in this paper stems from the fact that bisimilarity gives rise to the notion of a minimal model. Such minimal models, when computable, can be effectively used for optimising spatial model checking procedures, when the bisimilarity preserves logical equivalence. This is indeed the case for all spatial equivalences proposed in this paper. In fact, in [CLMV20] a minimisation algorithm has been presented for CMC-bisimilarity. That paper also introduces `MiniLogicA`, a minimisation tool for CMC-bisimilarity. In [CGL⁺23] an encoding of (finite) QdCMs into labelled transition systems has been defined such that two points are CoPa-bisimilar if and only if their images via the encoding are Branching bisimulation equivalent. This enables the exploitation of very efficient minimisation algorithms for Branching bisimulation equivalence, as e.g. those in [GJKW17], in order to compute the minimal QdCM with respect to CoPa-bisimilarity and then apply spatial model-checking to the latter.

Many results we have shown in this paper concern QdCMs; we think the investigation of their extension to continuous or general closure spaces is an interesting line of future research. A significant first step in that direction is proposed in [BCG⁺22] where a technique for `SLCS` model-checking on polyhedra in Euclidean spaces has been proposed as well as an efficient model checker for 2D and 3D spaces, that enhances the spatial model-checker `VoxLogicA`.

In [CLMV20] we investigated a coalgebraic view of QdCMs that was useful for the definition of the minimisation algorithm for CMC-bisimilarity. It would be interesting to study a similar approach for Path-bisimilarity and CoPa-bisimilarity.

In [HKP09], coalgebraic bisimilarity is developed for a general kind of models, generalising the topological ones, known as Neighbourhood Frames. The development of the corresponding Hennessy-Milner style theorems for logics with reachability such as `SLCS`, by enriching the class of Neighbourhood Frames with a notion of path, could be an interesting addition to that theory.

REFERENCES

- [Aie02] Marco Aiello. *Spatial Reasoning: Theory and Practice*. PhD thesis, Institute of Logic, Language and Computation, University of Amsterdam, 2002.
- [Aie03] Marco Aiello. The topo-approach to spatial representation and reasoning. *AIIA NOTIZIE*, 16(4):5–14, 2003.
- [BB07] Johan van Benthem and Guram Bezhanishvili. Modal logics of space. In Marco Aiello, Ian Pratt-Hartmann, and Johan van Benthem, editors, *Handbook of Spatial Logics*, pages 217–298. Springer, 2007. doi:10.1007/978-1-4020-5587-4_5.
- [BBC⁺20] Fabrizio Banci Buonamici, Gina Belmonte, Vincenzo Ciancia, Diego Latella, and Mieke Massink. Spatial logics and model checking for medical imaging. *Software Tools for Technology Transfer*, 22(2):195–217, 2020. doi:10.1007/s10009-019-00511-9.
- [BBC⁺21] Gina Belmonte, Giovanna Broccia, Vincenzo Ciancia, Diego Latella, and Mieke Massink. Feasibility of spatial model checking for nevus segmentation. In Simon Bliudze, Stefania Gnesi, Nico Plat, and Laura Semini, editors, *9th IEEE/ACM International Conference on Formal Methods*

- in *Software Engineering, FormaliSE@ICSE 2021, Madrid, Spain, May 17-21, 2021*, pages 1–12. IEEE, 2021. doi:10.1109/FormaliSE52586.2021.00007.
- [BBEY17] Johan van Benthem, Nick Bezhanishvili, Sebastian Enqvist, and Junhua Yu. Instantial neighbourhood logic. *The Review of Symbolic Logic*, 10(1):116–144, 2017. doi:10.1017/S1755020316000447.
- [BCG88] Michael C. Browne, Edmund M. Clarke, and Orna Grumberg. Characterizing finite Kripke structures in propositional temporal logic. *Theoretical Computer Science*, 59:115–131, 1988. doi:10.1016/0304-3975(88)90098-9.
- [BCG⁺22] Nick Bezhanishvili, Vincenzo Ciancia, David Gabelaia, Gianluca Grilletti, Diego Latella, and Mieke Massink. Geometric Model Checking of Continuous Space. *Logical Methods in Computer Science*, Volume 18, Issue 4, November 2022. URL: <https://lmcs.episciences.org/10348>, doi:10.46298/lmcs-18(4:7)2022.
- [BCLM19a] Gina Belmonte, Vincenzo Ciancia, Diego Latella, and Mieke Massink. Innovating medical image analysis via spatial logics. In Maurice H. ter Beek, Alessandro Fantechi, and Laura Semini, editors, *From Software Engineering to Formal Methods and Tools, and Back - Essays Dedicated to Stefania Gnesi on the Occasion of Her 65th Birthday*, volume 11865 of *Lecture Notes in Computer Science*, pages 85–109. Springer, 2019. doi:10.1007/978-3-030-30985-5_7.
- [BCLM19b] Gina Belmonte, Vincenzo Ciancia, Diego Latella, and Mieke Massink. VoxLogicA: A spatial model checker for declarative image analysis. In Tomás Vojnar and Lijun Zhang, editors, *Tools and Algorithms for the Construction and Analysis of Systems, Proc. TACAS 2019 Part I*, volume 11427 of *Lecture Notes in Computer Science*, pages 281–298. Springer, 2019. doi:10.1007/978-3-030-17462-0_16.
- [CC03] Luís Caires and Luca Cardelli. A spatial logic for concurrency (part I). *Information and Computation*, 186(2):194–235, 2003. doi:10.1016/S0890-5401(03)00137-8.
- [Če66] Eduard Čech. Topological Spaces. In Vlastimil Pták, editor, *Topological Spaces*, chapter III, pages 233–394. Publishing House of the Czechoslovak Academy of Sciences/Interscience Publishers, John Wiley & Sons, Prague/London-New York-Sydney, 1966. Revised edition by Zdeněk Frolíc and Miroslav Katětov. Scientific editor, Vlastimil Pták. Editor of the English translation, Charles O. Junge. MR0211373. URL: <http://dml.cz/dmlcz/402628>.
- [CG00] Luca Cardelli and Andrew D. Gordon. Anytime, anywhere: Modal logics for mobile ambients. In Mark N. Wegman and Thomas W. Reps, editors, *POPL 2000, Proceedings of the 27th ACM SIGPLAN-SIGACT Symposium on Principles of Programming Languages, Boston, Massachusetts, USA, January 19-21, 2000*, pages 365–377. ACM, 2000. doi:10.1145/325694.325742.
- [CGG⁺18] Vincenzo Ciancia, Stephen Gilmore, Gianluca Grilletti, Diego Latella, Michele Loreti, and Mieke Massink. Spatio-temporal model checking of vehicular movement in public transport systems. *International Journal of Software Tools and Technology Transfer*, 20(3):289–311, 2018. doi:10.1007/s10009-018-0483-8.
- [CGL⁺15] Vincenzo Ciancia, Gianluca Grilletti, Diego Latella, Michele Loreti, and Mieke Massink. An experimental spatio-temporal model checker. In Domenico Bianculli, Radu Calinescu, and Bernhard Rumpe, editors, *Software Engineering and Formal Methods - SEFM 2015 Collocated Workshops: ATSE, HOFM, MoKMaSD, and VERY*SCART, York, UK, September 7-8, 2015, Revised Selected Papers*, volume 9509 of *Lecture Notes in Computer Science*, pages 297–311. Springer, 2015. doi:10.1007/978-3-662-49224-6_24.
- [CGL⁺23] Vincenzo Ciancia, Jan Friso Groote, Diego Latella, Mieke Massink, and Erik P. de Vink. Minimisation of spatial models using branching bisimilarity. In Marsha Chechik, Joost-Pieter Katoen, and Martin Leucker, editors, *25th International Symposium, FM 2023, Lübeck, March 6–10, 2023, Proceedings*, *Lecture Notes in Computer Science*. Springer, 2023. To appear.
- [CLLM14] Vincenzo Ciancia, Diego Latella, Michele Loreti, and Mieke Massink. Specifying and verifying properties of space. In Josep Díaz, Ivan Lanese, and Davide Sangiorgi, editors, *Theoretical Computer Science - 8th IFIP TC 1/WG 2.2 International Conference, TCS 2014, Rome, Italy, September 1-3, 2014. Proceedings*, volume 8705 of *Lecture Notes in Computer Science*, pages 222–235. Springer, 2014. doi:10.1007/978-3-662-44602-7_18.

- [CLLM16] Vincenzo Ciancia, Diego Latella, Michele Loreti, and Mieke Massink. Model checking spatial logics for closure spaces. *Logical Methods Computer Science*, 12(4), 2016. doi:10.2168/LMCS-12(4:2)2016.
- [CLM19] Vincenzo Ciancia, Diego Latella, and Mieke Massink. Embedding RCC8D in the collective spatial logic CSLCS. In Michele Boreale, Flavio Corradini, Michele Loreti, and Rosario Pugliese, editors, *Models, Languages, and Tools for Concurrent and Distributed Programming - Essays Dedicated to Rocco De Nicola on the Occasion of His 65th Birthday*, volume 11665 of *Lecture Notes in Computer Science*, pages 260–277. Springer, 2019. doi:10.1007/978-3-030-21485-2_15.
- [CLMV20] Vincenzo Ciancia, Diego Latella, Mieke Massink, and Erik P. de Vink. Towards spatial bisimilarity for closure models: Logical and coalgebraic characterisations, 2020. arXiv:2005.05578.
- [CLMV21] Vincenzo Ciancia, Diego Latella, Mieke Massink, and Erik P. de Vink. On bisimilarities for closure spaces (preliminary version), 2021. arXiv:2105.06690.
- [CLMV22a] Vincenzo Ciancia, Diego Latella, Mieke Massink, and Erik P. de Vink. Back-and-forth in space: On logics and bisimilarity in closure spaces. In Nils Jansen, Marielle Stoelinga, and Petra van den Bos, editors, *A Journey From Process Algebra via Timed Automata to Model Learning - A Festschrift Dedicated to Frits Vaandrager on the Occasion of His 60th Birthday*, volume 13560 of *Lecture Notes in Computer Science*, pages 98–115. Springer, 2022. doi:10.1007/978-3-031-15629-8_6.
- [CLMV22b] Vincenzo Ciancia, Diego Latella, Mieke Massink, and Erik P. de Vink. On the expressive power of ISLCS and IMLC. Technical Report ISTI-TR-2022/021, CNR-ISTI, 2022. doi:10.32079/ISTI-TR-2022/021.
- [CR08] Anthony G. Cohn and Jochen Renz. Qualitative spatial representation and reasoning. In Frank van Harmelen, Vladimir Lifschitz, and Bruce W. Porter, editors, *Handbook of Knowledge Representation*, volume 3 of *Foundations of Artificial Intelligence*, pages 551–596. Elsevier, 2008. doi:10.1016/S1574-6526(07)03013-1.
- [DMV90] Rocco De Nicola, Ugo Montanari, and Frits W. Vaandrager. Back and forth bisimulations. In Jos C. M. Baeten and Jan Willem Klop, editors, *Theories of Concurrency: Unification and Extension, Proc. CONCUR '90*, volume 458 of *Lecture Notes in Computer Science*, pages 152–165. Springer, 1990. doi:10.1007/BFb0039058.
- [Gal03] Antony Galton. A generalized topological view of motion in discrete space. *Theoretical Computer Science*, 305((1-3)):111–134, 2003. doi:10.1016/S0304-3975(02)00701-6.
- [GJKW17] Jan Friso Groote, David N. Jansen, Jeroen J. A. Keiren, and Anton Wijs. An $O(m \log n)$ algorithm for computing stuttering equivalence and branching bisimulation. *ACM Transactions on Computational Logic*, 18(2):13:1–13:34, 2017. doi:10.1145/3060140.
- [Han03] Helle Hansen. Monotonic Modal Logics, 2003. Master's Thesis, ILLC, University of Amsterdam. URL: <https://eprints.illc.uva.nl/id/eprint/108/2/PP-2003-24.text.pdf>.
- [HKP09] Helle Hansen, Clemens Kupke, and Eric Pacuit. Neighbourhood Structures: Bisimilarity and Basic Model Theory. *Logical Methods in Computer Science*, Volume 5, Issue 2, April 2009. URL: <https://lmcs.episciences.org/1167>, doi:10.2168/LMCS-5(2:2)2009.
- [KR97] Natasha Kurtonina and Maarten de Rijke. Bisimulations for temporal logic. *Journal of Logic, Language and Information*, 6(4):403–425, 1997. URL: <https://doi.org/10.1023/A:1008223921944>.
- [Kur22] Kazimierz Kuratowski. Sur l'opération \bar{A} de l'Analysis Situs. *Fundamenta Mathematicae*, 3, 1922. URL: <http://matwbn.icm.edu.pl/ksiazki/fm/fm3/fm3121.pdf>.
- [LPS20] Sven Linker, Fabio Papacchini, and Michele Sevegnani. Analysing spatial properties on neighbourhood spaces. In Javier Esparza and Daniel Král, editors, *45th International Symposium on Mathematical Foundations of Computer Science, MFCS 2020, August 24–28, 2020, Prague, Czech Republic*, volume 170 of *LIPICs*, pages 66:1–66:14. Schloss Dagstuhl - Leibniz-Zentrum für Informatik, 2020. doi:10.4230/LIPICs.MFCS.2020.66.
- [LPS21] Sven Linker, Fabio Papacchini, and Michele Sevegnani. Finite models for a spatial logic with discrete and topological path operators. In Filippo Bonchi and Simon J. Puglisi, editors, *46th International Symposium on Mathematical Foundations of Computer Science, MFCS 2021, August 23–27, 2021, Tallinn, Estonia*, volume 202 of *LIPICs*, pages 72:1–72:16. Schloss Dagstuhl - Leibniz-Zentrum für Informatik, 2021. doi:10.4230/LIPICs.MFCS.2021.72.
- [LQ21] Michele Loreti and Michela Quadrini. A spatial logic for a simplicial complex model. *CoRR*, abs/2105.08708, 2021. URL: <https://arxiv.org/abs/2105.08708>, arXiv:2105.08708.

- [Mil09] Robin Milner. *The Space and Motion of Communicating Agents*. Cambridge University Press, 2009.
- [MT44] John McKinsey and Alfred Tarski. The algebra of topology. *Annals of Mathematics*, 45:141–191, 1944.
- [NBBL22] Laura Nenzi, Ezio Bartocci, Luca Bortolussi, and Michele Loreti. A Logic for Monitoring Dynamic Networks of Spatially-distributed Cyber-Physical Systems. *Logical Methods in Computer Science*, Volume 18, Issue 1, January 2022. URL: <https://lmcs.episciences.org/8936>, doi: 10.46298/lmcs-18(1:4)2022.
- [NBC⁺18] Laura Nenzi, Luca Bortolussi, Vincenzo Ciancia, Michele Loreti, and Mieke Massink. Qualitative and quantitative monitoring of spatio-temporal properties with SSTL. *Logical Methods Computer Science*, 14(4), 2018. doi:10.23638/LMCS-14(4:2)2018.
- [RLG13] David A. Randell, Gabriel Landini, and Antony Galton. Discrete mereotopology for spatial reasoning in automated histological image analysis. *IEEE Transactions on Pattern Analysis and Machine Intelligence*, 35(3):568–581, 2013. doi:10.1109/TPAMI.2012.128.
- [Smy95] Michael B. Smyth. Semi-metrics, closure spaces and digital topology. *Theoretical Computer Science*, 151(1):257–276, 1995. doi:10.1016/0304-3975(95)00053-Y.
- [Sti93] Colin Stirling. Modal and Temporal Logics. In Samson Abramsky, Dov M. Gabbay, and Tom Maibaum, editors, *Handbook of Logic in Computer Science*, chapter V, pages 477–563. Oxford University Press, 1993.
- [SW07] Michael B. Smyth and Julian Webster. Discrete spatial models. In Marco Aiello, Ian Pratt-Hartmann, and Johan van Benthem, editors, *Handbook of Spatial Logics*, pages 713–798. Springer, 2007. URL: https://doi.org/10.1007/978-1-4020-5587-4_12.
- [TKG17] Christos Tsiganos, Timo Kehrer, and Carlo Ghezzi. Modeling and verification of evolving cyber-physical spaces. In Eric Bodden, Wilhelm Schäfer, Arie van Deursen, and Andrea Zisman, editors, *Proceedings of the 2017 11th Joint Meeting on Foundations of Software Engineering, ESEC/FSE 2017, Paderborn, Germany, September 4-8, 2017*, pages 38–48. ACM, 2017. doi:10.1145/3106237.3106299.
- [TPGN15] Christos Tsiganos, Liliana Pasquale, Carlo Ghezzi, and Bashar Nuseibeh. Ariadne: Topology aware adaptive security for cyber-physical systems. In Antonia Bertolino, Gerardo Canfora, and Sebastian G. Elbaum, editors, *37th IEEE/ACM International Conference on Software Engineering, ICSE 2015, Florence, Italy, May 16-24, 2015, Volume 2*, pages 729–732. IEEE Computer Society, 2015. doi:10.1109/ICSE.2015.234.

APPENDIX A.

Below, we recall the definition of CoPa-bisimilarity we used in [CLMV22a]⁴ and show that it is equivalent to Definition 5.3.

Definition A.1 (Definition 15 of [CLMV22a]). Given QdCS $\mathcal{M} = (X, \vec{C}, \mathcal{V})$, a symmetric relation $B \subseteq X \times X$ is a *CoPa-bisimulation* for \mathcal{M} if, whenever $B(x_1, x_2)$, the following holds:

- (1) for all $p \in \mathbf{AP}$ we have $x_1 \in \mathcal{V}(p)$ in and only if $x_2 \in \mathcal{V}(p)$;
- (2) for each forward path $\pi_1 = (x'_i)_{i=0}^{\ell_1}$ from x_1 such that $B(\pi_1(i), x_2)$ for all $i \in [0; \ell_1)$ there is a forward path $\pi_2 = (x''_j)_{j=0}^{\ell_2}$ from x_2 such that the following holds: $B(x_1, \pi_2(j))$ for all $j \in [0; \ell_2)$ and $B(\pi_1(\ell_1), \pi_2(\ell_2))$;
- (3) for each backward path $\pi_1 = (x'_i)_{i=0}^{\ell_1}$ from x_1 such that $B(\pi_1(i), x_2)$ for all $i \in [0; \ell_1)$ there is a backward path $\pi_2 = (x''_j)_{j=0}^{\ell_2}$ from x_2 such that the following holds: $B(x_1, \pi_2(j))$ for all $j \in [0; \ell_2)$ and $B(\pi_1(\ell_1), \pi_2(\ell_2))$.

⁴Here, for notational consistency with the rest of the paper, we use a terminology that is slightly different than, but equivalent to, that used in [CLMV22a].

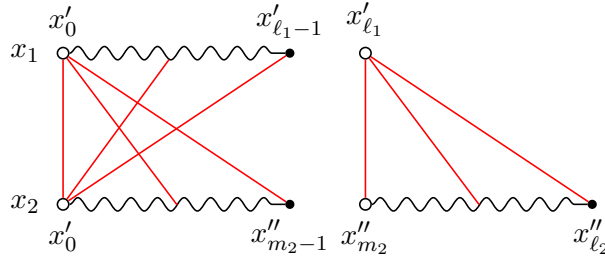

FIGURE 13. Example illustrating the proof of Proposition A.2
 $(\Rightarrow_{\text{CoPa}}^{5.3} \subseteq \Rightarrow_{\text{CoPa}}^{A.1})$.

Two points $x_1, x_2 \in X$ are called *CoPa-bisimilar* in \mathcal{M} if $B(x_1, x_2)$ for some CoPa-bisimulation B for \mathcal{M} . Notation, $x_1 \Rightarrow_{\text{CoPa}}^{\mathcal{M}} x_2$. •

In [CLMV22a] it has been shown that, for all QdCMs \mathcal{M} , $\Rightarrow_{\text{CoPa}}^{\mathcal{M}}$, defined according to Definition A.1, is an equivalence relation. The following proposition establishes the equivalence of the two definitions.

Proposition A.2. *Let $\mathcal{M} = (X, \vec{\mathcal{C}}, \mathcal{V})$ be a QdCM and $x_1, x_2 \in X$. It holds that $x_1 \Rightarrow_{\text{CoPa}} x_2$ according to Definition 5.3 if and only if $x_1 \Rightarrow_{\text{CoPa}} x_2$ according to Definition A.1.*

Proof. In this proof, for the sake of clarity, we use the following notation: $\Rightarrow_{\text{CoPa}}^{A.1}$ denotes relation $\Rightarrow_{\text{CoPa}}$ defined according to Definition A.1, and $\Rightarrow_{\text{CoPa}}^{5.3}$ denotes relation $\Rightarrow_{\text{CoPa}}$ defined according to Definition 5.3.

We first prove that $\Rightarrow_{\text{CoPa}}^{5.3} \subseteq \Rightarrow_{\text{CoPa}}^{A.1}$. Let $x_1, x_2 \in X$ and assume $x_1 \Rightarrow_{\text{CoPa}}^{5.3} x_2$. We have to show that the three conditions of Definition A.1 are satisfied.

(i) The first condition is trivially satisfied since $x_1 \Rightarrow_{\text{CoPa}}^{5.3} x_2$ requires that $x_1 \in \mathcal{V}(p)$ iff $x_2 \in \mathcal{V}(p)$ for all $p \in \text{AP}$.

(ii) As for the second condition, let $\pi_1 = (x'_i)_{i=0}^{\ell_1}$ be a forward path from x_1 such that $x'_i \Rightarrow_{\text{CoPa}}^{5.3} x_2$ for all $i \in [0; \ell_1)$. We distinguish two cases:

Case 1: $x'_{\ell_1} \Rightarrow_{\text{CoPa}}^{5.3} x_2$.

Put $\ell_2 = 0$ and consider the one-point path $\pi_2 = (x_2)$. Then we have that $\pi_1(\ell_1) = x'_{\ell_1} \Rightarrow_{\text{CoPa}}^{5.3} x_2 = \pi_2(\ell_2)$. Note that the other requirement of Definition A.1(2) is vacuous.

Case 2: $x'_{\ell_1} \not\Rightarrow_{\text{CoPa}}^{5.3} x_2$.

Since, by assumption, $x_1 \Rightarrow_{\text{CoPa}}^{5.3} x_2$, a forward path $\pi_2 = (x''_j)_{j=0}^{\ell_2}$ from x_2 exists, for some $\ell_2 \in \mathbb{N}$, that is compatible with π_1 . Define $m_2 = \min\{j \in (0; \ell_2] \mid x''_{j-1} \not\Rightarrow_{\text{CoPa}}^{5.3} x''_j\}$ (see Figure 13). Then m_2 is well-defined since $x_2 \not\Rightarrow_{\text{CoPa}}^{5.3} x'_{\ell_1}$ by hypothesis and $x'_{\ell_1} \Rightarrow_{\text{CoPa}}^{5.3} x''_{\ell_2}$ because π_1 is compatible with π_2 . Consider the forward path $\hat{\pi}_2 = (x''_j)_{j=0}^{m_2}$ from x_2 , i.e. the prefix of length m_2 of π_2 . For all $j \in [0; m_2)$ it holds that $x''_j \Rightarrow_{\text{CoPa}}^{5.3} x_2$, by definition of m_2 and $x_2 \Rightarrow_{\text{CoPa}}^{5.3} x_1$, by assumption. Let, for some $N \in \mathbb{N}$, $f : [0; \ell_1] \rightarrow [1; N]$ and $g : [0; \ell_2] \rightarrow [1; N]$ be matching functions for π_1 and π_2 . Let $i \in [0; \ell_1]$ be such that $f(i) = g(m_2)$, implying that $x'_i \Rightarrow_{\text{CoPa}}^{5.3} x''_{m_2}$. Then $i = \ell_1$, since for all $i \in [0, \ell_1)$ it holds $x'_i \Rightarrow_{\text{CoPa}}^{5.3} x_2$ by hypothesis and $x_2 \not\Rightarrow_{\text{CoPa}}^{5.3} x''_{m_2}$ by definition of m_2 . Thus, we have shown that there is a forward path $\hat{\pi}_2$ from x_2 such that $\hat{\pi}_2(j) \Rightarrow_{\text{CoPa}}^{5.3} x_1$ for all $j \in [0, m_2)$ and $\hat{\pi}_2(m_2) \Rightarrow_{\text{CoPa}}^{5.3} \pi_1(\ell_1)$.

(iii) The proof is similar to that for the second condition.

We now prove that $\Rightarrow_{\text{CoPa}}^{A.1} \subseteq \Rightarrow_{\text{CoPa}}^{5.3}$.

(i) Also in this case, the first condition is trivially satisfied since $x_1 \Rightarrow_{\text{CoPa}}^{A.1} x_2$ requires that

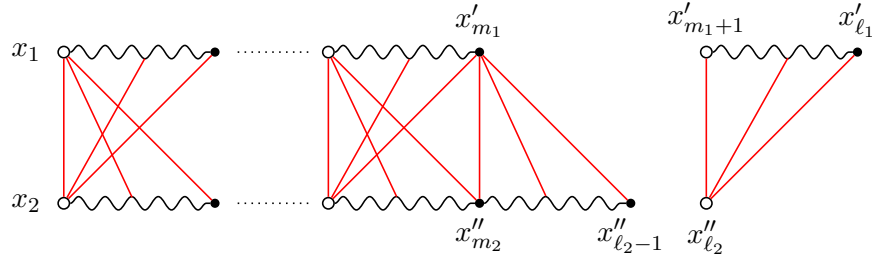

FIGURE 14. Example illustrating the proof of Proposition A.2
 $(\rightrightarrows_{\text{CoPa}}^{A.1} \subseteq \rightrightarrows_{\text{CoPa}}^{5.3})$.

$x_1 \in \mathcal{V}(p)$ iff $x_2 \in \mathcal{V}(p)$ for all $p \in \text{AP}$.

(ii) Regarding the second condition, for any forward path $\pi = (x_i)_{i=0}^{\ell}$ the number $Z(\pi)$ of times $\rightrightarrows_{\text{CoPa}}^{A.1}$ is not preserved while going from $\pi(0)$ to $\pi(\ell)$, i.e.

$$Z(\pi) = |\{i \in [0, \ell) \mid x_i \not\rightrightarrows_{\text{CoPa}}^{A.1} x_{i+1}\}|.$$

We have to show that for all $x_1, x_2 \in X$ such that $x_1 \rightrightarrows_{\text{CoPa}}^{A.1} x_2$ and forward path $\pi_1 = (x'_i)_{i=0}^{\ell_1}$ from x_1 there is a forward path $\pi_2 = (x''_j)_{j=0}^{\ell_2}$ from x_2 that is compatible with π_1 . We proceed by induction on $Z(\pi_1)$.

Base Case: $Z(\pi_1) = 0$.

In this case, since $Z(\pi_1) = 0$, we have that $x'_i \rightrightarrows_{\text{CoPa}}^{A.1} x_1$ for all $i \in [0; \ell_1]$ and, by hypothesis, we have that $x_1 \rightrightarrows_{\text{CoPa}}^{A.1} x_2$. Let then π_2 be the forward path of length 0 from x_2 , i.e. $\pi_2 = (x_2)$. Then π_2 is compatible with π_1 because the constant maps $f : [0; \ell_1] \rightarrow [1; 1]$ and $g : [0; 0] \rightarrow [1; 1]$ are matching functions for π_1 and π_2 .

Induction Step: $Z(\pi_1) > 0$.

In the sequel, we construct a forward path $\pi_2 = (x''_j)_{j=0}^{\ell_2}$ from x_2 as the concatenation of two forward paths — namely $\widehat{\pi}_{2a}$, of length m_{2a} , from x_2 and $\widehat{\pi}_{2b}$, of length m_{2b} from $\widehat{\pi}_{2a}(m_{2a})$, with $\ell_2 = m_{2a} + m_{2b}$ — and we show that π_2 is compatible with π_1 . Define $m_1 = \max\{i \in [0; \ell_1) \mid x'_i \not\rightrightarrows_{\text{CoPa}}^{A.1} x'_{i+1}\}$ (see Figure 14). Note that m_1 is well-defined since $Z(\pi_1) > 0$. Consider the forward path $\widehat{\pi}_1 = (x'_i)_{i=0}^{m_1}$ from x_1 , i.e. the prefix of length m_1 of π_1 . Since $Z(\widehat{\pi}_1) < Z(\pi_1)$, a forward path $\widehat{\pi}_{2a} = (x''_j)_{j=0}^{m_{2a}}$ exists that is compatible with $\widehat{\pi}_1$, by the induction hypothesis. Let, for some $N \in \mathbb{N}$, $f' : [0; m_1] \rightarrow [1; N]$ and $g' : [0; m_{2a}] \rightarrow [1; N]$ be matching functions for $\widehat{\pi}_1$ and $\widehat{\pi}_{2a}$ with respect to $\rightrightarrows_{\text{CoPa}}^{A.1}$. Note that, by compatibility of $\widehat{\pi}_1$ and $\widehat{\pi}_{2a}$, with respect to $\rightrightarrows_{\text{CoPa}}^{A.1}$, we have that $x'_{m_1} \rightrightarrows_{\text{CoPa}}^{A.1} x''_{m_{2a}}$. Consider the two point forward path (x'_{m_1}, x'_{m_1+1}) from x'_{m_1} . Since $x'_{m_1} \rightrightarrows_{\text{CoPa}}^{A.1} x''_{m_{2a}}$, a forward path $\widehat{\pi}_{2b} = (z_j)_{j=0}^{m_{2b}}$ exists from $x''_{m_{2a}}$ such that $x'_{m_1} \rightrightarrows_{\text{CoPa}}^{A.1} z_j$ for all $j \in [0; m_{2b})$ and $x'_{m_1+1} \rightrightarrows_{\text{CoPa}}^{A.1} z_{m_{2b}}$. We have that $m_{2b} > 0$ since $x''_{m_{2a}} \rightrightarrows_{\text{CoPa}}^{A.1} x'_{m_1} \not\rightrightarrows_{\text{CoPa}}^{A.1} x'_{m_1+1} \rightrightarrows_{\text{CoPa}}^{A.1} z_{m_{2b}}$. Define path $\pi_2 = (x''_j)_{j=0}^{\ell_2}$, with $\ell_2 = m_{2a} + m_{2b}$, as the concatenation $\widehat{\pi}_{2a} \cdot \widehat{\pi}_{2b}$ of $\widehat{\pi}_{2a}$ and $\widehat{\pi}_{2b}$. Obviously, π_2 is a forward path from x_2 . Moreover, π_1 and π_2 are compatible as shown below. Let $f : [0; \ell_1] \rightarrow [1; N+1]$ and $g : [0; \ell_2] \rightarrow [1; N+1]$ be defined as follows, where, for notational convenience, we let $m_2 = m_{2a}$:

$$f(i) = \begin{cases} f'(i) & \text{if } i \in [0; m_1], \\ N+1 & \text{if } i \in (m_1; \ell_1]. \end{cases}$$

$$g(j) = \begin{cases} g'(j) & \text{if } j \in [0; m_2], \\ N & \text{if } j \in (m_2; \ell_2), \\ N + 1 & \text{if } j = \ell_2. \end{cases}$$

The functions f and g are monotone. Surjectivity of f is obvious. For what concerns surjectivity of g , recall that $g'(m_2) = N$ and that $\ell_2 > m_2$. We now show that for all $i \in [0; \ell_1]$ and $j \in [0; \ell_2]$ satisfying $f(i) = g(j)$ it holds that $x'_i = \pi_1(i) \stackrel{A.1}{\rightleftharpoons}_{\text{CoPa}} \pi_2(j) = x''_j$.

If $f(i) = g(j) < N$ and $i \in [0; m_1], j \in [0; m_2]$, then $f'(i) = f(i) = g(j) = g'(j)$, which implies $x'_i \stackrel{A.1}{\rightleftharpoons}_{\text{CoPa}} x''_j$, since f' and g' are matching functions for $\widehat{\pi}_1$ and $\widehat{\pi}_{2a}$ with respect to $\stackrel{A.1}{\rightleftharpoons}_{\text{CoPa}}$.

If $f(i) = g(j) = N$ and $i \in [0; m_1], j \in (m_2; \ell_2)$, then $f(i) = g(m_2)$; so $x'_i \stackrel{A.1}{\rightleftharpoons}_{\text{CoPa}} x''_{m_2}$ and $x''_{m_2} \stackrel{A.1}{\rightleftharpoons}_{\text{CoPa}} x''_j$. Moreover $x'_{m_1} \stackrel{A.1}{\rightleftharpoons}_{\text{CoPa}} x''_j$ by choice of $\widehat{\pi}_{2b}$. Thence $x'_i \stackrel{A.1}{\rightleftharpoons}_{\text{CoPa}} x''_j$.

If $f(i) = g(j) = N + 1$ then $i \in (m_1, \ell_1]$ and $j = \ell_2$. Since, by definition of m_1 , we have that $x'_i \stackrel{A.1}{\rightleftharpoons}_{\text{CoPa}} x'_{m_1+1}$ and, by definition of $\widehat{\pi}_{2b}$, $x'_{m_1+1} \stackrel{A.1}{\rightleftharpoons}_{\text{CoPa}} x''_{\ell_2}$, it follows that $x'_i \stackrel{A.1}{\rightleftharpoons}_{\text{CoPa}} x''_j$. In conclusion, we have that π_1 and π_2 are compatible.

(iii) Similar to case (ii). □