

FLOWViZ: Framework for Phylogenetic Processing

Miguel Luís^a, Cátia Vaz^a

^aDEETC, ISEL, Portugal

A43504@alunos.isel.pt cvaz@cc.isel.ipl.pt

Abstract—The increasing risk of epidemics and a fast-growing world population has contributed to a great investment in phylogenetic analysis, in order to track numerous diseases and conceive effective medication and treatments.

Phylogenetic analysis requires large quantities of information to be analyzed and processed for knowledge extraction, using suitable techniques and, nowadays, specific software and algorithms, to deliver results as efficiently and fast as possible. These algorithms and techniques are already provided by several free and available frameworks and tools. Usually, the process of phylogenetic analysis consists of several processing steps, which define a pipeline. Some phylogenetic frameworks have available more than one processing step, such as inferring phylogenetic trees, data integration, and visualization, but due to the continuous growth in involved data amounts, each step may last several hours or days.

Scientific workflow systems may use high performance computing facilities, if available, for processing large volumes of data, concurrently. But most of these scientific workflow systems cannot be easily installed and configured, are available as centralized services, and, usually, it is not easy to integrate tools and processing steps available in phylogenetic frameworks.

This paper summarizes the thesis document of the FLOWViZ framework, which main goal is to provide a software integration framework between a phylogenetic framework and a scientific workflow system. This framework makes it possible to build a customized integration with much fewer lines of code, while providing existing phylogenetic frameworks with workflow building and execution, to manage the processing of great amounts of data.

The project was supported by funds, under the context of a student grant of Fundação para a Ciência e a Tecnologia (FCT) with reference UIDB/50021/2020, for a INESC-ID's project - NGPHYLO PTDC/CCI-BIO/29676/2017 and a Polytechnic Institute of Lisbon project - IPL/2021/DIVA.

Keywords: Bioinformatics, Workflow Systems, Software Integration, Phylogenetic Frameworks.

I. INTRODUCTION

Biology has been strongly influenced by the digital era we live in. The relationship between it and informatics had proven great humanitarian and scientific advances, mainly in the areas of healthcare and virology, not only contributing to create, but also enrich the science field of Bioinformatics.

Delivering fast and efficient results and track different viruses and diseases is now a relevant world healthcare requirement, specially in the last two years with the ongoing Covid-19 pandemic and due to the continuously growing world population, which contributes to the appearance of new epidemics.

Consequently, scientists rely on phylogenetic and genome analysis for variant tracking, in order to conceive effective medication.

Phylogenetic and genome analysis use large quantities of data, that needs to be processed in order to be usable, which can sometimes reach terabytes (TB) in size[9]. This added to the multiple tasks which compose various analysis procedures, can make these very demanding, complex and time-consuming. Specific software were made to ease the weight caused by these three issues, where distributed and parallel computing are also used to decrease processing times.

There are already multiple free and available solutions that let users make this type of analysis, usually providing them with tools to build phylogenetic trees. Most of them, however, only provide tools but do not provide ways to assemble and create procedures with them. Because of this, scientists have to build these procedures manually - they have to wait for results in order to proceed to the next steps. Not only it is antiquated for today's standards, but also time-consuming, inefficient and more prone to human error, as no automation is involved.

These procedures are composed by groups of tasks or steps, which are usually intrinsically dependent with each other - an output of a certain task may serve as an input of a future task. This pattern repeats until the final task's output, where the procedure ends. The procedure's structure and flow resembles a pipeline or a flowchart, being this the reason why the scientific community labeled these procedures as *pipelines* or *workflows*.

To automate these procedures, *Scientific Workflow Systems* were developed - specialized software, which provide a Domain-Specific Language (DSL), that allow users to script their own workflows and manage complex distributed computation and data in distributed resource environments.

Nowadays, there are many available workflow systems and each one provides a different and, sometimes, unique way to build workflows. At first, this software diversity can bring many options to build workflows, however, workflow shareability worsens, as there are many DSL to configure the same workflow for different workflow systems.

In order to provide workflow shareability among different workflow systems, the *Common Workflow Language* (CWL)[2] standard was created. This new standard contributed to an increasing interoperability between different workflow systems, however, as it is still new, a small percentage of them support this standard. It is expected that, given this standard increasing popularity, more workflow systems will implement it.

However, scientific workflow systems are not easy to configure and most of them are available through centralized services. These implementations also preclude the user from including new phylogenetic tools and hamper additional and customized configurations. It would also be easier if the user

could update their phylogenetic frameworks to a version that supported pipeline specification and execution automatically, through workflow systems, by simply installing a package and applying a small configuration to it.

The main goal of this paper is to propose an architecture which is being applied in a developing framework - *FLOWViZ*, that aims to offer workflow specification and execution to existent phylogenetic frameworks, with minimal configuration. By offering an user-friendly web interface, where users can manage and build workflows, allowing them to add and use their own tools, along with the bundled ones inside the framework itself. This is achieved by letting users define *contracts* - interfaces for their tools, which specify rules and operation guidelines for a correct tool execution and configuration. This way, the framework gets to know how to invoke a tool and how it should be correctly configured by the user, allowing the framework to integrate new tools, without changing its source code and without requiring the integrating tool to adapt. The framework, which is composed by a client and a server, relies on a workflow system, that schedule the workflows' execution and return the results back to the framework, which will be latterly delivered to the user.

With this approach, the developing framework will provide: (i) *Automation* - make the phylogenetic analysis an automatic process; (ii) *Flexibility* - allow the user to implement a wide range of phylogenetic tools, which can be executed in many execution environments, such as containers or cloud virtual machines; (iii) *Scalability* - support large-scale analysis, by relying on a workflow system that supports distributed and parallel computation in large clusters; (iv) *Result production* - provide complete and detailed results and logs, regarding the workflow's execution; (v) *Interoperability* - allow seamless integration with other phylogenetic frameworks that want to provide workflow building, through contracts and components' loosely-coupled relationships; (vi) *Reproducibility* - supply ready-to-use tools and workflows, which allow users to reproduce the same procedures; allow them to share their workflows through the CWL standard.

The rest of the document is divided by as follows. Section II shows the studied state-of-the-art phylogenetic frameworks and workflow systems. Section III presents the architecture of the project, namely the main components and interactions among them. Sections IV, V and VI refer and expose details of specific system's modules.

Finally, in section VII we discuss the proposed framework, expose possible future work and summarize the main contributions.

II. RELATED WORK

This section presents all the studied related work, namely, state-of-the-art phylogenetic frameworks and workflow systems.

A. Phylogenetic frameworks

We studied two well-known phylogenetic frameworks: PHYLOViZ[8] and NGPhylogeny[6].

PHYLOViZ provides methods to build phylogenetic trees in real-time, through a user-friendly interface. It also provides other functionalities, such as distance matrix visualization and sequence visualization. However, phylogenetic procedures need to be manually built, one step at a time, not providing functionalities to build workflows.

On the other hand, NGPhylogeny is a phylogenetic web framework, which is integrated with the Galaxy[1] workflow system. The framework provides three ways to build workflows: (1) using pre-made workflows with default values; (2) using pre-made workflows with users' values; (3) building customized workflows, using the framework provided tools and users' inputs. This method is also labeled as "*à la carte*" workflows.

Although NGPhylogeny provides users with workflow building and scheduling, they are limited to the tools that the framework has to offer. This is a problem that our framework aims to solve, by allowing users to integrate their tools and use them along with the ones that came bundled with the integrating tool. This can be achieved by contract specification, where rules and guidelines of each integrating tool are specified.

B. Workflow systems

In the context of this work, the *workflow* is a generic term to designate the automation of a process, in which data is processed by different logical data processing activities according to a specified set of rules [7]. It can also be interpreted as a *flow of work* that have a beginning and an end. Moreover, in Bioinformatics, it is usual to use the term workflow or pipeline for expressing the same.

As workflow scheduling and execution is the core requirement of this project, workflow systems were researched, in order to find the one that would better fit the framework's requirements. We previously selected three well known scientific workflow systems, namely: *Apache Airflow*[4], *Nextflow*[3] and *Snakemake*[5].

The selection was based on their popularity among the scientific community and with workflow systems which have a programming base language.

We analyzed the relevant features of them, which are summarized in Table I. One of the requirements is containerization support. As we can observe in Table I, Snakemake does not support this core feature and, therefore, we discarded this workflow system. Another core feature is CWL support, which Nextflow does not have and, thus, this workflow system was also discarded. The workflow system must also provide workflow composition via CLI, which is supported by all of them. Execution and dependency order are not core features, however, explicit order is more manageable than implicit and thus preferred, as it allow tasks' order and data dependencies to be defined explicitly, and not only by the tasks' topology: in which order tasks were written inside the script.

Given this, the workflow system which gathered most benevolent characteristics and is the most suitable for this project is *Apache Airflow*: it supports container execution and has CWL support. It also allows to specify the execution order

TABLE I
WORKFLOW COMPARISON TABLE

Characteristics	Workflow System		
	Airflow	Nextflow	Snakemake
Base Language	Python	Java / Groovy	Python
Composition Style (Values: Script, GUI)	Script	Script	Script
Execution Style (Values: CLI, GUI)	GUI / CLI	CLI	CLI
CWL Support (Values: Yes, No)	Yes	No	Yes
Containerization Support (Values: Yes, No)	Yes	Yes	No
Execution Order (Values: Explicit, Implicit)	Explicit	Implicit	Implicit
Dependency Order (Values: Explicit, Implicit)	Explicit	Implicit	Implicit
Workflow Sharing (Values: Yes, Partial, No)	Yes	Partial	Partial

of tasks explicitly and it also provides complete logs of the executed tasks, via GUI or CLI.

III. FLOWViZ OVERVIEW

FLOWViZ¹ is a software integration framework with the goal of providing a bridge between an existing phylogenetic framework and a workflow system. By supplying a basic configuration with few lines of code, the user can seamlessly integrate customized phylogenetic tools, which can be used to build and execute workflows and deliver results that better fit users' needs.

As a case study, we chose to use the PHYLOViZ framework, as the phylogenetic framework, and Apache Airflow[4], as the workflow system. We chose PHYLOViZ since it is a well known phylogenetic framework in this field and provides a great set of phylogenetic tools, however, it lacks workflow building and execution, making this a relevant case study for this implementation.

FLOWViZ has four primary requirements: (i) allow the user to integrate new tools with any phylogenetic framework and use them along with priorly added tools; (ii) easy integration with the phylogenetic framework, by supplying visual elements to easily access FLOWViZ features; (iii) manage and create workflows; (iv) export created workflows through CWL-written scripts, in order to facilitate workflow shareability;

To achieve a seamless tool integration, the proposed framework allow the users to establish contracts, where the tool's rules and guidelines are specified. This also happens when bridging the phylogenetic framework with FLOWViZ, namely the developer or the person responsible for the frameworks' integration must: (1) - have the phylogenetic framework's tools exposed via API or CLI; (2) - build the contracts to make these tools usable by the FLOWViZ framework. Customized tools added by users, must be deployed in a remote computing instance (cloud virtual machines or containers), with the

¹The public code repository of FLOWViZ is available through this link: <https://github.com/mig07/FLOWViZ>

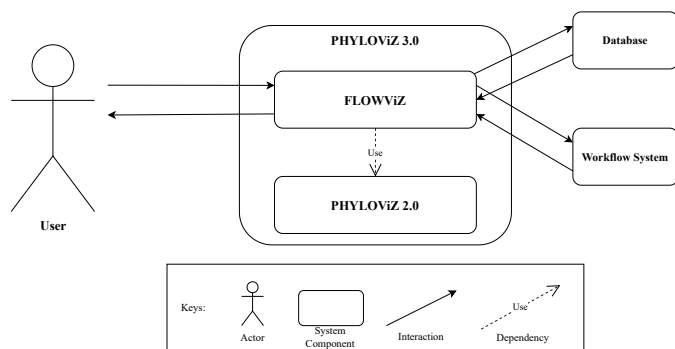

Fig. 1. System's architecture

necessary open ports and security configurations, to make the tool accessible by FLOWViZ. After this, the tool contract can be established and the tool can be successfully invoked by the framework.

Self-hosting FLOWViZ does not require exposing tools using remote instances - in *localhost* environment, the user or developer only needs to specify the tools' contracts. FLOWViZ will be a component of a system that integrates the phylogenetic framework and the workflow system. Therefore, the system architecture is composed by *four* main components: the *FLOWViZ framework*, the *phylogenetic framework* (in this case, PHYLOViZ 2.0), the *workflow system* and the *database*. Figure 1 show the system architecture.

In this architecture, integrating FLOWViZ with PHYLOViZ 2.0, will generate a new version of the PHYLOViZ project - version 3.0.

The system's architecture can also be divided by three functional modules: (i) *integration module*; (ii) *workflow building module*; (iii) *result production module*. The *integration module* (i) is responsible for integrating new phylogenetic tools within the framework via contracts; the *workflow building module* (ii) refers to the part responsible to supply a GUI that allows workflow building and scheduling; the *result production* (iii) uses the workflow execution logs to build a final report related to the workflow execution.

The system assets are the visual representation of the data, which is used during the workflow execution: tools and necessary files.

The FLOWViZ component encapsulates two sub-components: the *client* and the *server*. In the end, the FLOWViZ component serves as a middleware among: the user, the workflow system and the phylogenetic framework. This can be observed in Figure 2. As presented in Figure 2, the FLOWViZ component is composed by: a web client written in JavaScript with React, which supplies the user with a graphical user interface allowing it to add its own tools, build workflows and display results; an HTTP Express server written in JavaScript and Node.js, which supplies all the necessary endpoints to the client; it also provides user authentication by communicating with the phylogenetic framework; a database where all user-defined contracts and other relevant metadata are stored; the system assets, which are only the visual representation for the tools and necessary

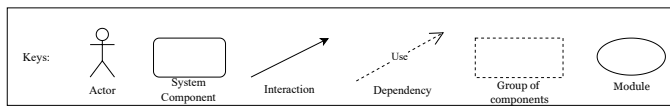
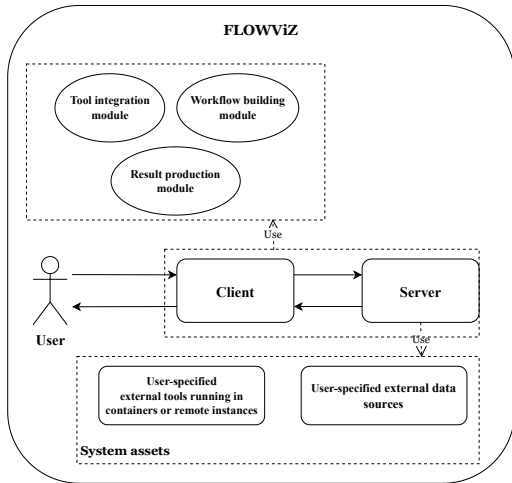

Fig. 2. FLOWViZ architecture detail

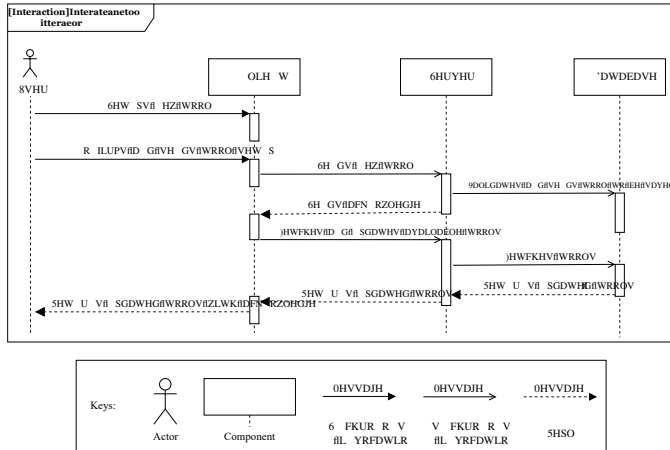

Fig. 3. Interaction diagram: tool integration module's general use case

files for workflow execution; the functional modules that this component performs: *tool integration (i)*, *workflow building (ii)* and *result production (iii)* modules.

The following sections detail each system's modules, approaching the respective involved components and specific use cases.

IV. TOOL INTEGRATION MODULE

The *integration module (i)* is responsible for enabling the user to integrate new tools inside the framework, which is the contract establishment for each tool. Figure 3 shows the interaction diagram of the integration module's general use case. In the depicted interaction diagram, Figure 3, the user configures the new tool using the provided web client GUI. When the setup is concluded and sent to the server, this receives, validates it and, finally, saves the contract into the

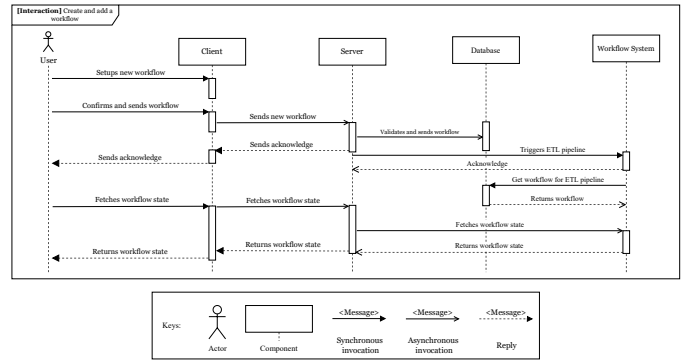

Fig. 4. Interaction diagram: workflow building module's general use case

database. Afterwards, the client self updates with the newest provided tools and receives the acknowledgment signal that the added tool was successfully integrated with the framework.

There are two ways to configure a tool: if it has CLI support, the user can configure it as a library and configure each command's invocation and settings; or if the tool exposes an API, the user can set up each exposed endpoint, providing the allowed structure for the HTTP body and headers.

Listing 1 shows the generic tool contract. This listing has both `api` and `library` fields for demonstration proposes but, in a real scenario, only one of them should be defined, since the user previously decides if it wants to configure the tool access as a library or as an API. This happens because the user firstly decides if it wants to configure the tool access as a library or as an API.

Listing 1. Generic tool contract (updated september, 2022)

```

1 {
2   "general": {
3     "name": "Name of the tool.",
4     "description": "Tool description."
5   },
6   "access": {
7     "_type": "type of tool access (library or API)"
8     // External tool access specifications
9   },
10  "library": [
11    // Groups of commands
12  ],
13  "api": [
14    // Endpoints
15  ]
16 }

```

V. WORKFLOW BUILDING MODULE

The *workflow building module (ii)* provides the user with a graphical user interface to build their workflows, using the user provided tools and the ones which came already bundled with the framework. The GUI consists of a whiteboard with a tools' side list, which the user can use to *drag and drop* tools into the whiteboard and connect them, creating a flowchart and defining the workflow. Figure 4 shows the interaction diagram of the workflow building module's general use case. As shown in Figure 4, after the tool's configuration, the user can build a workflow, by using the provided GUI, the whiteboard, where

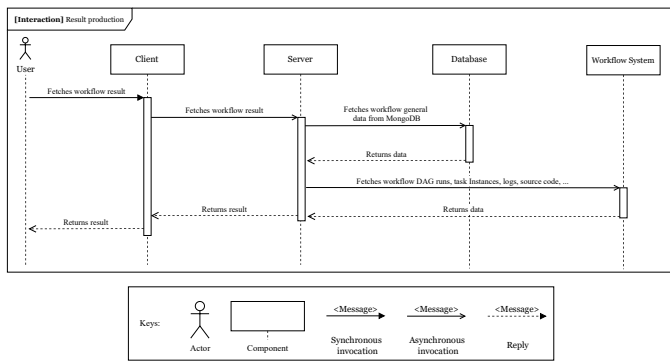

Fig. 5. Interaction diagram: result production module’s general use case

the workflow can be graphically drawn and each invoked tool setting can be individually configured. When the workflow configuration is concluded, the user submits it and the client sends the workflow to the server, which will go through a validation, that checks if every tool configuration is valid. If the validation succeeded, the workflow will be saved into the database and a HTTP request, containing the workflow’s name and the correspondent user, will be sent to the Airflow’s REST API, which will fetch the submitted workflow and translate its data into an Airflow DSL script, also known as an DAG (Directed Acyclic Graph). The DAG will then be executed at the date and time, pre-configured by the user, and the workflow’s execution will produce results.

VI. RESULT PRODUCTION MODULE

The *result production module* (iii) delivers the workflow log back to the client, so the user can retrieve it. When the workflow execution finishes, the HTTP server provides the client with endpoints, which fetch data from the Airflow REST API, in order to retrieve results for a specific workflow. Figure 5 displays the general use case implementation of the result production module. When the workflow’s execution finishes, the user can fetch its results via web client, which will send a request to the HTTP server. This will fetch data from both the database and the Airflow’s REST API and will send it back to the client. These results include logs regarding each workflow execution, each specific involved task and the correspondent parsed workflow DSL source code.

It should be noted that this module is shared between the FLOWViZ and the workflow system components.

VII. DISCUSSION

This paper introduces FLOWViZ - a tool integration framework for phylogenetic frameworks. This provides both a client and a server component, allowing the user to build workflows, through a user-friendly web client’s interface, enabling it to add its own phylogenetic tools and use them in its own built workflows, by only requiring few lines of configuration.

This provides a great tool scalability and interoperability, as tools can be continuously integrated, while the workflow

Fig. 6. FLOWViZ: tool integration general fragment

Fig. 7. FLOWViZ: tool integration access fragment

system’s workers can be also scaled-out to handle larger workloads. Tool interoperability is also supported by using contracts and loosely coupled relationship between components, which allows seamless integration with other phylogenetic frameworks, requiring the developer to only add the phylogenetic framework’s bundled tools to the FLOWViZ configuration.

The proposed architecture was tested and materialized into an application prototype, composed by two main components: (i) a React web client and (ii) an HTTP server, both written in JavaScript. With these two it is possible to: (i) integrate external phylogenetic tools, (ii) build workflows with the previously integrated tools and, finally, (iii) retrieve results and logs from the workflow’s execution.

Figures 6, 7 and 8 show the tool integration use case implementation in the application.

After a successful tool integration, the web client will send the tool contract to the HTTP server, which will go through a validation. If the contract is valid, it will be saved into the database. At this point, the tool was successfully integrated. The user can then use the previously integrated tools to build its customized workflows, using the web client’s provided editor - the *whiteboard*, where the user can graphically draw and configure the workflow’s tasks (figure 9).

When the user finishes the configuration, the workflow can

Add tool

Fig. 8. FLOWViZ: tool integration rules fragment

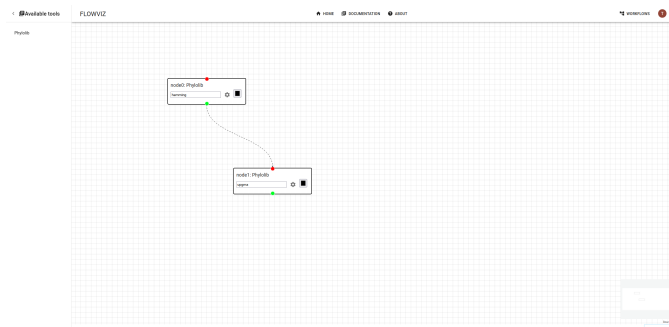

Fig. 9. FLOWViZ: whiteboard

be submitted and send to the HTTP server, which will go again, through a validation. If it succeeds, the workflow data will be saved into the database and a HTTP request, containing the name of the workflow and its correspondent user, will be sent to the Airflow's REST API, that will then fetch from the database the correspondent user workflow and parse it to an Airflow DSL script or DAG. The DAG will then be executed at the pre-configured date and time, which will produce results, that can be easily consulted via the web client (figure 10).

VIII. ACKNOWLEDGEMENTS

The work reported in this article was supported by national funds through Fundação para a Ciência e a Tecnologia (FCT) with reference UIDB/50021/2020 and project NGPHYLO PTDC/CCI-BIO/29676/2017. It was also supported through Instituto Politécnico de Lisboa with project IPL/2021/DIVA.

REFERENCES

[1] Enis Afgan, Dannon Baker, Bérénice Batut, Marius van den Beek, Dave Bouvier, Martin Čech, John Chilton,

PhylolibWorkflow

Fig. 10. FLOWViZ: Results of a workflow execution

Dave Clements, Nate Coraor, Björn A Gruning, Aysam Guerler, Jennifer Hillman-Jackson, Saskia Hiltmann, Vahid Jalili, Helena Rasche, Nicola Soranzo, Jeremy Goecks, James Taylor, Anton Nekrutenko, and Daniel Blankenberg. The Galaxy platform for accessible, reproducible and collaborative biomedical analyses: 2018 update. *Nucleic Acids Research*, 46(W1):W537–W544, 05 2018.

[2] Peter Amstutz, Michael R Crusoe, Nebojša Tijanić, Brad Chapman, John Chilton, Michael Heuer, Andrey Kartashov, Dan Leehr, Hervé Ménager, Maya Nedeljkovich, et al. Common workflow language, v1. 0. *No journal*, 2016.

[3] Paolo Di Tommaso, Evan W Floden, Cedric Magis, Emilio Palumbo, and Cedric Notredame. Nextflow: un outil efficace pour l'amélioration de la stabilité numérique des calculs en analyse génomique. *Biologie Aujourd'hui*, 211(3):233–237, 2017.

[4] Leanne Finnigan and Emily Toner. Building and maintaining metadata aggregation workflows using apache airflow. *Temple University Libraries*, 2021.

[5] Johannes Köster and Sven Rahmann. Snakemake — a scalable bioinformatics workflow engine. *Bioinformatics*, 28(19):2520–2522, 08 2012.

[6] Frédéric Lemoine, Damien Correia, Vincent Lefort, Olivia Doppelt-Azeroual, Fabien Mareuil, Sarah Cohen-Boulakia, and Olivier Gascuel. NGPhylogeny.fr: new generation phylogenetic services for non-specialists. *Nucleic Acids Research*, 47(W1):W260–W265, 04 2019.

[7] Ji Liu, Esther Pacitti, Patrick Valduriez, and Marta Mattoso. A survey of data-intensive scientific workflow management. *Journal of Grid Computing*, 13(4):457–493, 2015.

[8] Marta Nascimento, Adriano Sousa, Mário Ramirez, Alexandre P Francisco, João A Carriço, and Cátia Vaz. PHYLOViZ 2.0: providing scalable data integration and visualization for multiple phylogenetic inference methods. *Bioinformatics*, 33(1):128–129, 09 2016.

[9] Cuiping Pan, Gregory McInnes, Nicole Deflaux, Michael Snyder, Jonathan Bingham, Somalee Datta, and Philip S Tsao. Cloud-based interactive analytics for terabytes of genomic variants data. *Bioinformatics*, 33(23):3709–3715, 07 2017.