

The Internal Operads of Combinatory Algebras

Masahito Hasegawa^{1,2}

*Research Institute for Mathematical Sciences
Kyoto University
Kyoto, Japan*

Abstract

We argue that *operads* provide a general framework for dealing with polynomials and combinatory completeness of *combinatory algebras*, including the classical **SK**-algebras, linear **BCI**-algebras, planar **BI**(\cdot)-algebras as well as the braided **BC \pm I**-algebras. We show that every extensional combinatory algebra gives rise to a canonical closed operad, which we shall call the *internal operad* of the combinatory algebra. The internal operad construction gives a left adjoint to the forgetful functor from closed operads to extensional combinatory algebras. As a by-product, we derive extensionality axioms for the classes of combinatory algebras mentioned above.

Keywords: lambda calculus, combinatory algebras, operads

1 Introduction

Combinatory algebras [3,11] are fundamental in several areas of theory of computation. They can be thought as models of the λ -calculus, in which the λ -abstraction is not a primitive ingredient but a derived construct. This paper addresses a seemingly naive and easy-to-answer question on this ability of modelling λ -abstractions in combinatory algebras: what are the correct interpretations of variables? For the classical (cartesian) combinatory algebras, our approach basically agrees with that of Hyland [12]. However, our work is motivated by non-classical variants of combinatory algebras, especially by a difficulty in formulating the braided combinatory algebras along the line of our previous work [9]. Technically, we build our framework on top of the case of planar combinatory algebras [19,20].

1.1 Polynomials and Combinatory Completeness

Recall that an (total) *applicative structure* (also called a *magma*) (\mathcal{A}, \cdot) is a set \mathcal{A} equipped with a binary function $(_) \cdot (_) : \mathcal{A} \times \mathcal{A} \rightarrow \mathcal{A}$ called *application*. In this paper we only deal with total applicative structures, i.e., applications are always defined. As is customary, applications are assumed to be left associative, and the infix \cdot is often omitted.

We are mainly interested in applicative structures which can model the λ -calculus. So we are to handle *variables* and *abstractions*. Usually, we proceed as follows.

¹ I thank Haruka Tomita for stimulating discussions, and the anonymous reviewers for comments. This work was supported by JSPS KAKENHI Grant No. JP18K11165, JP21K11753 and JST ERATO Grant No. JPMJER1603.

² Email: hassei@kurims.kyoto-u.ac.jp

- (i) Introduce *polynomials* $\mathcal{P}[x_1, \dots, x_n]$ on (\mathcal{A}, \cdot) , which are generated by variables x_1, \dots, x_n and elements of \mathcal{A} using the application \cdot .
- (ii) We say that (\mathcal{A}, \cdot) is *combinatory complete* if, for any $p \in \mathcal{P}[\Gamma, x]$ there exists $\lambda^*x.p \in \mathcal{P}[\Gamma]$ such that $(\lambda^*x.p) \cdot q = p[q/x]$ holds. We say it is *extensional* when such $\lambda^*x.p$ is unique (equivalently: $\lambda^*x.(p \cdot x) = p$ with no free x in p).

In this paper, by a *combinatory algebra* we mean a combinatory complete applicative structure. Note the ambiguity in the notion of polynomials; by altering the definition of polynomials, we get different notions of combinatory algebras.

Remark 1.1 The extensionality above is not quite a standard one found in e.g. [3,11], where an applicative structure \mathcal{A} is called extensional when $(\forall x \in \mathcal{A} a \cdot x = b \cdot x)$ implies $a = b$. This traditional extensionality is too strong for our purpose; in particular, interesting braided combinatory algebras cannot be extensional in the traditional sense, as it enforces braids with the same underlying permutation to be identified. In contrast, our extensionality (or the η -rule) says that $a \cdot x = b \cdot x$ in $\mathcal{P}[\Gamma, x]$ implies $a = b$ for $a, b \in \mathcal{P}[\Gamma]$, which heavily depends on the notion of polynomials.

1.2 Semi-closed Operads and Combinatory Algebras

Thanks to combinatory completeness, a combinatory algebra gives rise to a model of the λ -calculus:

- (i) Firstly, polynomials $\mathcal{P}[x_1, \dots, x_n]$ are thought as the set $\mathcal{P}(n)$ of n -ary operators on \mathcal{A} .
- (ii) The family $\{\mathcal{P}(n)\}_{n \in \mathbf{N}}$ with suitable notion of composition determines an *operad* (one-object multi-category) \mathcal{P} with $\mathcal{P}(0) = \mathcal{A}$. Depending on the definition of polynomials, the operad can be *planar*, *symmetric*, *braided* or *cartesian*.
- (iii) Then, combinatory completeness says the operad \mathcal{P} is *semi-closed* (*closed* when extensional).
- (iv) It is not hard to see that semi-closed (or closed) planar/symmetric/braided/cartesian operads are models of the planar/linear/braided/ordinary λ -calculus with β - (or $\beta\eta$ -)equality, where a term-in-context $x_1, \dots, x_n \vdash M$ is interpreted as an element $\llbracket x_1, \dots, x_n \vdash M \rrbracket$ of $\mathcal{P}(n)$.

So the situation can be summarized as follows:

$$\begin{aligned} \text{Constructing polynomials} &= \text{Constructing operads} \\ \text{Requiring combinatory completeness} &= \text{Requiring (semi-)closedness} \end{aligned}$$

Conversely, (semi-)closed operads give a combinatory algebra, just by taking the 0-ary operators:

- the planar case: when \mathcal{P} is a semi-closed planar operad, $\mathcal{P}(0)$ is a **BI**(\cdot)[•]-*algebra* of Tomita [19];
- the linear case: when \mathcal{P} is a semi-closed symmetric operad, $\mathcal{P}(0)$ is a **BCI**-*algebra* [1,10];
- the braided case: when \mathcal{P} is a semi-closed braided operad, $\mathcal{P}(0)$ is a **BC**[±]**I**-*algebra*, a braided variant of **BCI**-algebras [9]; and
- the classical case: when \mathcal{P} is a semi-closed cartesian operad, $\mathcal{P}(0)$ is an **SK**-*algebra* [12].

It remains to see how to construct polynomials, or more generally operads, on top of a combinatory algebra.

1.3 Taking Polynomials Seriously

Often, polynomials of $\mathcal{P}[x_1, \dots, x_n]$ are identified with certain functions from \mathcal{A}^n to \mathcal{A} . Many studies on combinatory algebras employ this “polynomials as functions” view either explicitly or implicitly (e.g. formulating polynomials as formal expressions while saying that two polynomials are equal when they express the same function).

There also are cases handling polynomials as a “polynomial combinatory algebra” in the algebraic manner [7,18], in which variables are taken as indeterminates. This approach allows a cleaner treatment of abstractions where the problem of ξ -rule disappears [18], and mathematically preferable than the “polynomials as functions” approach. However, for the planar, linear and braided cases, polynomials do not form a combinatory algebra, and we cannot apply the same strategy.

Note that operads obtained in the “polynomials as functions” way are always well-pointed: the global section multi-functor into **Set** is faithful. Hence many of the conventional approaches actually consider only well-pointed operads. It still works reasonably well for the classical, linear and planar cases. However, the same cannot be applied to the braided case: well-pointed braided operads are always symmetric, hence the information on braids is lost. Thus existing approaches are too restrictive. Is there an alternative way of constructing operads from combinatory algebras which can cover the braided case?

1.4 The Internal Operad Construction

In this paper, we propose an alternative construction of operads from combinatory algebras: the *internal operad* construction. The key insight is that, instead of taking *external* functions as polynomials, we construct an operad just by using the elements and structure of the combinatory algebra, hence *internally*. As we will explain in Section 2, its basic idea is rather simple and should be unsurprising for those familiar with the λ -calculus: just to express a program with m inputs and n outputs by a closed λ -term of the form $\lambda f x_1 \dots x_m. f M_1 \dots M_n$ with no free f in M_i 's. The novel finding is that it works in a wide class of combinatory algebras, in which we can characterise elements of m inputs and n outputs by an equation. We show that the internal operad is the initial one among the closed operads giving rise to the combinatory algebra. In other words, the internal operad construction is left adjoint to the functor sending a closed operad \mathcal{P} to the extensional combinatory algebra $\mathcal{P}(0)$.

Moreover, the internal operad construction works not only for the planar, linear and classical (non-linear) cases but also for the braided case. This gives an answer to the difficulty of formalizing polynomials and combinatory completeness of braided combinatory algebras.

The main restriction of this approach is that the internal operad construction works only for *extensional* combinatory algebras. In fact, we can *design* extensionality axioms so that the internal operad construction works; this might be compared to Freyd's approach to extensionality [7] where he identifies axioms to make the “polynomial combinatory algebra” construction satisfy the extensional principle. The axioms obtained in this way are semantically motivated and (hopefully) understandable. We present the resulting axiomatizations for the planar, linear, braided as well as the classical cases.

1.5 Related Work

This work started with the question of how to formulate combinatory completeness of braided combinatory algebras, which came from our previous work on the braided λ -calculus [9]. The notion of $\mathbf{BC}^\pm\mathbf{I}$ -algebras also comes from that work, though its axiomatization was left open.

Hyland [12] advocated the view that (classical) combinatory algebras are semi-closed cartesian operad. Our approach can be seen as generalization of his work to planar, linear, and braided settings. The main difference would be that we put the planar – the weakest but most general – case as the basic setting, and develop other cases on top of it.

The planar combinatory algebras – $\mathbf{BI}(_)^\bullet$ -algebras and variations – have been studied by Tomita [19,20] as the realizers for his non-symmetric realizability models.

There are plenty of work on the graphical presentations of the λ -calculus; while many focus on the graph-theoretic or combinatorial aspects, Zeilberger's work on linear/planar λ -terms and trivalent graphs [22,23] provide a more geometric perspective on the graphs, which is closer to our approach.

Ikebuchi and Nakano's work on \mathbf{B} -terms [13] emphasizes the role of composition and application of \mathbf{B} as basic constructs of their calculus of \mathbf{B} -terms as forest of binary trees, which is very close to our definition of internal operads; only the identity \mathbf{I} and the internalization operator $(_)^\bullet$ are missing.

Some work on knotted graphs (including [16,21]) identify the “Reidemeister-IV” move, which is used in our axiomatizations of extensional \mathbf{BCI} -algebras and $\mathbf{BC}^\pm\mathbf{I}$ -algebras.

1.6 Organization of This Paper

This paper is organized as follows. In Section 2, we consider the combinatory algebras of closed λ -terms as well as its graphical variants, and see how they give rise to operads internally. In Section 3, we review Tomita's $\mathbf{BI}(_)^\bullet$ -algebras from the viewpoint of planar operads, and introduce extensional $\mathbf{BI}(_)^\bullet$ -algebras. In Section 4, we introduce internal operads of extensional $\mathbf{BI}(_)^\bullet$ -algebras. Section 5 is devoted to the

cases of linear, braided and classical combinatory algebras, which are obtained by specializing the planar case with additional structures. In Section 6, we conclude this paper by suggesting possible future work, including the preliminary observations on traced combinatory algebras. For lack of space most proofs are omitted, though they all follow from plain equational reasoning. We assume that the reader is familiar with the basic concepts of the λ -calculus and combinatory logic as found e.g., in [11]. Brief summaries of the braid groups and braided operads used in this paper are given in Appendix A.

2 Motivating Internal Operads

2.1 The Planar, Linear, and Braided λ -calculi

Let us summarize the fragments and variant of the λ -calculus to be discussed in this paper. The *planar λ -calculus* is an untyped linear λ -calculus with no exchange, whose terms are given by the following rules.

$$\frac{}{x \vdash x} \text{ variable} \quad \frac{\Gamma, x \vdash M}{\Gamma \vdash \lambda x.M} \text{ abstraction} \quad \frac{\Gamma \vdash M \quad \Gamma' \vdash N}{\Gamma, \Gamma' \vdash MN} \text{ application}$$

It is easy to see that planar terms are closed under $\beta\eta$ -conversion. Typical planar terms include $\mathbf{I} = \lambda f.f$, $\mathbf{B} = \lambda fxy.f(xy)$, and $P^\bullet = \lambda f.fP$ for planar closed term P .

The *linear λ -calculus* has the rules for the planar λ -calculus and the exchange rule:

$$\frac{x_1, x_2, \dots, x_n \vdash M \quad s : \text{permutation on } \{1, \dots, n\}}{x_{s(1)}, x_{s(2)}, \dots, x_{s(n)} \vdash M} \text{ exchange}$$

Non-planar linear terms include $\mathbf{C} = \lambda fxy.fyx$.

The *braided λ -calculus* [9] is a variant of the linear λ -calculus in which every permutation/exchange of variables is realized by a braid. Thus, for a term M with n free variables and a braid s with n strands (which can be identified with the elements of the braid group B_n as explained in Appendix A below), we introduce a term $[s]M$ in which the free variables are permuted by s :

$$\frac{x_1, x_2, \dots, x_n \vdash M \quad s : \text{braid with } n \text{ strands}}{x_{s(1)}, x_{s(2)}, \dots, x_{s(n)} \vdash [s]M} \text{ braid}$$

For instance, there are infinitely many braided \mathbf{C} -combinators including

$$\mathbf{C}^+ = \lambda fxy. \left[\begin{array}{c} \text{---} \\ \text{---} \end{array} \right] (fyx) \quad \text{and} \quad \mathbf{C}^- = \lambda fxy. \left[\begin{array}{c} \text{---} \\ \text{---} \end{array} \right] (fyx).$$

The $\beta\eta$ -equality on braided terms is less straightforward due to the presence of braids; see [9] for details.

2.2 Operads

Recall that an (planar or non-symmetric) operad [17] \mathcal{P} is a family of sets $(\mathcal{P}(n))_{n \in \mathbb{N}}$ equipped with

- an identity $id \in \mathcal{P}(1)$ and
- a composition map sending $f_i \in \mathcal{P}(k_i)$ ($1 \leq i \leq n$) and $g \in \mathcal{P}(n)$ to the composite $g(f_1, \dots, f_n) \in \mathcal{P}(k_1 + k_2 + \dots + k_n)$

which are subject to the unit law and associativity:

$$f(id, \dots, id) = f = id(f)$$

$$h(g_1(f_{11}, \dots, f_{1j_1}), \dots, g_k(f_{k1}, \dots, f_{kj_k})) = (h(g_1, \dots, g_n))(f_{11}, \dots, f_{km_k})$$

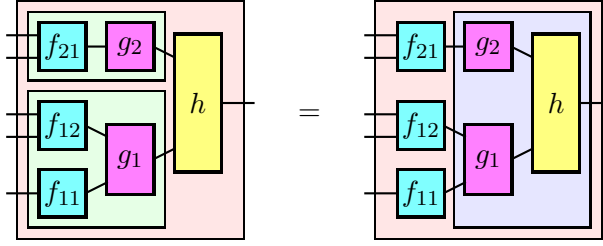

$\mathcal{P}(n)$ serves as the set of n -ary operators, or polynomials with n variables.

2.3 (Semi-)Closed Operads and Combinatory Completeness

From an applicative structure \mathcal{A} , we are to construct an operad \mathcal{P} with $\mathcal{P}(0) = \mathcal{A}$ and an element $\mathbf{app} \in \mathcal{P}(2)$ corresponding to the application \cdot . That is, $\mathbf{app}(a, b) = a \cdot b$ for $a, b \in \mathcal{A}$.

We say \mathcal{A} is combinatory complete with respect to \mathcal{P} if, for any $p \in \mathcal{P}(n+1)$, there exists $\lambda^*(p) \in \mathcal{P}(n)$ satisfying $\mathbf{app}(\lambda^*(p), id) = p$; it is extensional when such $\lambda^*(p)$ is unique.

On the other hand, an operad \mathcal{P} is semi-closed when there is $\mathbf{app} \in \mathcal{P}(2)$ such that for any $p \in \mathcal{P}(n+1)$, there exists $\lambda^*(p) \in \mathcal{P}(n)$ satisfying $\mathbf{app}(\lambda^*(p), id) = p$, and closed when such $\lambda^*(p)$ is unique.

\mathcal{P} is semi-closed $\iff \mathcal{A} = \mathcal{P}(0)$ is combinatory complete with respect to \mathcal{P}

\mathcal{P} is closed $\iff \mathcal{A} = \mathcal{P}(0)$ is combinatory complete and extensional with respect to \mathcal{P}

2.4 The Internal Operad of the λ -calculus

The idea of the internal operads (and internal PRO(P)) is very simple if we look at the case of the combinatory algebra of closed λ -terms, with its graphical interpretation.

We say that a closed λ -term is of arity $m \rightarrow n$ when it is $\beta\eta$ -equal to a head normal form

$$\lambda f x_1 \dots x_m. f M_1 \dots M_n \quad (f \text{ not free in } M_i\text{'s})$$

which can be regarded as a program with m inputs and n outputs, where the head variable f serves as the (linearly-used) continuation or the environment. There are closed terms which do not have an arity (e.g. $\lambda xy. yx$), but we shall note that any closed term of the planar λ -calculus has an arity. Examples of closed terms with arity include:

$$\begin{aligned} \mathbf{I} &= \lambda f. f : 0 \rightarrow 0 & \mathbf{B} &= \lambda fxy. f(xy) : 2 \rightarrow 1 & \mathbf{C} &= \lambda fxy. fyx : 2 \rightarrow 2 \\ \mathbf{S} &= \lambda fxy. f y(xy) : 2 \rightarrow 2 & \mathbf{K} &= \lambda fx. f : 1 \rightarrow 0 & \mathbf{W} &= \lambda fx. fxx : 1 \rightarrow 2 \\ \mathbf{P}^\bullet &= \lambda f. f P : 0 \rightarrow 1 \quad (P \text{ closed term}) \end{aligned}$$

Note that $M : m \rightarrow n$ implies $M : m+1 \rightarrow n+1$ because we take the η -rule into account:

$$\lambda f x_1 \dots x_m. f M_1 \dots M_n =_\eta \lambda f x_1 \dots x_m x_{m+1}. f M_1 \dots M_n x_{m+1}.$$

By letting $\mathcal{I}_\Lambda(n)$ be the set of ($\beta\eta$ -equivalence classes of) closed terms of arity $n \rightarrow 1$ and by appropriately defining the composition (with the identity $\mathbf{I} : 1 \rightarrow 1$), we obtain a closed (cartesian) operad \mathcal{I}_Λ , which we shall call the *internal operad* of the λ -calculus. The closed operad structure of \mathcal{I}_Λ will be spelled out below; but before that, we shall look at a graphical interpretation of terms with arity, which turns out to be useful in describing the operad structure.

2.5 The Internal Operad of the λ -calculus, Graphically

We can interpret closed (linear) λ -terms as rooted trivalent graphs with two kinds of nodes (the **lambda nodes** \bullet and **application nodes** \odot) [22,23] as shown in Figure 1 where the annotations show the correspon-

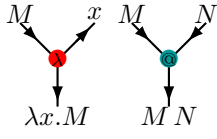

Fig. 1. The nodes

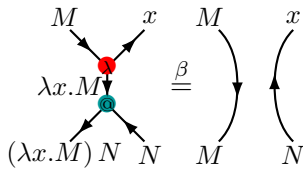

Fig. 2. $\beta\eta$ -rules

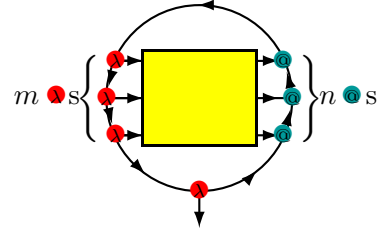
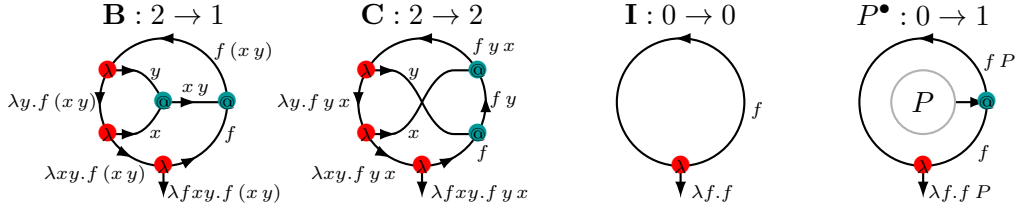

Fig. 3. Graphs of arity $m \rightarrow n$

dence to the linear λ -terms. They are subject to the $\beta\eta$ -rules given in Figure 2.

We are interested in the graphs (modulo $\beta\eta$ -rules) of arity $m \rightarrow n$ as depicted in Figure 3, which are $\lambda f x_1 \dots x_m. f M_1 \dots M_n$ in the λ -calculus. The most basic examples of such graphs with arity are:



They will be the basic primitives for the planar and linear combinatory algebras.

Now we describe a few simple constructions on terms with arity. They will be of fundamental importance in describing the operad structure.

Adding lower strands

For $M : m \rightarrow n$, we have $\mathbf{B}M : m + 1 \rightarrow n + 1$. graphically, applying \mathbf{B} adds a new lower strand:

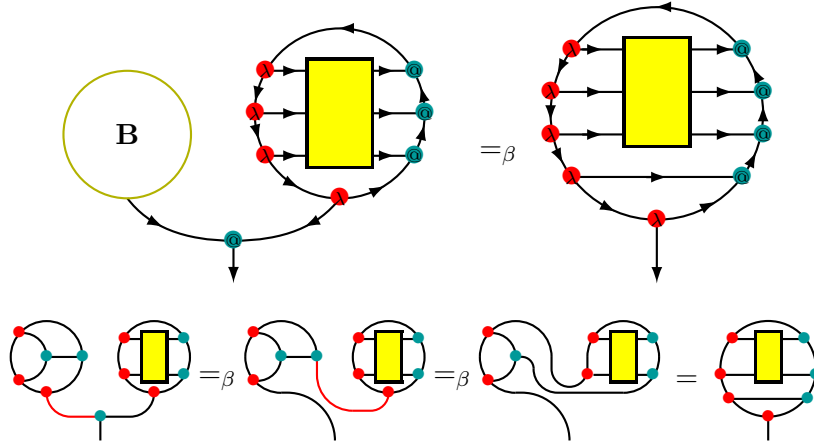

Adding upper strands

As we already noticed, $M : m \rightarrow n$ implies $M : m + 1 \rightarrow n + 1$. Graphically, it means that we can add upper strands for free:

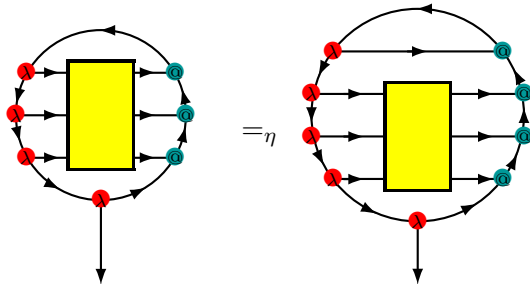

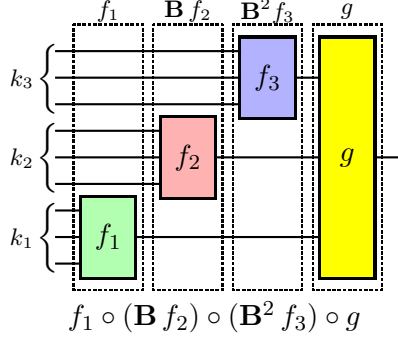
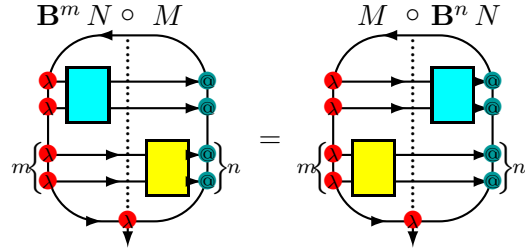
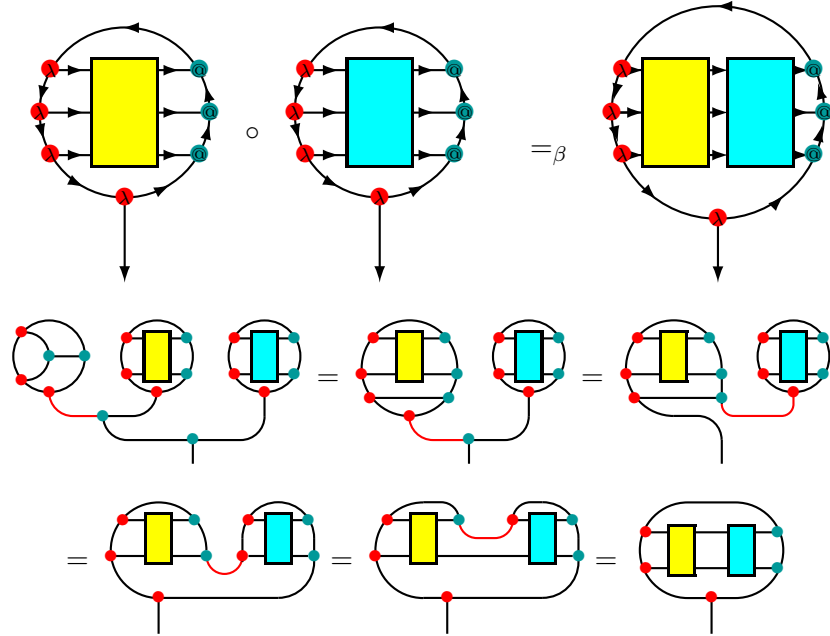

 Fig. 4. Composition $g(f_1, f_2, f_3)$

Fig. 5. The exchange law

Sequential composition

As usual, let us write $M \circ N$ for $\mathbf{B} M N =_{\beta} \lambda f. M(N f)$. For $M : l \rightarrow m$ and $N : m \rightarrow n$, we have $M \circ N : l \rightarrow n$, the sequential composition of M and N :



The composition \circ is associative, and $\mathbf{I} : n \rightarrow n$ serves as the unit.

2.6 The Closed Operad Structure of \mathcal{I}_{Λ}

Now we shall spell out the operad structure of \mathcal{I}_{Λ} . For $f_i \in \mathcal{I}_{\Lambda}(k_i)$ ($1 \leq i \leq n$) and $g \in \mathcal{I}_{\Lambda}(n)$, the composite $g(f_1, \dots, f_n) \in \mathcal{I}_{\Lambda}(k_1 + k_2 + \dots + k_n)$ is $f_1 \circ (\mathbf{B} f_2) \circ \dots \circ (\mathbf{B}^{n-1} f_n) \circ g$ (Figure 4). With $id = \mathbf{I}$, it is routine to see that this composition satisfies the unit law and associativity of operads.

Next, we look at the closed structure. Let $\mathbf{app}_{\mathcal{I}_{\Lambda}} = \mathbf{B} \in \mathcal{I}_{\Lambda}(2)$. For $t \in \mathcal{I}_{\Lambda}(m+1)$, let $\lambda(t) \in \mathcal{I}_{\Lambda}(m)$ be $(t \mathbf{I})^{\bullet} \circ \mathbf{B}^m$. If t is $\lambda f x_1 \dots x_m x_{m+1}. f M$, $\lambda(t)$ is $\lambda f x_1 \dots x_m. f (\lambda x_{m+1}. M)$. Then $\lambda(t)$ is the unique element satisfying $t = \mathbf{app}_{\mathcal{I}_{\Lambda}}(\lambda(t), id_{\mathcal{I}_{\Lambda}}) = \lambda(t) \circ \mathbf{B}$. Hence we conclude that \mathcal{I}_{Λ} is a closed operad.

2.7 Towards Internal Operads of Combinatory Algebras

We have seen that, in the case of the λ -calculus and its graphical presentation, the following constructs are essential in defining the internal operad \mathcal{I}_{Λ} : the basic operators

$$\overline{\mathbf{B} : 2 \rightarrow 1} \quad \overline{\mathbf{I} : 0 \rightarrow 0} \quad \frac{P \text{ a closed term}}{P^{\bullet} : 0 \rightarrow 1}$$

and the composition as well as adding strands

$$\frac{M : l \rightarrow m \quad N : m \rightarrow n}{M \circ N : l \rightarrow n} \quad \frac{M : m \rightarrow n}{\mathbf{B}M : m + 1 \rightarrow n + 1} \quad \frac{M : m \rightarrow n}{M : m + 1 \rightarrow n + 1}$$

So far, terms with arity are defined using head normal forms. However, it is possible to characterize them just by using equations involving \mathbf{B} , \mathbf{I} , $(-)^{\bullet}$, with no mention to head normal forms as follows.

Proposition 2.1 *A closed λ -term M is of arity $m \rightarrow 1$ (or $M \in \mathcal{I}_{\Lambda}(m)$) iff $(M\mathbf{I})^{\bullet} \circ \mathbf{B}^m =_{\beta\eta} M$ iff $M^{\bullet} \circ \mathbf{B}^{m+1} =_{\beta\eta} (\mathbf{B}M) \circ \mathbf{B}$.*

Indeed, for $M = \lambda f x_1 \dots x_m. f N$, it is not hard to verify $M^{\bullet} \circ \mathbf{B}^{m+1} = (\mathbf{B}M) \circ \mathbf{B} = \lambda f g x_1 \dots x_m. f (g N)$. $M^{\bullet} \circ \mathbf{B}^{m+1} = (\mathbf{B}M) \circ \mathbf{B}$ implies $((M\mathbf{I})^{\bullet} \circ \mathbf{B}^m) f = (M^{\bullet} \circ \mathbf{B}^{m+1}) f \mathbf{I} = ((\mathbf{B}M) \circ \mathbf{B}) f \mathbf{I} = M f$, hence $(M\mathbf{I})^{\bullet} \circ \mathbf{B}^m = M$. Finally, $(M\mathbf{I})^{\bullet} \circ \mathbf{B}^m = M$ implies $M f x_1 \dots x_m = f (M\mathbf{I} x_1 \dots x_m)$, hence $M = \lambda f x_1 \dots x_m. f (M\mathbf{I} x_1 \dots x_m)$. More generally, we have

Proposition 2.2 *A closed λ -term M is of arity $m \rightarrow n$ iff $M^{\bullet} \circ \mathbf{B}^{m+1} =_{\beta\eta} (\mathbf{B}M) \circ \mathbf{B}^n$.*

These suggest that the internal operad construction can be carried out in any applicative structure with \mathbf{B} , \mathbf{I} and $(-)^{\bullet}$ which validates the $\beta\eta$ -equality (hence combinatory complete and extensional).

We conclude this section by noting that the condition $M^{\bullet} \circ \mathbf{B}^{m+1} =_{\beta\eta} (\mathbf{B}M) \circ \mathbf{B}^n$ of Proposition 2.2 can be understood as an exchange law $(\mathbf{B}^m N) \circ M = M \circ (\mathbf{B}^n N)$ as depicted in Figure 5.

3 Planar Combinatory Algebras

3.1 The Operad of Planar Polynomials

Given an applicative structure \mathcal{A} , we construct an operad $\mathcal{P}_{\mathcal{A}}$, where $\mathcal{P}_{\mathcal{A}}(m)$ is the smallest class of functions from \mathcal{A}^m to \mathcal{A} such that

- $\mathcal{P}_{\mathcal{A}}(0) = \mathcal{A}$,
- $id_{\mathcal{A}} \in \mathcal{P}_{\mathcal{A}}(1)$, and
- $t_1 \cdot t_2 \in \mathcal{P}_{\mathcal{A}}(m+n)$ for $t_1 \in \mathcal{P}_{\mathcal{A}}(m)$ and $t_2 \in \mathcal{P}_{\mathcal{A}}(n)$, where $(t_1 \cdot t_2)(x_1, \dots, x_m, y_1, \dots, y_n) = t_1(x_1, \dots, x_m) \cdot t_2(y_1, \dots, y_n)$.

The elements of $\mathcal{P}_{\mathcal{A}}(m)$ are *planar polynomials* with m variables. (If we allow pre-composing permutations, we have linear polynomials. If projections and duplications are allowed, we have the usual (non-linear) polynomials.)

The identity function id represents an occurrence of a variable. $\mathbf{app} = id \cdot id \in \mathcal{P}_{\mathcal{A}}(2)$ corresponds to the application: $\mathbf{app}(p, q) = p \cdot q$. Two planar polynomials with m -variables are equal when they are equal as functions from \mathcal{A}^m to \mathcal{A} .

3.2 $\mathbf{BI}(-)^{\bullet}$ -algebras as Planarly Combinatory Complete Applicative Structures

Suppose that \mathcal{A} is an applicative structure which is combinatory complete with respect to the planar polynomials $\mathcal{P}_{\mathcal{A}}$. That is, for any $p \in \mathcal{P}_{\mathcal{A}}(n+1)$, there exists $\lambda^*(p) \in \mathcal{P}_{\mathcal{A}}(n)$ such that $\lambda^*(p) \cdot id = p$. In \mathcal{A} , we have

- $\mathbf{I} = \lambda^*(id) \in \mathcal{A}$ which satisfies $\mathbf{I} \cdot a = a$
- $\mathbf{B} = \lambda^*(\lambda^*(\lambda^*(\mathbf{app}(id, \mathbf{app})))) \in \mathcal{A}$ satisfying $\mathbf{B} \cdot a \cdot b \cdot c = a \cdot (b \cdot c)$
- $a^{\bullet} = \lambda^*(\mathbf{app}(id, a)) \in \mathcal{A}$ for $a \in \mathcal{A}$, which satisfies $a^{\bullet} \cdot b = b \cdot a$

Conversely, if an applicative structure \mathcal{A} has elements \mathbf{I} , \mathbf{B} and a^{\bullet} for all $a \in \mathcal{A}$ satisfying $\mathbf{I}a = a$, $\mathbf{B}abc = a(bc)$ and $a^{\bullet}b = ba$, \mathcal{A} is combinatory complete with respect to the planar polynomials:

$$\lambda^*(id) = \mathbf{I} \quad \lambda^*(\mathbf{app}(t_1, t_2)) = \begin{cases} \mathbf{app}(\mathbf{app}(\mathbf{B}, t_2^{\bullet}), \lambda^*(t_1)) & t_2 \in \mathcal{A} \\ \mathbf{app}(\mathbf{app}(\mathbf{B}, t_1), \lambda^*(t_2)) & \text{otherwise} \end{cases}$$

Following Tomita [19], we call such an \mathcal{A} a $\mathbf{BI}(_)^\bullet$ -algebra. Thus, $\mathbf{BI}(_)^\bullet$ -algebras are precisely the planarly combinatory complete applicative structures. There are several interesting $\mathbf{BI}(_)^\bullet$ -algebras including: the term model of the planar λ -calculus modulo β - or $\beta\eta$ -equality; reflexive objects in monoidal closed categories; and models of Moggi's computational λ -calculus. Originally, $\mathbf{BI}(_)^\bullet$ -algebras were introduced in Tomita's study on non-symmetric (or planar) realizability. One of the central results in that context is that the assemblies on a $\mathbf{BI}(_)^\bullet$ -algebra form a closed multicategory. See [19,20] for further details, variations and examples.

3.3 Extensional $\mathbf{BI}(_)^\bullet$ -algebras

Planar combinatory completeness implies a natural interpretation $\llbracket _ \rrbracket$ of the planar λ -calculus in a $\mathbf{BI}(_)^\bullet$ -algebra, which is sound for the β -equality: $M =_\beta N$ implies $\llbracket M \rrbracket = \llbracket N \rrbracket$. However, the translation is in general not sound for the η -equality: $\llbracket \lambda x.M x \rrbracket \equiv \lambda^*x.\llbracket M x \rrbracket \equiv \mathbf{B} \llbracket M \rrbracket \mathbf{I}$, which may not agree with $\llbracket M \rrbracket$. To remedy this, we introduce additional axioms to $\mathbf{BI}(_)^\bullet$ -algebras:

Definition 3.1 A $\mathbf{BI}(_)^\bullet$ -algebra is *extensional* when it satisfies the following axioms.

$\mathbf{B} \mathbf{I} = \mathbf{I}$	(BI)
$(ab)^\bullet = \mathbf{B} b^\bullet (\mathbf{B} a^\bullet \mathbf{B})$	(app \bullet)
$\mathbf{B} \mathbf{B}^\bullet (\mathbf{B} \mathbf{B} (\mathbf{B} \mathbf{B} \mathbf{B})) = \mathbf{B} (\mathbf{B} \mathbf{B}) \mathbf{B}$	(B \bullet)
$\mathbf{B} \mathbf{I}^\bullet \mathbf{B} = \mathbf{I}$	(I \bullet)
$\mathbf{B} a^{\bullet\bullet} \mathbf{B} = \mathbf{B} (\mathbf{B} a^\bullet) \mathbf{B}$	($\bullet\bullet$)

Extensionality implies a lot.

Lemma 3.2 In an extensional $\mathbf{BI}(_)^\bullet$ -algebra, the composition $a \circ b = \mathbf{B} a b$ is associative, and \mathbf{I} is its unit: that is, $a \circ (b \circ c) = (a \circ b) \circ c$ and $\mathbf{I} \circ a = a = a \circ \mathbf{I}$ hold.

The extensional equality is a congruence for the λ^* -abstraction, and it follows that soundness for the $\beta\eta$ -equality holds: $M =_{\beta\eta} N$ in the planar λ -calculus implies $\llbracket M \rrbracket = \llbracket N \rrbracket$ in any extensional $\mathbf{BI}(_)^\bullet$ -algebra. Also, it is routine to see that the closed term model of the planar $\lambda\beta\eta$ -calculus is an extensional $\mathbf{BI}(_)^\bullet$ -algebra. So are the term models of the $\lambda\beta\eta$ -calculus, linear $\lambda\beta\eta$ -calculus, and even the braided $\lambda\beta\eta$ -calculus. As a result, completeness for the $\beta\eta$ -equality holds:

Proposition 3.3 $M =_{\beta\eta} N$ in the planar λ -calculus if and only if $\llbracket M \rrbracket = \llbracket N \rrbracket$ for all extensional $\mathbf{BI}(_)^\bullet$ -algebras.

Moreover, any extensional $\mathbf{BI}(_)^\bullet$ -algebra has an internally defined isomorphic $\mathbf{BI}(_)^\bullet$ -algebra in itself:

Proposition 3.4 For an extensional $\mathbf{BI}(_)^\bullet$ -algebra \mathcal{A} , $\mathcal{A}^\bullet \equiv \{a^\bullet \mid a \in \mathcal{A}\}$ is a $\mathbf{BI}(_)^\bullet$ -algebra with $a \cdot_{\mathcal{A}} b = b \circ a \circ \mathbf{B}$, $\mathbf{B}_{\mathcal{A}} = \mathbf{B}^\bullet$, $\mathbf{I}_{\mathcal{A}} = \mathbf{I}^\bullet$ and $a^{\bullet\mathcal{A}} = a^\bullet$, which is isomorphic to \mathcal{A} via $a \mapsto a^\bullet : \mathcal{A} \xrightarrow{\cong} \mathcal{A}^\bullet$ and $b \mapsto b \mathbf{I} : \mathcal{A}^\bullet \xrightarrow{\cong} \mathcal{A}$.

Indeed, the axiom (app \bullet) states that $(a \cdot b)^\bullet = a^\bullet \cdot_{\mathcal{A}} b^\bullet$ holds, and (B \bullet), (I \bullet) and ($\bullet\bullet$) imply that axioms for \mathbf{B} , \mathbf{I} and $(-)^{\bullet}$ hold in \mathcal{A}^\bullet . If we follow the graphical presentation in the previous section, the last three axioms can be depicted as follows, which might be more understandable:

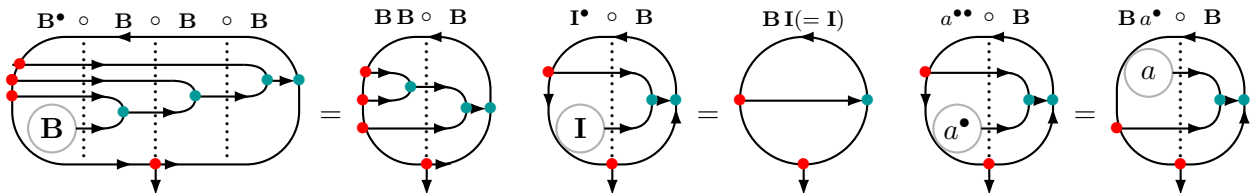

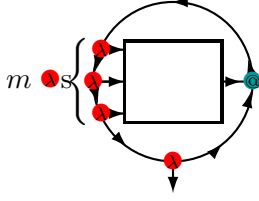
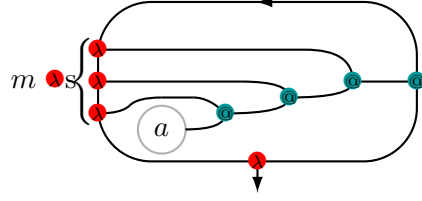
 Fig. 6. Elements of arity $m \rightarrow 1$

 Fig. 7. $a^\bullet \circ \mathbf{B}^m : m \rightarrow 1$

Actually, we have chosen these axioms following the graphical intuition. The internally defined $\mathbf{BI}(\cdot)^\bullet$ -algebra \mathcal{A}^\bullet is part of the structure of the internal operad to be spelled out below.

4 Internal Operads

As explained in Section 2, the idea of internal operads of a combinatory algebra \mathcal{A} was to use elements of arity $m \rightarrow 1$ (Figure 6) as polynomials with m variables. Thanks to combinatory completeness, such elements of arity $m \rightarrow 1$ are equal to elements of the form $a^\bullet \circ \mathbf{B}^m$ for some $a \in \mathcal{A}$ (Figure 7).

4.1 Internal Operads of Extensional $\mathbf{BI}(\cdot)^\bullet$ -algebras

For an extensional $\mathbf{BI}(\cdot)^\bullet$ -algebra \mathcal{A} , we define a closed operad $\mathcal{I}_{\mathcal{A}}$, which we shall call the *internal operad* of \mathcal{A} , by $\mathcal{I}_{\mathcal{A}}(m) = \{a^\bullet \circ \mathbf{B}^m \mid a \in \mathcal{A}\}$ with $id_{\mathcal{I}_{\mathcal{A}}} = \mathbf{I} = \mathbf{I}^\bullet \circ \mathbf{B} \in \mathcal{I}_{\mathcal{A}}(1)$ and $\mathbf{app}_{\mathcal{I}_{\mathcal{A}}} = \mathbf{B} = \mathbf{I}^\bullet \circ \mathbf{B} \circ \mathbf{B} \in \mathcal{I}_{\mathcal{A}}(2)$. For $f_i \in \mathcal{I}_{\mathcal{A}}(k_i)$ ($1 \leq i \leq n$) and $g \in \mathcal{I}_{\mathcal{A}}(n)$, the composite $g(f_1, \dots, f_n) \in \mathcal{I}_{\mathcal{A}}(k_1 + k_2 + \dots + k_n)$ is $f_1 \circ (\mathbf{B} f_2) \circ \dots \circ (\mathbf{B}^{n-1} f_n) \circ g$. For closedness, for $t \in \mathcal{I}_{\mathcal{A}}(m+1)$, let $\lambda(t) \in \mathcal{I}_{\mathcal{A}}(m)$ be $(t\mathbf{I})^\bullet \circ \mathbf{B}^m$. $\lambda(t)$ is the unique element satisfying $t = \mathbf{app}_{\mathcal{I}_{\mathcal{A}}}(\lambda(t), id_{\mathcal{I}_{\mathcal{A}}}) = \lambda(t) \circ \mathbf{B}$. (For verifying the closedness, it is useful to notice that $a \in \mathcal{I}_{\mathcal{A}}(m)$ if and only if $a = (a\mathbf{I})^\bullet \circ \mathbf{B}^m$ holds — indeed, for $x = a^\bullet \circ \mathbf{B}^m$, $x\mathbf{I} = a^\bullet (\mathbf{B}^m \mathbf{I}) = a^\bullet \mathbf{I} = a$, hence $(x\mathbf{I})^\bullet \circ \mathbf{B}^m = x$.)

Proposition 4.1 *For any extensional $\mathbf{BI}(\cdot)^\bullet$ -algebra \mathcal{A} , $\mathcal{I}_{\mathcal{A}}$ is a closed operad s.t. $\mathcal{I}_{\mathcal{A}}(0) = \mathcal{A}^\bullet \cong \mathcal{A}$. That is, \mathcal{A} is combinatory complete and extensional with respect to $\mathcal{I}_{\mathcal{A}}$.*

While Proposition 4.1 can be shown by direct calculation, it is much easier to make use of the notion of arities. Following our observation on arities on the closed λ -terms (Proposition 2.2), we define:

Definition 4.2 An element a of an extensional $\mathbf{BI}(\cdot)^\bullet$ -algebra is said to be of arity $m \rightarrow n$ when $a^\bullet \circ \mathbf{B}^{m+1} = (\mathbf{B} a) \circ \mathbf{B}^n$ holds.

It follows that $a : m \rightarrow 1$ iff $a \in \mathcal{I}_{\mathcal{A}}(m)$. We shall note that the last three axioms of extensional $\mathbf{BI}(\cdot)^\bullet$ -algebras say $\mathbf{B} : 2 \rightarrow 1$ ($\mathbf{B}\bullet$), $\mathbf{I} : 0 \rightarrow 0$ ($\mathbf{I}\bullet$) and $a^\bullet : 0 \rightarrow 1$ ($\bullet\bullet$) respectively.

Lemma 4.3 *The following hold in extensional $\mathbf{BI}(\cdot)^\bullet$ -algebras.*

- (i) $\mathbf{B} : 2 \rightarrow 1$, $\mathbf{I} : 0 \rightarrow 0$ and $a^\bullet : 0 \rightarrow 1$.
- (ii) If $a : l \rightarrow m$ and $b : m \rightarrow n$, then $a \circ b : l \rightarrow n$.
- (iii) If $a : m \rightarrow n$, then $\mathbf{B} a : m+1 \rightarrow n+1$. Moreover, $\mathbf{B}\mathbf{I} = \mathbf{I}$ and $\mathbf{B}(a \circ b) = (\mathbf{B} a) \circ (\mathbf{B} b)$ hold.
- (iv) If $a : m \rightarrow n$, then $a : m+1 \rightarrow n+1$.
- (v) For $a : m \rightarrow n$ and b , $(\mathbf{B}^m b) \circ a = a \circ (\mathbf{B}^n b)$ holds.

From this lemma, Proposition 4.1 easily follows. Moreover, using this notion of arity, we can define a PRO (strict monoidal category whose objects are generated from a single object) of extensional $\mathbf{BI}(\cdot)^\bullet$ -algebras, into which the internal operad fully faithfully embeds.

Theorem 4.4 *For any extensional $\mathbf{BI}(\cdot)^\bullet$ -algebra \mathcal{A} , we have a PRO $\mathcal{C}_{\mathcal{A}}$ whose arrows from m to n are \mathcal{A} 's elements of arity $m \rightarrow n$. In particular, we have $\mathcal{C}_{\mathcal{A}}(m, 1) = \mathcal{I}_{\mathcal{A}}(m)$.*

As an immediate corollary, we have a sort of Scott's theorem:

Corollary 4.5 *For any extensional $\mathbf{BI}(-)^\bullet$ -algebra \mathcal{A} , there exists a monoidal closed category \mathcal{D} with an object U such that U is isomorphic to the internal hom $[U, U]$ and the induced extensional $\mathbf{BI}(-)^\bullet$ -algebra $\mathcal{D}(I, U)$ is isomorphic to \mathcal{A} .*

Indeed, we may take the presheaf category $\mathbf{Set}^{\mathcal{C}_{\mathcal{A}}^{\text{op}}}$ (monoidal cocompletion of $\mathcal{C}_{\mathcal{A}}$) as \mathcal{D} and let $U = \mathcal{C}_{\mathcal{A}}(-, 1)$.

In Section 5, we will consider symmetric, braided and cartesian cases. For these cases, Theorem 4.4 can be refined as follows: $\mathcal{C}_{\mathcal{A}}$ is a PROP (strict symmetric monoidal category whose objects are generated from a single object) for the symmetric case, a PROB (strict braided monoidal category whose objects are generated from a single object) for the braided case, and a Lawvere theory for the cartesian case. The appropriate variation of Corollary 4.5 also holds for each case, where \mathcal{D} is symmetric, braided or cartesian, respectively.

4.2 Internal Operads vs Planar Polynomials

There exists a homomorphism F of closed operads from the internal operad $\mathcal{I}_{\mathcal{A}}$ to the operad $\mathcal{P}_{\mathcal{A}}$ of planar polynomials sending $f \in \mathcal{I}_{\mathcal{A}}(n)$ to $Ff \in \mathcal{P}_{\mathcal{A}}(n)$ (hence $Ff : \mathcal{A}^n \rightarrow \mathcal{A}$) by

$$(Ff)(a_1, \dots, a_n) = f \mathbf{I} a_1 \dots a_n.$$

F does not have to be faithful. As a counterexample, let \mathcal{A} be the extensional $\mathbf{BI}(-)^\bullet$ -algebra of closed terms of the *braided* λ -calculus [9] modulo $\beta\eta$ -equality, with $\mathbf{B} \equiv \lambda fxy.f(xy)$, $\mathbf{I} \equiv \lambda x.x$ and $M^\bullet \equiv \lambda f.fM$. The following two braided terms (in the syntax of [9])

$$M^+ \equiv \lambda fxy. \left[\begin{array}{c} y \quad x \\ \diagdown \quad \diagup \\ x \quad y \\ \hline f \quad f \end{array} \right] (f(yx)) \quad M^- \equiv \lambda fxy. \left[\begin{array}{c} y \quad x \\ \diagup \quad \diagdown \\ x \quad y \\ \hline f \quad f \end{array} \right] (f(yx))$$

give two distinct elements of $\mathcal{I}_{\mathcal{A}}(2)$. However, FM^+ and FM^- are the same map sending (a_1, a_2) to $a_2 a_1$, thus the information on braids is lost in $\mathcal{P}_{\mathcal{A}}(2)$. (In fact, while $\mathcal{P}_{\mathcal{A}}$ is a closed planar operad, it is *not* a braided operad. On the other hand, in Section 5 we will see that $\mathcal{I}_{\mathcal{A}}$ is a closed braided operad.)

4.3 The Canonicity of Internal Operads

In fact, the internal operad is the canonical – initial – one among the closed operads corresponding to an extensional $\mathbf{BI}(-)^\bullet$ -algebra.

Proposition 4.6 *Let \mathcal{A} be an extensional $\mathbf{BI}(-)^\bullet$ -algebra and \mathcal{P} a closed operad such that $\mathcal{P}(0) \cong \mathcal{A}$. Then there is a unique homomorphism of closed operads from $\mathcal{I}_{\mathcal{A}}$ to \mathcal{P} .*

Explicitly, the homomorphism from $\mathcal{I}_{\mathcal{A}}$ to \mathcal{P} sends (assuming $\mathcal{P}(0) = \mathcal{A}$ for simplicity) $t \in \mathcal{I}_{\mathcal{A}}(m)$ to $\mathbf{app}_{\mathcal{P}}(\dots(\mathbf{app}_{\mathcal{P}}(t \mathbf{I}, id_{\mathcal{P}}), id_{\mathcal{P}}) \dots, id_{\mathcal{P}}) \in \mathcal{P}(m)$. More succinctly, we have

Theorem 4.7 *The internal operad construction $\mathcal{A} \mapsto \mathcal{I}_{\mathcal{A}}$ gives a left adjoint to the functor from the category of closed operads (and operad homomorphisms preserving the closed structure) to that of extensional $\mathbf{BI}(-)^\bullet$ -algebras (and maps preserving the $\mathbf{BI}(-)^\bullet$ -algebra structure) sending a closed operad \mathcal{P} to an extensional $\mathbf{BI}(-)^\bullet$ -algebra $\mathcal{P}(0)$.*

5 Variations

5.1 Extensional BCI-algebras and Closed Symmetric Operads

An *extensional BCI-algebra* is an applicative structure with elements **B**, **C** and **I** satisfying the following axioms.

$\mathbf{B} a b c = a (b c)$	(B)
$\mathbf{C} a b c = a c b$	(C)
$\mathbf{I} a = a$	(I)
$\mathbf{B} \mathbf{I} = \mathbf{I}$	(λ)
$\mathbf{C} \mathbf{B} \mathbf{I} = \mathbf{I}$	(ρ)
$(\mathbf{B} \mathbf{B}) \circ \mathbf{B} = (\mathbf{C} \mathbf{B} \mathbf{B}) \circ (\mathbf{B} \circ \mathbf{B})$	(α)
$\mathbf{C} \circ \mathbf{C} = \mathbf{I}$	(cox_1)
$(\mathbf{B} \mathbf{C}) \circ (\mathbf{B} \circ \mathbf{B}) = (\mathbf{C} \mathbf{B} \mathbf{C}) \circ (\mathbf{B} \circ \mathbf{B})$	(cox_2)
$(\mathbf{B} \mathbf{C}) \circ (\mathbf{C} \circ (\mathbf{B} \mathbf{C})) = \mathbf{C} \circ ((\mathbf{B} \mathbf{C}) \circ \mathbf{C})$	(cox_3)
$(\mathbf{B} \mathbf{B}) \circ \mathbf{C} = \mathbf{C} \circ ((\mathbf{B} \mathbf{C}) \circ \mathbf{B})$	(bc)

These axioms first appeared in our previous work [9]. They are *chosen* so that the internal operad construction gives rise to a closed symmetric operad: (λ), (ρ) and (α) are for the unit law and associativity of the composition, while ($cox_{1,2,3}$) are the axioms of symmetric groups and (bc) is the equivariance of symmetry with respect to the application — also it is the Reidemeister move IV for trivalent graphs.

Recall that the *symmetric group* on n elements is generated by the adjacent transpositions $\sigma_i = (i, i+1)$ ($1 \leq i \leq n-1$) subject to the following relations (known as Coxeter relations):

$$\sigma_i^2 = e, \quad \sigma_i \sigma_j = \sigma_j \sigma_i \quad (j < i-1), \quad \sigma_{i+1} \sigma_i \sigma_{i+1} = \sigma_i \sigma_{i+1} \sigma_i.$$

The axioms (cox_1), (cox_2) and (cox_3) correspond to these axioms of symmetric groups. (cox_1) can be depicted as

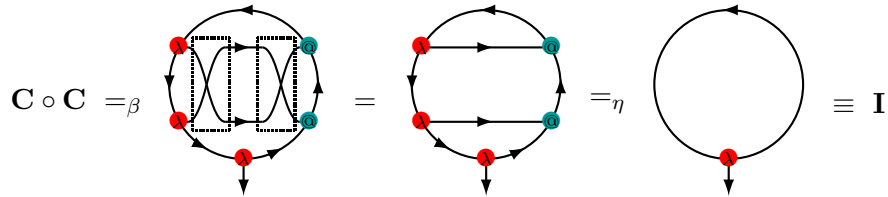

which amounts to the axiom $\sigma_i \sigma_i = e$ of the symmetric groups.

(cox_2) is equivalent to say that **C** is of arity $2 \rightarrow 2$, and expresses the following exchange law, which corresponds to the axiom $\sigma_i \sigma_j = \sigma_j \sigma_i$ ($j < i-1$) of symmetric groups:

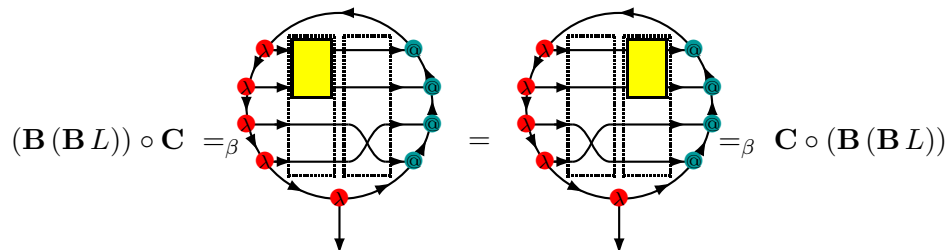

Finally, (cox_3) is

$$(\mathbf{BC}) \circ \mathbf{C} \circ (\mathbf{BC}) \stackrel{=}{=}_{\beta} \text{diagram} \stackrel{=}{=} \text{diagram} \stackrel{=}{=}_{\beta} \mathbf{C} \circ (\mathbf{BC}) \circ \mathbf{C}$$

which is the axiom $\sigma_{i+1}\sigma_i\sigma_{i+1} = \sigma_i\sigma_{i+1}\sigma_i$ of the symmetric groups.

On the other hand, the axiom (bc) is

$$(\mathbf{BB}) \circ \mathbf{C} \stackrel{=}{=}_{\beta} \text{diagram} \stackrel{=}{=} \text{diagram} \stackrel{=}{=}_{\beta} \mathbf{C} \circ (\mathbf{BC}) \circ \mathbf{B}$$

which amounts to the Reidemeister move IV [16,21] for knotted graphs:

A *symmetric operad* is an operad equipped with actions of symmetric groups satisfying equivariance conditions (see the case of braid groups below).

Lemma 5.1 *An extensional \mathbf{BCI} -algebra is also an extensional $\mathbf{BI}(-)^{\bullet}$ -algebra with $a^{\bullet} = \mathbf{CI}a$.*

Proposition 5.2 *For an extensional \mathbf{BCI} -algebra \mathcal{A} , $\mathcal{I}_{\mathcal{A}}$ is a closed symmetric operad s.t. $\mathcal{I}_{\mathcal{A}}(0) \cong \mathcal{A}$.*

Theorem 5.3 [9] *Extensional \mathbf{BCI} -algebras are sound and complete for the linear $\lambda\beta\eta$ -calculus.*

Theorem 5.4 *The internal operad construction $\mathcal{A} \mapsto \mathcal{I}_{\mathcal{A}}$ is left adjoint to the functor from the category of closed symmetric operads to that of extensional \mathbf{BCI} -algebras sending \mathcal{P} to $\mathcal{P}(0)$.*

5.2 Extensional $\mathbf{BC}^{\pm}\mathbf{I}$ -algebras and Closed Braided Operads

Extensional $\mathbf{BC}^{\pm}\mathbf{I}$ -algebras are a refinement of extensional \mathbf{BCI} -algebras in which the \mathbf{C} -combinator is replaced by the combinators \mathbf{C}^+ , \mathbf{C}^- for positive and negative braids:

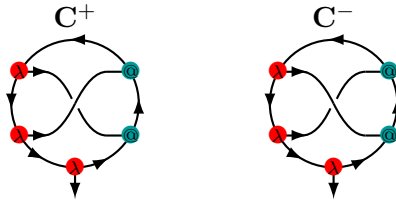

An extensional $\mathbf{BC}^{\pm}\mathbf{I}$ -algebra is an applicative structure with elements \mathbf{B} , \mathbf{C}^+ , \mathbf{C}^- and \mathbf{I} satisfying the following axioms.

$$(fs)(g_1, g_2, g_3) = (f(g_2, g_3, g_1))(s[1, 2, 1])$$

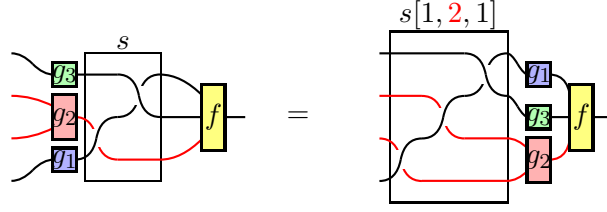

Fig. 8. The equivariance condition

$\mathbf{B}abc = a(bc)$	(B)
$\mathbf{C}^*abc = acb$	(C)
$\mathbf{I}a = a$	(I)
$\mathbf{C}^+ab = \mathbf{C}^-ab$	$(C2)$
$\mathbf{B}\mathbf{I} = \mathbf{I}$	(λ)
$\mathbf{C}^*\mathbf{B}\mathbf{I} = \mathbf{I}$	(ρ)
$(\mathbf{B}\mathbf{B}) \circ \mathbf{B} = (\mathbf{C}^*\mathbf{B}\mathbf{B}) \circ (\mathbf{B} \circ \mathbf{B})$	(α)
$\mathbf{C}^\pm \circ \mathbf{C}^\mp = \mathbf{I}$	(cox_1)
$(\mathbf{B}\mathbf{C}^\pm) \circ (\mathbf{B} \circ \mathbf{B}) = (\mathbf{C}^*\mathbf{B}\mathbf{C}^\pm) \circ (\mathbf{B} \circ \mathbf{B})$	(cox_2)
$(\mathbf{B}\mathbf{C}^\pm) \circ (\mathbf{C}^\pm \circ (\mathbf{B}\mathbf{C}^\pm)) = \mathbf{C}^\pm \circ ((\mathbf{B}\mathbf{C}^\pm) \circ \mathbf{C}^\pm)$	(cox_3)
$(\mathbf{B}\mathbf{B}) \circ \mathbf{C}^\pm = \mathbf{C}^\pm \circ ((\mathbf{B}\mathbf{C}^\pm) \circ \mathbf{B})$	(bc)

The double signs \pm and \mp in an equation should be taken as appropriately linked, while \star indicates an arbitrary choice of $+$ or $-$. (As we have $(C2)$, assuming just an instance of \star suffices.)

Closed terms of the braided λ -calculus [9] modulo the $\beta\eta$ -theory form an extensional $\mathbf{BC}^\pm\mathbf{I}$ -algebra. For a non-syntactic example, for any group G , the crossed G -set of infinite binary G -labelled trees [9] is an extensional $\mathbf{BC}^\pm\mathbf{I}$ -algebra; it is obtained as a reflexive object in the ribbon category of crossed G -sets and suitable relations [8].

A *braided operad* [6] is an operad equipped with actions of *braid groups* [2,15] satisfying *equivariance conditions* needed for handling substitutions involving braids. For instance, Figure 8 presents an instance of the equivariance condition, which shows that substituting a term with two free variables (g_2) for a variable in a braided term (fs) involves replacing a strand by two parallel strands in the braid (s).³ For further details see Appendix A.

Lemma 5.5 *An extensional $\mathbf{BC}^\pm\mathbf{I}$ -algebra is also an extensional $\mathbf{BI}(_)^\bullet$ -algebra with $a^\bullet = \mathbf{C}^+\mathbf{I}a$.*

Proposition 5.6 *For an extensional $\mathbf{BC}^\pm\mathbf{I}$ -algebra \mathcal{A} , $\mathcal{I}_{\mathcal{A}}$ is a closed braided operad s.t. $\mathcal{I}_{\mathcal{A}}(0) \cong \mathcal{A}$.*

We shall note that the axiom $(C2)$, which has no counterpart in the axioms of extensional \mathbf{BCI} -algebras, is added for making $\mathcal{I}_{\mathcal{A}}$ braided; it amounts to an instance of the equivariance condition: $(f\sigma_1)(g, id) = f(id, g) = (f\sigma_1^{-1})(g, id)$ for $f \in \mathcal{I}_{\mathcal{A}}(2)$ and $g \in \mathcal{I}_{\mathcal{A}}(0)$, where σ_1 is the generator of the braid group B_2 of two strands which corresponds to \mathbf{C}^+ and σ_1^{-1} is its inverse (corresponding to \mathbf{C}^-).

Theorem 5.7 *Extensional $\mathbf{BC}^\pm\mathbf{I}$ -algebras are sound and complete for the braided $\lambda\beta\eta$ -calculus.*

Theorem 5.8 *The internal operad construction $\mathcal{A} \mapsto \mathcal{I}_{\mathcal{A}}$ is left adjoint to the functor from the category of closed braided operads to that of extensional $\mathbf{BC}^\pm\mathbf{I}$ -algebras sending \mathcal{P} to $\mathcal{P}(0)$.*

³ Equivariance conditions are also found in the definition of substitutions in the braided λ -calculus [9], though we were not aware of the relevance of braided operads as of preparing that paper.

5.3 Extensional **SK**-algebras and Closed Cartesian Operads

Instead of **SK**-algebras, we study **BCIWK**-algebras with **W** corresponding to $\lambda f x.f x x$ and **K** corresponding to $\lambda f x.f$. (It is well known that **SK** and **BC(I)WK** are equivalent since Curry's work [5].) An extensional **BCIWK**-algebra is an extensional **BCI**-algebra with elements **W** and **K** subject to the axioms saying

- $\mathbf{W} : 1 \rightarrow 2$ and $\mathbf{K} : 1 \rightarrow 0$,
- **W** and **K** form a co-commutative comonoid, and
- **B** and a^\bullet are comonoid morphisms (the latter implies $\mathbf{W} a b = a b b$ and $\mathbf{K} a b = a$).

Explicitly, these axioms can be given as follows.

$\mathbf{W}^\bullet \circ \mathbf{B} \circ \mathbf{B} = (\mathbf{B} \mathbf{W}) \circ \mathbf{B} \circ \mathbf{B}$	($\mathbf{W} : 1 \rightarrow 2$)
$\mathbf{K}^\bullet \circ \mathbf{B} \circ \mathbf{B} = \mathbf{B} \mathbf{K}$	($\mathbf{K} : 1 \rightarrow 0$)
$\mathbf{W} \circ \mathbf{K} = \mathbf{I}$	(<i>co-unit</i>)
$\mathbf{W} \circ \mathbf{W} = \mathbf{W} \circ (\mathbf{B} \mathbf{W})$	(<i>co-associativity</i>)
$\mathbf{W} \circ \mathbf{C} = \mathbf{W}$	(<i>co-commutativity</i>)
$\mathbf{B} \circ \mathbf{W} = (\mathbf{B} \mathbf{W}) \circ \mathbf{W} \circ (\mathbf{B} \mathbf{C}) \circ \mathbf{B} \circ (\mathbf{B} \mathbf{B})$	(B comonoid morphism)
$\mathbf{B} \circ \mathbf{K} = \mathbf{K} \circ \mathbf{K}$	(B comonoid morphism)
$a^\bullet \circ \mathbf{W} = a^\bullet \circ a^\bullet$	(a^\bullet comonoid morphism)
$a^\bullet \circ \mathbf{K} = \mathbf{I}$	(a^\bullet comonoid morphism)

Proposition 5.9 *An extensional **SK**-algebra is equivalent to an extensional **BCIWK**-algebra.*

Proposition 5.10 *For an extensional **BCIWK**-algebra \mathcal{A} , $\mathcal{I}_{\mathcal{A}}$ is a closed cartesian operad s.t. $\mathcal{I}_{\mathcal{A}}(0) \cong \mathcal{A}$.*

Theorem 5.11 *Extensional **BCIWK**-algebras are sound and complete with respect to the $\lambda\beta\eta$ -calculus.*

Theorem 5.12 *The internal operad construction $\mathcal{A} \mapsto \mathcal{I}_{\mathcal{A}}$ is left adjoint to the functor from the category of closed cartesian operads to that of extensional **BCIWK**-algebras sending \mathcal{P} to $\mathcal{P}(0)$.*

This adjunction is actually an *adjoint equivalence* (cf. the Fundamental Theorem in [12], which covers non-extensional cases as well); the cartesian case is technically much simpler than other variations.

6 Conclusion and Future Work

We proposed to use (semi-)closed operads as an appropriate framework for discussing combinatory completeness of combinatory algebras. As an alternative of polynomials, we introduced internal operads which make sense for extensional planar, linear, braided as well as classical combinatory algebras. Among them, the braided case was not covered by the conventional ‘‘polynomials as functions’’ approach, and this fact prompted us to introduce internal operads. In our study, the planar case is of particular importance, as it serves as the common foundation of all other cases.

It is shown that the internal operad construction is left adjoint to the forgetful functor from closed operads to extensional combinatory algebras. In addition, the internal operad construction is useful for deriving extensionality axioms in a systematic, semantics-oriented way.

6.1 Future Work

There are several cases yet to be covered. It should be possible to study Tomita's bi-BDI-algebras [20] within our framework; it is likely that they correspond to (semi-)bi-closed planar operads. Also it would

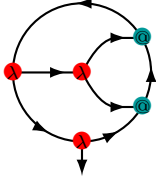

Fig. 9. The trace combinator \mathbf{Tr}

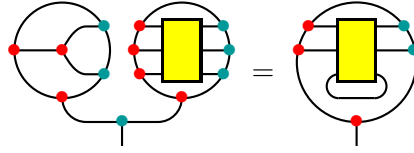

Fig. 10. Applying \mathbf{Tr}

be interesting to study combinatory algebras corresponding to the tangled (or knotted) λ -calculus briefly mentioned in [9]. For a possible direction, see the discussion on traced combinatory algebras below.

Another important direction is to relax the limitations of our approach. Firstly, we cannot handle applicative structures which are not combinatory complete. For example, the extensional theory of \mathbf{B} -terms of Ikebuchi and Nakano [13] is not covered — for lack of the \mathbf{I} -combinator, it does not give rise to an operad. It would be nice if we could extend our framework to cover such cases. Secondly, it is desirable to have a weak internal operad construction for non-extensional combinatory algebras, which would give rise to semi-closed operads.

Finally, in this paper we did not consider partial algebras nor relation to realizability. For that direction it would be useful to have a framework generalizing both ours and Turing categories [4].

6.2 Traced Combinatory Algebras

The graph \mathbf{Tr} shown in Figure 9 does not correspond to a λ -term, but has interpretations in some $\mathbf{BC}^\pm\mathbf{I}$ -algebras, e.g., those arising as a reflexive object in a ribbon category, including the crossed G -set of G -labelled infinite binary trees [9]. By applying \mathbf{Tr} , we can create *trace* [14] in the internal PROP/PROB, as depicted in Figure 10. Such a trace operator allows us to represent knots and tangles. For instance, the trefoil knot can be expressed as the braid closure $\mathbf{Tr}(\mathbf{Tr}(\mathbf{C}^+ \circ \mathbf{C}^+ \circ \mathbf{C}^+))$ of $\mathbf{C}^+ \circ \mathbf{C}^+ \circ \mathbf{C}^+$:

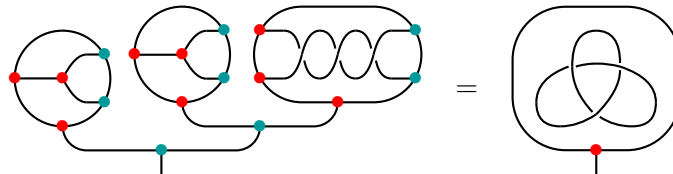

Actually \mathbf{Tr} is far more expressive than one might expect. With \mathbf{Tr} , we can define the combinators

$$\eta = \mathbf{Tr}(\mathbf{Tr} \circ (\mathbf{B} \mathbf{Tr}) \circ (\mathbf{B} \mathbf{C}) \circ \mathbf{C}) : 0 \rightarrow 2 \quad \text{and} \quad \varepsilon = \mathbf{Tr}(\mathbf{C} \circ (\mathbf{B} \mathbf{C}) \circ (\mathbf{B} \mathbf{B}) \circ \mathbf{B}) : 2 \rightarrow 0$$



which satisfy the zig-zag equation $\eta \circ (\mathbf{B} \varepsilon) = (\mathbf{B} \eta) \circ \varepsilon = \mathbf{I}$, e.g.

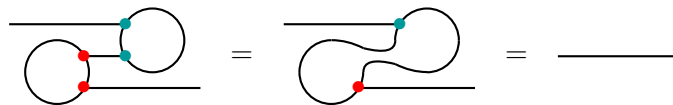

Thus the internal PROP is not just traced but also compact closed (ribbon in the braided case).

It is tempting to call such combinatory algebras with \mathbf{Tr} *traced combinatory algebras*; to be more precise, a traced combinatory algebra should be an extensional $\mathbf{BC}^\pm\mathbf{I}$ -algebra (or \mathbf{BCI} -algebra in the symmetric case) equipped with a trace combinator \mathbf{Tr} . The axiomatizations of traced combinatory algebras, and the corresponding tangled λ -calculus, are left as an interesting future work.

References

- [1] Abramsky, S., and M. Lenisa, *Linear realizability and full completeness for typed lambda-calculi*, Annals of Pure and Applied Logic **134** (2005), 122–168, DOI: <https://doi.org/10.1016/j.apal.2004.08.003>
- [2] Artin, E., *Theorie der Zöpfe*, Abh. Math. Sem. Univ. Hamburg **4** (1925), 47–72, DOI: <https://doi.org/10.1007/BF02950718>
- [3] Barendregt, H. P., “The Lambda Calculus, its Syntax and Semantics,” 2nd ed., North-Holland, 1984, ISBN: 9780444875082
- [4] Cockett, J.R.B., and P.J.W. Hofstra, *Introduction to Turing categories*, Annals of Pure and Applied Logic **156** (2008), 183–209, DOI: <https://doi.org/10.1016/j.apal.2008.04.005>
- [5] Curry, H.B., *Grundlagen der kombinatorischen logik*, American Journal of Mathematics **52** (1930), 509–536, DOI: <https://doi.org/10.2307/2370716>
- [6] Fiedorowicz, Z., *The symmetric bar construction*, Preprint (1996), <https://people.math.osu.edu/fiedorowicz.1/>
- [7] Freyd, P., *Combinators*, Contemp. Math., **92** (1989), 63–66, a revised version available from <https://www2.math.upenn.edu/~pjf/combinators.pdf>
- [8] Hasegawa, M., *A quantum double construction in Rel*, Mathematical Structures in Computer Science **22** (2012), 618–650, DOI: <https://doi.org/10.1017/S0960129511000703>
- [9] Hasegawa, M., *A braided lambda calculus*, Proc. 2nd Joint International Workshop on Linearity & Trends in Linear Logic and Applications (Linearity & TLLA 2020), Electronic Proceedings in Theoretical Computer Science **353** (2021), 94–108, DOI: <https://doi.org/10.4204/EPTCS.353.5>
- [10] Hoshino, N., *Linear realizability*, Proc. Computer Science Logic (CSL 2007), Springer Lecture Notes in Computer Science **4646** (2007), 420–434, DOI: https://doi.org/10.1007/978-3-540-74915-8_32
- [11] Hindley, J.R., and J.P. Seldin, “Lambda-Calculus and Combinators, an Introduction,” Cambridge University Press, 2008, ISBN: 9780521898850
- [12] Hyland, J.M.E., *Classical lambda calculus in modern dress*, Mathematical Structures in Computer Science **27** (2017), 762–781, DOI: <https://doi.org/10.1017/S0960129515000377>
- [13] Ikebuchi, M., and K. Nakano, *On properties of B-terms*, Logical Methods in Computer Science **16** (2020), DOI: [https://doi.org/10.23638/LMCS-16\(2:8\)2020](https://doi.org/10.23638/LMCS-16(2:8)2020)
- [14] Joyal, A., R. Street and D. Verity, *Traced monoidal categories*, Math. Proc. Cambridge Phils. Soc. **119** (1996), 447–468, DOI: <https://doi.org/10.1017/S0305004100074338>
- [15] Kassel, C., and V.G. Turaev, “Braid Groups,” Graduate Texts in Mathematics 247, Springer-Verlag, 2008, DOI: <https://doi.org/10.1007/978-0-387-68548-9>
- [16] Kauffman, L.H., *Invariants of graphs in three-space*, Trans. Amer. Math. Soc. **311** (1989), 697–710, DOI: <https://doi.org/10.1090/S0002-9947-1989-0946218-0>
- [17] Leinster, T., “Higher Operads, Higher Categories,” London Mathematical Society Lecture Note Series **298**, Cambridge University Press, 2004, DOI: <https://doi.org/10.1017/CB09780511525896>
- [18] Selinger, P., *The lambda calculus is algebraic*, J. Functional Programming **12** (2002), 549–566, DOI: <https://doi.org/10.1017/S0956796801004294>
- [19] Tomita, H., *Realizability without symmetry*, Proc. 29th EACSL Annual Conference on Computer Science Logic (CSL 2021), Leibniz International Proceedings in Informatics **183** (2021), 38:1–38:16, DOI: <https://drops.dagstuhl.de/opus/volltexte/2021/13472>
- [20] Tomita, H., *Planar realizability via left and right applications*, Proc. 30th EACSL Annual Conference on Computer Science Logic (CSL 2022), Leibniz International Proceedings in Informatics **216** (2022), 35:1–35:17, DOI: <https://doi.org/10.4230/LIPIcs.CSL.2022.35>
- [21] Yetter, D.N., *Category theoretic representations of knotted graphs in \mathbb{S}^3* , Adv. Math. **77** (1989), 137–159, DOI: [https://doi.org/10.1016/0001-8708\(89\)90017-0](https://doi.org/10.1016/0001-8708(89)90017-0)
- [22] Zeilberger, N., *Linear lambda terms as invariants of rooted trivalent maps*, J. Functional Programming **26** (2016), e21, DOI: <https://doi.org/10.1017/S095679681600023X>
- [23] Zeilberger, N., *A theory of linear typings as flows on 3-valent graphs*, Proc. 33rd Annual ACM/IEEE Symposium on Logic in Computer Science (LICS 2018), 919–928, DOI: <https://doi.org/10.1145/3209108.3209121>

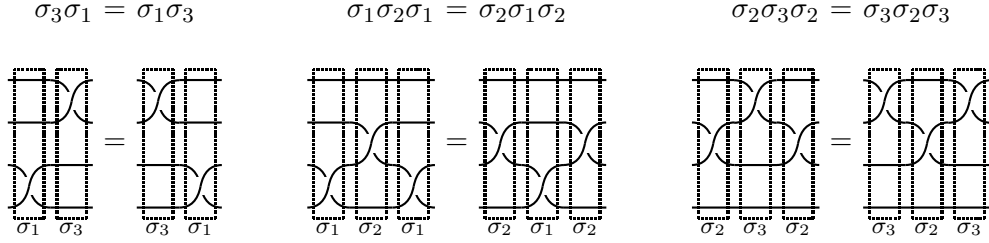

Fig. A.1. Axioms of B_4

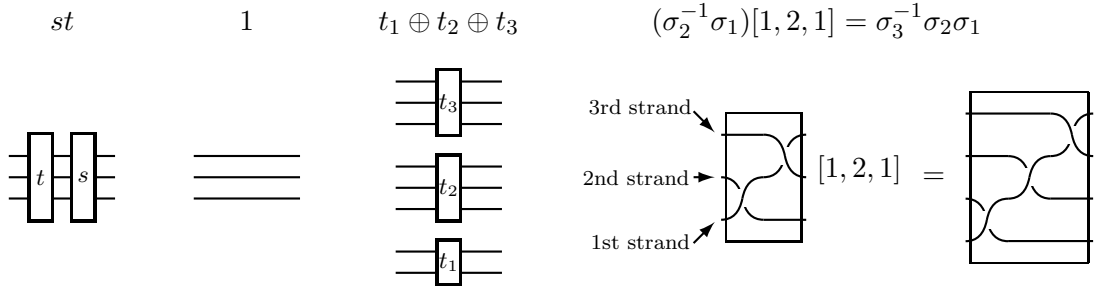

Fig. A.2. Some constructions on braids

A Braided Operads

A.1 Braid Groups

Let B_n be the Artin braid group with n strands [2,15], which can be represented by $n - 1$ generators $\sigma_1, \dots, \sigma_{n-1}$ and the relations

$$\sigma_i \sigma_j = \sigma_j \sigma_i \quad (j < i - 1), \quad \sigma_i \sigma_{i+1} \sigma_i = \sigma_{i+1} \sigma_i \sigma_{i+1}$$

Figure A.1 illustrates a graphical reading of the relations of B_4 .

Let S_n be the symmetric group on $\{1, \dots, n\}$. Let us denote the obvious homomorphism from B_n to S_n sending σ_i to the permutation $(i, i + 1)$ by $|\cdot| : B_n \rightarrow S_n$. For $s \in B_k$ and non-negative integers j_1, \dots, j_k , let $s[j_1, \dots, j_k] \in B_{j_1 + \dots + j_k}$ be the braid obtained from s by replacing the m -th strand by j_m parallel strands for $m = 1, \dots, k$. When $j_m = 0$, the m -th strand is simply deleted. (For the extreme case that all j_m are 0, let B_0 be the trivial group.) In our previous work on the braided λ -calculus [9], $s[j_1, \dots, j_k] \in B_{j_1 + \dots + j_k}$ amounts to the substitution map $s[k := j_k] \dots [1 := j_1]$.

For $t_1 \in B_{j_1}, \dots, t_k \in B_{j_k}$, $t_1 \oplus \dots \oplus t_k \in B_{j_1 + \dots + j_k}$ is the block direct sum of the braids t_1, \dots, t_k . See Figure A.2 for a graphical account of these constructions.

A.2 Braided Operads

A *braided operad* [6] is an operad $\mathcal{P} = (\mathcal{P}(n))_{n \in \mathbb{N}}$ equipped with actions of the braid groups $\mathcal{P}(j) \times B_j \rightarrow \mathcal{P}(j)$ satisfying the following equivariance conditions

$$\begin{aligned} (fs)(g_1, \dots, g_k) &= (f(g_{s^{-1}(1)}, \dots, g_{s^{-1}(k)}))s[j_1, \dots, j_k] \\ f((g_1 t_1), \dots, (g_k t_k)) &= (f(g_1, \dots, g_k))(t_1 \oplus \dots \oplus t_k) \end{aligned}$$

where $f \in \mathcal{P}(k)$ and $g_i \in \mathcal{P}(j_i)$; $s \in B_k$ acts on $\{1, \dots, k\}$ via the homomorphism $|\cdot| : B_k \rightarrow S_k$ (so $s(i) = |s|(i)$). Figure 8 in Section 5 illustrates an instance of the first equivariance condition.