

# Public Transit Arrival Prediction: a Seq2Seq RNN Approach<sup>†</sup>

Nancy Bhutani<sup>§</sup>, Soumen Pachal<sup>§</sup>, Avinash Achar<sup>\*§</sup>.

**Abstract**—Arrival/Travel times for public transit exhibit variability on account of factors like seasonality, dwell times at bus stops, traffic signals, travel demand fluctuation etc. The developing world in particular is plagued by additional factors like lack of lane discipline, excess vehicles, diverse modes of transport and so on. This renders the bus arrival time prediction (BATP) to be a challenging problem especially in the developing world. A novel data-driven model based on recurrent neural networks (RNNs) is proposed for BATP (in real-time) in the current work. The model intelligently incorporates both spatial and temporal correlations in a unique (non-linear) fashion distinct from existing approaches. In particular, we propose a Gated Recurrent Unit (GRU) based Encoder-Decoder(ED) OR Seq2Seq RNN model (originally introduced for language translation) for BATP. The geometry of the dynamic real time BATP problem enables a nice fit with the Encoder-Decoder based RNN structure. We feed relevant additional synchronized inputs (from previous trips) at each step of the decoder (a feature classically unexplored in machine translation applications). Further motivated from accurately modelling congestion influences on travel time prediction, we additionally propose to use a bidirectional layer at the decoder (something unexplored in other time-series based ED application contexts). The effectiveness of the proposed algorithms is demonstrated on real field data collected from challenging traffic conditions. Our experiments indicate that the proposed method outperforms diverse existing state-of-art data-driven approaches proposed for the same problem.

**Index Terms**—Travel-Time Prediction, Nonlinear Predictive Modelling, Recurrent Neural Networks, Encoder-Decoder, Seq2Seq.

## I. INTRODUCTION

Constantly increasing traffic congestion levels is a perennial problem across geographies on account of steadily increasing urban population and associated traffic volumes. Enhancing the public transit standard is one promising approach to mitigate this ubiquitous problem. This not only reduces traffic volumes and congestion in turn, but would also curtail pollution. Public transit needs to be reliable to remain attractive among commuters. This would mean maintaining schedules to the extent feasible and providing accurate arrival time predictions in real-time. Such accurate estimates can aid commuters plan their arrival to bus-stops and minimize waiting times. Bus travel time predictions can also aid passengers who plan/decide to board a bus based on predictions to reach a desired destination bus-stop. The bus arrival time prediction (BATP) can potentially also aid transport administrators take

real-time corrective measures when the bus is off schedule. Hence providing quality BATPs is crucial for reliable mass transit.

Literature around BATP research is about two decades old. In developed countries, it is arguably a well solved problem. However, it continues to be a challenging research problem in the context of developing economies. The main factors contributing to this include (1)lack of lane discipline (2) inhomogeneity of traffic (i.e. transport modes can range from bicycles, two wheelers to heavy vehicles like trucks and buses) with dedicated lanes absent for specific modes of transport. We refer to this as *mixed traffic* conditions. The real data we consider in this paper is from a bus route in Delhi, the capital of India which routinely experiences such conditions. Any google-map based bus travel time query (in most cities in India including Delhi) has till recently mostly returned a constant prediction irrespective of the date or time of query. These returned (fixed) travel times seem to be based on some pre-fixed schedules which are almost unimplementable given the chaotic nature of traffic here. Further, ETA (Expected time of arrival) solutions are still being continuously improved upon by Google at a network level across the world for different modes of urban transport[1], [2]. Owing to these aforementioned factors, BATP is still a challenging research problem [3] especially under mixed traffic conditions [4], [5].

The BATP literature has seen a wide range of methods over the years. A broad predominant line of attack comes from the class of data-driven methods. Most of these segment an entire route into smaller segments (or sections) either uniformly [6] OR based on non-uniform segments connecting successive bus-stops. The data input in such methods can range over entities like flow, density, speed, travel time etc. depending on the sensing infrastructure in place and the algorithm. In this work, we consider scenarios where input data comes only from travel times experienced at each of these sections/segments. Such travel times can be *easily* obtained from AVL (automatic vehicle location) data gathered via GPS sensing.

**Gaps and Contributions:** Existing data-driven methods for BATP have adopted a diverse range of techniques which include ARIMA models [7], linear statistical models like Kalman filters [4], [8], support vector machines [9], [10], [11], feed-forward ANNs [12], [2], recurrent neural networks [13], [14], CNNs [5], temporal difference learning[15] and so on. Most of the existing approaches suffer from a variety of issues like (i)not exploiting the historical data sufficiently for model calibration [16], [17], [6] OR (ii)do not exploit spatial correlations [8], [18], [10] (iii) fail to capture temporal correlations([12], [19]) (iv)do not exploit the current real-time

\* Avinash Achar is the corresponding author.

§ All authors contributed equally.

Nancy Bhutani, Soumen Pachal, Avinash Achar are with TCS Research, Chennai, INDIA. E-mail: {nancy.9.s.pachal,achar.avinash}@tcs.com.

Manuscript received Apr 2022

information sufficiently([20]). (v)segment the time-axis into uniform bins, which can lead to inaccurate predictions[13], [14]. There has been some recent work on exploiting spatio-temporal correlations [4], [11], [5], [13], [14] as well in this direction.

From an RNN literature perspective, there's been recent work where people have explored ED (also known as Seq2Seq) architectures for real-valued data [21], [22] (time-series (TS) in particular). However, employing a Seq2Seq (ED) architecture for B ATP as prescribed in these time-series approaches is not immediately evident due to difference in structure of available data between B ATP and traditional time-series. In particular, GPS based data has a unique spatio-temporal aspect with information scattered across trips throughout the day.

The current work proposes a novel ED architecture (different from classical machine translation architecture OR existing ED approaches for time-series) which is also distinct from all existing B ATP approaches (in particular from ED based B ATP approaches also [13], [14]). It exploits current real-time spatio-temporal correlations and historical seasonal correlations for nonlinear modelling and prediction. Specifically

- We recast the real-time B ATP problem to a novel and unique Encoder-Decoder framework with real-time spatio-temporal inputs and historical seasonal inputs carefully placed in the architecture. The proposed ED model's sequential aspect is mapped to the spatial dimension of B ATP, while the temporal aspects of B ATP are captured by feeding the associated inputs as decoder inputs in a space synchronized fashion. The (multiple) targets of the real-time B ATP prediction task are intelligently mapped to the outputs of the decoder sequentially.
- Travel times from the just traversed sections of current bus (constitute the spatial correlations) are fed as inputs to the encoder. While real-time information coming from previous bus's travel times across subsequent sections (constituting temporal correlations) are fed in a synchronized sequential fashion into the decoder as additional inputs. Note that these synchronised inputs at the decoder are absent in the classic ED application for machine translation [23], [24]. The section travel times (of current bus) across subsequent sections are the prediction targets which are neatly mapped to the decoder outputs sequentially. Weekly seasonal correlations are also incorporated via additional inputs from the closest trip of the previous week.
- We propose a bidirectional layer at the decoder as this can now capture (for a given section) the possible upstream influence of past congestions (in time) across the subsequent sections propagating backward in space (along the bus route). This feature of our ED architecture is unexplored in other time-series based applications of ED to the best of our knowledge.
- We demonstrate the proposed approach's effectiveness on real field data gathered from a route in a mixed traffic condition from Delhi. Our experiments clearly illustrate superior performance of the proposed method compared to state-of-art baselines.

## II. LITERATURE REVIEW AND RELATED WORK

Over the last decade or two, the literature on B ATP has seen many different approaches. A variety of data inputs like flow information, travel times, speed, weather, scheduled time tables [25], crowd-sourced data[26] and so on have been considered by researchers for prediction. One can divide the diverse landscape of approaches into two broad categories: (i)traffic-theory based (See App. A) (ii)data-driven.

### A. Data-driven methods

Data-driven methods, instead of adopting a detailed modeling based on physics of the traffic, typically employ a coarse model (based on measurable entities) that is good enough for the prediction problem at hand. There exist a class of methods which utilize a data-based model but do not perform learning based on historical data in a full-fledged sense. Rest of the approaches learn from past historical data to estimate the necessary parameters of a suitable predictive model, which is employed further for real-time predictions.

**Without Learning:** This is a class of methods which don't learn from historical-data explicitly. One of the earliest approaches (using a Kalman filter) was proposed in [27], which used travel times of previous bus and travel times from previous day (same time), as inputs. The method captures temporal dependencies only with an adhoc parameter choice in the state space model. The later approaches which employ a linear state-space model involving travel times, *calibrate* (or fix) the data-based model parameters in real time. These parameters are chosen either based on (a) current data of previous bus [16], [6] or (b)a suitable optimal travel-time data vector from the historical data-base [28].

**Explicit Learning:** The literature has seen a wide variety of learning methods from historical data. For instance, support vector regression [10] and feed-forward ANN [18] based methods have been proposed which capture only temporal correlations via multiple previous bus travel times. An SVR based prediction with static inputs like link length and dynamic inputs like rate of road usage and speed is proposed in [20]. However it doesn't consider current bus position OR the previous bus inputs. [29] proposes a speed based prediction scheme using a weighted average of historically averaged section speed and current bus speed as inputs, while ignores information from previous bus as earlier. [9] considers a dynamic SVR based prediction scheme where current bus's travel time at the previous section and previous bus's travel time at the current section are considered as inputs during training. This scheme exploits both spatial and temporal correlations in the data in a minimal way.

A single hidden layer feed-forward ANN is trained in [12] based on current position of the bus and time of query to predict arrival times across all subsequent stops. It learns a single model to predict travel times between any two bus stops on the route. This renders the target travel time variable's dynamic range very large in this method. A recent approach capturing spatio-temporal correlations based on linear statistical models (non-stationary) was proposed in [4] which uses a linear kalman filter for prediction across sections. It uses

linear models to capture the spatial correlations. The temporal correlations come from the (currently plying) previous bus section travel time. Another approach using linear statistical models and exploiting real-time temporal correlations (from previous buses) was proposed in [8]. A nonlinear generalization of [4] using support vector function approximators capturing spatio-temporal correlations was proposed in [11]. CNN based approach capturing spatio-temporal correlations was proposed in [5] recently where the conditional predictive distributions were parameterized using masked-CNNs. The CNN output modeled the travel-time between any two bus-stops in a quantized form.

An interesting approach based on combining CNNs and RNNs is provided in [13]. In particular the convolutional layer captures the (one-dimensional) spatial correlations from the adjacent sections of the 1-D route, while the recurrent structure captures the temporal correlations. A convolutional-RNN based ED architecture is employed to capture accurate multi time-step predictions. [14] considers an attention-based extension of [13]. [30] considers a simplified RNN with no state feedback (in spite of weight sharing across time-steps) with attention, but only models single time-step predictions. In all these three RNN approaches, the time axis is partitioned uniformly into time bins (of width 15-min).

A recent computationally interesting approach where BATP is recast as a value function estimation problem under a suitably constructed Markov reward process is proposed in [15]. This enables exploring a family of value-function predictors using temporal-difference (TD) learning.

## B. Related ED based RNN approaches

The ED architecture was first successfully proposed for language translation applications[23], [24]. The proposed architecture was relatively simple with the context from the last time-step of the encoder fed as initial state and explicit input for each time-step of the decoder. Over the years, machine translation literature has seen intelligent improvements over this base structure by employing attention layer, bidirectional layer etc. in the encoder. Further, the ED framework has been successfully applied in many other tasks like speech recognition[31], image captioning etc.

Given the variable length Seq2Seq mapping ability, the ED framework naturally can be utilized for multi-step (target) time-series prediction where the raw data is real-valued and target vector length can be independent of the input vector. An attention based ED approach (with a bidirectional layer in the encoder) for multi-step TS prediction was proposed in [22] which could potentially capture seasonal correlations as well. However, this architecture doesn't consider exogenous inputs. An approach to incorporate exogenous inputs into predictive model was proposed in [21], where the exogenous inputs in the forecast horizon are fed in a synchronized fashion at the decoder steps. Our approach is close to the above TS approaches.

## C. Proposed approach in perspective of related approaches

From the above discussion, it is clear that many existing approaches either fail to exploit historical data for model

building OR fail to capture spatial or temporal correlations. The remaining approaches even though exploit the spatio-temporal correlations in different ways [9], [4], [11], [5], [13], [14], suffer different drawbacks. For instance, [9] just explores the travel time measurement at the current section from the previous bus (temporal correlation) irrespective of when the previous bus made this traversal. The spatial correlation comes from travel time at the previous section from the current bus. [4] addresses the issues of [9] as follows. It considers travel time measurements from multiple previous sections of the current bus to better capture the spatial correlations. The temporal correlations here additionally factor the closeness of the previous bus by hypothesizing a parameterized functional form dependent on the start time difference and the current section travel time. It adopts a predominantly linear modelling approach culminating in a Linear Kalman filter for prediction. As explained earlier, a support-vector based nonlinear generalization of [4] is considered in [11]. It learns the potentially non-linear spatial and temporal correlations at a single-step level and then employs an extended kalman filter for spatial multi-step prediction. Compared to our non-linear ED (Seq2Seq) approach here, [4] considers mainly a linear modelling. While [11] adopts a non-linear modelling, the model training happens with single-step targets in both [4], [11]. However, both these KF approaches adopt a recursive sequential multi-step prediction which can be prone to error accumulation. On the other hand, our ED approach circumvents this issue of both these KFs by training with vector targets where the predictions across all subsequent sections are padded together into one target-vector.

CNN approach of [5] models travel time targets as categorical values essentially using a soft-max at the output layer. This approach hence is sensitive to the quantization level. A coarse quantization leads to some significant errors whenever the target is exactly between two consecutive levels. On the other hand, a fine quantization leads to too many outputs which in turn leads to a large number of weights to be learnt and a potentially imbalanced multi-class problem. The proposed method on the other hand models targets as real-valued.

All LSTM approaches [13], [14], [30] bin the time-axis into 15 minute intervals. This strategy inherently makes an assumption that the predictions across a link is constant for a 15 minute interval. However, this assumption can be pretty restrictive and unrealistic especially during peak hours when the bus headway is low. The method in [8] also bins the time-axis and builds temporal models at each section while only exploiting temporal correlations. Our approach on the other hand doesn't make any such restrictive assumptions and we model time as a continuous entity.

While [13] also uses an ED architecture for prediction, it employs sequential RNN to model time. In contrast, our sequential RNN (ED) captures the spatial aspect of the problem. Accordingly our decoder output models the travel times across the subsequent sections of the currently plying bus. In contrast, [13] uses a 1-D CNN to capture spatial correlations. Further, our method captures temporal correlations by feeding the entry and travel times of the closest previous bus at subsequent sections as decoder inputs in a space synchronised fashion.

Further we also use a bidirectional layer at the decoder to capture possible upstream propagating congestion influences. This makes our ED approach very different from that of [13].

The TD approach of [15] (as explained earlier) where a value function estimation of a suitable Markov reward process (MRP) is carried out, is clearly distinct from our approach here. The travel-time across each section is modeled as the one-step reward. For each destination section (or bus stop), a MRP is constructed with all preceding sections (along with features like time of day etc.) encoded as states, while the destination section is the final state. This approach while conceptually interesting performs poorly for short to mid-range sub-routes.

BusTr [2] models the bus-stop dwell time and run time across a segment separately using a feed-forward ANN (FFN), where the FFN weights are shared across road segments and bus stops. The inputs to the FFN are the (i) speed forecast based on current real-time traffic from google maps and (ii) features based on location embedding, both of which are unused in our approach. The speed forecast used is that of cars, whose speed based travel times are linearly transformed to that of bus while the linear weights are modelled as the output of the FFN whose weights are learnt during training. Overall BusTr differs from our method in most aspects like the inputs and targets used for prediction and the predictive model.

Compared to the ED based TS prediction approaches [22], [21], one novel feature is the use of a bidirectional layer at the decoder (unexplored to the best of our knowledge in TS approaches). This feature is strongly motivated from the B ATP application as explained in detail in Sec. III-D2. Also, in contrast to [22], [21], we employ additional inputs at the decoder to factor real-time temporal and weekly seasonal correlations, something absent in [22], [21].

### III. METHODOLOGY

#### A. Data Preliminaries

**Data Input:** We segment the given bus route uniformly into sections. Our input training data includes travel times experienced across each of these sections for all transpired trips along the given route. The observed section travel times, include the running time across the section and the dwell time at the possible bus-stops in the section. As mentioned in the introduction, travel times were obtained from AVL data obtained via high frequency GPS based sensing.

**Uniform Segmenting:** We chose this for two reasons. (i) There is prior work [6], [17] where people have split the route uniformly into segments and predicted bus travel time between any two bus stops, and reported reasonable performance. (ii) *Ease of testing across multiple bus-routes:* Non-uniform segmenting where segment ends correspond to bus-stops means significant additional book-keeping. (iii) *Ease of adapting section-level predictions to the bus-stop level as explained next.*

*Our learning and prediction method can also be used as it is under non-uniform segmenting of the route (where the section travel times will now be travel times between two consecutive bus-stops).* But we strongly reckon the trend in the results

(between the proposed and the baseline methods) in the non-uniform case will not be very different from the uniform case reported here.

**Adapt to bus-stop level:** Also, the predictions based on uniform segmenting which predict between any two segments can be easily adapted to predict between any two bus-stops. Specifically, given any two bus stops  $i$  and  $j$ , we could consider the segment start in which bus-stop  $i$  lies and perform our proposed ED based prediction till the end of the segment which contains bus-stop  $j$ . We would now need to subtract the expected dwell time at bus-stop  $j$  and the expected semi-segment travel times at the start and end segment of the multi-step prediction. The semi-segment lengths will depend on the position of the bus-stop  $i$  and  $j$  in their respective segments.

#### B. Capturing Spatio-Temporal and Seasonal Correlations

**Motivation:** One of the factors influencing the section travel time  $Z_n$  at section  $n$ , could be its preceding section travel times. This can be motivated as follows. The preceding section travel times can give strong indicators of congestion propagation moving downstream along the route OR impending congestions (with above average travel times) at the subsequent sections across which we need to predict. It can also help us capture patterns present in the historical data between section travel times.

Further, in addition to the section travel times of the previously traversed sections of the currently plying bus, travel times experienced by previous buses (most recent) across the subsequent sections would be indicative of the most recent (real-time) traffic condition on the subsequent sections. This information can help better estimate the potential travel times to be experienced by the current bus in the subsequent sections ahead. We indicate the associated section travel times by  $Z_n^{pv}$  and the section entry times by  $T_n^{e:pv}$ . The section entry time  $T_n^{e:pv}$  essentially tell us when the respective section travel times  $Z_n^{pv}$  transpired. This is important because if  $T_n^{e:pv}$  is significantly before the current time (OR time of query), the associated  $Z_n^{pv}$  may not be correlated to  $Z_n$ , the entity of interest.

In addition to the above real-time information, given strong weekly patterns in similar traffic data [32] in general, we propose to exploit information from a historical trip from the previous week whose start time is closest to that of the current trip. We indicate associated section travel times by  $Z_n^{pw}$  and section entry times by  $T_n^{e:pw}$ . This information would capture the weekly seasonal correlations in the data and would potentially enhance the predictive quality of the model.

#### C. Prediction Problem

B ATP, the dynamic real-time prediction problem can be formally stated as follows in view of the just described inputs potentially influencing prediction. Given (a) current bus's position in real-time (say at the end of section  $m$ ) (b) current time (equivalent to  $T_{m+1}^{e:cu}$ , the current bus's entry time into section  $m + 1$ ) (c) previous section travel times of the current bus (d) section travel times (ahead of section  $m$ ) of the closest previous bus and (e) section travel times (beyond section  $m$ )

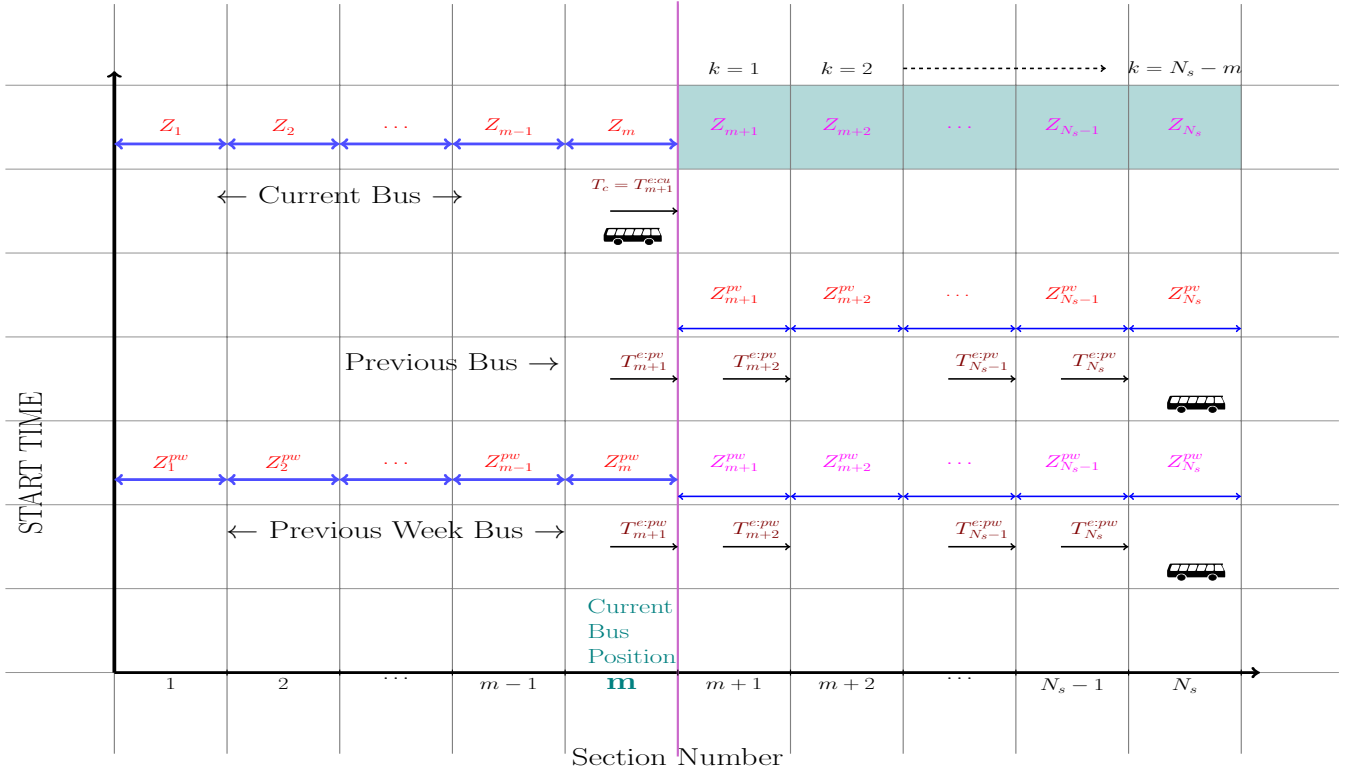

Fig. 1. Spatio-temporal and Seasonal Correlations pictorially. Current Bus Inputs (Spatial correlations), Previous Bus Inputs (Temporal Correlations), Previous Week Bus Inputs (Weekly Seasonal Correlations).

from a historical trip of the previous week (but same weekday) with the nearest trip start time to that of the current trip, one needs to estimate subsequent section travel times beyond section  $m$  of the current bus.

TABLE I  
LIST OF SYMBOLS

Symbol	Descriptions
$N_s$	total number of sections in a route
$m$	Current Bus Position
$T_c$	Current Time OR time of prediction query.
$Z_n$	travel time across section $n$ of current bus.
$Z_n^{pv}$	travel time across section $n$ of closest previous bus.
$Z_n^{pw}$	travel time across section $n$ of the closest bus from previous week, same weekday.
$T_n^{e:cu}$	entry time into section $n$ of current bus.
$T_n^{e:pv}$	entry time into section $n$ of closest previous bus.
$T_n^{e:pw}$	entry time into section $n$ of (closest) previous week bus, same weekday.
$K$	Number of steps in the Decoder (Fig. 2, Fig. 3), also equal to $(N_s - m)$ .
$F$	Predictive (Regression) Function learnt by the ED architecture.

Fig. 1 gives a clear pictorial spatial layout of all the relevant input entities that influence prediction and the associated target variables of interest.  $m$  denotes the section index of the current bus position (top bus in Fig. 1), while  $N_s$  denotes the total number of sections.  $Z_1, Z_2, \dots, Z_m$  denote the traversed section travel times of the current bus.  $Z_{m+1}, Z_{m+2}, \dots, Z_{N_s}$  are the target variables (marked with a

shade). They denote the section travel times of current bus across the subsequent sections, which need to be predicted. Similarly,  $Z_{m+1}^{pv}, Z_{m+2}^{pv}, \dots, Z_{N_s}^{pv}$ , denote section travel times across subsequent sections of the closest previous bus (middle bus in Fig. 1), while  $T_{m+1}^{e:pv}, T_{m+2}^{e:pv}, \dots, T_{N_s-1}^{e:pv}, T_{N_s}^{e:pv}$  denotes the associated section entry times. The bottom bus in Fig. 1 denotes the closest trip from the previous week, same weekday and its associated section travel and entry times along the entire route are clearly indicated. The main symbols employed in this paper have been summarized in Table I.

Given current position  $m$  and current time  $T_c$ , which is also the entry time of the bus into section  $m+1$  (i.e.  $T_{m+1}^{e:cu}$ ), we wish to learn an input-output function  $F(\cdot)$  of the below form.

$$\begin{aligned}
 & \left( Z_{m+1}, Z_{m+2}, \dots, Z_{N_s-1}, Z_{N_s} \right) = \\
 & F \left( m, T_c, \underbrace{Z_m, Z_{m-1}, \dots, Z_2, Z_1}_{\text{Spatial Correlation}}, \right. \\
 & \quad \underbrace{Z_{m+1}^{pv}, Z_{m+2}^{pv}, \dots, Z_{N_s-1}^{pv}, Z_{N_s}^{pv}, T_{m+1}^{e:pv}, T_{m+2}^{e:pv}, \dots, T_{N_s-1}^{e:pv}, T_{N_s}^{e:pv}}_{\text{Temporal Correlations}}, \\
 & \quad \left. \underbrace{Z_{m+1}^{pw}, Z_{m+2}^{pw}, \dots, Z_{N_s-1}^{pw}, Z_{N_s}^{pw}, T_{m+1}^{e:pw}, T_{m+2}^{e:pw}, \dots, T_{N_s-1}^{e:pw}, T_{N_s}^{e:pw}}_{\text{Weekly Seasonal Correlations}}, \right. \\
 & \quad \left. \underbrace{Z_m^{pw}, Z_{m-1}^{pw}, \dots, Z_2^{pw}, Z_1^{pw}}_{\text{Weekly Seasonal Correlations}} \right) \quad (1)
 \end{aligned}$$

The inputs have been grouped into 3 categories (based on the style of underlining). The first category corresponds to the current bus information, namely its current position  $m$ , its section travel times along traversed sections (correspond to spatial correlation). The second category is the section travel and entry times from the closest previous bus across all subsequent sections (correspond to temporal correlations). The

third category includes section travel time from all sections of the closest previous week trip, while its section entry times from only the subsequent sections (correspond to weekly seasonal correlations). Note we don't use the previous section travel times from the previous trip as the current trip travel times across the previous sections are more recent.

#### D. Motivating the ED Architecture

The ED architecture was originally employed for variable length pairs of input-output sequences. The input could correspond to a sentence from a particular language, while the output could be its translation in another language. Each word essentially comes from a categorical space and one needs sophisticated word2vec [33], [34] representations before feeding the transcribed words into the RNN. In our setting the raw data is already a real number and hence can be fed directly into the RNNs.

Our prediction problem (BATP) can be viewed as a spatial multi-step prediction problem, where at  $i^{\text{th}}$  step we can either predict (i) the travel time across the  $(m+i)^{\text{th}}$  segment OR (ii) travel time to reach end of  $(m+i)^{\text{th}}$  segment. We stick to the former in this paper. Given the variable length Seq2Seq mapping ability, the ED framework naturally can be utilized for our spatial multi-step (target) prediction where we train with vector valued targets, with vector size equal to the number of sections ahead ( $N_s - m$ ). We rewrite eqn. (1) by reorganizing its inputs as follows which aids us in clearly associating the inputs and outputs of the regression function  $F(\cdot)$  to the proposed ED architecture.

$$F\left(m, T_c, \underbrace{(Z_m, Z_m^{pw}), (Z_{m-1}, Z_{m-1}^{pw}) \dots, (Z_2, Z_2^{pw}), (Z_1, Z_1^{pw})}_{(Z_{m+1}^{pv}, Z_{m+1}^{pw}, T_{m+1}^{e:pv}, T_{m+1}^{e:pw}), (Z_{m+2}^{pv}, Z_{m+2}^{pw}, T_{m+2}^{e:pv}, T_{m+2}^{e:pw}) \dots, (Z_{N_s-1}^{pv}, Z_{N_s-1}^{pw}, T_{N_s-1}^{e:pv}, T_{N_s-1}^{e:pw}), (Z_{N_s}^{pv}, Z_{N_s}^{pw}, T_{N_s}^{e:pv}, T_{N_s}^{e:pw})}\right) = \quad (2)$$

All the previous section travel times from the current bus and the previous week trip have been grouped. These two pairs of inputs are fed as encoder inputs unfolded up to  $m$  steps (Fig. 2). In the second group, we bring together section travel times and entry times of the previous bus and an appropriate previous week trip. These inputs in pairs of four are fed as additional inputs at each step of the decoder, where the decoder is unfolded into  $N_s - m$  steps. The intuition is that not just the subsequent section travel time, but also the time at which the traversal happened (entry time into that section) has an influence. Closer the entry time of the previous bus to the current bus's likely entry time, higher is its influence. In this architecture, the current bus's likely entry time into section  $m+i$  would be inherently represented in the hidden state  $h_i$ .

**Remark 1:** The GPS/AVL based travel-time data is naturally discrete in the spatial dimension, because we have travel-time information available either across sections OR between two consecutive bus-stops as described earlier. On the other hand this data is naturally continuous in temporal dimension

as trips can happen anytime during the day. So it makes more sense to map the (discrete) spatial aspect of the problem to the discrete sequential aspect of the Seq2Seq (or ED) framework. Further, real-time BATP needs to predict travel times across all subsequent sections (from the current section). This spatial and sequential multi-step target aspect of BATP can be exactly mapped to the multi-step sequential decoder outputs. The temporal correlations coming from the previous bus are fed as decoder inputs in a space synchronized fashion, while the weekly seasonal historical inputs are clearly split between the encoder and decoder inputs without any redundancy. Our ED framework hence also avoids discretizing time as in [13], [14], [30].

1) **Gating Unit in the architecture:** Amongst the three standard recurrent structure choices of plain RNN (without gating), LSTM [35] and GRU [36], we choose GRU in this paper. Like LSTM unit, GRU also has a gating mechanism to mitigate vanishing gradients and have more persistent memory. But the lesser gate count in GRU keeps the number of weight parameters much smaller. GRU unit as the building block for RNNs is currently ubiquitous across sequence prediction applications [37], [38], [39], [40]. A single hidden layer plain RNN unit's hidden state can be specified as

$$h_i = \sigma(W^h h_{i-1} + W^u u_i) \quad (3)$$

where  $W^h$ ,  $W^u$  are the weight matrices associated with the state at the previous step  $h_{i-1}$  and the current input ( $u_i$ ) respectively,  $\sigma(\cdot)$  denotes sigma function. GRU based cell computes its hidden state (for one layer as follows).

$$z_i = \sigma(W^z u_i + U^z h_{i-1}) \quad (4)$$

$$r_i = \sigma(W^r u_i + U^r h_{i-1}) \quad (5)$$

$$\tilde{h}_i = \tanh(r_i \circ U h_{i-1} + W u_i) \quad (6)$$

$$h_i = z_i \circ h_{i-1} + (1 - z_i) \circ \tilde{h}_i \quad (7)$$

where  $z_i$  is update gate vector and  $r_i$  is the reset gate vector. If the two gates were absent, we essentially have the plain RNN.  $\tilde{h}_i$  is the new memory (summary of all inputs so far) which is a function of  $u_i$  and  $h_{i-1}$ , the previous hidden state. The reset signal controls the influence of the previous state on the new memory. The final current hidden state is a convex combination (controlled by  $z_i$ ) of the new memory and the memory at the previous step,  $h_{i-1}$ . All associated weights  $W^z$ ,  $W^r$ ,  $W$ ,  $U^z$ ,  $U^r$ ,  $U$  are trained using back-propagation through time (BPTT).

2) **Bidirectional Layer at the Decoder:** We further propose to use a bidirectional layer at the decoder. The motivation for this comes primarily from this application. To predict  $Z_{m+k}$ , the unidirectional architecture as in fig. 2 considers the previous bus's travel times up to section  $m+k$  only. However, the previous bus's travel times in subsequent sections beyond  $m+k$  can provide indicators of recent congestions further down in the route. *These recent congestions can in turn potentially propagate backward in space and strongly influence the travel time of the current bus at section  $(m+k)$ .* To capture such eventualities, we use a bidirectional layer as given in fig. 3.

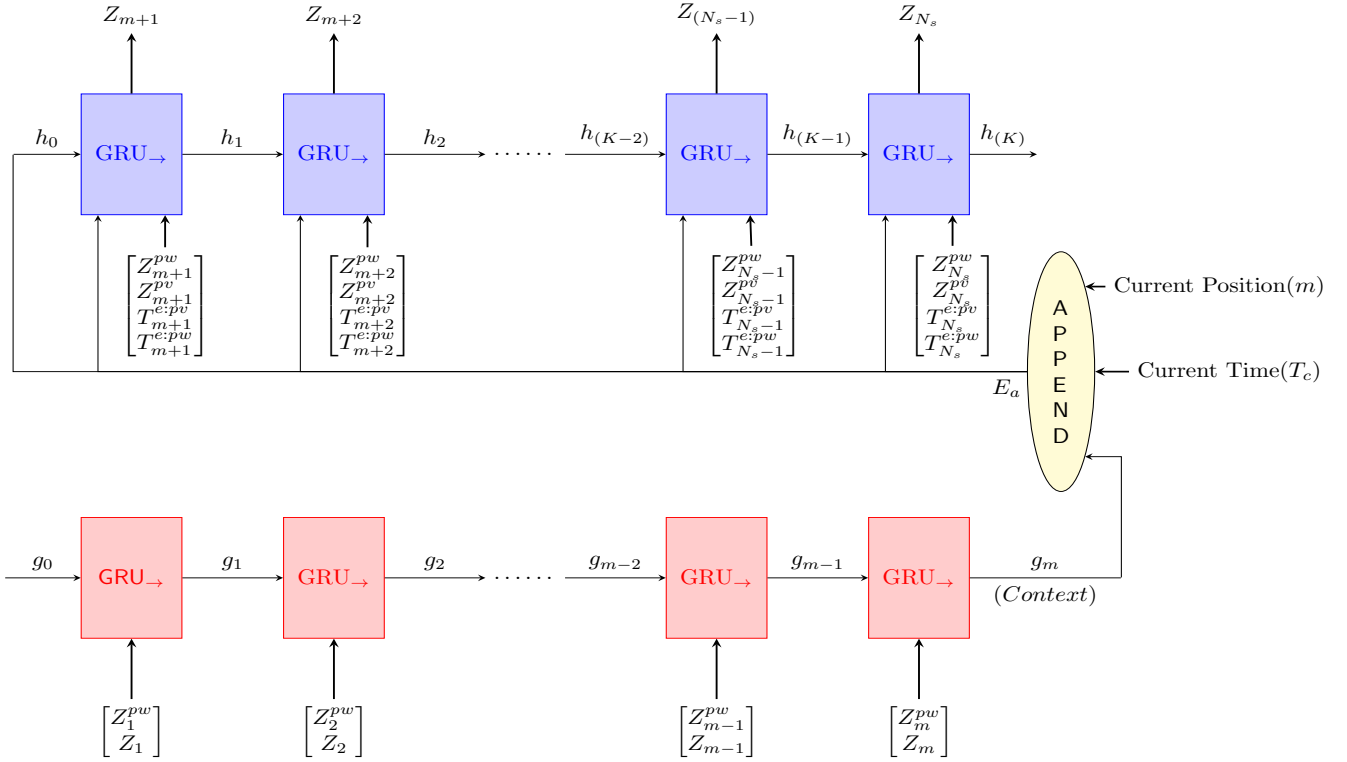

Fig. 2. Proposed ED Architecture with a Unidirectional Decoder.  $K = (N_s - m)$

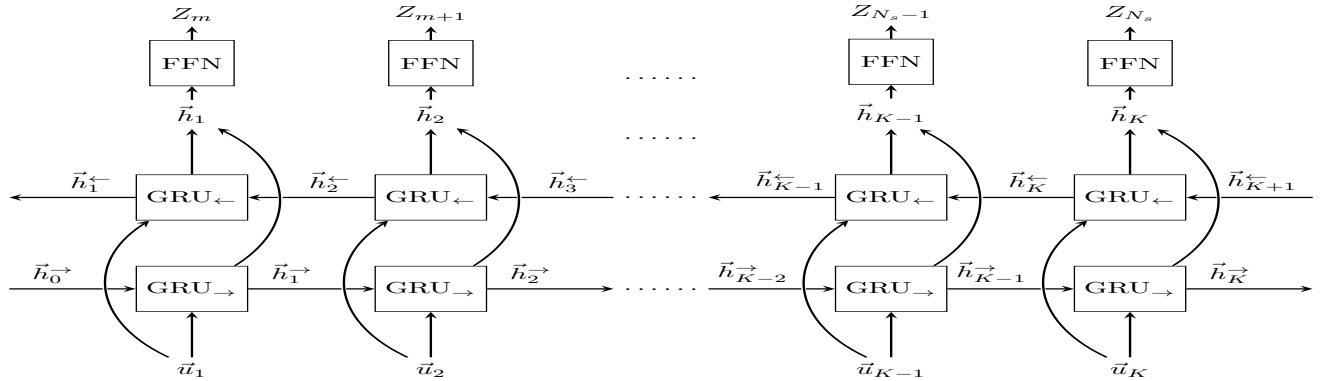

Fig. 3. Bidirectional Decoder. Please note  $K = (N_s - m)$ .  $\vec{h}_{K+1}^{\leftarrow} = \vec{h}_0^{\rightarrow} = E_a$ , output of the append block in Fig. 2.

In the GRU-cell defining equations (eqn. (4)-(7)), the state-update essentially follows the below equation

$$\vec{h}_i^{\rightarrow} = f_1(\vec{h}_{i-1}^{\rightarrow}, u_i) \quad (8)$$

where for each time-step the state information flows from left to right. In a bi-directional setting, we have an additional state-vector  $\vec{h}_i^{\leftarrow}$  and map  $f_2$ , with an update with reverse information flow from right to left as follows.

$$\vec{h}_i^{\leftarrow} = f_2(\vec{h}_{i+1}^{\leftarrow}, u_i) \quad (9)$$

So the state at step  $i$ ,  $h_i$ , is a concatenation  $[\vec{h}_i^{\rightarrow}, \vec{h}_i^{\leftarrow}]$ . Note that  $f_2$  like  $f_1$  is governed by the same GRU-cell defining equations (eqn. (4)-(7)) with possibly different weight values. Each input  $\vec{u}_i$  in Fig. 3 is actually the concatenation of all

inputs at the  $i^{\text{th}}$  (each) step of the decoder in Fig. 2. In particular,

$$\vec{u}_i = [Z_{m+i}^{pw} \ Z_{m+i}^{pv} \ T_{m+i}^{e:pv} \ T_{m+i}^{e:pw} \ E_a] \quad (10)$$

where  $E_a$  is output of the append block in Fig. 2. Also note initial states ( $\vec{h}_{K+1}^{\leftarrow}$ ) and ( $\vec{h}_0^{\rightarrow}$ ) are equal and initialized to  $E_a$ .

#### IV. RESULTS

**Data:** We tested and benchmarked our method on one bus route (Route 399) from Delhi, India in detail. The route was uniformly segmented into sections of length 800m resulting in a total of 34 segments. The section width was chosen keeping in mind (a)the actual number of bus-stops and (b)the number of resulting sections ( $N_s$ ). Having too many sections can be challenging on the model for long sub-route prediction,

while long section length would mean poor predictions on short sub-route predictions. For training purposes, over each week, data from Mon to Sat was considered. This is because in Indian conditions, for a large segment of people, Saturday is also a working day. Further, a previous study [32] under similar conditions provides evidence of Sunday traffic being very different from rest of the days. The data we tested on comes from GPS measurements collected across all trips over 2 historical months namely September and October 2019. The raw GPS measurements had to be filtered off the GPS noise before computing the travel times across each of the 800 m segments that constitute a route. Since the route information is known, filtering was performed based on simple route projection. The learnt models were tested based on the last week's data (test period) while the remaining 7 weeks data was used for training. The prediction accuracy was evaluated based on Mean Absolute Error (MAE) and Mean Absolute Percentage Error (MAPE) metric. *Percentage error is Absolute Error divided by true prediction expressed in percentage.* While MAE provides a commuter understandable clock time difference in seconds, MAPE is a scale independent metric.

#### A. Bench-marking Details

**Proposed Approaches:** We denote our proposed ED approaches as EDU (unidirectional decoder) and EDB (bidirectional decoder). The bidirectional model version can lead to many more parameters in the decoder (in comparison to the unidirectional version) for a similar number of hidden nodes in the GRU cell. For consistency in the number of learnable parameters, the number of hidden nodes in the GRU-cell of the bidirectional decoder is kept lower so that the overall number of parameters in the bidirectional decoder matches that of the unidirectional decoder.

**Baselines:** In this paper, we benchmark the proposed methods (with or without bidirectional layer at the decoder) against 4 recent state-of-art baselines all of which capturing spatio-temporal correlations in a distinct way:

- (a)LNKF [4], which learns spatio-temporal correlations (post a log transformation) using linear statistical models first followed by a linear kalman filter prediction approach
- (b)SVKF [11], which learns spatio-temporal correlations using nonlinear support-vector approximations followed by an extended kalman filter prediction approach.
- (c)DpAR[41] many-to-many architecture inspired from [41] (an RNN approach for sequential (time-series) prediction in the presence of exogenous inputs). At each time step, the previous section travel time of current bus (prior sequential input from a DeepAR perspective) and current section travel time of previous bus (akin to the exogenous input in DeepAR) are fed as inputs to predict the current section travel time of the current bus. Overall the baseline (indicated as DpAR henceforth) captures spatio-temporal correlations in a unique way.
- (d)CLSTM [13] a current interesting spatio-temporal approach utilizing Seq2Seq to capture temporal correlations and Convolutional layer to capture spatial correlations.

BPTT was used to train all the deep learning algorithms namely DpAR, CLSTM, EDU and EDB. All these methods use adam optimizer with batch size=32. To tackle over-fitting, early stopping was used for DpAR, EDU and EDB, while the default batch normalization (as prescribed in [13]) was used for CLSTM. For LNKF training (model building), we used a least squares regression on the log transformed inputs. For SVKF training, support vector regression with a Gaussian kernel was used, while a grid search was employed to narrow down on the hyper-parameters,  $\epsilon$  and  $C$ .

**Justification of baselines:** Please note LNKF and SVKF are recent learning-based spatio-temporal approaches which also capture the spatial sequential aspect of BAP in their predictive models like our approach, but by performing a Kalman-filter based spatial multi-step prediction. SVKF in particular is a recent interesting nonlinear approach using support vector approximations for model building. CLSTM and DpAR are two recent DL approaches which make them a natural choice for baselining. Owing to the following reasons, we do not benchmark our method against some of the other recent approach's like [2],[15],[8] discussed in related work. BusTr [2] considers run-time and dwell time separately, while takes very different inputs like speed forecasts, location embeddings etc. which are very hard to procure and compute for the data and route on which we benchmarked. The performance of the TD approach of [15] on the other hand was very poor on short and mid-length sub-routes. CLSTM is a nonlinear model which captures temporal correlations on lines similar to [8] by segmenting the time axis. While [8] captures linear temporal correlations only, CLSTM additionally captures spatial correlations also via a convolutional layer making it a stronger baseline compared to [8]. Overall our choice of baseline methods is current and enables a diverse comparison.

**Assessing significance of Error differences statistically:** We have conducted a Z-test based significance assessment (across all relevant experiments) under MAPE/MAE differences (EDB vs EDU/Baseline) with a significance level of 0.1 for null hypothesis rejection. In all experiments, the mean error metric is calculated by averaging more than 30 samples and hence a Z-test is sufficient. Overall we observe that improvements of EDB (over EDU/baselines) are mostly significant, while instances where a baseline performs better than both EDB and EDU are very few.

**Model Building Details:** Recall that Fig. 2 takes current position ( $m$ ) also as input and builds a unified model. One issue with the unified model is that the section number has to be one-hot encoded with a large number of binary inputs (equal to the number of sections). Also, empirically building separate models for each  $m$  performs better. A possible intuitive explanation could be that the unified model has to generalize across all  $m$  while also handling a huge variation in encoder/decoder unfolded lengths for different  $m$ . Hence, we build separate models for each  $m$  based on Fig. 2.

For the purposes of this paper and ease of demonstration, we have built models uniformly spaced across the route, starting from section  $m = 5$  till section  $m = 30$  in steps of 5. For each of these bus positions, the travel time data is suitably grouped into input-output pairs in line with the input-output structure



of Fig. 2 before training.

### B. Two-step (section) ahead Prediction (Short Routes)

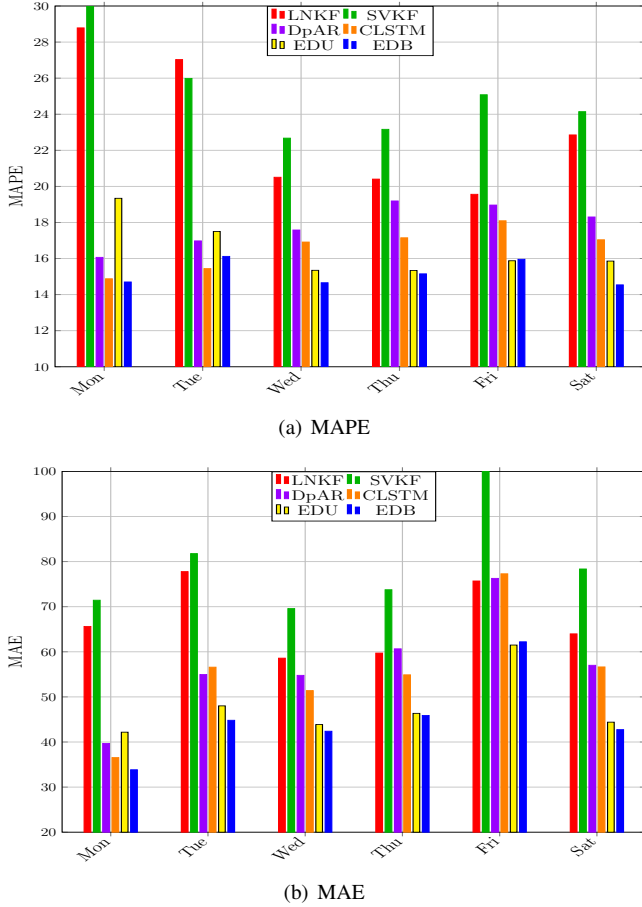

Fig. 4. Two-Step Ahead MAPE and MAE Comparison at a Day level

**Day Level Comparison:** We compare two-step ahead predictions (for short routes) of EDU and EDB with all existing methods at a day level. Fig. 4 illustrates that the proposed methods EDU and EDB consistently outperform existing methods at a 2-step level. Overall EDB (with our novel bidirectional layer at the decoder) seems to perform the best. Fig. 4(a) and Fig. 4(b) provide the comparisons in terms of MAPE and MAE respectively. In particular, EDB performs the best with an advantage up to 14.08%, 16.41%, 4.04%, 2.5% and 4.64% over LNKF, SVKF, DpAR, CLSTM and EDU approaches respectively. Similarly in terms of MAE, EDB performs the best with an advantage up to 32.96s, 55.36s, 14.76s, 15.08s and 8.33s over LNKF, SVKF, DpAR, CLSTM and EDU approaches respectively. Overall, we observe reasonable improvements from our method based on both metrics.

### C. Multi-Step Prediction

We now test our learnt models on longer sub-routes. This is important as real-time prediction needs to be carried out between any two bus-stops (or sections) of the bus route. We evaluate performance based on both metrics. Each sub-figure in Fig. 5 shows comparison of MAPE values for an  $(i, j)$  pair,

where  $i$  is the current bus position and  $j$  is the destination section. This means for a given  $i \in \{5, 10, 15, 20, 25, 30\}$ ,  $j$  is varied in steps of 5 from  $i + 5$ . The only exception here is for the maximum  $j$  which is 34 (as the route ends there). Fig. 5(a) provides MAPE results for  $i = 5, 30$ . Fig. 5(b) provides results for  $i = 10, 25$ , while Fig. 5(c) provides results for  $i = 15, 20$ . MAE/MAPE is calculated by averaging across all trips and days in the test set by keeping the start section and end section fixed. We note that the proposed EDB mostly performs better than LNKF, SVKF, DpAR, CLSTM and EDU, while EDU performs better than LNKF, SVKF and DpAR with comparable performance against CLSTM. This inference is based on both MAPE and MAE metrics (Fig. 5 and Fig. 6). EDB in particular, as in the 2-step case performs the best. Specifically, for a 5-step ahead prediction, EDB achieves MAPE improvement by up to 14.32%, 14.74%, 8.94%, 3.78% and 1.58% over LNKF, SVKF, DpAR, CLSTM and EDU respectively. For a 10-step ahead prediction, EDB reduces MAPE by up to 11.18%, 10.99%, 9.82%, 2.97% and 1.34% in comparison to LNKF, SVKF, DpAR, CLSTM and EDU respectively. For a 15-step ahead prediction, EDB reduces MAPE by up to 8.87%, 8.81%, 4.82%, 1.76% and 1.33% in comparison over LNKF, SVKF, DpAR, CLSTM and EDU respectively.

On similar lines, Fig. 6(a) provides MAE results for  $i = 5, 30$ . Fig. 6(b) provides results for  $i = 10, 25$ , while Fig. 6(c) provides results for  $i = 15, 20$ . Please observe in these figures how the MAE generally increases with the length of the sub-route (i.e.  $(j - i)$ ) inline with the intuition that error increases with prediction horizon. As before, EDB performance is the best. Specifically, for a 5-step ahead prediction, EDB achieves MAE improvement by up to 102.82s, 118.97s, 45.96s, 43.81s and 6.19s over LNKF, SVKF, DpAR, CLSTM and EDU respectively. For a 10-step ahead prediction, EDB reduces MAE by up to 134.51s, 145.16s, 111.75s, 41.88s and 12.98s in comparison over LNKF, SVKF, DpAR, CLSTM and EDU respectively. For a 15-step ahead prediction, EDB reduces MAE by up to 158.8s, 169.2s, 80.15s, 46.59s and 16.33s in comparison over LNKF, SVKF, DpAR, CLSTM and EDU respectively.

**Remark 2:** In the plots whenever some of the baselines have high errors, we have avoided showing the associated bar heights completely as this adversely affects the visual comparison of the bars in the error range of our proposed approaches EDB and EDU. As a result we see some clipped bars with actual error values higher than the max  $y$ -axis range.

## V. DISCUSSION & CONCLUSION

In this paper we proposed a Encoder Decoder (Seq2Seq) RNN based approach for Bus arrival time prediction (BATP). As shown, the geometry of ED prediction framework had a natural fit with BATP to simultaneously predict travel times across subsequent sections of the currently plying bus. The real-time spatio-temporal correlations and weekly seasonal influences were intelligently incorporated into the proposed predictive model via non-redundant inputs at both the encoder and decoder. Further we also proposed the use of a

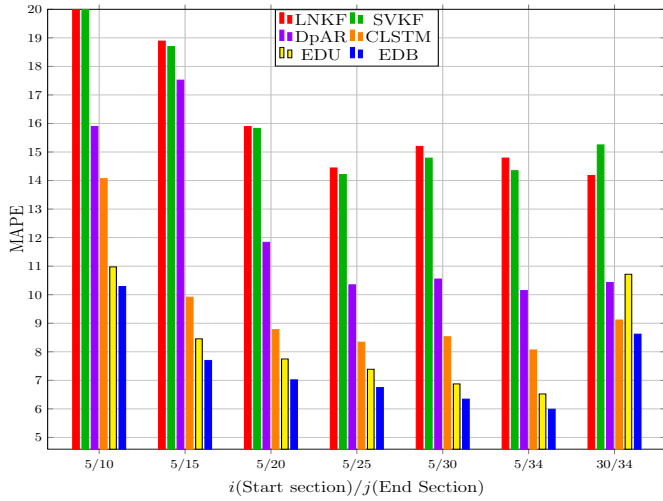

(a) Bus current position at section 5 and section 30.

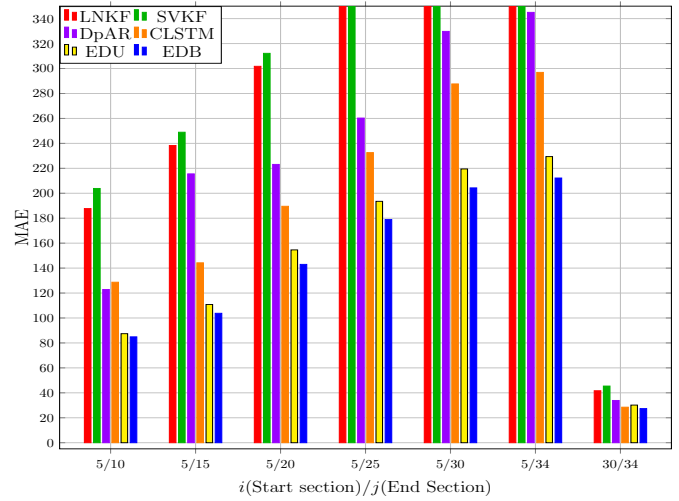

(a) Bus current position at section 5 and section 30.

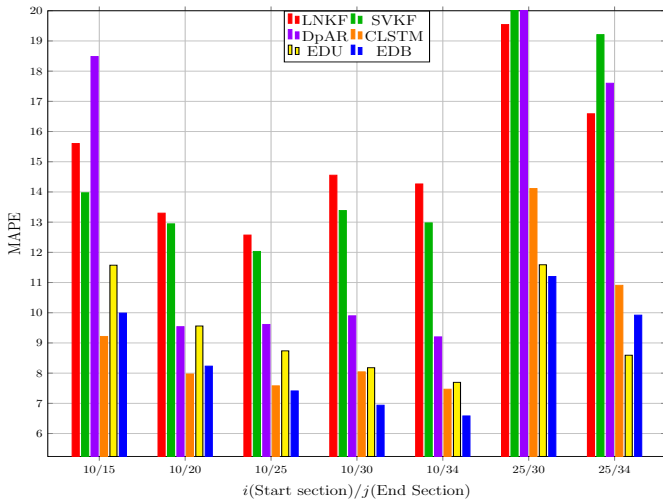

(b) Bus current position at section 10 and section 25.

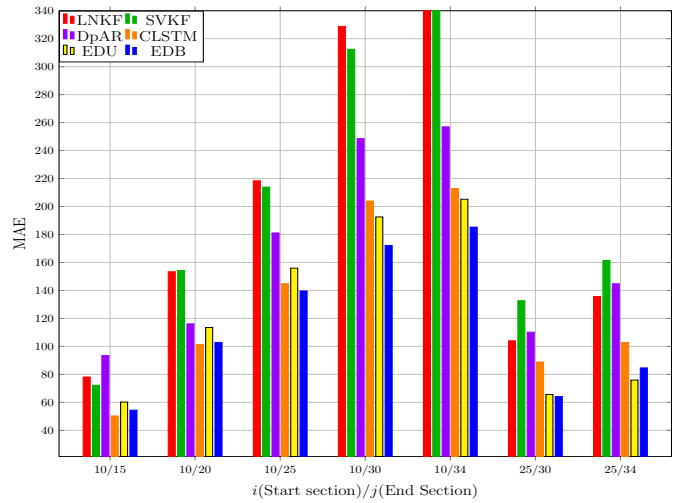

(b) Bus current position at section 10 and section 25.

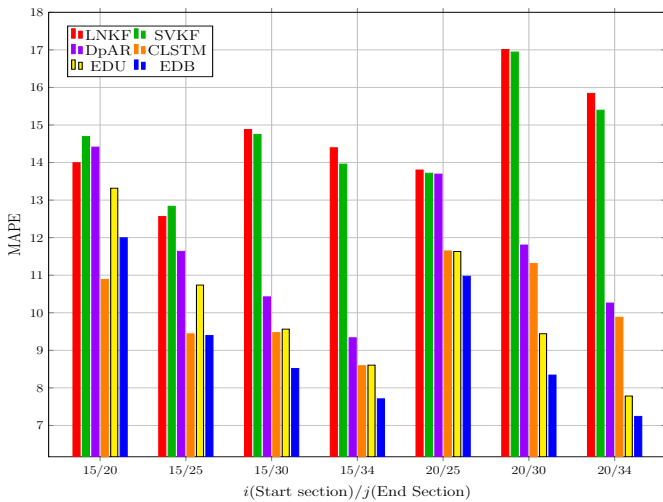

(c) Bus current position at section 15 and section 20.

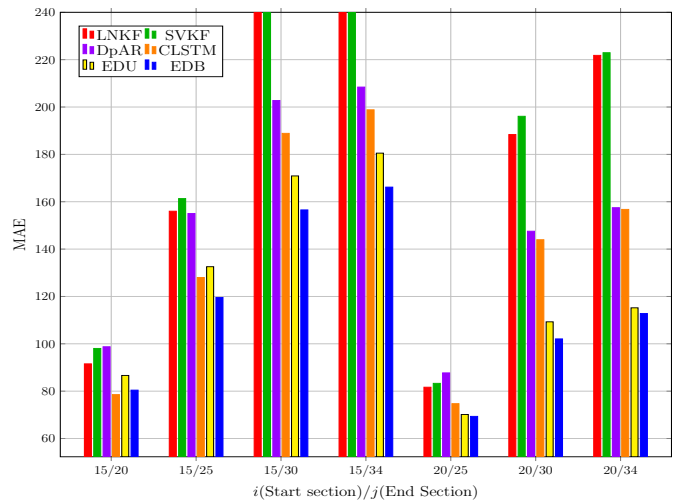

(c) Bus current position at section 15 and section 20.

Fig. 5. Multi-Step Ahead MAPE at various start/current bus positions (again chosen in steps of 5) along the route.

Fig. 6. Multi-Step Ahead MAE at various start/current bus positions (again chosen in steps of 5) along the route.

bidirectional layer at the decoder to potentially capture the upstream propagation of past downstream congestions for superior predictions. This feature of the bidirectional layer at the decoder seems unique and unexplored in other time-series applications of the ED framework. We demonstrated via detailed experiments the utility of our approach on a bus route from challenging mixed traffic conditions. Results indicate that our approach performs better than many state-of-art approaches for the same problem.

The proposed ED framework with a bidirectional decoder can potentially have applications in sales prediction for retail for instance. If promo information/prices is fed as inputs as decoder inputs, then future promos can potentially influence past sales. This anti-causal influence can rightly be captured by our modified ED framework. In that sense, our proposed framework is general and can be employed in other time-series applications as well. As future work, we would explore the utility of the proposed architecture in other domains like demand prediction for retail and so on. Another potential future work could be to exploit additional inputs for BAP like speed, flow etc. and a suitably refined ED architecture to meaningfully incorporate these inputs.

#### ACKNOWLEDGEMENT

The authors acknowledge Prof. Pravesh Biyani and his team from IIIT Delhi [42] for generously sharing historical bus AVL data, which made our benchmarking possible. The authors also acknowledge Rohith Regikumar, researcher from TCS Research for his support during benchmarking.

#### REFERENCES

- [1] A. Darrow-Pinion, J. She, D. Wong, O. Lange, T. Hester, L. Perez, M. Nunkesser, S. Lee, X. Guo, B. Wiltshire, P. W. Battaglia, V. Gupta, A. Li, Z. Xu, A. Sanchez-Gonzalez, Y. Li, and P. Velickovic, "ETA prediction with graph neural networks in google maps," in *CIKM*. ACM, 2021, pp. 3767–3776.
- [2] R. Barnes, S. Buthpitiya, J. Cook, A. Fabrikant, A. Tomkins, and F. Xu, "Bustr: Predicting bus travel times from real-time traffic," in *KDD '20: Proceedings of the 26th ACM SIGKDD International Conference on Knowledge Discovery Data Mining*. ACM, 2020, pp. 3243–3251.
- [3] P. Ranjitkar, L. S. Tey, E. Chakravorty, and K. L. Hurley, "Bus arrival time modeling based on auckland data," *Transportation Research Record*, vol. 2673, no. 6, pp. 1–9, 2019.
- [4] A. Achar, D. Bharathi, B. A. Kumar, and L. Vanajakshi, "Bus arrival time prediction: A spatial kalman filter approach," *IEEE Transactions on Intelligent Transportation Systems*, vol. 21, no. 3, pp. 1298–1307, 2020.
- [5] C. Paliwal and P. Biyani, "To each route its own eta: A generative modeling framework for eta prediction," in *2019 IEEE Intelligent Transportation Systems Conference (ITSC)*, Oct 2019, pp. 3076–3081.
- [6] L. Vanajakshi, S. C. Subramanian, and R. Sivanandan, "Travel time prediction under heterogeneous traffic conditions using global positioning system data from buses," *IET Intelligent Transportation Systems*, vol. 3(1), pp. 1–9, 2009.
- [7] R. Jairam, B. A. Kumar, S. S. Arkatkar, and L. Vanajakshi, "Performance comparison of bus travel time prediction models across indian cities," *Transportation Research Record*, vol. 2672, no. 31, pp. 87–98, 2018.
- [8] B. D. Bharathi, B. A. Kumar, A. Achar, and L. Vanajakshi, "Bus travel time prediction: a log-normal auto-regressive (ar) modelling approach," *Transportmetrica A: Transport Science*, vol. 16, no. 3, pp. 807–839, 2020.
- [9] Y. Bin, Y. Zhinzen, and Y. Baozhen, "Bus arrival time prediction using support vector machines," *Journal of Intelligent Transportation Systems*, vol. 10(4), pp. 151–158, 2007.
- [10] K. K. Reddy, B. A. Kumar, and L. Vanajakshi, "Bus travel time prediction under high variability conditions," *Current Science*, vol. 111, no. 4, pp. 700–711, 2016.
- [11] A. Achar, R. Regikumar, and B. A. Kumar, "Dynamic bus arrival time prediction exploiting non-linear correlations," in *2019 International Joint Conference on Neural Networks (IJCNN)*, July 2019, pp. 1–8.
- [12] W. Fan and Z. Gurmu, "Dynamic travel time prediction models for buses using only gps data," *International Journal of Transportation Science and Technology*, vol. 4, no. 4, pp. 353 – 366, 2015.
- [13] N. C. Petersen, F. Rodrigues, and F. C. Pereira, "Multi-output bus travel time prediction with convolutional lstm neural network," *Expert Syst. Appl.*, vol. 120, pp. 426–435, 2019.
- [14] X. Ran, Z. Shan, Y. Fang, and C. Lin, "An lstm-based method with attention mechanism for travel time prediction," *Sensors*, vol. 19, no. 4, 2019. [Online]. Available: <https://www.mdpi.com/1424-8220/19/4/861>
- [15] L. K. P. Vignesh, A. Achar, and G. Karthik, "Dynamic bus arrival time prediction: A temporal difference learning approach," in *2020 International Joint Conference on Neural Networks (IJCNN)*, 2020, pp. 1–8.
- [16] B. A. Kumar, S. Mothukuri, L. Vanajakshi, and S. C. Subramanian, "Analytical approach to identify the optimum inputs for a bus travel time prediction method," *Transportation Research Record: Journal of the Transportation Research Board*, vol. 2535, pp. 25–34, 2015.
- [17] B. A. Kumar, L. Vanajakshi, and S. C. Subramanian, "Bus travel time prediction using a time-space discretization approach," *Transportation Research Part C: Emerging Technologies*, vol. 79, pp. 308–332, 2017.
- [18] B. A. Kumar, V. Kumar, L. Vanajakshi, and S. Subramanian, "Performance comparison of data driven and less data demanding techniques for bus travel time prediction," *European Transport*, vol. 65(9), 2017.
- [19] Y. Duan, Y. L.V., and F. Wang, "Travel time prediction with lstm neural network," in *2016 IEEE 19th International Conference on Intelligent Transportation Systems (ITSC)*, Nov 2016, pp. 1053–1058.
- [20] M. Yang, C. C. ., L. Wangz., X. Yanx., and L. Zhou, "Bus arrival time prediction using support vector machine with genetic algorithm," *Neural Network World*, vol. 3, pp. 205–217, 2016.
- [21] R. Wen, K. Torkkola, B. Narayanaswamy, and D. Madeka, "A multi-horizon quantile recurrent forecaster," in *The 31st Conference on Neural Information Processing Systems (NIPS 2017), Time Series Workshop*, 2017.
- [22] Y. G. Cinar, H. Mirisae, P. Goswami, É. Gaussier, A. Ait-Bachir, and V. V. Strijov, "Position-based content attention for time series forecasting with sequence-to-sequence rnns," in *Neural Information Processing - 24th International Conference, ICONIP 2017, Guangzhou, China, November 14-18, 2017, Proceedings, Part V*, ser. Lecture Notes in Computer Science, vol. 10638. Springer, 2017, pp. 533–544. [Online]. Available: [https://doi.org/10.1007/978-3-319-70139-4\\_54](https://doi.org/10.1007/978-3-319-70139-4_54)
- [23] K. Cho, B. van Merriënboer, C. Gulcehre, D. Bahdanau, F. Bougares, H. Schwenk, and Y. Bengio, "Learning phrase representations using RNN encoder–decoder for statistical machine translation," in *Proceedings of the 2014 Conference on Empirical Methods in Natural Language Processing (EMNLP)*, Oct. 2014, pp. 1724–1734.
- [24] I. Sutskever, O. Vinyals, and Q. V. Le, "Sequence to sequence learning with neural networks," in *Proceedings of the 27th International Conference on Neural Information Processing Systems - Volume 2*, 2014, p. 3104–3112.
- [25] W. H. Lin and J. Zeng, "Experimental study on real-time bus arrival time prediction with GPS data," *Transportation Research Record: Journal of the Transportation Research Board*, vol. 1666, pp. 101–109, 1999.
- [26] P. Zhou, Y. Zheng, and M. Li, "How long to wait?: Predicting bus arrival time with mobile phone based participatory sensing," in *Proceedings of the 10th International Conference on Mobile Systems, Applications, and Services*. New York, NY, USA: ACM, 2012, pp. 379–392.
- [27] A. Shalaby and A. Farhan, "Bus travel time prediction for dynamic operations control and passenger information systems," in *82nd Annual Meeting of the Transportation Research Board*. Washington D.C., USA: National Research Council, 2003.
- [28] S. V. Kumar and L. Vanajakshi, "Pattern identification based bus arrival time prediction," *Proceedings of the Institution of Civil Engineers-Transport*, vol. 167(3), pp. 194–203, 2012.
- [29] D. Sun, H. Luo, L. Fu, W. Liu, X. Liao, and M. Zhao, "Predicting bus arrival time on the basis of global positioning system data," *Transportation Research Record: Journal of the Transportation Research Board*, vol. 2034, pp. 62–72, 2007.
- [30] J. Wu, Q. Wu, J. Shen, and C. Cai, "Towards attention-based convolutional long short-term memory for travel time prediction of bus journeys," *Sensors*, vol. 20, no. 12, 2020. [Online]. Available: <https://www.mdpi.com/1424-8220/20/12/3354>

- [31] L. Lu, X. Zhang, K. Cho, and S. Renals, "A study of the recurrent neural network encoder-decoder for large vocabulary speech recognition," in *Proceedings of the 16th Annual Conference of the International Speech Communication Association, INTERSPEECH*, Jan. 2015, pp. 3249–3253.
- [32] B. A. Kumar, L. Vanjakshi, and S. C. Subramanian, "Day-wise travel time pattern analysis under heterogeneous traffic conditions," *Procedia - Social and Behavioral Sciences*, vol. 104, pp. 746 – 754, 2013, 2nd Conference of Transportation Research Group of India (2nd CTRG).
- [33] J. Pennington, R. Socher, and C. Manning, "GloVe: Global vectors for word representation," in *Proceedings of the 2014 Conference on Empirical Methods in Natural Language Processing (EMNLP)*. Doha, Qatar: Association for Computational Linguistics, Oct. 2014, pp. 1532–1543. [Online]. Available: <https://aclanthology.org/D14-1162>
- [34] T. Mikolov, K. Chen, G. Corrado, and J. Dean, "Efficient estimation of word representations in vector space," *CoRR*, vol. abs/1301.3781, 2013.
- [35] S. Hochreiter and J. Schmidhuber, "Long short-term memory," *Neural Comput.*, vol. 9, no. 8, p. 1735–1780, Nov. 1997.
- [36] J. Chung, C. Gulcehre, K. Cho, and Y. Bengio, "Empirical evaluation of gated recurrent neural networks on sequence modeling," in *NIPS 2014 Deep Learning and Representation Learning Workshop*, 2014. [Online]. Available: <http://arxiv.org/abs/1412.3555>
- [37] A. Gupta, G. Gurrula, and P. S. Sastry, "Instability prediction in power systems using recurrent neural networks," in *Proceedings of the 26th International Joint Conference on Artificial Intelligence*. AAAI Press, 2017, p. 1795–1801.
- [38] M. Ravanelli, P. Brakel, M. Omologo, and Y. Bengio, "Light gated recurrent units for speech recognition," *IEEE Transactions on Emerging Topics in Computational Intelligence*, vol. 2, no. 2, p. 92–102, Apr 2018.
- [39] Z. Che, S. Purushotham, K. Cho, D. Sontag, and Y. Liu, "Recurrent neural networks for multivariate time series with missing values," *Scientific Reports*, vol. 8, Jun 2016.
- [40] N. Gruber and A. Jockisch, "Are gru cells more specific and lstm cells more sensitive in motive classification of text?" *Front. Artif. Intell.*, 2020.
- [41] D. Salinas, V. Flunkert, J. Gasthaus, and T. Januschowski, "Deepar: Probabilistic forecasting with autoregressive recurrent networks," *International Journal of Forecasting*, vol. 36, no. 3, pp. 1181–1191, 2020.
- [42] A. Kumar, S. Balodi, A. Jain, and P. Biyani, "Benchmark dataset for timetable optimization of bus routes in the city of new delhi," in *IEEE 23rd International Conference on Intelligent Transportation Systems (ITSC)*. IEEE, 2020, pp. 1–6.
- [43] L. Mihaylova and R. Boel, "A particle filter for freeway traffic estimation," in *43rd IEEE Conference on Decision and Control*, 2004.
- [44] U. Mori, A. Mendiburu, M. Alvarez, and J. Lozano, "A review of travel time estimation and forecasting for advanced traveller information systems," *Transportmetrica A: Transport Science*, vol. 11, no. 2, pp. 119–157, 2015.
- [45] J. Zhang, L. Yan, Y. Han, and J. Zhang, "Study on the prediction model of bus arrival time," in *International Conference on Management and Service Science*, MASS, China, 2009, pp. 1–3.
- [46] S. Xinghao, T. Jing, C. Guojun, and S. Qichong, "Predicting bus real-time travel time basing on both GPS and RFID data," *Procedia - Social and Behavioral Sciences*, vol. 96, pp. 2287–2299, 2013.

finally uses some traffic theory based ideas to convert speed into travel times.

## APPENDIX A

### TRAFFIC-THEORY BASED METHODS

These methods try to explicitly model the dynamics/physics of the traffic. The associated models could broadly be categorized either as (a)macroscopic (modeling at a coarse level capturing aggregate variables flow, density and speed) [43] OR (b)microscopic (detailed modeling at a vehicular level) [44]. While the macroscopic models give only an aggregate information, microscopic models suffer from issues like being computationally expensive, necessity to calibrate, and making inaccurate predictions. A recent approach based on a traffic-theory based model using speed as input was proposed in [17]. [45] breaks the travel time into different components like queuing delay at signals, acceleration and deceleration into and out of bus-stops which incorporates the physics of traffic into prediction. [46] does a speed-based prediction and