

Testing the physics of knots with a Feringa nano engine

M. Lang,¹ C. Schuster,^{1,2} R. Dockhorn,^{1,2} M. Wengenmayr,^{1,2} J.-U. Sommer^{1,2}

¹*Institut Theorie der Polymere, Leibniz-Institut für Polymerforschung
Dresden e.V., Hohe Straße 6, 01069 Dresden, Germany and*

²*Technische Universität Dresden, Institute for Theoretical Physics, Zellescher Weg 17, 01069 Dresden, Germany**

We use the bond fluctuation model to study the contraction process of two polymer loops with N segments that are connected each to the bottom and top part of a Feringa engine. The change in the size of the molecules as well as the folding of the two strands follows approximately scaling predictions that are derived by assuming that the strands are confined inside an effective tube. Conformation data can be overlapped when plotting it as a function of $W_n N^{-1/4}$, where W_n is the winding number of the two strands that is proportional to the number of blobs inside the “knotted” region of the molecule and N is the degree of polymerization of the strands. Our data supports a weak localization of the knots along the contour of flexible cyclic a-thermal polymers with a localization exponent $t \approx 0.78$.

I. INTRODUCTION

The physics of knotting is relevant for any kind of long flexible molecule that is free to select its conformations. Knots affect the size of the molecules [1], equilibrium and non-equilibrium dynamics [2, 3], deformation behavior [4], translocation through a pore [5, 6], or protein folding [7] to provide just some examples. One key question is whether knots self-tighten for entropic reasons or not [8], as this self-tightening controls the portion of the molecule that is subject to a knotted conformation.

This question originates from physics motivated models for the entropy of a knotted molecule, for instance ref. [9]. Here, the self-confinement of the chains is modeled by considering a maximally inflated confining tube with the same knot topology as the chain inside the tube. Inflating the tube to a diameter ξ until it arrests at a contour length L results in a weak topological invariant $p = L/\xi$ of tube segments equivalent to the “rope-length” [10] used by mathematicians to characterize different “ideal” knots [11]. For a chain consisting of N statistical segments of length b , one way to realize optimum conformations is [12] within such a maximum inflated tube where the maximum entropy S of the embedded chain is found by balancing Pincus tension blobs with compression blobs. As a result, the size of the molecule, R , varies as $R \propto p^{-1/6}$ [12]. Another way is to assume a “phase separation” between a tightly knotted section of $\approx p$ segments and an unconstrained loop of roughly $\approx N - p$ segments [12]. In the latter case, the resulting molecular size $R \propto p^{-\nu+1/3}$ is also a function of the rope length p , whereby $\nu \approx 0.5876$ [13] is the Flory exponent. “Phase separation” (self-tightening of the knot) is expected, if $p \ll N^{0.2}$, while the knot spreads over the whole polymer otherwise. As the coefficients for the phase boundary are not known, one cannot rule out that extremely long chains with N on the order of 10^6 or even much larger might be necessary to observe phase separation

rated knots, since the smallest possible ropelength of the trefoil knot is $p \approx 16.4$ [11] and there is no way to reduce p below this minimum for a fixed knot topology.

Several simulation studies have addressed this question in the past [14–17] but arrive at different results concerning the power t that describes the localization of the knotted section within N^t segments. For closed random walks, $t = 0$ was obtained in refs. [18, 19]. For self-avoiding walks, an exponent of $t = 0.4 \pm 0.1$ [16] or $t \approx 0.75$ [14, 15] was obtained using different approaches. Recent data by Dai et al. [17] on the knotting of linear self-avoiding chains were considered to be more in line with a preferred knot size independent of N , i.e. $t = 0$, but it was suspected that still a fat tail could affect the scaling of the average size of a knot [8].

A general problem for analyzing knot localization is that real polymers exhibit force extension relations [20] quite different to a Gaussian coil or a self-avoiding chain when the tube diameter is getting squeezed to a size comparable to individual segments [21]. Thus, significant corrections to the free energy estimates in ref. [9] might be necessary. On top of that, the algorithm for analyzing the knotted section could lead to artifacts [22], in particular for more complex knots or collapsed conformations of a knot. Beyond that, additional finite N corrections come into play when the molecule consists not of much more tension blobs as the ropelength of the knot, see the Appendix C for more details. Taking these points together, self-tightening of knots still appears to be a Gordian knot.

Recent work where rotating molecular engines were attached to polymers [23, 24] possibly provides the sword to untie this Gordian knot. These nano engines allow to tune the rope length p of a figure of 8-shaped “tanglotron” molecule (“T8”, see Figure 1.) continuously down to zero, which reduces dramatically the required N to observe a possible phase transition between self-tightened and spreaded state. The resulting topology of the T8 under the action of the engine is not truly a knot and it does not refer exactly to a linked state of two cyclic polymers, since the central unit of the engine is located on both cyclic strands. But this is unproblematic for our analysis, since the similarity of linked and knotted struc-

* lang@ipfdd.de

tures concerning knot localization has been demonstrated in previous works [25, 26] and the common point induces corrections only of order $1/N$. Actually, the original work by Grosberg [9] ignores explicitly such details for the sake of a general physical model that applies independent of the type of knot or link.

In our work, we discuss first our simulations before we analyze the properties of the T8 in the limit of small p concerning signatures of self-tightening or a phase transition from a spreaded to non-spreaded state. We further use the linear deformation regime at small applied torques M of the molecular engine to measure the topological potential that unfavours the formation of a larger rope length p . This provides an alternative access to the localization exponent, whereby the results can be double checked by the conformation changes as a function of p without need for an algorithm to detect knot localization. This last point is of particular relevance for our study, since the known algorithms to identify the knotted part may lead to increasingly ambiguous results for more complex knots or more collapsed conformations of a knot [22]. In our simulations, the complexity of the link increases with torque and enforces a collapse of the molecule. Thus, a systematic bias when using one of these methods to detect knot localization could not be excluded, but this difficulties are avoided with our approach.

II. SIMULATION DETAILS AND ANALYSIS

For simulation, we use the bond fluctuation model (BFM) by Carmesin and Kremer [27] and Deutsch and Binder [28]. It is a Monte Carlo method to simulate universal properties of polymers on a lattice. In this model, a monomer occupies a cube of 8 adjacent lattice sites on a simple cubic lattice. The monomers are connected by bond vectors, which are restricted to a specific set of 108 vectors of length between 2 and $\sqrt{10}$. These vectors are defined such that a test of excluded volume for a motion to one of the nearest 6 lattice positions is sufficient to preserve topology, if the bond vectors from the new position are still contained in the set of allowed bond vectors. Monomers and motion directions are chosen randomly. A Monte-Carlo step consists of m attempted monomer moves, where m is the number of monomers in the simulation box.

The Feringa engine is built up of two parts called rotor and stator, see top left part of Figure 1. The rotor undergoes conformation changes in the way that it rotates unidirectional around the stator when illuminated with light [29, 31]. To model a similar qualitative behavior with the BFM, the motor is made of five monomers as shown in the top right part of Figure 1. At X and Y, the Feringa engine is connected to the surrounding structure; in the simulations this happens on all rotor monomers in order to cause a twist of the connected pair of chains. For illustration, Ref. [30] contains a short movie that

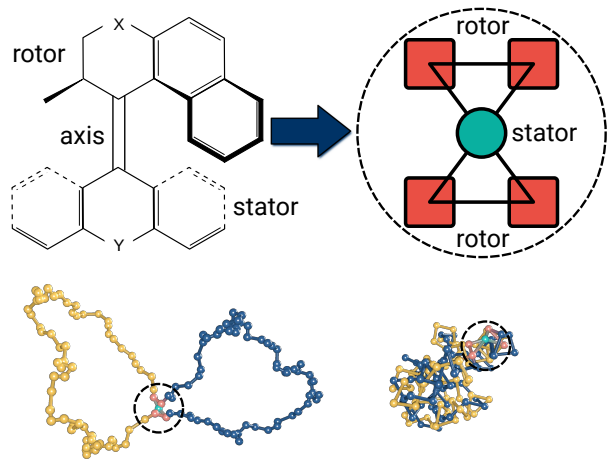

Figure 1. Left top: chemical structure of a second generation Feringa engine [29]. Right top: implementation as a double rotor molecule within the simulations. Bottom: unfolded state of the T8 with a nano engine at its core (left) and completely coiled state (right). See also Ref. [30] for a short movie that shows the coiling of the structure in response to the action of the engine. All Figures color online.

shows how the Feringa engine coils up the two attached polymer strands.

In a lattice based Monte-Carlo simulation, it is not feasible to completely block the backwards rotation of the rotors as for the original Feringa engine, since this could cause a freezing of the engine. Thus, we use the Metropolis algorithm [32] to introduce a penalty for backwards rotation based upon the potential energy difference

$$\Delta U = \pm M \Delta \alpha \quad (1)$$

between new and old position of the particle. Here, M is an effective torque acting on the rotor to model the rotational engines of refs [29, 31]. $\Delta \alpha$ is the change in the angle of twist between upper and lower rotor upon moving a monomer and the sign in front of M determines whether the engine drives right handed (negative) or left handed (positive) twist. Note that a proper computation of $\Delta \alpha$ leads to some non-trivial restrictions for our lattice based simulation model, which are discussed in the Appendix A. The motion of a rotor monomer is performed only with probability w

$$w = \min \left[1, \exp \left(- \frac{\Delta U}{kT} \right) \right]. \quad (2)$$

Note that this implementation is qualitatively similar to the function of a Feringa engine during irradiation for an appropriate choice of M and at low total twist of the attached polymers, but not after the light has been switched off or in the limit of high torque. The Feringa engine still preserves the torsion angle between upper and lower rotor, while setting $M = 0$ in the simulations either results in a backwards rotation (if potential energy was

stored in the attached polymer structure) or a random drift of the torsion angle. This could be adapted in the simulations by inserting an additional bond that connects both rotors of the engine and blocks further rotation at the end of the irradiation. Furthermore, the increase of the torsion angle is not monotonic in the simulations and fluctuations $> 2\pi$ around an average torsion angle are always possible, which is not the case for the original Feringa engine.

Note that the gels with Feringa engines inside were breaking after a long time exposure with light in ref. [23]. To allow for a better control of the induced shrinking process and a reversible use of the materials, either a second mechanism to unwind the chains is required or the development of engines that control torque as a function of light intensity. The former possibility has been realized recently [33]. Related research by one of the authors of ref. [23] already considers equilibrium physics simulations to model the action of such engines [24]. Our research is in line with this modification of the engines to make them more suitable for polymer applications.

The choice of the BFM as simulation model in contrast to molecular dynamics as in ref. [24] is motivated by the high performance of the BFM that allows to scale up to gels containing Feringa engines. Certainly, we cannot address the dynamic response of the attached molecules to the action of the engine with our lattice based simulations. But Monte-Carlo methods are known to be very effective tools to study universal properties related to molecular conformations at equilibrium [34], which is the task of our investigations.

The typical response of a single attached flexible polymer strand to the action of a Feringa engine is not of particular interest, since the action of the engine is typically much slower than the thermal (torsional) motion of the attached monomers. This is different to double stranded DNA with an intrinsic torsional stiffness, where an applied torque can make a single ds-DNA strand to coil up with itself [35]. For flexible polymers, a significant response is achieved when at least two strands are attached to either side of the Feringa engine, which now causes these strands to wind around each other. This type of coiling is most conveniently measured by summation over all changes of the angle of twist $\Delta\alpha$ of a given engine, which provides the change in the winding number [36]

$$\Delta W_n = \frac{\sum \Delta\alpha}{2\pi} \quad (3)$$

between pairs of strands connecting from upper to lower rotor upon the action of the engine.

Alternatively, one can consider the linking number

$$L_k = \frac{1}{4\pi} \oint_{x_1} \oint_{x_2} \vec{x}'_1(s_1) \times \vec{x}'_2(s_2) \cdot \frac{\vec{x}_1(s_1) - \vec{x}_2(s_2)}{|\vec{x}_1(s_1) - \vec{x}_2(s_2)|^3} ds_1 ds_2, \quad (4)$$

as defined for two closed non-crossing curves x_1 and x_2 and their tangent vectors $\vec{x}'(s)$ at s . Here, still one needs

to connect monomers A and C as well as B and D such that curve closure does not lead to an intersection of the two curves [37]. Note that in contrast to the winding number, the Linking number is always an integer. Since $W_n - 1 \leq L_k \leq W_n + 1$ when starting from uncoiled conformations of the 8-shaped tanglotron (“T8”), we used this dependence to double check our computation of W_n and L_k . For convenience, however, the angle of twist was measured continuously to determine the average winding numbers W_n at a given torque.

III. “KNOT” LOCALIZATION

Let us consider first simple scaling arguments to understand the behavior of the *maximum inflated tube* (spreaded knot). In our simulations, we apply a stochastic force f_t at a distance $b/2$ from the rotation axis of the engine such that the applied torque at the engine is $M \approx f_t b/2$. The action of the engine coils up the two strands and we expect a tight double helix conformation of tension blobs for maximum inflated tubes similar to ref. [24]. For a tube diameter (blob size) $\xi > b$ (or equivalently an applied torque of roughly $M \lesssim kT$), the force f_t is leveraged by excluded volume interactions within the first blob to a distance of $\approx \xi$ instead of $\approx b$ from the axis of the helix of tubes. The pulling force along the tube is not modified, since the repulsion of the strands that drives the leverage is orthogonal to f_t (as a mechanical analogue one could consider a pulley at distance $\xi/2$ and pulling the chain with force f_t through this pulley). This leads for $M \lesssim kT$ to an effective torque $M_e \approx M\xi/b \approx kT$ inside the entangled section that is larger than the “applied” torque M by a factor of ξ/b . Thus, instead of controlling torque, the action of the tanglotron sets the tube diameter $\xi \approx bkT/M \approx kT/f_t$. Using the scaling relation between the number of segments per blob and blob size in good solvents, $g \approx (\xi/b)^{1/\nu}$, one can estimate, therefore, the change in free energy by counting the number of tension blobs

$$\Delta F \approx kT \frac{N}{g} \approx kTN \left(\frac{M}{kT} \right)^{1/\nu} \quad (5)$$

as a function of the applied torque M .

It has been shown that optimum packing of a double helix (minimal tube length L at a given tube diameter and winding number W_n) is obtained for $L \approx W_n \xi (\pi^2 + 4)^{1/2}$ [24]. Since the cost in free energy for chain stretching is a known function of L [38], we arrive at a linear relation between change in free energy and the winding number:

$$\Delta F \approx (L/\xi) kT \approx pkT \approx W_n (\pi^2 + 4)^{1/2} kT. \quad (6)$$

In combination with the previous estimate of free energy, this yields

$$W_n \propto NM^{1/\nu}. \quad (7)$$

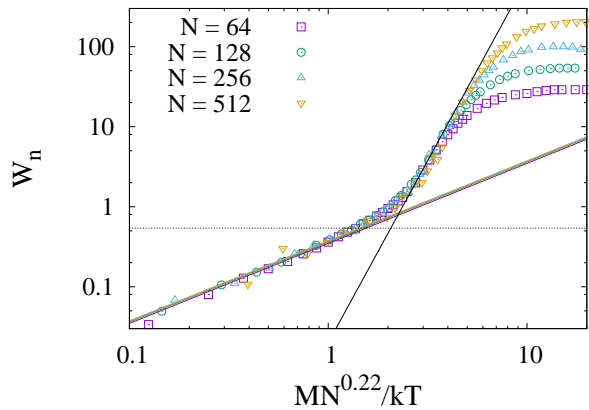

Figure 2. Winding number as a function of the scaled torque. The dotted line is at a level of $W_n = 2/(\pi^2 + 4)^{1/2}$ where there is in average one blob per strand inside the helix. The colored continuous lines are linear fits to the data at $MN^{0.22} < 1$. Overlap of the data was optimized with respect to the smallest variance of the coefficients of these linear fits. The black continuous line is the relation $W_n \propto M^{1/(1-t)}$ with $t = 0.78$.

Let us now develop a simple model for the *phase separated state*. Here, we assume that an entropic force is pulling a significant fraction of chain segments out of the entangled zone. Following the above discussion, we argue that the entropic force defines the number of segments per tension blob, g , inside the entangled zone as there is $\xi > b$. In order to check for a possible weak localization, we write $g \propto N^t$ with a localization exponent t to be determined from the simulation data. In the limit of low applied torque $M \ll kT$, we expect a linear force extension relation $M \propto W_n$ up to the point where pulling force f_t and entropic force compensate each other similar to the initial linear regime of a Pincus chain [38]. Coiling of the two strands occurs for torques larger than this threshold. The free energy cost for stretching an equivalent linear chain to g segments per tension blob is $\approx N/gkT \approx N^{1-t}kT$. Since there must be $M \propto N/g$ for the linear regime, we determine the exponent t by re-scaling M with a factor of N^{1-t} such that the W_n data for small M collapse on top of each other. This re-scaling of the linear regime works well as demonstrated in Figure 2 and leads also to a collapse to the data in the following non-linear regime up to the saturation point where the data levels off depending on N . Optimum collapse is obtained for $t \approx 0.78$, which is almost the same as in refs. [14, 15] with $t \approx 0.75$, but does not agree [39] with the $t = 0.4 \pm 0.1$ obtained in ref [16] or the $t \approx 0$ of [17].

The spreaded knot regime is not truly visible in Figure 2 and could be hidden in the transition to saturation. Another possibility is that the T8 switches between a spreaded and a phase separated state within the regime where W_n grows rapidly, since the free energies of these state could be of the same order of magnitude for the

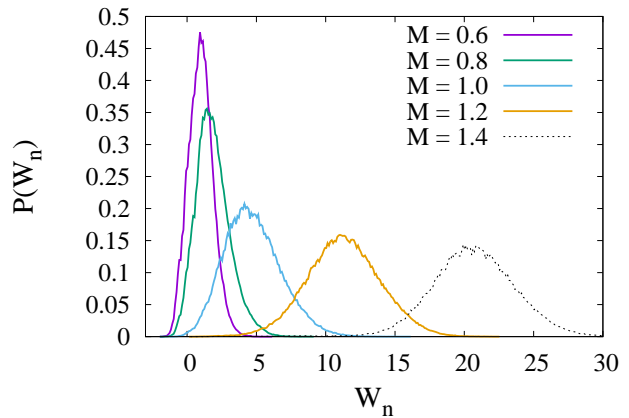

Figure 3. Normalized distribution of winding numbers for a given applied torque M and $N = 250$. The average winding numbers for $M = 0.6, 0.8, 1.0, 1.2$, and 1.4 are $W_n \approx 0.99, 1.99, 4.68, 10.7$, and 20.4 .

limited N of our study (the free energy penalty grows apparently just as $N^{0.22}$). In consequence, we would expect a significant jump in the winding numbers when switching from a phase separated to spreaded knot state, since the nano engine just triggers the blob size.

In order to scan for such a smeared out discontinuous phase transition, we analyzed the distribution of winding numbers, $P(W_n)$, for all torques and examples are shown in Figure 3. Our data shows no indication for two competing ground states with two separate peaks in $P(W_n)$ such that for the range of parameters of our study, the transition is a continuous one. As a complementary test, we also analyzed the contacts between segments on the two loops (see Appendix B). The data of this analysis is in accord with a localization of the entanglements next to the Feringa engine for torques $M \lesssim 1.2$ (prior to the onset of saturation). Therefore, we conclude that there is a weak localization of the entanglements next to the engine with a localization exponent $t \approx 0.78$ as discussed above. This weak localization covers essentially all of the accessible parameter space between initial linear and final saturation regime.

One striking feature of the data in Figure 3 is the broad distribution of W_n for a given torque and correspondingly, the number of blobs in the entangled zone. These fluctuations smear out the folding transition. In consequence, possible corrections to scaling can hardly be extracted from the data. Thus, we attempt only a very simplistic description of the regime where W_n increases strongly. Let us assume that this growth occurs in self-similar manner. The corresponding power has to settle an increase of $W_n \propto N$ for a window of torques $M \propto N^{1-t}$, which results in the proposal that a very rough approximation might be obtained by a power law

$$W_n \propto M^{1/(1-t)} \approx M^{4.55}. \quad (8)$$

This simplistic estimate is included into Figure 2 and

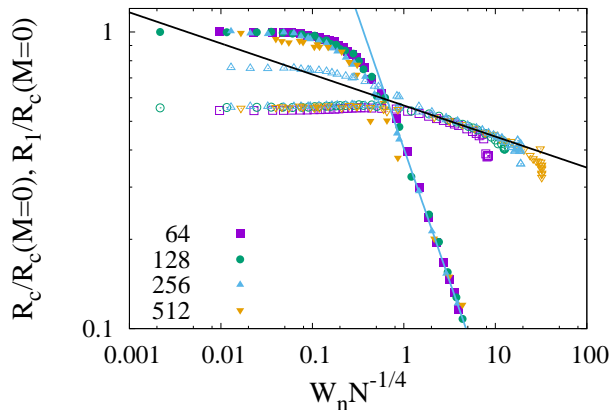

Figure 4. The center to center distance of both loops, R_c , (full symbols) the gyration radius of a single loop, R_1 , (lower set of data with open symbols) are shown as a function of the scaled winding number $W_n N^{-1/4}$. For comparison, the gyration radius of the whole molecule, R_g , is shown for one particular sample ($N = 256$, open triangles). All data are normalized with respect to R_c at zero torque, $M = 0$. The lines are power law fits for large W_n yielding -0.89 ± 0.03 for the R_c data and -0.10 ± 0.01 for the R_1 data respectively.

agrees surprisingly well with the simulation data.

IV. FOLDING TRANSITION

The folding process of the T8 is monitored best by the distance between the centers of mass of both loops, R_c , since it shows the strongest change as a function of W_n , see Figure 4. Recall that $p \propto W_n$ and that the position of the transition point should scale as $p \approx N^{0.2}$. Thus, we expect a collapse of all data, when plotting it as a function of $W_n N^{-0.2}$. As above, we vary the power of N to scan for optimum collapse of the data, which is found for $W_n N^{-1/4}$. This is close to the original prediction, which strongly supports the model of Grosberg et. al. [9, 12].

Let us discuss now the scaling of the conformation changes of the T8. Figure 4 shows that distinct power laws can only be tested for $W_n N^{-1/4} > 1$, which refers to the spreaded knot regime. As “folding point” we identify the intersection of the high W_n scaling regimes that almost coincides with the condition that the center-to-center distance equals the gyration radius of a single loop, $R_c = R_1$. One key parameter for our scaling analysis is the knotting length of a cyclic polymer, N_0 , which is in the range of 3000 segments for the bond fluctuation model in melt [40], while it can be expected in the range of 10^5 segments for isolated molecules in good solvent [41]. Therefore, our data is clearly in the limit of $N < pN_0$, for which a shrinkage of the size of the molecule with increasing complexity of the knot, $R \propto p^{-1/6}$, was proposed previously [12]. We obtain

$R \approx R_1 \propto p^{-0.10 \pm 0.01}$, which is a smaller power than predicted. However, the range of data $W_n N^{1/4} > 1$ is still quite narrow to truly test a weak power law $p^{-1/6}$. Furthermore, for increasing W_n , our samples gradually cross over to the regime where the chain sections inside the blobs are overstretched. Overstretched chains show a sub-linear response to an applied force, which results in a smaller apparent power for the change in R . This explains qualitatively the observed discrepancy to the theoretical prediction.

In order to discuss the scaling of R_c in the folded state, we assume a helix like conformation of the effective tubes where the chains are confined similar to ref. [24] and in agreement with the model of Grosberg [9, 12]. Under these conditions, chain conformations are modeled by $\propto W_n$ blobs of size $\xi \propto b g^\nu \propto b (N/W_n)^\nu$. Each of the $\propto W_n$ pairs of blobs along the helix provides an independent measurement for the distance ξ . We interpret the scaling of the center of mass distance R_c as a series of $\propto W_n$ independent measurements of the inter-blob distance, thus, we expect $R_c \approx \xi W_n^{-1/2} \propto b N^\nu W_n^{-(\nu+1/2)} \propto W_n^{-1.08}$. Our simulation data fits best to $W_n^{-0.89 \pm 0.03}$, which is again a somewhat weaker dependence as expected that could be explained qualitatively by the same reasons as above. Altogether, also the conformation changes support the model of Grosberg et al. [9, 12].

V. DISCUSSION

The above results allow for a distinct view on previous simulation studies, in particular concerning the different results for the localization exponent ranging from $t \approx 0$ [17] over $t \approx 0.4$ [16] to $t \approx 0.75$ [14, 15]. The major differences among these works - beyond “boundary effects” for cyclic vs. linear polymers - are the existence of an external pulling force (only in ref. [16]) and the algorithm to detect knot localization.

With our data at hand, we cannot judge on the impact [22] of the different algorithms that were used. On the contrary, we have to stress that such a discussion does not affect our results, as we determine the localization potential directly by analyzing the entropic cost to create additional “blobs” for increasingly coiled conformations of two intertwined polymer strands. The analysis in ref. [17] yields an effective tube diameter of roughly three times the size of a monomer, which is within the regime where classical scaling laws no longer lead to a reasonable description of cylindrically confined chains [21]. Together with the suspicion that still a fat tail could affect the scaling of the average size of a knot [8] and our discussion in the Appendix C, it remains difficult to conclude towards a yet asymptotic behaviour. With respect to the above discussion, it is indeed rather surprising that our data agrees well with refs. [14, 15] on cyclic polymers also concerning the still limited ratio of $N/(gp)$ for a fixed knot topology.

Recent work on the active supercoiling of DNA [42] in-

vestigates also the active coiling of molecules by means of computer simulations, here the dynamic coiling of individual DNA strands and the relevance of this problem for the unknotting and postreplicative decatenation of DNA. Research in this direction, however, would require to use non-equilibrium molecular dynamics simulations. With our tools at hand, the investigation of more complex systems at equilibrium is straight forward to address. Therefore, our current interest focusses on the investigation of gels containing nano-engines as in the experiments of ref. [23] or the analysis of individual polymers attached nano-engines in more complex environments than an a-thermal solvent.

VI. SUMMARY

In the present work, we have presented simulation data and a scaling analysis of a figure of 8 shaped molecule (“T8”) where two polymer loops are coiled up against each other by a Feringa engine that is located at the core of the molecule. Our observations support Grosberg’s model [9, 12] for the physics of knotted polymers. Conformation data can be overlapped when plotting it as a function of $W_n N^{-1/4}$, where W_n is the winding number of the two strands that is proportional to the number of blobs inside the “knotted” region of the molecule. The change in the size of the molecules as well as the folding of the two strands follows roughly scaling predictions that are derived by assuming that the strands are confined inside an effective tube, in agreement with the model assumptions in refs. [9, 12]. Finally, our data supports a weak localization of the knots with localization exponent $t \approx 0.78$ in case of single polymers in the a-thermal limit.

VII. ACKNOWLEDGEMENT

The authors acknowledge funding from the DFG grants LA 2735/5-1 and SO 277/17 and a generous grant of computation time at the ZIH Dresden.

VIII. APPENDIX

A. Computation of the change in the angle of twist

The change in the angle of twist $\Delta\alpha$ of each motor is computed each time one rotor monomer is moved in the simulation. Computation requires particular care for lattice based simulations, where singularities in the computation of the twist angle are rather frequent, for instance, when a rotor is getting parallel to the rotation axis. Also, the large jump size allows for a significant number of jumps that lead to angular changes by π (jumps across the axis), for which it is not clear whether these refer to a left handed or right handed torsion. Furthermore, the rotation axis needs to move with the engine, i.e. it must

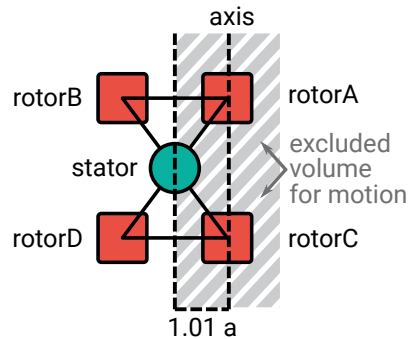

Figure 5. Sketch of the engine, rotation axis, and the volume that is excluded for the motion of rotor monomers B and D.

be defined by monomers of the engine. A reorientation of the axis causes additional changes in the angle of twist of the rotor that is stationary. The net change in torsion angle with respect to moved and stationary rotor needs to be restricted to less than π in order to correctly assign the handedness of the twist. All of these conditions are satisfied by the following definition of the rotation axis in combination with some additional restrictions on the motion of the rotor monomers.

The rotation axis \vec{A} is defined as the positions of rotor monomers A and C and pointing from C to A,

$$\vec{A} = \vec{R}_A - \vec{R}_C, \quad (9)$$

as shown in figure 5. In order to assure that the computation of the angles leads to no errors, the rotor monomers B and D are forced to stay a minimum distance of more than one lattice unit away from the rotation axis. Also, an attempted motion of an axis monomer is rejected, if it leads to new positions that are in conflict with this condition. This prevents that a rotor becomes parallel to the axis and that jumps across the axis occur, since jumps are of one lattice unit length. Because of this jump length, also the maximum change in the angle of twist per rotor is restricted to less than $\pi/3$ and the total change in twist remains below $2\pi/3$, which allows to correctly assign the handedness.

For computation of the angle of twist we distinguish between the two cases where the axis moves or where it is stationary. In the former case, we can directly proceed to the computation of the angle of twist, equations (19)-(23) while otherwise, we have to first rotate the current coordinates into the future coordinate system. To simplify notation, we add an index a to specify the new coordinates *after* the move and an index r , if these coordinates need to be considered in a *rotated* coordinate system. If the axis changes during the move, i.e. when monomer A or C move, we first check whether the current axis \vec{A} and future axis \vec{A}_a after the move are parallel. If yes, the change in the angle of twist is zero and we are done. If not, we compute the rotation matrix that rotates axis \vec{A} into the new direction \vec{A}_a such that yaw, pitch and roll angles are correctly separated, and the change

in twist angle is solely related to the change in roll angle. To this end, we first construct an orthonormal base from the the plane of axis reorientation using

$$\vec{N} = \vec{A} \times \vec{A}_a \quad (10)$$

and

$$\vec{C} = \vec{N} \times \vec{A}. \quad (11)$$

Next, we normalize all vectors $\vec{e}_X = \vec{X}/|\vec{X}|$ with $X = A, C, N$ and define the orientation matrix prior to the move,

$$\mathbf{M}_p = (\vec{e}_C, \vec{e}_N, \vec{e}_A). \quad (12)$$

The orientation matrix after the move, M_a , is obtained by using

$$\vec{N}_a = \vec{A}_a \times -\vec{A} \quad (13)$$

and

$$\vec{C}_a = \vec{N} \times \vec{A}_a \quad (14)$$

in similar manner as above from the normalized vectors \vec{e}_X :

$$\mathbf{M}_a = (\vec{e}_{C_a}, \vec{e}_{N_a}, \vec{e}_{A_a}). \quad (15)$$

The rotation matrix \mathbf{M} is then given by right multiplication of the matrix after the move with the inverted matrix prior to the move

$$\mathbf{M} = \mathbf{M}_a \mathbf{M}_p^{-1}. \quad (16)$$

This rotation matrix is used to rotate the upper

$$\vec{U}_r = \mathbf{M} \vec{U} = \mathbf{M} (\vec{R}_B - \vec{R}_A) \quad (17)$$

and lower rotor

$$\vec{L}_r = \mathbf{M} \vec{L} = \mathbf{M} (\vec{R}_D - \vec{R}_C). \quad (18)$$

The rotated vectors \vec{U}_r , \vec{L}_r , and \vec{e}_{A_a} replace \vec{U} , \vec{L} , and \vec{e}_A below, if the axis is moving.

Due to the symmetry of the problem, we denote here only the change in the angle of twist for the upper rotor. Obviously, $\vec{A} = \vec{A}_a$, if the axis is not moving. The scalar product of \vec{e}_{A_a} times \vec{U} (or \vec{U}_r , if the axis is moving) provides the vector component parallel to the axis \vec{A}_a , which we use to compute the vector component

$$\vec{O}_U = \vec{U} - \vec{A}_a \cdot (\vec{U} \cdot \vec{e}_{A_a}) \quad (19)$$

of the upper rotor orthogonal to axis \vec{A}_a . The same computations are repeated for \vec{U}_a and provide \vec{O}_{U_a} . The

angle between both orthogonal components of the upper rotor, α_U , is given by

$$\alpha_U = \arccos \left(\frac{\vec{O}_U \cdot \vec{O}_{U_a}}{|\vec{O}_U| |\vec{O}_{U_a}|} \right). \quad (20)$$

The chirality of the upper rotor, c_U , is one, $c_U = 1$, if

$$\vec{A} \cdot (\vec{O}_U \times \vec{O}_{U'}) > 0, \quad (21)$$

which determines, whether the change in angle of twist of the upper rotor is positive ($c_U = -1$ otherwise). If only the upper rotor is moving, the change in the angle of twist is given by

$$\Delta\alpha = \alpha_U c_U. \quad (22)$$

Note that the chirality of the lower rotor, c_L is computed analogously but with opposite sign in order to provide the twist of upper rotor with respect to the lower rotor.

If the axis is moving, we compute the change in angle of twist for both upper and lower rotor separately. The total change in angle of twist is then

$$\Delta\alpha = \alpha_U c_U + \alpha_L c_L. \quad (23)$$

This $\Delta\alpha$ is used to compute the potential energy difference in equation (1) of the main manuscript.

B. Contact analysis

In order to learn about the conformations of the T8, contacts between segments of the two polymer loops were analyzed. The monomers of each loop were labeled from $i = 2$ to $N + 1$ in order to compute the elastic strand

$$N_{el}(i) = \frac{i(N + 2 - i)}{N + 2} \quad (24)$$

to the center monomer of the engine similar to previous work on cyclic polymers [43]. N_{el} is taken as a rough estimate for the number of segments for an equivalent self-avoiding walk that describes the return probability to the center of the T8, which refers to the closest segments of the second loop. Due to the quick decay of the return probability of inside chain contacts [44, 45], $P_c \propto N_{el}^{-(d+\theta_2)\nu} \propto N_{el}^{-2.18}$, we expect that this estimate captures the approximate scaling of the contacts without applied torque. Note that we consider the contact exponent θ_2 for contacts between inner segments of chains, as the T8 has no ends. Contacts are determined from simulation data by analyzing a sphere with radius 3 lattice units around a given monomer. The contact probability P_c is defined by the event that at least one monomer of the other loop resides within this sphere and it is averaged over a long time series of conformations.

The results of this analysis are plotted in Figure 6 for some selected torques. The obvious trend is that

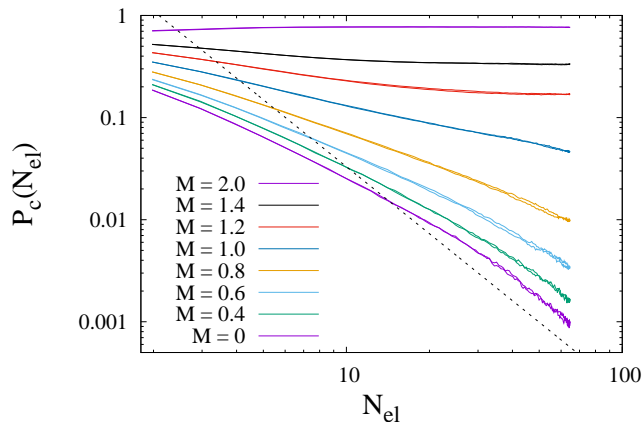

Figure 6. Contacts between segments of the loop of the elastic strand N_{el} to the center monomer of the engine for a T8 with $N = 256$. The thin dotted line indicates a scaling $P_c \propto N_{el}^{-(d+\theta_2)\nu} \propto N_{el}^{-2.18}$.

contacts increase with increasing torque. In the limit of low torques, $M \approx 0$, the contact probability follows approximately the scaling expected for a self-avoiding walk for large N_{el} . This indicates that the simplifications above and the mapping on N_{el} are consistent with the simulation data. Saturation $P_c \approx const.$ is only reached for rather high torques $M \gtrsim 1.2$ where at least 1 out of 5 monomers is in contact with a monomer of the second loop. Note that the winding numbers for $M = 0.6, 0.8, 1.0$, and 1.2 are $W_n \approx 0.99, 1.99, 4.68$, and 10.7 . Since there are about 3.7 blobs per winding number, the coils start to be overstretched already at torques $M \gtrsim 1$ close to the qualitative change of the contact statistics. The data between these cases shows a gradual transition between both asymptotic limits, whereby at larger N_{el} an increased downturn of P_c is visible, which indicates the preferred localization of entanglements (and thus, enhanced contacts) next to the engine.

An alternate view on the contact statistics is provided in Figure 7, where P_c is analyzed as a function of the applied torque for a given segment index i . Folded conformations show up here by a collapse of the data at same torque as we observe for $M/kT \gtrsim 1.2$. The missing collapse of the data at low torque points towards a localization of the entanglements next to the engine of the tanglotron.

C. Numerical correction to localization

The determination of the size of the knotted region is a non-trivial task, which is in most cases performed by an algorithm of the type described in [8]: “... usually by the steepest descent, the smallest among the spheres” is selected, “which satisfy two properties: first, the sphere has to be pierced by the polymer exactly two times (thus allowing for an unambiguous determination of the topology

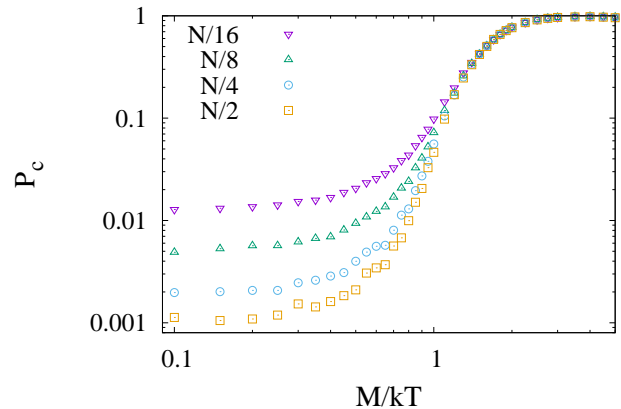

Figure 7. Contact probability P_c between loops for selected monomers at $i = N/2, N/4, N/8$, and $N/16$. Data was recorded for the T8 with $N = 256$.

for the inside section of the polymer); second, the portion of the polymer inside of the sphere is topologically equivalent to the entire chain (which means the sphere encloses the knot). Polymer length inside this sphere is L_{knot} .”

In order to understand whether such an algorithm leads to some numerical bias for the weight fraction

$$w_{knot} = N_{knot}/N = L_{knot}/(bN) \quad (25)$$

of polymer inside the knot or not, let us perform the following gedankenexperiment: we consider a cyclic polymer where we randomly place l labels among the N segments of the chain. These labels regard randomly selected sections at which the polymer may wind around a second section of the chain and thus, could be the position where the polymer may cut through a minimum sphere as for the above algorithm. The largest among the sections between two subsequent labels will be chosen as the unknotted part of the polymer. Note that the case of a random choice of sections refers to zero localization of the “knot”. The question that we would like to answer is whether placing the labels along the chains leads to a statistical bias and thus, also for the algorithm for determining the weight fraction of the knot.

The result of this gedankenexperiment are shown in Figure 8. We observe a monotonously decaying w_{knot} for increasing N at constant l that might be interpreted as a weak localization of a knot despite of the fact that the labels were placed randomly. For sufficiently large N/l , this correction can be ignored. Note that an analytical description of this gedankenexperiment can be obtained by adapting the computations in ref. [46] (first label can be considered as to cut the cyclic polymer in a linear one).

Let us use the data in Figure 8 for a rough estimate of the minimum required N to observe unbiased results for the example of a trefoil knot. Apparently, the numerical correction starts to saturate roughly for $N/l \gtrsim 10$.

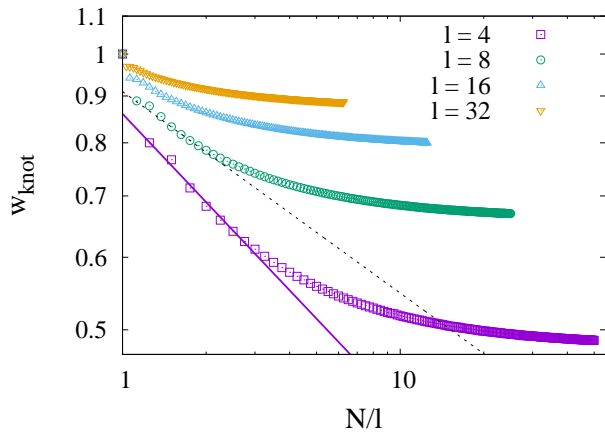

Figure 8. Estimated weight fraction of a knot w_{knot} for a set of random labels along a chain. The continuous line is a power law fit to the small N/l data for $l = 4$ with exponent -0.32 ± 0.01 and the dashed line indicates a power of -0.22 .

When adopting a scaling picture as proposed by Grosberg [9, 12], we identify the number N with the number of minimal units, which is confinement or tension blobs of the chain. l cannot be smaller than the minimum number of intersections when projecting the knot to a plane. Thus, the chains should consist of at least 30 blobs for an unbiased result. Furthermore, the polymer strands inside the blobs should not be overstretched to observe the proper scaling of the data. This requires, that blob size ξ as compared to fully stretched size of the corresponding chain section, bg , fulfills the condition $\xi/(bg) \lesssim 1/5$ [20]. Therefore, 750 segments for a self-avoiding cyclic polymer are just a lower bound for the required minimum number of chain sections to observe a correct scaling of knot localization. This criterion should be surpassed by at least one order of magnitude to determine the localization exponent, which has not been met in previous work. Recall also that the measured knot size may show additional dependencies on the algorithm used [22]. These problems are avoided by our approach as we measure the confining force within the very first blob.

-
- [1] Moore, N. T.; Grosberg, A. Y. *Phys. Rev. E* **2005**, *72*, 061803.
- [2] Mai, D. J.; Schroeder, C. M. *Curr. Op. Coll. Interf. Sci.* **2016**, *26*, 28–40.
- [3] Klotz, A. R.; Soh, B. W.; Doyle, P. S. *Phys. Rev. Lett.* **2018**, *120*, 18803.
- [4] Caraglio, M.; Micheletti, C.; Orlandini, E. *Phys. Rev. Lett.* **2015**, *115*, 188301.
- [5] Suma, A.; Rosa, A.; Micheletti, C. *ACS Macro Lett.* **2015**, *4*, 1420–1424.
- [6] Suma, A.; Micheletti, C. *PNAS* **2017**, *15*, E2991–E2997.
- [7] Ziegler, F.; Lim, N. C. H.; Mandal, S. S.; Pelz, B.; Ng, W.-P.; Schlierf, M.; Jackson, S. E.; Rief, M. *PNAS* **2016**, *113*, 7533–7538.
- [8] Grosberg, A. Y. *Polym. Sci. A* **2016**, *58*, 864–872.
- [9] Grosberg, A. Y.; Feigel, A.; Rabin, Y. *Phys. Rev. E* **1996**, *54*, 6618–6622.
- [10] Cantarella, J.; Kusner, R. B.; Sullivan, J. M. *Nature* **1998**, *392*, 237–238.
- [11] Katrich, V.; Bednar, J.; Michoud, D.; Scharein, R. G.; Dubochet, J.; Stasiak, A. *Nature* **1996**, *384*, 142–145.
- [12] Grosberg, A. *Phys. Rev. Lett.* **2000**, *85*, 3858–3861.
- [13] Clisby, N. *Phys. Rev. Lett.* **2010**, *104*, 055702.
- [14] Marcone, B.; Orlandini, E.; Stella, A. L.; Zonta, F. *J. of Phys. A: Math. Gen.* **2005**, *38*, L15–L21.
- [15] Marcone, B.; Orlandini, E.; Stella, A. L.; Zonta, F. *Phys. Rev. E* **2007**, *75*, 041105.
- [16] Farago, O.; Kantor, Y.; Kardar, M. *Europhys. Lett.* **2002**, *60*, 53–59.
- [17] Dai, L.; Renner, C. B.; Doyle, S. *Phys. Rev. Lett.* **2015**, *114*, 037801.
- [18] Katritch, V.; Olson, W. K.; Vologodskii, A.; Dubochet, J.; Stasiak, A. *Phys. Rev. E* **2000**, *61*, 5545–5549.
- [19] Millet, K. C. *Prog. Theoret. Phys. Suppl.* **2011**, *191*, 182–191.
- [20] Rubinstein, M.; Colby, R. H. *Polymer Physics*; Oxford University Press, 2005.
- [21] Kim, J.; Jeon, C.; Jeong, H.; Jung, Y.; Ha, B.-Y. *Soft Matter* **2013**, *9*, 6142–6150.
- [22] Tubiana, L.; Micheletti, E. O. C. *Prog. Theoret. Phys. Suppl.* **2011**, *191*, 192–204.
- [23] Li, Q.; Fuks, G.; Moulin, E.; Maaloum, M.; Rawiso, M.; Kulic, I.; Foy, J. T.; Giuseppone, N. *Nature Nanotechnology* **2015**, *10*, 161–165.
- [24] Weysser, F.; Benzerara, O.; Johner, A.; Kulic, I. M. *Soft Matter* **2015**, *11*, 732.
- [25] Metzler, R.; Hanke, A.; Dommersnes, P. G.; Kantor, Y.; Kardar, M. *Phys. Rev. E* **2002**, *65*, 061103.
- [26] Baiesi, M.; Orlandini, E.; Stella, A. L.; Zonta, F. *Phys. Rev. Lett.* **2011**, *106*, 258301.
- [27] Carmesin, I.; Kremer, K. *American Chemical Society* **1988**, *21*, 2819–2823.
- [28] Deutsch, H.; Binder, K. *Journal of Chemical Physics* **1991**, *94*, 2294–2304.
- [29] Koumura, N.; Geertsema, E.; van Gelder, M.; Meetsma, A.; Feringa, B. *American Chemical Society* **2002**, *124*, 5037–5051.
- [30] movie in Supplemental Material, U. R. L.
- [31] Koumura, N.; Zijlstra, R. W. J.; van Delden, R. A.; Harada, N.; Feringa, B. L. *Nature* **1999**, *401*, 152–155.
- [32] Metropolis, N.; Rosenbluth, A. W.; Rosenbluth, M. N.; Teller, A. H.; Teller, E. *The Journal of Chemical Physics* **1953**, *21*, 1087–1092.
- [33] Foy, J.; Li, Q.; Goujon, A.; Colard-Itte, J.; Fuks, G.; Moulin, E.; Schiffmann, O.; Dattler, D.; Funeriu, D.; Giuseppone, N. *Nature Nanotechnology* **2017**, *12*, 540–545.
- [34] Binder, K.; Paul, W. *Macromolecules* **2008**, *41*, 4537–4550.
- [35] Strick, T. R.; Allemand, J.-F.; Bensimon, D.; Bensimon, A.; Croquette, V. *Science* **1996**, *271*, 1835–1837.
- [36] Ricca, R., Ed. *Lectures on Topological Fluid Mechanics*;

Springer-Verlag: Berlin Heidelberg, 2009.

- [37] Adams, C. C. *Das Knotenbuch. Einführung in die mathematische Theorie der Knoten.*; Spektrum Akademischer Verlag GmbH: Heidelberg Berlin, 1995.
- [38] Pincus, P. *Macromolecules* **1976**, *9*, 386–388.
- [39] The force deformation data in Fig. 2 of ref. [16] do not scale as expected; it is therefore not clear whether the simulation data in ref. [16] are consistent or not.
- [40] Michalke, W.; Lang, M.; Kreitmeier, S.; Göritz, D. *Phys. Rev. E* **2001**, *64*, 012801.
- [41] Koniaris, K.; Muthukumar, M. *Phys. Rev. Lett.* **1997**, *66*, 2211–2214.
- [42] Racko, D.; Benedetti, F.; Dorier, J.; Burnier, Y.; Stasiak, A. *Nucleic Acids Research* **2015**, *43*, 7229–7236.
- [43] Lang, M. *Macromolecules* **2013**, *46*, 1158–1166.
- [44] Redner, S. *J. Phys. A: Math. Gen.* **1980**, *13*, 3525–3541.
- [45] Cloizeaux, J. D. *J. Phys. France* **1980**, *41*, 223–238.
- [46] Lang, M.; Göritz, D.; Kreitmeier, S. *Macromolecules* **2003**, *36*, 4646–4658.