

# THE CHARNEY-DAVIS CONJECTURE FOR SIMPLE THIN POLYOMINOES

MANOJ KUMMINI AND DHARM VEER

ABSTRACT. Let  $\mathcal{P}$  be a simple thin polyomino and  $\mathbb{k}$  a field. Let  $R$  be the toric  $\mathbb{k}$ -algebra associated to  $\mathcal{P}$ . Write the Hilbert series of  $R$  as  $h_R(t)/(1-t)^{\dim(R)}$ . We show that

$$(-1)^{\lfloor \frac{\deg h_R(t)}{2} \rfloor} h_R(-1) \geq 0$$

if  $R$  is Gorenstein. This shows that the Gorenstein rings associated to simple thin polyominoes satisfy the Charney-Davis conjecture.

## 1. INTRODUCTION

The Charney-Davis conjecture [CD95, Conjecture D] asserts that if  $h(t)$  is the  $h$ -polynomial of a flag simplicial homology  $(d-1)$ -sphere, then  $(-1)^{\lfloor \frac{d}{2} \rfloor} h(-1) \geq 0$ . Stanley [Sta00, Problem 4] extended this conjecture to Gorenstein\* flag simplicial complexes. Generalizing it further, Reiner and Welker [RW05, Question 4.4] posed the following:

**Question 1.1.** Let  $\mathbb{k}$  be a field and  $R$  a standard graded Gorenstein Koszul  $\mathbb{k}$ -algebra. Write the Hilbert series of  $R$  as  $h_R(t)/(1-t)^{\dim(R)}$ . Is

$$(-1)^{\lfloor \frac{\deg h_R(t)}{2} \rfloor} h_R(-1) \geq 0?$$

We say that a standard graded Gorenstein Koszul  $\mathbb{k}$ -algebra  $R$  is CD if it gives an affirmative answer to the above question. In this article, we show that the toric  $\mathbb{k}$ -algebras associated to simple thin polyominoes are CD, when they are Gorenstein.

Suppose that, in the notation of Question 1.1,  $\deg h_R(t)$  is odd. Then  $h_R(-1) = 0$ ; see, e.g., [BH93, Corollary 4.4.6]. Therefore Question 1.1 is open only when  $\deg h_R(t)$  is even. See the bibliography of [RW05] and of [Sta00] for various classes of rings that are CD. A class of CD rings related to the ones we study in this paper are Gorenstein Hibi rings [Brä04, Corollary 4.3]. Recently, D'Alì and Venturello [1] proved that the answer to Question 1.1 is negative in general.

A cell in  $\mathbb{R}^2$  is a set of the form  $\{(x, y) \in \mathbb{R}^2 \mid a \leq x \leq a+1, b \leq y \leq b+1\}$  where  $(a, b) \in \mathbb{Z}^2$ . Let  $\mathcal{P}$  be a finite collection of cells. Then  $\mathcal{P}$  determines a unique topological subspace  $\text{sp}(\mathcal{P}) := \cup_{C \in \mathcal{P}} C$  of  $\mathbb{R}^2$ . By abuse of terminology, we assign the topological attributes to  $\mathcal{P}$  that  $\text{sp}(\mathcal{P})$  has. We say that  $\mathcal{P}$  is a *polyomino* if  $\mathcal{P}$  is connected and does not have a finite cut-set [Sta97, 4.7.18] (i.e.,  $\text{sp}(\mathcal{P})$  has these properties). There is a  $\mathbb{k}$ -algebra  $\mathbb{k}[\mathcal{P}]$  of finite-type associated to  $\mathcal{P}$  [Qur12].

We say that a polyomino  $\mathcal{P}$  is *simple* if  $\text{sp}(\mathcal{P})$  is simply connected; it is *thin* if it does not have a  $2 \times 2$  square such as the one shown in Figure 1. The S-property of simple thin polyominoes was introduced in [RR21] to characterise such polyominoes  $\mathcal{P}$  for which  $\mathbb{k}[\mathcal{P}]$  is Gorenstein. If  $\mathcal{P}$  is simple then  $\mathbb{k}[\mathcal{P}]$  is a Koszul algebra [QSS17, Corollary 2.3]. Therefore it is natural to ask whether  $\mathbb{k}[\mathcal{P}]$  is CD if  $\mathcal{P}$  is a simple thin polyomino with the S-property. In this regard, we show the following:

**Theorem 1.2.** *Let  $\mathcal{P}$  be a collection of cells such that its connected components are simple thin polyominoes with the S-property. Then  $\mathbb{k}[\mathcal{P}]$  is CD.*

Note that if  $\mathcal{P}_1, \dots, \mathcal{P}_m$  are the connected components of  $\mathcal{P}$ , then  $\mathbb{k}[\mathcal{P}] \simeq \mathbb{k}[\mathcal{P}_1] \otimes_{\mathbb{k}} \dots \otimes_{\mathbb{k}} \mathbb{k}[\mathcal{P}_m]$ . Therefore  $\mathbb{k}[\mathcal{P}]$  Gorenstein (respectively, Koszul) if and only if  $\mathbb{k}[\mathcal{P}_i]$  is Gorenstein (respectively, Koszul) for each  $i$ .

Section 2 contains the definitions and preliminaries. Proof of the theorem is given in Section 3.

2020 Mathematics Subject Classification. 13D40 (Primary).

MK was partly supported by the grant CRG/2018/001592 from Science and Engineering Research Board, India and by an Infosys Foundation fellowship. DV was partly supported by an Infosys Foundation fellowship.

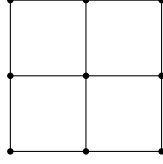

FIGURE 1. A  $2 \times 2$  square polyomino

## 2. PRELIMINARIES

**Gorenstein rings, Koszul rings, Hilbert series, etc.** Let  $R$  be a finitely generated  $\mathbb{k}$ -algebra. Throughout this paper, we deal with only standard graded  $\mathbb{k}$ -algebras  $R$ , i.e.,  $R$  is generated as a  $\mathbb{k}$ -algebra by homogeneous elements of degree 1. We say that  $R$  is *Gorenstein* if it is Cohen-Macaulay and  $\text{Ext}_R^{\dim R}(\mathbb{k}, R) \simeq \mathbb{k}$ . We say that  $R$  is *Koszul* if  $\mathbb{k}$  has a linear free resolution as an  $R$ -module.

The *Hilbert series*  $H_R(t)$  of  $R$  is the formal power series  $\sum_{i \in \mathbb{N}} \dim_{\mathbb{k}} R_i t^i$  where for each  $i$ ,  $R_i$  is the finite-dimensional  $\mathbb{k}$ -vector-space of the homogeneous elements of  $R$  of degree  $i$ . There exists a unique polynomial  $h_R(t)$  such that

$$H_R(t) = \frac{h_R(t)}{(1-t)^{\dim R}}.$$

Question 1.1 asks whether  $(-1)^{\lfloor \frac{\deg h_R(t)}{2} \rfloor} h_R(-1)$  is non-negative for all Gorenstein Koszul algebras  $R$ . Parenthetically, note that, if  $R$  is Cohen-Macaulay,  $\deg h_R(t)$  is the Castelnuovo-Mumford regularity of  $R$ .

**Polyominoes.** Let  $\mathcal{P}$  be a finite collection of cells. As mentioned in the introduction, we treat  $\mathcal{P}$  interchangeably with the topological space  $\text{sp}(\mathcal{P})$ . Let  $S = \mathbb{k}[\{x_{i,j} \mid (i,j) \in \mathcal{P} \cap \mathbb{Z}^2\}]$  be the standard graded polynomial ring in the variables  $x_{i,j}$ . Let  $\mathfrak{a}_{\mathcal{P}}$  be the binomial ideal generated by the binomials  $x_{i,j}x_{k,l} - x_{k,j}x_{i,l}$  for all  $(i,j), (k,l) \in \mathcal{P} \cap \mathbb{Z}^2$  such that the rectangle with vertices  $(i,j)$ ,  $(k,l)$ ,  $(k,j)$  and  $(i,l)$  is a subset of  $\text{sp}(\mathcal{P})$ . Define  $\mathbb{k}[\mathcal{P}] = S/\mathfrak{a}_{\mathcal{P}}$  [Qur12]. If  $\mathcal{P}$  is a simple polyomino, then  $\mathbb{k}[\mathcal{P}]$  is a Koszul Cohen-Macaulay integral domain [QSS17, Corollary 2.3].

For  $k \in \mathbb{N}$ , a  $k$ -rook configuration in  $\mathcal{P}$  is an arrangement of  $k$  rooks in pairwise non-attacking positions. The *rook polynomial*  $r_{\mathcal{P}}(t)$  of  $\mathcal{P}$  is  $\sum_{k \in \mathbb{N}} r_k t^k$  where  $r_k$  is the number of  $k$ -rook configurations in  $\mathcal{P}$ . The *rook number*  $r(\mathcal{P})$  of  $\mathcal{P}$  is the degree of  $r_{\mathcal{P}}(t)$ , i.e., the largest  $k$  such that there is a  $k$ -rook configuration in  $\mathcal{P}$ . If  $\mathcal{P}$  is a simple thin polyomino, then  $h_{\mathbb{k}[\mathcal{P}]}(t) = r_{\mathcal{P}}(t)$  [RR21, Theorem 1.1].

Let  $C, D \in \mathcal{P}$ . We say that  $C$  is a *neighbour* of  $D$  if  $C \cap D$  is a line segment. A *path* from  $C$  to  $D$  is a sequence of cells  $C = C_0, C_1, \dots, C_m = D$  such that for all  $i \neq j$ ,  $C_i \neq C_j$  and for all  $1 \leq i \leq m$ ,  $C_i$  is a neighbour of  $C_{i-1}$ . If  $\mathcal{P}$  is a simple thin polyomino, then for all cells  $C, D$  of  $\mathcal{P}$ , there is a unique path from  $C$  to  $D$ .

A *inner interval* of  $\mathcal{P}$  is a subcollection  $I$  of  $\mathcal{P}$  such that  $\text{sp}(I)$  (which is a subspace of  $\text{sp}(\mathcal{P})$ ) is a rectangle with vertices  $(i_1, j_1)$ ,  $(i_1 + 1, j_1)$ ,  $(i_1, j_2)$  and  $(i_1 + 1, j_2)$  or a rectangle with vertices  $(i_1, j_1)$ ,  $(i_1, j_1 + 1)$ ,  $(i_2, j_1)$  and  $(i_2, j_1 + 1)$  for some  $i_1, i_2, j_1, j_2 \in \mathbb{Z}$  with  $i_1 < i_2$  and  $j_1 < j_2$ . An inner interval of  $\mathcal{P}$  is *maximal* if it is maximal under inclusion.

Let  $\mathcal{P}$  be a simple thin polyomino. Observe that any cell of  $\mathcal{P}$  belongs to at most two maximal inner intervals. A cell  $C$  is said to be an *end-cell* of a maximal inner interval  $I$  if  $C \in I$  and  $C$  has exactly one neighbour cell in  $I$ . A cell of  $\mathcal{P}$  is called *single* if it belongs to exactly one maximal inner interval of  $\mathcal{P}$ . We say that  $\mathcal{P}$  has the *S-property* if every maximal inner interval of  $\mathcal{P}$  has exactly one single cell. For a simple thin polyomino  $\mathcal{P}$ ,  $\mathbb{k}[\mathcal{P}]$  is Gorenstein if and only if  $\mathcal{P}$  has the S-property [RR21, Theorem 4.2].

## 3. PROOF OF THE THEOREM

We begin with an observation about how Hilbert series and rook polynomials behave in disjoint unions of polyominoes.

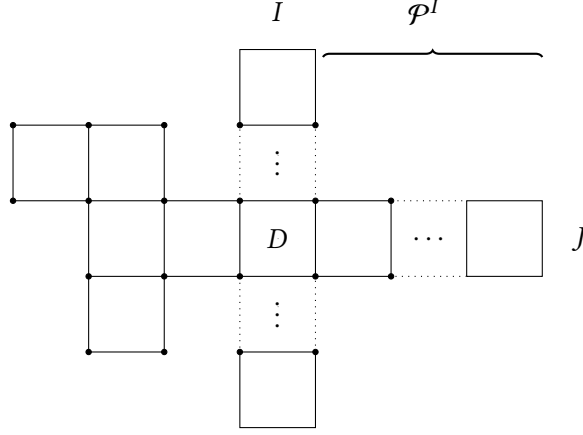

FIGURE 2. Collapse datum (cf. Definition 3.2)

**Proposition 3.1.** *Let  $\mathcal{P}$  be a finite collection of cells. Write  $\mathcal{P}_1, \dots, \mathcal{P}_m$  for the connected components. Then:*

$$h_{\mathbb{k}[\mathcal{P}]}(t) = \prod_{i=1}^m h_{\mathbb{k}[\mathcal{P}_i]}(t) \text{ and } r_{\mathcal{P}}(t) = \prod_{i=1}^m r_{\mathcal{P}_i}(t).$$

*In particular, if  $\mathcal{P}_i$  is a simple thin polyomino for each  $i$ , then  $h_{\mathbb{k}[\mathcal{P}]}(t) = r_{\mathcal{P}}(t)$ .*

*Proof.* Vertices of the  $\mathcal{P}_i$  are disjoint, so  $\mathbb{k}[\mathcal{P}] \simeq \mathbb{k}[\mathcal{P}_1] \otimes_{\mathbb{k}} \dots \otimes_{\mathbb{k}} \mathbb{k}[\mathcal{P}_m]$ . Hence  $H_{\mathbb{k}[\mathcal{P}]}(t) = \prod_{i=1}^m H_{\mathbb{k}[\mathcal{P}_i]}(t)$ , from which it follows that  $h_{\mathbb{k}[\mathcal{P}]}(t) = \prod_{i=1}^m h_{\mathbb{k}[\mathcal{P}_i]}(t)$ . Let  $k \in \mathbb{N}$ . Then  $k$ -rook configurations in  $\mathcal{P}$  corresponds to independent choices of  $k_i$ -rook configurations in  $\mathcal{P}_i$  for each  $1 \leq i \leq m$  and for each tuple  $(k_1, \dots, k_m) \in \mathbb{N}^m$  with  $\sum_i k_i = k$ . Hence  $r_{\mathcal{P}}(t) = \prod_{i=1}^m r_{\mathcal{P}_i}(t)$ . The final assertion now follows from noting that for each  $i$ ,  $h_{\mathbb{k}[\mathcal{P}_i]}(t) = r_{\mathcal{P}_i}(t)$  since  $\mathcal{P}_i$  is a simple thin polyomino [RR21, Theorem 1.1].  $\square$

Let  $\mathcal{P}$  be a simple thin polyomino. In [RR21, Definition 3.4], Rinaldo and Romeo introduced a notion of collapsing  $\mathcal{P}$  in a maximal inner interval, and showed that if  $\mathcal{P}$  has at least two maximal inner intervals, then there exists a maximal inner interval in which  $\mathcal{P}$  is collapsible [RR21, Proposition 3.7]. We need a refinement of this result for simple thin polyominoes with the  $S$ -property, for which we rephrase [RR21, Definition 3.4] in a slightly different way.

**Definition 3.2.** Let  $\mathcal{P}$  be a simple thin polyomino. A collapse datum on  $\mathcal{P}$  is a tuple  $(I, J, \mathcal{P}^I)$ , where  $I$  and  $J$  are maximal inner intervals and  $\mathcal{P}^I$  is a sub-polyomino of  $\mathcal{P}$  satisfying the following conditions:

- (1)  $J$  is the only maximal inner interval of  $\mathcal{P}$  such that  $I \cap J$  is a cell;
- (2)  $\mathcal{P}^I \subseteq J$  and  $I \cap J \notin \mathcal{P}^I$ .
- (3)  $\mathcal{P} \setminus (I \cup \mathcal{P}^I)$  is a non-empty sub-polyomino of  $\mathcal{P}$ .

Figure 2 gives an example of a collapse datum. Note that since  $\mathcal{P}^I$  is a sub-polyomino of  $\mathcal{P}$  and  $\mathcal{P}^I \subseteq J$ , it is an inner interval if it is non-empty. When  $\mathcal{P}$  has at least two maximal inner intervals, the maximal inner intervals  $I$  and  $J$  defined in the Definition 3.2 exist by [RR21, Lemma 3.6].

**Discussion 3.3.** Let  $\mathcal{P}$  be a simple thin polyomino with  $S$ -property. Assume that  $\mathcal{P}$  is not a cell. Then it has a collapse datum  $(I, J, \mathcal{P}^I)$ . Since, additionally,  $\mathcal{P}$  has the  $S$ -property,  $I$  has exactly two cells and  $\mathcal{P}^I$  is either empty or a cell. Write  $I = \{C, D\}$  with  $C$  denoting the single cell of  $I$  and  $\{D\} = I \cap J$ . Denote the single cell of  $J$  by  $E$ . Let  $C_1, \dots, C_k$  be the cells of  $J$  different from  $D$  and  $E$ . For  $1 \leq i \leq k$ , let  $B_i$  be the cell in  $\mathcal{P}$  such that  $B_i \notin J$  and  $C_i$  is a neighbour cell of  $B_i$ ; such a  $B_i$  must exist, since  $C_i$  is not a single cell. We now consider the various cases.

(1)  $\mathcal{P}^I \neq \emptyset$ . Equivalently,  $\mathcal{P}^I = \{E\}$ . Then we may assume that  $C_k$  is an end-cell of  $J$  and for all  $i \in \{1, \dots, k-1\}$ ,  $C_i$  and  $C_{i+1}$  are neighbours. So  $B_i$  and  $B_{i+1}$  can not be neighbours, since  $\mathcal{P}$  is thin. Hence for all  $i \in \{1, \dots, k\}$  whether  $B_i$  is above  $C_i$  or is below  $C_i$  determined by whether  $i$  is even or odd. Therefore in the neighbourhood of  $J$ ,  $\mathcal{P}$  is as shown in Figure 3.

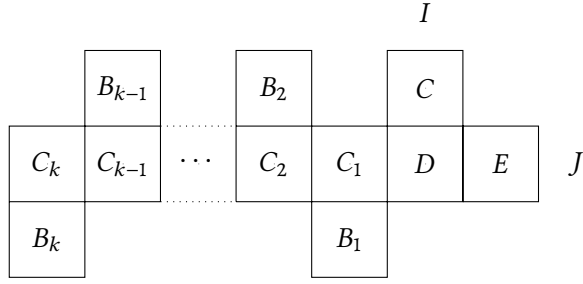

FIGURE 3.  $\mathcal{P}^I$  non-empty

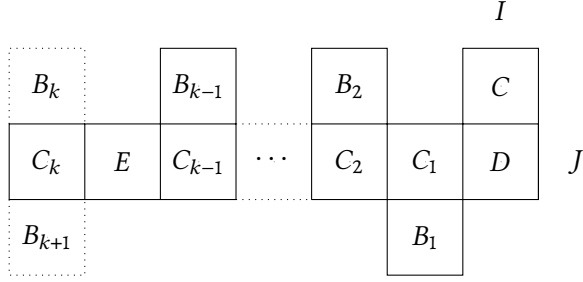

FIGURE 4.  $\mathcal{P}^I$  is empty,  $E$  is a neighbour of  $C_k$  but not an end-cell of  $J$

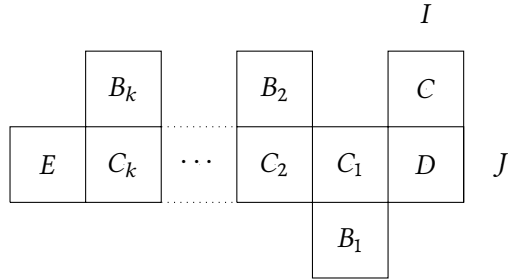

FIGURE 5.  $\mathcal{P}^I$  is empty,  $E$  is an end-cell of  $J$

(2)  $\mathcal{P}^I = \emptyset$ ,  $C_k$  is an end-cell of  $J$  and  $E$  is a neighbour cell of  $C_k$ . We may assume that for all  $i \in \{1, \dots, k-2\}$ ,  $C_i$  and  $C_{i+1}$  are neighbours, so  $B_i$  and  $B_{i+1}$  cannot be neighbours. Therefore, using the same considerations as in the above case, we see that  $\mathcal{P}$  is as shown in Figure 4 in the neighbourhood of  $J$ .

(3)  $\mathcal{P}^I = \emptyset$  and  $E$  is an end-cell of  $J$ . Then, in the neighbourhood of  $J$ ,  $\mathcal{P}$  is as shown in Figure 5.

(4)  $\mathcal{P}^I = \emptyset$ ,  $C_k$  is an end-cell of  $J$  and  $E$  is not a neighbour cell of  $C_k$ . Then, in the neighbourhood of  $J$ ,  $\mathcal{P}$  is one of the figures in Figure 6. □

**Discussion 3.4.** By the *first end-cell* of  $J$ , we mean

$$\begin{cases} E, & \text{if } \mathcal{P}^I = \{E\}; \\ I \cap J, & \text{if } \mathcal{P}^I = \emptyset. \end{cases}$$

(Note that in both of the above cases, the cell in question is an end-cell of  $J$ .) We call the other end-cell of  $J$  the *second end-cell* of  $J$ . If  $E$  is the second end-cell of  $J$ , then  $E$  has exactly one neighbour cell. If  $C_k$  is the second end-cell of  $J$  and  $E$  is not a neighbour cell of  $C_k$ , then  $C_k$  has exactly two neighbour cells. If  $C_k$  is the second end-cell of  $J$  and  $E$  is a neighbour cell of  $C_k$ , then  $C_k$  has two or three neighbour cells; see Figures 3, 4, 5 and 6. □

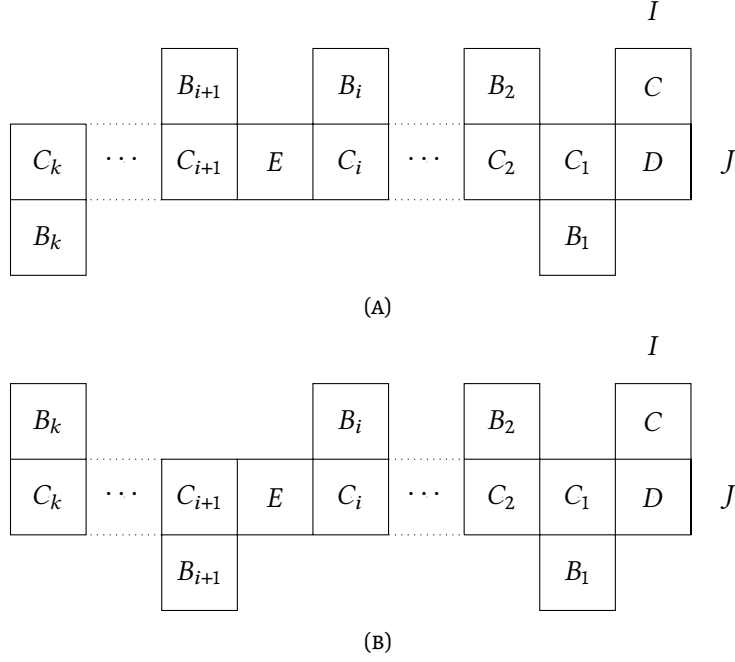

FIGURE 6.  $\mathcal{P}^I$  is empty,  $E$  is not a neighbour of  $C_k$

The next lemma shows that simple thin polyominoes with the S-property have a special collapse datum. See Figure 7 for an example to illustrate that condition (2) of the next lemma cannot be deleted.

**Lemma 3.5.** *Let  $\mathcal{P}$  be a simple thin polyomino with S-property. Assume that  $\mathcal{P}$  is not a cell. Then there exists a collapse datum  $(I, J, \mathcal{P}^I)$  of  $\mathcal{P}$  such that one of the following holds:*

- (1) *The second end-cell of  $J$  has at most two neighbour cells.*
- (2) *If the second end-cell of  $J$  has three neighbour cells, then one of its neighbour cells is both a single cell and an end-cell of the maximal inner interval containing it.*

*Proof.* We proceed by induction on number of cells of  $\mathcal{P}$ . Let  $(I, J, \mathcal{P}^I)$  be a collapse datum of  $\mathcal{P}$ . If the neighbourhood of  $J$  in  $\mathcal{P}$  looks like the ones given in Figures 3, 5 or 6, then (1) holds. Therefore we may assume that we are in the situation of Figure 4. Let  $E$  be the single cell of  $J$ ,  $C_k$  be the second end-cell of  $J$ . We may assume that  $B_k$  and  $B_{k+1}$  as marked in Figure 4 exist.

If  $B_k$  is both a single cell and an end-cell of the maximal inner interval that contains  $\{B_k, C_k, B_{k+1}\}$  then (2) holds. Hence we may assume that either  $B_k$  is not a single cell or it is not an end-cell of the maximal inner interval that contains  $\{B_k, C_k, B_{k+1}\}$ . Similarly for  $B_{k+1}$ . Let

$$\mathcal{P}' = (\mathcal{P} \setminus \{A \in \mathcal{P} : \text{the (unique) path between } A \text{ and } E \text{ does not contain } C_k\}) \cup \{E\}.$$

(E.g., in Figure 4,  $\mathcal{P}'$  is the sub-polyomino comprising  $E$  and the cells reachable from  $E$  through  $C_k$ .) Observe that  $\mathcal{P}'$  is a simple thin polyomino. We first show that  $\mathcal{P}'$  has the S-property. Let  $L$  be a maximal inner interval of  $\mathcal{P}'$ . Then  $L$  is a maximal inner interval of  $\mathcal{P}$  or  $L = \{C_k, E\}$ . In both cases,  $L$  has a unique single cell. Thus,  $\mathcal{P}'$  has the S-property. Also note that  $\mathcal{P}'$  is not a cell. The number of cells in  $\mathcal{P}'$  are strictly less than the number of cells in  $\mathcal{P}$ . Therefore, by induction, there exists a collapse datum  $(I', J', \mathcal{P}'^{I'})$  of  $\mathcal{P}'$  satisfying the assertion of the lemma for  $\mathcal{P}'$ .

Note that  $I' \neq \{C_k, E\}$  and  $J' \neq \{C_k, E\}$ ; therefore  $I'$  and  $J'$  are maximal inner intervals of  $\mathcal{P}$ . Let  $J_1$  be a maximal inner interval of  $\mathcal{P}$  such that  $J_1 \cap I'$  is a cell. Since  $\mathcal{P}$  is simple,  $J_1 \subset \mathcal{P}'$ , so  $J_1$  is a maximal inner interval of  $\mathcal{P}'$ . Hence  $J_1 = J'$ . Note that  $\mathcal{P}'^{I'} \subseteq J'$  and that  $I' \cap J' \notin \mathcal{P}'^{I'}$ . Moreover, since  $J' \neq \{C_k, E\}$ , it follows that  $\{C_k, E\} \subseteq \mathcal{P}' \setminus (I' \cup \mathcal{P}'^{I'})$ ; hence  $\mathcal{P}' \setminus (I' \cup \mathcal{P}'^{I'})$  which equals

$$(\mathcal{P}' \setminus (I' \cup \mathcal{P}'^{I'})) \cup \{A \in \mathcal{P} : \text{the path between } A \text{ and } E \text{ does not contain } C_k\}$$

is a non-empty sub-polyomino of  $\mathcal{P}$ . Hence  $(I', J', \mathcal{P}'^{I'})$  is a collapse datum of  $\mathcal{P}$  that satisfies the assertion of the lemma for  $\mathcal{P}$ .  $\square$

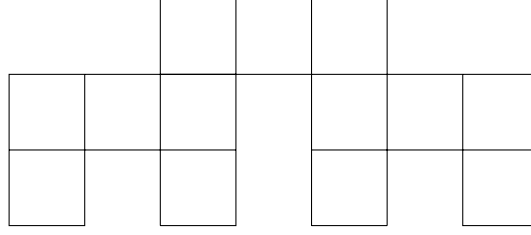

FIGURE 7

$k$	$k$ -rook configurations that have a rook at $C$	number	$k$ -rook configurations that do not have a rook at $C$	number
0	There are no 0-rook configurations that have a rook at $C$	0	$\emptyset$	1
1	$\{C\}$	1	$\{A\}, \{B\}$	2
2	$\{C, A\}$	1	none	0
$k \geq 3$	none	0	none	0
	$r_{P,C}(t)$	$t + t^2$	$r_{P,\widehat{C}}(t)$	$1 + 2t$

TABLE 1. Calculation of  $r_{P,C}(t)$  and  $r_{P,\widehat{C}}(t)$

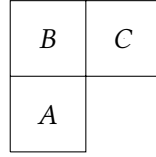

FIGURE 8. Polyomino from Example 3.8

**Discussion 3.6.** Let  $\mathcal{P}$  be a simple thin polyomino and  $C$  be a single cell in  $\mathcal{P}$ . Let  $r_{\mathcal{P},C}(t)$  be the polynomial  $\sum_{k \in \mathbb{N}} r_k t^k$ , where  $r_k$  is the number of  $k$ -rook configurations in  $\mathcal{P}$  that have a rook at  $C$ . Let  $r_{\mathcal{P},\widehat{C}}(t)$  be the polynomial  $\sum_{k \in \mathbb{N}} r_k t^k$ , where  $r_k$  is the number of  $k$ -rook configurations in  $\mathcal{P}$  that have no rook at  $C$ . Then,

$$r_{\mathcal{P}}(t) = r_{\mathcal{P},\widehat{C}}(t) + r_{\mathcal{P},C}(t).$$

Let  $I$  be the maximal inner interval of  $\mathcal{P}$  such that  $C \in I$ . Let  $r_{\mathcal{P},\widehat{I}}(t)$  be the polynomial  $\sum_{k \in \mathbb{N}} r_k t^k$ , where  $r_k$  is the number of  $k$ -rook configurations in  $\mathcal{P}$  that has no rook at any cell of  $I$ . Note that  $r_{\mathcal{P},C}(t) = r_{\mathcal{P},\widehat{I}}(t)t$ . Hence,

$$(3.7) \quad r_{\mathcal{P}}(t) = r_{\mathcal{P},\widehat{C}}(t) + r_{\mathcal{P},\widehat{I}}(t)t. \quad \square$$

**Example 3.8.** We illustrate the above definitions now. Let  $\mathcal{P}$  be the polyomino as shown in the Figure 8. Note that  $C$  is a single cell in  $\mathcal{P}$ . The polynomials  $r_{\mathcal{P},\widehat{C}}(t)$  and  $r_{\mathcal{P},C}(t)$  are calculated in Table 1. The unique maximal inner interval  $I$  containing  $C$  is  $\{B, C\}$ . Hence  $r_{\mathcal{P},\widehat{I}}(t) = 1 + t$ , since this is the rook polynomial of the polyomino consisting of just the cell  $A$ . On the other hand, the number of  $k$ -rook configurations in  $\mathcal{P}$  for  $k = 0, 1, 2$  are, respectively, 1, 3, 1; hence  $r_{\mathcal{P}}(t) = 1 + 3t + t^2$ . We thus see that

$$r_{\mathcal{P}}(t) = r_{\mathcal{P},\widehat{C}}(t) + r_{\mathcal{P},C}(t) = r_{\mathcal{P},\widehat{C}}(t) + r_{\mathcal{P},\widehat{I}}(t)t. \quad \square$$

We now wish to express  $r_{\mathcal{P},\widehat{C}}(t)$  and  $r_{\mathcal{P},\widehat{I}}(t)$  as the rook polynomials of polyominoes when  $\mathcal{P}$  has the S-property.

**Discussion 3.9.** Let  $\mathcal{P}$  be a simple thin polyomino that has the S-property. Let  $(I, J, \mathcal{P}^I)$  be a collapse datum of  $\mathcal{P}$  satisfying the conclusion of Lemma 3.5. Let  $C$  and  $D$  be the cells of  $I$ , with  $C$  being the single cell. Let  $E$  be the single cell of  $J$ . Let  $r_{\mathcal{P},\widehat{C}}(t)$  and  $r_{\mathcal{P},\widehat{I}}(t)$  be as defined in Discussion 3.6.

Write  $Q = \mathcal{P} \setminus \{C\}$ . Then  $r_{\mathcal{P}, \widehat{C}}(t) = r_Q(t)$ . If  $\mathcal{P}^I$  is empty, define  $\mathcal{R}$  to be the polyomino  $\mathcal{P} \setminus I$ . Otherwise, i.e. if  $\mathcal{P}^I$  is a cell  $E$ , define  $\mathcal{R}$  to be the polyomino  $\mathcal{P} \setminus \{C, E\}$ . Then  $r_{\mathcal{P}, \widehat{I}}(t) = r_{\mathcal{R}}(t)$ . Thus (3.7) becomes

$$(3.10) \quad r_{\mathcal{P}}(t) = r_Q(t) + r_{\mathcal{R}}(t)t.$$

Note that  $Q$  does not have the S-property, so we cannot use an inductive argument to prove Theorem 1.2 directly. Hence we need to rewrite  $r_Q(t)$  in terms of smaller polyominoes. To this end, we observe that  $D$  is a single cell of the maximal inner interval  $J$  inside  $Q$ . Therefore, by (3.7),

$$(3.11) \quad r_Q(t) = r_{Q, \widehat{D}}(t) + r_{Q, \widehat{J}}(t)t.$$

We note that

$$(3.12) \quad r_{Q, \widehat{D}}(t) = r_{\mathcal{R}}(t). \quad \square$$

We now find an expression for  $r_{Q, \widehat{J}}(t)$ . Let  $E, C_1, \dots, C_k$  be the other cells of  $J$  in  $\mathcal{P}$ .  $E$  denotes the single cell of  $J$  in  $\mathcal{P}$ . For  $1 \leq i \leq k-1$ , let  $B_i$  be the cell in  $\mathcal{P}$  such that  $B_i \notin J$  and  $C_i$  is a neighbour cell of  $B_i$ . (See Discussion 3.3 and Figures 3, 4, 5, and 6 for notational conventions.) When  $E$  is the second end-cell or  $C_k$  is an end-cell with two neighbour cells, let  $B_k$  be the cell in  $\mathcal{P}$  such that  $B_k \notin J$  and  $C_k$  is a neighbour cell of  $B_k$ . When  $C_k$  is an end-cell with three neighbour cells, let  $B_k$  and  $B_{k+1}$  be the cells in  $\mathcal{P}$  such that  $B_k, B_{k+1} \notin J$  and  $C_k$  is a neighbour cell of  $B_k$  and  $B_{k+1}$ . In the case when  $C_k$  has three neighbour cells, by Lemma 3.5, we may assume that  $B_{k+1}$  is both a single cell and an end-cell of the maximal inner interval containing it.

Now for all  $1 \leq i \leq k-1$ , define

$$Q_i := \{A \in Q : \text{the path between } A \text{ and } B_i \text{ does not contain } C_i\}.$$

Also, define

$$\widetilde{Q}_k := \{A \in Q : \text{the path between } A \text{ and } B_k \text{ does not contain } C_k\}.$$

When  $E$  is the second end-cell or  $C_k$  is an end-cell with two neighbour cells, define  $Q_k = \widetilde{Q}_k$ . When  $C_k$  is an end-cell with three neighbour cells, let  $\{a, b, a', b'\}$  be the vertices of  $C_k$  where  $a, b \in V(B_k)$  and  $a', b' \in V(B_{k+1})$ . We define  $Q_k$  as the polyomino obtained from  $\widetilde{Q}_k \cup \{B_{k+1}\}$  by the identification of the vertices  $a$  and  $b$  of  $V(B_k)$  with the vertices  $a'$  and  $b'$  of  $V(B_{k+1})$ , respectively, by translating the cell  $B_{k+1}$ .

**Lemma 3.13.** *With notation as above, we have the following:*

- (1)  $Q_1, \dots, Q_k$  are precisely the connected components of  $Q \setminus J$ .
- (2) For each  $1 \leq i \leq k$ ,  $Q_i$  is a simple thin polyomino with the S-property.
- (3)  $r_{Q, \widehat{J}}(t) = \prod_{i=1}^k r_{Q_i}(t)$  and  $\sum_{i=1}^k r(Q_i) = r(\mathcal{P}) - 2$ .

*Proof.* (1): Each  $Q_i$  is connected,  $Q_i \cap Q_j = \emptyset$  for all  $i \neq j$  (since  $\mathcal{P}$  is simple) and  $Q \setminus J = Q_1 \cup \dots \cup Q_k$ .

(2): Since  $Q$  is simple thin, so is  $Q_i$ . Let  $L$  be a maximal inner interval of  $Q_i$ . Then, either  $L$  is a maximal inner interval of  $\mathcal{P}$  or  $L = L' \setminus \{C_i\}$ , where  $L'$  is a maximal inner interval of  $\mathcal{P}$ . In both cases,  $L$  has a unique single cell. Hence  $Q_i$  has the S-property.

(3): By (1)  $r_{Q, \widehat{J}}(t)$  is the rook polynomial of  $Q \setminus J$ . Thus, by Proposition 3.1,  $r_{Q, \widehat{J}}(t) = \prod_{i=1}^k r_{Q_i}(t)$ . For any  $k$ -rook configuration  $\alpha$  of  $Q \setminus J$ , we note that  $\alpha \cup \{C, E\}$  is a  $(k+2)$ -rook configuration of  $\mathcal{P}$ . Hence  $\sum_{i=1}^k r(Q_i) \leq r(\mathcal{P}) - 2$ . On the other hand, let  $\beta$  be a  $r(\mathcal{P})$ -rook configuration of  $\mathcal{P}$ . Since  $\mathcal{P}$  has the S-property,  $\beta$  is the only  $r(\mathcal{P})$ -rook configuration of  $\mathcal{P}$  and  $\beta$  is the collection of all single cells of  $\mathcal{P}$ . Then,  $\beta \setminus \{C, E\}$  is a rook configuration of  $Q \setminus J$ . Therefore  $\sum_{i=1}^k r(Q_i) \geq r(\mathcal{P}) - 2$ .  $\square$

We are now ready to prove Theorem 1.2.

*Proof of the Theorem.* By Proposition 3.1, we may assume that  $\mathcal{P}$  is a simple thin polyomino with the S-property. Let  $h_{\mathbb{k}[\mathcal{P}]} / (1-t)^{\dim(\mathbb{k}[\mathcal{P}])}$  be the Hilbert series of  $\mathbb{k}[\mathcal{P}]$ . By [RR21, Theorem 1.1],  $h_{\mathbb{k}[\mathcal{P}]}(t) = r_{\mathcal{P}}(t)$ . We proceed by induction on the rook number  $r(\mathcal{P})$ . If  $r(\mathcal{P})$  is odd (in particular if  $r(\mathcal{P}) = 1$ ), then  $r_{\mathcal{P}}(-1) = 0$ . Hence we may assume that  $r(\mathcal{P})$  is even. Let  $(I, J, \mathcal{P}^I)$  be a collapse datum of  $\mathcal{P}$  satisfying the conclusion of Lemma 3.5. Apply Discussion 3.9, adopting its notation. Let  $Q$  and  $\mathcal{R}$  be as in Discussion 3.9. Then, by (3.10)

$$r_{\mathcal{P}}(t) = r_Q(t) + r_{\mathcal{R}}(t)t.$$

Now apply Discussion 3.6 to the single cell  $D$  of the maximal inner interval  $J$  of  $Q$ . By (3.11), (3.12) and Lemma 3.13, we see that

$$r_{\mathcal{P}}(t) = (1+t)r_{\mathcal{R}}(t) + t \prod_{i=1}^k r_{Q_i}(t).$$

By Lemma 3.13 and induction hypothesis,  $\mathbb{k}[Q_i]$  is CD for all  $1 \leq i \leq k$ . If  $r(Q_i)$  is odd for some  $i$ , then  $r_{\mathcal{P}}(-1) = 0$ . Therefore we may assume that  $r(Q_i)$  is even for all  $i$ .

$$\begin{aligned} (-1)^{\lfloor \frac{r(\mathcal{P})}{2} \rfloor} r_{\mathcal{P}}(-1) &= (-1)^{\frac{r(\mathcal{P})}{2}+1} \prod_{i=1}^k r_{Q_i}(-1) \\ &= (-1)^{\frac{r(\mathcal{P})-2}{2}} \prod_{i=1}^k r_{Q_i}(-1) \\ &= \prod_{i=1}^k (-1)^{\frac{r(Q_i)}{2}} r_{Q_i}(-1) && \text{by Lemma 3.13} \\ &\geq 0 && \text{by induction.} \end{aligned}$$

This completes the proof of the theorem. □

#### REFERENCES

- [BH93] W. Bruns and J. Herzog. *Cohen-Macaulay rings*, volume 39 of *Cambridge Studies in Advanced Mathematics*. Cambridge University Press, Cambridge, 1993.
- [Brä04] P. Brändén. Sign-graded posets, unimodality of  $W$ -polynomials and the Charney-Davis conjecture. *Electron. J. Combin.*, 11(2):Research Paper 9, 15, 2004/06.
- [CD95] R. Charney and M. Davis. The Euler characteristic of a nonpositively curved, piecewise Euclidean manifold. *Pacific J. Math.*, 171(1):117–137, 1995.
- [1] D'Alì, A. and Venturello, L. (2021). Koszul Gorenstein algebras from Cohen-Macaulay simplicial complexes. arXiv:2106.05051 [math.AC].
- [QSS17] A. A. Qureshi, T. Shibuta, and A. Shikama. Simple polyominoes are prime. *J. Commut. Algebra*, 9(3):413–422, 2017.
- [Qur12] A. A. Qureshi. Ideals generated by 2-minors, collections of cells and stack polyominoes. *J. Algebra*, 357:279–303, 2012.
- [RR21] G. Rinaldo and F. Romeo. Hilbert series of simple thin polyominoes. *J. Algebraic Combin.*, 54:607–624, 2021.
- [RW05] V. Reiner and V. Welker. On the Charney-Davis and Neggers-Stanley conjectures. *J. Combin. Theory Ser. A*, 109(2):247–280, 2005.
- [Sta97] R. P. Stanley. *Enumerative combinatorics. Vol. 1*, volume 49 of *Cambridge Studies in Advanced Mathematics*. Cambridge University Press, Cambridge, 1997. With a foreword by Gian-Carlo Rota, Corrected reprint of the 1986 original.
- [Sta00] R. P. Stanley. Positivity problems and conjectures in algebraic combinatorics. In *Mathematics: frontiers and perspectives*, pages 295–319. Amer. Math. Soc., Providence, RI, 2000.

CHENNAI MATHEMATICAL INSTITUTE, SIRUSERI, TAMILNADU 603103. INDIA  
Email address: mkummini@cmi.ac.in

CHENNAI MATHEMATICAL INSTITUTE, SIRUSERI, TAMILNADU 603103. INDIA  
Email address: dharm@cmi.ac.in