

Traveling waves of a generalized Rotation-Camassa-Holm equation with the Coriolis effect

N'Gbo N'Gbo ^{1*} Yonghui Xia^{2†} Tonghua Zhang^{3‡}

1. Department of Mathematics, Shanghai University, Shanghai, 200444, P.R. China

2. Department of Mathematics, Zhejiang Normal University, Jinhua, Zhejiang, 321004, P. R. China

3. Department of Mathematics, Swinburne University of Technology, Hawthorn, Victoria, 3122, Australia

February 25, 2022

Abstract

In this paper, we analyze the dynamics of a generalized Rotation-Camassa-Holm equation, which is the θ -equation augmented with the Coriolis effect, induced by the earth rotation. The generalized Rotation-Camassa-Holm equation (named as Rotation- θ equation) is a generalization of a family of models (including the Rotation-Camassa-Holm equation for $\theta = \frac{1}{3}$, asymptotic Rotation-Camassa-Holm equation for $\theta = 1$ and the Rotation-Degasperis-Procesi (DP) equation for $\theta = \frac{1}{4}$). Our study is conducted via the bifurcation method and qualitative theory of dynamical systems. The existence of not only smooth solitary wave solutions, periodic wave solutions, but also peakons and periodic peakon solutions is shown. The chosen values θ , allow us to assess the difference in behavior between the classical θ -equation and the Rotation- θ equation. We conclude that the Coriolis effect does affect the traveling wave solutions. We summarize the bifurcations and explicit expressions of waves solutions in three theorems in Section 4. A conclusion ends the paper.

*npaulrene2@outlook.com

†Corresponding author. Yonghui Xia, yhxia@zjnu.cn, xiadoc@163.com

‡tonghuazhang@swin.edu.au

Keywords: Rotation-Camassa-Holm equation; solitary wave solution; periodic wave solution; peakon solution; periodic peakon solution.

1 Introduction

The Coriolis force is an inertial force acting on objects that are in motion within a frame of reference. The deflection of an object due to the Coriolis force is called the Coriolis effect. The Coriolis effect is caused by the rotation of the Earth and is known to perturb wave propagation. In 1993, Camassa and Holm [Camassa & Holm, 1993], derived the famous classical Camassa-Holm (CH) equation, as a model for shallow-water waves. The model is formulated as follow:

$$u_t + 2\lambda u_x - u_{xxt} + 3uu_x = 2u_x u_{xx} + uu_{xxx}, \quad (1.1)$$

where $x \in \mathbb{R}$, $t > 0$, and u , the velocity field, is a function of the position x at time t (see [Lui, 2008]). We write $u(x, t)$, depicting the water's free surface over a flat bottom. u_x and u_t are the partial derivatives of u , with respect of x and t .

The extensive literature on the CH-equation contains investigations of every-other aspects of the models via countless methods. For examples, Constantin and Bressan [Bressan & Constantin, 2006] utilized a transformation method to obtain global conservative solutions for the CH equation. The significance of the CH and DP equations as shallow water waves models was proven in [Constantin & Lannes, 2008]. The scattering problem of the CH equation was considered in [Constantin, 2008]. Wei et al [Wei et al., 2018] studied the travelling wave solutions for a generalized CH equation using the bifurcation method of dynamical system. Further, Du et al [Du et al., 2018] proved the existence of solitary wave solutions for a delayed CH equation by geometrical approach. Furthermre, Ge and De [Ge and Du, 2018] studied the shallow water wave equation by singular perturbation approach. Most recently, Chu et al [Chu et al., 2020] considered the spectral problem for a modified CH equation. Sun et al [Sun et al., 2020] proved coexistence of the solitary and periodic waves in convecting shallow water fluid.

The importance of the CH equation in fluid dynamics is due to its remarkable

properties. Among which, conservation laws, integrability, peakons, soliton solutions [Camassa & Holm, 1993, Bressan & Constantin, 2006]. Gui et al. and Luo et al. in [Gui et al., 2018, Gui et al., 2019, Chen et al., 2018, Luo et al., 2019] derived a series of shallow-water waves equations with the Coriolis effect, namely, the Rotation-Green-Naghdi (R-GN), the Rotation-Korteweg-De Vries (R-KdV) and Rotation-Camassa-Holm (R-CH) equations. The R-CH equation reads,

$$\begin{cases} m_t + um_x + 2u_x m + ku_x - \frac{\beta_0}{\beta} u_{xxx} + \frac{\omega_1}{\alpha^2} u^2 u_x + \frac{\omega_2}{\alpha^3} u^3 u_x = 0, & x \in \mathbb{R}, t > 0, \\ m = u - u_{xx}, \end{cases} \quad (1.2)$$

where the constants appearing in the equation are defined as: $k = \sqrt{1 + \Omega^2} - \Omega$, $\alpha = \frac{k}{1+k^2}$, $\beta_0 = \frac{k(k^4+6k^2-1)}{6(k^2+1)}$, $\beta = \frac{3k^4+8k^2-1}{6(k^2+1)}$, $\omega_1 = \frac{-3k(k^2-1)(k^2-2)}{2(1+k^2)^3}$, $\omega_2 = \frac{(k^2-2)(k^2-1)^2(8k^2-1)}{2(1+k^2)^5}$, and Ω is the Coriolis frequency caused by the Earth rotation ([Ni et al., 2011][Chu et al., 2020]). System (1.2) is analogous to the CH-equation, but describing the motion of the fluid with the Coriolis effect from the incompressible and irrotational two-dimensional shallow-water in the equatorial region. For more details on the equatorial waves modeling and dynamics, one can refer to [Chu & Wang, 2020, Constantin, 2012, Constantin & Johnson, 2008, Kirbi et al., 2013, Constantin, 2012, Constantin & Germain, 2013, Hsu, 2015]. We notice that, without the Coriolis effect (i.e. $\Omega = 0$), we have the classical Camassa-Holm with λ equal to one. In [Tu et al., 2019], the authors proved the global existence and uniqueness of the energy conservative weak solutions in the energy space H^1 of system (1.2). Moreover, Fan et al [Fan & Yuen, 2019] obtained peakon weak solutions for the two component R-CH-equation formulated in [Fan, Gao, & Liu, 2016]. Recently, Liang et al [Liang et al., 2020] analyzed the bifurcations and exact solutions of an asymptotic R-CH equation considered in [Constantin & Lannes, 2009].

The study of the CH-equation brought forward many generalizations of the model. Following these ideas, Liu [Liu, 2008] derived a type of nonlocal dispersive models, namely, the θ -equation:

$$\begin{cases} m_t + \theta um_x + (1 - \theta)u_x m = 0, \\ m = u - u_{xx}. \end{cases} \quad (1.3)$$

It is easy to see that for $\theta = \frac{1}{3}$ and $\theta = \frac{1}{4}$, the θ -equation, respectively, becomes the CH and DP [Degasperis & Procesi, 1999] equations. Wen [Wen, 2014] will later study the bifurcations of traveling wave solutions of Eq. (1.3).

Motivated by the aforementioned researches, we aim to investigate the behavior of the θ -equation, at the equator neighborhood by mean of the transformation technique of dynamical system ([Li, 2013, Li, 2019, Zhang, et al., 2021, Zhang & Li, 2017, Du & Qiao, 2020, Song & Tang, 2017, Sun & Yu, 2019]). In this paper, we study the Rotation- θ equation (θ -equation augmented with the Coriolis effect) taking the form of:

$$\begin{cases} m_t + \theta um_x + (1 - \theta)u_x m + ku_x - \frac{\beta_0}{\beta} u_{xxx} + \frac{\omega_1}{\alpha^2} u^2 u_x + \frac{\omega_2}{\alpha^3} u^3 u_x = 0, & x \in \mathbb{R}, t > 0, \\ m = u - u_{xx}, & x \in \mathbb{R}. \end{cases} \quad (1.4)$$

Notice that, for $\theta = \frac{1}{3}$, system (1.4) is exactly the Rotation-CH considered in [Gui et al., 2018].

For $\theta = 1$, system (1.4) reduces to the asymptotic Rotation-CH considered in [Liang et al., 2020].

For $\theta = \frac{1}{4}$, system (1.4) reduces to the Rotation-Degasperis-Procesi equation. To study the travelling wave of (1.4), we transform the partial differential equation (PDE) to an ordinary differential equation (ODE). We introduce the new variable ξ such that $\xi = x - ct$ with c denoting the wave speed. Next, we let $u(x, t) = \phi(\xi)$. Substituting $u(x, t)$ in system (1.4), we obtain

$$-c\phi_\xi + c\phi_{\xi\xi\xi} + \phi\phi_\xi + k\phi_\xi - \frac{\beta_0}{\beta}\phi_{\xi\xi\xi} + \frac{\omega_1}{\alpha^2}\phi^2\phi_\xi + \frac{\omega_2}{\alpha^3}\phi^3\phi_\xi = (1 - \theta)\phi_\xi\phi_{\xi\xi} + \theta\phi\phi_{\xi\xi\xi}. \quad (1.5)$$

Integrating Eq. (1.5) once, taking the integration constant null, leads to

$$-c\phi + c\phi_{\xi\xi} + \frac{1}{2}\phi^2 + k\phi - \frac{\beta_0}{\beta}\phi_{\xi\xi} + \frac{\omega_1}{3\alpha^2}\phi^3 + \frac{\omega_2}{4\alpha^3}\phi^4 = \frac{1}{2}(1 - 2\theta)(\phi_\xi)^2 + \theta\phi\phi_{\xi\xi}. \quad (1.6)$$

For convenience, we set $C_1 = c - \frac{\beta_0}{\beta}$, $C_2 = \frac{\omega_1}{3\alpha^2}$, $C_3 = \frac{\omega_2}{4\alpha^3}$, and $K = -c + k$.

Then, we pose $\frac{d\phi}{d\xi} = y$ and obtain the planar system

$$\begin{cases} \frac{d\phi}{d\xi} = y, \\ \frac{dy}{d\xi} = \frac{(\theta - \frac{1}{2})y^2 + C_3\phi^4 + C_2\phi^3 + \frac{1}{2}\phi^2 + K\phi}{\theta\phi - C_1}. \end{cases} \quad (1.7)$$

Subsequently, we derive the first integral of system (1.7). From system (1.7), we write

$$[(\theta - \frac{1}{2})y^2 + C_3\phi^4 + C_2\phi^3 + \frac{1}{2}\phi^2 + K\phi]d\phi - (\theta\phi - C_1)ydy = 0. \quad (1.8)$$

Multiplying Eq.(1.8) by the integrating factor $\mu(\phi) = (\phi - \frac{C_1}{\theta})^{(\frac{1-3\theta}{\theta})}$, we obtain the exact ordinary differential equation

$$[(\theta - \frac{1}{2})y^2 + C_3\phi^4 + C_2\phi^3 + \frac{1}{2}\phi^2 + K\phi](\phi - \frac{C_1}{\theta})^{(\frac{1-3\theta}{\theta})}d\phi - \theta(\phi - \frac{C_1}{\theta})^{(\frac{1-2\theta}{\theta})}ydy = 0. \quad (1.9)$$

Therefore, we have

$$H(\phi, y) = \int -\theta(\phi - \frac{C_1}{\theta})^{(\frac{1-2\theta}{\theta})}ydy \quad (1.10)$$

$$= -\frac{1}{2}\theta(\phi - \frac{C_1}{\theta})^{(\frac{1-2\theta}{\theta})}y^2 + p(\phi). \quad (1.11)$$

We easily get, $p'(\phi) = (C_3\phi^4 + C_2\phi^3 + \frac{1}{2}\phi^2 + K\phi)(\phi - \frac{C_1}{\theta})^{(\frac{1-3\theta}{\theta})}$. It follows,

$$p(\phi) = \int (C_3\phi^4 + C_2\phi^3 + \frac{1}{2}\phi^2 + K\phi)(\phi - \frac{C_1}{\theta})^{(\frac{1-3\theta}{\theta})}d\phi. \quad (1.12)$$

In the above equation, set $m = \frac{1-3\theta}{\theta}$ with $m \in \mathbb{Z}$. Finally, we arrive at the general first integral of system (1.7):

$$\begin{aligned} H(\phi, y) = & -\frac{1}{2}\theta y^2(\phi - \frac{C_1}{\theta})^{m+1} + C_3 \sum_{n=0}^m \frac{\binom{m}{n}\phi^{m-n+5}(\frac{C_1}{\theta})^n}{m-n+5} \\ & + C_2 \sum_{n=0}^m \frac{\binom{m}{n}\phi^{m-n+4}(\frac{C_1}{\theta})^n}{m-n+4} + \frac{1}{2} \sum_{n=0}^m \frac{\binom{m}{n}\phi^{m-n+3}(\frac{C_1}{\theta})^n}{m-n+3} \\ & + K \sum_{n=0}^m \frac{\binom{m}{n}\phi^{m-n+2}(\frac{C_1}{\theta})^n}{m-n+2}, \end{aligned} \quad (1.13)$$

where $\binom{m}{n} = \frac{m!}{(m-n)!}$ is the binomial coefficient. One can verify that for $m = 0$, i.e. $\theta = \frac{1}{3}$. Eq.(1.13) only differs from the first integral in [Liang et al., 2020] by the value of certain parameters. Thereafter, we consider the cases of $\theta = \frac{1}{4}$, $\theta = \frac{1}{2}$, $\theta = 1$ in this paper.

The rest of our work is conducted as follows. In section 2, we present the bifurcations of phase portraits of system (1.7) and classification of equilibria based on the theory of dynamical systems. In section 3, dynamics of traveling wave solutions are discussed. The main results are given in Section 4. Lastly, a conclusion ends the paper.

2 Bifurcations of Phase Portraits of system (1.7)

2.1 Case of $\theta = \frac{1}{4}$

If $\theta = \frac{1}{4}$, then system (1.7) takes the form

$$\begin{cases} \frac{d\phi}{d\xi} = y, \\ \frac{dy}{d\xi} = \frac{-\frac{1}{4}y^2 + C_3\phi^4 + C_2\phi^3 + \frac{1}{2}\phi^2 + K\phi}{\frac{1}{4}\phi - C_1}, \end{cases} \quad (2.1)$$

with the corresponding Hamiltonian:

$$\begin{aligned} H(\phi, y) = & -\frac{1}{8}(\phi - 4C_1)^2 y^2 + \frac{C_3}{6}\phi^6 + \frac{1}{5}(C_2 - 4C_1C_3)\phi^5 \\ & + (\frac{1}{8} - C_1C_2)\phi^4 + \frac{1}{3}(K - 2C_1)\phi^3 - 2C_1K\phi^2 = h. \end{aligned} \quad (2.2)$$

Imposing the transformation $d\xi = (\theta\phi - C_1)d\tau$, the system (2.1) becomes the regular system

$$\begin{cases} \frac{d\phi}{d\tau} = y(\frac{1}{4}\phi - C_1), \\ \frac{dy}{d\tau} = -\frac{1}{4}y^2 + C_3\phi^4 + C_2\phi^3 + \frac{1}{2}\phi^2 + K\phi. \end{cases} \quad (2.3)$$

The difference between the systems (2.1) and (2.3) is in the dynamical behavior at the singular line $\phi = \frac{C_1}{\theta}$.

2.1.1 Qualitative analysis of singular points of system (2.3)

We investigate the equilibrium points of the system (2.3).

The point (0,0) is an obvious equilibrium of the system (2.3). On the line $\phi = 4C_1$, we have two equilibrium points $y_{\pm} = \pm 2\sqrt{f(4C_1)}$ for $f(4C_1) > 0$. To identify the other equilibrium points of system (2.3), we write

$$f(\phi) = C_3\phi^4 + C_2\phi^3 + \frac{1}{2}\phi^2 + K\phi = \phi * g(\phi), \quad (2.4)$$

where

$$g(\phi) = C_3\phi^3 + C_2\phi^2 + \frac{1}{2}\phi + K. \quad (2.5)$$

$f(\phi) = 0$ for $\phi = 0$ or $g(\phi) = 0$.

We obtain,

$$g'(\phi) = 3C_3\phi^2 + 2C_2\phi + \frac{1}{2} \quad (2.6)$$

and

$$g''(\phi) = 6C_3\phi + 2C_2. \quad (2.7)$$

Notice that, $g(0) = K$, $g'(0) = \frac{1}{2}$. Additionally, $\Delta_{g'} = 4C_2^2 - 6C_3$. Assuming $C_3 < 0$ and $\Delta_{g'} > 0$. $g'(\phi)$ admits two zeros denoted $\tilde{\phi}_{\pm} = \frac{-2C_2 \pm \sqrt{\Delta}}{6C_3}$, with $g''(\tilde{\phi}_-) > 0$ and $g''(\tilde{\phi}_+) < 0$.

So $g(\phi)$ has at most 3 zeros denoted $\phi_n, n = 1, 2, 3$.

Thus, we have the following conclusions:

1. When $K \neq 0$, and $\Delta_{g'} > 0$,

(i) if $g(\tilde{\phi}_+) < 0$, then $g(\phi)$ has only one zero, and system (2.3) admits four equilibrium points, $E_0(0, 0)$, $E(\phi^*, 0)$ and $S_{\pm}(4C_1, y_{\pm})$.

(ii) if $g(\tilde{\phi}_+) = 0$, then $g(\phi)$ has a simple zero and a double zero. System (2.3) admits five equilibrium points $E_0(0, 0)$, $E_i(\phi_i, 0)$, $n = 1, 2$ and $S_{\pm}(4C_1, y_{\pm})$.

(iii) if $g(\tilde{\phi}_-) < 0$ and $g(\tilde{\phi}_+) > 0$, then $g(\phi)$ has three simple zeros and the system (2.3) admits six equilibrium points, $E_0(0, 0)$, $E_i(\phi_i, 0)$, $n = 1, 2, 3$ and $S_{\pm}(4C_1, y_{\pm})$.

(iv) if $g(\tilde{\phi}_-) = 0$, then $g(\phi)$ has a simple zero and a double zero. System (2.3) admits five equilibrium points, $E_0(0, 0)$, $E(\phi^*, 0)$ and $S_{\pm}(4C_1, y_{\pm})$.

(v) if $g(\tilde{\phi}_-) > 0$, then $g(\phi)$ has only one zero, and system (2.3) admits four equilibrium points, $E_0(0, 0)$, $E(\phi^*, 0)$ and $S_{\pm}(4C_1, y_{\pm})$.

2. When $K \neq 0$, for $\Delta_{g'} = 0$ and $\Delta_{g'} < 0$, $g(\phi)$ admits only one zero, the conclusion are similar to (1-i) and (1-v).

3. When $K = 0$, if

(i) $C_2^2 > 2C_3$, then the system (2.3) admits five equilibrium points, $E_0(0, 0)$, $E_{1,2}(\phi_{1,2}, 0)$ and $S_{\pm}(4C_1, y_{\pm})$.

(ii) $C_2^2 = 2C_3$, then the system (2.3) admits four equilibrium points, $E_0(0, 0)$, $E(\phi, 0)$ and $S_{\pm}(4C_1, y_{\pm})$.

(iii) $C_2^2 < 2C_3$, then the system (2.3) admits three equilibrium points, $E_0(0, 0)$ and $S_{\pm}(4C_1, y_{\pm})$.

We only consider the cases 1(i)-(v) and 3(i), then Fig.1 directly follows

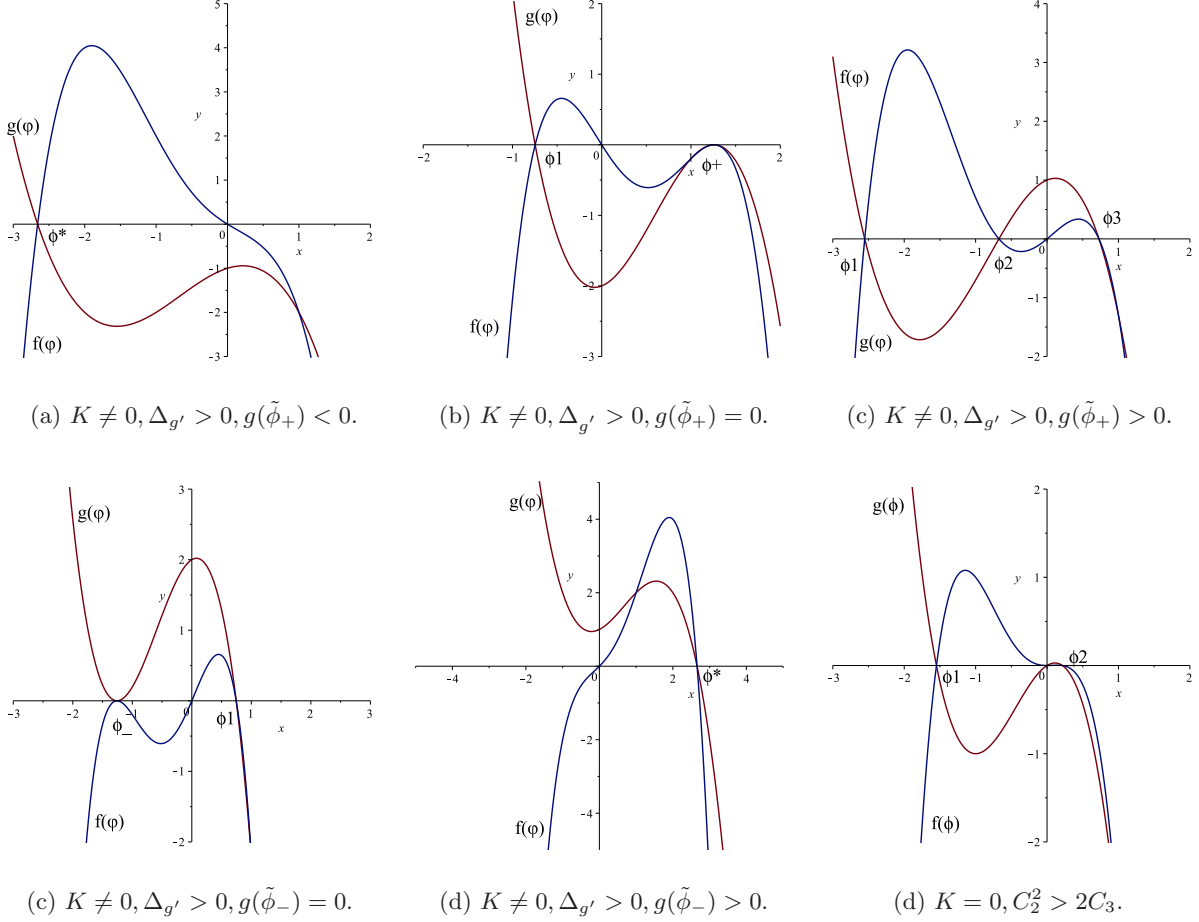

Fig.1. Cases 1(i)-(v) and 3(i)

2.1.2 Classification of singular points and phase portraits of system (2.3)

Let $M_1(\phi, y)$ be the matrix of the linearized system of (2.3),

$$M_1(\phi, y) = \begin{pmatrix} \frac{1}{4}y & \frac{1}{4}\phi - C_1 \\ f'(\phi) & -\frac{1}{2}y \end{pmatrix}. \quad (2.8)$$

with

$$J_1(\phi, y) = \det M = -\frac{1}{8}y^2 - \left(\frac{1}{4}\phi - C_1\right)f'(\phi) \quad (2.9)$$

Particularly,

$$J_1(4C_1, y_{\pm}) = -\frac{1}{8}(y_{\pm})^2 \quad (2.10)$$

and

$$J_1(\phi_i, 0) = -\left(\frac{1}{4}\phi_i - C_1\right)f'(\phi_i) \quad (2.11)$$

Based on the theory of planar dynamical system (see[Li, 2013]), for an equilibrium point of a planar integrable system, the equilibrium point is a saddle point if $J < 0$; the equilibrium point is a center point (a node point) if $J > 0$ and $(trM)^2 - 4J < (>)0$; the equilibrium point is a cusp if $J = 0$ and the Poincaré index of the equilibrium point is 0. For example, when they exist, the singular points y_{\pm} are always saddle points.

Let $h_i = H(\phi_i, 0)$, $h_0 = H(0, 0)$ and $h_s = H(4C_1, y_{\pm})$, where H is given by (2.2). For the aforementioned cases, we let the singular line $\phi = 4C_1$ move from right to left in the (ϕ, y) -phase plane and obtain the following topological phase portraits of system (2.3) (see Fig.2-Fig.6).

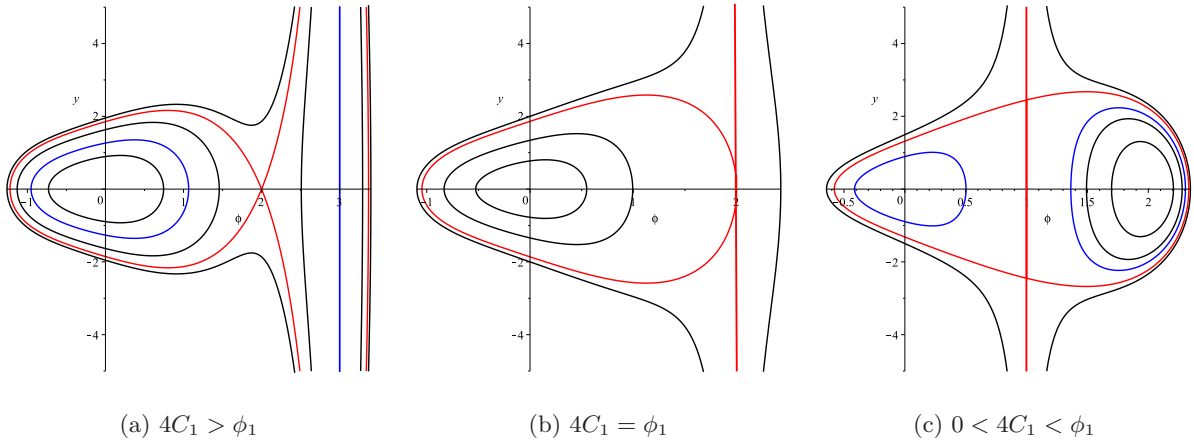

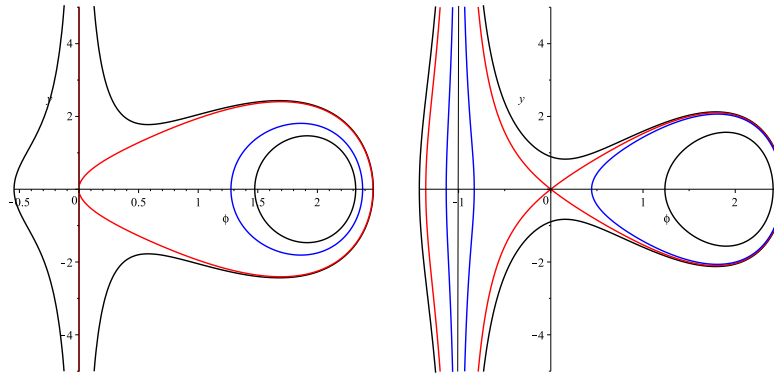

(d) $4C_1 = 0$

(e) $4C_1 < 0$

Fig.2 The function $g(\phi)$ admits only one zero, i.e $(\Delta_g) > 0$ and $g(\phi_-) > 0$.

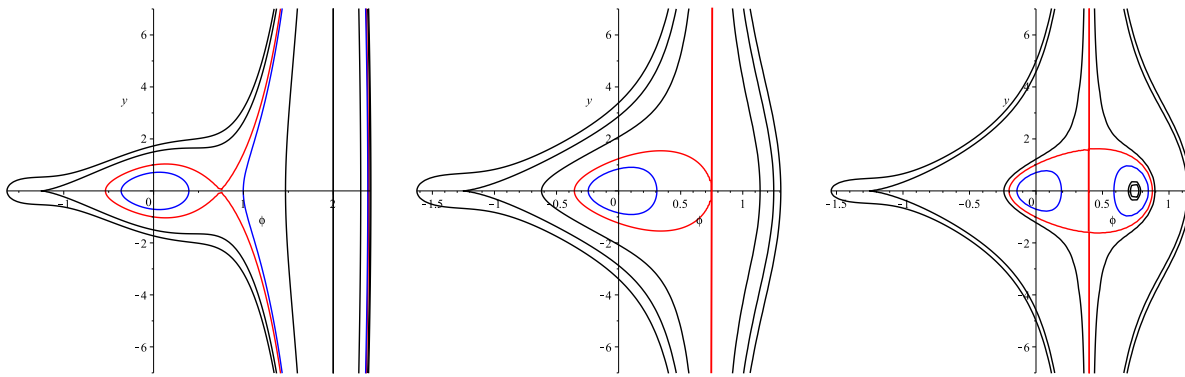

(a) $4C_1 > \phi_1$

(b) $4C_1 = \phi_1$

(c) $0 < 4C_1 < \phi_1$

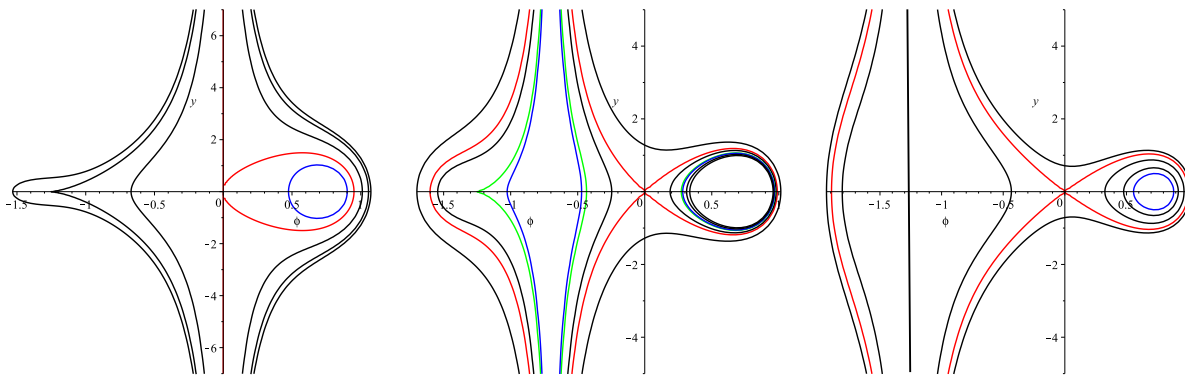

(d) $4C_1 = 0$

(e) $\phi_2 < 4C_1 < 0$

(f) $4C_1 = \phi_2$

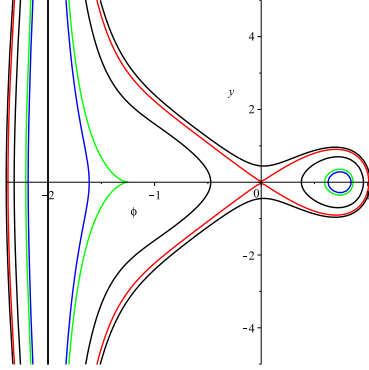

(g) $4C_1 < \phi_2$

Fig.3 The function $g(\phi)$ admits a double zero, and $\tilde{\phi}_- < 0 < \phi_1$.

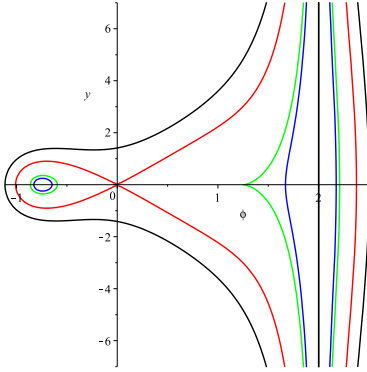

(a) $4C_1 > \phi_1$

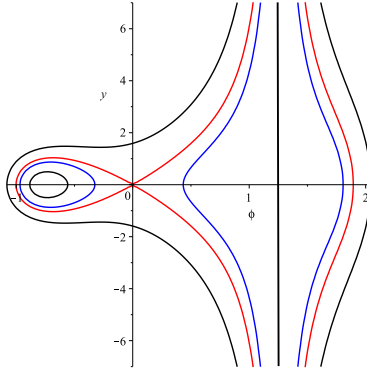

(b) $4C_1 = \phi_1$

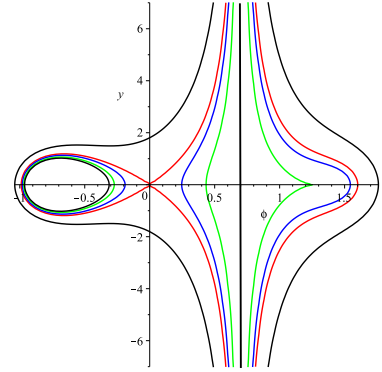

(c) $0 < 4C_1 < \phi_1$

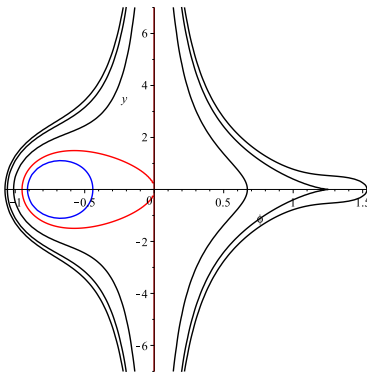

(d) $4C_1 = 0$

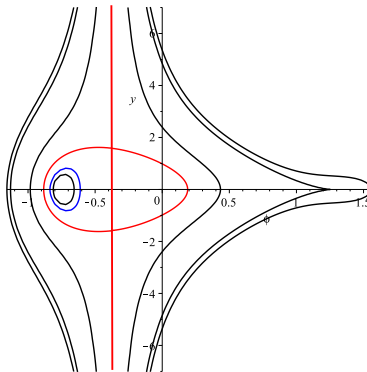

(e) $\phi_2 < 4C_1 < 0$

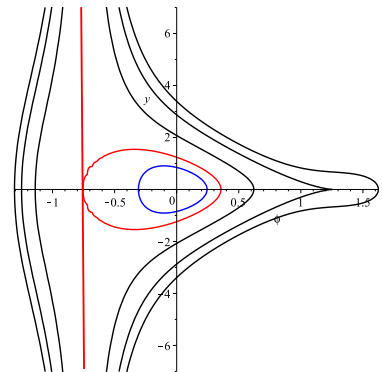

(f) $4C_1 = \phi_2$

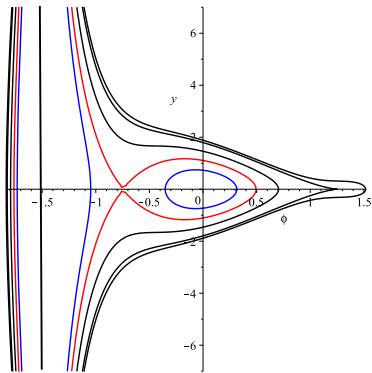

(g) $4C_1 < \phi_2$

Fig.4 The function $g(\phi)$ admits a double zero, and $\phi_1 < 0 < \tilde{\phi}_+$.

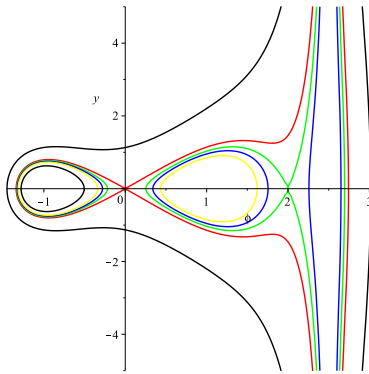

(a) $4C_1 > \phi_1$

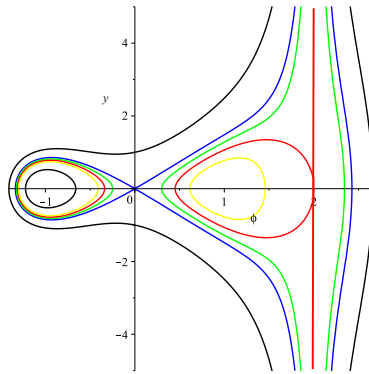

(b) $4C_1 = \phi_1$

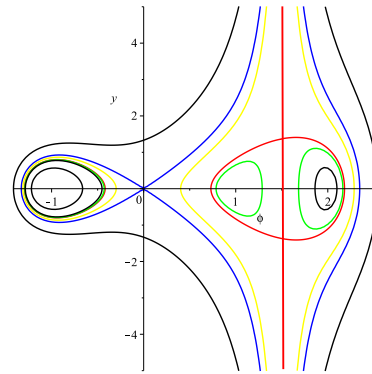

(c) $0 < 4C_1 < \phi_1$

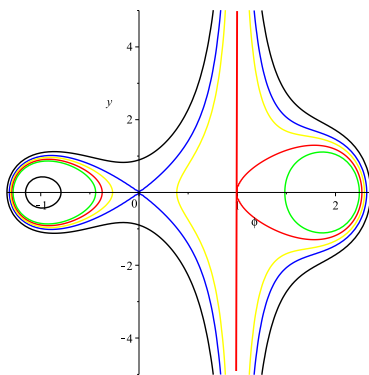

(d) $4C_1 = 0$

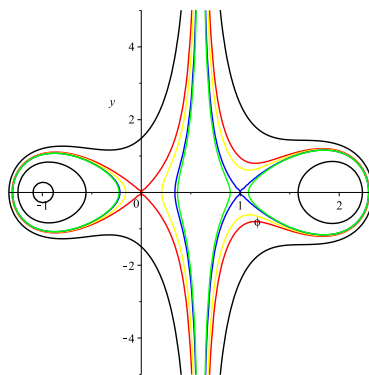

(e) $\phi_2 < 4C_1 < 0$

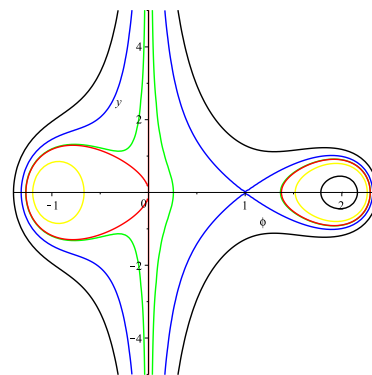

(f) $4C_1 = \phi_2$

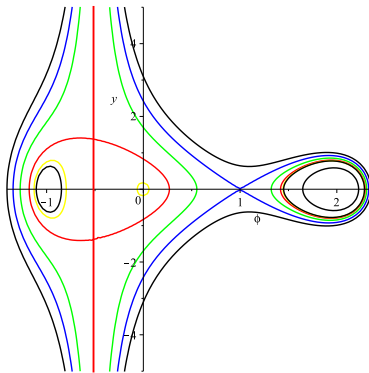

(g) $\phi_3 < 4C_1 < \phi_2$

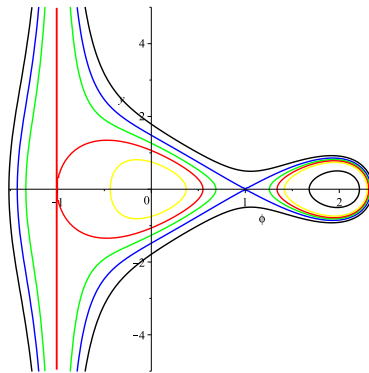

(h) $4C_1 = \phi_3$

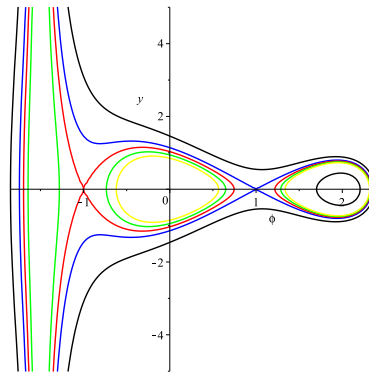

(i) $4C_1 < \phi_3$

Fig.5 The function $g(\phi)$ admits three real zeros and $\phi_1 < \phi_2 < 0 < \phi_3$.

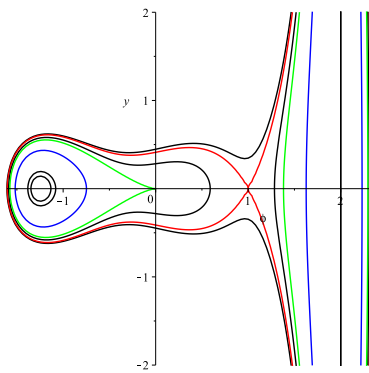

(a) $4C_1 > \phi_1$

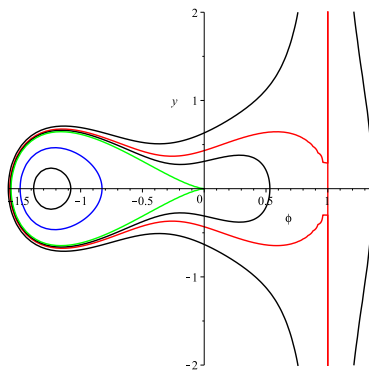

(b) $4C_1 = \phi_1$

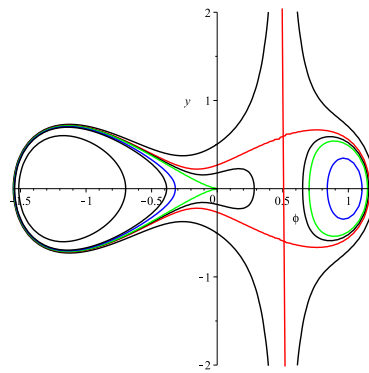

(c) $0 < 4C_1 < \phi_1$

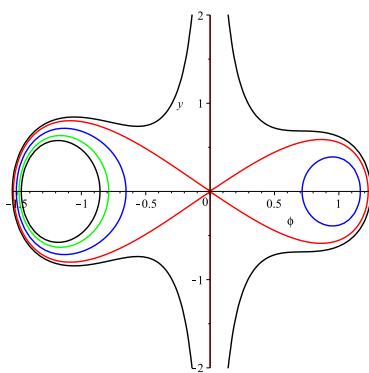

(d) $4C_1 = 0$

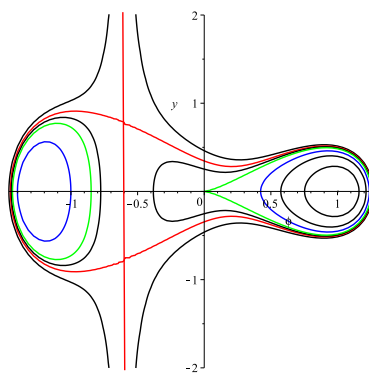

(e) $\phi_2 < 4C_1 < 0$

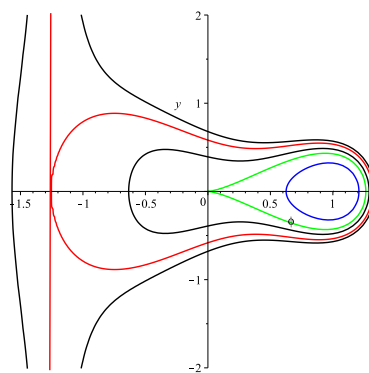

(f) $4C_1 = \phi_2$

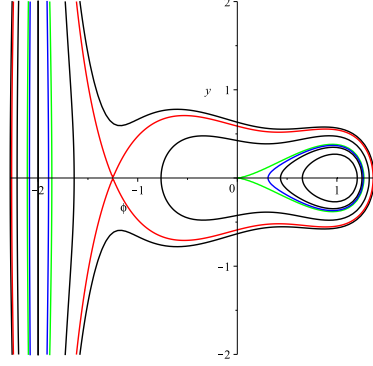

(f) $4C_1 < \phi_2$

Fig.6 The special case of $k=0$, $\phi_1 < 0 < \phi_2$.

2.2 Case of $\theta = \frac{1}{2}$

If $\theta = \frac{1}{2}$, then (1.7) takes the form

$$\begin{cases} \frac{d\phi}{d\xi} = y, \\ \frac{dy}{d\xi} = \frac{C_3\phi^4 + C_2\phi^3 + \frac{1}{2}\phi^2 + K\phi}{\frac{1}{2}\phi - C_1}, \end{cases} \quad (2.12)$$

with the associated regular system

$$\begin{cases} \frac{d\phi}{d\tau} = y(\frac{1}{2}\phi - C_1), \\ \frac{dy}{d\tau} = C_3\phi^4 + C_2\phi^3 + \frac{1}{2}\phi^2 + K\phi, \end{cases} \quad (2.13)$$

and the Hamiltonian

$$H(\phi, y) = -\frac{1}{2}(\phi - 4C_1)^2 y^2 + \frac{1}{4}\phi^4 + \frac{\alpha}{3}\phi^3 + \frac{\beta}{2}\phi^2 + \gamma\phi + \delta \ln(|\phi - 2C_1|) = h, \quad (2.14)$$

where $\alpha = C_2 + 2C_1C_3$, $\beta = \frac{1}{2} + 2C_1C_2 + 4C_1^2C_3$, $\gamma = K + C_1 + 4C_1^2C_2 + 8C_1^3C_3$, and $\delta = 2C_1K + 2C_1^2 + 8C_1^3C_2 + 16C_1^4C_3$.

2.2.1 Qualitative analysis of singular points of system (2.13)

Similarly to system (2.3), the point $O(0,0)$ is a singular point of system (2.13). There are no equilibrium points on the singular line $\phi = 2C_1$. The other singular points $(\phi_i, 0)$ of system(2.13) are obtained by solving the equation $f(\phi) = 0$. Thus, the conclusions in section (2.2.1) hold.

2.2.2 Classification of singular points and phase portraits of system (2.13)

Let $M_2(\phi, y)$ be the matrix of the linearized system of (2.13),

$$M_2(\phi, y) = \begin{pmatrix} \frac{1}{2}y & \frac{1}{2}\phi - C_1 \\ f'(\phi) & 0 \end{pmatrix}. \quad (2.15)$$

with

$$J_2(\phi, y) = \det M_2 = -\left(\frac{1}{2}\phi - C_1\right)f'(\phi) \quad (2.16)$$

We classify the equilibrium points based on the theory of dynamical system, and obtain the following phase portraits of system (2.13).

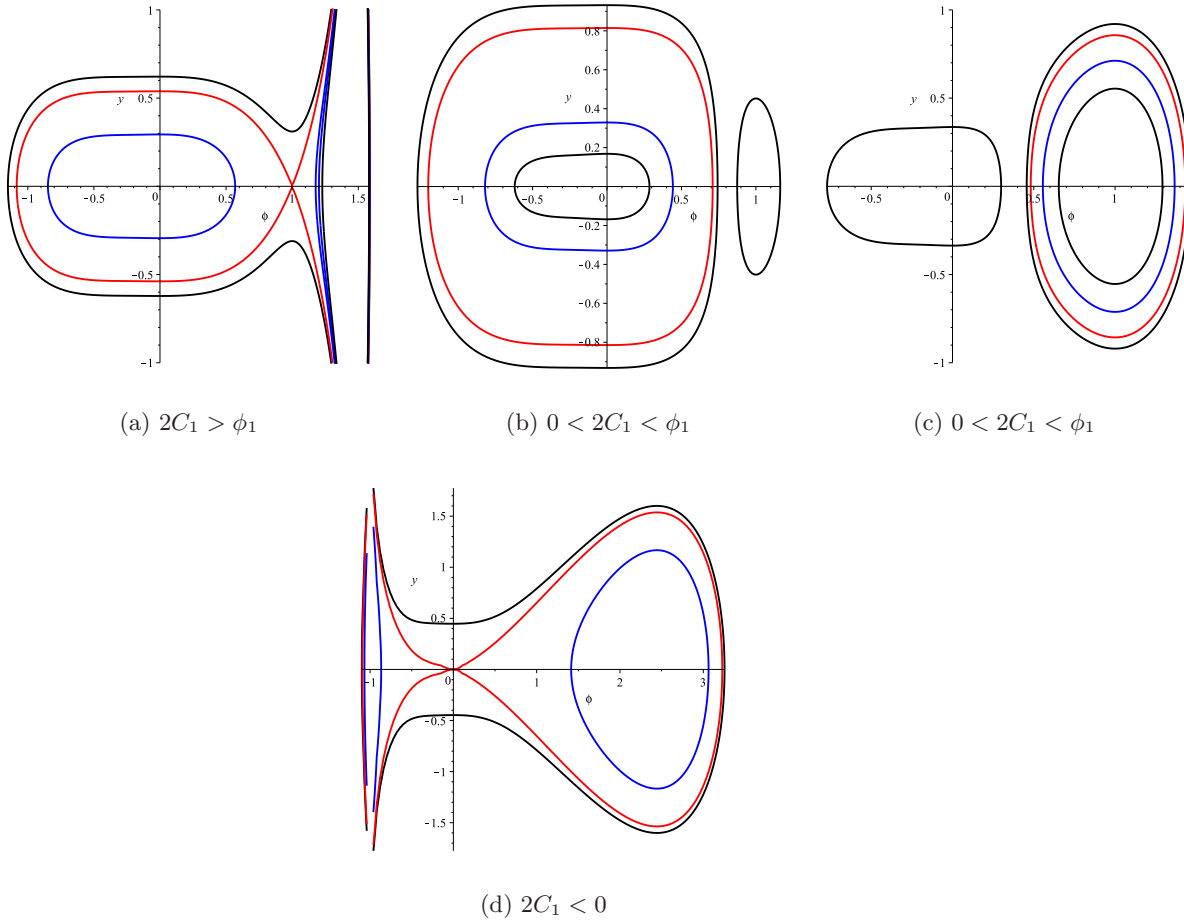

Fig.7 The function $g(\phi)$ admits only one zero, i.e $(\Delta_g) > 0$ and $g(\phi_-) > 0$.

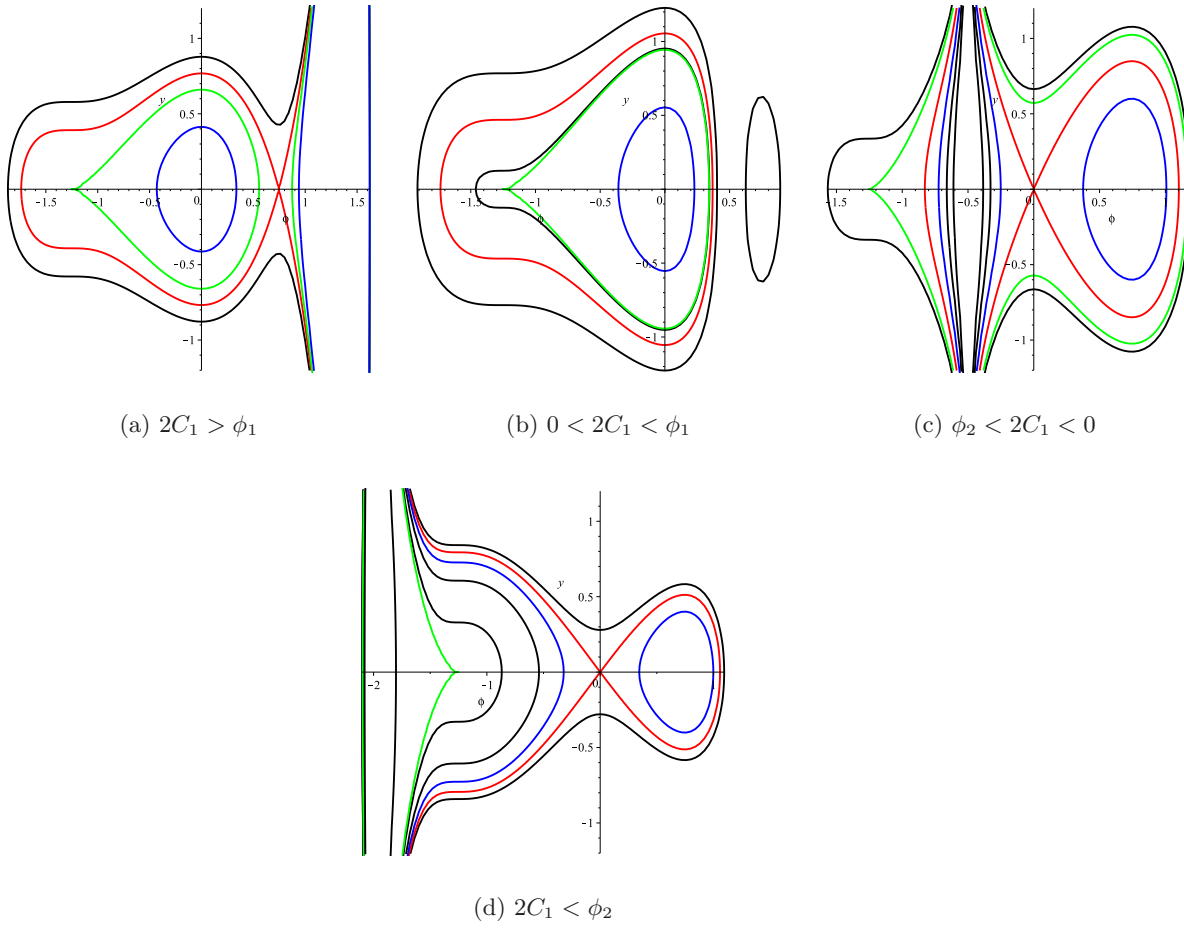
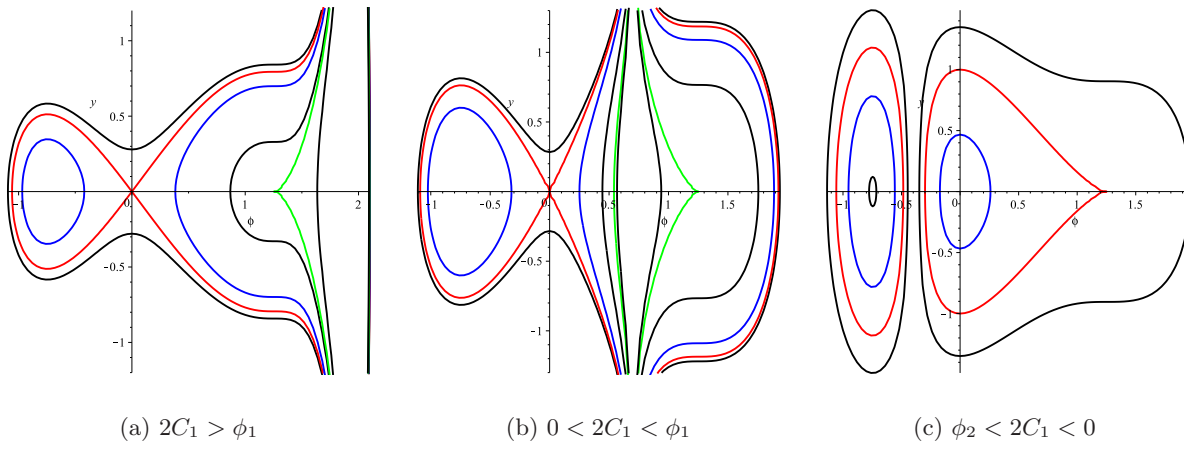
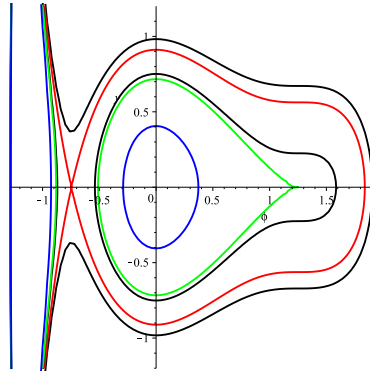

Fig.8 The function $g(\phi)$ admits a double zero, and $\tilde{\phi}_- < 0 < \phi_1$.





(d) $2C_1 < \phi_2$

Fig.9 The function $g(\phi)$ admits a double zero, and $\phi_1 < 0 < \tilde{\phi}_+$.

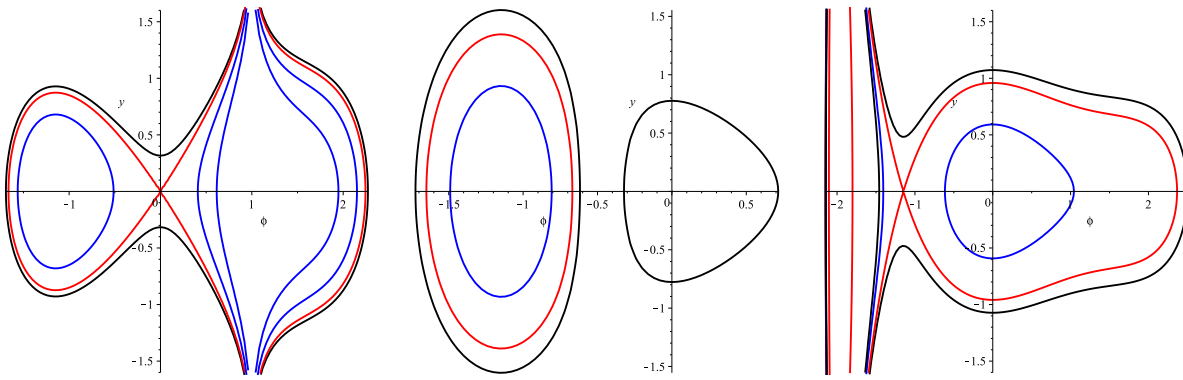

(a) $2C_1 > 0$

(b) $\phi_1 < 2C_1 < 0$

(c) $2C_1 < \phi_1$

Fig.10 The function $g(\phi)$ admits only one zero, i.e. $(\Delta_g) > 0$ and $g(\phi_+) < 0$.

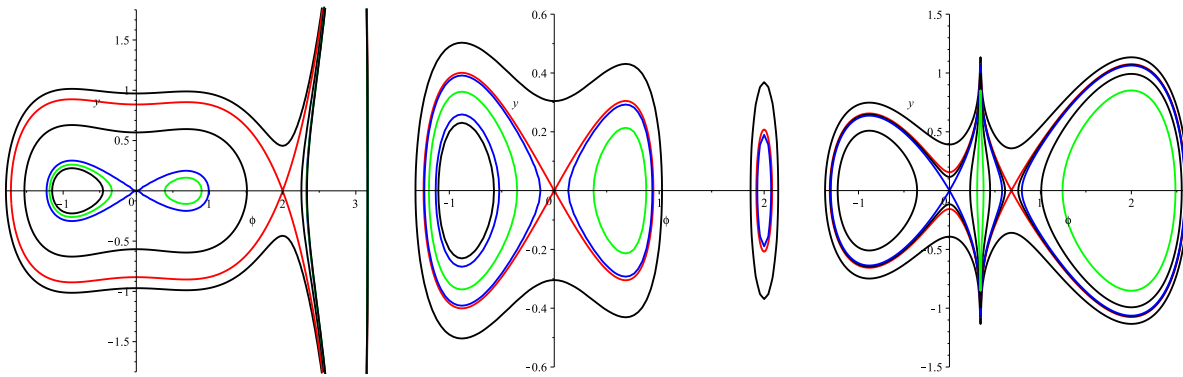

(a) $2C_1 > \phi_1$

(b) $\phi_2 < 2C_1 < \phi_1$

(c) $0 < 2C_1 < \phi_2$

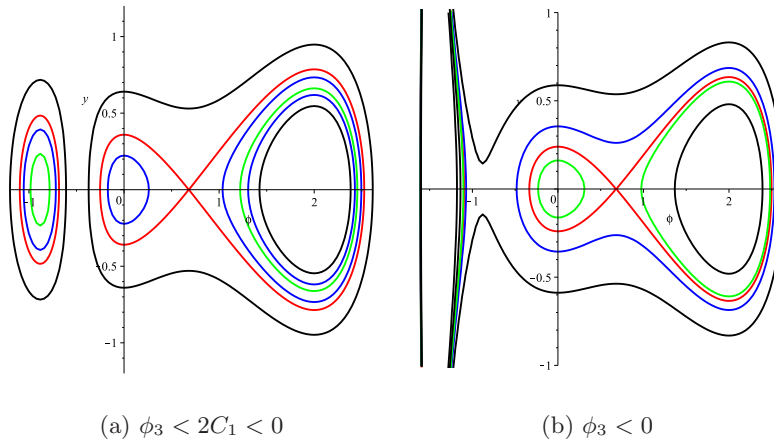

Fig.11 The function $g(\phi)$ admits three real zeros and $\phi_1 < \phi_2 < 0 < \phi_3$.

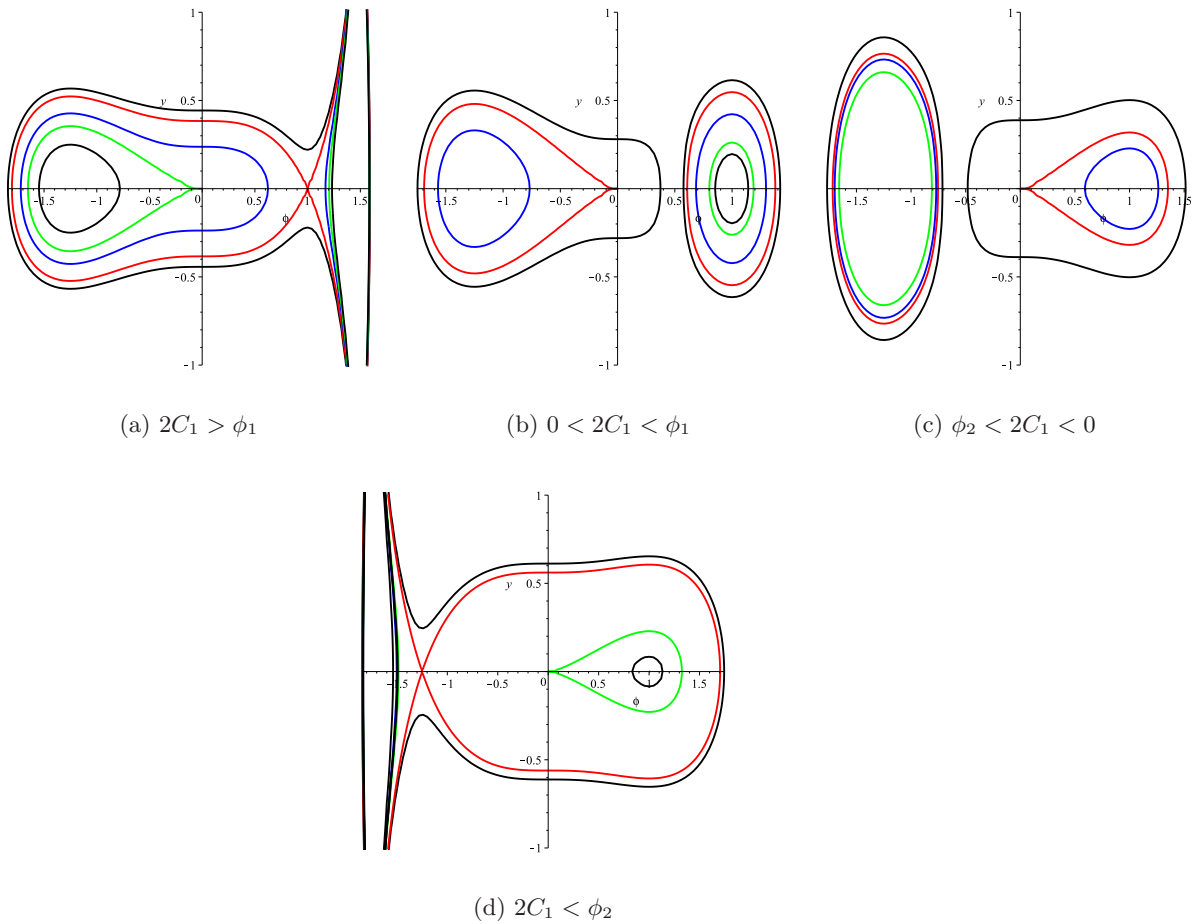
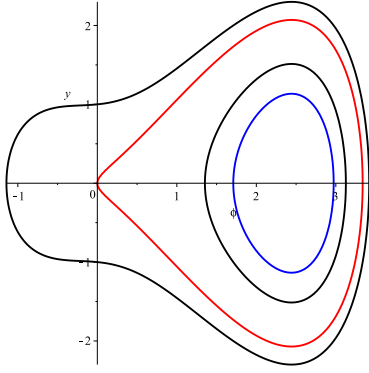
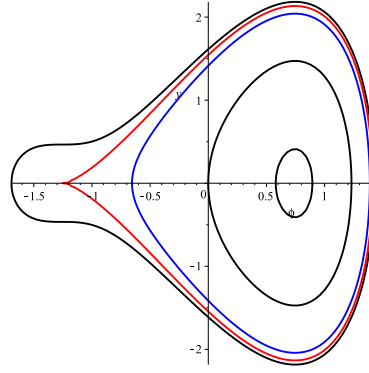

Fig.12 The function $g(\phi)$ admits three real zeros and $K = 0$.



(a) $K \neq 0, \Delta_{g'} > 0, g(\tilde{\phi}_-) > 0, C_1 = 0.$



(b) $K \neq 0, \Delta_{g'} > 0, g(\tilde{\phi}_-) = 0, C_1 = 0.$

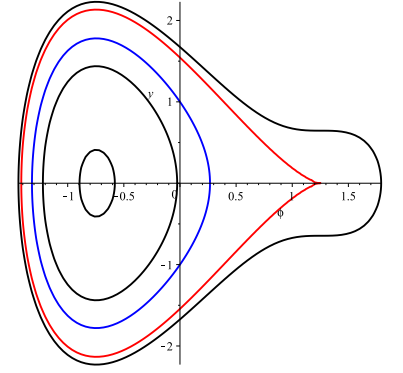

(c) $K \neq 0, \Delta_{g'} > 0, g(\tilde{\phi}_+) = 0, C_1 = 0.$

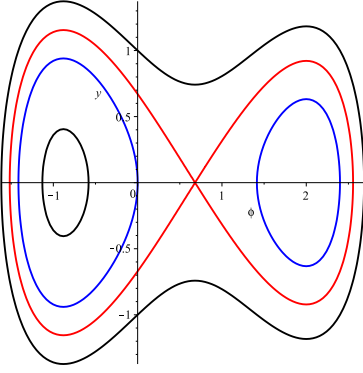

(d) $K \neq 0, \Delta_{g'} > 0, g(\tilde{\phi}_+) > 0, C_1 = 0.$

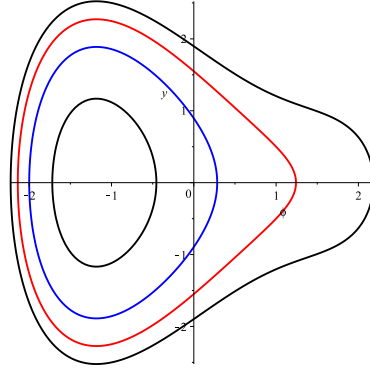

(e) $K \neq 0, \Delta_{g'} > 0, g(\tilde{\phi}_+) < 0, C_1 = 0.$

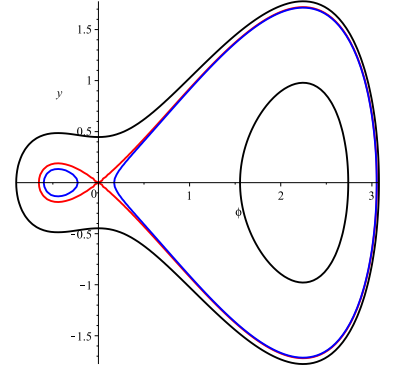

(f) $K = 0, C_2^2 > 2C_3, C_1 = 0.$

Fig.13 The special case of $C_1 = 0.$

2.3 Case of $\theta = 1$

If $\theta = 1$ then system (1.7) become

$$\begin{cases} \frac{d\phi}{d\xi} = y \\ \frac{dy}{d\xi} = \frac{\frac{1}{2}y^2 + C_3\phi^4 + C_2\phi^3 + \frac{1}{2}\phi^2 + K\phi}{\phi - C_1}, \end{cases} \quad (2.17)$$

with its associated regular system

$$\begin{cases} \frac{d\phi}{d\tau} = y(\phi - C_1), \\ \frac{dy}{d\tau} = \frac{1}{2}y^2 + C_3\phi^4 + C_2\phi^3 + \frac{1}{2}\phi^2 + K\phi, \end{cases} \quad (2.18)$$

and Hamiltonian

$$H(\phi, y) = y^2(\phi - C_1) + \frac{2}{5}C_3\phi^5 + \frac{1}{2}C_2\phi^4 + \frac{1}{3}\phi^3 + K\phi^2 = h. \quad (2.19)$$

Note that, for $C_3 = -a_3$, $C_2 = -a_2$, $a_1 = -\frac{1}{4}$ and $K = -a_0$, Eq. (2.19) is exactly the first integral of the asymptotic Rotation-CH equation considered in [Liang et al., 2020]. Thus, we do not show results.

3 Dynamical behavior of solutions of system (1.7)

In this section, we analyze the dynamical behavior and give some exact traveling wave solutions of system (1.7).

3.1 Case of $\theta = \frac{1}{4}$

The expression of the first integral of system (2.3) makes the computation of exact solutions of traveling waves quite a tedious process. In this section, we discuss the dynamical behavior of the solutions, based on the properties of singular points and the obtained phase portraits. To discuss the traveling wave solutions, we utilize the following two theorems. **Theorem A** (The Rapid-Jump Property of the Derivative near the Singular Straight Line), and **Theorem B** (Existence of Finite Time Interval(s) of Solutions with Respect to Variables in the Positive or (and) Negative Direction(s))(See [Li, 2013]). The above theorems have been proven in [Li & Kou, 2017]. Consecutively to the above results, we classify the profiles for the wave function $\phi(\xi)$.

3.1.1 Smooth solitary and periodic wave solution

In figures 2a, 2b, 3a, 3b, 5a, 5b, there exists a family of periodic orbits enclosing the equilibrium point $E_0(0, 0)$ defined by $H(\phi, y) = h$ with $h \in (h_1, h_3)(or(h_3, h_1))$. In these cases system (2.3) admits a periodic wave solutions(see fig. 7(a)). Considering figures 2a, 2d, 3a, 3e, 3f, 3g, 4a, 4b, 4g, 5a, 5b, 5c, 5d, 5e, 5f, 5i, 6f, we have homoclinic orbits to the equilibrium points $E_0(0, 0)$ or $E_i(\phi_i)$ defined by $H(\phi, y) = h_i$. In these cases, system (2.3) has solitary wave solutions (see fig. 7(b)).

3.1.2 Peakon, anti-peakon and periodic peakon solution

The left or right arches connecting the two saddle points on the singular line, in figures 2c, 3c, 4d, 4e, 5c, 5g, are limit solutions for the periodic orbits they enclose ([Liang et al., 2020]). Considering these arches, system (2.3) admits peakon and anti-peakon solutions (see fig.8 (a) and (b)). Corresponding to the family of triangular periodic orbits enclosed by the singular line $\phi = 4C_1$ and the closed orbit in figures 2c, 3c, 4d, 5c, 5g, 6d. They are defined by $H(\phi, y) = h$ with $h \in (h_2, h_3)$ (or (h_3, h_2)). The system (2.3) admits periodic peakon solutions (see fig.8 (c)).

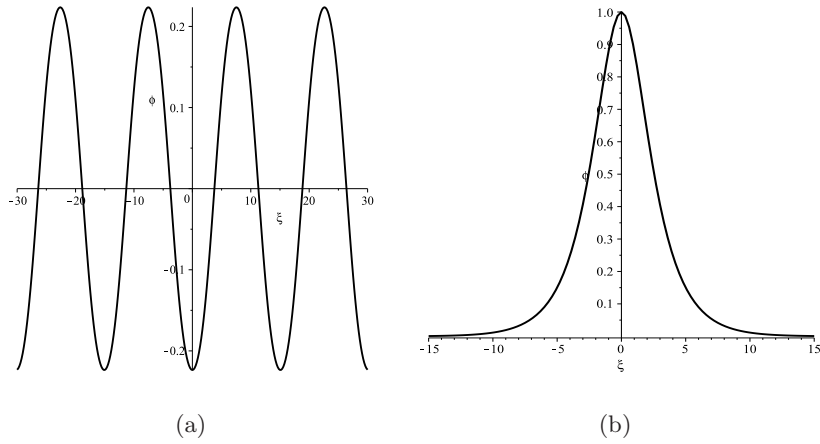
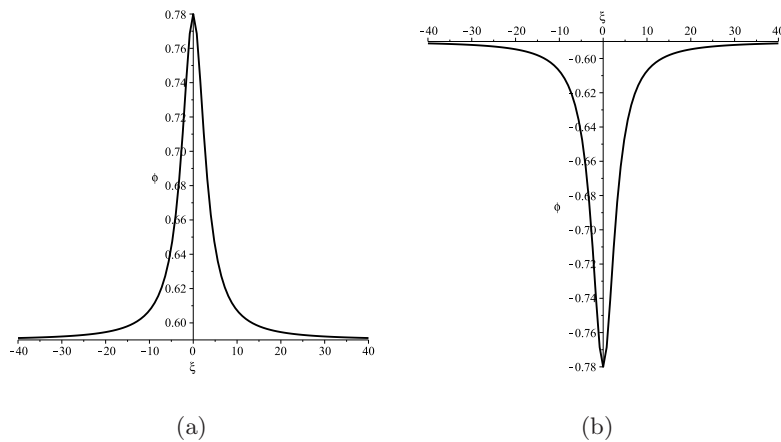
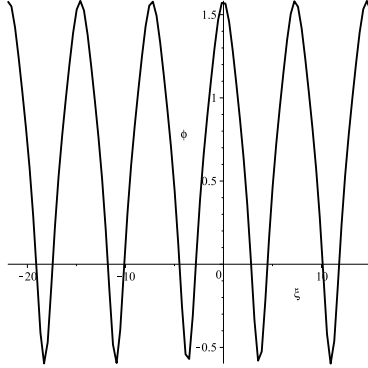

Fig.14 Periodic and solitary wave solution profile of system (2.3).





(c)

Fig.15 Peakon, anti-peakon and periodic peakon solution profile of system (2.3).

3.2 Case of $\theta = \frac{1}{2}$

As previously mentioned, the expression of the first integral of system (2.13), makes explicit expressions of solutions difficult to obtain. Thus, we discuss the dynamical behavior of the solutions, based on the phase portraits and the properties of the singular points. However, for the special case of the parameter C_1 being null, we are able to compute some exact traveling wave solutions.

3.2.1 Dynamical behavior of solutions

(i) Periodic wave solution

Taking figures 7-12, corresponding to the level curve $H(\phi, y) = h$ with $h \in (h_1, h_2)$ (or (h_2, h_1)), there exist families of periodic orbits enclosing the center points $E_i(\phi_i, 0)$ or (and) $E_0(0, 0)$. Thus, system (2.13) admits periodic wave solutions.

(ii) Solitary wave solution

Considering fig. 7a, d, 8a, c, d, 9a, b, d, 10a, c, 11 and 12a, d. There exist homoclinic orbits corresponding to the level curve $H(\phi, y) = h$ with $h = h_i$. In these cases, system (2.13) admits solitary wave solution.

We notice that for $\theta = \frac{1}{2}$, all the wave solutions appear to be smooth.

3.2.2 Some exact solutions of system (2.13) for $C_1 = 0$

In this subsection, we consider the orbits computed with $C_1 = 0$.

According to the phase portraits in fig.(13), for a given h , $H(\phi, y) = h$ corresponds to level curves of system (2.13). From Eq. (2.2) we write

$$y^2 = \frac{C_3}{2}\phi^4 + \frac{2\alpha}{3}\phi^3 + \beta\phi^2 + 2\gamma\phi - 2h. \quad (3.1)$$

Furthermore, we know, $\frac{d\phi}{d\xi} = y$. Hence, integrating along the curve $H(\phi, y) = h$, from $\phi(0) = \phi_0$, we derive

$$\xi = \int_{\phi_0}^{\phi} \frac{d\phi}{\sqrt{\frac{C_3}{2}\phi^4 + \frac{2\alpha}{3}\phi^3 + \beta\phi^2 + 2\gamma\phi - 2h}} \quad (3.2)$$

i) Considering figures 13a, 13b, 13d, there is a family of periodic orbits enclosing the equilibrium point ϕ_1 . Let p_1 and p_2 be the intersections of the curve with the ϕ -axis. Then, we have

$$y^2 = \frac{C_3}{2}(p_1 - \phi)(\phi - p_2)(\phi - w)(\phi - \bar{w}) \quad (3.3)$$

where w and \bar{w} are imaginary numbers. Thus, from ([Byrd & Friedman, 1971]), we get:

$$\phi(\xi) = \frac{(p_1 B_1 - p_2 A_1) \text{cn}(\omega\xi, k) - p_1 B_1 - P_2 A_1}{(B_1 - A_1) \text{cn}(\omega\xi, k) - (B_1 - A_1)}, \quad (3.4)$$

where $A_1^2 = (p_1 - b_1)^2 + a_1^2$, $B_1^2 = (p_2 - b_1)^2 + a_1^2$, $a_1^2 = \frac{-(w-\bar{w})^2}{4}$, $b_1 = \frac{w+\bar{w}}{2}$, $k = \frac{(p_1-p_2)^2 - (A_1-B_1)^2}{4A_1B_1}$, $\omega = \sqrt{\frac{AB|C_3|}{2}}$ and $\text{cn}(\omega\xi, k)$ is Jacobian elliptic function.

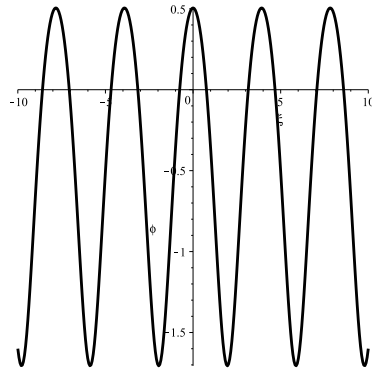

Fig.16 Periodic orbit given by (3.4)

ii) Corresponding to figures 13d,f, there exists two families of periodic orbits enclosing the equilibrium points ϕ_1 and ϕ_2 . In term of the right orbit, we have

$$y^2 = \frac{C_3}{2}(p_1 - \phi)(\phi - p_2)(\phi - p_3)(\phi - p_4). \quad (3.5)$$

Hence,

$$\phi(\xi) = \frac{p_2(p_1 - p_3) - p_3(p_1 - p_2)sn^2(\omega\xi, k)}{(p_1 - p_3) - (p_1 - p_2)sn^2(\omega\xi, k)}, \quad (3.6)$$

where $\omega = \frac{2}{\sqrt{(p_1-p_3)(p_2-p_4)}}\sqrt{\frac{|C_3|}{2}}$, $k^2 = \frac{(p_1-p_2)(p_3-p_4)}{(p_1-p_3)(p_2-p_4)}$, and $sn(\omega\xi, k)$ is Jacobian elliptic function.

In term of the left orbit, we have

$$y^2 = \frac{C_3}{2}(p_1 - \phi)(\phi - p_2)(p_3 - \phi)(\phi - p_4), \quad (3.7)$$

which gives us

$$\phi(\xi) = \frac{p_4(p_1 - p_3) - p_1(p_3 - p_4)sn^2(\omega\xi, k)}{(p_1 - p_3) - (p_3 - p_4)sn^2(\omega\xi, k)}, \quad (3.8)$$

where $\omega = \frac{2}{\sqrt{(p_1-p_3)(p_2-p_4)}}\sqrt{\frac{|C_3|}{2}}$, $k^2 = \frac{(p_1-p_2)(p_3-p_4)}{(p_1-p_3)(p_2-p_4)}$, and $sn(\omega\xi, k)$ is Jacobian elliptic function.

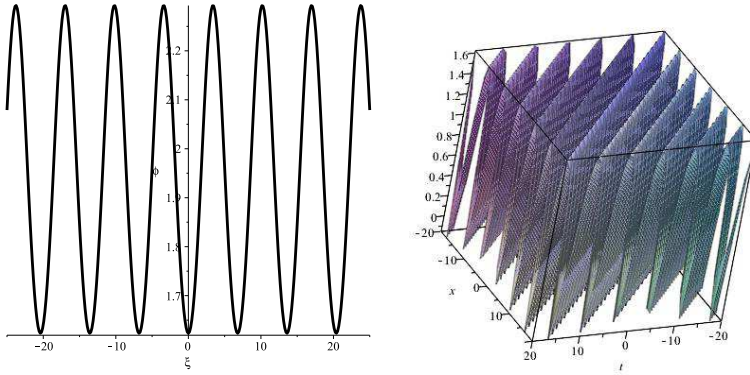

(a) Right orbit given by (3.6)

(b) Wave solution given by (3.6)

Fig.17

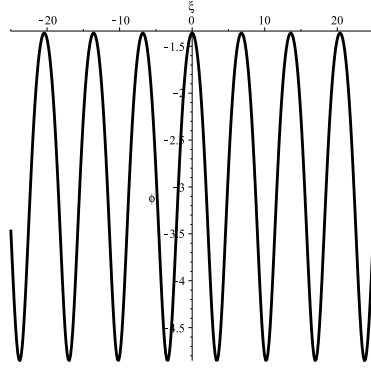

Fig.18 Right orbit given by (3.6)

iii) Considering figures 13d,f, we observe two homoclinic orbits to the equilibrium points $\phi_2 O(0, 0)$, respectively. In term of the right orbit, we write:

$$y^2 = \frac{C_3}{2}(p_1 - \phi)(\phi - p_2)^2(\phi - p_3). \quad (3.9)$$

Hence, we get

$$\phi = p_2 + \frac{2a}{(p_3 - p_1)\cosh(\omega\xi) - b}. \quad (3.10)$$

In term of the right orbit, we have

$$\phi = p_2 - \frac{2a}{(p_3 - p_1)\cosh(\omega\xi) - b}, \quad (3.11)$$

where $a = p_1p_2 - p_1p_3 + p_2p_3 - p_2^2$, $b = p_1 - 2p_2 + p_3$ and $\omega = \sqrt{\frac{a|C_3|}{2}}$.

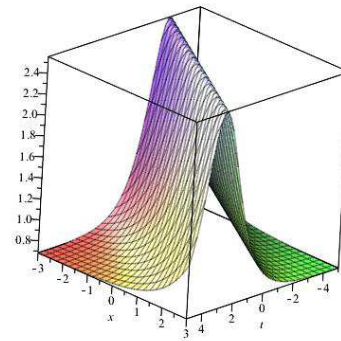
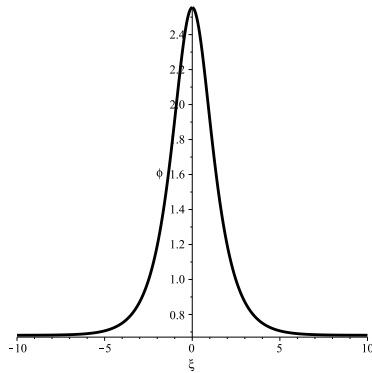

(a) Right homoclinic orbit given by (3.10) (b) Wave solution given by (3.10)

Fig.19

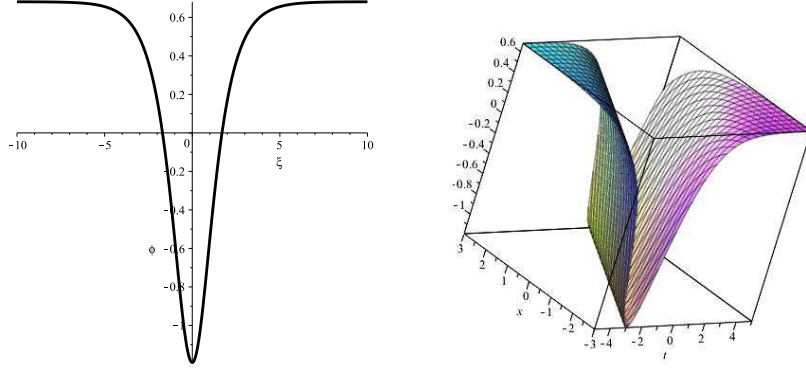

(a) Left homoclinic orbit given by (3.11) (b) Wave solution given by (3.11)

Fig.20

4 Main results

We summarize the bifurcations and explicit expressions of waves solutions in the following theorems.

Theorem 1. When $\theta = \frac{1}{4}$,

(B1) In the domain $D_1 = \{4C_2^2 > 6C_3, g(\tilde{\phi}_-) > 0\}$, moving the singular line $4C_1$ from right to left, there are solitary wave solutions and (or) periodic wave solutions. Additionally, when $0 < 4C_1 < \phi_1$ there are a peakon solution and two periodic peakon solutions.

(B2) In the domain $D_2 = \{4C_2^2 > 6C_3, g(\tilde{\phi}_-) = 0\}$, moving the singular line $4C_1$ from right to left, there are solitary wave solutions and (or) periodic wave solutions. Additionally, when $0 < 4C_1 < \phi_1$ there are two periodic peakon solutions.

(B3) In the domain $D_3 = \{4C_2^2 > 6C_3, g(\tilde{\phi}_+) = 0\}$, moving the singular line $4C_1$ from right to left, there are solitary wave solutions and (or) periodic wave solutions. Espacially, when $0 < 4C_1 < \phi_1$ there are a peakon and two periodic peakon solutions.

(B4) In the domain $D_4 = \{4C_2^2 > 6C_3, g(\tilde{\phi}_+) > 0, g(\tilde{\phi}_-) < 0\}$, moving the singular line $4C_1$ from right to left, there are solitary wave solutions and (or) periodic wave solutions. Additionally, when $\phi_3 < 4C_1 < \phi_2$ and $0 < 4C_1 < \phi_1$ there are a peakon solution and two periodic peakon solutions.

(B5) In the domain $D_5 = \{K = 0, 4C_2^2 > 6C_3\}$, moving the singular line $4C_1$ from right to left, there are solitary wave solutions and (or) periodic wave solutions. Additionally, when $\phi_3 < 4C_1 < \phi_2$ and $0 < 4C_1 < \phi_1$ there are a peakon solution and two periodic peakon solutions.

Theorem 2. When $\theta = \frac{1}{2}$,

(B1) In the domain $D_1 = \{4C_2^2 > 6C_3, g(\tilde{\phi}_-) > 0\}$, moving the singular line $2C_1$ from right to left, there are solitary wave solutions and (or) periodic wave solutions.

(B2) In the domain $D_2 = \{4C_2^2 > 6C_3, g(\tilde{\phi}_-) = 0\}$, moving the singular line $2C_1$ from right to left, there are solitary wave solutions and (or) periodic wave solutions.

(B3) In the domain $D_3 = \{4C_2^2 > 6C_3, g(\tilde{\phi}_+) = 0\}$, moving the singular line $2C_1$ from right to left, there are solitary wave solutions and (or) periodic wave solutions.

(B4) In the domain $D_4 = \{4C_2^2 > 6C_3, g(\tilde{\phi}_+) < 0\}$, moving the singular line $2C_1$ from right to left, there are solitary wave solutions and (or) periodic wave solutions.

(B5) In the domain $D_5 = \{4C_2^2 > 6C_3, g(\tilde{\phi}_+) > 0, g(\tilde{\phi}_-) < 0\}$, moving the singular line $2C_1$ from right to left, there are solitary wave solutions and (or) periodic wave solutions.

(B6) In the domain $D_5 = \{K = 0, 4C_2^2 > 6C_3\}$, moving the singular line $4C_1$ from right to left, there are solitary wave solutions and (or) periodic wave solutions.

Theorem 3. When $\theta = \frac{1}{2}$ and $C_1 = 0$,

(B1) In the domain $D_1 = \{4C_2^2 > 6C_3, g(\tilde{\phi}_-) \geq 0\}$, there is a periodic solution given by Eq. (3.4).

(B2) In the domain $D_2 = \{4C_2^2 > 6C_3, g(\tilde{\phi}_-) \leq 0\}$, there is a periodic solution with the same parametric representation as Eq. (3.6).

(B3) In the domain $D_2 = \{4C_2^2 > 6C_3, g(\tilde{\phi}_-) < 0, g(\tilde{\phi}_+) > 0\}$, there are two periodic wave solutions given by Eqs. (3.6), (3.8) and two solitary wave solutions given by Eqs. (3.10), (3.11).

5 Conclusion

In this paper, we studied the Rotation- θ -equation (the θ -equation with the Coriolis force effect), by mean of the bifurcation method and qualitative theory of dynamical system. Using traveling wave solution transformation, we obtained the first integral for the model we built, which to our knowledge has not been brought to investigation. After qualitative analysis, we were able to obtain phase portraits for certain values θ and the parameters. Smooth periodic and solitary waves, as well as, peakons and periodic peakons solutions were observed. Interestingly, we noticed that the proximity of the singular line alters the nature of an equilibrium point. One would notice that for $\theta = \frac{1}{4}$, the Rotation- θ equation is reduced to the Rotation Degasperis-Procesi (R-DP) equation. Furthermore, for $\theta = 1$, the Rotation- θ equation is similar to the asymptotic R-CH equation in ([Liang et al., 2020]), only differing by the values of certain parameters.

The chosen values of θ , allow us to assess the difference in behavior between the classical θ -equation and the Rotation- θ equation. We can conclude that the coriolis effect does affect the traveling wave solutions. Due to the form of the model and the high power of the hamiltonian, we were unable to compute some of the explicit expressions of the solutions. To the best of our knowledge, there are no mathematical tools to solve the elliptic integrals whose the power is higher than 5 ([Byrd & Friedman, 1971]). It is an interesting question and remains open.

6 Acknowledgement

This manuscript was supported from the Natural Science Foundation of Zhejiang Province under Grant (No. LY20A010016), National Natural Science Foundation of China under Grant (No. 11671176, 11931016).

References

- [Camassa & Holm, 1993] Camassa, R. & Holm, D. [1993] “An integrable shallow water wave equation with peaked solitons,” *Phys. Rev.* **71**, 1161-1164.
- [Lui, 2008] Lui, H. [2008] “On the discreteness of the Hopf equation,” *Acta Math. Appl.Sin.* **24**, 423-440.
- [Bressan & Constantin, 2006] Bressan, A. & Constantin, D. [2006] “Global Conservative Solutions of the Camassa-Holm Equation,” *Arch. Ration. Mech. Anal.* **183**, 2: 215-239.
- [Constantin & Lannes, 2008] Constantin, D. & Lannes, D. [2008] “The Hydrodynamical Relevance of the Camassa-Holm and Degasperis-Procesi Equations,” *Arch. Ration. Mech. Anal.* **192**, 1: 165-186.
- [Constantin, 2008] Constantin, A. [2008] “On the scattering problem for the Camassa-Holm equation,” *Proc. R. Soc. Lond. Ser. A Math. Phys. Eng. Sci.* **457**, 953-970.
- [Wei et al., 2018] Wei, M., sun, X., & Zhou, H. [2018] “Bifurcations of traveling wave solutions for a generalized Camassa-Holm equation,” *J. Appl. Anal. Comput.* **8**, 6:1851-1862.
- [Du et al., 2018] Du, Z., Li, J., & Li, X. [2018] “The existence of solitary wave solutions of delayed Camassa-Holm equation via a geometric approach,” *J. Funct. Anal.* **275**, 4; 988-1007.
- [Ge and Du, 2018] Ge J., Du Z. [2020] “The solitary wave solutions of the nonlinear perturbed shallow water wave model, *Appl. Math. Lett.*, 103, 106202”.
- [Chu et al., 2020] Chu, J., Meng, G., & Zhang, Z. [2020] “Continuous dependence and estimates of eigenvalues for periodic generalized Camassa-Holm equations,” *J. Differential Equations* **269**, 6343-6358.

- [Sun et al., 2020] Sun, X., Huang, W. & Cai, J. [2020] “Coexistence of the solitary and periodic waves in convecting shallow water fluid,” *Nonlinear Anal. Real World Appl.* **53**, 103076.
- [Gui et al., 2018] Gui, G., Liu, Y., & Sun, J. [2018] “A nonlocal shallow-water model arising the Full Water Waves with Coriolis effect,” *J. Math. Fluid Mech.* **21**, 27.
- [Gui et al., 2019] Gui, G., Liu, Y., & Luo, T., [2019] “Model Equations and Traveling Wave Solutions for Shallow-Water Waves with the Coriolis Effect,” *J. Nonlinear Sci.*, **29**, 993–1039.
- [Chen et al., 2018] Chen R., Gui, G., Liu, Y., “On a shallow-water approximation to the Green-Naghdi equations with the Coriolis effect”, *Advances in Mathematics*, 340(2018) 106-137.
- [Luo et al., 2019] Luo, T., Liu, Y., Mi, Y., & Moon, B., [2019] “On a shallow-water model with the Coriolis effect,” *J. Differential Equations*, **267**, 3232-3270.
- [Ni et al., 2011] Ni, L., & Zhou, Y., [2011] “Wave breaking and propagation speed for a class of nonlocal dispersive θ -Equations,” *Nonlinear Anal.* **12**, 592-600.
- [Chu et al., 2020] Chu, J., Ding, Q., & Yang, Y., [2020] “Steady periodic waves and formal stability for fixed-depth rotational equatorial flows,” *J. Differential Equations* **269**, 4192-4214.
- [Chu & Wang, 2020] Chu, J. & Wang, l., [2020] “Analyticity of rotational travelling gravity two layer waves,” *Stud. Appl. Math.*, <https://doi.org/10.1111/sapm.12358>.
- [Constantin, 2012] Constantin, A., [2012] “On the modeling of equatorial waves,” *Geophys. Res. Lett.* **39**.
- [Constantin & Johnson, 2008] Constantin, A. & Johnson, R., [2008] “Propagation of very long water waves, with vorticity, over variable depth, with applications to tsunamis,” *Fluid Dynam. Res.* **49**, 175-211.

- [Kirbi et al., 2013] Kirbi, J. Shi, F., Tehranirad, B. Harris, J., & Grilli, S., [2013] “Dispersive tsunami waves in the ocean: model equations and sensitivity to dispersion and Coriolis effects,” *Ocean Model.* **62**, 39-55.
- [Constantin, 2012] Constantin, A., [2012] “An exact solution for equatorially trapped waves,” *J. Geophys. Res.* **117**, C05029.
- [Constantin & Germain, 2013] Constantin, A., & Germain, P., [2013] “Instability of some equatorially trapped waves,” *J. Geophys. Res.* **118**, 2802-2810.
- [Hsu, 2015] Tsu, H., [2015] “An exact solution for equatorial waves,” *Monatsh. Math.* **176**, 143-252.
- [Ricardo & Wooyoun, 2009] Ricardo, B., & Wooyoun, C. [2009] “Inhibiting shear instability induced by large amplitude internal solitary waves in two-layer flows with a free surface,” *Stud. Appl. Math.* **122**, 325-346.
- [Chu & Yang, 2020] Chu, J. & Yang, Y., [2020] “Constant vorticity water flows in the equatorial β -plane approximation with centripetal forces,” *J. Differential Equations*, **269**, 9336-9347.
- [Tu et al., 2019] Tu, X., Liu, Y., & Mu, C., [2019] “Existence and uniqueness of the global conservative weak solutions to the rotation- Camassa-Holm equation,” *J. Differential Equations*, **266**, 4864-4900.
- [Fan & Yuen, 2019] Fan, E., & Yuen, M., [2019] “Peakon weak solutions for the rotation-two-component Camassa-Holm system,” *Appl. Math. Lett.* **97**, 53-59.
- [Fan, Gao, & Liu, 2016] Fan, L., Gao, H., & Liu, Y., [2016] “On the rotation-two-component Camassa-Holm system modelling the equatorial water waves,” *Adv. Math.* **291**, 59-89.
- [Liang et al., 2020] Liang, J., Li, J. & Zhang, Y., [2020] “Bifurcations and exact solutions of an asymptotic rotation-Camassa-Holm equation,” *Nonlinear Dynam.* **101**, 2423-2439.

- [Constantin & Lannes, 2009] Constantin, A., & Lannes, D., [2009] “The hydrodynamical relevance of the Camassa-Holm and Degasperis-Procesi equations,” *Arch. Ration. Mech. Anal.* **192**, 165-186.
- [Degasperis & Procesi, 1999] Degasperis, A., & Procesi, M., [1999] “Asymptotic integrability, in Symmetry and Perturbation Theory,” *World Sci. Publ.* **77**, 23-27.
- [Wen, 2014] Wen, Z., [2014] “Bifurcation of solitons, peakons, and periodic cusp waves for θ -equation,” *Nonlinear Dynam.* **11**, 247-253.
- [Li, 2013] Li, J. [2013] *Singular Nonlinear Travelling Wave Equations: Bifurcations and Exact Solutions* (Science, Beijing).
- [Li, 2019] Li, J. [2019] *Bifurcations and exact solutions in invariant manifolds for nonlinear wave equations* (Science, Beijing).
- [Zhang, et al., 2021] Zhang, Y., Xia, Y., [2021] “Traveling wave solutions of generalized Dullin–Gottwald–Holm equation with parabolic law nonlinearity,” *Qual. Theor. Dyn. Syst.*, (2021) 20:67.
- [Zhang & Li, 2017] Zhang, T., & Li, J., [2017] “Exact Torus Knot Periodic Orbits and Homoclinic Orbits in a Class of Three-Dimensional Flows Generated by a Planar Cubic System,” *Internat. J. Bifur. Chaos Appl. Sci. Engrg.*, **27**, 1-12.
- [Du & Qiao, 2020] Du, Z., & Qiao, Q., [2020] “The dynamics of traveling waves for a nonlinear Belousov-Zhabotinskii system,” *J. Differential Equations* **269**, 2289-2303.
- [Song & Tang, 2017] Song, Y., & Tang, X., [2017] “Stability, Steady-state bifurcations, and Turing patterns in a predator-prey model with herd behavior and prey-taxis,” *Stud. Appl. Math.* **139**, 3: 371-404.
- [Sun & Yu, 2019] Sun, X., & Yu, P., [2019] “Periodic traveling waves in a generalized BBM equation with weak backward diffusion and dissipation terms,” *Discrete Contin. Dyn. Syst. Ser. B* **24**, 965-987.

- [Li & Kou, 2017] Li, J., & Kou, K., [2017] “Dynamics of Traveling Wave Solutions to a New Highly Nonlinear Shallow Water Wave Equation,” *Int. J. Bifurcat. Chaos* **27**, 3: 1750044.
- [Byrd & Friedman, 1971] Byrd, P. & Friedman, M., [1971] *Handbook of elliptic integrals for engineers and scientists* (Springer, Berlin).
- [Ni, 2010] Ni, L., [2010] “The Cauchy problem for two-component generalized θ -equation,” *Nonlinear Anal.* **73**, 1338-1339.

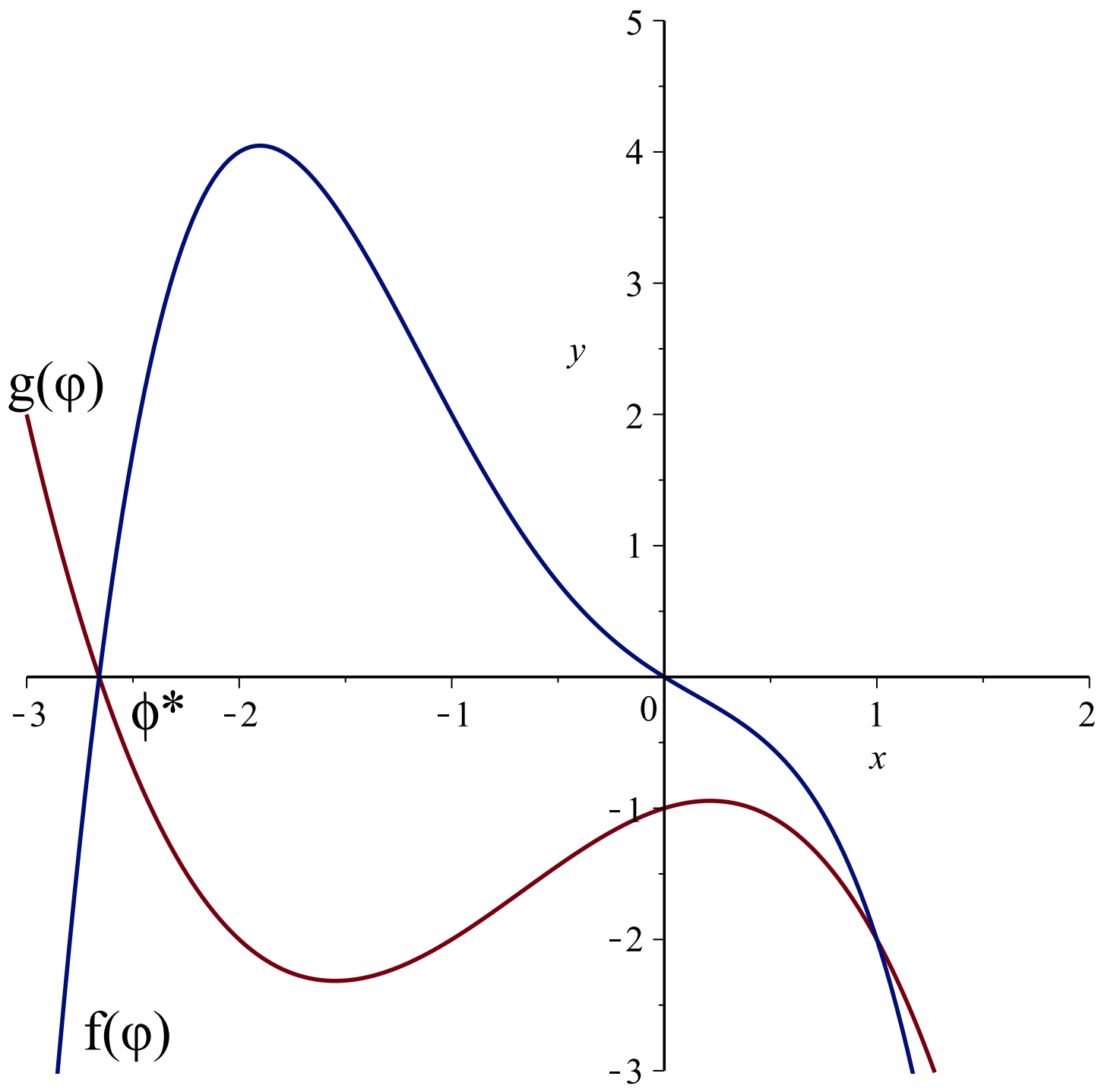

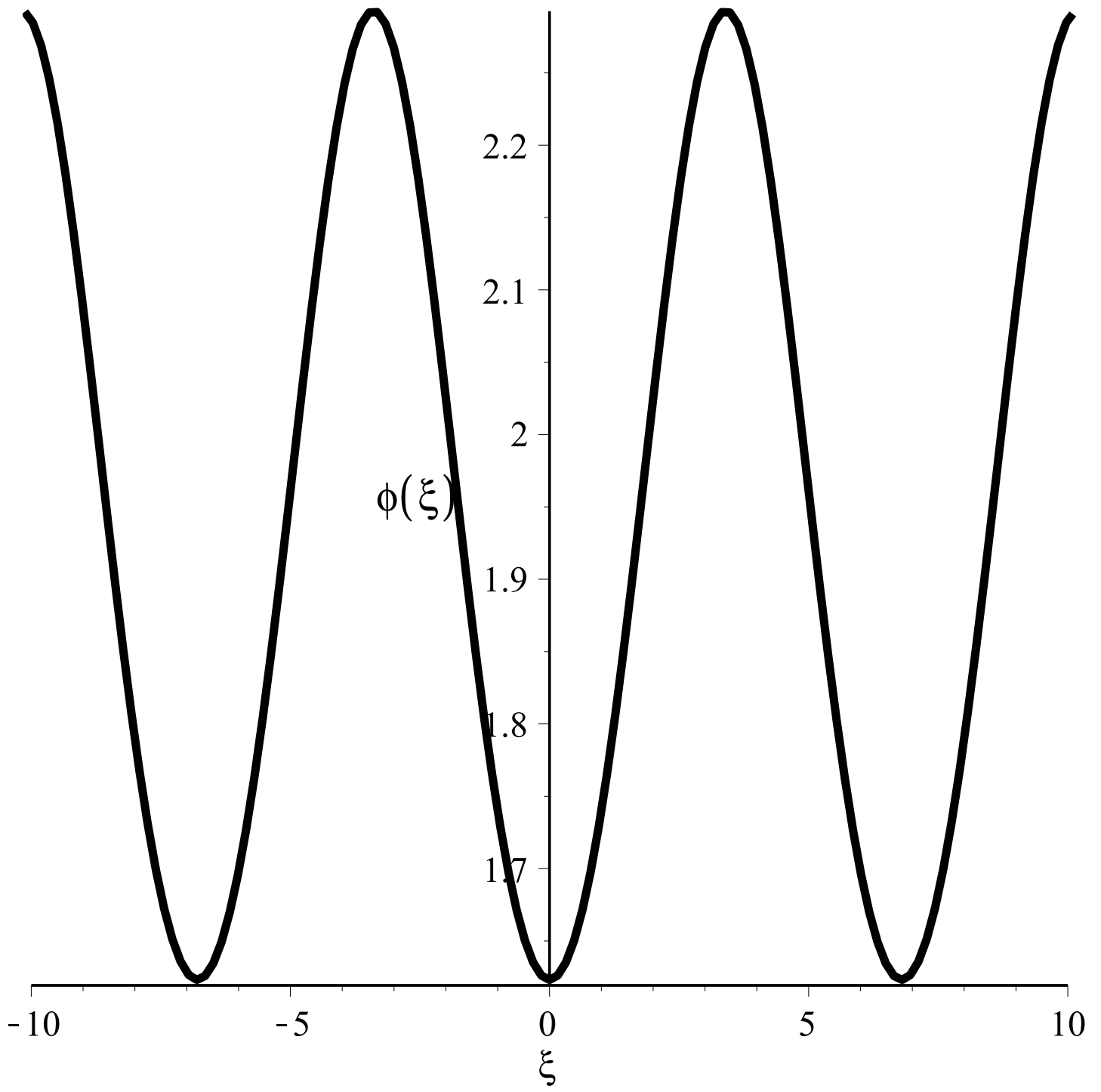

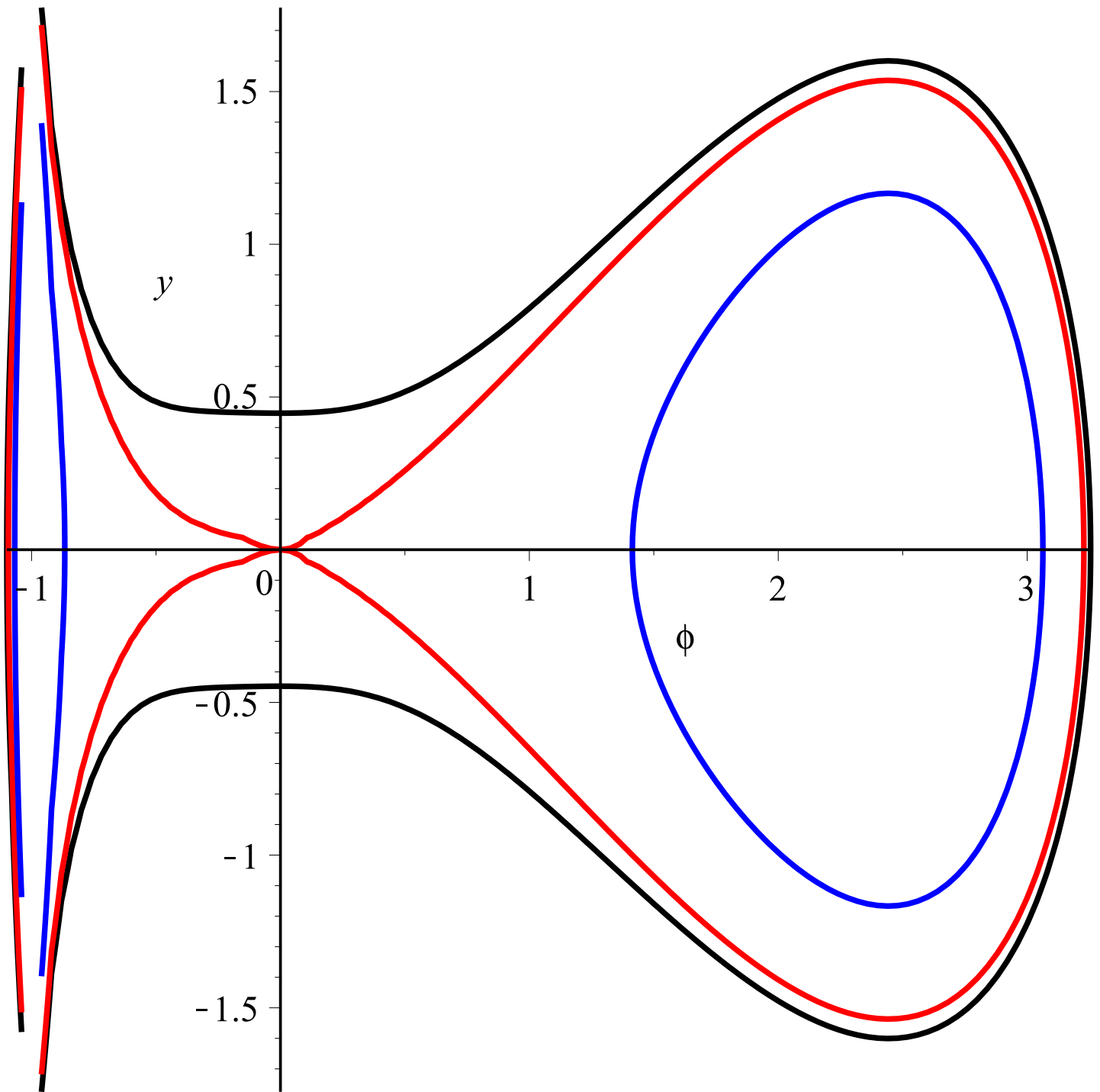

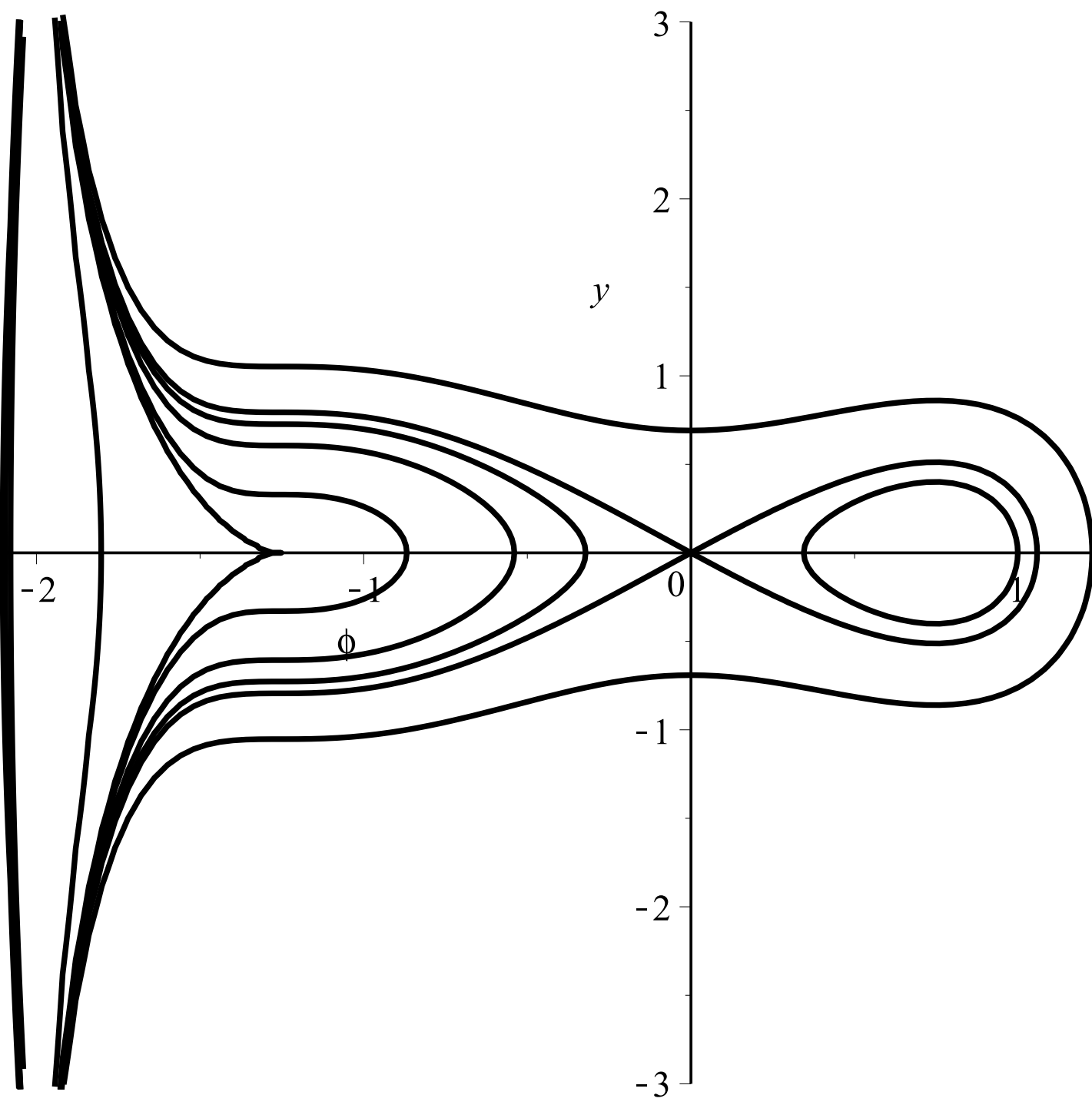

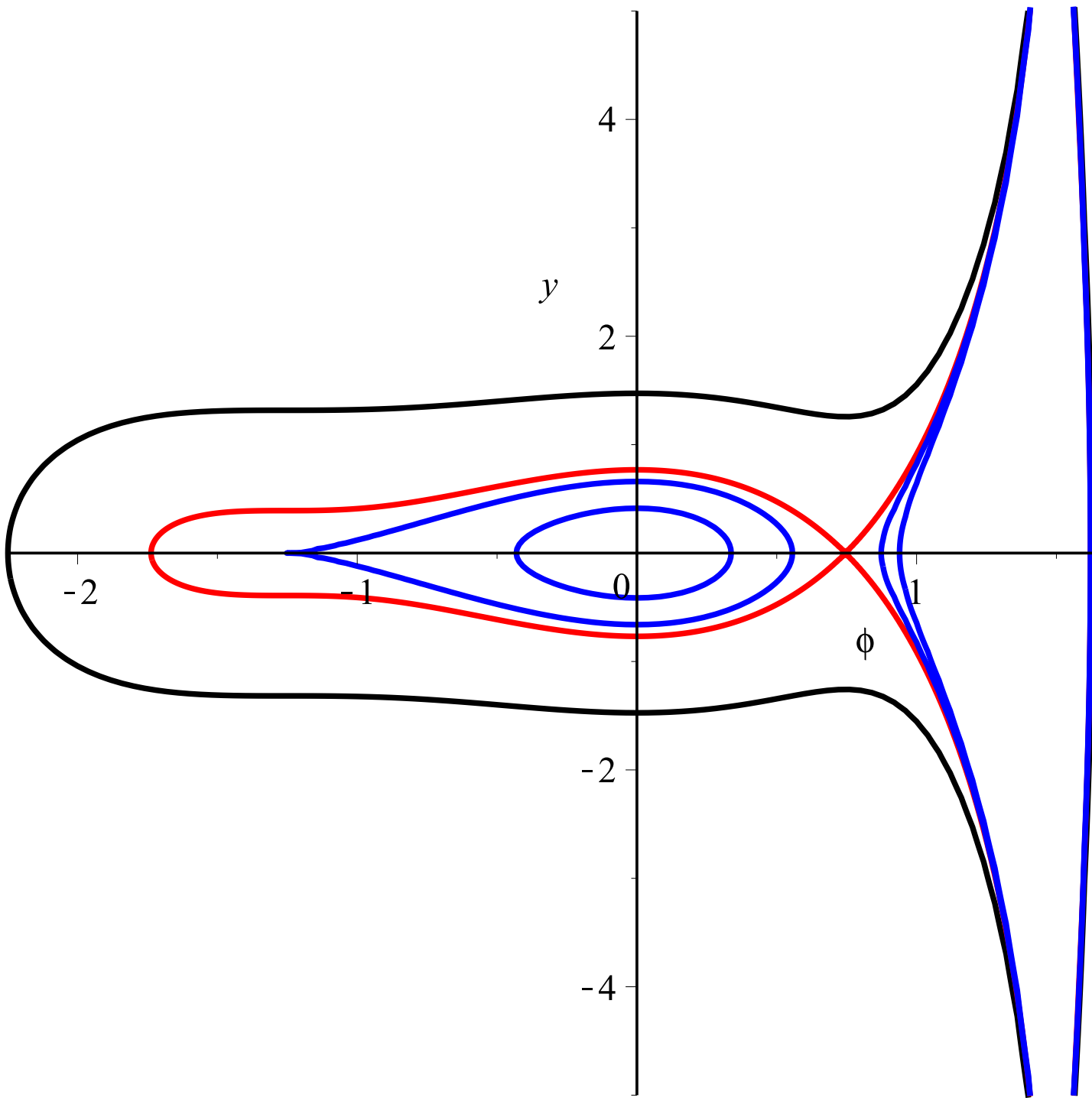

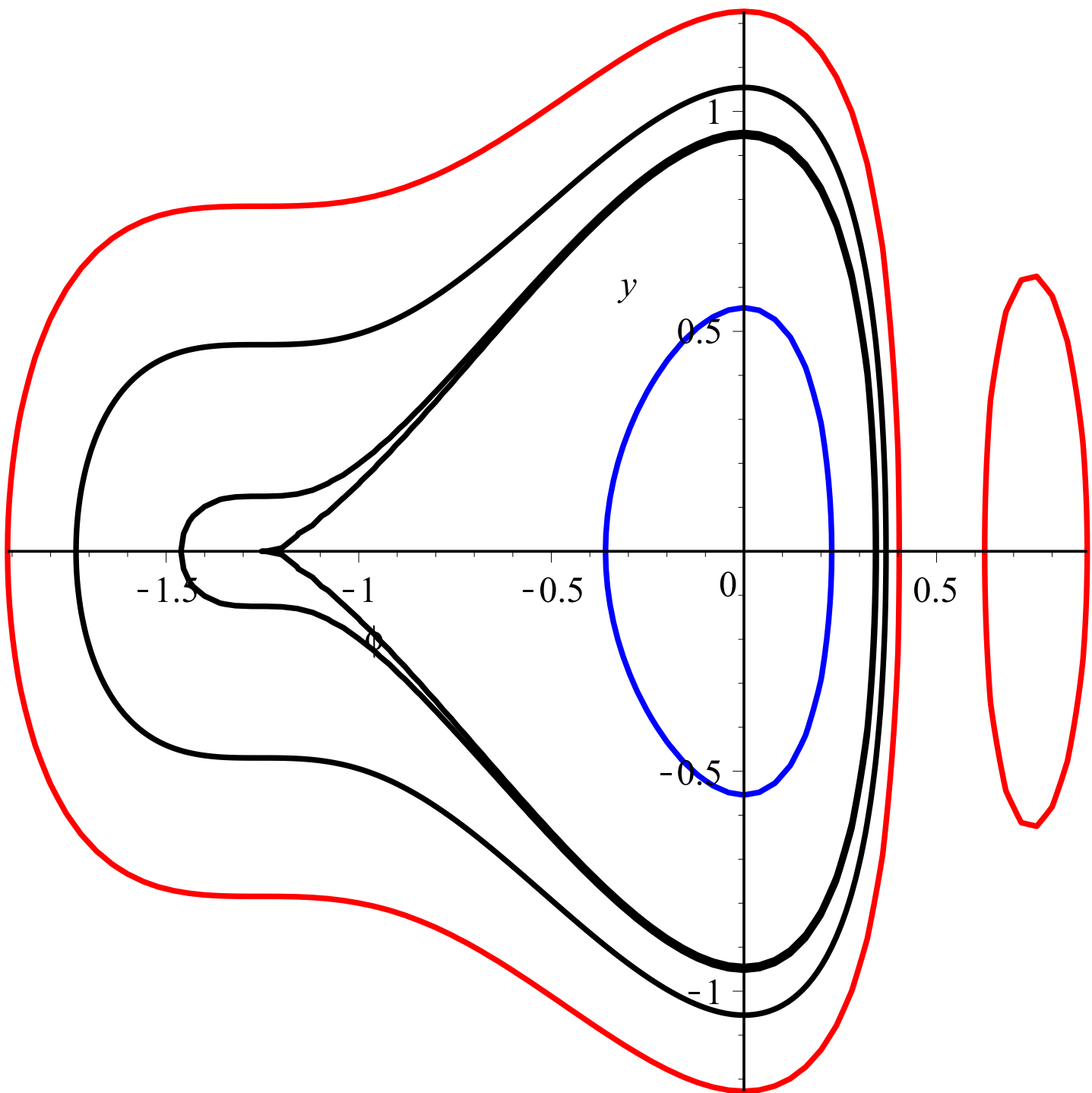

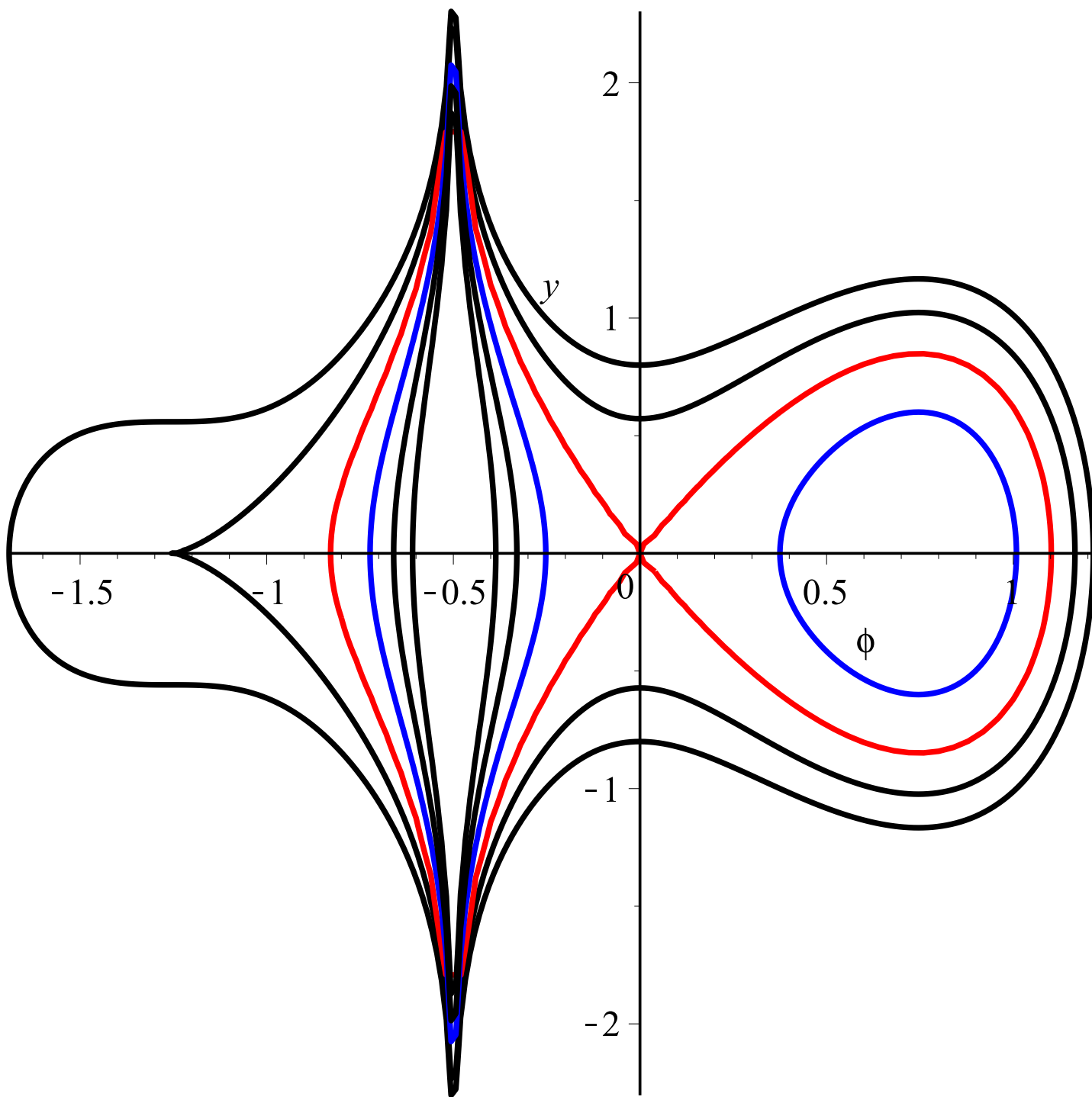

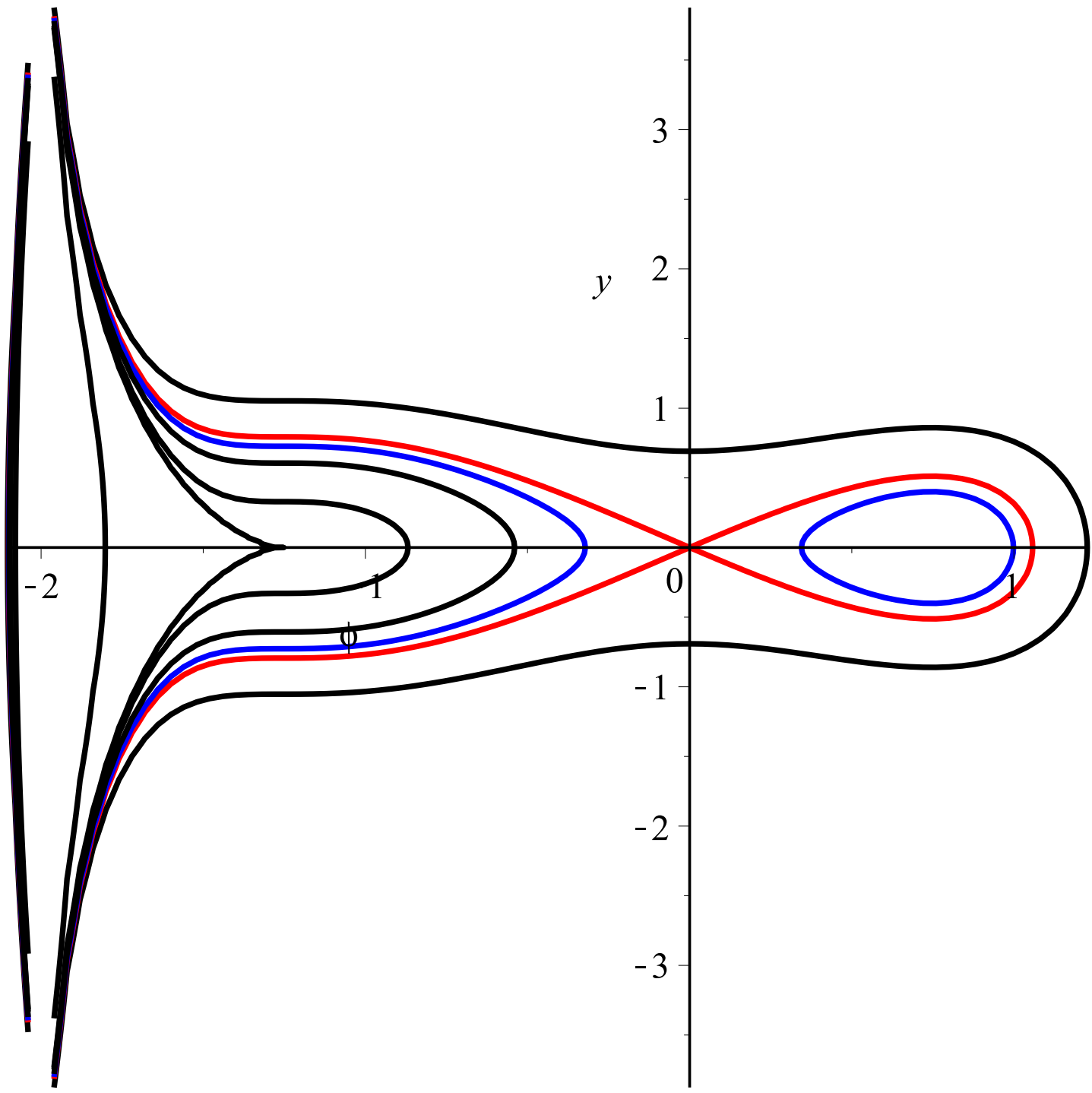

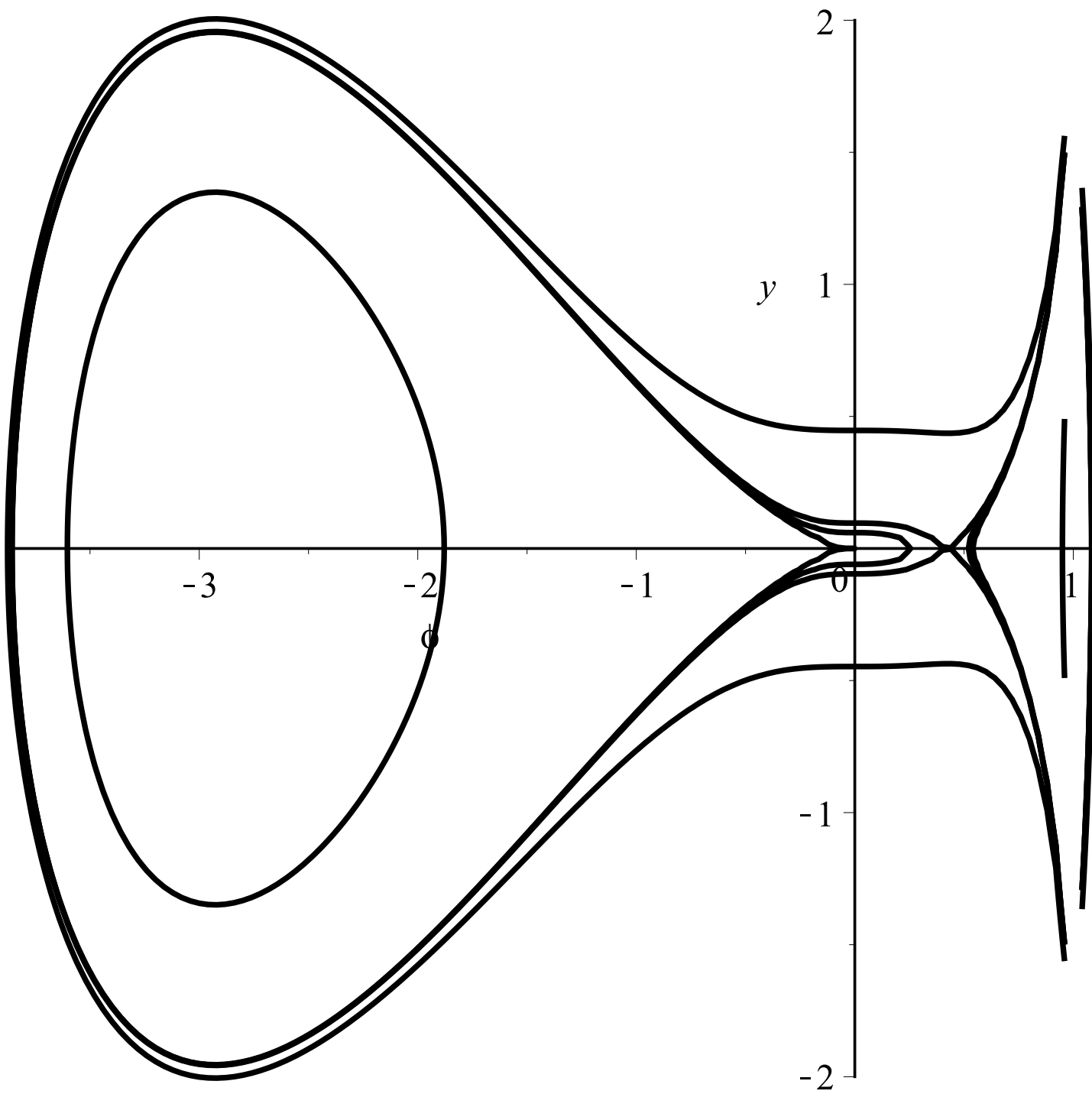

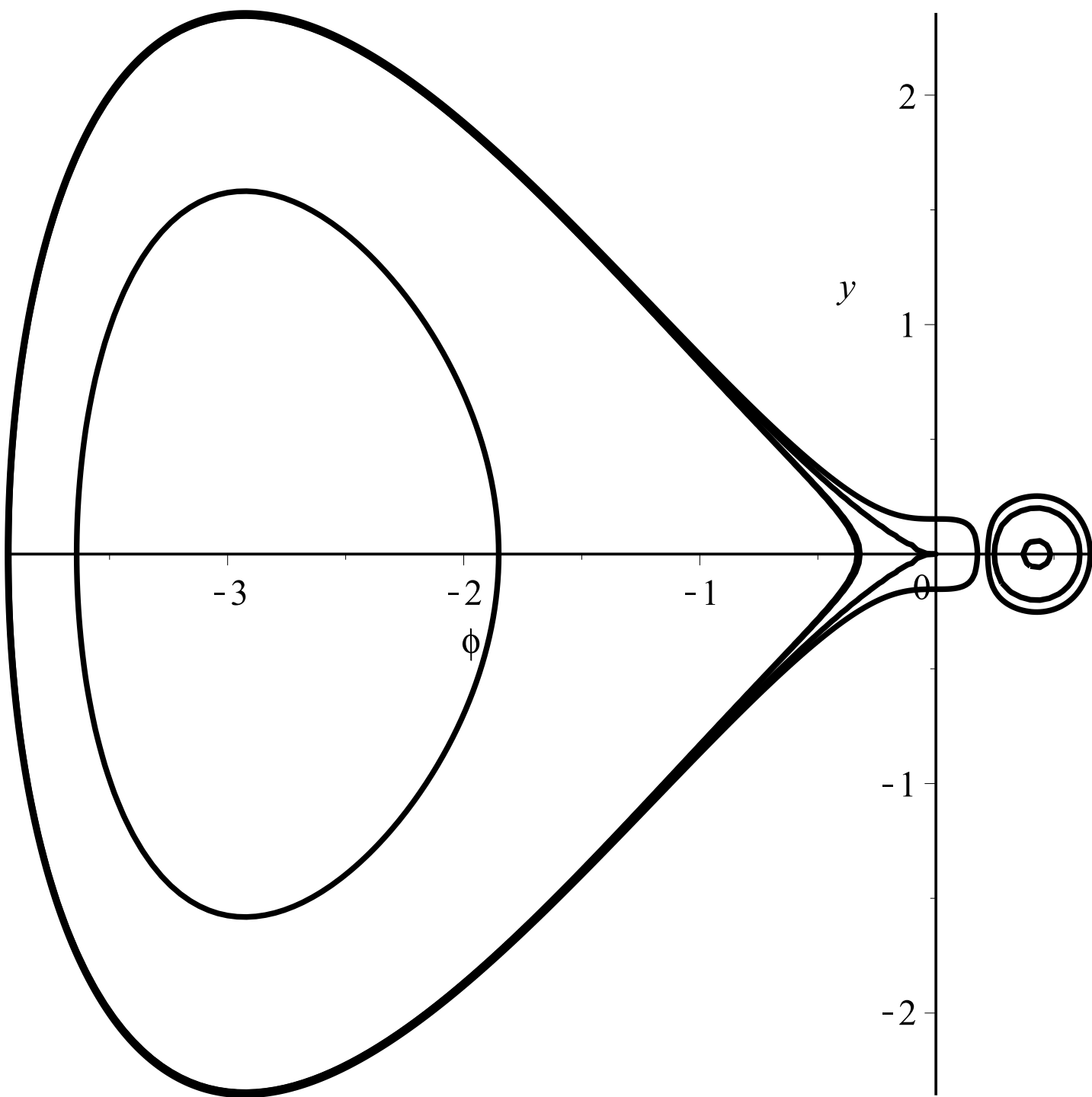

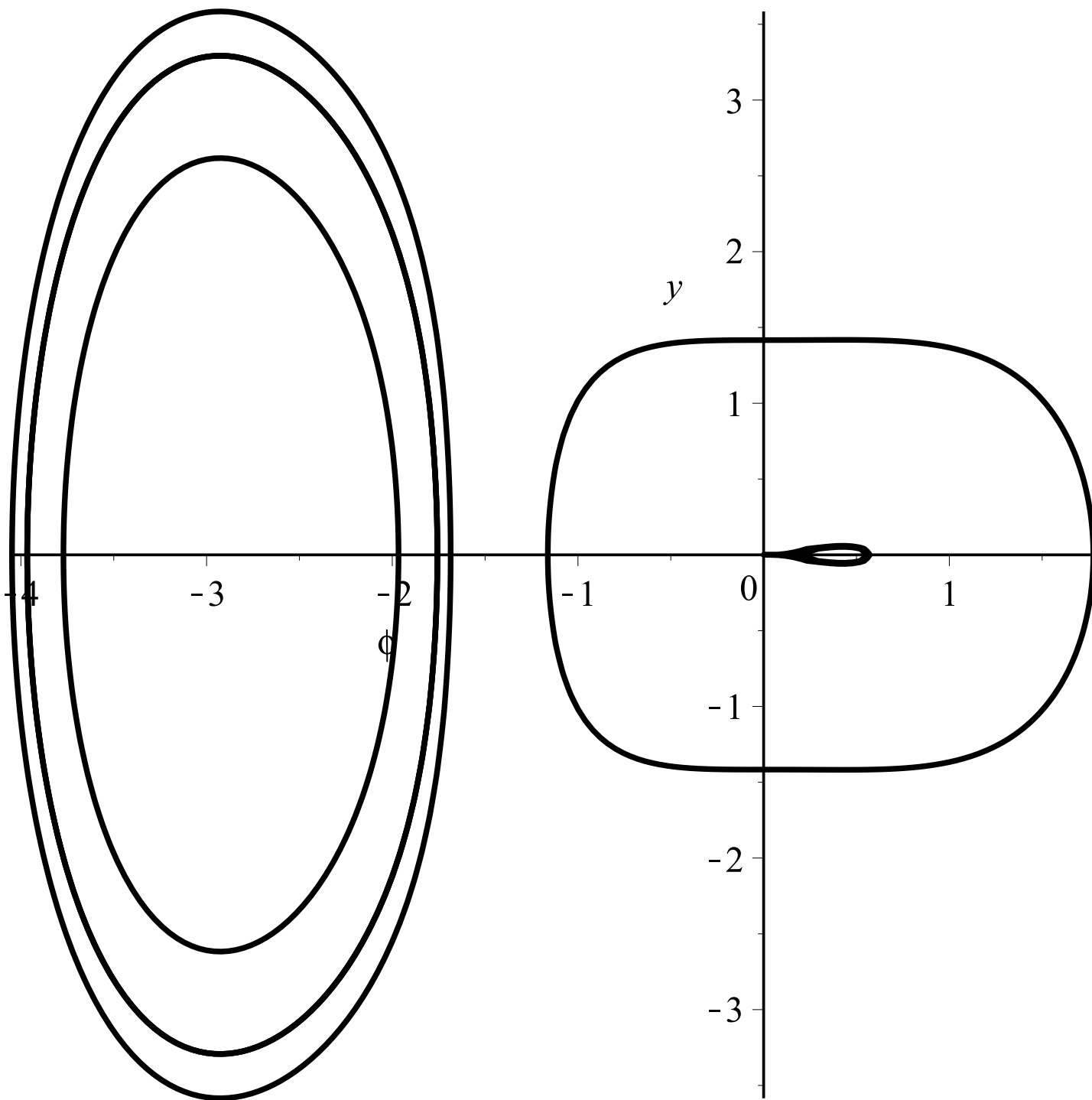

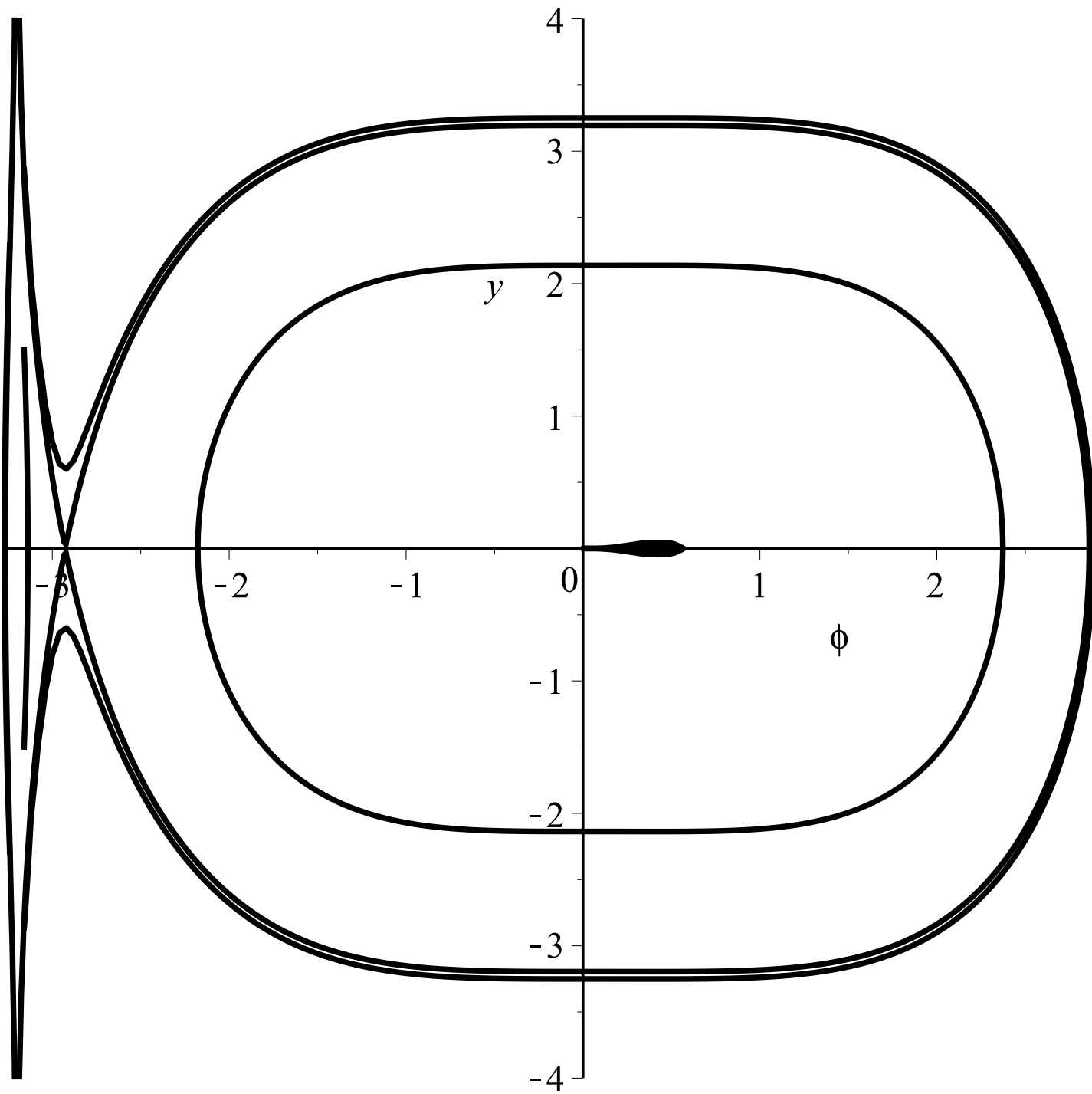

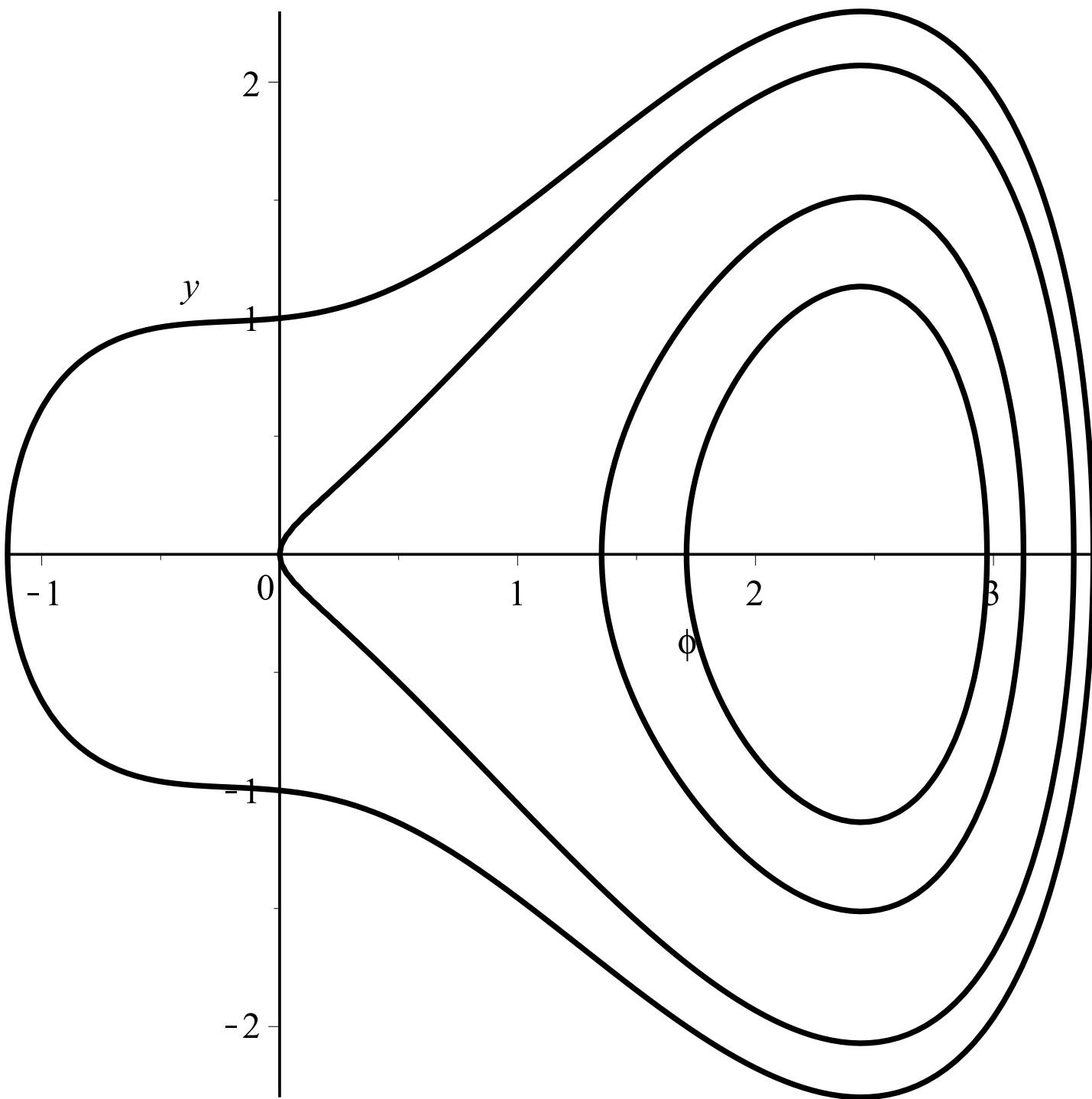

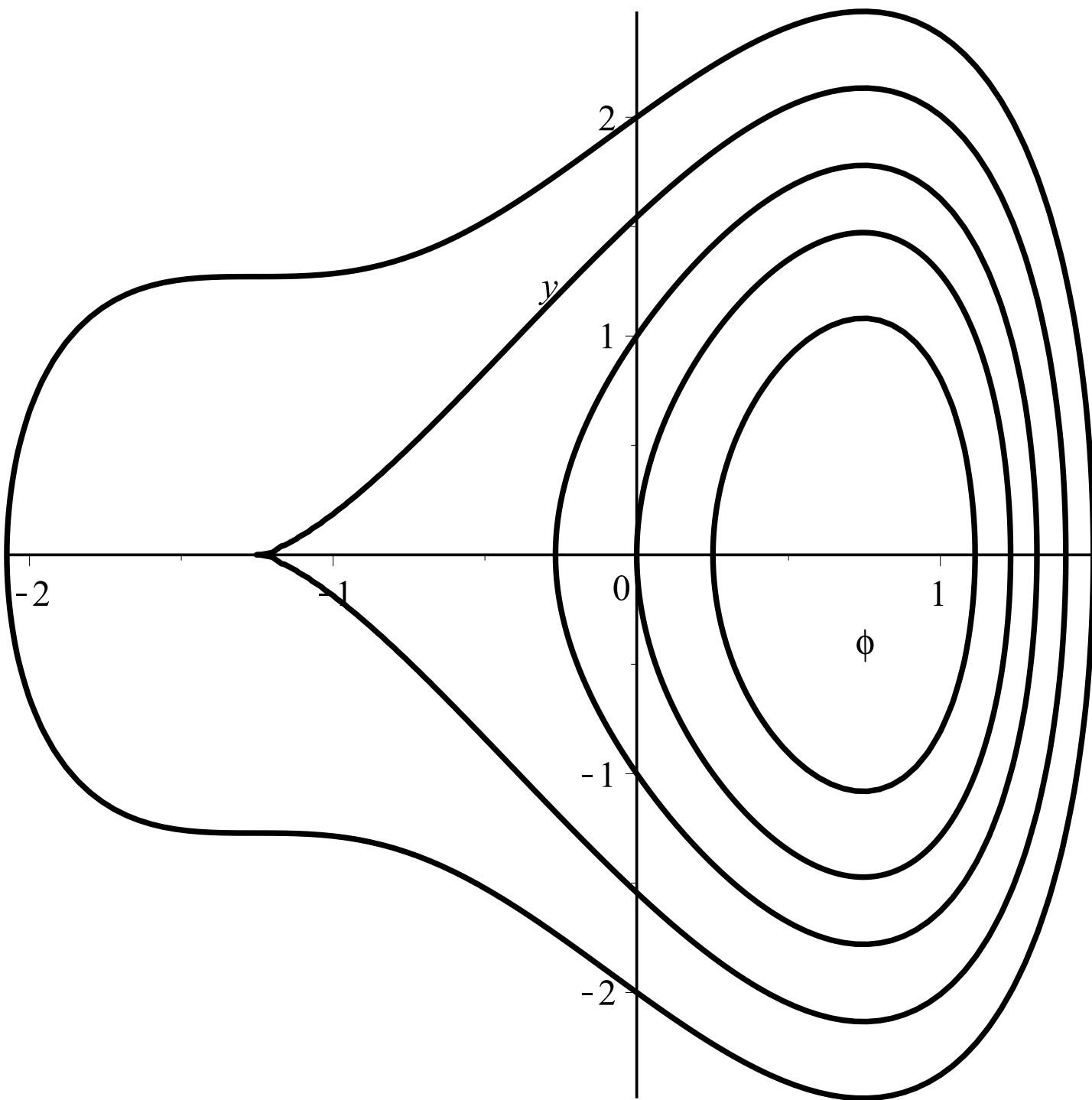

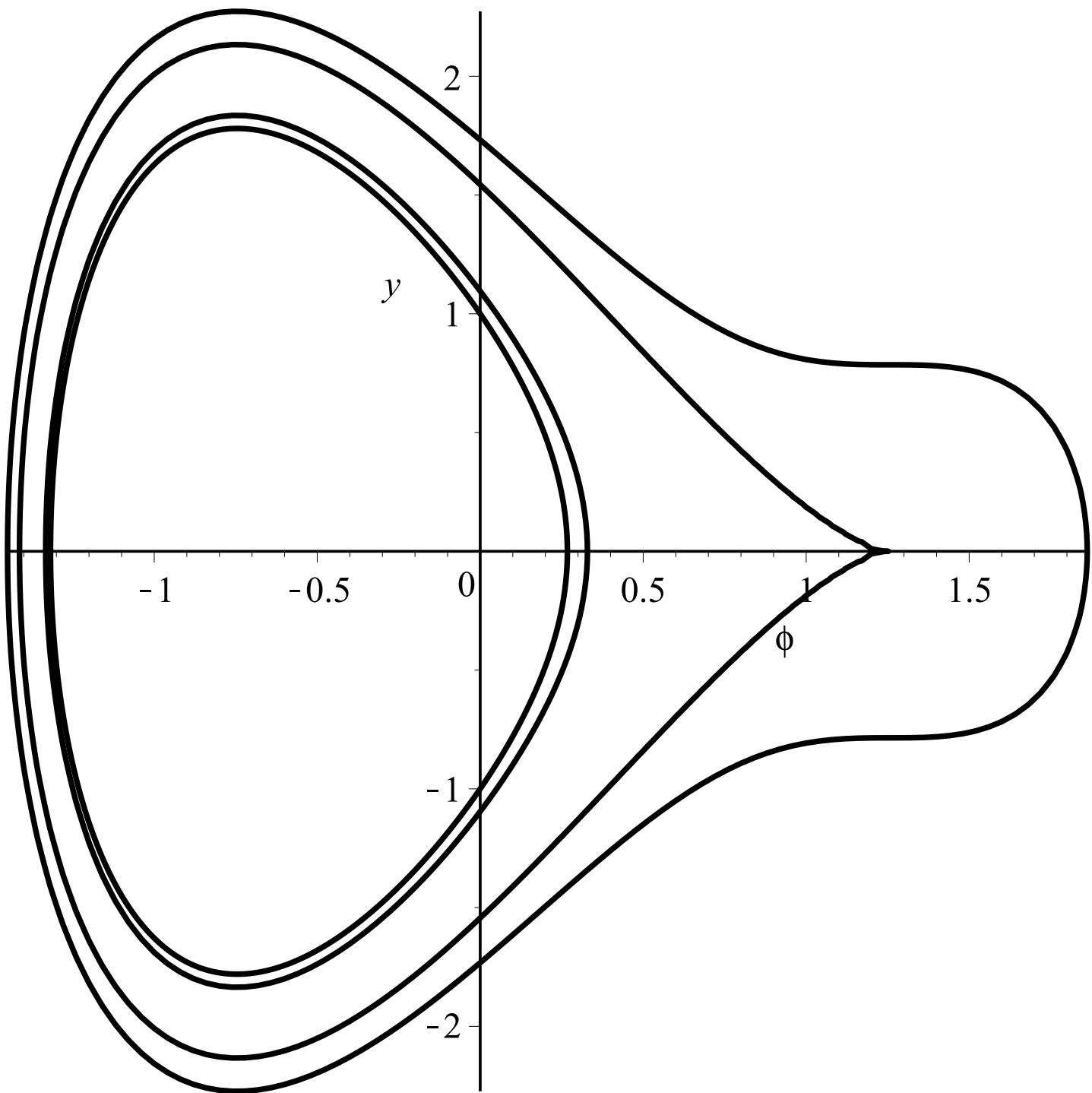

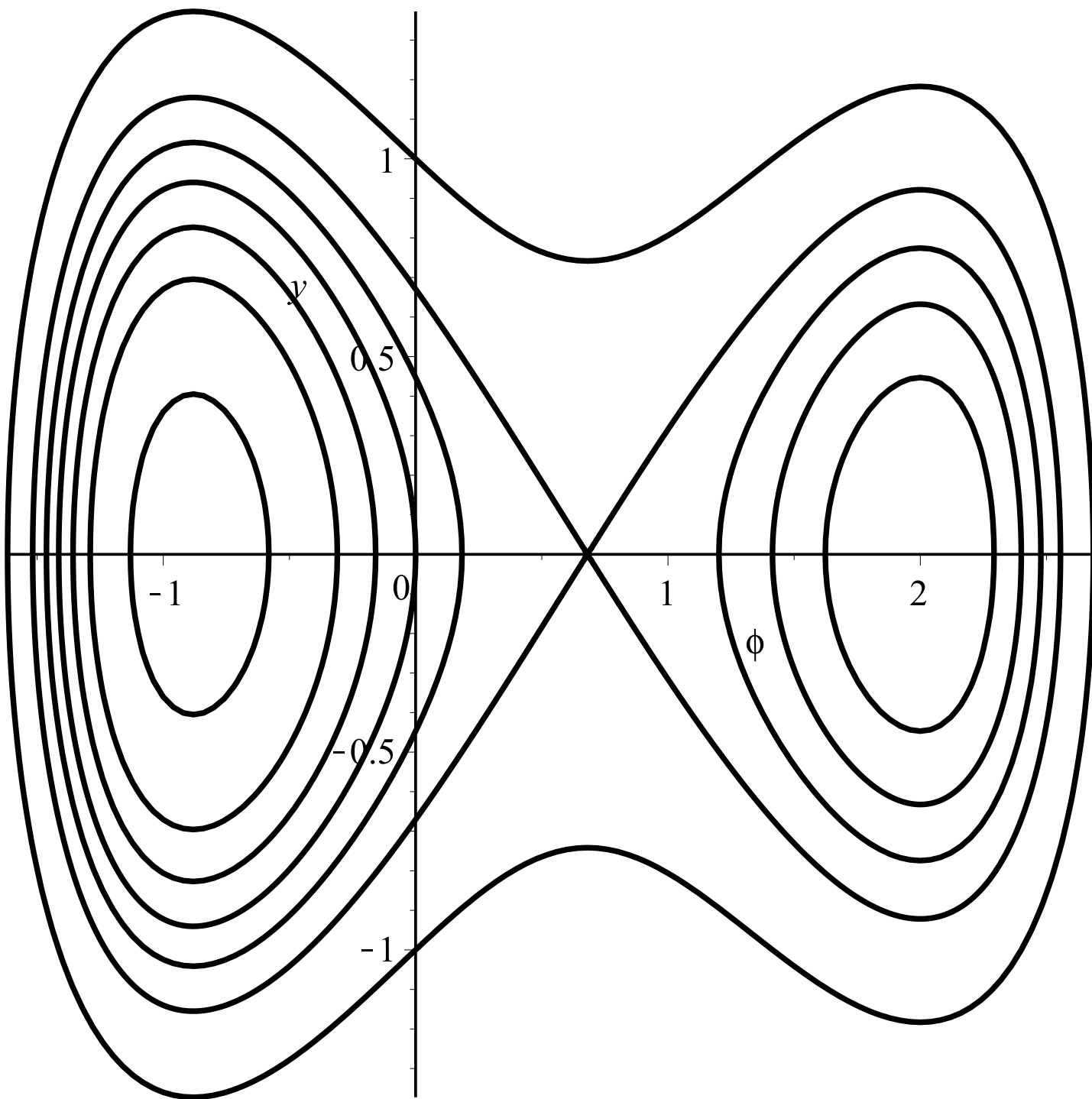

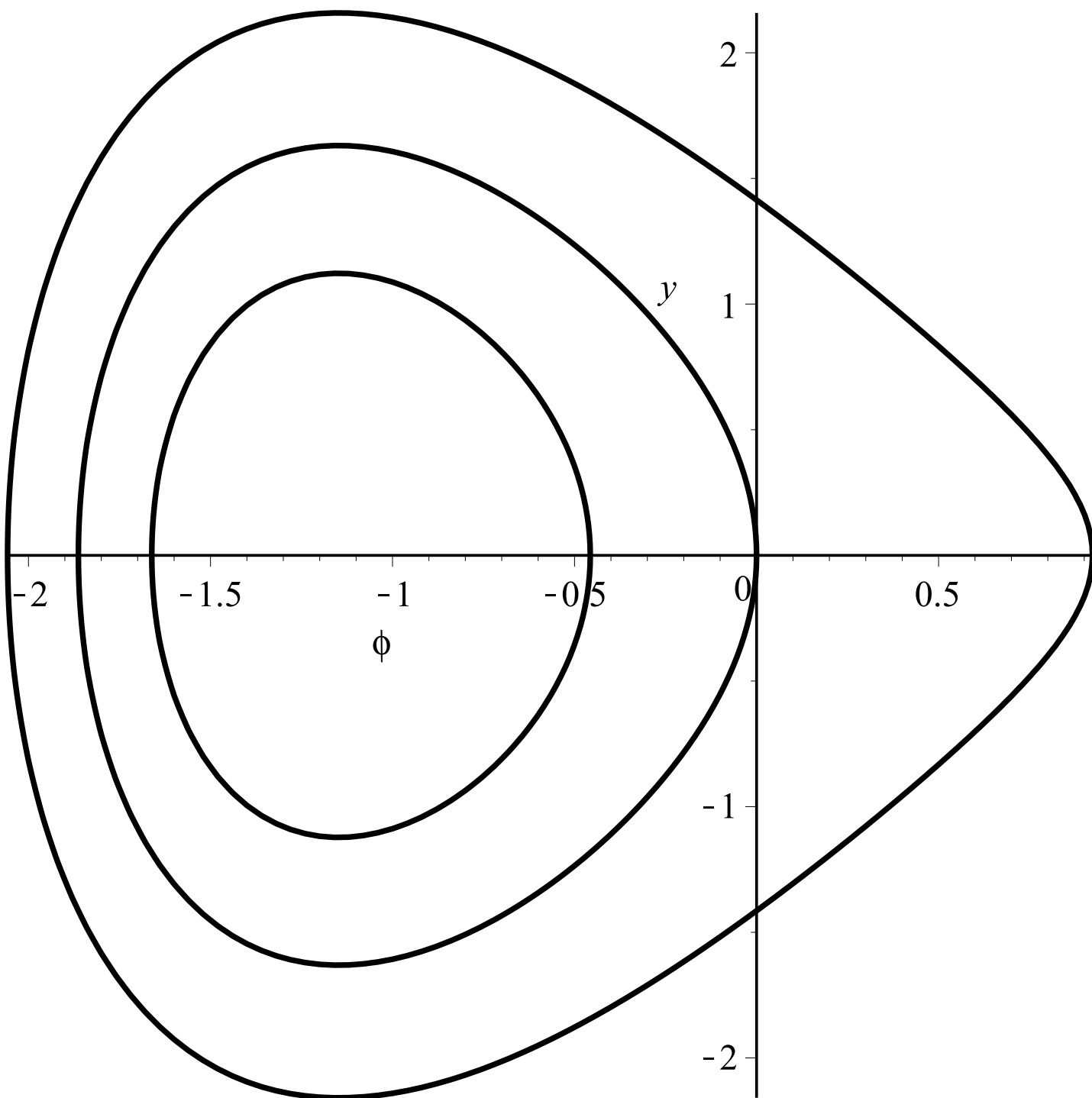

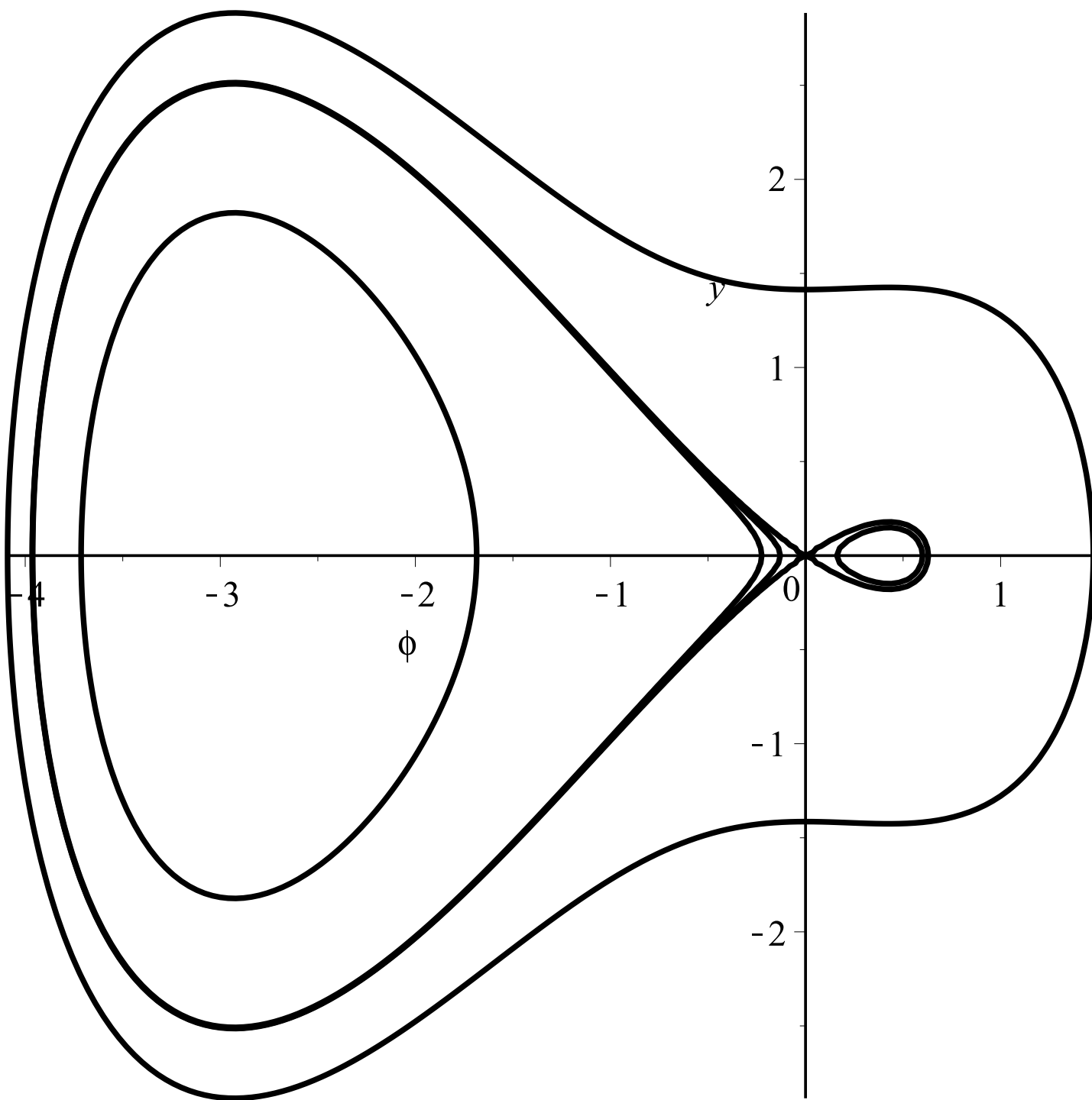

x -3
-2
-1
0
1
2
3
2.4

2.2 This figure "fig18b.jpg" is available in "jpg" format from:

2.0 <http://arxiv.org/ps/2202.11706v1>

1.8

1.6

1.4

1.2

1.0

0.8

4

2

0

t

-2

-4

