

Hitting probabilities of constrained random walks representing tandem networks

Ali Devin Sezer*

November 26, 2021

Abstract

Let X be the constrained random walk on \mathbb{Z}_+^d $d > 2$, having increments $e_1, -e_i + e_{i+1}$ $i = 1, 2, 3, \dots, d-1$ and $-e_d$ with probabilities $\lambda, \mu_1, \mu_2, \dots, \mu_d$, where $\{e_1, e_2, \dots, e_d\}$ are the standard basis vectors. The process X is assumed stable, i.e., $\lambda < \mu_i$ for all $i = 1, 2, 3, \dots, d$. Let τ_n be the first time the sum of the components of X equals n . We derive approximation formulas for the probability $\mathbb{P}_x(\tau_n < \tau_0)$. For $x \in \bigcup_{i=1}^d \left\{ x \in \mathbb{R}_+^d : \sum_{j=1}^i x(j) > \left(1 - \frac{\log \lambda / \min \mu_i}{\log \lambda / \mu_i} \right) \right\}$ and a sequence of initial points $x_n/n \rightarrow x$ we show that the relative error of the approximation decays exponentially in n . The approximation formula is of the form $\mathbb{P}_y(\tau < \infty)$ where τ is the first time the sum of the components of a limit process Y is 0; Y is the process X as observed from a point on the exit boundary except that it is unconstrained in its first component (in particular Y is an unstable process); Y and $\mathbb{P}_y(\tau < \infty)$ arise naturally as the limit of an affine transformation of X and the probability $\mathbb{P}_x(\tau_n < \tau_0)$. The analysis of the relative error is based on a new construction of supermartingales. We derive an explicit formula for $\mathbb{P}_y(\tau < \infty)$ in terms of the ratios λ/μ_i which is based on the concepts of harmonic systems and their solutions and conjugate points on a characteristic surface associated with the process Y ; the derivation of the formula assumes $\mu_i \neq \mu_j$ for $i \neq j$.

1 Introduction and Definitions

For an integer $d \geq 3$ let X be a random walk with independent and identically distributed increments $\{I_1, I_2, I_3, \dots\}$, $I_k \in \mathcal{V} \subset \mathbb{Z}^d$, constrained to remain in \mathbb{Z}_+^d , i.e.,

$$X_{k+1} = X_k + \pi(X_k, I_{k+1}),$$

where

$$\pi(x, v) \doteq \begin{cases} v, & \text{if } x + v \in \mathbb{Z}_+^d \\ 0, & \text{otherwise.} \end{cases}$$

The constraining boundaries of X are

$$\partial_j = \{x \in \mathbb{Z}^d : x(j) = 0\}, j \in \{1, 2, 3, \dots, d\}.$$

*Middle East Technical University, Institute of Applied Mathematics, Ankara, Turkey, devin-sezer@gmail.com. Sections 3,4 and 5 of the present work are revisions of Sections 5,6 and subsection 8.3 of [9]

For $A_n \doteq \{x \in \mathbb{Z}_+^d : \sum_{i=1}^d x(i) \leq n\}$ and $\partial A_n \doteq \{x \in \mathbb{Z}_+^d : \sum_{i=1}^d x(i) = n\}$ define the stopping time

$$\tau_n \doteq \inf\{k \geq 0 : X_k \in \partial A_n\}.$$

The goal of this work is to develop approximations of the hitting probability

$$\mathbb{P}_x(\tau_n < \tau_0)$$

for $x \in \mathbb{Z}_+^d$, $x \in A_n$ when X is a constrained random walk that represents d queues in tandem (a tandem network), i.e., when the set of possible increments of X are

$$\mathcal{V} = \{e_1, -e_1 + e_2, \dots, -e_j + e_{j+1}, \dots, -e_{d-1} + e_d, -e_d\},$$

$$e_i(j) = \begin{cases} 1, & \text{if } i = j, \\ 0, & \text{otherwise,} \end{cases}$$

$i, j = 1, 2, 3, \dots, d$; $\{e_i, i = 1, 2, 3, \dots, d\}$ are the unit vectors in \mathbb{Z}^d . The distribution of the increments is given as follows:

$$\begin{aligned} \mathbb{P}(I_k = e_1) &= \lambda, \\ \mathbb{P}(I_k = e_{i+1} - e_i) &= \mu_i, \quad i = 1, 2, 3, \dots, d-1, \\ \mathbb{P}(I_k = -e_d) &= \mu_d. \end{aligned}$$

We assume X to be stable:

$$\lambda < \max_{i=1}^d \mu_i \tag{1}$$

which implies

$$\rho_i \doteq \lambda/\mu_i, \quad \rho \doteq \max_i \rho_i < 1.$$

The random walk X can represent d servers/processes working in tandem; in this interpretation, λ is the arrival rate to the first queue the μ_i are the processing rates of the servers and the components of X are the number of items/packets waiting for service and the probability $p_n(x) = \mathbb{P}_x(\tau_n < \tau_0)$ is the probability that the number of packets in the system reaches n before the system empties. The analysis of p_n goes at least back to [4, 7]. Stability of X implies that this probability decays exponentially in n . Its exponential decay rate (i.e., the large deviations limit) is computed in [4, 5] as

$$\lim_{n \rightarrow \infty} -\frac{1}{n} \log p_n(x_n) = -\log \rho$$

for $x = x_n$, $x_n/n \rightarrow 0$. Because it is an exponentially decaying probability its simulation requires variance reduction algorithms, see, e.g., [3, 1] and the references in these works. The work [10] develops precise analytical formulas for this probability for $d = 2$ based on an affine transformation of X and $\mathbb{P}_x(\tau_n < \tau_0)$; the goal of the present work is to extend these results to dimensions 3 or more. There is a wide literature on the approximation/simulation of probabilities of the type $\mathbb{P}_x(\tau_n < \tau_0)$; we refer the reader to [10, Sections 1,6] for a literature review.

Let $\mathcal{I}_1 \in \mathbb{R}^{d \times d}$ be the diagonal matrix with diagonal entries $\mathcal{I}_1(1, 1) = -1$, $\mathcal{I}_1(j, j) = 1$ $j > 1$ and $T_n = n + \mathcal{I}_1$. Define

$$J_k \doteq \mathcal{I}_1 I_k, \quad Y_{k+1} \doteq Y_k + \pi_1(Y_k, J_{k+1}), \tag{2}$$

where

$$\pi_1(y, v) \doteq \begin{cases} v, & \text{if } x + v \in \mathbb{Z} \times \mathbb{Z}_+^{d-1} \\ 0, & \text{otherwise.} \end{cases}$$

Define, $\Omega_Y \doteq \mathbb{Z} \times \mathbb{Z}_+^{d-1}$,

$$B \doteq \left\{ y \in \Omega_Y, y(1) \geq \sum_{j=2}^d y(j) \right\};$$

the boundary of B is

$$\partial B = \left\{ y \in \Omega_Y, y(1) = \sum_{j=2}^d y(j) \right\}.$$

The limit stopping time

$$\tau \doteq \inf\{k : Y_k \in \partial B\}$$

is the first time Y hits ∂B . Our goal is to approximate $\mathbb{P}_x(\tau_n < \tau_0)$ by the limit probability $\mathbb{P}_{T_n(x)}(\tau < \infty) = \mathbb{P}(\tau < \infty | Y_0 = T_n(x))$. The process $Y^n = T_n(X)$ is the process X as observed from the boundary point $(n, 0, \dots, 0) \in \partial A_n$. The limit process Y and the limit probability $\mathbb{P}_y(\tau < \infty)$ is obtained by letting $n \rightarrow \infty$, see Figure 1 for an illustration in two dimensions.

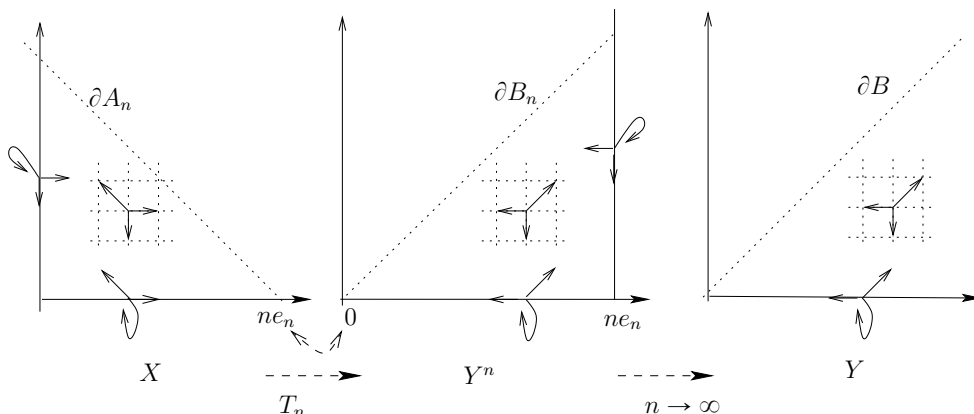

Figure 1: Derivation of the limit problem via an affine transformation in two dimensions

Define

$$R_\rho \doteq \bigcap_{i=1}^d \left\{ x \in \mathbb{R}_+^d : \sum_{j=1}^i x(j) \leq \left(1 - \frac{\log \rho}{\log \rho_i}\right) \right\}$$

$$\bar{R}_{\rho,n} \doteq \bigcup_{i=1}^d \left\{ x \in \mathbb{Z}_+^d : \sum_{j=1}^i x(j) \geq 1 + n \left(1 - \frac{\log \rho}{\log \rho_i}\right) \right\}.$$

$$g : \mathbb{R}_+^d \mapsto \mathbb{R}, g(x) = \max_{i \in \{1, 2, \dots, d\}} \left(1 - \sum_{j=1}^i x(j)\right) \log_\rho \rho_i$$

First main result of the present paper is the following:

Theorem 1.1. For $\epsilon > 0$ there exists $n_0 > 0$ such that

$$\frac{|\mathbb{P}_x(\tau_n < \tau_0) - \mathbb{P}_{T_n(x)}(\tau < \infty)|}{\mathbb{P}_x(\tau_n < \tau_0)} \leq \rho^{n(1-g(x/n)-\epsilon)} \quad (3)$$

for all $n > n_0$ and for any $x \in \bar{R}_{\rho,n}$. In particular, for $x_n/n \rightarrow x \in A - R_\rho$ the relative error decays exponentially with rate $-\log(\rho)(1 - g(x)) > 0$, i.e.,

$$\liminf_n -\frac{1}{n} \log \left(\frac{|\mathbb{P}_{x_n}(\tau_n < \tau_0) - \mathbb{P}_{T_n(x_n)}(\tau < \infty)|}{\mathbb{P}_{x_n}(\tau_n < \tau_0)} \right) \geq -\log(\rho)(1 - g(x)). \quad (4)$$

A precise statement corresponding to Figure 1 is [10, Proposition 1] which states

$$\lim_n \mathbb{P}_{T_n(y)}(\tau_n < \tau_0) = \mathbb{P}_y(\tau < \infty), y \in B, \quad (5)$$

for any stable Jackson network in any dimension. In (5) the initial point of the process is specified and fixed in y -coordinates; in (4) it is specified in scaled x coordinates (as is done in large deviations analysis). For fixed $y \in B$, the probability $\mathbb{P}_{T_n(y)}(\tau_n < \tau_0)$ doesn't decay to 0 in n but converges to the nonzero probability $\mathbb{P}_y(\tau < \infty)$. In (4), where the initial position is fixed in scaled x coordinates both of the probabilities $\mathbb{P}_{x_n}(\tau_n < \tau_0)$ and $\mathbb{P}_{T_n(x_n)}(\tau < \infty)$ decay to 0 exponentially. The limit (4) expresses that the difference between them decays exponentially faster than $\mathbb{P}_{x_n}(\tau_n < \tau_0)$.

Previous results of the type (4) are as follows: [10, Proposition 8] treats the case $d = 2$, [11, Theorem 6.1] treats the constrained simple random walk in two dimensions (i.e., the constrained random walk with increments $\pm e_i$, $i = 1, 2$) and [6, Theorem 6.1] treats the case $d = 2$ when the dynamics of the constrained random walk is Markov modulated (i.e., in addition to X there is an additional finite state Markov chain M that determines the jump distributions of X). These prior results state that the relative error on the left side of (4) converges to 0 exponentially at a rate depending on x ; the precise formulation of the decay rate as in the right side of (4) is new. The prelimit statement (3) that is specified in terms of an unscaled initial point x is also new. Theorem 1.1 uses only the stability assumption on model parameters; all of the prior results just cited use an additional assumption, which in the present case would be $\mu_i \neq \mu_j$ for $i \neq j$; dropping of this assumption in the error analysis arises from a significant change in the argument and we comment on it below (see the third paragraph below). We will assume $\mu_i \neq \mu_j$ for $i \neq j$ in Theorem 4.1 which gives an explicit formula for $\mathbb{P}_y(\tau < \infty)$.

As in the works just cited we will use the following idea in our analysis of the relative error: because the dynamics of X and Y differ only on ∂_1 , the events $\{\tau_n < \tau_0\}$ and $\{\tau < \infty\}$ mostly overlap. This is proved as follows: 1) find an event containing the difference of the events $\{\tau_n < \tau_0\}$ and $\{\tau < \infty\}$ 2) prove that the upperbound event has a small probability. Let $\bar{\tau}_0 = \inf \left\{ k \geq 0 : \sum_{j=1}^d Y_k(j) = n \right\} = \inf \left\{ k \geq 0 : \sum_{j=1}^n T_n(Y_k(j)) = 0 \right\}$ and let $\sigma_{j,j+1}$ be the first time X hits ∂_{j+1} after hitting ∂_j (see (6) for the precise definition). Lemmas 1, 2 and 3 show that the difference between $\{\tau_n < \tau_0\}$ and $\{\tau < \infty\}$ is contained in the union of $\{\bar{\tau}_0 < \tau < \infty\}$ and $\{\sigma_{d-1,d} < \tau_n < \tau_0\}$. The proofs of these lemmas are more complex compared to their counterparts [10, 6] because d is now arbitrary. Some of the novelties are explained in the paragraphs below.

A function $f : \Omega_Y \mapsto \mathbb{R}$ is said to be Y -(sub/super)harmonic if $f(y) = (\leq / \geq) \mathbb{E}_y[f(Y_1)]$ for all $y \in \Omega_Y$. Note that $y \mapsto \mathbb{P}_y(\tau < \infty) = \mathbb{P}(\tau < \infty | Y_0 = y)$ is a Y -harmonic function. An upperbound on the probability $\mathbb{P}_y(\bar{\tau}_0 < \tau < \infty)$ follows from the Markov property of Y

and an upperbound on $\mathbb{P}_y(\tau < \infty)$; in subsection 2.1 we construct an upperbound for this probability. In previous works treating two dimensions the upperbound follows directly from the computation/approximation of $\mathbb{P}_y(\tau < \infty)$: in [10] there is a simple explicit formula for $\mathbb{P}_y(\tau < \infty)$ and in [6] an upperbound can be constructed in terms the Y -harmonic functions used in the computation of $\mathbb{P}_y(\tau < \infty)$. In the present setup the formula for $\mathbb{P}_y(\tau < \infty)$ is more complex (see Theorem 4.1); instead of it, in subsection 2.1 we construct simpler Y -superharmonic functions (and corresponding supermartingales) that imply the bound we seek on $\mathbb{P}_y(\tau < \infty)$ (we comment on this further in the next paragraph). Subsection 2.2 derives an upperbound on the probability $\mathbb{P}_x(\sigma_{d-1,d} < \tau_n < \tau_0)$ (Proposition 2.5). For the proof we construct a supermartingale corresponding to the event $\{\sigma_{d-1,d} < \tau_n < \tau_0\}$. The event happens in d stages (the process moves from stage j to $j + 1$ upon hitting ∂_{j+1}); the supermartingale is obtained by applying one of the Y -superharmonic functions of subsection 2.1 to X at each stage. Because Y has unconstrained dynamics on ∂_1 , the process resulting from the application of these functions is not a supermartingale on ∂_1 ; to compensate for this we add a strictly decreasing term to the resulting process (see (31)). As in previous works [10, 11, 6] we truncate time to manage this additional term (see (39)).

For $\beta \in \mathbb{C}$ and $\alpha \in \mathbb{C}^{\{2,3,4,\dots,d\}}$ define the function $[(\beta, \alpha), \cdot] : \mathbb{Z}^d \mapsto \mathbb{C}$ as

$$[(\beta, \alpha), y] = \beta^{y^{(d)} - \sum_{j=2}^n y^{(j)}} \prod_{j=2}^d \alpha^{(j)y^{(j)}}.$$

In [10, 11, 6] the supermartingales in the relative error analysis are constructed from functions of the above form where at least some of the parameters β and α take values in $\{\rho_i, i = 1, 2\}$. A novel feature of the analysis in the present work is the use of values for these parameters that are strictly different from ρ_i , see Propositions 2.1 and 2.2. This allows the construction of strictly Y -superharmonic functions which have much simpler structures compared to the Y -harmonic functions appearing in the computation of $\mathbb{P}_y(\tau < \infty)$. The construction of the just mentioned strictly Y -superharmonic functions do not need any assumptions beyond the stability assumption (1); this is the reason we are able to derive (3) and (4) based only on the stability assumption.

With this theorem, the approximation of $\mathbb{P}_x(\tau_n < \tau_0)$ reduces to the computation of $\mathbb{P}_y(\tau < \infty)$. Considered as a function $y \mapsto \mathbb{P}_y(\tau < \infty)$ of y , this probability is the unique ∂B -determined Y -harmonic function taking the value 1 on ∂B . Section 3 reduces the construction of these functions to solutions of systems of equations represented by graphs with labeled edges (a “harmonic system”, see Definition 3.2). This reduction can be easily carried out for constrained random walks arising from any Jackson network and therefore in this section we will work in that generality. Section 4 introduces a class of harmonic systems for tandem networks and provides solutions for them. Theorem 4.1 gives an explicit formula for $y \mapsto \mathbb{P}_y(\tau < \infty)$ as a linear combination of the functions defined by these solutions. Section 5 provides numerical examples showing the effectiveness of the formulas obtained. In Section 6 we comment on future work.

2 Error Analysis

The goal of this section is to prove Theorem 1.1. This theorem generalizes [10, Proposition 8], which treats $d = 2$, to an arbitrary positive dimension $d > 0$. The proof is based on the

stopping times

$$\begin{aligned}\sigma_{0,1} &\doteq \inf\{k \geq 0 : X_k \in \partial_1\} \\ \sigma_{j-1,j} &\doteq \inf\{k > \sigma_{j-2,j-1} : X_k \in \partial_j\}, j = 2, 3, \dots, d.\end{aligned}\tag{6}$$

Time τ_0 is the first time the set of all components of X equal 0; this definition and the dynamics of X imply $\tau_0 \geq \sigma_{d-1,d}$. We will use these stopping times to show that the events $\{\tau_0 < \tau\}$ and $\{\tau < \infty\}$ mostly overlap. In what follows it will be convenient to represent Y in x -coordinates: $\bar{X}_k = T_n(Y_k)$, \bar{X} has the same dynamics as X except on ∂_1 where it is not constrained, i.e.,

$$\bar{X}_{k+1} = \bar{X}_k + \pi_1(\bar{X}_k, I_{k+1});$$

\bar{X} and X processes start from the same point:

$$X_0 = \bar{X}_0 = x_n;\tag{7}$$

the Y process then has initial point $Y_0 = T_n(x_n)$. Define

$$\bar{\tau}_n \doteq \inf \left\{ k : \sum_{j=1}^d \bar{X}_k(j) = n \right\};$$

we note $\bar{\tau}_n = \tau$, therefore:

$$\mathbb{P}_{x_n}(\tau_n < \infty) = \mathbb{P}_{T_n(x_n)}(\tau < \infty).$$

Define $\mathbf{S} : \mathbb{Z}^d \rightarrow \mathbb{Z}$ as

$$\mathbf{S}(x) = \sum_{j=1}^d x(j).$$

Lemma 1.

$$\bar{X}_k(l) \geq X_k(l), l = 2, 3, \dots, j+1,\tag{8}$$

$$\bar{X}_k(l) = X_k(l), l = j+2, j+3, \dots, d,\tag{9}$$

$$\mathbf{S}(X_k) = \mathbf{S}(\bar{X}_k)\tag{10}$$

for $k \leq \sigma_{j,j+1}$, $j \in \{0, 1, 2, 3, \dots, d-1\}$;

$$\mathbf{S}(X_k) \geq \mathbf{S}(\bar{X}_k)\tag{11}$$

for $k > \sigma_{d-1,d}$.

Note that (10) holds for all j , i.e., $\mathbf{S}(X_k) = \mathbf{S}(\bar{X}_k)$, $k \leq \sigma_{d-1,d}$.

Proof. The processes X and \bar{X} have the same dynamics except on ∂_1 where only X is constrained and by assumption (7) they start from the same point. Therefore, until they hit ∂_1 they move together, i.e.,

$$X_k = \bar{X}_k$$

for $k \leq \sigma_{0,1}$. These prove (8), (9) and (10) for $j = 0$. For $j \geq 1$ we will use induction. Assume (8), (9) and (10) hold for $j = j_0 < d-1$; let us prove that they will also hold for $j = j_0 + 1$. We will do this by another induction on k , $\sigma_{j_0,j_0+1} \leq k \leq \sigma_{j_0+1,j_0+2}$. Note that there is a nested induction here, one induction on j another on k - we will refer to the induction on j as the outer induction and to the one on k as the inner induction. For $k = \sigma_{j_0,j_0+1}$ the statements hold by the outer induction hypothesis. Now assume that (8), (9) and (10), $j = j_0 + 1$, hold for $k \leq k_0$ for some $\sigma_{j_0,j_0+1} \leq k_0 < \sigma_{j_0+1,j_0+2}$. We want to show that they must also hold for $k = k_0 + 1$. We argue based on the possible positions of X and \bar{X} at time k_0 :

1. $X_{k_0} \in \mathbb{Z}_+^d - \bigcup_{j=1}^d \partial_j$: this and the inner induction hypothesis imply $\bar{X}_{k_0}(l) > 0$ for $l = 2, 3, \dots, d$; furthermore \bar{X} is not constrained on ∂_1 . These imply

$$X_{k+1} = X_k + I_{k+1}, \bar{X}_{k+1} = \bar{X}_k + I_{k+1},$$

i.e., both X and \bar{X} change by the same increment. Therefore, all of the relations (8), (9) and (10) are preserved from time $k = k_0$ to $k = k_0 + 1$.

2. X_{k_0} can also be on the boundary of \mathbb{Z}_+^d ; recall that σ_{j_0+1, j_0+2} is the first time X hits ∂_{j_0+2} after time σ_{j_0, j_0+1} . Therefore, $X_{k_0} \notin \partial_{j_0+2}$, since $\sigma_{j_0, j_0+1} \leq k_0 < \sigma_{j_0+1, j_0+2}$. Then if X_{k_0} is on the boundary of \mathbb{Z}_+^d it must be on one of the following:

$$X_{k_0} \in \partial \mathcal{M} \doteq \left(\bigcap_{m \in \mathcal{M}} \partial_m \right) \cap \left(\bigcap_{m \in \mathcal{M}^c} \partial_m^c \right)$$

for some $\mathcal{M} \subset \{1, 2, 3, \dots, j_0 + 1, j_0 + 3, \dots, d\}$:

- (a) if $I_{k_0+1} = e_1$, or $I_{k_0+1} = -e_m + e_{m+1}$ for some $m \in \mathcal{M}^c$: the increment e_1 is not constrained for X and \bar{X} regardless of their position. For the case $I_{k_0+1} = -e_m + e_{m+1}$: $X_{k_0} \in \partial_m^c$ means $X_{k_0}(m) > 0$. This and the inner induction hypothesis ((8) and (9)) imply $\bar{X}_{k_0}(m) > 0$ if $m > 1$; furthermore \bar{X} is not constrained on ∂_1 . These imply

$$X_{k_0+1} = X_{k_0} + I_{k_0+1}, \bar{X}_{k_0+1} = \bar{X}_{k_0} + I_{k_0+1}.$$

Once again this implies that the relations (8) and (9) are preserved from time $k = k_0$ to $k = k_0 + 1$.

- (b) If $I_{k_0+1} = -e_m + e_{m+1}$ for $m \geq (j_0 + 1) + 2$, $m \in \mathcal{M}$: $X_{k_0} \in \partial \mathcal{M}$ implies $X_{k_0}(m) = 0$. By the inner induction hypothesis $\bar{X}_{k_0}(m) = X_{k_0}(m)$ for $m \geq (j_0 + 1) + 2$. Therefore, $\bar{X}_{k_0}(m) = 0$ as well. These imply that the increment $-e_m + e_{m+1}$ is constrained both for X and \bar{X} :

$$X_{k_0+1} = X_{k_0}, \bar{X}_{k_0+1} = \bar{X}_{k_0}, \quad (12)$$

and the relations (8), (9) and (10) are trivially preserved from time $k = k_0$ to $k = k_0 + 1$.

- (c) If $I_{k_0+1} = -e_m + e_{m+1}$, $2 \leq m \leq j_0 + 1$, $m \in \mathcal{M}$: we know by the induction hypothesis that $\bar{X}_{k_0}(m) \geq X_{k_0}(m)$. If $\bar{X}_{k_0}(m) = X_{k_0}(m)$ then the increment $-e_m + e_{m+1}$ is constrained both for X and \bar{X} , (12) holds and the relations (8), (9) and (10) are trivially preserved from time $k = k_0$ to $k = k_0 + 1$. If $\bar{X}_{k_0}(m) > X_{k_0}(m)$ then the increment $-e_m + e_{m+1}$ is unconstrained for \bar{X} while it is constrained for X :

$$X_{k_0+1} = X_{k_0}, \bar{X}_{k_0+1} = \bar{X}_{k_0} - e_m + e_{m+1}.$$

The linearity of \mathcal{S} and $\mathcal{S}(-e_m + e_{m+1}) = 0$ imply that (10) is preserved at time $k_0 + 1$. All of the components $\bar{X}(l)$, $l \neq m, m + 1$ remain unchanged from k_0 to $k_0 + 1$. Therefore, the relations (8) and (9) are trivially preserved for these components; in particular, this shows that (9) holds at time $k_0 + 1$ with $j = j_0 + 1$ because $m, m + 1 \leq (j_0 + 1) + 2$. To complete the proof it suffices to show that (8) holds for $j = j_0 + 1$ and $k = k_0 + 1$ for components $l = m$ and $l = m + 1$. For $l = m + 1$,

$$\bar{X}_{k_0+1}(m + 1) = \bar{X}_{k_0}(m + 1) + 1 \geq X_{k_0}(m + 1) = X_{k_0+1}(m + 1).$$

For $l = m$: recall that we are treating the case $\bar{X}_{k_0}(m) > X_{k_0}(m)$, i.e., $\bar{X}_{k_0}(m) \geq X_{k_0}(m) + 1$. Therefore:

$$\bar{X}_{k_0+1}(m+1) = \bar{X}_{k_0}(m+1) - 1 \geq X_{k_0}(m+1) = X_{k_0+1}(m+1);$$

these prove that (8) holds at time $k_0 + 1$ with $j = j_0 + 1$.

- (d) Finally, it may happen that $1 \in \mathcal{M}$ and $I_{k_0+1} = -e_1 + e_2$. In this case, $X_{k_0} \in \partial_1$ and therefore the increment I_{k_0+1} is canceled by the constraining map π for X ; \bar{X} is unconstrained on ∂_1 , therefore, the increment I_{k_0+1} is not constrained for \bar{X} . Therefore,

$$\bar{X}_{k_0+1}(l) = \bar{X}_{k_0}(l), X_{k_0+1}(l) = X_{k_0}(l), l = 3, 4, \dots, d,$$

and

$$\bar{X}_{k_0+1}(2) = \bar{X}_{k_0}(2) + 1, X_{k_0+1}(2) = X_{k_0}(2).$$

These imply that the relation (8) and (9) for $j = j_0 + 1$ are preserved from time k_0 to $k_0 + 1$. The preservation of (10) follows from the linearity of \mathbf{S} and $\mathbf{S}(-e_1 + e_2) = 1$ as in the last part.

This case by case analysis completes the inner induction step and hence the outer induction step.

$X_k \in \partial_d$ for $k = \sigma_{d-1,d}$. If $I_{k+1} = -e_d$ and $\bar{X}_k \notin \partial_d$ we have:

$$X_{k+1} = X_k, \bar{X}_{k+1} = \bar{X}_k - e_d;$$

an application of \mathbf{S} to both sides of the above equations and (10) imply $\mathbf{S}(X_{k+1}) = \mathbf{S}(\bar{X}_{k+1}) + 1$; thus $\mathbf{S}(X_{k+1}) > \mathbf{S}(\bar{X}_{k+1})$ can happen after time $\sigma_{d-1,d}$. A case by case analysis parallel to the one given above shows that (11) is preserved at all times after $\sigma_{d-1,d}$. \square

The previous lemma implies

Lemma 2. *The stopping times $\tau_n, \bar{\tau}_n$ and $\sigma_{d-1,d}$ satisfy:*

1. for any $n \geq 0$, $\sigma_{d-1,d} \geq \tau_n$ if and only if $\sigma_{d-1,d} \geq \bar{\tau}_n$.

2.

$$\tau_n = \bar{\tau}_n \tag{13}$$

over the event $\{\sigma_{d,d+1} \geq \tau_n\} = \{\sigma_{d,d+1} \geq \bar{\tau}_n\}$.

3.

$$\tau_n \geq \bar{\tau}_n \tag{14}$$

if $n < \mathbf{S}(x)$ and

$$\tau_n \leq \bar{\tau}_n \tag{15}$$

if $n > \mathbf{S}(x)$.

Proof. By definition $\tau_n \leq \sigma_{d-1,d}$ if and only if

$$\mathbf{S}(X_k) = n,$$

for some $k \leq \sigma_{d-1,d}$ and $\bar{\tau}_n \leq \sigma_{d-1,d}$ if and only if

$$\mathbf{S}(\bar{X}_k) = n,$$

for some $k \leq \sigma_{d-1,d}$. By the previous lemma $\mathbf{S}(X_k) = \mathbf{S}(\bar{X}_k)$ for $k \leq \sigma_{d-1,d}$. These imply the first two parts of the current lemma. Similarly,

$$\tau_n = \inf\{k \geq 0 : \mathbf{S}(X_k) = n\}, \quad \bar{\tau}_n = \inf\{k \geq 0 : \mathbf{S}(\bar{X}_k) = n\};$$

$\mathbf{S}(\bar{X}_k) = \mathbf{S}(X_k)$ for $k \leq \sigma_{d-1,d}$ by Lemma 1, (10). Therefore, for $\tau_n \leq \sigma_{d,d+1}$

$$\tau_n = \inf\{\sigma_{d-1,d} \geq k \geq 0 : \mathbf{S}(X_k) = n\} = \inf\{\sigma_{d-1,d} \geq k \geq 0 : \mathbf{S}(\bar{X}_k) = n\} = \bar{\tau}_n,$$

i.e., (13) holds.

The relations (10) and (11) imply that

$$\mathbf{S}(\bar{X}_k) \leq \mathbf{S}(X_k). \quad (16)$$

for all $k \geq 0$. We will argue the case when $n < \mathbf{S}(x)$, the opposite case is argued similarly. By definition, $\mathbf{S}(X_{\tau_n}) = n$. This and (16) imply $\mathbf{S}(\bar{X}_{\tau_n}) \leq n$. The process $\mathbf{S}(\bar{X})$ jumps by increments of -1 (happens when \bar{X} jumps by $-e_d$) and 1 (happens when \bar{X} jumps by e_1). It follows that \bar{X} must take all of the values $n, n+1, n+2, \dots, \mathbf{S}(x)$ in the time interval $k \in \{0, 1, 2, \dots, \tau_n\}$. This implies $\bar{\tau}_n \leq \tau_n$. \square

We now express the difference between the events $\{\tau_n \leq \tau_0\}$ and $\{\tau < \infty\} = \{\bar{\tau}_n < \infty\}$ in terms of the stopping times $\sigma_{d-1,d}$ and $\bar{\tau}_0$. For two events A and B let Δ denote their symmetric difference: $A\Delta B \doteq (A - B) \cup (B - A)$.

Lemma 3. For $X_0 = x$, $0 < \mathbf{S}(x) < n$

$$\{\tau_n < \tau_0\}\Delta\{\bar{\tau}_n < \infty\} \subset \{\tau_n < \tau_0, \tau_n > \sigma_{d-1,d}\} \cup \{\bar{\tau}_0 < \bar{\tau}_n < \infty\} \quad (17)$$

holds.

Proof. Break down $\{\tau_n < \tau_0\}$ and $\{\bar{\tau}_n < \infty\}$ into two as

$$\begin{aligned} \{\tau_n < \tau_0\} &= \{\tau_n < \tau_0, \tau_n \leq \sigma_{d-1,d}\} \cup \{\tau_n < \tau_0, \tau_n > \sigma_{d-1,d}\}, \\ \{\bar{\tau}_n < \infty\} &= \{\bar{\tau}_n < \infty, \bar{\tau}_n \leq \sigma_{d-1,d}\} \cup \{\bar{\tau}_n < \infty, \bar{\tau}_n > \sigma_{d-1,d}\}. \end{aligned} \quad (18)$$

That $\tau_n = \bar{\tau}_n$ for $\tau_n \leq \sigma_{d-1,d}$ and $\sigma_{d-1,d} \leq \tau_n$ if and only if $\sigma_{d-1,d} \leq \bar{\tau}_n$ imply

$$\{\tau_n < \tau_0, \tau_n \leq \sigma_{d-1,d}\} \subset \{\bar{\tau}_n < \infty, \bar{\tau}_n \leq \sigma_{d-1,d}\}. \quad (19)$$

On the other hand,

$$\{\bar{\tau}_n < \infty, \bar{\tau}_n \leq \sigma_{d-1,d}\} = \{\bar{\tau}_n < \infty, \bar{\tau}_n \leq \sigma_{d-1,d}, \bar{\tau}_0 < \bar{\tau}_n\} \cup \{\bar{\tau}_n < \infty, \bar{\tau}_n \leq \sigma_{d-1,d}, \bar{\tau}_0 > \bar{\tau}_n\}; \quad (20)$$

$\tau_0 \geq \bar{\tau}_0$ by (15) and $\tau_n = \bar{\tau}_n$ for $\bar{\tau}_n \leq \sigma_{d-1,d}$ by (13); therefore

$$\{\bar{\tau}_n < \infty, \bar{\tau}_n \leq \sigma_{d-1,d}, \bar{\tau}_0 > \bar{\tau}_n\} \subset \{\tau_n \leq \sigma_{d-1,d}, \tau_0 > \tau_n\}.$$

The last line, (18), (19) and (20) imply

$$\begin{aligned} \{\tau_n < \tau_0\}\Delta\{\bar{\tau}_n < \infty\} \\ \subset \{\tau_n < \tau_0, \tau_n > \sigma_{d-1,d}\} \cup \{\bar{\tau}_n < \infty, \bar{\tau}_n > \sigma_{d-1,d}\} \cup \{\bar{\tau}_n < \infty, \bar{\tau}_n \leq \sigma_{d-1,d}, \bar{\tau}_0 \leq \bar{\tau}_n\}. \end{aligned} \quad (21)$$

Next we decompose $\{\bar{\tau}_n < \infty, \bar{\tau}_n > \sigma_{d-1,d}\}$ into two:

$$\{\bar{\tau}_n < \infty, \bar{\tau}_n > \sigma_{d-1,d}\} = \{\bar{\tau}_n < \infty, \bar{\tau}_n > \sigma_{d-1,d}, \bar{\tau}_0 < \bar{\tau}_n\} \cup \{\bar{\tau}_n < \infty, \bar{\tau}_n > \sigma_{d-1,d}, \bar{\tau}_0 > \bar{\tau}_n\}.$$

The assumption $0 < \mathbf{S}(x) < n$, (14) and (15) imply $\tau_n \leq \bar{\tau}_n$ and $\tau_0 \geq \bar{\tau}_0$; furthermore by the first part of Lemma 2 $\tau_n > \sigma_{d-1,d}$ if and only if $\bar{\tau}_n > \sigma_{d-1,d}$; these imply

$$\{\bar{\tau}_n < \infty, \bar{\tau}_n > \sigma_{d-1,d}, \bar{\tau}_0 > \bar{\tau}_n\} \subset \{\tau_n > \sigma_{d-1,d}, \tau_0 > \tau_n\}.$$

The last two displays give:

$$\{\bar{\tau}_n < \infty, \bar{\tau}_n > \sigma_{d-1,d}\} \subset \{\bar{\tau}_n < \infty, \bar{\tau}_n > \sigma_{d-1,d}, \bar{\tau}_0 < \bar{\tau}_n\} \cup \{\tau_n > \sigma_{d-1,d}, \tau_0 > \tau_n\}.$$

This and (21) imply (17). □

By this lemma the numerator of the relative error (??) is bounded by

$$\begin{aligned} |\mathbb{P}_{x_n}(\tau_n < \tau_0) - \mathbb{P}_{T_n(x_n)}(\tau < \infty)| &\leq |\mathbb{P}_{x_n}(\{\tau_n < \tau_0\} \Delta \{\bar{\tau}_n < \infty\})| \\ &\leq \mathbb{P}_{x_n}(\tau_n < \tau_0, \tau_n > \sigma_{d-1,d}) + \mathbb{P}_{x_n}(\bar{\tau}_0 < \bar{\tau}_n < \infty). \end{aligned}$$

The next two subsections derives upperbounds on the last two probabilities. The one following them finds a lower bound on the denominator $\mathbb{P}_{x_n}(\tau_n < \tau_0)$ of the relative error. The last subsection combines these to give a proof of Theorem 2.1.

2.1 Upperbound on $\mathbb{P}_x(\bar{\tau}_n < \infty)$

Recall that $\mathbb{P}_x(\bar{\tau}_n < \infty) = \mathbb{P}_{T_n(x)}(\tau < \infty)$. The function $y \mapsto \mathbb{P}_y(\tau < \infty)$ is Y -harmonic. In Sections 3 and 4 we will compute this Y -harmonic function exactly and see that $y \mapsto \mathbb{P}_y(\tau < \infty)$ has a rather intricate structure. It turns out to be possible to derive the upperbounds we need using much simpler Y -superharmonic functions and in this subsection that is what we will do. We will derive an upperbound on the probability $\mathbb{P}_{x_n}(\bar{\tau}_n < \infty) = \mathbb{P}_{T_n(x)}(\tau < \infty)$; the bound we seek on $\mathbb{P}_{x_n}(\bar{\tau}_0 < \bar{\tau}_n < \infty)$ will follow from the bound on $\mathbb{P}_y(\tau < \infty)$ by the Markov property of Y .

The n variable plays no role here and therefore we will derive the bound and the superharmonic functions in terms of the Y process- the bound for the \bar{X} -process will follow by the change of variable $x = T_n(y)$.

A real valued function h is said to be Y -superharmonic on a set $A \subset D_Y$ if

$$\mathbb{E}_y[h(Y_1)] \leq h(y), y \in A.$$

We say h is Y -superharmonic if $A = D_Y$.

Define

$$h_{k,r} \doteq r^{y(1) - \sum_{j=2}^k y(j)}, k \in \{1, 2, 3, \dots, d\}, r > 0.$$

Proposition 2.1. *The function $h_{k,r}$ satisfies*

$$\mathbb{E}_y[h_{k,r}(Y_1)] - h_{k,r}(y) = \begin{cases} h_{k,r}(y) \left(\lambda \left(\frac{1}{r} - 1 \right) + \mu_1(r - 1) \right), & \text{if } k = 1, \\ h_{k,r}(y) \left(\lambda \left(\frac{1}{r} - 1 \right) + \mu_k(r - 1) \mathbf{1}_{\partial_k^c}(y) \right), & \text{if } k \in \{2, 3, \dots, d\}. \end{cases} \quad (22)$$

In particular, for $r \in (\rho, 1)$, $h_{1,r}$ is Y -superharmonic and for $k \in \{2, 3, 4, \dots, d\}$ $h_{k,r}$ is Y -superharmonic on $D_Y - \partial_k$.

In the proof we will use the following basic fact:

Lemma 4. For $r \in (\rho, 1)$ and any $k \in \{1, 2, 3, 4, \dots, d\}$

$$\lambda\left(\frac{1}{r} - 1\right) + \mu_k(r - 1) < 0. \quad (23)$$

Proof. The function $r \mapsto \lambda\left(\frac{1}{r} - 1\right) + \mu_k(r - 1)$ is convex for $r \in (0, \infty)$ and equals 0 for $r = \lambda/\mu_k < \rho$ and $r = 1$. It follows that it is strictly below 0 on the interval $(\rho, 1)$. \square

Proof of Proposition 2.1. For (22) The distribution of Y_1 and the definition of $h_{k,r}$ imply

$$\mathbb{E}_y[h_{k,r}(Y_1)] = h_{k,r}(y) \left(\lambda\frac{1}{r} + \mu_k r \mathbf{1}_{\partial_k^c}(y) + \mu_k \mathbf{1}_{\partial_k}(y) + \sum_{j \neq k} \mu_j \right); \quad (24)$$

subtracting $h_{k,r}(y) = h_{k,r}(y) \left(\lambda_1 + \sum_{j=1}^d \mu_j \right)$ from the last expression gives (22). For $k = 1$, Y_1 is not constrained on ∂_1 , therefore (24) in that case reduces to

$$\mathbb{E}_y[h_{k,r}(Y_1)] = h_{k,r}(y) \left(\lambda\frac{1}{\rho} + \mu_1 \rho + \sum_{j \neq 1} \mu_j \right).$$

The rest of the argument remains the same for $k = 1$. The inequality (23) and (22) imply

$$\begin{aligned} \mathbb{E}_y[h_{k,r}(Y_1)] - h_{k,r}(y) &< 0, y \in D_Y, \text{ if } k = 1, \\ \mathbb{E}_y[h_{k,r}(Y_1)] - h_{k,r}(y) &< 0, y \in D_Y - \partial_k \text{ if } k \in \{2, 3, \dots, d\}. \end{aligned}$$

This proves the Y -superharmonicity of $h_{k,r}$ (on D_Y for $k = 1$ and on $D_Y - \partial_k$ for $k > 1$). \square

Linear combinations of $h_{k,r}$ give further Y -superharmonic functions: define the constants

$$\gamma_1 \doteq 1, \gamma_k \doteq \frac{1 \min_{j < k} \gamma_j (\lambda(1 - 1/r) + \mu_j(1 - r))}{\lambda(1/r - 1)}, k = 2, 3, \dots, d. \quad (25)$$

By (23), $\gamma_k > 0$ for $r \in (\rho, 1)$. Now define

$$h_{2,k,r} \doteq \sum_{j=1}^k \gamma_j h_{j,r}.$$

Proposition 2.2. For any $k = 1, 2, 3, \dots, d$ and $r \in (\rho, 1)$ the function $h_{2,k,r}$ is Y -superharmonic

Proof. We assume throughout that $r \in (\rho, 1)$. The proof is by induction. By definition $h_{2,k,r} = h_{k,r}$ for $k = 1$ and we know that $h_{1,r}$ is Y -superharmonic by the previous proposition. Now assume that $h_{2,k,r}$ is Y -superharmonic for some $k < d$; we will prove that $h_{2,k+1,r}$ must also be Y -superharmonic. The function $h_{k+1,r}$ is Y -superharmonic on $D_Y - \partial_{k+1}$ by the previous proposition; the function $h_{2,k,r}$ is Y -superharmonic by the induction hypothesis. These and $\gamma_{k+1} > 0$ imply that $h_{2,k+1,r}$ is Y -superharmonic on $D_Y - \partial_{k+1}$. Therefore, it suffices to prove that $h_{2,k+1,r}$ is Y -superharmonic on ∂_{k+1} . Choose any $y \in \partial_{k+1}$ and let

$$k_0 = \max\{j \leq k + 1 : y(j) > 0\} \vee 1,$$

where, by convention the max of the empty set is $-\infty$. By the induction hypothesis $h_{2,k_0-1,r}$ is Y -superharmonic on ∂_k . Therefore it suffices to prove that

$$h_{2,k_0,k+1,r} \doteq \sum_{j=k_0}^{k+1} \gamma_j h_{j,r}$$

satisfies the Y -superharmonicity condition for the chosen y . The definition of k_0 implies $y(j) = 0$ for $k_0 < j \leq k+1$. This and the definition of $h_{k,r}$ imply $h_{j,r}(y) = h_{k_0,r}(y)$ for all $k_0 \leq j \leq k+1$. Then

$$\begin{aligned} & \mathbb{E}_y[h_{2,k_0,k+1,r}(Y_1)] - h_{2,k_0,k+1,r}(y) \\ &= h_{k_0,r}(y) \left(\lambda \left(\frac{1}{r} - 1 \right) \sum_{j=k_0+1}^{k+1} \gamma_j + \gamma_{k_0} \left(\lambda \left(\frac{1}{r} - 1 \right) + \mu_{k_0}(r-1) \right) \right). \end{aligned} \quad (26)$$

The definition (25) and $j > k_0$ implies

$$\gamma_j \leq \frac{1}{d} \frac{1}{\lambda \left(\frac{1}{r} - 1 \right)} \gamma_{k_0} \left(\lambda \left(1 - \frac{1}{r} \right) + \mu_{k_0}(1-r) \right).$$

Substituting this in (26) gives

$$\begin{aligned} & \mathbb{E}_y[h_{2,k_0,k+1,r}(Y_1)] - h_{2,k_0,k+1,r}(y) \\ & \leq h_{k_0,r}(y) \gamma_{k_0} \frac{d - (k+1) + k_0}{d} \left(\lambda \left(\frac{1}{r} - 1 \right) + \mu_{k_0}(r-1) \right) < 0, \end{aligned}$$

which completes the induction step. \square

Applying the Y -harmonic function $h_{2,d,r}$ to the process Y we obtain the supermartingale $h_{2,d,r}(Y_k)$, which gives us the bound we seek on $\mathbb{P}_y(\tau < \infty)$:

Proposition 2.3. *For $y \in D_Y$ and $r \in (\rho, 1)$*

$$\mathbb{P}_y(\tau < \infty) \leq \frac{1}{\gamma_d} h_{2,d,r}(y). \quad (27)$$

Proof. Let m be a positive integer. The optional sampling theorem applied to the supermartingale $k \mapsto h_{2,d,r}(Y_k)$ at the stopping time $m \wedge \tau$ gives

$$\begin{aligned} h_{2,d,r}(y) & \geq \mathbb{E}_y[h_{2,d,r}(Y_{\tau \wedge m})] \\ & = \mathbb{E}_y[h_{2,d,r}(Y_\tau) \mathbf{1}_{\{\tau \leq m\}}] + \mathbb{E}_y[h_{2,d,r}(Y_m) \mathbf{1}_{\{\tau > m\}}]. \end{aligned}$$

By definition $h_{2,d,r} \geq 0$ and $h_{2,d,r}/\gamma_d \geq h_{d,r} = 1$ on ∂B . These and the previous display imply

$$h_{2,d,r}(y)/\gamma_d \geq \mathbb{P}_y(\tau \leq m).$$

Letting $m \rightarrow \infty$ gives (27). \square

By definition

$$\mathbb{P}_x(\bar{\tau}_n < \infty) = \mathbb{P}_{T_n(x)}(\tau < \infty). \quad (28)$$

The bound on $\mathbb{P}_x(\bar{\tau}_0 < \bar{\tau}_n < \infty)$ now follows from the previous proposition and the Markov property of \bar{X} :

Proposition 2.4. For $x \in \mathbb{Z} \times \mathbb{Z}_+^{d-1}$ and $0 < \mathbf{S}(x) < n$

$$\mathbb{P}_x(\bar{\tau}_0 < \bar{\tau}_n < \infty) \leq \rho^n \frac{1}{\gamma_d} \sum_{j=1}^d \gamma_j. \quad (29)$$

Proof. By (28), (27) in x coordinates is

$$\mathbb{P}_x(\bar{\tau}_n < \infty) \leq \frac{1}{\gamma_d} h_{2,d,r}(T_n(x)) = \frac{1}{\gamma_d} \sum_{j=1}^d \gamma_j h_{d,r}(T_n(x)) = \frac{1}{\gamma_d} \sum_{j=1}^d \gamma_j r^{n - \sum_{k=1}^j x(k)}.$$

This, $x \in \mathbb{Z} \times \mathbb{Z}_+^{d-1}$ and $0 < r < 1$ imply

$$\mathbb{P}_x(\bar{\tau}_n < \infty) \leq r^n \frac{1}{\gamma_d} \sum_{j=1}^d \gamma_j$$

for $\mathbf{S}(x) = 0$. The previous display is true for any $r \in (\rho, 1)$; by continuity it is also true for $r = \rho$. The strong Markov property of \bar{X} implies

$$\mathbb{P}_x(\bar{\tau}_0 < \bar{\tau}_n < \infty) = \mathbb{E}_x \left[\mathbb{P}_{\bar{X}_{\bar{\tau}_0}}(\bar{\tau}_n < \infty) \right].$$

This, $\mathbf{S}(X_{\bar{\tau}_0}) = 0$ and the previous display imply (29). \square

2.2 Upperbound on $\mathbb{P}_x(\sigma_{d-1,d} < \tau_n < \tau_0)$

The goal of this subsection is to prove the following bound:

Proposition 2.5. For any $\epsilon > 0$ there exists $n_0 > 0$ such that

$$\mathbb{P}_x(\sigma_{d-1,d} < \tau_n < \tau_0) < \rho^{n(1-\epsilon)},$$

for $n > n_0$ and $x \in A_n$.

As in the previous section and as in two dimensions treated in [10] we will construct a supermartingale to upperbound $\mathbb{P}_x(\sigma_{d-1,d} < \tau_n < \tau_0)$. The event $\{\sigma_{d-1,d} < \tau_n < \tau_0\}$ consists of at most $d + 1$ stages: the process X starts on or away from ∂_1 , then hits ∂_2 , then hits ∂_3 , etc. and finally hits ∂A_n after hitting ∂_d without ever hitting 0. Roughly, the supermartingale will be constructed by applying one of the functions $h_{2,k,r}$ to the process X at each of these stages. The next lemma is used to adjust the definition so that the defined process remains a supermartingale as X jumps from one stage to the next.

For $k \in \{2, 3, \dots, d\}$ define

$$\gamma_{k-1,k} \doteq \frac{\gamma_{k-1}}{\gamma_{k-1} + \gamma_k}.$$

Lemma 5. For $k \in \{2, 3, \dots, d\}$ and $r \in (\rho, 1)$

$$\min_{y \in \partial_k} \frac{h_{2,k-1,r}(y)}{h_{2,k,r}(y)} \geq \gamma_{k-1,j} \quad (30)$$

for $y \in \partial_k$.

Proof. By their definition

$$h_{k-1,r}(y) = h_{k,r}(y) = r^{y(1) - \sum_{j=2}^{k-1} y(j)}.$$

for $y \in \partial_k$. This and the definition of $h_{2,k-1,r}, h_{2,k,r}$ imply

$$\frac{h_{2,k-1,r}(y)}{h_{2,k,r}(y)} = \frac{r^{y(1) - \sum_{j=1}^{k-1} y(j)} \left(\gamma_{k-1} + \sum_{j=1}^{k-2} \gamma_j r^{\sum_{l=2}^j y(l)} \right)}{r^{y(1) - \sum_{j=1}^{k-1} y(j)} \left(\gamma_k + \gamma_{k-1} + \sum_{j=1}^{k-2} \gamma_j r^{\sum_{l=2}^j y(l)} \right)}$$

for $y \in \partial_k$; this and $\gamma_j, r > 0$ imply (30). \square

Define

$$\Gamma_j \doteq \prod_{l=2}^j \gamma_{l-1,l},$$

and

$$S'_k \doteq \Gamma_j h_{2,j,r}(T_n(X_k)) \text{ for } \sigma_{j-1,j} < k \leq \sigma_{j,j+1}, j = 0, 1, 2, 3, \dots, d,$$

where, by convention, $\Gamma_0 = \Gamma_1 = 1$, $h_{2,0,r} = r^n$, $\sigma_{-1,0} = -1$ and $\sigma_{d,d+1} = \infty$; in particular, $S'_k = r^n$ for $k \leq \sigma_{0,1}$ and $S'_k = \Gamma_d h_{2,d,r}(T_n(X_k))$ for $k > \sigma_{d-1,d}$. The supermartingale that we will use to upperbound the probability $\mathbb{P}_x(\sigma_{d-1,d} < \tau_n < \tau_0)$ is

$$S_k \doteq S'_k - k \left(\lambda \left(\frac{1}{r} - 1 \right) \sum_{j=1}^d \gamma_j \right) r^n. \quad (31)$$

Proposition 2.6. *The process $\{S_k, k = 0, 1, 2, 3, \dots\}$ is a supermartingale.*

Proof. The proof is a case by case analysis. We begin by $X_k \notin \partial_1$, i.e., $X_k(1) > 0$. There are two subcases to consider: $k = \sigma_{j-1,j}$ for some $j \geq 1$ and $k \neq \sigma_{j-1,j}$ for all $j \geq 1$. For $k \neq \sigma_{j-1,j}$, $S'_k = \Gamma_j h_{2,j,r}(T_n(X_k))$, $S'_{k+1} = \Gamma_j h_{2,j,r}(T_n(X_{k+1}))$ for some $j \in \{0, 1, 2, 3, \dots, d\}$; the functions $h_{2,j,r}$ are Y -superharmonic by Proposition 2.2 and therefore $h_{2,j,r}(T_n(\cdot))$ are X -superharmonic on ∂_1^c . It follows from these that

$$\mathbb{E}_x[S'_{k+1} | \mathcal{F}_k] \leq S'_k \quad (32)$$

over the event $\{X_k \notin \partial_1\} \cap \{k \neq \sigma_{j-1,j}, j = 1, 2, 3, \dots, d\}$. If $k = \sigma_{j-1,j}$ for some $j \in \{2, 3, 4, \dots, d\}$ we have $S'_k = \Gamma_{j-1} h_{2,j-1,r}(T_n(X_k))$ and $S'_{k+1} = \Gamma_j h_{2,j,r}(T_n(X_{k+1}))$; $h_{2,j,r}$ is Y -superharmonic and therefore $h_{2,j,r}(T_n(\cdot))$ is X -superharmonic on ∂_1^c . These imply

$$\Gamma_j h_{2,j,r}(T_n(X_k)) \geq \mathbb{E}[\Gamma_j h_{2,j,r}(T_n(X_{k+1})) | \mathcal{F}_k] = \mathbb{E}[S'_{k+1} | \mathcal{F}_k] \quad (33)$$

over the event $\{k = \sigma_{j-1,j}\} \cap \{X_k \notin \partial_1\}$. That $X_k \in \partial_j$ for $k = \sigma_{j-1,j}$ and Lemma 5 imply

$$S'_k = \Gamma_{j-1} h_{2,j-1,r}(T_n(X_k)) \geq \Gamma_j h_{2,j,r}(T_n(X_k)).$$

This and (33) imply

$$S'_k \geq \mathbb{E}[S'_{k+1} | \mathcal{F}_k]$$

over the event $\{k = \sigma_{j-1,j}\} \cap \{X_k \notin \partial_1\}$. This and (32) imply $S'_k \geq \mathbb{E}[S'_{k+1} | \mathcal{F}_k]$; subtracting $k \left(\frac{\lambda}{r} + \sum_{j=1}^d \mu_j \right) r^n$ from the left and $(k+1) \left(\frac{\lambda}{r} + \sum_{j=1}^d \mu_j \right) r^n$ from the right gives

$$S_k \geq \mathbb{E}[S_{k+1} | \mathcal{F}_k]$$

over the event $\{X_k \notin \partial_1\}$.

For $x \in \mathbb{Z}_+^d$, define

$$L^*(x) \doteq \{l \in \{2, 3, 4, \dots, d\}, x(l) \neq 0\};$$

and

$$d^*(x) \doteq |L^*(x)|;$$

$l_1(x) < l_2(x) < \dots < l_{d^*}(x)$ are the members of L^* ; two conventions 1) $l_{d^*+1}(x) = d+1$ and 2) $l_1 = d+1$ if $d^* = 0$, i.e., if $L^*(x) = \emptyset$. For $X_k \in \partial_1$, there are two cases to consider: 1) $k = \sigma_{j-1, j}$ for some j and 2) $k \neq \sigma_{j-1, j}$ for all j . For the latter case

$$S'_k = \Gamma_j h_{2, j, r}(T_n(X_k)), S'_{k+1} = \Gamma_j h_{2, j, r}(T_n(X_{k+1})), \quad (34)$$

for some j . For ease of notation, let us abbreviate $l_m(X_k)$ to l_m , and $d^*(X_k)$ to d^* . Decompose $h_{2, j, r}(T_n(x))$ as

$$h_{2, j, r}(T_n(x)) = \sum_{l=1}^{(l_1-1) \wedge j} \gamma_l h_{l, r}(T_n(x)) + \sum_{m=1}^{d^*} \sum_{l=l_m}^{(l_{m+1}-1) \wedge j} \gamma_l h_{l, r}(T_n(x)), \quad (35)$$

where we use the conventions set above. Let us begin by considering any of the inner sums in the second sum in the last display. By the definition of l_m and l_{m+1} , $X_k(l_m) > 0$ and $X_k(l) = 0$ for $l_m < l < l_{m+1}$. This implies $h_{l, r}(T_n(X_k)) = h_{l_m, r}(T_n(X_k))$ for $l_m < l < l_{m+1}$. These, $l_m > 1$, Proposition 2.1, the definition (25) of γ_l and the dynamics of X imply

$$\begin{aligned} & \mathbb{E} \left[\sum_{l=l_m}^{(l_{m+1}-1) \wedge j} \gamma_l h_{l, r}(T_n(X_{k+1})) \middle| \mathcal{F}_k \right] - \sum_{l=l_m}^{(l_{m+1}-1) \wedge j} \gamma_l h_{l, r}(T_n(X_k)) \\ &= h_{l_m, r}(T_n(X_k)) \left(\lambda \left(\frac{1}{r} - 1 \right) \sum_{l=l_{m+1}}^{(l_{m+1}-1) \wedge j} \gamma_l + \gamma_{l_m} \left(\lambda \left(\frac{1}{r} - 1 \right) + \mu_{l_m}(r-1) \right) \right) \leq 0. \end{aligned}$$

Summing the last inequality over m gives

$$\mathbb{E} \left[\sum_{m=1}^{d^*} \sum_{l=l_m}^{(l_{m+1}-1) \wedge j} \gamma_l h_{l, r}(T_n(X_{k+1})) \middle| \mathcal{F}_k \right] - \sum_{m=1}^{d^*} \sum_{l=l_m}^{(l_{m+1}-1) \wedge j} \gamma_l h_{l, r}(T_n(X_k)) \leq 0. \quad (36)$$

Similarly, the definition of l_1 implies, $X_k(l) = 0$ for $l < l_1$, this and $h_{l, r}(T_n(x)) = r^{n - \sum_{m=1}^l x(m)}$ imply $h_{l, r}(T_n(X_k)) = r^n$ for $l < l_1$ over the event $\{X_k \in \partial_1\}$. These and the dynamics of X imply

$$\begin{aligned} & \mathbb{E} \left[\sum_{l=1}^{(l_1-1) \wedge j} \gamma_l h_{l, r}(T_n(X_{k+1})) \middle| \mathcal{F}_k \right] - \sum_{l=1}^{(l_1-1) \wedge j} \gamma_l h_{l, r}(T_n(X_k)) \\ &= h_{1, r}(T_n(X_k)) \left(\lambda \left(\frac{1}{r} - 1 \right) \sum_{l=1}^{(l_1-1) \wedge j} \gamma_l \right) = r^n \left(\lambda \left(\frac{1}{r} - 1 \right) \sum_{l=1}^{(l_1-1) \wedge j} \gamma_l \right) \geq 0 \end{aligned}$$

over the event $\{X_k \in \partial_1\}$. Putting together the last display, (36), (35) and $0 < \Gamma_j \leq 1$ give

$$\mathbb{E}[\Gamma_j h_{2, j, r}(T_n(X_{k+1})) \middle| \mathcal{F}_k] \leq \Gamma_j h_{2, j, r}(T_n(X_k)) + \left(\lambda \left(\frac{1}{r} - 1 \right) \sum_{l=1}^d \gamma_l \right) \quad (37)$$

over the event $\cap_{j=1}^d \{X_k \in \partial_1, k \neq \sigma_{j-1,j}\}$; this and (34) imply

$$\mathbb{E}[S'_{k+1} | \mathcal{F}_k] \leq S'_k + r^n \left(\lambda \left(\frac{1}{r} - 1 \right) \sum_{l=1}^d \gamma_l \right).$$

Moving the last expression to the left of the inequality sign and subtracting $k \left(\lambda \left(\frac{1}{r} - 1 \right) \sum_{l=1}^d \gamma_l \right)$ from both sides give $\mathbb{E}[S_{k+1} | \mathcal{F}_k] \leq S_k$ over the same event. It remains to show

$$\mathbb{E}[S_{k+1} | \mathcal{F}_k] \leq S_k \tag{38}$$

over the event $\cup_{j=1}^d \{X_k \in \partial_1, k = \sigma_{j-1,j}\}$. In this case

$$S'_k = \Gamma_{j-1} h_{2,j-1,r}(T_n(X_k)), S'_{k+1} = \Gamma_j h_{2,j,r}(T_n(X_{k+1})),$$

for some $j \in \{1, 2, 3, \dots, d\}$ and $X_k \in \partial_j$. By Lemma 5

$$S'_k = \Gamma_{j-1} h_{2,j-1,r}(T_n(X_k)) \geq \Gamma_j h_{2,j,r}(T_n(X_k));$$

this and (37) imply (38). \square

The upperbound on $\mathbb{P}_x(\sigma_{d-1,d} < \tau_n < \tau_0)$ now follows from the supermartingale constructed above:

Proof of Proposition 2.5. To use the supermartingale S to bound $\mathbb{P}_x(\sigma_{d-1,d} < \tau_n < \tau_0) < \rho^{n(1-\epsilon)}$ we need to truncate time by an application of the following fact (see [8, Theorem A.1.1]): there exists $c_1 > 0$ and $n_0 > 0$ such that $\mathbb{P}_x(\tau_n \wedge \tau_0 > c_1 n) \leq \rho^{2n}$ for $n > n_0$. Although they give the same results, the truncation argument varies in [10, 11, 6]; below we closely follow the one given in [6]. We decompose $\mathbb{P}_x(\sigma_{d-1,d} < \tau_n < \tau_0)$:

$$\mathbb{P}_x(\sigma_{d-1,d} < \tau_n < \tau_0) \leq \mathbb{P}_x(\sigma_{d-1,d} < \tau_n < \tau_0 \leq c_6 n) + \rho^{2n}. \tag{39}$$

To bound the last probability we apply the optional sampling theorem to the supermartingale S of (31) at the bounded terminal time $\eta = c_6 n \wedge \tau_0 \wedge \tau_n$:

$$\begin{aligned} r^n = S_0 &\geq \mathbb{E}_x[S_\eta] \\ &= \mathbb{E}_x \left[S'_\eta - \eta \left(\lambda \left(\frac{1}{r} - 1 \right) \sum_{j=1}^d \gamma_j \right) r^n \right] \\ &\geq \mathbb{E}_x [S'_\eta] - c_6 n \left(\lambda \left(\frac{1}{r} - 1 \right) \sum_{j=1}^d \gamma_j \right) r^n \end{aligned} \tag{40}$$

$S' > 0$ implies

$$\mathbb{E}_x[S'_\eta] \geq \mathbb{E}[S'_\eta \mathbf{1}_{\{\sigma_{d-1,d} < \tau_n < \tau_0 \leq c_6 n\}}]. \tag{41}$$

Over the event $\{\sigma_{d-1,d} < \tau_n < \tau_0 \leq c_6 n\}$ we have:

$$\begin{aligned} \eta &= \tau_n, \\ S'_\eta &= \Gamma_d h_{2,d,r}(T_n(X_{\tau_n})) = \Gamma_d \sum_{j=1}^d \gamma_j h_{j,r}(T_n(X_{\tau_n})) \geq \Gamma_d \gamma_d h_{d,r}(T_n(X_{\tau_n})) = \Gamma_d \gamma_d. \end{aligned}$$

This, (40) and (41) imply

$$\frac{1}{\gamma_d \Gamma_d} r^n \left(1 + c_6 n \left(\lambda \left(\frac{1}{r} - 1 \right) \sum_{j=1}^d \gamma_j \right) \right) \geq \mathbb{P}_x(\sigma_{d-1,d} < \tau_n < \tau_0 \leq c_6 n).$$

This inequality holds for any $r \in (\rho, 1)$; it follows that it also holds for ρ , i.e.,

$$\frac{1}{\gamma_d \Gamma_d} \rho^n \left(1 + c_6 n \left(\lambda \left(\frac{1}{r} - 1 \right) \sum_{j=1}^d \gamma_j \right) \right) \geq \mathbb{P}_x(\sigma_{d-1,d} < \tau_n < \tau_0 \leq c_6 n).$$

The statement of the proposition follows from this and (39). \square

2.3 Completion of the analysis

As the last step, we derive a lower bound on $\mathbb{P}_x(\tau_n < \tau_0)$. Following [11, 6] we will do this via subharmonic functions. Define

$$x \in \mathbb{Z}_+^d \mapsto g_{i,n}(x) = h_{i,\rho_i}(T_n(x)) = \rho_i^{n - \sum_{j=1}^i x^{(j)}}, k = 1, 2, 3, \dots, d,$$

and

$$g_n(x) \doteq \max_{i \in \{1, 2, 3, \dots, d\}} g_{i,n}(x). \quad (42)$$

Proposition 2.7.

$$g_n(x) - \rho^n \leq \mathbb{P}_x(\tau_n < \tau_0). \quad (43)$$

Proof. That $g_{i,n}(x) = h_{i,\rho_i}(T_n(x))$ and the calculation in the proof of Proposition 2.1 give

$$\mathbb{E}_x[g_{i,n}(X_1)] - g_{i,n}(x) = g_{i,n}(x) \left(\lambda \left(\frac{1}{\rho_i} - 1 \right) + \mu_k(\rho_i - 1) \mathbf{1}_{\partial_k^c}(x) \right).$$

The right side of this equality is 0 for $x \in \partial_k^c$ and positive for $x \in \partial_k$. It follows that $g_{i,n}$ is X -subharmonic on \mathbb{Z}_+^d . Therefore, $k \mapsto g_{i,n}(X_k)$ is a submartingale. The stability of X implies that $\tau_0 < \infty$ almost surely. This, that $k \mapsto g_{i,n}(X_k)$ is a submartingale and the optional sampling theorem give

$$g_{i,n}(x) \leq \mathbb{E}[h_{i,n}(X_{\tau_n}) \mathbf{1}_{\{\tau_n < \tau_0\}}] + \mathbb{E}[g_{i,n}(0) \mathbf{1}_{\{\tau_n > \tau_0\}}]$$

$g_{i,n} \leq 1$ on ∂A_n and $g_{i,n}(0) = \rho_i^n$ imply

$$\leq \mathbb{P}_x(\tau_n < \tau_0) + \rho_i^n.$$

Applying $\max_{i \in \{1, 2, 3, \dots, d\}}$ to both sides gives (43). \square

Define the order relation \leq on the nodes $\{1, 2, 3, \dots, d\}$ as follows: $i \leq j$ if $\rho_i \leq \rho_j$ and $i \leq j$. It follows from its definition that \leq is a partial order relation (it is reflexive, antisymmetric, transitive). Define

$$\mathcal{M} \doteq \{i \in \{1, 2, 3, \dots, d\} : \nexists j \in \{1, 2, 3, \dots, d\} \text{ such that } \rho_j \geq \rho_i \text{ and } j > i\}.$$

The set \mathcal{M} consists exactly of the maximal elements of the relation \leq . d is the maximum of $\{1, 2, 3, \dots, d\}$, therefore there can be no $j \in \{1, 2, 3, \dots, d\}$ satisfying $j > d$, this implies that

$d \in \mathcal{M}$ always holds, in particular, \mathcal{M} is never empty. A similar argument implies $\rho_i \neq \rho_j$ for $i, j \in \mathcal{M}$. Let us label members of \mathcal{M} by $i_1, i_2, \dots, i_{|\mathcal{M}|}$ so that

$$\rho_{i_1} > \rho_{i_2} > \rho_{i_3} > \dots > \rho_{i_{|\mathcal{M}|}}; \quad (44)$$

$i_1 < i_3 < \dots < i_{|\mathcal{M}|}$ and $i_{|\mathcal{M}|} = d$ once again follow from the definitions just given.

The point $x \in A_n$ must satisfy $g_n(x) < \rho^n$ for the bound (43) to be nontrivial. The next proposition identifies the set of such x .

$$\begin{aligned} R_\rho &\doteq \bigcap_{i \in \mathcal{M}} \left\{ x \in \mathbb{R}_+^d : \sum_{j=1}^i x(j) \leq \left(1 - \frac{\log \rho}{\log \rho_i}\right) \right\} \\ R_{\rho,n} &\doteq \{x \in \mathbb{Z}_+^d : x/n \in R_\rho\} \\ \bar{R}_{\rho,n} &\doteq \bigcup_{i \in \mathcal{M}} \left\{ x \in \mathbb{Z}_+^d : \sum_{j=1}^i x(j) \geq 1 + n \left(1 - \frac{\log \rho}{\log \rho_i}\right) \right\}. \end{aligned} \quad (45)$$

Two comments: 1) $x \in \bar{R}_{\rho,n}$ if $\sum_{j=1}^{\min \mathcal{M}} x(j) \geq 1$; in particular $\bar{R}_{\rho,n} = \{x \in \mathbb{Z}_+^d : \sum_{j=1}^d x(j) \geq 1\}$ if $\mathcal{M} = \{d\}$ (i.e., if $\rho_d \geq \rho_i$ for all i); 2) $\bar{R}_{\rho,n}$ is almost the complement of $R_{\rho,n}$.

Proposition 2.8. *The following hold:*

$$g_n(x) = \max_{i \in \mathcal{M}} \rho_i^{n - \sum_{j=1}^i x_j}, \quad \min_{x \in A_n} g_n(x) = \rho^n, \quad (46)$$

$$\{g_n(x) = \rho^n\} = R_{\rho,n}. \quad (47)$$

and

$$\frac{g_n(x)}{g_n(x) - \rho^n} \leq \frac{1}{1 - \rho}, \quad (48)$$

for $x \in \bar{R}_{\rho,n}$.

Proof. For $i \neq j$, the definitions of \leq , $g_{i,n}$ and $g_{j,n}$ imply

$$g_{i,n}(x) \leq g_{j,n}(x),$$

if $i \leq j$. Therefore, one can replace the index set $\{1, 2, 3, \dots, d\}$ in (42) with \mathcal{M} ; this implies the first statement in (46).

Reversing the order of min and max gives

$$\min_{x \in A_n} g_n(x) = \min_{x \in A_n} \max_{i \in \{1, 2, 3, \dots, d\}} g_{i,n}(x) \geq \max_{i \in \{1, 2, 3, \dots, d\}} \min_{x \in A_n} g_{i,n}(x).$$

By the definition of $g_{i,n}$ we have

$$\min_{x \in A_n} g_{i,n}(x) = \rho_i^n.$$

The last two displays imply

$$\min_{x \in A_n} g_n(x) \geq \rho^n.$$

On the other hand, $g_n(0) = \max_{i \in \{1, 2, 3, \dots, d\}} \rho_i^n = \rho^n$; this and the last display imply the second statement in (46).

Once again, the definition of $g_{i,n}$ implies

$$\{x : g_{i,n}(x) \leq \rho^n\} = \left\{ x \in \mathbb{Z}_+^d : \sum_{j=1}^i x(j) \leq n \left(1 - \frac{\log \rho}{\log \rho_i} \right) \right\}.$$

This and $g_n(x) = \max_{i \in \mathcal{M}} \rho_i^{n - \sum_{j=1}^i x(j)}$ implies (47).

Finally, if $x \in \mathbb{Z}_+^d$ satisfies $\sum_{j=1}^i x(j) \geq 1 + n \left(1 - \frac{\log \rho}{\log \rho_i} \right)$ we have $g_{i,n}(x) \geq \rho^n / \rho_i$. Then

$$\frac{g_n(x)}{g_n(x) - \rho^n} \leq \frac{g_{i,n}(x)}{g_{i,n}(x) - \rho^n} \leq \frac{\rho^n / \rho_i}{\rho^n / \rho_i - \rho^n} \leq \frac{1}{1 - \rho_i} \leq \frac{1}{1 - \rho},$$

which implies (48). \square

Recall the convention (44); i.e., $\rho_{i_1} = \rho$ and $i_1 = \min \mathcal{M}_{\leq}$. Therefore, $R_\rho \subset \{x \in \mathbb{R}_+^d : \sum_{j=1}^{i_1} x(j) = 0\}$; in particular R_ρ has strictly lower dimension than d . If $|\mathcal{M}| = 1$, i.e., if $\rho_d > \rho_i$ for all $i < d$ we have $R_\rho = \{0\}$.

Define

$$g : \mathbb{R}_+^d \mapsto \mathbb{R}, g(x) = \max_{i \in \{1, 2, \dots, d\}} \left(1 - \sum_{j=1}^i x(j) \right) \log_\rho \rho_i$$

The following lemma follows from the definition of g and the arguments of the previous proposition:

Lemma 6. $g_n(x) = \rho^{ng(x/n)}$, $\max_{x \in A} g(x) = 1$, $\{x : g(x) = 1\} = R_\rho$.

The upperbound on the approximation error follows from the bounds above:

Theorem 2.1. For $\epsilon > 0$ there exists $n_0 > 0$ such that

$$\frac{|\mathbb{P}_x(\tau_n < \tau_0) - \mathbb{P}_{T_n(x)}(\tau < \infty)|}{\mathbb{P}_x(\tau_n < \tau_0)} \leq \rho^{n(1-g(x/n)-\epsilon)} \quad (49)$$

for all $n > n_0$ and for any $x \in \bar{R}_{\rho,n}$. In particular, for $x_n/n \rightarrow x \in A - R_\rho$ the relative error decays exponentially with rate $-\log(\rho)(1 - g(x)) > 0$, i.e.,

$$\liminf_n -\frac{1}{n} \log \left(\frac{|\mathbb{P}_{x_n}(\tau_n < \tau_0) - \mathbb{P}_{T_n(x_n)}(\tau < \infty)|}{\mathbb{P}_{x_n}(\tau_n < \tau_0)} \right) \geq -\log(\rho)(1 - g(x)). \quad (50)$$

Proof. By Lemma 3

$$|\mathbb{P}_{x_n}(\tau_n < \tau_0) - \mathbb{P}_{T_n(x_n)}(\tau < \infty)| \leq \mathbb{P}_x(\bar{\tau}_0 < \bar{\tau}_n < \infty) + \mathbb{P}_x(\sigma_{d-1,d} < \tau_n < \tau_0) \quad (51)$$

By Proposition 2.5 we can choose n_0 large enough so that

$$\mathbb{P}_x(\sigma_{d-1,d} < \tau_n < \tau_0) < \rho^{n(1-\epsilon/2)}$$

for $n > n_0$. This, (51) and Proposition 2.4 give

$$|\mathbb{P}_{x_n}(\tau_n < \tau_0) - \mathbb{P}_{T_n(x_n)}(\tau < \infty)| \leq \rho^{n(1-\epsilon/2)} + \rho^n \frac{1}{\gamma_d} \sum_{j=1}^d \gamma_j.$$

for $n > n_0$. This and the lowerbound on $\mathbb{P}_x(\tau_n < \tau)$ given in Proposition 2.7 imply

$$\frac{|\mathbb{P}_x(\tau_n < \tau_0) - \mathbb{P}_{T_n(x)}(\tau < \infty)|}{\mathbb{P}_x(\tau_n < \tau_0)} \leq \frac{1}{g_n(x) - \rho^n} \left(\rho^{n(1-\epsilon/2)} + \rho^n \frac{1}{\gamma_d} \sum_{j=1}^d \gamma_j \right)$$

and by Proposition 2.8 and Lemma 6

$$\leq \frac{1}{1-\rho} \rho^{ng(x/n)} \left(\rho^{n(1-\epsilon/2)} + \rho^n \frac{1}{\gamma_d} \sum_{j=1}^d \gamma_j \right)$$

Finally, increase n_0 if necessary so that $\frac{1}{1-\rho} \left(1 + \frac{1}{\gamma_d} \sum_{j=1}^d \gamma_j \right) < \rho^{-n\epsilon/2}$ for $n > n_0$; then the last display and this choice of n_0 imply (49); (50) follows from (49), the continuity of g and from the fact that $\epsilon > 0$ can be chosen arbitrarily small. \square

3 Y -harmonic functions from harmonic systems

This section provides a framework for the construction of Y -harmonic functions. This can be done without additional effort for constrained random walks arising from any Jackson network and we will do so. The main element of the framework is the reduction of the construction of Y -harmonic functions to the solution of certain equations represented by graphs with labeled edges. In the next section we will provide a solution to these equations for the case when the constrained random walk represents a tandem network.

In this section we allow \mathcal{V} to be the set of possible increments of any constrained random walk arising from a Jackson network, i.e.:

$$\mathcal{V} = \{-e_i + e_j, i, j \in \{0, 1, 2, \dots, d\}, i \neq j\},$$

where $e_0 = 0 \in \mathbb{Z}^d$; the unconstrained increments of X takes values in \mathcal{V} with probabilities $\mathbb{P}(I_k = -e_i + e_j) = p(i, j)$ where $p \in \mathbb{R}_+^{(d+1) \times (d+1)}$, $p(i, i) = 0$, $i \in \{0, 1, 2, 3, \dots, d\}$ and $\sum_{i,j=0}^d p(i, j) = 1$. With this update to the set of possible increments the definition of X remains unchanged. The increment $-e_i + e_j$ represents a customer leaving node i and joining node j where node 0 represents outside of the system. For a general Jackson network the total service rates are defined as

$$\mu_i = \sum_{j=0}^d p(i, j), i \in \{1, 2, 3, \dots, d\}.$$

The Y process is defined as in (2) on ∂_1 with possible increments

$$\begin{aligned} \mathcal{V}_Y &= \{\mathcal{I}_1 v, v \in \mathcal{V}\} \\ &= \{v_{1,j} \doteq e_1 + e_j, v_{i,1} \doteq -e_i - e_1, v_{i,j} \doteq -e_i + e_j, i, j \in \{0, 1, 2, 3, \dots, d\}, i \neq j\} \\ Y_{k+1} &= Y_k + \pi_1(Y_k, J_k). \end{aligned} \tag{52}$$

For $\alpha \in \mathbb{C}^{d-1}$ we will index the components of the vector α with the set $\{2, 3, 4, \dots, d\}$, i.e., $\alpha = (\alpha(2), \alpha(3), \dots, \alpha(d))$ (so, more precisely, $\alpha \in \mathbb{C}^{\{2,3,4,\dots,d\}}$). The class of Y -harmonic

functions we seek are to be linear combinations of functions of the form

$$y \in \mathbb{Z}^d \mapsto [(\beta, \alpha), y],$$

$$[(\beta, \alpha), y] \doteq \beta^{y(1) - \sum_{j=2}^d y(j)} \prod_{j=2}^d \alpha(j)^{y(j)}.$$

$[(\beta, \alpha), y]$ is log-linear in y , i.e., $y \mapsto \log([(\beta, \alpha), y])$ is linear in y .

For $a \subset \{2, 3, \dots, d\}$ and $a^c = \{0, 1, 2, 3, \dots, d\} - a$, define the characteristic polynomial

$$\mathbf{p}_a(\beta, \alpha) \doteq \left(\sum_{i \in a^c, j=0}^d p(i, j)[(\beta, \alpha), v_{i,j}] + \sum_{i \in a} \mu_i \right) \quad (53)$$

the characteristic equation

$$\mathbf{p}_a(\beta, \alpha) = 1, \quad (54)$$

and the characteristic surface

$$\mathcal{H}_a \doteq \{(\beta, \alpha) \in \mathbb{C}^d : \mathbf{p}_a(\beta, \alpha) = 0\}$$

of the boundary ∂_a , $a \subset \{2, 3, 4, \dots, d\}$. We will write \mathbf{p} instead of \mathbf{p}_\emptyset . \mathbf{p}_a is not a polynomial but a rational function; to make it a polynomial one must multiply it by $\beta \prod_{j=2}^d \alpha(j)$; nonetheless, to keep our language simple we will refer to the rational (53) as the ‘‘characteristic polynomial.’’

Conditioning Y on its first step gives

Lemma 7. *Suppose $(\beta, \alpha) \in \mathcal{H}$. Then $[(\beta, \alpha), \cdot]$ is Y -harmonic on $\Omega_Y - \bigcup_{j=2}^d \partial_j$.*

Proof. For $y \in \Omega_Y - \bigcup_{j=2}^d \partial_j$ we have

$$\mathbb{E}_y[[\beta, \alpha), Y_1]] - [(\beta, \alpha), y] = [(\beta, \alpha), y](\mathbf{p}(\beta, \alpha) - 1) = 0,$$

where the last equality follows from $(\beta, \alpha) \in \mathcal{H}$. □

Define the operator D_a acting on functions on \mathbb{Z}^d and giving functions on ∂_a :

$$D_a V = g, \quad V : \mathbb{Z}^d \rightarrow \mathbb{C},$$

$$g(y) \doteq \left(\sum_{i \in a} \mu_i V(y) + \sum_{i \in a^c, j=0}^d p(i, j) V(y + v_{i,j}) \right) - V(y);$$

Lemma 8. *$D_a V = 0$ if and only if V is Y -harmonic on ∂_a .*

The proof follows from the definitions. Define

$$C(i, \beta, \alpha) \doteq \mu_i - \sum_{j=0}^d p(i, j)[(\beta, \alpha), v_{i,j}]. \quad (55)$$

Lemma 9. *For $y \in \partial_a$ and $(\beta, \alpha) \in \mathcal{H}$:*

$$D_i([\beta, \alpha, \cdot])(y) = C(i, \beta, \alpha)[(\beta, \alpha), y]. \quad (56)$$

Proof.

$$\begin{aligned} D_i([\beta, \alpha, \cdot])(y) &= \left(\mu_i + \sum_{i' \neq i, j=0}^d p(i', j)[(\beta, \alpha), v_{i', j}] - 1 \right) [(\beta, \alpha), y] \\ &= \left(\mu_i - \sum_{j=0}^d p(i, j)[(\beta, \alpha), v_{i, j}] \right) [(\beta, \alpha), y], \end{aligned}$$

where we used $1 = \mathbf{p}(\beta, \alpha)$. \square

Lemma 10. *Suppose $(\beta, \alpha) \in \mathcal{H} \cap \mathcal{H}_i$. Then $[(\beta, \alpha), \cdot]$ is Y -harmonic on $\Omega_Y - \bigcup_{j \in \{2, 3, \dots, d\} - \{i\}} \partial_j$.*

Proof. $(\beta, \alpha) \in \mathcal{H}$ and Lemma 7 imply that $[(\beta, \alpha), \cdot]$ is Y -harmonic on $\Omega_Y - \bigcup_{j=2}^d \partial_j$. That $\mathbf{p}(\beta, \alpha) = 1$ and $\mathbf{p}_i(\beta, \alpha) = 1$ imply

$$C(i, \beta, \alpha) = \mathbf{p}_i(\beta, \alpha) - \mathbf{p}(\beta, \alpha) = 0.$$

This and the last two lemmas imply that $[(\beta, \alpha), \cdot]$ is Y -harmonic on ∂_i . \square

For $\alpha \in \mathbb{C}^{\{2, 3, \dots, d\}}$ and $j \in \{2, 3, 4, \dots, d\}$ define $\alpha\{j\} \in \mathbb{C}^{\{2, 3, \dots, d\}}$ as follows:

$$\alpha\{j\}(i) = \begin{cases} 1, & \text{if } i = j \\ \alpha(i), & \text{otherwise.} \end{cases}$$

For example, for $d = 4$, $j = 4$ and $\alpha = (0.2, 0.3, 0.4)$, $\alpha\{4\} = (0.2, 0.3, 1)$.

For $i \in \{2, 3, 4, \dots, d\}$, multiplying both sides of the characteristic equation $\mathbf{p}(\beta, \alpha) = 0$ by $\alpha(i)$ gives a second order polynomial equation in $\alpha(i)$: denote the roots by r_1 and r_2 . From the coefficients of the second order polynomial we read

$$r_1 r_2 = \frac{\sum_{j=0}^d p(i, j)[(\beta, \alpha\{i\}), v_{i, j}]}{\sum_{j=0}^d p(j, i)[(\beta, \alpha\{i\}), v_{j, i}]}.$$
 (57)

From these two roots we get two points $(\beta, \alpha_1), (\beta, \alpha_2)$ on \mathcal{H} whose components are

$$\alpha_1(i) = r_1, \alpha_2(i) = r_2,$$

and

$$\alpha_1(j) = \alpha_2(j) = \alpha(j), j \neq i.$$
 (58)

By (57)

$$\alpha_1(i) \alpha_2(i) = \frac{\sum_{j=0}^d p(i, j)[(\beta, \alpha\{i\}), v_{i, j}]}{\sum_{j=0}^d p(j, i)[(\beta, \alpha\{i\}), v_{j, i}]}.$$
 (59)

If $\alpha_1(i) \neq \alpha_2(i)$ we call $(\beta, \alpha_1) \neq (\beta, \alpha_2) \in \mathcal{H}$ i -conjugate. Note that $\alpha_1\{i\} = \alpha_2\{i\} = \alpha\{i\}$; therefore (59) can also be written as

$$\alpha_1(i) \alpha_2(i) = \frac{\sum_{j=0}^d p(i, j)[(\beta, \alpha_1\{i\}), v_{i, j}]}{\sum_{j=0}^d p(j, i)[(\beta, \alpha_1\{i\}), v_{j, i}]} = \frac{\sum_{j=0}^d p(i, j)[(\beta, \alpha_2\{i\}), v_{i, j}]}{\sum_{j=0}^d p(j, i)[(\beta, \alpha_2\{i\}), v_{j, i}]}.$$
 (60)

Next proposition generalizes [10, Proposition 4] to the current setup.

Proposition 3.1. *Suppose that (β, α_1) and (β, α_2) are i -conjugate and $C(i, \beta, \alpha_j)$, $j = 1, 2$ are well defined. Then*

$$h_\beta \doteq C(i, \beta, \alpha_2)[(\beta, \alpha_1), \cdot] - C(i, \beta, \alpha_1)[(\beta, \alpha_2), \cdot]$$

is Y -harmonic on ∂_i .

Proof. The definition (55) of C , (56) and linearity of D_i imply

$$D_i(h_\beta) = C(i, \beta, \alpha_2)C(i, \beta, \alpha_1)[(\beta, \alpha_1), \cdot] - C(i, \beta, \alpha_2)C(i, \beta, \alpha_1)[(\beta, \alpha_2), \cdot]$$

(58) implies $[(\beta, \alpha_1), z] = [(\beta, \alpha_2), z]$ for $z \in \partial_i$ and therefore the last line reduces to

$$= 0.$$

Lemma 8 now implies that h_β is Y -harmonic on ∂_i . □

The class of Y -harmonic functions we identify in this section is based on graphs with labeled edges; let us now give a precise definition of these. We denote any graph by its adjacency matrix G ; the structure of G is as follows. Let V_G , a finite set, denote the set of vertices of G ; let L denote the set of labels. For two vertices $i \neq j$, $G(i, j) = 0$ if they are disconnected, and $G(i, j) = l$ if an edge with label $l \in L$ connects them; such an edge will be called an l -edge. As usual, an edge from a vertex to itself is called a loop. For a vertex $j \in V_G$, $G(j, j)$ is the set of the labels of the loops on j . Thus $G(j, j) \subset L$ is set valued.

In graph theory a graph is said to be k -regular if all of its vertices have the same degree (number of edges) k [2, page 5]. We generalize this definition as follows:

Definition 3.1. *Let G and L be as above. If each vertex $j \in V_G$ has a unique l -edge (perhaps an l -loop) for all $l \in L$ we will call G L -regular.*

Definition 3.2. *A Y -harmonic system consists of a $\{2, 3, 4, \dots, d\}$ -regular graph G , the variables $(\beta, \alpha_j) \in \mathbb{C}^d$, $\mathbf{c}_j \in \mathbb{C}$, $j \in V_G$ and these equations/constraints:*

1. $(\beta, \alpha_j) \in \mathcal{H}$, $\mathbf{c}_j \in \mathbb{C} - \{0\}$, $j \in V_G$,
2. $\alpha_i \neq \alpha_j$, if $i \neq j$, $i, j \in V_G$,
3. α_i, α_j are $G(i, j)$ -conjugate if $G(i, j) \neq 0$, $i \neq j$, $i, j \in V_G$,

4.

$$\mathbf{c}_i/\mathbf{c}_j = -\frac{C(G(i, j), \beta, \alpha_j)}{C(G(i, j), \beta, \alpha_i)}, \text{ if } G(i, j) \neq 0, \quad (61)$$

5. $(\beta, \alpha_j) \in \mathcal{H}_l$ for all $l \in G(j, j)$, $j \in V_G$.

Proposition 3.2. *Suppose that a Y -harmonic system with graph G has a solution $(\mathbf{c}_j, (\beta, \alpha_j), j \in V_G)$. Then*

$$h_G \doteq \sum_{j \in V_G} \mathbf{c}_j [(\beta, \alpha_j), \cdot] \quad (62)$$

is Y -harmonic.

In the proof the following decomposition is useful: for $y \in \partial_a$ and $(\beta, \alpha) \in \mathcal{H}$:

$$\begin{aligned}
D_a([\!(\beta, \alpha, \cdot)\!])(y) &= \left(\sum_{i \in a} \mu_i + \sum_{i \in a^c, j} p(i, j)[\!(\beta, \alpha), v_{i,j}\!] - 1 \right) [\!(\beta, \alpha), y\!] \\
&= \left(\sum_{i \in a} \mu_i - \sum_{i \in a, j=0}^d p(i, j)[\!(\beta, \alpha), v_{i,j}\!] \right) [\!(\beta, \alpha), y\!] \\
&= \sum_{i \in a} \left(\mu_i - \sum_{j=0}^d p(i, j)[\!(\beta, \alpha), v_{i,j}\!] \right) [\!(\beta, \alpha), y\!] \\
&= \sum_{i \in a} D_i([\!(\beta, \alpha, \cdot)\!])(y). \tag{63}
\end{aligned}$$

Proof of Proposition 3.2. By Lemma 7, all summands of h_G are Y -harmonic on $\Omega_Y - \bigcup_{j=2}^d \partial_j$ because $(\beta, \alpha_j), j \in V_G$ are all on the characteristic surface \mathcal{H} . It remains to show that h_G is Y -harmonic on all $\partial_a \cap \Omega_Y$ $a \subset \{2, 3, 4, \dots, d\}$ and $a \neq \emptyset$. We will do this by induction on $|a|$. Let us start with $|a| = 1$, i.e., $a = \{l\}$, for some $l \in \{2, 3, 4, \dots, d\}$. Take any vertex $i \in V_G$; if $l \in G(i, i)$ then $(\beta, \alpha_i) \in \mathcal{H}_l$ and by Lemma 10 $[\!(\beta, \alpha_i), \cdot\!]$ is Y -harmonic on ∂_l . Otherwise, the definition of a harmonic system implies that there exists a unique vertex j of G such that $G(i, j) = l$. This implies, by definition, that (β, α_i) and (β, α_j) are l -conjugate and by Proposition 3.1 and (61)

$$\mathbf{c}_i[\!(\beta, \alpha_i), \cdot\!] + \mathbf{c}_j[\!(\beta, \alpha_j), \cdot\!]$$

is Y -harmonic on ∂_l . Thus, all summands of h_G are either Y -harmonic on ∂_l or form pairs which are so; this implies that the sum h_G is Y -harmonic on ∂_l .

Now assume h_G is Y -harmonic for all a' with $|a'| = k - 1$; fix an $a \subset \{2, 3, 4, \dots, d\}$ such that $|a| = k$ and a $i \in a$; by (63)

$$D_a(h_G) = D_{a-\{i\}}(h_G) + D_i(h_G).$$

The induction assumption and Lemma 8 imply that the first term on the right is zero; the same lemma and the previous paragraph imply the same for the second term. Then $D_a(h_G) = 0$; this and Lemma 8 finish the proof of the induction step. \square

3.1 Simple extensions

In this subsection we show how the solution of a harmonic system for a lower dimensional process can provide solutions for a related harmonic system of a higher dimensional process provided that the higher dimensional process is a ‘‘simple extension’’ (defined below) of the lower dimensional one.

For two integers $d_2 > d_1 > 0$ let $p_i \in \mathbb{R}^{(d_i+1) \times (d_i+1)}$, $i = 1, 2$, be two transition matrices. Define $p' \in \mathbb{R}^{(d_1+1) \times (d_1+1)}$ as

$$p'(i, j) = p_2(i, j) \tag{64}$$

if $i \in \{0, 1, 2, 3, \dots, d_1\}$, $j \in \{1, 2, 3, \dots, d_1\}$ and

$$p'(i, 0) = p_2(i, 0) + \sum_{j=d_1+1}^{d_2} p_2(i, j), \quad i \in \{1, 2, 3, \dots, d_1\}. \tag{65}$$

Definition 3.3. We say that p_2 is a simple extension of p_1 if

$$p' = \left(\sum_{i,j=0}^{d_1} p'(i,j) \right) p_1, p' \neq 0, \quad (66)$$

$$p_2(i,j) = 0 \text{ if } i \in \{d_1 + 1, \dots, d_2\}, j \in \{1, 2, 3, \dots, d_1\}. \quad (67)$$

An example:

$$p_1 = \begin{pmatrix} 0 & 1/7 & 0 \\ 0 & 0 & 4/7 \\ 2/7 & 0 & 0 \end{pmatrix}, p_2 = \begin{pmatrix} 0 & 0.05 & 0 & 0 & 0.02 \\ 0 & 0 & 0.2 & 0 & 0 \\ 0.1 & 0 & 0 & 0.1 & 0 \\ 0 & 0 & 0 & 0 & 0.25 \\ 0.1 & 0 & 0 & 0.18 & 0 \end{pmatrix}. \quad (68)$$

Figure 2 shows the topologies of the networks corresponding to p_1 and p_2 .

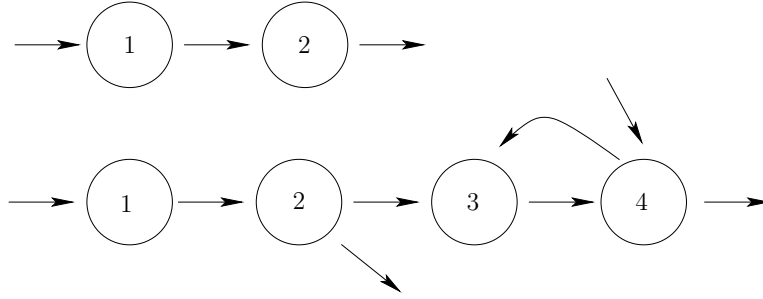

Figure 2: Networks corresponding to p_1 and p_2 of (68), second is a simple extension of the first

Definition 3.4. Let G be a L -regular. Let $L_1 \supset L$ be another set of labels. G 's simple extension G_1 to an L_1 -regular graph is defined as follows: $V_{G_1} = V_G$ and

$$\begin{aligned} G_1(i,j) &= G(i,j), i \neq j, i, j \in V_G \\ G_1(j,j) &= G(j,j) \cup (L_1 - L), j \in V_G. \end{aligned} \quad (69)$$

To get G_1 from G one adds to each vertex of G an l -loop for each $l \in L_1 - L$. G is L -regular implies that G_1 is L_1 -regular. Figure 3 gives an example.

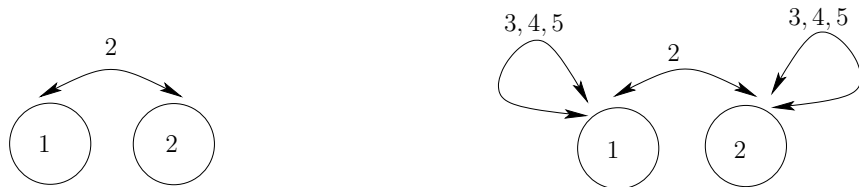

Figure 3: A $\{2\}$ -regular graph and its simple extension to a $\{2, 3, 4, 5\}$ -regular graph

If Y^2 is a simple extension of Y^1 , any solution to a Y^1 -harmonic system implies a related solution to a related Y^2 -harmonic system:

Proposition 3.3. For $d_2 > d_1 > 1$ let $p_i \in \mathbb{R}_+^{(d_i+1) \times (d_i+1)}$, $i = 1, 2$ be transition matrices such that p_2 is a simple extension of p_1 . Let Y^i be defined through (52) with $d = d_i$, $i = 1, 2$

and $p = p_i$, $i = 1, 2$. Let G_i , $i = 1, 2$ be $\{2, 3, \dots, d_i\}$ -regular graphs for Y^2 and Y^1 such that G_2 is a simple extension of G_1 (in the sense of Definition 3.4). Suppose $(\beta, \alpha_k), \mathbf{c}_k, k \in V_{G_1}$ solve the harmonic system associated with G_1 . For $k \in V_{G_2} = V_{G_1}$ define $\alpha_k^2 \in \mathbb{C}^{d_2+1}$ as follows

$$\alpha_k^2(j) = \alpha_k^1(j), \quad j \in \{2, 3, 4, \dots, d_1\} \quad (70)$$

$$\alpha_k^2(j) = \beta, \quad j \in \{d_1 + 1, d_1 + 2, \dots, d_2\}. \quad (71)$$

Then $(\beta, \alpha_k^2), \mathbf{c}_k, k \in V_{G_2}$ solves the harmonic system defined by G_2 and p_2 .

The definition (71) extends $\alpha_k^1 \in \mathbb{C}^{d_1-1}$ to $\alpha_k^2 \in \mathbb{C}^{d_2-1}$ by assigning the value β to the additional dimensions of α_k^2 . This, (66) and (67) imply that, when α_k^2 is defined as above, the harmonic system defined by G_2 reduces to that defined by G_1 ; the details are as follows:

Proof. By assumption, $(\beta, \alpha_k^1), \mathbf{c}_k, k \in V_{G_0}$ satisfy the five conditions listed under Definition 3.2 for $G = G_1$ and $p = p_1$. We want to show that this implies that the same holds for $(\beta, \alpha_k^2), \mathbf{c}_k, k \in V_{G_2}$ for $G = G_2$ and $p = p_2$.

Fix any $k \in V_{G_1}$; (70) and (71) imply

$$[(\beta, \alpha_k^2), v_{i,j}^2] = \begin{cases} [(\beta, \alpha_k^1), v_{i,j}^1], & \text{if } j \leq d_1, \\ [(\beta, \alpha_k^1), v_{i,0}^1], & \text{if } j > d_1, \end{cases} \quad (72)$$

for all $i \in \{0, 1, 2, \dots, d_1\}$, $j \in \{0, 1, 2, \dots, d_2\}$, $i \neq j$. Similarly, (71) implies

$$[(\beta, \alpha_k^2), v_{i,j}^2] = 1 \quad (73)$$

for all $i, j \in \{0, d_1 + 1, d_1 + 2, \dots, d_2\}$, $i \neq j$.

Let \mathbf{p}^2 denote the characteristic polynomial of Y^2 and let \mathcal{H}^2 denote its characteristic surface; we would like to show $(\beta, \alpha_k^2) \in \mathcal{H}^2$, i.e., $\mathbf{p}^2(\beta, \alpha_k^2) = 1$.

By (67)

$$\begin{aligned} \mathbf{p}^2(\beta, \alpha_k^2) &= \sum_{i=0, j=1}^{d_1} p_2(i, j)[(\beta, \alpha_k^2), v_{i,j}^2] + \sum_{i=1, j \in \{0, d_1+1, \dots, d_2\}}^{d_1} p_2(i, j)[(\beta, \alpha_k^2), v_{i,j}^2] \\ &+ \sum_{i, j \in \{0, d_1+1, \dots, d_2\}} p_2(i, j)[(\beta, \alpha_k^2), v_{i,j}^2]. \end{aligned} \quad (74)$$

(64), (72) and (73) imply

$$\begin{aligned} &= \sum_{i=0, j=1}^{d_1} p'(i, j)[(\beta, \alpha_k^1), v_{i,j}^1] + \sum_{i=1, j \in \{0, d_1+1, \dots, d_2\}}^{d_1} p_2(i, j)[(\beta, \alpha_k^1), v_{i,0}^1] \\ &+ \sum_{i, j \in \{0, d_1+1, \dots, d_2\}} p_2(i, j) \end{aligned} \quad (75)$$

(65) implies that the second sum above equals $\sum_{i=1}^{d_1} p'(i, 0)[(\beta, \alpha_k^1), v_{i,0}^1]$. Substitute this back in (75) to get

$$\mathbf{p}^2(\beta, \alpha_k^2) = \sum_{i, j=0}^{d_1} p'(i, j)[(\beta, \alpha_k^1), v_{i,j}^1] + \sum_{i, j \in \{0, d_1+1, \dots, d_2\}} p_2(i, j)$$

which, by (66), equals

$$= \left(\sum_{i,j=0}^{d_1} p'(i,j) \right) \sum_{i,j=0}^{d_1} p_1(i,j)[(\beta, \alpha_k^1), v_{i,j}^1] + \sum_{i,j \in \{0, d_1+1, \dots, d_2\}} p_2(i,j)$$

$(\beta, \alpha_k) \in \mathcal{H}$, (64), (65) and (67) now give

$$= \sum_{i,j=0}^{d_2} p_2(i,j) = 1$$

i.e., $(\beta, \alpha_k^2) \in \mathcal{H}^2$. This proves $(\beta, \alpha_k^2) \in \mathcal{H}^2$, $k \in V_{G_2}$, i.e., the first part of Definition 3.2 is satisfied by (β, α_k^2) , \mathbf{c}_k , $k \in V_{G_2}$ for $G = G_2$ and $p = p_2$.

By definition $\alpha_i^1 \neq \alpha_j^1$ for $i \neq j$, this and (70) imply $\alpha_i^2 \neq \alpha_j^2$, i.e., the second part of Definition 3.2 also holds for (β, α_k^2) , \mathbf{c}_k , $k \in V_{G_2}$ for $G = G_2$ and $p = p_2$.

Let us now show that the third part of the same definition is also satisfied. Fix any $i \neq j$ with $G_2(i,j) = l \in \{2, 3, 4, \dots, d_1\}$ (that G_2 is a simple extension of G_1 means that $G_2(i,j) \in \{2, 3, 4, \dots, d_1\}$; see (69)). We want to show that (β, α_i^2) and (β, α_j^2) are l -conjugate, i.e., that they satisfy (58) and (60):

$$\alpha_i^2(k) = \alpha_j^2(k), k \neq l, \quad (76)$$

$$\alpha_i^2(l)\alpha_j^2(l) = \frac{\sum_{k=0}^{d_2} p_2(l,k)[(\beta, \alpha_i^2\{l\}), v_{l,k}^2]}{\sum_{k=0}^{d_2} p_2(k,l)[(\beta, \alpha_i^2\{l\}), v_{k,l}^2]}. \quad (77)$$

By definition $G_2(i,j) = l$ when $G_1(i,j) = l$; $G_1(i,j) = l$ implies that α_i^1 and α_j^1 are l -conjugate; in particular, they satisfy (58). (76) follows from this, (70) and (71).

We next prove (77). For $l \in \{2, 3, 4, \dots, d_1\}$, $\alpha_j^2(l) = \alpha_j^1(l)$ and $\alpha_i^2(l) = \alpha_i^1(l)$; therefore $\alpha_i^2(l)\alpha_j^2(l) = \alpha_i^1(l)\alpha_j^1(l)$. α_i^1 and α_j^1 are l -conjugate, in particular, they satisfy (60):

$$\alpha_i^1(l)\alpha_j^1(l) = \frac{\sum_{k=0}^{d_1} p_1(l,k)[(\beta, \alpha_i^1\{l\}), v_{l,k}^1]}{\sum_{k=0}^{d_1} p_1(k,l)[(\beta, \alpha_i^1\{l\}), v_{k,l}^1]}.$$

Then to prove (77) it suffices to prove

$$\frac{\sum_{k=0}^{d_2} p_2(l,k)[(\beta, \alpha_i^2\{l\}), v_{l,k}^2]}{\sum_{k=0}^{d_2} p_2(k,l)[(\beta, \alpha_i^2\{l\}), v_{k,l}^2]} = \frac{\sum_{k=0}^{d_1} p_1(l,k)[(\beta, \alpha_i^1\{l\}), v_{l,k}^1]}{\sum_{k=0}^{d_1} p_1(k,l)[(\beta, \alpha_i^1\{l\}), v_{k,l}^1]}. \quad (78)$$

This follows from a decomposition parallel to the one given in (74); let us first apply it to the numerator:

$$\sum_{k=0}^{d_2} p_2(l,k)[(\beta, \alpha_i^2\{l\}), v_{l,k}^2] = \sum_{k=0}^{d_1} p_2(l,k)[(\beta, \alpha_i^2\{l\}), v_{l,k}^2] + \sum_{k=d_1+1}^{d_2} p_2(l,k)[(\beta, \alpha_i^2\{l\}), v_{l,k}^2]$$

(64), (65), (66) and (72) imply

$$\begin{aligned} &= \sum_{k=1}^{d_1} p'(l,k)[(\beta, \alpha_i^1\{l\}), v_{l,k}^1] + p_2(l,0)[(\beta, \alpha_i^1\{l\}), v_{l,0}^1] + \sum_{k=d_1+1}^{d_2} p_2(l,k)[(\beta, \alpha_i^1\{l\}), v_{l,0}^1] \\ &= \left(\sum_{i,j=0}^{d_1} p'(i,j) \right) \sum_{k=0}^{d_1} p_1(k,l)[(\beta, \alpha_i^1\{l\}), v_{k,l}^1]. \end{aligned} \quad (79)$$

A parallel argument for the denominator gives (this time also using (67))

$$\sum_{k=0}^{d_2} p_2(k, l)[(\beta, \alpha_i^2 \{l\}), v_{k,l}^2] = \left(\sum_{i,j=0}^{d_1} p'(i, j) \right) \sum_{k=0}^{d_1} p_1(k, l)[(\beta, \alpha_i^1 \{l\}), v_{k,l}^1].$$

Dividing (79) by the last equality gives (78).

The proof that parts 4-5 of Definition 3.2 hold for $(\beta, \alpha_k^2), \mathbf{c}_k, k \in V_{G_2}$ for $G = G_2$ and $p = p_2$ is parallel to the arguments just given and is omitted. \square

In the following remark we note several facts that we don't need directly in our arguments. Their proofs are very similar to the arguments given above and are left to the reader:

Remark 1. Let Y^1 and Y^2 be as above, i.e. Y^i is d_i dimensional, $d_1 < d_2$ and Y^2 is a simple extension of Y^1 ; for $y \in \mathbb{Z}^{d_2}$, let y^{1,d_1} be denote the projection of y onto its first d_1 coordinates. If h is Y^1 -harmonic then, $y \mapsto h(y^{1,d_1})$ is Y_2 -harmonic. Similarly, let G_1 and G_2 , $\mathbf{c}_k, \alpha_k^i, k \in V_{G_1}$ be as in the previous proposition; then $h_{G_2}(y) = h_{G_1}(y^{1,d_1})$.

3.2 ∂B -determined Y -harmonic functions

A Y -harmonic function f is said to be ∂B -determined if

$$f(y) = \mathbb{E}[f(Y_\tau)1_{\{\tau < \infty\}}], y \in \Omega_Y.$$

$y \mapsto \mathbb{P}_y(\tau < \infty)$ is the unique ∂B -determined Y -harmonic function with the value 1 on ∂B . The next proposition identifies simple conditions under which a Y -harmonic function defined by a harmonic system is ∂B -determined.

Proposition 3.4. *Let $(\beta, \alpha_j), \mathbf{c}_j$ be the solutions of a Y -harmonic system with its graph G and let h_G be defined as in (62). If*

$$|\beta| < 1, \quad |\alpha_j(i)| \leq 1, i = 2, 3, \dots, d, j \in V_G,$$

then h_G is ∂B -determined.

The proof is identical to that of [10, Proposition 5]; for ease of reference we give an outline below:

Proof. Define $\xi_n = \inf\{k : Y_k(1) = \sum_{j=2}^d Y_k(j) + n\}$. The optional sampling theorem and the fact that h_G is Y -harmonic imply

$$h_G(y) = \mathbb{E}[h_G(Y_\tau)1_{\{\tau \leq \xi_n\}}] + \mathbb{E}[h_G(Y_{\xi_n})1_{\{\xi_n \leq \tau\}}].$$

$|\alpha_i| \leq 1$ implies $|\mathbb{E}[h_G(Y_{\xi_n})1_{\{\xi_n \leq \tau\}}]| \leq \beta^n |V_G| \max_{j \in V_G} |\mathbf{c}_j|$. This, $|\beta| < 1$ and letting $n \rightarrow \infty$ in the last display give

$$h_G(y) = \mathbb{E}[h_G(Y_\tau)1_{\{\tau < \infty\}}].$$

\square

4 Harmonic systems for constrained random walks representing tandem networks and the computation of $\mathbb{P}_y(\tau < \infty)$

Throughout this section we will denote the dimension of the system with \mathbf{d} ; the arguments below for \mathbf{d} dimensions require the consideration of all walks with dimension $d \leq \mathbf{d}$.

We will now define a specific sequence of regular graphs for tandem walks and construct a particular solution to the harmonic system defined by these graphs. These particular solutions will give us an exact formula for $\mathbb{P}_y(\tau < \infty)$ in terms of the superposition of a finite number of log-linear Y -harmonic functions.

We will assume

$$\mu_i \neq \mu_j, i \neq j; \quad (80)$$

this generalizes $\mu_1 \neq \mu_2$ assumed in [10]. One can treat parameter values which violate (80) by taking limits of the results of the present section, we give several examples in Section 6.

The characteristic polynomials for the tandem walk are:

$$\begin{aligned} \mathbf{p}(\beta, \alpha) &= \lambda \frac{1}{\beta} + \mu_1 \alpha(2) + \sum_{j=2}^{\mathbf{d}} \mu_j \frac{\alpha(j+1)}{\alpha(j)} \\ \mathbf{p}_i(\beta, \alpha) &= \lambda \frac{1}{\beta} + \mu_1 \alpha(2) + \mu_i + \sum_{j=2, j \neq i}^{\mathbf{d}} \mu_j \frac{\alpha(j+1)}{\alpha(j)}, \end{aligned} \quad (81)$$

where by convention $\alpha(\mathbf{d}+1) = \beta$ (this convention will be used throughout this section, and in particular, in Lemma 11, (82), and (83)).

(81) implies

Lemma 11. For $j \in \{2, 3, 4, \dots, \mathbf{d}\}$, $(\beta, \alpha) \in \mathcal{H} \cap \mathcal{H}_j \iff \mu_j \frac{\alpha(j+1)}{\alpha(j)} = \mu_j \iff \alpha(j+1) = \alpha(j)$.

For the tandem walk, the conjugacy relation (59) reduces to

$$\alpha_1(i) \alpha_2(i) = \begin{cases} \frac{\alpha(3) \mu_2}{\mu_1}, & i = 2, \\ \frac{\alpha(i-1) \alpha(i+1) \mu_i}{\mu_{i-1}}, & i = 2, 3, \dots, \mathbf{d}. \end{cases} \quad (82)$$

For tandem walks the functions $C(j, \beta, \alpha)$ of (55) reduce to

$$C(j, \beta, \alpha) = \mu_j - \mu_j \frac{\alpha(j+1)}{\alpha(j)}, \quad (83)$$

We define $\{2, 3, \dots, \mathbf{d}\}$ -regular graphs $G_{d, \mathbf{d}}$, $d \in \{1, 2, 3, \dots, \mathbf{d}\}$ as follows:

$$V_{G_{d, \mathbf{d}}} = \{a \cup \{d\}, a \subset \{1, 2, 3, \dots, d-1\}\}; \quad (84)$$

for $j \in (a \cup \{d\})$, $j \neq 1$, define $G_{d, \mathbf{d}}$ by

$$G_{d, \mathbf{d}}(a \cup \{d\}, a \cup \{d\} \cup \{j-1\}) = j \text{ if } j-1 \notin a \quad (85)$$

and

$$G_{d, \mathbf{d}}(a \cup \{d\}, a \cup \{d\}) = \{2, 3, 4, \dots, d\} - a \cup \{d\}; \quad (86)$$

these and its symmetry determine $G_{d, \mathbf{d}}$ completely. We note that vertices of $G_{d, \mathbf{d}}$ are subsets of $\{1, 2, 3, \dots, \mathbf{d}\}$; we will assume these sets to be sorted, for $a \subset \{1, 2, 3, \dots, \mathbf{d}\}$, $a(1)$ denotes the smallest element of a , $|a|$ the number of elements in a and $a(|a|)$ the greatest element of a . Figure 4 shows the graph $G_{4,4}$.

The next two propositions follow directly from the above definition:

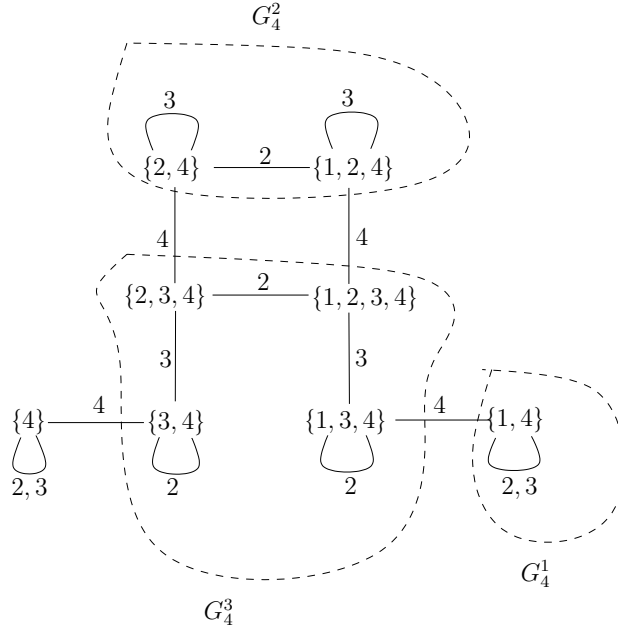

Figure 4: $G_{d,d}$ for $d = \mathbf{d} = 4$

Proposition 4.1. $G_{d,d}$ is the simple extension of $G_{d,d}$ to a $\{2, 3, \dots, \mathbf{d}\}$ -regular graph.

Let $G_{d+1,d}^k$ denote the subgraph of $G_{d+1,d}$ consisting of the vertices $\{a, k, d+1\}$, $a \subset \{1, 2, 3, \dots, k-1\}$.

Proposition 4.2. One can represent $G_{d+1,d}$ as a disjoint union of the graphs $G_{k,d}$, $k = 1, 2, \dots, d$, and the vertex $\{d+1\}$ as follows: for $a \subset \{1, 2, 3, \dots, k-1\}$ map the vertex $a \cup \{k\}$ of $G_{d+1,d}$ to $a \cup \{k, d+1\}$. This maps $G_{k,d}$ to the subgraph $G_{d+1,d}^k$ of $G_{d+1,d}$ consisting of the vertices $a \cup \{k, d+1\}$, $a \subset \{1, 2, 3, \dots, k-1\}$. The same map preserves the edge structure of $G_{k,d}$ as well except for the $d+1$ -loops. These loops on $G_{k,d}$ are broken and are mapped to $d+1$ -edges between $G_{d+1,d}^k$ and $G_{d+1,d}^{d-1}$.

Figure 4 shows an example of the decomposition described in Proposition 4.2.

For $a \subset \{2, 3, 4, \dots, \mathbf{d}\}$ define

$$\mathbf{c}_a^* \doteq (-1)^{|a|-1} \prod_{j=1}^{|a|-1} \prod_{l=a(j)+1}^{a(j+1)} \frac{\mu_l - \lambda}{\mu_l - \mu_{a(j)}} \quad (87)$$

$$\alpha_a^*(l) \doteq \begin{cases} 1 & \text{if } l \leq a(1) \\ \rho_{a(j)}, & \text{if } a(j) < l \leq a(j+1), \\ \rho_{a(|a|)} & \text{if } l > a(|a|), \end{cases} \quad (88)$$

$$\beta_a^* \doteq \rho_{a(|a|)}, \quad (89)$$

$l \in \{2, 3, \dots, \mathbf{d}\}$ (remember that we assume sets ordered and $a(|a|)$ denotes the largest element

in the set). Let us give several examples to these definitions for $\mathbf{d} = 8$:

$$\begin{aligned}
\mathbf{c}_{\{5\}}^* &= 1 \\
\alpha_{\{5\}}^* &= (1, 1, 1, 1, \rho_5, \rho_5, \rho_5) \\
\mathbf{c}_{\{3,6\}}^* &= -\frac{\mu_4 - \lambda}{\mu_4 - \mu_3} \frac{\mu_5 - \lambda}{\mu_5 - \mu_3} \frac{\mu_6 - \lambda}{\mu_6 - \mu_3} \\
\mathbf{c}_{\{3,5,7\}}^* &= (-1)^2 \frac{\mu_4 - \lambda}{\mu_4 - \mu_3} \frac{\mu_5 - \lambda}{\mu_5 - \mu_3} \frac{\mu_6 - \lambda}{\mu_6 - \mu_5} \frac{\mu_7 - \lambda}{\mu_7 - \mu_5} \\
\alpha_{\{3\}}^* &= (1, 1, \rho_3, \rho_3, \rho_3, \rho_3, \rho_3) \\
\alpha_{\{3,6\}}^* &= (1, 1, \rho_3, \rho_3, \rho_3, \rho_6, \rho_6) \\
\alpha_{\{3,5,7\}}^* &= (1, 1, \rho_3, \rho_3, \rho_5, \rho_5, \rho_7) \\
\alpha_{\{8\}}^* &= (1, 1, 1, 1, 1, 1, 1);
\end{aligned} \tag{90}$$

remember that we index the components of α^* with $\{2, 3, 4, \dots, \mathbf{d}\}$; therefore, e.g., the first 1 on the right side of the last line is $\alpha_{\{8\}}^*(2)$.

It follows from (87) and (88) that

$$\begin{aligned}
\mathbf{c}_{a \cup \{d_1, d_2\}}^* &= -\mathbf{c}_{a \cup \{d_1\}}^* \prod_{l=d_1+1}^{d_2} \frac{\mu_l - \lambda}{\mu_l - \mu_{d_1}} \\
\alpha_{a \cup \{d_1\}}^* &= \alpha_{a \cup \{d_1, \mathbf{d}\}}^*
\end{aligned}$$

for any $1 < a(|a|) < d_1 < d_2 \leq \mathbf{d}$ and $a \subset \{2, 3, 4, \dots, \mathbf{d}\}$; These and Proposition 4.2 imply

Proposition 4.3. *For $d < \mathbf{d}$ and $y \in \partial B$*

$$-\left(\prod_{l=d+1}^{\mathbf{d}} \frac{\mu_l - \lambda}{\mu_l - \mu_d} \right) \sum_{a \in V_{G_{d,\mathbf{d}}}} \mathbf{c}_a^*[(\beta_a^*, \alpha_a^*), y] = \sum_{a \in V_{G_{d,d}^d}} \mathbf{c}_a^*[(\beta_a^*, \alpha_a^*), y] \tag{91}$$

Proposition 4.4. *For $d \leq \mathbf{d}$, let $G_{d,\mathbf{d}}$ be as in (84) and (85). Then $(\beta_{a \cup \{d\}}^*, \alpha_{a \cup \{d\}}^*)$, $\mathbf{c}_{a \cup \{d\}}^*$, $a \subset \{1, 2, 3, \dots, d-1\}$, defined in (87), solve the harmonic system defined by $G_{d,\mathbf{d}}$.*

Proof. A d' tandem walk is a simple extension of the tandem walk defined by its first $d' - 1$ dimensions. This, Propositions 4.1, 3.3 and the definitions of β^* and α^* above imply that it suffices to prove the current proposition only for $d = \mathbf{d}$.

The vertices of $G_{\mathbf{d},\mathbf{d}}$ are $a \cup \{\mathbf{d}\}$, $a \subset \{1, 2, 3, \dots, \mathbf{d} - 1\}$, and for all of them we have $\beta_{a \cup \{\mathbf{d}\}}^* = \rho_{\mathbf{d}}$ by definition (89). Let us begin by showing $(\rho_{\mathbf{d}}, \alpha_{a \cup \{\mathbf{d}\}}^*)$, $a \subset \{1, 2, 3, \dots, \mathbf{d} - 1\}$ is on the characteristic surface \mathcal{H} of the tandem walk. We will write α^* instead of $\alpha_{a \cup \{\mathbf{d}\}}^*$, the set a will be clear from context.

Let us first consider the case when $a(1) > 1$, i.e., when $1 \notin a$; the opposite case is treated similarly and is left to the reader. Then $\alpha^*(l) = 1$ for $2 \leq l \leq a(1)$. By definition $\alpha^*(i) = \alpha^*(i+1)$ if $a(j) < i < a(j+1)$; these and $\beta_{a \cup \{\mathbf{d}\}}^* = \rho_{\mathbf{d}}$ give

$$\begin{aligned}
\mathbf{p}(\rho_{\mathbf{d}}, \alpha^*) &= \mu_{\mathbf{d}} + \sum_{j=1}^{a(1)-1} \mu_j + \mu_{a(1)} \rho_{a(1)} + \sum_{j \in (a^c - \{1 \dots a(1)-1\})} \mu_j \\
&+ \sum_{j \in (a - \{a(1)\})} \mu_j \frac{\alpha^*(j+1)}{\alpha^*(j)} + \rho_{\mathbf{d}} \frac{\mu_{\mathbf{d}}}{\alpha^*(\mathbf{d})}
\end{aligned}$$

(where $a^c = \{1, 2, 3, \dots, \mathbf{d} - 1\} - a$) and in the last expression we have used the convention $\alpha^*(\mathbf{d} + 1) = \beta^*$; by definition (88) $\alpha^*(a(j + 1)) = \rho_{a(j)}$, $\alpha^*(a(j)) = \rho_{a(j-1)}$ and therefore

$$\begin{aligned} &= \mu_{\mathbf{d}} + \sum_{j=1}^{a(1)-1} \mu_j + \lambda + \sum_{j \in (a^c - \{1 \dots a(1)-1\})} \mu_j \\ &\quad + \sum_{j=2}^{|\mathbf{a}|} \mu_{a(j)} \frac{\rho_{a(j)}}{\rho_{a(j-1)}} + \mu_{a(|\mathbf{a}|)} \end{aligned}$$

$\mu_{a(j)} \rho_{a(j)} / \rho_{a(j-1)} = \mu_{a(j-1)}$ implies

$$\begin{aligned} &= \mu_{\mathbf{d}} + \sum_{j=1}^{a(1)-1} \mu_j + \lambda + \sum_{j \in (a^c - \{1 \dots a(1)-1\})} \mu_j \\ &\quad + \sum_{j=2}^{|\mathbf{a}|} \mu_{a(j-1)} + \mu_{a(|\mathbf{a}|)} \\ &= \mu_{\mathbf{d}} + \sum_{j=1}^{a(1)-1} \mu_j + \lambda + \sum_{j \in (a^c - \{1 \dots a(1)-1\})} \mu_j + \sum_{j \in a} \mu_j = 1; \end{aligned}$$

i.e., $(\rho_{\mathbf{d}}, \alpha^*) \in \mathcal{H}$.

If $a_1 \neq a_2$ take any $i \in a_1 - a_2$ (relabel the sets if necessary so that $a_1 - a_2 \neq \emptyset$). Let j be the index of i in a_1 , i.e., $a_1(j) = i$. Then by definition, $\alpha_{a_1 \cup \{\mathbf{d}\}}^*(j + 1) = \rho_i$; but $i \notin a_2$ and (80) imply that no component of $\alpha_{a_1 \cup \{\mathbf{d}\}}^*$ equals ρ_i , and therefore $\alpha_{a_1 \cup \{\mathbf{d}\}}^* \neq \alpha_{a_2 \cup \{\mathbf{d}\}}^*$. This shows that $\alpha_{a \cup \{\mathbf{d}\}}^*$, $a \subset \{1, 2, \dots, \mathbf{d} - 1\}$ satisfy the second part of Definition 3.2.

Fix a vertex $a \cup \{\mathbf{d}\}$ of $G_{\mathbf{d}, \mathbf{d}}$. By definition, for each of its elements l , this vertex is connected to $a \cup \{\mathbf{d}\} \cup \{l - 1\}$ if $l - 1 \notin a$ or to $a \cup \{\mathbf{d}\} - \{l - 1\}$ if $l - 1 \in a$. Then to show that $(\beta_{a \cup \{\mathbf{d}\}}^*, \alpha_{a \cup \{\mathbf{d}\}}^*)$, $a \subset \{1, 2, 3, \dots, \mathbf{d} - 1\}$ satisfy the third part of Definition 3.2 it suffices to prove that for each $a \subset \{1, 2, 3, \dots, \mathbf{d} - 1\}$, and each $l \in a \cup \{\mathbf{d}\}$ such that $l - 1 \notin a \cup \{\mathbf{d}\}$ $\alpha_{a \cup \{\mathbf{d}\}}^*$ and $\alpha_{a \cup \{\mathbf{d}\} \cup \{l-1\}}^*$ are l -conjugate. For ease of notation let us denote $a \cup \{l - 1\}$ by a_1 , $\alpha_{a \cup \{\mathbf{d}\}}^*$ by α^* , $\alpha_{a_1 \cup \{\mathbf{d}\}}^*$ by α_1^* and $\beta_{a_1}^* = \beta_a^*$ by β^* (because we have assumed $d = \mathbf{d}$, both β^* and β_1^* are equal to $\rho_{\mathbf{d}}$). We want to show that (β^*, α^*) and (β^*, α_1^*) are l -conjugate. Let us assume $2 < l < \mathbf{d}$, the cases $l = 2, \mathbf{d}$ are treated almost the same way and are left to the reader. By assumption $l \in \alpha^*$ but $l - 1 \notin \alpha^*$. If l is the j^{th} element of a , i.e., $l = a(j)$; then $a(k) = a_1(k)$ for $k < j$, $a_1(j) = l - 1$, $a(k - 1) = a_1(k)$ for $k > j$. This and the definition (88) of α^* imply

$$\alpha^*(i) = \alpha_1^*(i), i \in \{2, 3, 4, \dots, \mathbf{d}\}, i \neq l, \quad (92)$$

i.e., α^* and α_1^* satisfy (58) (for example, for $\mathbf{d} = 8$, $\alpha_{\{3,6\}}^*$ is given in (90); on the other hand $\alpha_{\{3,5,6\}}^* = (1, 1, \rho_3, \rho_3, \rho_5, \rho_6, \rho_6)$ and indeed $\alpha_{\{3,6\}}^*(i) = \alpha_{\{3,5,6\}}^*(i)$, $i \neq 6$). Definition (88) also implies

$$\alpha_1^*(l) = \rho_{a_1(j)} = \rho_{l-1}, \quad \alpha_1^*(l + 1) = \rho_{a_1(j+1)} = \rho_l, \quad (93)$$

On the other hand, again by (88), and by $l - 1 \notin a$, we have

$$\alpha^*(l) = \alpha^*(l - 1) = \rho_{a(j-1)} \quad \text{and} \quad \alpha^*(l + 1) = \rho_l.$$

Then

$$\frac{1}{\alpha^*(l)} \frac{\alpha^*(l-1)\alpha^*(l+1)\mu_l}{\mu_{l-1}} = \rho_{l-1}$$

and, by (93) this equals $\alpha_1^*(l)$, i.e., α_1^* and α^* satisfy (82). This and (92) mean that (β^*, α_1^*) and (β^*, α) are l -conjugate.

Now we will prove that the $\mathbf{c}_{a \cup \{\mathbf{d}\}}^*$, $a \subset \{2, 3, 4, \dots, \mathbf{d}-1\}$ defined in (87) satisfy the fourth part of Definition 3.2. The structure of $G_{\mathbf{d}, \mathbf{d}}$ implies that it suffices to check that

$$\frac{\mathbf{c}_a^*}{\mathbf{c}_{a_1}^*} = -\frac{C(l', \rho_{\mathbf{d}}, \alpha_{a_1}^*)}{C(l', \rho_{\mathbf{d}}, \alpha_a^*)} \quad (94)$$

holds for any $l' \in a$ such that $l' - 1 \notin a$ and $a_1 = a \cup \{l' - 1\}$. There are three cases to consider: $l' = 2$, $l' = \mathbf{d}$ and $2 < l' < \mathbf{d}$; we will only treat the last. For $2 < l' < \mathbf{d}$ one needs to further consider the cases $a(1) = l'$ and $a(1) < l'$. For $b \subset \{2, 3, 4, \dots, \mathbf{d}-1\}$, $\mathbf{c}_{b \cup \{\mathbf{d}\}}^*$ of (87) is the product of a parity term and a running product of $\mathbf{d} - b(1)$ ratios of the form $(\mu_l - \lambda)/(\mu_l - \mu_{b(j)})$. The ratio of the parity terms of a and a_1 is -1 because a_1 has one additional term. If $a(1) = l'$ then $a_1(1) = l' - 1$ and the only difference between the running products in the definitions of \mathbf{c}^* and \mathbf{c}_1^* is that the latter has an additional initial term $(\mu_{l'} - \lambda)/(\mu_{l'} - \mu_{l'-1})$ and therefore

$$\frac{\mathbf{c}_a^*}{\mathbf{c}_{a_1}^*} = -\frac{\mu_{l'} - \mu_{l'-1}}{\mu_{l'} - \lambda}.$$

Because $l' > 2$ and $l' - 1 \geq 2$, definition (88) implies $\alpha^*(l') = 1$, $\alpha^*(l' + 1) = \rho_l$, $\alpha_1^*(l) = \rho_{l-1}$ and $\alpha_1^*(l + 1) = \rho_l$. These and (83) imply

$$\frac{C(l, \rho_{\mathbf{d}}, \alpha_{a_1}^*)}{C(l, \rho_{\mathbf{d}}, \alpha_a^*)} = \frac{\mu_{l'} - \mu_{l'-1}}{\mu_{l'} - \lambda}.$$

The last two display imply (94) for $a(1) = l'$.

If $l' > a(1)$, let $j > 1$ be the position of l in a , i.e., $l = a(j)$. In this case, the definition (87) implies that the running products in the definitions of \mathbf{c}_a^* and $\mathbf{c}_{a_1}^*$ are a product of the same ratios except for the $(l')^{\text{th}}$ terms, which is $(\mu_{l'} - \lambda)/(\mu_{l'} - \mu_{a(j-1)})$ for a and $(\mu_{l'} - \lambda)/(\mu_{l'} - \mu_{l'-1})$ for a_1 . a_1 has one more element than a , therefore, the ratio of the parity terms is again -1 ; these imply

$$\frac{\mathbf{c}_a^*}{\mathbf{c}_{a_1}^*} = -\frac{\mu_{l'} - \mu_{l'-1}}{\mu_{l'} - \mu_{a(j-1)}}.$$

On the other hand, $l' \in a$, $j > 1$, $a_1 = a \cup \{l' - 1\}$ and the definition (88) imply $\alpha^*(l') = \rho^*(a(j-1))$, $\alpha^*(l' + 1) = \rho_{l'}$, $\alpha_1^*(l') = \rho_{l'-1}$, and $\alpha_1^*(l' + 1) = \rho_{l'}$ and therefore

$$\frac{C(l', \rho_{\mathbf{d}}, \alpha_{a_1}^*)}{C(l', \rho_{\mathbf{d}}, \alpha_a^*)} = \frac{\mu_{l'} - \mu_{l'-1}}{\mu_{l'} - \mu_{a(j-1)}}.$$

The last two displays once again imply (94) for $l' > a(1)$.

Consider a vertex $a \cup \{\mathbf{d}\}$ of $G_{\mathbf{d}, \mathbf{d}}$; by definition (86), the loops on this vertex are $\{2, 3, \dots, \mathbf{d}\} - a \cup \{\mathbf{d}\}$. For $l \in \{2, 3, \dots, \mathbf{d}\} - a \cup \{\mathbf{d}\}$ the definition (88) implies

$$\alpha_{a \cup \{\mathbf{d}\}}^*(l) = \alpha_{a \cup \{\mathbf{d}\}}^*(l + 1);$$

we have already shown $\alpha_{a \cup \{\mathbf{d}\}}^* \in \mathcal{H}$, then, Lemma 11 and the last display imply $\alpha_{a \cup \{\mathbf{d}\}}^* \in \mathcal{H}_l$ for $l \in \{2, 3, \dots, \mathbf{d}\} - a \cup \{\mathbf{d}\}$; i.e., the last part of Definition 3.2 is also satisfied. This finishes the proof of the proposition. \square

Proposition 4.5.

$$h_d^* \doteq \sum_{a \subset \{1,2,3,\dots,d-1\}} \mathbf{c}_{a \cup \{d\}}^* [(\rho_d, \alpha_{a \cup \{d\}}^*), \cdot], \quad (95)$$

$d = 1, 2, 3, \dots, \mathbf{d}$, are ∂B -determined Y -harmonic functions.

Proof. That h_d^* is Y -harmonic follows from Propositions 4.4 and 3.2. The components of $\alpha_{a \cup \{d\}}^*$, $a \subset \{1, 2, 3, \dots, d-1\}$ and $\beta_d^* = \rho_d$ are all between 0 and 1. This and Proposition 3.4 imply that h_d^* are all ∂B -determined. \square

With definition (95) we can rewrite (91) as

$$- \left(\prod_{l=d+1}^{\mathbf{d}} \frac{\mu_l - \lambda}{\mu_l - \mu_d} \right) h_d^*(y) = \sum_{a \in V_{G_d}^d} \mathbf{c}_a^* [(\beta_a^*, \alpha_a^*), y] \quad (96)$$

for $y \in \partial B$.

Theorem 4.1.

$$\mathbb{P}_y(\tau < \infty) = \sum_{d=1}^{\mathbf{d}} \left(\prod_{l=d+1}^{\mathbf{d}} \frac{\mu_l - \lambda}{\mu_l - \mu_d} \right) h_d^*(y) \quad (97)$$

for $y \in B$.

For $\mathbf{d} = 2$ (97) reduces to

$$\mathbb{P}_y(\tau < \infty) = \left(\rho_2^{y(1)-y(2)} - \frac{\mu_2 - \lambda}{\mu_2 - \mu_1} \rho_2^{y(1)-y(2)} \rho_1^{y(2)} \right) + \frac{\mu_2 - \lambda}{\mu_2 - \mu_1} \rho_1^{y(1)},$$

which is the formula given in [10] for $\mathbf{d} = 2$.

Proof. Let $\mathbf{1} \in \mathbb{C}^{\{2,3,\dots,\mathbf{d}\}}$ denote the vector with all components equal to 1. The decomposition of G_d into the single vertex $\{d\}$ and G_d^d , $d < \mathbf{d}$ implies that the right side of (97) equals

$$[(\rho_d, \mathbf{1}), y] + \sum_{d=1}^{\mathbf{d}-1} \sum_{a \in V_{G_d^d}} \mathbf{c}_a^* [(\beta_a^*, \alpha_a^*), y] + \sum_{d=1}^{\mathbf{d}-1} \left(\prod_{l=d+1}^{\mathbf{d}} \frac{\mu_l - \lambda}{\mu_l - \mu_d} \right) h_d^*(y)$$

for $y \in \partial B$ (96) implies

$$= [(\rho_d, \mathbf{1}), y],$$

which, for $y \in \partial B$, equals 1. Thus, we see that the right side of (97) equals 1 on ∂B . Proposition 4.5 says that the same function is ∂B -determined and is Y -harmonic. Then its restriction to B must be indeed equal to $y \rightarrow \mathbb{P}_y(\tau < \infty)$, $y \in B$, which is the unique function with those properties. \square

5 Numerical Example

Take a four dimensional tandem system with rates, for example,

$$\lambda = 1/18, \mu_1 = 3/18, \mu_2 = 7/18, \mu_3 = 2/18, \mu_4 = 5/18.$$

For $n = 60$, and in four dimensions, the probability $\mathbb{P}_x(\tau_n < \tau_0)$ can be computed numerically by iterating the harmonic equation $\mathbb{P}_x(\tau_n < \tau_0) = \mathbb{E}_x[\mathbb{P}_{X_1}(\tau_n < \tau_0)]$. Let $f(y)$ denote the right side of (97). Define $V_n = -\log(\mathbb{P}_x(\tau_n < \tau_0))/n$ and $W_n = -\log f(T_n(x))/n$. The level curves of V_n and W_n and the graph of the relative error $(V - W)/V$ for $x = (i, j, 0, 0, 0)$ and $x = (0, i, 0, j, 0)$, $i, j \leq n = 60$ are shown in Figure 5; qualitatively these graphs show results similar to those reported in [10]: almost zero relative error across the domain selected, except for a boundary layer along the $x(4)$ -axis, where the relative error is bounded by 0.05. The size of the boundary layer is determined by the set R_ρ of (45) and Theorem 2.1.

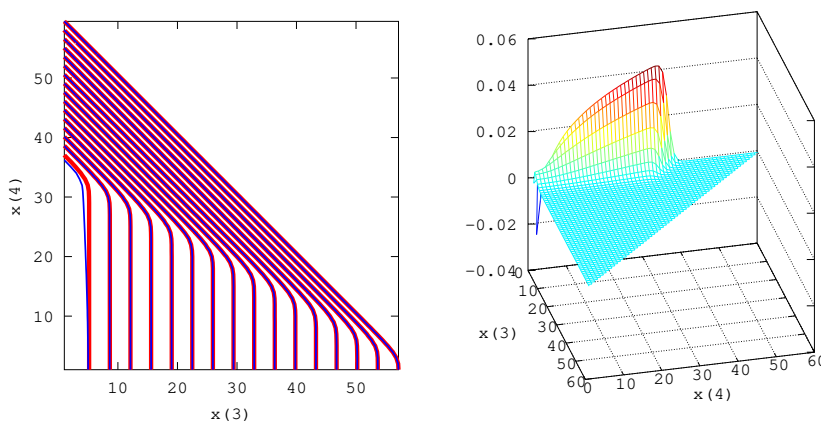

Figure 5: Level curves and relative error in four dimensions

Finally we consider the 14-tandem queues with parameter values shown in Figure 6.

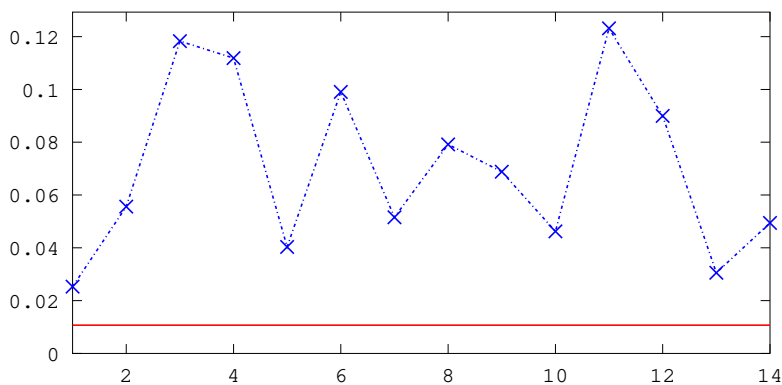

Figure 6: The service rates (blue) and the arrival rate (red) for a 14-dimensional tandem Jackson network

For $n = 60$, A_n contains $60^{14}/14! = 8.99 \times 10^{13}$ states which makes impractical an exact calculation via iterating the harmonic equation satisfied by $\mathbb{P}_y(\tau_n < \tau_0)$. On the other hand,

(97) has $2^{15} = 32768$ summands and can be quickly calculated. Define W_n as before. Its graph over $\{x : x(4) + x(14) \leq 60, x(j) = 0, j \neq 4, 14\}$ is depicted in Figure 7. For

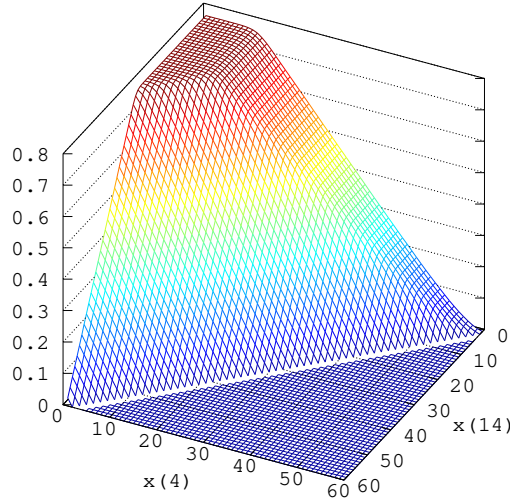

Figure 7: The graph of W_n over $\{x : x(4) + x(14) = 60, x(j) = 0, j \neq 4, 14\}$

a finer approximation of $\mathbb{P}_{(1,0,\dots,0)}(\tau_n < \tau_0)$ we use importance sampling based on W_n . With 12000 samples IS gives the estimate 7.53×10^{-20} with an estimated 95% confidence interval $[6.57, 8.48] \times 10^{-20}$ (rounded to two significant figures). The value given by our approximation (97) for the same probability is $f((1, 0, \dots, 0)) = 1.77 \times 10^{-20}$ which is approximately $1/4^{th}$ of the estimate given by IS. The large deviation estimate of the same probability is $(\lambda / \min_{i=1}^{14}(\mu_i))^{60} = 4.15 \times 10^{-23}$. The discrepancy between IS and (97) quickly disappears as $x(1)$ increases. For example, for $x(1) = 4$, IS gives 2.47×10^{-19} and (97) gives 2.32×10^{-19} .

6 Conclusion

In Section 4 we computed $\mathbb{P}_y(\tau < \infty)$ under the assumption $\mu_i \neq \mu_j$ for $i \neq j$. One can obtain formulas for $\mathbb{P}_y(\tau < \infty)$ when this assumption is violated by computing limits of (97) as $\mu_i \rightarrow \mu_j$; this limiting process introduces polynomial terms to the formula. For example, for $d = 3$ and $\mu_1 = \mu_2 = \mu_3 = \mu$ we get

$$\mathbb{P}_y(\tau < \infty) = \rho^{\bar{y}(1)} \left(\frac{1}{2} c_0^2 (\bar{y}(1))^2 \rho^{y(2)+y(3)} + \rho^{y(3)} \left(\left(\frac{c_0^2}{2} + y(3)c_0^2 \right) \rho^{y(2)} + c_0 \right) \bar{y}(1) + 1 \right),$$

where $c_0 = (\mu - \lambda)/\mu$ and $\bar{y}(1) = y(1) - (y(2) + y(3))$. Similar limits can be computed explicitly for the cases $\mu_1 = \mu_2 \neq \mu_3$, $\mu_1 = \mu_3 \neq \mu_2$ and $\mu_1 \neq \mu_2 = \mu_3$. A systematic study of these cases in three and higher dimensions remain for future work.

Another obvious direction for future work is the study of more general dynamics and exit boundaries. We refer the reader to [10, Conclusion] for further comments on possible directions for future research.

References

- [1] Jose Blanchet, *Optimal sampling of overflow paths in Jackson networks*, Mathematics of Operations Research **38** (2013), no. 4, 698–719.
- [2] Reinhard Diestel, *Graph theory*, fifth ed., Graduate Texts in Mathematics, vol. 173, Springer, Heidelberg; New York, 2017.
- [3] Paul Dupuis, Ali Devin Sezer, and Hui Wang, *Dynamic importance sampling for queueing networks*, Annals of Applied Probability **17** (2007), no. 4, 1306–1346.
- [4] Paul Glasserman and Shing-Gang Kou, *Analysis of an importance sampling estimator for tandem queues*, ACM Transactions on Modeling and Computer Simulation **5** (1995), 22–42.
- [5] Irina Ignatiouk-Robert, *Large deviations of jackson networks*, Annals of Applied Probability (2000), 962–1001.
- [6] Fatma Başoğlu Kabran and Ali Devin Sezer, *Approximation of the exit probability of a stable markov modulated constrained random walk*, Annals of Operations Research (2020), 1–45.
- [7] Shyam Parekh and Jean Walrand, *A quick simulation method for excessive backlogs in networks of queues*, IEEE Transactions on Automatic Control **34** (1989), no. 1, 54–66.
- [8] Ali Devin Sezer, *Dynamic importance sampling for queueing networks, ph.d. thesis*, Brown University Division of Applied Mathematics, 2005.
- [9] Ali Devin Sezer, *Exit probabilities and balayage of constrained random walks*, arXiv preprint arXiv:1506.08674 (2015).
- [10] ———, *Approximation of excessive backlog probabilities of two tandem queues*, Journal of Applied Probability **55** (2018), no. 3, 968–997.
- [11] Kamil Demirberk Ünlü and Ali Devin Sezer, *Excessive backlog probabilities of two parallel queues*, Annals of Operations Research (2019), 1–34.