

SCHUBERT PUZZLES AND INTEGRABILITY II: MULTIPLYING MOTIVIC SEGRE CLASSES

ALLEN KNUTSON AND PAUL ZINN-JUSTIN

ABSTRACT. In *Schubert Puzzles and Integrability I* we proved several “puzzle rules” for computing products of Schubert classes in K-theory (and sometimes equivariant K-theory) of d -step flag varieties. The principal tool was “quantum integrability”, in several variants of the Yang–Baxter equation; this let us recognize the Schubert structure constants as $q \rightarrow 0$ limits of certain matrix entries in products of R- (and other) matrices of $\mathcal{U}_q(\mathfrak{g}[z^{\pm}])$ -representations. In the present work we give direct cohomological interpretations of those same matrix entries but at finite q : they compute products of “motivic Segre classes”, closely related to K-theoretic Maulik–Okounkov stable classes living on the *cotangent bundles* of the flag varieties. Without $q \rightarrow 0$, we avoid some divergences that blocked fuller understanding of $d = 3, 4$. The puzzle computations are then explained (in cohomology only in this work, not K-theory) in terms of Lagrangian convolutions between Nakajima quiver varieties. More specifically, the conormal bundle to the diagonal inclusion of a flag variety factors through a quiver variety that is not a cotangent bundle, and it is on *that* intermediate quiver variety that the R-matrix calculation occurs.

CONTENTS

1. Introduction	2
1.1. What puzzles “really” compute	2
1.2. The ring with basis	3
1.3. Our main results	4
1.4. Plan of the paper	4
Acknowledgments	5
2. Stable and motivic Segre classes	5
2.1. Geometric setup	5
2.2. Localization	6
2.3. The single-number R-matrix	6
2.4. Motivic Segre classes	8
2.5. Relation to stable classes	11
3. The puzzle rule	14
3.1. The representation theory	15
3.2. The R-matrices	18
3.3. The main theorem	21
3.4. The hierarchy of bases	25
3.5. Inversion numbers and Drinfeld twist	26
4. Example: $d = 1$	28
4.1. The $d = 1$ setup	28
4.2. Back to Schubert calculus in $\text{Gr}(k, n)$	30

Date: April 22, 2024.

AK was supported by NSF grant 1953948.

PZJ was supported by ARC grant FT150100232.

4.3. Nonequivariant rule and loop model	30
5. The limit to ordinary cohomology	33
5.1. Localization revisited	33
5.2. Segre–Schwartz–MacPherson classes	33
5.3. H_{\dagger}^* puzzle rules for $d \leq 3$	34
5.4. Some details on $d = 4$	37
5.5. An interpretation of the nonequivariant-cohomology puzzle rule	42
6. Positivity	46
6.1. Positivity in equivariant K-theory	46
6.2. Positivity in equivariant cohomology	47
6.3. Positivity in nonequivariant K-theory and cohomology	47
7. A couple of results on Nakajima quiver varieties	47
7.1. The varieties	47
7.2. The geometry of figures 1–4	49
8. Geometric interpretation of puzzles	51
8.1. The “category” of correspondences	51
8.2. Weinstein’s “category” of symplectic manifolds	52
8.3. Correspondences and (equivariant) cohomology, and dividing by the zero section	54
8.4. Stable envelopes	55
8.5. The flag type case	56
8.6. $d = 1$	56
8.7. $d = 2$.	64
8.8. $d = 3, 4$.	65
Appendix A. Quantized affine algebras	69
A.1. Generators and relations	69
A.2. Affine case	69
A.3. Evaluation representation	69
Appendix B. R-matrices at $d = 1$	70
Appendix C. Examples of $d = 4$ puzzles	72
C.1. $d = 3$ vs $d = 4$	72
C.2. Zero weight states	73
C.3. Violation of inversion number inequalities	75
Appendix D. Scalar products	76
References	78

1. INTRODUCTION

1.1. What puzzles “really” compute. Equivariant puzzles were introduced in [KT03] to study Grassmannian Schubert calculus, and were related to quantum integrable systems in [ZJ09, WZJ19]. In our previous paper [KZJ17] we extended this connection beyond 1-step flag manifolds (i.e., Grassmannians) to 2- and 3-step flag manifolds. This required recognizing the puzzle labels (for a fixed number of steps d) as indexing the basis vectors in three representations of a quantized loop algebra $\mathcal{U}_q(\mathfrak{g}[z^{\pm}])$ (one representation for each edge angle: $/$, $—$, \backslash).

The state sums computed using the R-matrices of those representations then came with an extra parameter q not appearing in the Schubert calculus structure constants; to be rid of it, we took $q \rightarrow 0$ or $q \rightarrow \infty$. This point was subtle enough that at $d = 3$, we were

unable to take this limit without first losing equivariance, and so we only discovered (and proved) in this way a formula for *nonequivariant* K-theoretic Schubert calculus on 3-step flag manifolds.

The purpose of the present paper is to give a cohomological interpretation of these puzzle state sums at general q , not just as $q^\pm \rightarrow 0$ (and in particular, to recover equivariance in 3-step, and extend to 4-step). They are again structure constants for multiplication of a certain ring-with-basis; the ring is no longer cohomology (or equivariant, or K-cohomology) of a d -step flag manifold, but rather of its cotangent bundle¹, and properly speaking the basis elements live only in an equivariant localization (we must formally invert the class of the zero section in the cotangent bundle).

These cotangent bundle calculations can to some extent be interpreted on the base; our best result in this direction is theorem 5.4, a puzzle formula for the Euler characteristic of the intersection of three generically situated Bruhat cells. (In the traditional setting, one only computes this number when the intersection is 0-dimensional.)

1.2. The ring with basis. In [MO19, Oko15] are defined “stable bases” of the cohomology and K-theory of “symplectic resolutions”, a class of spaces that includes cotangent bundles to flag manifolds. These bases depend on a choice of symplectic circle action with isolated fixed points, and are closely analogous to Schubert bases of cohomology of flag manifolds. In both cases, one considers the Białynicki–Birula attracting sets of the fixed points. In the Schubert situation the classes are those of the closures of the attracting sets. In the symplectic-resolution situation, *if* an attracting set is closed – which is automatic when the resolution is affine enough; see lemma 8.3 – then the associated “stable class” in cohomology is indeed that of the attracting set.

On a general symplectic resolution M an attracting set (while automatically Lagrangian) need not be closed. (This unfortunate behavior occurs in the case of most interest in this paper, the cotangent bundle $T^*(P_- \backslash G)$ to a flag manifold $P_- \backslash G$.) However, symplectic resolutions always have T -equivariant deformations \widetilde{M} to affine varieties M_α on which the attracting sets *are* closed. (For example, $T^*(P_- \backslash G)$ has a Grothendieck–Springer deformation to the affine variety $L \backslash G$, where L is a Levi subgroup of the parabolic P_- .)

Using such a deformation, we can define the stable class *in cohomology* associated to a fixed point as follows. We deform the symplectic resolution M to affine M_α , obtain the (closed, Lagrangian) attracting cycle C_α inside M_α and follow that subvariety C_α back through the degeneration, to $C \subseteq M$.

In the $H_{T \times \mathbb{C}^\times}^*(T^*(P_- \backslash G)) \cong H_T^*(P_- \backslash G)[\hbar]$ case this C is a union of conormal varieties to Schubert varieties (with complicated multiplicities). This is already sufficient to show that the Schubert classes arise as the \hbar -leading terms in the stable classes, where \hbar is the weight of the dilation action on the cotangent fibers. In particular, if we invert \hbar then the stable classes are a basis over $H_T^*[\hbar^\pm]$. (The thesis [Col16] concerns the product structure in this basis, but only when $P_- \backslash G$ is projective space.)

In K-theory, using the classes of the structure sheaves of the attracting sets (or their degeneration from affine) doesn’t lead to an especially good basis; it seems that one wants the classes of some other sheaves. However, there is no unique limit when degenerating sheaves, so we can’t use the above limiting trick to define “K-theoretic stable classes”.

¹Of course the manifold and its cotangent bundle are equivariantly homotopic, but the extra parameter is only geometrically natural on the cotangent bundle.

Instead we give in proposition 2.7 a recurrence relation on the equivariant K-theoretic stable classes St^λ , closely related to ones in [SZZ20, AMSS19].

Let $i : P_- \setminus G \rightarrow T^*(P_- \setminus G)$ be the zero section, and $[P_- \setminus G]$ the class of its image. Since for all fixed points μ the point restriction $[P_- \setminus G]_{|\mu}$ is nonzero, we get a well-defined element $[P_- \setminus G]^{-1}$ in the appropriately localized equivariant K-theory $K_{T \times \mathbb{C}^\times}^{\text{loc}}(T^*(P_- \setminus G))$. Finally, following the terminology of [AMSS19, footnote 1] we define for now the **motivic Segre class** S^λ as the ratio $St^\lambda / [P_- \setminus G]$ in this localization. (An alternate, more explicit, definition is given in §2.)

1.3. Our main results. For $d \leq 4$, we define a second group X_{2d} , three representations $V_1(z_1), V_2(z_2), V_3(z_3)$ of its quantized loop algebra $\mathcal{U}_q(\mathfrak{r}_{2d}[z^\pm])$, and intertwiners

$$\check{R} : V_1(z_1) \otimes V_2(z_2) \rightarrow V_2(z_2) \otimes V_1(z_1), \quad U : V_1(q^{h_d/3}z) \otimes V_2(q^{-h_d/3}z) \rightarrow V_3(z)$$

(h_d being the dual Coxeter number of X_{2d}) that satisfy the Yang–Baxter and bootstrap equations exactly as in [KZJ17, §3]. Puzzles provide a way to compute the matrix entries in a massive product of Rs and Us, and via essentially the same proof as in [KZJ17, §3] we show that puzzles compute the product of the motivic Segre classes. (There are some new puzzle pieces required at finite q , that were suppressed as $q \rightarrow \infty$.)

One key difference between the $d = 4$ case, vs. the $d = 1, 2, 3$ cases we studied in [KZJ17], is that the representations $V_a(z_i)$ are not minuscule – rather, each is the adjoint-plus-trivial representation of \mathfrak{e}_8 , bearing a 9-dimensional central weight space. To write down \check{R}, U as matrices requires picking bases of this weight space and its dual. (These choices were unique up to a simple gauge equivalence, in the $d = 1, 2, 3$ cases.) We do this in §5.4.

The close relation between SSM classes and Euler characteristics gives us a corollary that can be stated completely within the Grassmannian: a puzzle formula (in §5.5) for the topological Euler characteristic of the intersection of three generically translated Bruhat cells. In particular, this gives a positivity result for $d \leq 3$ for these Euler characteristics (times the sign familiar from K-theory) for which there was no known geometric proof, and based on it we conjectured that the positivity holds for triple intersections of Bruhat cells in general G/P . Since this paper was written, that conjecture has been proven, in [SSW23].

Define a **positivity notion** in Schubert calculus to be a submonoid M (under $+$) of the coefficient ring (either the cohomology of a point, or a localization thereof) s.t. $M \cap -M = 0$. The principal consequence is that a sum of elements of M is zero only if each term is zero. Call a formula **manifestly M-positive** if it is a sum of terms, each in $M \setminus 0$.

We show that our puzzle formulae for the coefficients in the product of motivic Segre classes are manifestly M -positive for some M to be specified, for $d = 1, 2$ equivariantly, and $d = 1, 2, 3$ nonequivariantly.

1.4. Plan of the paper. In §2 we define the motivic Segre classes on type A partial flag manifolds. In §3 we state the main formula (a bit schematically, with detailed fugacities in §4 and appendix B; see also §5.3-5.4 for the $d = 2, 3, 4$ cases in cohomology. In particular, in §3.4 we collect the various limiting versions of our main theorem, from K to H , from motivic Segre classes to Schubert classes, and from equivariant to nonequivariant. In §4 we provide full details on the $d = 1$ (Grassmannian) case, and give in §4.3 a loop-model interpretation of the nonequivariant puzzles; in this model we can sum over fewer puzzles, at the cost of measuring global features of each (the number of loops). In §5 we

pass from K-theory to ordinary cohomology, where we can more reasonably explore the $d = 3, 4$ cases. This is also where we give a puzzle formula for the Euler characteristic of the intersection of three Bruhat cells. We discuss positivity of our puzzle rules in §6.

In the remaining two sections, we give a retrodiction of our results (at least in cohomology) using quiver varieties. In §7 we recall the definitions and results we need about them, and give a new result (proposition 7.2) about recognizing quiver varieties as cotangent bundles of partial flag varieties. This is also where we recognize the type A_d R-matrix as sitting inside the type X_{2d} R-matrix (lemma 7.3). In §8 we sneak up on the X_{2d} -based puzzles through several steps: replace the diagonal inclusion $M \rightarrow M \times M$ (whose pullback defines the multiplication on cohomology) by the conormal bundle of its graph (lemma 8.1), factor that correspondence through an X_{2d} quiver variety (proposition 8.5), obtain the SSM classes using stable envelopes (recalled in §8.4), and show that the failure of the resulting Lagrangian-correspondence squares to commute can be computed using puzzles (§8.6.3).

Appendix A gives the presentation of the quantized affine algebras and their representations that we need. Appendix B computes the full details of these representations, for $d = 1$. Appendix C provides examples of $d = 4$ puzzles, whereas Appendix D is a table of scalar products that is useful for computing H_T -fugacities of $d \leq 3$ puzzles.

In our next paper [KZJ23] in this series we will exploit some other quiver varieties to solve some additional families of Schubert calculus problems.

Finally, we mention that all results of this paper were carefully checked by computer with the help of *Macaulay2* [GS]. In particular, the puzzle rules of [KZJ17] and of the present paper are implemented in the package *CotangentSchubert* [ZJ21].

Acknowledgments. We thank Iva Halacheva, David Hernandez, Leonardo Mihalcea, and Hiraku Nakajima for discussions on many related topics.

2. STABLE AND MOTIVIC SEGRE CLASSES

2.1. Geometric setup.

2.1.1. *Cotangent bundles of flag varieties.* Let $G = GL_n(\mathbb{C})$, B_{\pm} denote the upper/lower triangular matrices, with intersection T the diagonal matrices, and let $P_- \geq B_-$ be a parabolic subgroup with Levi factor $\prod_{i=0}^d GL_{p_i}(\mathbb{C})$. The main actors of this paper are the coset space $P_- \backslash G$ and its cotangent bundle $T^*(P_- \backslash G) \xrightarrow{P} P_- \backslash G$. The torus T naturally acts on $P_- \backslash G$, but the cotangent bundle $T^*(P_- \backslash G)$ has an extra circle action by scaling of the fiber, resulting in an action of $\hat{T} := T \times \mathbb{C}^{\times}$. The T -fixed points in $P_- \backslash G$ (or \hat{T} -fixed points in $T^*(P_- \backslash G)$) are indexed by elements of $W_p \backslash W$, where $W = N(T)/T \cong \mathcal{S}_n$ and $W_p = W \cap P_- \cong \prod_{i=0}^d \mathcal{S}_{p_i} \backslash \mathcal{S}_n$. We denote by α (resp. ω) the smallest (resp. largest) element in W/W_p w.r.t. the Bruhat order. As in [KZJ17], we identify elements of $W_p \backslash W$ and strings of n letters in the alphabet $\{0, \dots, d\}$, where W acts on strings by permuting their labels, and W_p is the stabilizer of ω , which is identified with the unique weakly increasing string $0^{p_0}, \dots, d^{p_d}$.

2.1.2. *Schubert cycles.* Schubert cycles are not as central as in [KZJ17], but we still need the following definitions. Schubert cells $X_{\sigma}^{\circ} := P_- \backslash P_- \sigma B_+$ are B_+ -orbits of fixed points $\sigma \in W_p \backslash W$. Their closures are Schubert varieties X^{σ} . The codimension of X^{σ} is given by the number of inversions in the string corresponding to σ .

2.1.3. *K-theory.* In what follows, we shall consider the equivariant K-theory ring $K_{\hat{\Gamma}}(T^*(P_- \backslash G))$. It can be described explicitly as follows. Define the restriction map

$$\begin{aligned} |_{\sigma} : \mathbb{Z}[x_1^{\pm}, \dots, x_n^{\pm}, z_1^{\pm}, \dots, z_n^{\pm}, t^{\pm}]^{W_p} &\rightarrow K_{\hat{\Gamma}}(\text{pt}) \cong \mathbb{Z}[z_1^{\pm}, \dots, z_n^{\pm}, t^{\pm}] \\ f &\mapsto f|_{\sigma} := f(z_{\sigma^{-1}(1)}, \dots, z_{\sigma^{-1}(n)}, z_1, \dots, z_n, t) \end{aligned}$$

where the W_p permutes the x Laurent variables, and σ runs over $W_p \backslash W$. The z_1, \dots, z_n, t are the equivariant parameters associated to $\hat{T} = T \times \mathbb{C}^{\times}$.²

To present $K_{\hat{\Gamma}}(T^*(P_- \backslash GL_n)) \cong K_{\hat{\Gamma}}(P_- \backslash GL_n)$, we use $GL_n \hookrightarrow \text{Mat}_n$ and consider the maps

$$\mathbb{Z}[x_1^{\pm}, \dots, x_n^{\pm}, z_1^{\pm}, \dots, z_n^{\pm}, t^{\pm}]^{W_p} \cong K_{P_- \times \hat{\Gamma}}(\text{Mat}_n) \twoheadrightarrow K_{P_- \times \hat{\Gamma}}(GL_n) \cong K_{\hat{\Gamma}}(P_- \backslash GL_n) \hookrightarrow \bigoplus_{W_p \backslash W} K_{\hat{\Gamma}}(\text{pt})$$

The second map is surjective because (as in [KM05, verse]) each Schubert class in the target can be lifted to the class of a matrix Schubert variety, and the final map is injective because its kernel is torsion [Seg68, proposition 2.1], but $K_{\hat{\Gamma}}(P_- \backslash GL_n)$ is a free $K_{\hat{\Gamma}}$ -module (on the Schubert basis).

Consequently

$$K_{\hat{\Gamma}}(T^*(P_- \backslash G)) \cong \mathbb{Z}[x_1^{\pm}, \dots, x_n^{\pm}, z_1^{\pm}, \dots, z_n^{\pm}, t^{\pm}]^{W_p} \Big/ \bigcap_{\sigma \in W_p \backslash W} \ker(|_{\sigma})$$

where the x_i are the Chern roots of the duals of the tautological bundles. Thus to describe a class, it suffices to give a Laurent polynomial and check its symmetry in the x s.

2.2. **Localization.** In this paper we need to extend the base ring $K_{\hat{\Gamma}}(\text{pt})$.

A first (minor) modification is that we need a square root of t , that is a variable q such that $t = q^{-2}$. It can be formally defined by introducing a double cover of the circle scaling the fiber; *in the rest of this paper, this is implicitly done*. Note that there is an arbitrariness in the sign of q which will reappear in §5.

More importantly, most of the time, we shall require localization. When we deal with cotangent bundles of flag varieties, as in the current section, localization corresponds, in the parametrization of §2.1.3, to inverting $1 - q^2 z_i / z_j$ for any i, j . Note that $1 - w$ is invertible, where w runs over weights at fixed points in the normal directions to the base $P_- \backslash G$, which is all that matters for now. (When we work with more general quiver varieties in §3 and §7–8, we shall extend slightly the localization, in a way that is compatible with the one presented here).

Finally, to conform to the representation-theory literature, and for simplicity of notation, we tensor with $\mathbb{C}(q)$ (or one could use $\mathbb{Q}(q)$, as in [CP94, §9]). In fact, some of the localisation above can be dispensed with, and in §5 (and only there), we will reconsider it.

We denote the resulting base ring $K_{\hat{\Gamma}}^{\text{loc}}(\text{pt})$, and $K_{\hat{\Gamma}}^{\text{loc}}(X) := K_{\hat{\Gamma}}(X) \otimes_{K_{\hat{\Gamma}}(\text{pt})} K_{\hat{\Gamma}}^{\text{loc}}(\text{pt})$.

2.3. **The single-number R-matrix.** We temporarily set aside the geometry, and introduce R-matrices. Consider the vector space $V^{\lambda} = \mathbb{C}^{d+1} = \langle e_0, \dots, e_d \rangle$, as well as the evaluation representation $V^{\lambda}(z)$ of $\mathcal{U}_q(\mathfrak{a}_d[z^{\pm}])$, where the evaluation parameter z is also called the spectral parameter, see Appendix A.3. A word of caution is needed on the somewhat misleading notation $V^{\lambda}(z)$: we consider q and z as formal parameters, so that as a vector

²The T -action is right multiplication $x \mapsto x \text{diag}(z_1, \dots, z_n)^{-1}$; this is the opposite choice that is made in [KZJ17].

space it is $V^\Lambda \otimes \mathbb{C}(q)[z^\pm]$. We take tensor products of such representations over $\mathbb{C}(q)$, hence the asymmetric notation in q and z . Furthermore, we localize as in §2.2, i.e., in the tensor product $V^\Lambda(z_1) \otimes \cdots \otimes V^\Lambda(z_n)$, we allow ourselves to invert $1 - q^2 z_i/z_j$, where z_i and z_j are any two spectral parameters.

We use the same diagrammatic language as in [KZJ17, §3], and briefly recall it here. Our diagrams consists of graphs embedded in the plane, whose edges are labeled. In this section the set of labels is $\{0, 1, \dots, d\}$. The convention is that the labels of external edges are fixed, but those of internal ones are summed over. To each edge are also attached some fixed data: a spectral parameter and an orientation (the “direction of time”). This way, an edge labeled i with a spectral parameter z corresponds to the standard basis element $e_i \in V^\Lambda(z)$. Juxtaposition of edges corresponds to taking a tensor product, where the ordering is left to right if they are oriented downwards.

The R-matrix is represented by the 4-valent vertex

$$\check{R}_{ij}^{kl}(z', z'') = \begin{array}{c} k \quad l \\ \swarrow \quad \searrow \\ z' \quad z'' \\ \downarrow \quad \downarrow \\ i \quad j \end{array}$$

Its entries depend on the ratio z''/z' of parameters attached to the two lines crossing, and have the following explicit expression: (see [Jim86] and references therein)

$$(1) \quad \check{R}_{ij}^{kl}(z', z'') = \check{R}_{ij}^{kl}(z''/z') = \frac{1}{1 - q^2 z''/z'} \begin{cases} 1 - q^2 z''/z' & i = j = k = l \\ q(1 - z''/z') & i = l \neq j = k \\ 1 - q^2 & i = k < j = l \\ (1 - q^2)z''/z' & i = k > j = l \\ 0 & \text{otherwise} \end{cases}$$

As an operator from $V^\Lambda(z') \otimes V^\Lambda(z'')$ to $V^\Lambda(z'') \otimes V^\Lambda(z')$, $\check{R}(z''/z')$ is an $\mathcal{U}_q(\mathfrak{a}_d[z^\pm])$ -intertwiner. This, combined with the normalization $\check{R}_{ii}^{ii} = 1$, implies the following well-known properties:

Proposition 2.1. • *Yang–Baxter equation:*

$$(2) \quad \begin{array}{c} \swarrow \quad \searrow \\ \downarrow \quad \downarrow \\ \swarrow \quad \searrow \end{array} = \begin{array}{c} \swarrow \quad \searrow \\ \downarrow \quad \downarrow \\ \swarrow \quad \searrow \end{array}$$

• *Unitarity equation:*

$$(3) \quad \begin{array}{c} \swarrow \quad \searrow \\ \downarrow \quad \downarrow \\ \swarrow \quad \searrow \end{array} = \begin{array}{c} \downarrow \\ \downarrow \end{array}$$

- Value at equal spectral parameters:

$$(4) \quad \begin{array}{c} \diagup \quad \diagdown \\ \diagdown \quad \diagup \\ z \quad z \end{array} = \begin{array}{c} \diagdown \quad \diagup \\ \diagup \quad \diagdown \\ z \quad z \end{array}$$

2.4. Motivic Segre classes. One of the standard ways to get a hold of equivariant Schubert classes on type A flag manifolds is with *double Schubert polynomials*, which were interpreted in [KM05] as arising from

$$\begin{array}{c} H_T^*(B_- \backslash GL_n) \cong H_{B_- \times T}^*(B_- \backslash GL_n) \leftarrow H_{B_- \times T}^*(M_n(\mathbb{C})) \cong \mathbb{Z}[x_1, \dots, x_n, y_1, \dots, y_n] \\ \downarrow \qquad \qquad \qquad \downarrow \qquad \qquad \qquad \downarrow \\ [B_- \backslash \overline{B_- w B_+}] \leftarrow [\overline{B_- w B_+} \subseteq GL_n] \leftarrow [\overline{B_- w B_+} \subseteq M_n(\mathbb{C})] \end{array}$$

Meanwhile, under the identification $M_n(\mathbb{C}) \cong B_-^{2n} \backslash (B_-^{2n}(1 \ n + 1)(2 \ n + 2) \cdots (n \ 2n) B_+^{2n})$ (essentially the A_2 case of [Zel85]) we can realize $[\overline{B_- w B_+} \subseteq M_n(\mathbb{C})]$ as the restriction of the equivariant Schubert class $S_{w \oplus Id_n}$ (on the flag manifold in \mathbb{C}^{2n}) to the point $(1 \ n + 1)(2 \ n + 2) \cdots (n \ 2n)$. We now pursue a parallel story to obtain the classes S^λ , where the permutation $(1 \ n + 1)(2 \ n + 2) \cdots (n \ 2n)$ will make an appearance as its square wiring diagram.

Given a single-number string λ of length n , we define

$$(5) \quad S^\lambda := \omega \left\{ \begin{array}{c} \overbrace{\quad \quad \quad \quad}^\lambda \\ \begin{array}{cccc} \downarrow & \downarrow & \downarrow & \downarrow \\ x_1 & & & \\ \hline & & & \leftarrow d \\ x_2 & & & \\ \hline & & & \leftarrow d \\ \vdots & & & \\ \hline & & & \leftarrow d \\ x_n & & & \\ \hline & & & \leftarrow d \\ z_1 & z_2 & \cdots & z_n \\ \hline d & d & d & d \end{array} \end{array} \right.$$

where we recall that the string ω is the unique weakly increasing string with the same content as λ . Strings are always read left to right and top to bottom (which is consistent with the ordering of tensor products).

Remark. This definition is related to the notion of *weight function* [RTV15], or in the language of quantum integrable systems, of *off-shell Bethe vector*. Note however that we are really only interested in the *on-shell* Bethe vector, as will be explained right below: that is, only in the the class S^λ modulo the relations of $K_\uparrow^{loc}(T^*(P_- \backslash G))$ (the Bethe equations for infinite twist). See also [AO17] for an extensive discussion of off-shell Bethe vectors in a geometric context. At the moment, we do not know how to extend to $T^*(P_- \backslash G)$ the more complicated method of [ZJ09, WZJ19] in order to expand products of off-shell Bethe vectors.

Lemma 2.4. S^λ is well-defined at every specialization $x_i = z_{\bar{\sigma}(i)}$, $\sigma \in W$, and given by

$$(6) \quad S^\lambda|_\sigma = \begin{array}{c} \overbrace{\quad \quad \quad}^\lambda \\ \downarrow z_1 \quad \downarrow z_2 \quad \downarrow \dots \quad \downarrow z_n \\ \boxed{\sigma} \\ \downarrow z_{\bar{\sigma}(1)} \quad \downarrow z_{\bar{\sigma}(2)} \quad \downarrow \dots \quad \downarrow z_{\bar{\sigma}(n)} \\ \underbrace{\quad \quad \quad}_\omega \end{array}$$

where the rectangle labeled σ is any wiring diagram of σ , each crossing being an R-matrix. Furthermore, $S^\lambda|_\sigma$ only depends on the class of σ in $W_P \setminus W$.

Note that time flows downwards, e.g., if $\sigma = (312)$, then the diagram of σ is 

Proof. (6) follows from proposition 2.1 – the proof is identical to that of [KZJ17, lemma 3.12], and we shall not repeat it here.

Because ω is invariant under W_P , and $\check{R}_{ii} = 1$ according to (1), the value of (6) is unaffected by left multiplication of σ by an element of W_P . This shows that $S^\lambda|_\sigma$ depends only on the class of σ in $W_P \setminus W$. \square

Example 2.5. We compute $S^\lambda|_\sigma$ for $\lambda = 01, 10$ and $\sigma \in \mathcal{S}_2$, where we identify the identity permutation with 01 and the nontrivial permutation with 10 :

$$\begin{array}{ll} S^{01}|_{01} = \begin{array}{c} \begin{array}{cc} \downarrow z_1 & \downarrow z_2 \\ \begin{array}{|c|c|} \hline 0 & 1 \\ \hline 0 & 1 \\ \hline \end{array} \\ \downarrow & \downarrow \end{array} = 1 & S^{10}|_{01} = \begin{array}{c} \begin{array}{cc} \downarrow z_1 & \downarrow z_2 \\ \begin{array}{|c|c|} \hline 1 & 0 \\ \hline 0 & 1 \\ \hline \end{array} \\ \downarrow & \downarrow \end{array} = 0 \\ \\ S^{01}|_{10} = \begin{array}{c} \begin{array}{cc} \downarrow z_1 & \downarrow z_2 \\ \begin{array}{|c|c|} \hline 0 & 1 \\ \hline 0 & 1 \\ \hline \end{array} \\ \downarrow & \downarrow \end{array} = \frac{1 - q^2}{1 - q^2 z_2 / z_1} & S^{10}|_{10} = \begin{array}{c} \begin{array}{cc} \downarrow z_1 & \downarrow z_2 \\ \begin{array}{|c|c|} \hline 1 & 0 \\ \hline 0 & 1 \\ \hline \end{array} \\ \downarrow & \downarrow \end{array} = \frac{q(1 - z_2 / z_1)}{1 - q^2 z_2 / z_1} \end{array}$$

Compare with example 2.2.

By abuse of notation, we suppress the dependence on the choice of word of σ in the diagram, the justification being that the resulting quantity is independent of the choice of word.

Lemma 2.4 implies that we can consider $S^\lambda|_\sigma$ (a rational function in z_1, \dots, z_n, q with only poles at $z_i / z_j = q^2$) as the restriction of a class in $K_{\dagger}^{\text{loc}}(T^*(P_- \setminus G))$ to a fixed point $\sigma \in W_P \setminus W$; we identify S^λ with this class, and call it the *motivic Segre class* labeled by λ .

We define dual classes by reversing all arrows (and conventionally rotating diagrams by 180 degrees); more precisely, define

$$(7) \quad S_\lambda := \begin{array}{cccc} & d & d & d & d \\ & \downarrow & \downarrow & \downarrow & \downarrow \\ d & \xrightarrow{x_n} & & & \leftarrow \\ & \vdots & & & \leftarrow \\ d & \xrightarrow{x_2} & & & \leftarrow \\ & \vdots & & & \leftarrow \\ d & \xrightarrow{x_1} & & & \leftarrow \\ & \downarrow & \downarrow & \cdots & \downarrow \\ & z_1 & z_2 & \cdots & z_n \end{array} \left. \vphantom{\begin{array}{c} d \\ d \\ d \\ d \end{array}} \right\} \alpha$$

$\underbrace{\hspace{10em}}_\lambda$

where we recall that the string α is the unique weakly decreasing string with the same content as λ . The fixed point restriction formula reads, using the shorthand notation $\hat{\sigma} = \sigma^{-1}w_0$, where w_0 is the longest permutation:

$$(8) \quad S_\lambda|_\sigma = \begin{array}{cccc} & \alpha & & \\ & \downarrow & \downarrow & \downarrow & \downarrow \\ & z_{\hat{\sigma}(1)} & z_{\hat{\sigma}(2)} & \cdots & z_{\hat{\sigma}(n)} \\ \boxed{\hat{\sigma}} & & & & \\ & \downarrow & \downarrow & \downarrow & \downarrow \\ & z_1 & z_2 & \cdots & z_n \end{array}$$

$\underbrace{\hspace{10em}}_\lambda$

Note that reversing arrows in the R-matrix is equivalent to $q, z', z'' \mapsto q^{-1}, z'^{-1}, z''^{-1}$, according to (1); so that there is a simple relationship between S^λ and S_λ :

Lemma 2.6. *One has*

$$S_\lambda(x_1, \dots, x_n, z_1, \dots, z_n, q) = S^{\lambda^*}(x_1^{-1}, \dots, x_n^{-1}, z_n^{-1}, \dots, z_1^{-1}, q^{-1})$$

where λ^* denotes the string λ read backwards. Similarly,

$$S_\lambda|_\sigma(z_1, \dots, z_n, q) = S^{\lambda^*}|_{\sigma w_0}(z_n^{-1}, \dots, z_1^{-1}, q^{-1})$$

2.5. Relation to stable classes. We start with the following characterization of motivic Segre classes of $P_- \setminus G$. Denote by τ_i the elementary transposition $(i, i + 1)$, and make it act on $K_{\dagger}^{\text{loc}}(\text{pt})$ by permuting variables z_i and z_{i+1} .

Proposition 2.7. *The classes S^λ are entirely determined by the following properties:*

- (1) **Triangularity:** $S^\lambda|_\sigma = 0$ unless $\sigma \leq \lambda$ in the Bruhat order.
- (2) **Diagonal entries:**

$$S^\lambda|_\lambda = \prod_{i < j: \lambda_i > \lambda_j} \frac{q(1 - z_j/z_i)}{1 - q^2 z_j/z_i}$$

(3) Exchange relation:

$$\tau_i S^\lambda|_{\sigma\tau_i} = \begin{cases} \frac{1-q^2}{1-q^2 z_i/z_{i+1}} S^\lambda|_\sigma + \frac{q(1-z_i/z_{i+1})}{1-q^2 z_i/z_{i+1}} S^{\lambda\tau_i}|_\sigma & \lambda_i < \lambda_{i+1} \\ S^\lambda|_\sigma & \lambda_i = \lambda_{i+1} \\ \frac{(1-q^2)z_i/z_{i+1}}{1-q^2 z_i/z_{i+1}} S^\lambda|_\sigma + \frac{q(1-z_i/z_{i+1})}{1-q^2 z_i/z_{i+1}} S^{\lambda\tau_i}|_\sigma & \lambda_i > \lambda_{i+1} \end{cases}$$

In fact, property (3) allows to define inductively the S^λ in terms of a single one, say S^α , and then we only need (1) and (2) at $\lambda = \alpha$.

Proof. For the first two points, pick a minimal representative σ of λ in $W_P \setminus W$, i.e., a permutation of minimal length that permutes the labels of ω to those of σ , and apply lemma 2.4, i.e., consider a reduced decomposition Q for σ .

- (1) According to (1), the summation over intermediate labels in the expression (6) of $S^\lambda|_\sigma$ is a summation over subwords P of Q , and therefore results in strings $\prod P \cdot \omega$ that are less or equal to λ in the Bruhat order.
- (2) In the equality case $\sigma = \lambda$, the only configuration that contributes to (6) is made of

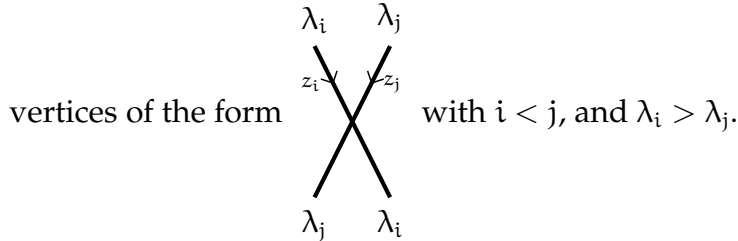

- (3) Finally, the induction formula is derived as follows: given a fixed point σ and an elementary transposition τ_i , diagrammatically,

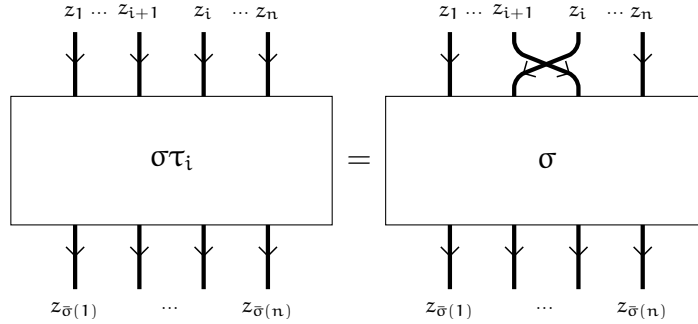

Applying once again lemma 2.4 and performing the sum over the labels of the edges right under the final $(i, i + 1)$ crossing leads to the desired result. □

One similarly proves the corresponding properties for the dual classes:

Proposition 2.8. *The classes S_λ are entirely determined by the following properties:*

- (1) Triangularity: $S_\lambda|_\sigma = 0$ unless $\sigma \geq \lambda$ in the Bruhat order.
- (2) Diagonal entries:

$$S_{\lambda|\lambda} = \prod_{i < j: \lambda_i < \lambda_j} \frac{q(1 - z_i/z_j)}{1 - q^2 z_i/z_j}$$

(3) Exchange relation:

$$\tau_i S_\lambda|_{\sigma\tau_i} = \begin{cases} \frac{1-q^2}{1-q^2 z_{i+1}/z_i} S_\lambda|_\sigma + \frac{q(1-z_{i+1}/z_i)}{1-q^2 z_{i+1}/z_i} S_{\lambda\tau_i}|_\sigma & \lambda_i < \lambda_{i+1} \\ S_\lambda|_\sigma & \lambda_i = \lambda_{i+1} \\ \frac{(1-q^2)z_{i+1}/z_i}{1-q^2 z_{i+1}/z_i} S_\lambda|_\sigma + \frac{q(1-z_{i+1}/z_i)}{1-q^2 z_{i+1}/z_i} S_{\lambda\tau_i}|_\sigma & \lambda_i > \lambda_{i+1} \end{cases}$$

In both cases, one notes that these properties are very similar to the ones satisfied by the stable basis [Oko15]. This motivates the definition

$$\text{St}^\lambda := \kappa S^\lambda$$

where

$$\kappa = [P_- \setminus G] = \prod_{i,j:\omega_i < \omega_j} (1 - q^2 x_i/x_j)$$

is the class of the zero section of $T^*(P_- \setminus G) \rightarrow P_- \setminus G$. We shall see just below that St^λ lives in *non-localized* K-theory, i.e., belongs to $K_{\uparrow}(T^*(P_- \setminus G))$. Inversely,

$$S^\lambda = p^* p_* \text{St}^\lambda$$

and the denominator of S^λ can be blamed on the lack of properness of the map p . Similarly, introduce $\text{St}_\lambda := \tilde{\kappa} S_\lambda$, where

$$\tilde{\kappa} = \prod_{i,j:\omega_i < \omega_j} q(1 - q^{-2} x_j/x_i)$$

differs from κ by a monomial (related to choosing an opposite polarization). We can then state:

Proposition 2.9. *St^λ (resp. St_λ) coincides with the stable basis element associated to λ , to the negative (resp. positive) chamber, to the polarization $T^*(P_- \setminus G)$ (resp. $T(P_- \setminus G)$), and to a line bundle in the positive (resp. negative) alcove closest to 0.*

(This is $\text{Stab}_-(\lambda)$ (resp. $\text{Stab}_+(\lambda)$) in the notations of [SZZ20].)

As a corollary, $\text{St}^\lambda, \text{St}_\lambda \in K_{\uparrow}(T^*(P_- \setminus G))$.

Proof. We provide the proof for St^λ . St^λ is uniquely determined by properties strictly analogous to proposition 2.7, the only difference being the normalization of the diagonal entries; using

$$[P_- \setminus G]_\lambda = \prod_{i,j:\lambda_i < \lambda_j} (1 - q^2 z_i/z_j)$$

leads to

$$(9) \quad \text{St}^\lambda|_\lambda = \prod_{i < j, \lambda_i < \lambda_j} (1 - q^2 z_i/z_j) \prod_{i > j, \lambda_i < \lambda_j} q(1 - z_i/z_j)$$

We now claim that the same properties are satisfied by the corresponding stable basis elements. Property (1) is a direct consequence of the definition of the stable envelope, and more precisely of the support condition [Oko15, 9.1.3 (1)].

Similarly, (9), which is a version of (2), is a consequence of the normalization condition on the diagonal [Oko15, 9.1.3 (1)], paying attention to the choice of polarization, which introduces the extra factor of $-q$ in the second product, cf [Oko15, 9.1.5].

So we only need to prove that stable classes satisfy the same exchange relation (3). But this is actually the definition of the R-matrix according to [Oko15, 9.2.11]. Indeed, the substitution $S^\lambda|_\sigma \mapsto \tau_i S^\lambda|_{\tau_i \sigma}$ is equivalent to moving from the negative chamber to a

neighboring one across the wall $z_i = z_{i+1}$. So the only check left is that our R-matrix (1) coincides with the one as defined geometrically. The beauty of this construction of the R-matrix is that it needs to be done at $n = 2$ only; this is the object of [Oko15, Exercise 9.2.25], and we shall not repeat it here (see also [SZZ20, Example 1.4]).

The reasoning for St_λ is much the same; we only provide the normalization condition:

$$St_\lambda|_\lambda = \prod_{i < j, \lambda_i < \lambda_j} (1 - z_j/z_i) \prod_{i > j, \lambda_i < \lambda_j} q(1 - q^{-2}z_j/z_i)$$

□

Remark. The exchange formula above should not be confused with the (torus-equivariant) transition formula of [SZZ20, Proposition 3.6]; the latter only makes sense for full flags, i.e., $T^*(G/B)$.

In particular we have the duality statement (cf. [SZZ20, Remark 1.3 (2)])

$$(10) \quad \langle St^\lambda St_\mu \rangle = \delta_\mu^\lambda$$

where $\langle \dots \rangle$ denotes pushforward to a point in (localized) equivariant K-theory. Such pushforwards are slightly subtle because the map $T^*(P_- \setminus G) \rightarrow \text{pt}$ is not proper; however, the localization formula gives a natural definition of pushforward whenever the map on *fixed points* is proper, with the only price being the denominators incurred in that formula.

Remark. If i is the zero section of $T^*(P_- \setminus G) \rightarrow P_- \setminus G$, then $i^* St^\lambda$ is the motivic Chern class of [FRW21].

3. THE PUZZLE RULE

In this section we several times make use of

- a finite-type Dynkin diagram, to which we associate a quantized loop algebra $\mathcal{U}_q(\mathfrak{g}[z^\pm])$,
- a dominant weight, to which we associate a particular representation (or more precisely, a parametrized family of representations), and
- a weight of that representation.

Although we defer discussion of Nakajima quiver varieties (whose K_T -groups will be those corresponding weight spaces) to §7, we will recall here the way these varieties are indexed, in order to similarly index our weight spaces.

The **Nakajima diagram** associated to a Dynkin diagram I attaches a univalent **framed vertex** hanging off each vertex of I , those called the **gauged vertices**. For example, the

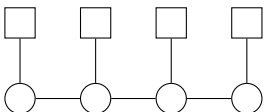
A_4 Nakajima diagram looks like . When we populate the diagram

with natural numbers, the framed vertices $(\overline{w^i})$ indicate a dominant linear combination $\sum w^i \vec{\omega}_i$ of the fundamental weights $\vec{\omega}_i$ of \mathfrak{g} , whereas the gauged vertices $(\underline{v^i})$ indicate a linear combination of the simple roots $\vec{\alpha}_i$, to be subtracted from that dominant weight, leaving the **weight** $\sum w^i \vec{\omega}_i - \sum_i v^i \vec{\alpha}_i$ of the labeled quiver. (Note that every weight of the \mathfrak{g} -irrep $V_{\sum w^i \vec{\omega}_i}$ is of this latter form.) These tuples $(\overline{w^i})$, $(\underline{v^i})$ are called the framed and gauged **dimension vectors**. When some w_i is 0 we generally don't bother to draw that framed vertex.

A basic example occurs when (1) the support of the gauged dimension vector $(\underline{v^i})$ lies on a type A_d subdiagram, and (2) the framed dimension vector is supported at one vertex,

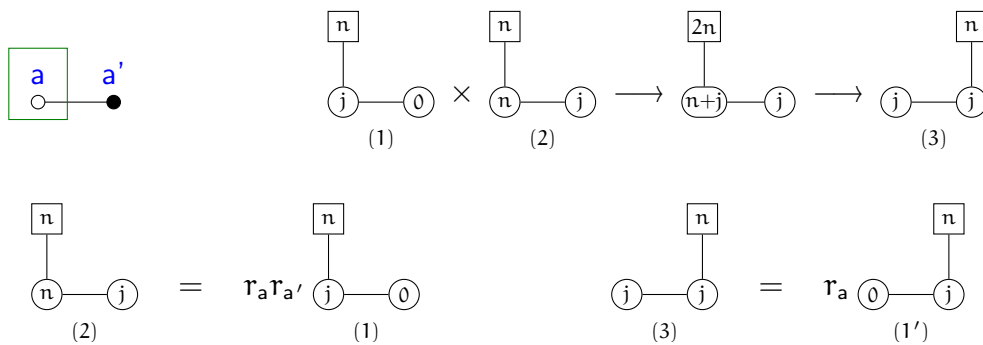

FIGURE 1. The $d = 1$ Dynkin diagram, fusion, and π_s needed in proposition 7.2.

at one end of the type A_d subdiagram. For reasons to be explained in §7 we call this a **(d-step) flag type** case.

To each $(\overline{w^i})$ is associated a representation of $\mathcal{U}_q(\mathfrak{g}[z^\pm])$, as will be discussed in more detail in §3.1. Properly speaking, this is not a finite-dimensional complex vector space but rather a finite rank module over a subring of $\mathbb{C}(z_{i,j}, j = 1, \dots, w^i)$. For now we say that for general values of the parameters $(z_{i,j})$ this representation is isomorphic to a tensor product $\otimes_i \otimes_{j=1}^{w^i} V_{\bar{\omega}_i}(z_{i,j})$ (which, for those general values, is irreducible).

The set of weights in each of our representations is W_G -invariant. We can see the action of a simple reflection $r_i \in W_G$ on a pair $(\overline{w^i}), (\underline{v^i})$ of dimension vectors thusly: **replace a gauged label $(\underline{v^i})$ by the sum of its neighboring labels (including the $\overline{w^i}$ on neighboring framed vertex), minus the original $(\underline{v^i})$.**

With all this we can introduce the labeled Nakajima quivers we need in this paper, four for each of $d = 1, 2, 3, 4$. In figures 1 – 4 we give a Dynkin diagram of rank $2d$, and four labelings of the Nakajima diagram. In each case,

- the sum of the first two weights equals the third weight, and also the fourth;
- the first of the four labelings is of d -step flag type; and
- the second and the fourth weights can be reflected (by iterating the bolded recipe in the paragraph above) to be of d -step flag type. In the figure we indicate sequences of reflections to use to see this. The third weight usually cannot be reflected to flag type (only for $d = 1$ is this possible).

Furthermore, the weight of the second quiver is τ^2 times that of the first, where τ is a nontrivial order 3 automorphism of the weight space that was defined in [KZJ17, §2];³ so the third = fourth weight is $-\tau$ times the first weight.

For the purposes of this section, the arrows in figures 1 – 4 refer to the maps on weight spaces induced from some corresponding $\mathcal{U}_q(\mathfrak{g}[z^\pm])$ -module homomorphisms. The second arrow will be called the “fusion” arrow, following the notion from the representation theory of quantized affine algebras.

3.1. The representation theory. Let \mathfrak{r}_{2d} be one of the Lie algebras $\mathfrak{a}_2, \mathfrak{d}_4, \mathfrak{e}_6, \mathfrak{e}_8$ corresponding to the Dynkin diagrams X_{2d} introduced in figures 1-4, and $\mathcal{U}_q(\mathfrak{r}_{2d}[z^\pm])$ the corresponding *quantized loop algebra*; see Appendix A for details.

³The explicit form of τ is irrelevant for the present work; note that if $d \neq 2$, τ can be chosen of the form $\chi^{h_d/3}$ where χ is a certain Coxeter element and $h_d = 3, 12, 30$ for $d = 1, 3, 4$; e.g., at $d = 4$, $\chi = r_d r_{a'} r_a r_b r_c r_d r_c r_b r_a$ (compare with figure 4, noting that $-1 = w_0 = \chi^{h/2}$ implies $-\tau = \chi^{-5}$).

In each of figures 1–4, the first, second, and fourth quivers each have only one framed vertex. Denote by $V_a(z)$ the fundamental representation [CP94, p399] associated to that vertex, where $a = 1, 2, 3$ for the first, second, and fourth quiver (i.e., the one labeled (a)) respectively. All three representations $V_a(z)$ have dimension $3, 8, 27, 248 + 1$ for $d =$

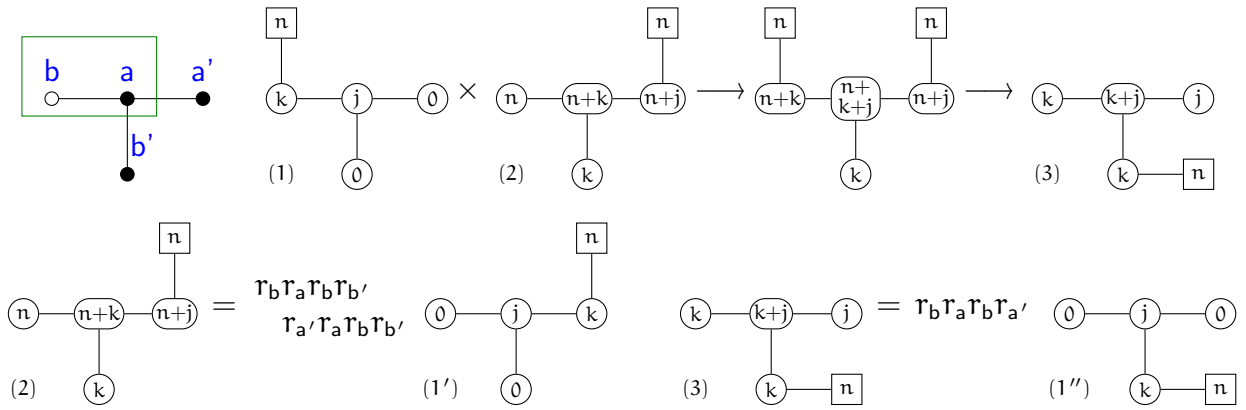

FIGURE 2. The $d = 2$ Dynkin diagram, fusion, and π_s needed in proposition 7.2.

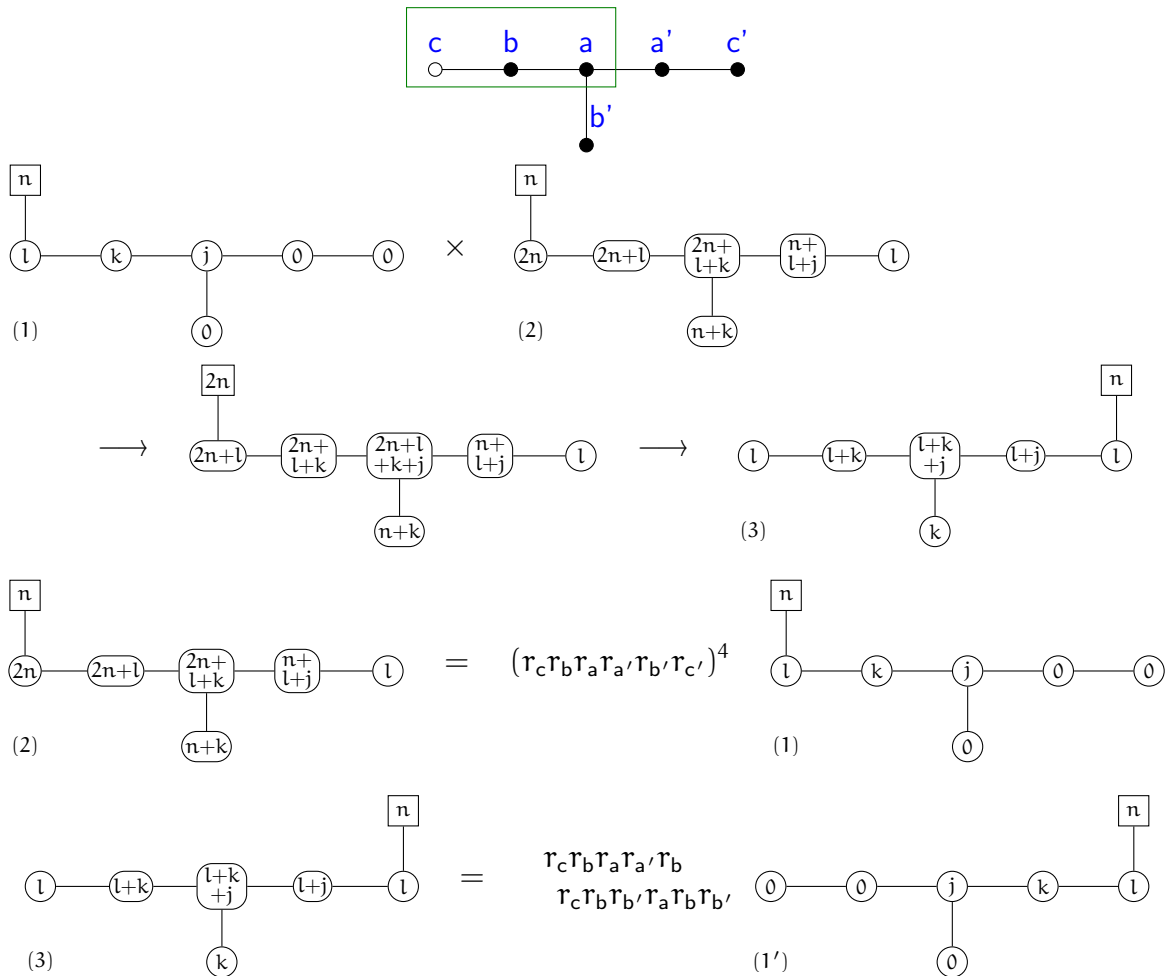

FIGURE 3. The $d = 3$ Dynkin diagram, fusion, and π_s needed in proposition 7.2.

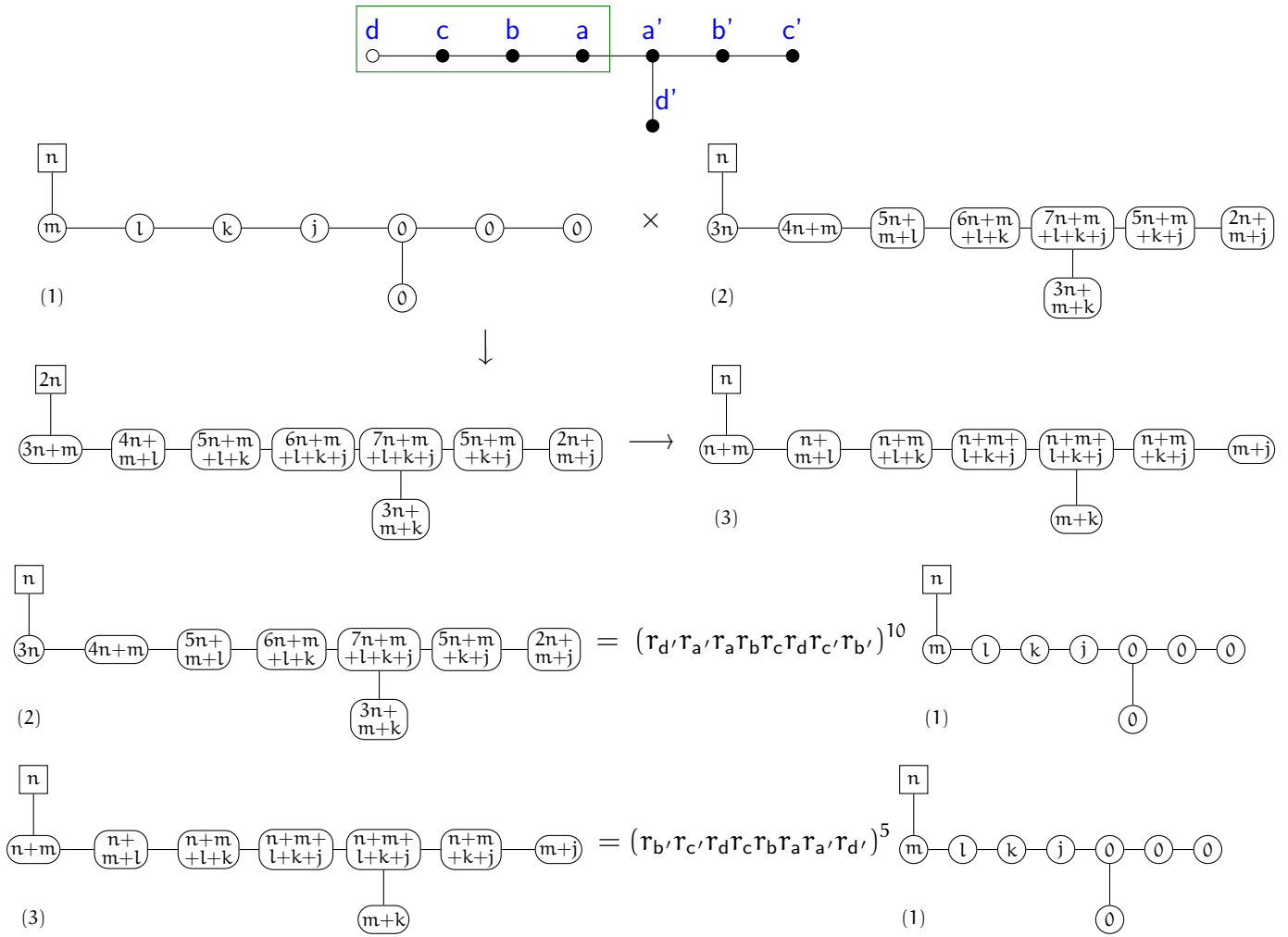

FIGURE 4. The $d = 4$ Dynkin diagram, fusion, and π_s needed in proposition 7.2.

1, 2, 3, 4 respectively – in the last case, the representation is *not* irreducible for the finite quantized algebra $\mathcal{U}_q(\mathfrak{e}_8)$, but is rather a direct sum of the fundamental representation associated to the same vertex (q -deformation of the adjoint representation of \mathfrak{e}_8) and of the trivial representation.

Each $V_a(z)$ possesses a natural weight space decomposition; furthermore, every weight space except the zero weight space at $d = 4$ is one-dimensional. We denote the set of weights of $V_1(z)$ by \mathcal{W} ; the set of weights of $V_2(z)$ (resp. $V_3(z)$) is then given by $\tau^2\mathcal{W}$ (resp. $-\tau\mathcal{W}$).

We are particularly interested in the subspaces $V_a^\Lambda(z)$ of $V_a(z)$ defined by restricting to weight spaces given by figures 1–4 at $n = 1$; that is, w corresponds to a single fundamental representation as above, and v is constrained to be of the form given by quiver (1) of figures 1–4. We pick basis elements (weight vectors) in each weight space; the normalization is unimportant for now and will be fixed by the geometry in §7. We denote them $e_{a,i}$, $i = 0, \dots, d$, where $e_{a,d}$ is the highest weight vector and the weight of $e_{a,i}$ is obtained from the highest weight by subtracting $d - i$ simple roots.

Example 3.1. At $d = 3$, $a = 1$, there are four possible assignments v_a of dimensions, namely

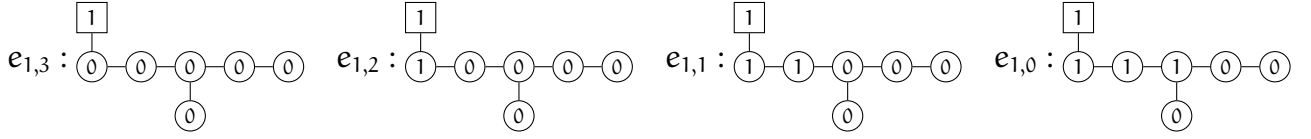

while at $d = 2$, $a = 2$, there are three possibilities:

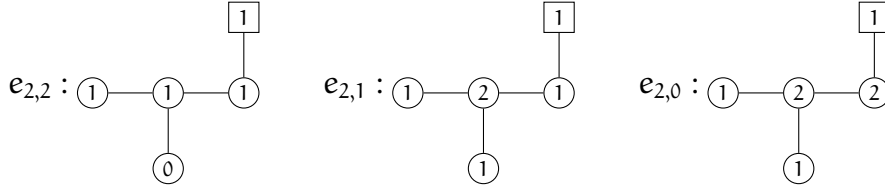

The weights of $e_{a,i}$ for $a = 1, 2, 3$ are denoted $\vec{f}_i, \tau^2 \vec{f}_i, -\tau \vec{f}_i$; the \vec{f}_i form a subset \mathcal{W}^A of \mathcal{W} . We can also define dual weight vectors $e_{a,i}^*$ with $\langle e_{a,i}^*, e_{a,j} \rangle = \delta_{ij}$, and opposite weights.

Note that at $d = 1, 3$, diagrams (1) and (2) correspond to (weight spaces of) the same representation of $\mathcal{U}_q(\mathfrak{r}_{2d}[z^\pm])$, whereas (3) corresponds to the dual representation – it is related by W action to a diagram (1') that is the mirror image of (1). At $d = 2$, diagrams (1), (2) and (3) correspond to nonisomorphic representations related by triality. Finally, at $d = 4$, the same representation is associated to diagrams (1), (2) and (3).

3.2. The R-matrices. In the previous section, we introduced fundamental representations $V_a(z)$, $a = 1, 2, 3$, of the quantized loop algebra $\mathcal{U}_q(\mathfrak{r}_{2d}[z^\pm])$. We now consider tensor products of such representations. As in §2, we tensor over $\mathbb{C}(q)$, and require localization. Extending that of §2, we invert $1 - q^{2k}z''/z'$ for any $k \in \mathbb{Z}$ and any spectral parameters z', z'' except in the following two cases: if z', z'' appear in $V_a(z')$ and $V_b(z'')$,

- (i) if $a = b$, we disallow $k = 0$;
- (ii) if $a = 1, b = 2$ we disallow $k = h_d/3$,

where h_d denotes the dual Coxeter number of \mathfrak{r}_{2d} .

For any $z''/z' \notin q^{2\mathbb{Z}}$, $V_a(z') \otimes V_b(z'')$ and $V_b(z'') \otimes V_a(z')$ are known to be irreducible and isomorphic (see [Cha02] and [HL10, §3.7]); let $\check{R}_{a,b}(z''/z')$, $a, b = 1, 2, 3$ be the unique $\mathcal{U}_q(\mathfrak{r}_{2d}[z^\pm])$ intertwiner from $V_a(z') \otimes V_b(z'')$ to $V_b(z'') \otimes V_a(z')$, with the normalization condition

$$(11) \quad \langle e_{b,0}^* \otimes e_{a,0}^*, \check{R}_{a,b}(z) e_{a,0} \otimes e_{b,0} \rangle =: \check{R}_{a,b}(z)_{00}^{00} = 1$$

making $\check{R}_{a,b}(z)$ a rational function of z . We will justify in what follows the slightly stronger statement that $\check{R}_{a,b}(z''/z')$ is well-defined in the localization above, i.e., we will explain the exceptions (i) and (ii).

In [MO19, Oko15] Maulik and Okounkov define R-matrices *geometrically* using the stable envelope construction, recalled here in §8. As we shall see, our normalization (11) of the R-matrices coincides with the one defined geometrically only when $a = b$. For now, the choice of normalization for $a \neq b$ is ad hoc and allows for a simpler formulation of our main theorem. A proper explanation (at least in cohomology) will be given in §8.

As in §2, we represent R-matrices diagrammatically as crossings, except we now distinguish the various $V_a(z)$ by the color of the line – green, red, blue for $a = 1, 2, 3$.

For $\check{R}_{1,2}(z)$, we also use the “dual” graphical depiction which is traditional in Schubert puzzles, namely,

$$\check{R}_{1,2}(z) = \begin{array}{c} \diagup \\ \diagdown \end{array}$$

where the parameter z is implicitly determined by the location of the rhombus, as will be discussed below; and similarly, matrix elements in a given basis are denoted by putting labels on the edges of the rhombus.

The following lemma is key, in that it relates the \mathfrak{r}_{2d} R-matrix we use in puzzles to the \mathfrak{a}_d R-matrix we use to compute the motivic Segre classes on the (cotangent bundle to the) d -step flag manifold. The lemma is an R-matrix analogue of the familiar statement that for a circle $S \hookrightarrow G$, the two extremal S -weight spaces in a G -irrep are (predictable) irreps of the Levi subgroup $C_G(S)$. As such, this lemma should have a purely representation-theoretic proof,⁴ but we found it easier to exploit geometry, and defer the proof to §7.1 where we provide the slightly more precise lemma 7.3.

Lemma 3.2. *The matrices of the operators $\check{R}_{\alpha,\alpha}$, $\alpha = 1, 2, 3$, restricted to $V_\alpha^\Lambda(z_1) \otimes V_\alpha^\Lambda(z_2)$, in the basis $(e_{\alpha,i})_{i=0,\dots,d}$ (with a normalization to be explained in §7), are equal to the R-matrix from (1).*

The purpose of the following lemma is to justify exception (ii) of our localization, and to introduce the tensors U and D ; we don’t otherwise use the result directly.

Lemma 3.3. *At the value $z = q^{-2h_d/3}$ (where $h_d = 3, 6, 12, 30$ for $d = 1, 2, 3, 4$), the matrix $\check{R}_{1,2}$ is well-defined (i.e., has no pole) and factors as*

$$\check{R}_{1,2}(q^{-2h_d/3}) = DU$$

where $U : V_1(q^{h_d/3}z) \otimes V_2(q^{-h_d/3}z) \rightarrow V_3(z)$ and $D : V_3(z) \rightarrow V_2(q^{-h_d/3}z) \otimes V_1(q^{h_d/3}z)$ are $\mathcal{U}_q(\mathfrak{r}_{2d}[z^\pm])$ intertwiners (unique up to scaling one while un-scaling the other).

Proof. The $d = 2$, $d = 3$ R-matrices were provided in [KZJ17, §3.6] and [KZJ17, §3.8] respectively, where the factorization was already pointed out. The $d = 1$ case is given in appendix B, and its factorization is discussed in §4 below. Finally, the $d = 4$ case requires the explicit form of the trigonometric \mathfrak{e}_8 R-matrix in its 249-dimensional representation, which to the authors’ knowledge has not appeared in the literature before. It is provided in a companion paper [ZJ20], where the factorization is proven. \square

Note that the geometric meaning of setting the ratio of spectral parameters equal to $q^{-2h_d/3}$ is not obvious, and in fact it is only our unusual normalization of the R-matrix (as mentioned above) which guarantees that $\check{R}_{1,2}(z)$ is well-defined at this value of z .

The graphical notation and its dual are

$$(12) \quad \check{R}_{1,2}(q^{-2h_d/3}) = \begin{array}{c} \diagup \\ \diagdown \end{array} = \begin{array}{c} \diagup \\ \diagdown \end{array} = \begin{array}{c} \diagup \\ \diagdown \end{array}$$

⁴A sketch of proof is that inclusions of Dynkin diagrams $A_d \subset X_{2d}$ induce inclusions of loop algebras $\mathcal{U}_q(\mathfrak{a}_d[z^\pm]) \subset \mathcal{U}_q(\mathfrak{r}_{2d}[z^\pm])$ by the Drinfeld current presentation; this immediately implies the property at $\alpha = 1$, where the $e_{1,i}$ are the standard basis of the $(d + 1)$ -dimensional representation of $\mathcal{U}_q(\mathfrak{a}_d)$, and $\check{R}_{1,1}$ is uniquely fixed up to normalization by $\mathcal{U}_q(\mathfrak{a}_d[z^\pm])$ -invariance. For $\alpha = 2, 3$, one uses the braid group action [Bec94] on $\mathcal{U}_q(\mathfrak{r}_{2d}[z^\pm])$ with any lift of τ to reduce to the case $\alpha = 1$.

where the Δ corresponds to U , and the ∇ to D . Because of the normalization condition (11), we can fix the scaling of U and D to have

$$(13) \quad \langle e_{3,0}^*, Ue_{1,0} \otimes e_{2,0} \rangle = \langle e_{2,0}^* \otimes e_{1,0}^*, De_{3,0} \rangle = 1$$

These R-matrices collectively satisfy the following identities (cf. [KZJ17, property 2]):

Proposition 3.4. *In the pictures below, black lines can have arbitrary (independent) colors, and all lines can have arbitrary spectral parameters (as long as they match between l.h.s. and r.h.s.).*

- *Weight conservation: matrix entries (in a basis of weight vectors) of all $\check{R}_{i,j}$, U , D are nonzero only if the sum of incoming weights is equal to the sum of outgoing weights.*
- *Yang–Baxter equation:*

$$(14) \quad \begin{array}{c} \diagup \quad \diagdown \\ \diagdown \quad \diagup \end{array} = \begin{array}{c} \diagdown \quad \diagup \\ \diagup \quad \diagdown \end{array}$$

- *Bootstrap equations:*

$$(15) \quad \begin{array}{c} \text{green} \quad \text{red} \\ \diagdown \quad \diagup \\ \text{blue} \\ \diagup \quad \diagdown \end{array} = \begin{array}{c} \text{green} \quad \text{red} \\ \diagdown \quad \diagup \\ \text{black} \\ \diagup \quad \diagdown \end{array} \quad \begin{array}{c} \text{green} \quad \text{red} \\ \diagdown \quad \diagup \\ \text{black} \\ \diagup \quad \diagdown \end{array} = \begin{array}{c} \text{green} \quad \text{red} \\ \diagdown \quad \diagup \\ \text{black} \\ \diagup \quad \diagdown \end{array}$$

$$(16) \quad \begin{array}{c} \text{blue} \\ \diagdown \quad \diagup \\ \text{red} \quad \text{green} \\ \diagup \quad \diagdown \end{array} = \begin{array}{c} \text{blue} \\ \diagdown \quad \diagup \\ \text{black} \\ \diagup \quad \diagdown \end{array} \quad \begin{array}{c} \text{blue} \\ \diagdown \quad \diagup \\ \text{black} \\ \diagup \quad \diagdown \end{array} = \begin{array}{c} \text{blue} \\ \diagdown \quad \diagup \\ \text{black} \\ \diagup \quad \diagdown \end{array}$$

- *Unitarity equation:*

$$(17) \quad \begin{array}{c} \diagdown \quad \diagup \\ \diagup \quad \diagdown \end{array} = \begin{array}{c} \downarrow \\ \downarrow \end{array}$$

- *Value at equal spectral parameters: (here, the lines must have the same color for the equality to make sense)*

$$(18) \quad \begin{array}{c} \diagdown \quad \diagup \\ \diagup \quad \diagdown \end{array} \Big|_z = \begin{array}{c} \diagdown \quad \diagup \\ \diagup \quad \diagdown \end{array} \Big|_z$$

Proof. The first property is simply a reformulation of the fact that R-matrices commute with the action of the Cartan torus of $U_q(\mathfrak{r}_{2d}[z^\pm])$. This property will be used repeatedly in what follows, sometimes requiring a careful check for $d = 1, 2, 3, 4$ (possibly by computer).

All other properties can be proven as follows: first note that the pictures represent intertwiners between two $U_q(\mathfrak{r}_{2d}[z^\pm])$ -modules which are irreducible (for our generic choice of spectral parameters; for (18), use [Cha02] or [FM01, Prop. 6.15]). Therefore by Schur’s

lemma, l.h.s. and r.h.s. must be proportional. In order to fix the constant of proportionality, we now impose the “boundary conditions 0” on the pictures, i.e., compute the matrix elements of these intertwiners between vectors of the form of a tensor product of $e_{\alpha,0}$. Using the first property, one can check that 0s propagate throughout the diagrams, so that we only get entries of the form of (11) or (13), which are all equal to 1. \square

(18) also justifies exception (i) in our localization: $\check{R}_{\alpha,\alpha}(z)$ is well-defined (and equal to 1) at $z = 1$.

3.3. The main theorem. Given three strings λ, μ, ν of same content, we define

$$(19) \quad \begin{array}{c} \lambda \\ \mu \\ \nu \end{array} := \left\langle e_{\nu}^*, \overbrace{U \dots U}^n \overbrace{R \dots R}^{\binom{n}{2}} e_{\lambda} \otimes e_{\mu} \right\rangle$$

to be the matrix entry of the product of R-matrices and U-matrices forming a puzzle, where $e_{\lambda} := \bigotimes_{k=1}^n e_{1,\lambda_k}$ and so on; e.g., for $\lambda = 0102, \mu = 0201, \nu = 0210$,

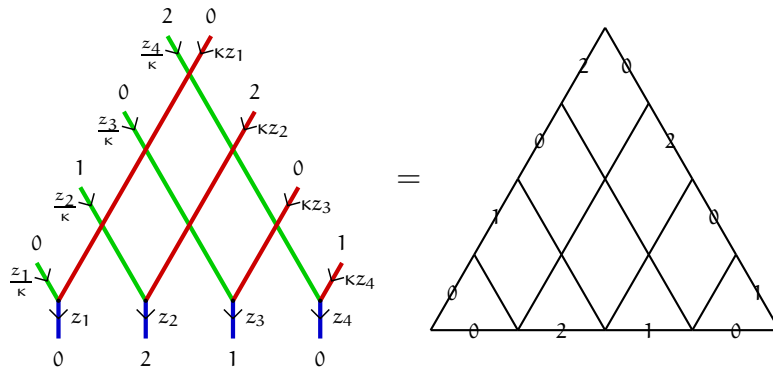

where $\kappa = q^{-h_a/3}$. Note that $e_{\lambda} \otimes e_{\mu}$ is viewed as a basis element of $V_1(\kappa^{-1}z_1) \otimes \dots \otimes V_1(\kappa^{-1}z_n) \otimes V_2(\kappa z_1) \otimes \dots \otimes V_2(\kappa z_n)$, so that, just like for lemma 3.3, we have to restrict localization so it allows the ratio $\kappa^2 = q^{-2h_a/3}$ for these specific pairs of spectral parameters.

Traditionally, a (Schubert) puzzle is an assignment of certain labels to *every* edge of the picture on the r.h.s. above. This point of view can be recovered by fixing bases of the spaces $V_{\alpha}(z)$ and then inserting decompositions of the identity at every edge. The expression above is then the sum over all possible puzzles of their “fugacity” (in the language of [KZJ17]), i.e., of the corresponding matrix entries. Our bases are always made of weight vectors, which fixes them uniquely up to normalization – except at $d = 4$ where the zero weight space has dimension 9, an issue which is deferred to §5.4. Whenever we use the term “puzzle” below, we implicitly assume that such a choice of basis of weight vectors has been made. We then label edges using (nonzero) weights, with the shortcut notation used above that the weights \vec{f}_i on the NW side (resp. $\tau^2 \vec{f}_i$ on the NE side, $-\tau \vec{f}_i$ on the S side) are abbreviated as “ i ”.⁵

⁵To avoid any risk of confusion between such labels “ i ” and the original weights, all our weights have arrows, as e.g. \vec{f}_i .

Lemma 3.5. *Suppose one is given*

$$\Phi = \begin{array}{c} \lambda \quad \mu \\ \triangle \end{array} := \overbrace{U \dots U}^n \overbrace{\tilde{R} \dots \tilde{R}}^{\binom{n}{2}} e_\lambda \otimes e_\mu \in \bigotimes_{k=1}^n V_3(z_k)$$

where the product of R-matrices and U-matrices forms as in (19) a puzzle, and λ and μ are strings with the same content. Then $\Phi \in \bigotimes_{k=1}^n V_3^A(z_k)$, and more precisely is a linear combination of $e_\nu = \bigotimes_{k=1}^n e_{3,\nu_k}$ where ν runs over strings of the same content as λ and μ .

Combinatorially, this is the statement “if the NW and NE edges are labeled only with single-numbers (not the more general multinumbers that appear within), then the S edge is necessarily also labeled with single-numbers”.

Proof. This is a direct consequence of the first part of lemma 3.2 and of the weight conservation of proposition 3.4, noting that the weight of e_μ is τ^2 times the weight of e_λ , so that the weight of Φ is $-\tau$ times that of e_λ . \square

Proposition 3.6. *There is a unique puzzle $\begin{array}{c} \lambda \quad \mu \\ \triangle \\ \omega \end{array}$ with a weakly increasing string ω at the bottom (where λ and μ are a priori arbitrary strings of the same content); its other two sides are also labeled by $\lambda = \mu = \omega$, and its labels on non-horizontal edges are constant along each diagonal (NW/SE or NE/SW).*

Proof. For $d \leq 3$ this was already proven in [KZJ17, prop. 3.4]. We provide here a different proof, which works at $d = 4$.

The proof is based on weight conservation, and on scalar products of weights. We normalize the Killing form $\langle \cdot, \cdot \rangle$ so that the norm of weights is 2 for $d \leq 3$, and 2 or 0 at $d = 4$; see in particular [KZJ17, §2.4] where the scalar product of \vec{f}_i is computed explicitly (in the notations there, $a = 3, 2, 3/2, 1$ for $d = 1, 2, 3, 4$; see also appendix D).

Let i be the first entry of ω . Because ω is weakly increasing, all labels of λ, μ, ω are greater or equal to i . We have, for $j > i$,

$$\langle \vec{f}_j + \tau \vec{f}_i, \vec{f}_j + \tau \vec{f}_i \rangle = 4 + 2\langle \tau \vec{f}_i, \vec{f}_j \rangle = 8, 6, 5, 4 > 2 \quad \text{for } d = 1, 2, 3, 4 \text{ respectively}$$

so triangles $\begin{array}{c} j \\ \triangle \\ i \end{array}$ with $j \geq i$ only exist for $j = i$, and we are led to the following partial filling of our puzzle P:

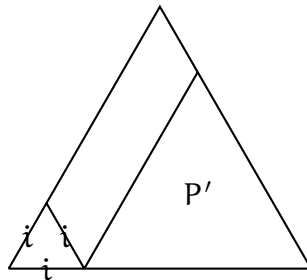

We now want to determine the labels of the rhombi forming the left column. One has the following lemma:

Lemma 3.7. For $0 \leq i \leq d$, let \mathcal{A}_i be the set of weights $\{\tau^2 \vec{f}_i, -\vec{f}_i, \dots, -\vec{f}_4\}$ at $d = 4$, and $\mathcal{A}_i = \{\tau^2 \vec{f}_i\}$ for $d \leq 3$. Given $j \geq i$, $\vec{u} \in \mathcal{A}_i$ and $\vec{v} \in \mathcal{W}$, $\vec{w} \in \tau^2 \mathcal{W}$, the equality $\vec{u} + \vec{v} = \vec{w} + \vec{f}_j$

(which is a necessary condition for the existence of a rhombus of the form



according to

the first point of proposition 3.4) implies $\vec{w} \in \mathcal{A}_i$. Furthermore, if $\vec{w} = \tau^2 \vec{f}_i$, then $\vec{u} = \tau^2 \vec{f}_i$.

Proof. In what follows, we use the following: for all $\vec{u} \in \tau^2 \mathcal{W}$, $\vec{v} \in \mathcal{W}$, one has, for $d = 4$, $-2 \leq \langle \vec{u}, \vec{v} \rangle \leq 2$, and for $d \leq 3$ the stronger bound $-1 \leq \langle \vec{u}, \vec{v} \rangle \leq 2$ (the former follows from Cauchy–Schwarz; noting that $\langle \vec{u}, \vec{v} \rangle = -2$ implies that V_1 and V_2 are dual of each other as \mathfrak{r}_{2d} representations, which only occurs at $d = 4$, results in the latter).

Given $j \geq i$, $\vec{u} \in \mathcal{A}_i$ and $\vec{v} \in \mathcal{W}$, $\vec{w} \in \tau^2 \mathcal{W}$, noting $\langle \vec{u}, \vec{u} \rangle = \langle \vec{f}_j, \vec{f}_j \rangle = 2$,

$$\begin{aligned}
 (20) \quad \langle \vec{u}, \vec{w} \rangle &= \frac{1}{2} (\langle \vec{u}, \vec{u} \rangle + \langle \vec{w}, \vec{w} \rangle - \langle \vec{u} - \vec{w}, \vec{u} - \vec{w} \rangle) \\
 &= 1 + \frac{1}{2} (\langle \vec{u} + \vec{v} - \vec{f}_j, \vec{u} + \vec{v} - \vec{f}_j \rangle - \langle \vec{v} - \vec{f}_j, \vec{v} - \vec{f}_j \rangle) \\
 &= 2 + \langle \vec{u}, \vec{v} \rangle - \langle \vec{u}, \vec{f}_j \rangle
 \end{aligned}$$

Let us first assume $\vec{u} = \tau^2 \vec{f}_i$. Then $\langle \vec{u}, \vec{f}_j \rangle = -1$. If $d \leq 3$, (20) implies $\langle \vec{u}, \vec{w} \rangle \geq 2$, and therefore $\langle \vec{u}, \vec{w} \rangle = 2$ and $\vec{w} = \vec{u} = \tau^2 \vec{f}_i$. If $d = 4$, there are two possibilities: either $\langle \vec{u}, \vec{w} \rangle = 2$ and we conclude likewise; or $\langle \vec{u}, \vec{w} \rangle = 1$, which means $\langle \vec{u}, \vec{v} \rangle = -2$, a bound which is only reached if $\vec{v} = -\vec{u}$ and therefore $\vec{w} = -\vec{f}_j$.

Now if $d = 4$, $\vec{u} = -\vec{f}_k$, $k \geq i$, if $k \neq j$, then $\langle \vec{u}, \vec{f}_j \rangle = -1$ and the same reasoning as above applies, implying $\vec{w} = -\vec{f}_k$ or $\vec{w} = -\vec{f}_j$. If $k = j$, $\langle \vec{u}, \vec{f}_j \rangle = -2$ and we conclude similarly that $\vec{v} = -\vec{u}$ and therefore $\vec{w} = -\vec{f}_j$. \square

For $d \leq 3$, we conclude immediately from lemma 3.7 that all rhombi in the column are

of the form  for some $j \geq i$. The same conclusion is reached at $d = 4$ as follows:

we start from the bottom and repeatedly apply lemma 3.7, concluding that all NE labels of the rhombi in the column belong to \mathcal{A}_i . When we reach the top of the column, the NE label must be a single number and therefore must be i . By applying the last part of lemma 3.7, we can backtrack all the way to the bottom of the column and conclude again

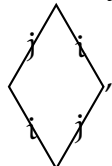
that all rhombi are of the form , $j \geq i$.

The statement of the proposition now follows by induction, noting that P' is a puzzle that satisfies the hypotheses of the proposition. \square

We can now state our main theorem:

Theorem 3.8. *Let $d = 1, 2, 3, 4$, and $P_- \setminus G$ be a d -step flag variety. The product of two motivic Segre classes S^λ and S^μ in $K_{\dagger}^{\text{loc}}(\mathbb{T}^*(P_- \setminus G))$ is given by the “puzzle” formula*

$$(21) \quad S^\lambda S^\mu = \sum_{\nu} \begin{array}{c} \lambda \quad \mu \\ \triangle \\ \nu \end{array} S^\nu$$

Proof. The proof is essentially identical to that of [KZJ17, theorem 1.4], except for the way we fix the normalization of fugacities. We first note that (21) can be proven by restricting to each fixed point $\sigma \in W_p \setminus W$. We then have the formal series of equalities

$$\begin{aligned} \sum_{\nu} \begin{array}{c} \lambda \quad \mu \\ \triangle \\ \nu \end{array} S^\nu|_{\sigma} &\stackrel{\text{lemma 2.4,3.2}}{=} \sum_{\nu} \begin{array}{c} \lambda \quad \mu \\ \triangle \\ \nu \\ \hline \omega \end{array} \stackrel{\text{lemma 3.5}}{=} \begin{array}{c} \lambda \quad \mu \\ \triangle \\ \sigma \\ \hline \omega \end{array} \stackrel{\text{prop. 3.4}}{=} \begin{array}{c} \lambda \quad \mu \\ \triangle \\ \omega \end{array} \\ &\stackrel{\text{lemma 3.2}}{=} \sum_{\tilde{\lambda}, \tilde{\mu}} \begin{array}{c} \lambda \quad \mu \\ \triangle \\ \omega \end{array} \stackrel{\text{prop. 3.6}}{=} C_{\omega} \begin{array}{c} \lambda \quad \mu \\ \triangle \\ \omega \end{array} \stackrel{\text{lemma 2.4,3.2}}{=} C_{\omega} S^{\lambda}|_{\sigma} S^{\mu}|_{\sigma} \end{aligned}$$

where C_{ω} is the value of the trivial puzzle occurring in proposition 3.6.

We now need to show $C_{\omega} = 1$, which is equivalent to the following

Lemma 3.9. *One has for $0 \leq i \leq j \leq d$*

$$\check{R}_{1,2}(z)_{ij}^{ji} = \begin{array}{c} j \quad i \\ \diamond \\ i \quad j \end{array} = 1$$

and for $0 \leq i \leq d$

$$U_i^{ii} = \begin{array}{c} i \quad i \\ \triangle \\ i \end{array} = D_{ii}^i = \begin{array}{c} i \\ \triangle \\ i \quad i \end{array} = 1$$

By using the Weyl group action as in §7.1, it is not hard to reduce to the case $i = 0$, with the normalization conditions (11) and (13) in mind; however this is not enough to prove the first equality in the case $j \neq 0$. Instead, one must resort to direct calculation (which we skip here) of the relevant R-matrix entries based on the explicit expressions of appendix B, [KZJ17, §3.6 and 3.8], [ZJ20], respectively, noting that the required entries are “diagonal”, i.e., independent of the normalization of the weight vectors inside each one-dimensional weight space; only the overall normalization of the R- and U-matrices is left undetermined, and one then concludes using (11) and (13). \square

There is an obvious dual statement, that we state without proof. Let

$$\begin{array}{c} \nu \\ \triangle \\ \mu \quad \lambda \end{array} := \left\langle e_{\mu}^* \otimes e_{\lambda}^*, \overbrace{\check{R} \dots \check{R}}^{\binom{n}{2}} \overbrace{D \dots D}^n e_{\nu} \right\rangle$$

to be the entry of the product of R-matrices and D-matrices forming a 180 degree rotated puzzle, where time still flows downwards, all labels are read left to right, and the spectral parameters at the bottom are (from left to right) $\kappa z_1, \dots, \kappa z_n, \kappa^{-1} z_1, \dots, \kappa^{-1} z_n$. Then

Theorem 3.10. *Let $d = 1, 2, 3, 4$, and $P_- \setminus G$ be a d -step flag variety.*

$$(22) \quad S_\lambda S_\mu = \sum_\nu S_\nu \begin{array}{c} \text{---} \\ \diagup \quad \diagdown \\ \mu \quad \lambda \\ \diagdown \quad \diagup \\ \text{---} \end{array} S_\nu$$

3.4. The hierarchy of bases. The various limits can be summarized in the following diagram:

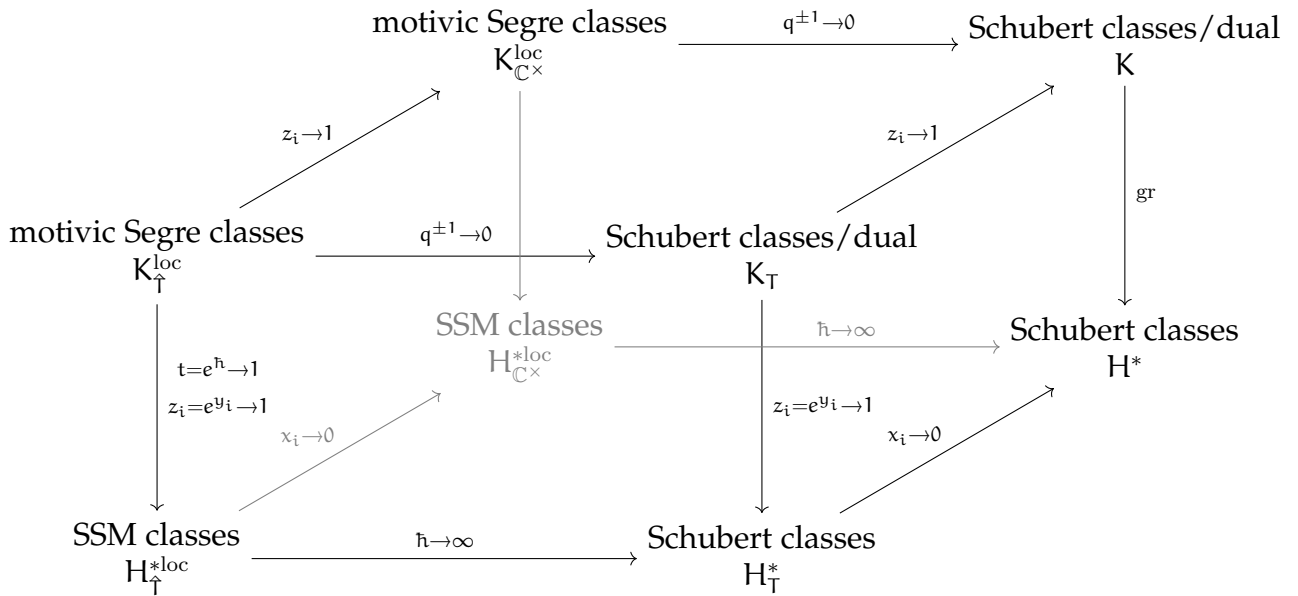

The vertical direction is going from K-theory to cohomology and will be discussed in more detail in §5.

The Northeast direction corresponds to forgetting the Cartan torus equivariance, keeping only the \mathbb{C}^\times action, e.g., working in $K_{\mathbb{C}^\times}(T^*(P_- \setminus G))$. By a slight abuse of language, we shall call the resulting specialization of theorem 3.8 the “nonequivariant rule” (note that it makes no sense⁶ to remove the equivariance altogether, because the definition of motivic Segre classes requires localization). In this limit, the rhombi composing a puzzle each break into triangles according to (12), so that a nonequivariant puzzle looks like

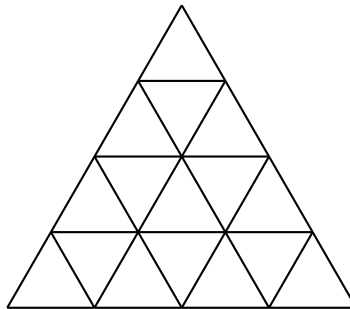

⁶Ginzburg’s formula [Gin86] for Chern–Schwartz–MacPherson classes hides its use of dilation equivariance in a rather sneaky way, by specializing $\hbar \rightarrow -1$. In the cohomological limit (bottom layer of the hierarchy cube), the \hbar s can be recovered by re-homogenizing, but this trick is unavailable in K-theory.

We now discuss the horizontal arrows, those going from left to right side of the cube.

3.5. Inversion numbers and Drinfeld twist. The horizontal arrows were the object of [KZJ17, §3.6.2]; this limit is related to getting rid of the fiber of the bundle $T^*(P_- \backslash G) \rightarrow P_- \backslash G$ by sending the equivariant parameter q scaling it to 0 (or ∞). We briefly review this limit here, describing how to recover the results of [KZJ17] as a limit of theorem 3.8.

We first show how to obtain Schubert classes as limits of motivic Segre classes. Return to the setup of §2. It is convenient to extend the Cartan action of (the quantized loop algebra of) \mathfrak{sl}_{d+1} on $V^\Lambda = \mathbb{C}^{d+1} = \langle e_0, \dots, e_d \rangle$ to that of \mathfrak{gl}_{d+1} , i.e., introduce operators h_i , $i = 0, \dots, d$, such that $h_i e_j = \delta_{i,j} e_j$.

Introduce next the *Drinfeld twist* [Dri88, Dri89] acting in $V^\Lambda \otimes V^\Lambda$ by

$$\Omega = q^{\frac{1}{2} \sum_{i,j=0}^d B_{i,j} h_i \otimes h_j}$$

where $B_{i,j} = \text{sign}(i - j) = -1, 0, 1$ depending on whether $i < j$, $i = j$, $i > j$, and use it to conjugate the R-matrix (1):

$$\check{R}(z)_{\text{twist}} = \Omega \check{R}(z) \Omega^{-1}$$

Define more generally the operator Ω_n acting on $(V^\Lambda)^{\otimes n}$ by

$$\Omega_n = q^{\frac{1}{2} \sum_{1 \leq k < \ell \leq n} \sum_{i,j=0}^d B_{i,j} h_i^{(k)} h_j^{(\ell)}}$$

where $h_i^{(k)}$ is h_i acting on the k^{th} factor of the tensor product. (In particular, $\Omega = \Omega_2$.)

Because of the cocycle property satisfied by Ω , one has symbolically

The diagram shows an equality between two rectangular boxes. The left box is labeled σ^{-1} and has a 'twist' label at the bottom right. It has four vertical arrows entering from the top, labeled z_1, z_2, \dots, z_n , and four vertical arrows exiting from the bottom, labeled $z_{\sigma(1)}, z_{\sigma(2)}, \dots, z_{\sigma(n)}$. The right box is a composition of three parts: a top box labeled Ω_n^{-1} , a middle box labeled σ^{-1} , and a bottom box labeled Ω_n . It has the same four top arrows z_1, z_2, \dots, z_n and four bottom arrows $z_{\sigma(1)}, z_{\sigma(2)}, \dots, z_{\sigma(n)}$. The two boxes are connected by an equals sign.

where the “twisted” rectangle uses $\check{R}(z)_{\text{twist}}$ at each crossing of the diagram of σ^{-1} .

With (6) in mind, we compute $\Omega_n^{-1} e_\lambda = q^{-\ell(\lambda) + D/2} e_\lambda$, where $D = \dim(P_- \backslash G)$ (cf [KZJ17, lemma 2.4]), and similarly $e_\omega^* \Omega_n = q^{-D/2} e_\omega^*$, so that

$$(23) \quad \begin{array}{c} \overbrace{\quad \lambda \quad} \\ \downarrow z_1 \downarrow z_2 \downarrow \dots \downarrow z_n \\ \sigma^{-1} \\ \downarrow z_{\sigma(1)} \downarrow z_{\sigma(2)} \downarrow \dots \downarrow z_{\sigma(n)} \\ \underbrace{\quad \omega \quad} \end{array} \text{twist} = q^{-\ell(\lambda)} \begin{array}{c} \overbrace{\quad \lambda \quad} \\ \downarrow z_1 \downarrow z_2 \downarrow \dots \downarrow z_n \\ \sigma^{-1} \\ \downarrow z_{\sigma(1)} \downarrow z_{\sigma(2)} \downarrow \dots \downarrow z_{\sigma(n)} \\ \underbrace{\quad \omega \quad} \end{array} = q^{-\ell(\lambda)} S^\lambda|_\sigma$$

Let us now compute explicitly from (1)

$$\lim_{q \rightarrow 0} \check{R}_{\text{twist}}(z) = \begin{cases} 1 & i = k \leq j = l \\ 1 - z & i = l < j = k \\ z & i = k > j = l \\ 0 & \text{else} \end{cases}$$

As explained in [KZJ17, §3.6], this *nilHecke* R-matrix is directly related to the K-theory of partial flag varieties (as opposed to their cotangent bundles); paying attention to the fact (cf 2.1.3 and [KZJ17, §2.1]) that inverse equivariant parameters and classes of line bundles are used there, we can compute the limit as $q \rightarrow 0$ of the l.h.s. of (23) to be the restriction $\underline{S}^\lambda|_\sigma$ to the fixed point σ of the Schubert class \underline{S}^λ associated to λ , composed with the map \vee that takes classes of vector bundles to classes of their duals (i.e., $x_i \mapsto x_i^{-1}$, $z_i \mapsto z_i^{-1}$). We conclude that

$$\underline{S}^\lambda = \left(\lim_{q \rightarrow 0} q^{-\ell(\lambda)} S^\lambda \right)^\vee$$

as elements of $K_\uparrow(P_- \backslash G) \cong K_\uparrow(T^*(P_- \backslash G))$. \vee , being a ring map, does not affect product rules.

Now consider any τ -invariant alternating form B on the weight space of \mathfrak{r}_{2d} that extends (B_{ij}) above, i.e., $B(\vec{f}_i, \vec{f}_j) = B_{ij}$.⁷ Use it to twist all R-matrices and U, D :

$$\Omega = q^{\frac{1}{2}B(H,H)}, \quad \check{R}(z)_{ij,\text{twist}} = \Omega \check{R}(z)_{ij} \Omega^{-1}, \quad U_{\text{twist}} = U \Omega^{-1}, \quad D_{\text{twist}} = \Omega D$$

where H stands for the collection of Cartan generators, and assign to puzzles twisted fugacities, which we denote with a subscript “twist”. We then have

Proposition 3.11. *Let $d = 1, 2, 3, 4$ and $P_- \backslash G$ be a d -step flag variety. The product of two Schubert classes \underline{S}^λ and \underline{S}^μ in $K_\uparrow(P_- \backslash G)$ is given by*

$$\underline{S}^\lambda \underline{S}^\mu = \lim_{q \rightarrow 0} \sum_{\nu} \begin{array}{c} \lambda \\ \triangle \\ \mu \\ \nu \end{array} \vee \underline{S}^\nu$$

This expression is not entirely satisfactory because the summation is not positive, so that there may be compensations. A natural question is whether one can choose bases⁸ of the $V_a(z)$ and an alternating form B in such a way the the fugacity of every (twisted) rhombus and triangle has a finite (positive) limit as $q \rightarrow 0$.

The case $d = 1$, which was only sketched in [KZJ17] because it did not lead to any new results, will be developed in §4.2 based on our more general framework. For $d = 2$, [KZJ17] provides a positive answer to the question above, leading to a positive K_\uparrow puzzle rule. At $d = 3$, the situation is more subtle: it seems impossible to keep the fugacity of equivariant rhombi finite as $q \rightarrow 0$. One can however find a limit for the (nonequivariant) fugacity of every triangle, leading to a positive K puzzle rule. In particular every triangle (with nonzero fugacity) has a nonnegative inversion number.

The situation is worse at $d = 4$: even nonequivariantly, it seems impossible to get rid of triangles with negative inversion number. This does not preclude from formulating

⁷In practice, it is convenient to augment the weight space in a similar way as we switched from \mathfrak{sl}_{d+1} to \mathfrak{gl}_{d+1} above; this is implicit in [KZJ17].

⁸Note that for $d \leq 3$, the representations $V_a(z)$ being minuscule, the only real freedom in the choice of bases is normalization of the weight vectors.

a puzzle rule in nonequivariant K-theory, but the answer is sufficiently complicated that we prefer not to write it explicitly, providing instead in §5.4 a (mildly nonpositive) rule in nonequivariant cohomology only.

The limit $q \rightarrow \infty$ can be treated similarly. In view of lemma 2.6, this is actually the same as taking $q \rightarrow 0$ in the dual theorem 22. Explicitly, if one applies the opposite twist Ω^{-1} to S_λ , one obtains in the $q \rightarrow 0$ limit the classes $\underline{S}_\lambda^\vee$ where the \underline{S}_λ are *dual* Schubert classes; and we derive this way puzzle rules for the latter.

4. EXAMPLE: $d = 1$

4.1. **The $d = 1$ setup.** We now provide the full details of the simplest case $d = 1$, i.e., $P_- \backslash G$ is a Grassmannian. The explicit definition of the quantized affine algebra $\mathcal{U}_q(\mathfrak{a}_2^{(1)})$ is given in appendices A and B.

We consider the three $\mathcal{U}_q(\mathfrak{a}_2[z^\pm])$ -modules $V_\alpha(z)$, $\alpha = 1, 2, 3$ (z is a formal parameter); even though $V_1(z)$ and $V_2(z)$ are isomorphic, it is useful to differentiate them. They have bases $e_{\alpha, X}$, $\alpha = 1, 2, 3$, labeled by $X \in \{1, 0, 10\}$, where the first two vectors form the usual bases of $V_\alpha^\Lambda(z)$, while the third vector is the remaining weight vector with some convenient normalization (the label “10” is traditional, see e.g. [KZJ17, §2.3] for a justification); and their weights are given by \vec{f}_X (resp. $\tau^2 \vec{f}_X, -\tau \vec{f}_X$). The representation matrices are given explicitly in appendix B.

The relevant R-matrices are also given in appendix B. In particular, one checks that if restricted to the single-number sector $\{0, 1\}$, all three R-matrices $\check{R}_{\alpha, \alpha}(z)$ coincide with the one in (1), in accordance with lemma 3.2.

At the particular ratio $z''/z' = q^{-2}$, $V_1(z') \otimes V_2(z'')$ and $V_2(z'') \otimes V_1(z')$ become reducible, and the R-matrix factorizes $\check{R}_{1,2}(q^{-2}) = DU$ as in lemma (3.3). The nonzero entries of U (resp. D) are depicted as up-pointing (resp. down-pointing) triangles:

$$(24) \quad \begin{array}{cccccc} \begin{array}{c} \triangle \\ 0 \quad 0 \\ 0 \end{array} = \begin{array}{c} \triangle \\ 1 \quad 1 \\ 1 \end{array} = \begin{array}{c} \triangle \\ 0 \quad 10 \\ 1 \end{array} = \begin{array}{c} \triangle \\ 10 \quad 1 \\ 0 \end{array} = \begin{array}{c} \triangle \\ 1 \quad 0 \\ 10 \end{array} = 1 & \begin{array}{c} \triangle \\ 10 \quad 10 \\ 10 \end{array} = -q^{-1} \\ \begin{array}{c} \triangle \\ 0 \quad 0 \\ 0 \end{array} = \begin{array}{c} \triangle \\ 1 \quad 1 \\ 1 \end{array} = \begin{array}{c} \triangle \\ 10 \quad 0 \\ 1 \end{array} = \begin{array}{c} \triangle \\ 1 \quad 10 \\ 0 \end{array} = \begin{array}{c} \triangle \\ 0 \quad 1 \\ 10 \end{array} = 1 & \begin{array}{c} \triangle \\ 10 \quad 10 \\ 10 \end{array} = -q \end{array}$$

Away from the ratio q^{-2} of parameters, we represent the nonzero entries of the matrix $\check{R}_{1,2}$ as rhombi, and use the parametrization $\check{R}_{1,2}(q^{-2}z^{-1})$:

(25)

$$\begin{array}{cccccc}
 \begin{array}{|c|c|} \hline \emptyset & \emptyset \\ \hline \emptyset & \emptyset \\ \hline \end{array} & = & \begin{array}{|c|c|} \hline 1 & \emptyset \\ \hline \emptyset & 1 \\ \hline \end{array} & = & \begin{array}{|c|c|} \hline 1 & 1 \\ \hline 1 & 1 \\ \hline \end{array} & = & \begin{array}{|c|c|} \hline 1\emptyset & 1 \\ \hline 1 & 1\emptyset \\ \hline \end{array} & = & \begin{array}{|c|c|} \hline \emptyset & 1\emptyset \\ \hline 1\emptyset & \emptyset \\ \hline \end{array} & = & \begin{array}{|c|c|} \hline 1\emptyset & 1\emptyset \\ \hline 1\emptyset & 1\emptyset \\ \hline \end{array} & = & 1 \\
 \\
 \begin{array}{|c|c|} \hline \emptyset & \emptyset \\ \hline 1 & 1\emptyset \\ \hline \end{array} & = & \begin{array}{|c|c|} \hline 1 & 1 \\ \hline 1\emptyset & \emptyset \\ \hline \end{array} & = & \frac{1-q^2}{1-q^2z} & \begin{array}{|c|c|} \hline 1\emptyset & 1 \\ \hline \emptyset & \emptyset \\ \hline \end{array} & = & \begin{array}{|c|c|} \hline \emptyset & 1\emptyset \\ \hline 1 & 1 \\ \hline \end{array} & = & \frac{(1-q^2)z}{1-q^2z} \\
 \\
 & & \begin{array}{|c|c|} \hline \emptyset & 1 \\ \hline 1 & \emptyset \\ \hline \end{array} & = & \begin{array}{|c|c|} \hline 1\emptyset & \emptyset \\ \hline \emptyset & 1\emptyset \\ \hline \end{array} & = & \begin{array}{|c|c|} \hline 1 & 1\emptyset \\ \hline 1\emptyset & 1 \\ \hline \end{array} & = & \frac{q(1-z)}{1-q^2z} \\
 \\
 \begin{array}{|c|c|} \hline 1\emptyset & 1\emptyset \\ \hline \emptyset & 1 \\ \hline \end{array} & = & -q^{-1} \frac{(1-q^2)z}{1-q^2z} & \begin{array}{|c|c|} \hline 1 & \emptyset \\ \hline 1\emptyset & 1\emptyset \\ \hline \end{array} & = & -q \frac{1-q^2}{1-q^2z}
 \end{array}$$

The parameter z should be set to z_j/z_i for a rhombus at location $i < j$.

Example 4.1. Consider the simplest nontrivial example, of $T^*\mathbb{P}^1$. The restrictions of motivic Segre classes at each fixed point were computed in example 2.5:

$$\begin{array}{l}
 S^{01} = \begin{pmatrix} |_{01} & \\ \hline 1 & (1-q^2)/(1-q^2z_2/z_1) \end{pmatrix} \\
 S^{10} = \begin{pmatrix} & |_{10} \\ \hline 0 & q(1-z_2/z_1)/(1-q^2z_2/z_1) \end{pmatrix}
 \end{array}$$

The possible products are:

- $S^{01}S^{01} = S^{01} - \frac{q(1-q^2)}{1-q^2z_2/z_1}S^{10}$, with corresponding puzzles

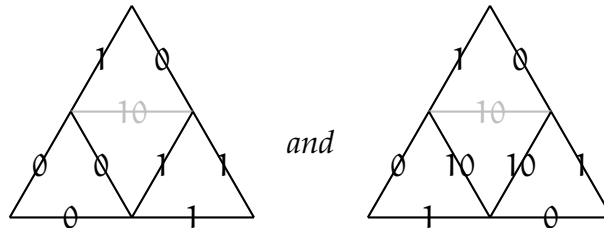

(we indicated in light gray the corresponding nonequivariant puzzles, see §4.3).

- $S^{01}S^{10} = S^{10}S^{01} = \frac{1-q^2}{1-q^2z_2/z_1}S^{10}$, with one puzzle for each of the two computations:

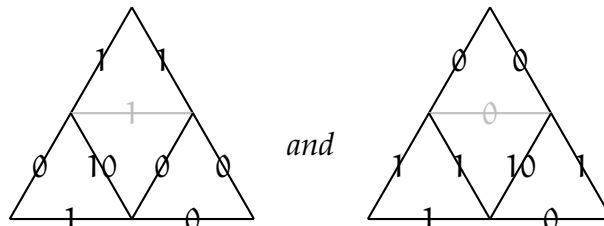

• $S^{10}S^{10} = \frac{q(1-z_2/z_1)}{1-q^2z_2/z_1} S^{10}$, with puzzle

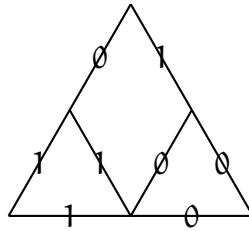

(this one only contributes equivariantly, as its fugacity vanishes at $z_1 = z_2$).

The same exercise can be repeated for the dual classes:

$$\begin{matrix} & & |_{01} & & |_{10} \\ S_{01} = & (& q(1 - z_1/z_2) / (1 - q^2z_1/z_2) & & 0 &) \\ S_{10} = & (& (1 - q^2)z_1/z_2 / (1 - q^2z_1/z_2) & & 1 &) \end{matrix}$$

the puzzles being 180 degree rotations of the ones above.

4.2. **Back to Schubert calculus in $\text{Gr}(k, n)$.** We now consider the limit $q^{\pm 1} \rightarrow 0$, cf. the top horizontal arrow of the diagram of §3.4. As discussed in §3.5, one must first twist the triangle/rhombi according to their inversion number. We list only those with nonzero inversion numbers:

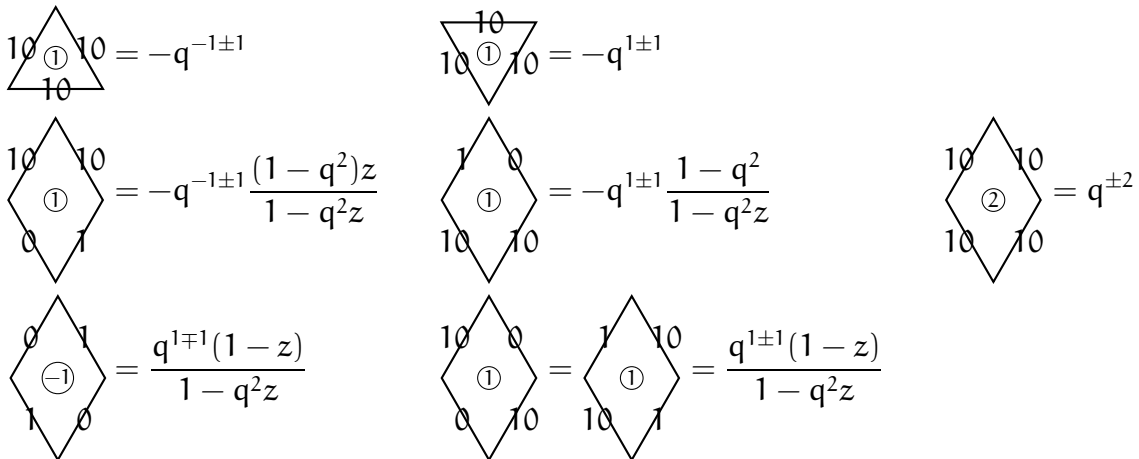

If we pick the + sign and send q to 0, the first of the two triangles survive, as well as the first rhombi of each row, and we recover exactly the puzzle rule for Schubert classes in the equivariant K-theory of the Grassmannian as formulated in [WZJ19] (related to symmetric Grothendieck polynomials). If we pick the - sign and send q to ∞ , the second triangle and the second rhombus of the second row survive, as well as the same first rhombus in the third row; rotating the pieces 180 degrees, we recognize the same rule as in the first limit, with the substitution $z \rightarrow z^{-1}$, cf lemma 2.6. This is nothing but the usual reflection of duality in the quantum integrable setting; we recover this way the puzzle rule for dual Schubert classes (i.e., classes of ideal sheaves of boundaries of Schubert varieties) in the equivariant K-theory of the Grassmannian as formulated in [WZJ19]. In this sense, the finite q rule interpolates between Schubert and dual Schubert puzzle rules.

4.3. **Nonequivariant rule and loop model.** Let us now discuss the nonequivariant rule (NE direction in the diagram of §3.4). First, note that setting $z = 1$ in equation (25), either the fugacity of the equivariant rhombi vanishes, or it factors as a product of fugacities of triangles of equation (24), in accordance with (12).

The resulting $d = 1$ nonequivariant puzzles can be thought of as the partition function (with particular boundary conditions) of a quantum integrable model which already appeared in a different context. In [Res91], Reshetikhin considered the so-called $O(n)$ loop model on the honeycomb lattice, and observed that if loops cover the entire lattice, then the model is exactly solvable as an A_2 integrable system. We reconnect to this loop model here (in the dual graphical description).

A **loop puzzle** for the Grassmannian $Gr(k, n)$ is an assignment to each elementary triangle of a size n equilateral triangle of one of the tiles

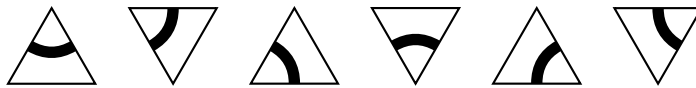

as well as k incoming arrows on the North-East side, $n - k$ outgoing arrows on the North-West side, and k outgoing arrows and $n - k$ incoming arrows on the South side, in such a way that

- At each internal edge, the black lines are continuous.
- Lines end on the sides exactly at arrows, and the directions of the arrows at opposite ends must match (i.e., lines can only connect NW and NE side, or NW to incoming arrows on the S side, or NE to outgoing arrows on the S side, or opposite arrows on the S side).

For example, if $k = 3, n = 7$, a valid loop puzzle is

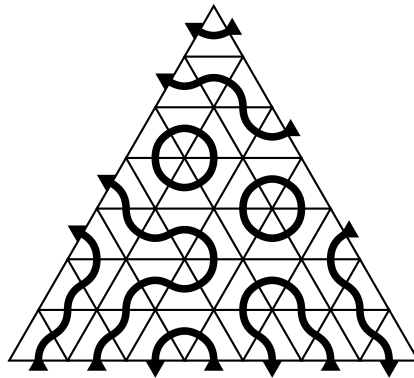

To each such loop puzzle, one associates the fugacity

$$(-q - q^{-1})^{\#\text{closed loops}} (-q)^{\#\text{paths oriented rightward with endpoints on the S side}}$$

Proposition 4.2. *The coefficient of S^ν in the expansion of $S^\lambda S^\mu$ in $K_{\mathbb{C}^\times}^{\text{loc}}(Gr(k, n))$ is the sum of fugacities of loop puzzles such that 1s of λ correspond to arrows on the NW side, 0s of μ to arrows on the NE side, 1s (resp. 0s) of ν to incoming (resp. outgoing) arrows on the S side.*

Proof. There is a bijection between $d = 1$ puzzles made of the triangles of (24) and *oriented* loop puzzles, given by:

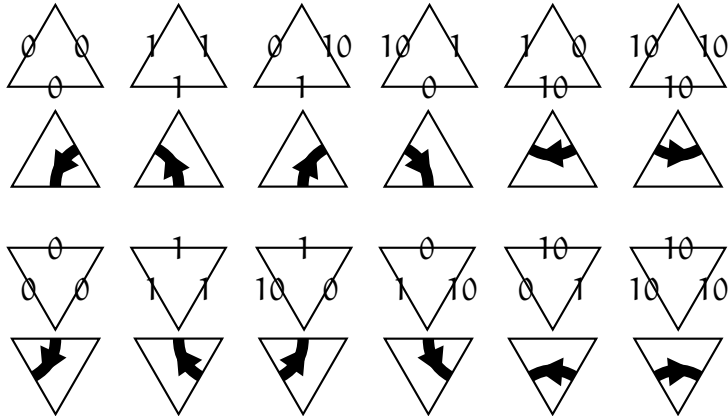

Starting from an ordinary puzzle and erasing the arrows except at the boundaries, one obtains a loop puzzle. Inversely, given a loop puzzle, one can orient each individual triangle starting from the boundaries, except for closed loops, which have two possible orientations. The formula for the fugacity follows. \square

As a corollary, we find that the coefficient of S^ν in the expansion of $S^\lambda S^\mu$ in $K_{\mathbb{C}^\times}^{\text{loc}}(\text{Gr}(k, n))$ is a polynomial with positive coefficients in $-q$ and $-(q + q^{-1})$; these coefficients are in fact unique, and given by the numbers of puzzles with fixed number of closed loops and S side rightward oriented paths.

Example. By direct computation, one finds the coefficient $-3q - q^{-1}$ for $\lambda = \mu = 0101$, $\nu = 1010$. Indeed, there are three loop puzzles:

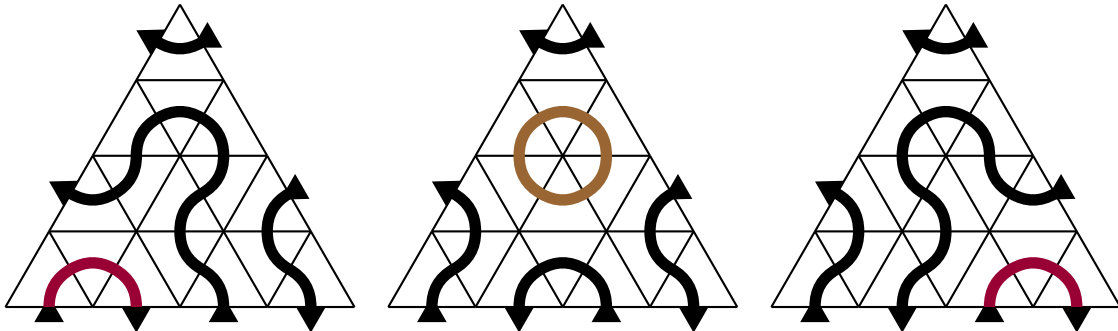

where the loop in brown results in a fugacity of $-q - q^{-1}$, whereas the two purple paths result in fugacities $-q$.

One defines similarly a dual fugacity to a loop puzzle, conventionally drawn upside-down, as

$$(-q - q^{-1})^{\#\text{closed loops}} (-q^{-1})^{\#\text{paths oriented leftward with endpoints on the N side}}$$

Then we have the obvious dual statement:

Proposition 4.3. *The coefficient of S_ν in the expansion of $S_\lambda S_\mu$ in $K_{\mathbb{C}^\times}^{\text{loc}}(\text{Gr}(k, n))$ is the sum of dual fugacities of loop puzzles such that 1s of λ correspond to arrows on the SW side, 0s of μ to arrows on the SE side, 1s (resp. 0s) of ν to incoming (resp. outgoing) arrows on the N side.*

5. THE LIMIT TO ORDINARY COHOMOLOGY

We now discuss the transition from K-theory to ordinary cohomology, corresponding to the vertical arrows of the diagram of §3.4. There is an arbitrariness in the sign of q , since only its square $q^2 = t^{-1}$ is geometrically meaningful; this choice of sign is effectively equivalent to a choice of polarization in the cohomology limit. The conventional choice is $q \rightarrow 1$; here we choose to send q to -1 , which has some technical advantages (in particular, it trivializes the polarization, which simplifies slightly the geometric discussion in §8).

5.1. Localization revisited. In §2.2 and §3.2, we have introduced the localisation that is convenient for most of the paper. However, it prevents us from specializing at $q = \pm 1$. We briefly sketch how one can get around this difficulty.

What we are formalizing here is the following procedure: in order to obtain formulæ in $H_{\dagger}^*(P_- \setminus G)$, where $H_{\dagger}^*(\text{pt}) = \mathbb{Z}[\hbar, y_1, \dots, y_n]$, we need to set $q = -e^{-\hbar/2}$, $z_i = e^{y_i}$ and to expand at first nontrivial order in \hbar, y_1, \dots, y_n .

Of course, a practical point of view is that this procedure produces a well-defined result (i.e., a $\hbar \rightarrow 0$ limit) in all cases of interest to us. A more formal way to *guarantee* that this construction is well-defined is to change the base ring by allowing less localisation.

The first point is that clearly one shouldn't tensor with $\mathbb{C}(q)$; instead, one can for example use $\mathbb{C}[q^{\pm}, [a]_q^{-1}, a \geq 2]$, where $[a]_q = (q^a - q^{-a})/(q - q^{-1})$. This means we can specialise at all q s except roots of unity distinct from ± 1 . This corresponds to the standard lore that the representation theory of quantum groups is uniform except at roots of unity.

The second point is to consider the ratios $[(k\hbar - y_i + y_j)/\hbar]_q := (1 - q^{2k}z_i/z_j)/(1 - q^2)$ for all k, i, j and to add them to our base ring. Let S be the set of (i, j, k) for which we previously made $1 - q^{2k}z_i/z_j$ invertible; we now instead make $[(k\hbar - y_i + y_j)/\hbar]_q$ invertible for all $(i, j, k) \in S$. One can check that all expressions that we have considered so far live in this ring.

The specialisation $q \mapsto \pm 1$ is now well-defined: it is easy to see that there is a well-defined map into $\mathbb{C}[\hbar^{\pm}, y_1, \dots, y_n, (k\hbar - y_i + y_j)^{-1}, (i, j, k) \in S]$ which sends q to ± 1 and $[(k\hbar - y_i + y_j)/\hbar]$ to $(k\hbar - y_i + y_j)/\hbar$ for all i, j, k .

5.2. Segre–Schwartz–MacPherson classes. In this limit to cohomology, the S^{λ} defined in §2 turn into classes $S_{\mathbb{H}}^{\lambda} \in H_{\dagger}^{*\text{loc}}(T^*(P_- \setminus G))$ which are called Segre–Schwartz–MacPherson (SSM) classes (see e.g. [FR18]); explicitly, they are given by the same diagram (5) in which K-theoretic parameters $x_1, \dots, x_n, z_1, \dots, z_n$ have been replaced with their H^* analogues, namely Chern roots t_1, \dots, t_n and equivariant parameters y_1, \dots, y_n , and in which the R-matrix entries (1) become

$$(26) \quad \begin{array}{c} k \quad l \\ y' \swarrow \quad \searrow y'' \\ i \quad j \end{array} = \check{R}_{ij}^{kl}(y', y'') = \check{R}_{ij}^{kl}(y'' - y') = \begin{cases} 1 & i = j = k = l \\ \frac{y'' - y'}{\hbar + y' - y''} & i = l \neq j = k \\ \frac{y'' - y'}{\hbar} & i = k \neq j = l \\ 0 & \text{else.} \end{cases}$$

We can define $S_{\lambda}^{\mathbb{H}}$ analogously as limit to cohomology of S_{λ} (defined by (7)); but since the entries (26) of the R-matrix are invariant under reversal of both arrows (or equivalently

by 180° rotation), lemma 2.6 simplifies to

$$(27) \quad S_\lambda^H(t_1, \dots, t_n, y_1, \dots, y_n) = S_H^{\lambda^*}(t_1, \dots, t_n, y_n, \dots, y_1)$$

where we recall that λ^* denotes the string λ read backwards. Similarly, one has for stable classes

$$(28) \quad \text{St}_\lambda^H(t_1, \dots, t_n, y_1, \dots, y_n) = \text{St}_H^{\lambda^*}(t_1, \dots, t_n, y_n, \dots, y_1)$$

Also note that the S_H^λ are degree 0 classes (which is possible because of localization).

The rest of this section being devoted to cohomology only, we omit the sub/superscripts “H” and simply write S^λ , etc.

5.3. H_\uparrow^* puzzle rules for $d \leq 3$. We now discuss puzzle rules satisfied by the S^λ . More specifically, let us consider the leftmost vertical arrow of the diagram of §3.4. In this limit, the fugacities simplify slightly, which is the sign of the τ_{2d} -invariance of the underlying R-matrix.

In the rest of this section, we assume $d \leq 3$. We start by fixing a basis of weight vectors of each $V_\alpha(z)$, $\alpha = 1, 2, 3$, given by the stable envelope construction (with, as mentioned above, the trivial choice of polarization). We recall that we then label triangles and rhombi

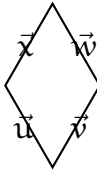
using the corresponding weights, i.e., write  for the matrix entry between basis

vectors with weights $\vec{u}, \vec{w} \in \tau^2\mathcal{W}$ and $\vec{v}, \vec{x} \in \mathcal{W}$, and similarly for triangles.

All R-matrices for $d \leq 3$ were provided in [KZJ17] and §4, and we simply state the results.

The triangles all have fugacity 1.⁹

As to the rhombi, we can parametrize them as follows. We assume $\vec{u} + \vec{v} = \vec{x} + \vec{w}$ (otherwise the matrix entry is zero). We use the Killing form $\langle \cdot, \cdot \rangle$ with the normalization that all weights have squared norm 2. For ease of comparison between different values of d , we also denote $\alpha = 3, 2, 3/2, 1$ for $d = 1, 2, 3, 4$ (see [KZJ17, §2.5] for a justification), and use it to parametrize our scalar products.

The matrix entry above can then only depend on the scalar products of the various weights. Because weight vectors have squared norm 2, there are only two independent scalar products, namely $s = \langle \vec{u}, \vec{x} \rangle = \langle \vec{v}, \vec{w} \rangle$ and $t = \langle \vec{u}, \vec{v} \rangle = \langle \vec{w}, \vec{x} \rangle$, the third scalar product being given by $r = \langle \vec{u}, \vec{w} \rangle = \langle \vec{v}, \vec{x} \rangle = t - s + 2$ (see (20) for an identical calculation). Because the latter is less than or equal to 2, one has $t \leq s$. A table of scalar products can be found in appendix D.

At $d = 1$, one can easily deduce from the results of §4 the following table

$$(29) \quad \begin{array}{c|cc} s \backslash t & -1 & -1 + \alpha \\ \hline -1 & 1 & \\ -1 + \alpha & \frac{\hbar}{\hbar - y} & \frac{y}{\hbar - y} \end{array} \quad \text{rhombus diagram}, \quad s = \langle \vec{u}, \vec{x} \rangle, \quad t = \langle \vec{u}, \vec{v} \rangle$$

⁹The sign convention is somewhat unusual from the point of view of invariant theory. E.g., at $d = 1$, the triangles are supposed to represent the fully antisymmetric tensor of \mathfrak{sl}_3 ; to recover the usual permutation signs, one needs to set $q = 1$ (as opposed to $q = -1$), and then for example change the sign of states labeled 10.

where the parameter y should be understood as the difference $y_j - y_i$ of equivariant parameters in $H_T^*(pt) \cong \mathbb{Z}[\hbar, y_1, \dots, y_n]$ related to the coordinates $i < j$ of the rhombus (and recall $a = 3$).

It is not hard to see that the exact same table (29) holds at $d = 2$ (except $a = 2$ now); this can in principle be derived from [KZJ17, appendix A].

Instead we jump straight to $d = 3$. The rhombi are all the ones that are allowed by weight conservation; there are 3591 of them. There are six different types of entries, because imposing $r, s, t \in \{-1, 1/2, 2\}$ leads to 6 solutions.

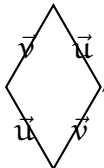
Diagonal rhombi, i.e., of the form , implying $r = 2$ and $s = t$, fall into 3 classes:

- There are 27 entries for which $s = t = 2$, i.e., $\vec{u} = \vec{v} = \vec{w} = \vec{x}$, of the form $\frac{-y(3\hbar-y)}{(\hbar-y)(4\hbar-y)}$.
- 270 entries with $s = t = -1$ which are equal to 1.
- 432 entries with $s = t = 1/2$, of the form $\frac{y}{\hbar-y}$.

Similarly, the nondiagonal rhombi are

- 2160 entries with $s = 1/2, t = -1$, of the form $\frac{\hbar}{\hbar-y}$.
- 432 entries with $s = 2, t = 1/2$, with fugacity $\frac{\hbar y}{(\hbar-y)(4\hbar-y)}$.
- 270 entries with $s = 2, t = -1$, with fugacity $\frac{4\hbar^2}{(\hbar-y)(4\hbar-y)}$.

In the last two cases note that we have $\vec{u} = \vec{x}, \vec{v} = \vec{w}$.

We can summarize these results in the table:

$s \backslash t$	-1	$-1 + a$	$-1 + 2a$
-1	1		
$-1 + a$	$\frac{\hbar}{\hbar-y}$	$\frac{y}{\hbar-y}$	
$-1 + 2a$	$\frac{4\hbar^2}{(\hbar-y)(4\hbar-y)}$	$\frac{\hbar y}{(\hbar-y)(4\hbar-y)}$	$\frac{-y(3\hbar-y)}{(\hbar-y)(4\hbar-y)}$

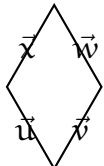
 $s = \langle \vec{u}, \vec{x} \rangle, t = \langle \vec{u}, \vec{v} \rangle$

where $a = 3/2$. The diagonal entries correspond to diagonal rhombi; the first column corresponds to “nonequivariant” rhombi (i.e., whose contribution does not vanish at $y = 0$ and then factors into a product of two triangles).

Comparing tables (29) and (30), we note that one is a subtable of the other. Another way of understanding this is that were we to consider a d -step flag variety as a d' -step flag variety with $d \leq d' \leq 3$ (and some trivial steps), the puzzle rule would remain the same. This is related to the functoriality property of [KZJ17, §2.2]. (As will be explained in the next subsection, this table containment does *not* continue to $d < d' = 4$.)

Example 5.1. *Let us compute the product $S^{3201} S^{2013}$ in $H_T^*(T^*(3\text{-step}))$. One has, using the shorthand notations $y_{ij} = y_i - y_j$ and $y'_{ij} = \hbar + y_i - y_j$,*

$$\begin{aligned}
 S^{3201} &= \left(\begin{array}{c|c} |_{3201} & |_{3210} \\ \hline \frac{y_{21}y_{31}y_{32}y_{41}y_{42}}{y'_{12}y'_{13}y'_{23}y'_{14}y'_{24}} & \frac{\hbar y_{21}y_{31}y_{32}y_{41}y_{42}}{y'_{12}y'_{13}y'_{23}y'_{14}y'_{24}y'_{34}} \\ \hline \frac{\hbar^3 y_{31}y_{41}}{y'_{12}y'_{13}y'_{23}y'_{14}y'_{24}} & \frac{\hbar^2 y_{31}y_{41}(\hbar^2 + y_{23}y_{32}y_{41} + y_{31}y_{41})}{y'_{12}y'_{13}y'_{23}y'_{14}y'_{24}y'_{34}} \end{array} \right) \\
 S^{2013} &= \left(\begin{array}{c|c} |_{3201} & |_{3210} \\ \hline \frac{y_{21}y_{31}y_{32}y_{41}y_{42}}{y'_{12}y'_{13}y'_{23}y'_{14}y'_{24}} & \frac{\hbar y_{21}y_{31}y_{32}y_{41}y_{42}}{y'_{12}y'_{13}y'_{23}y'_{14}y'_{24}y'_{34}} \\ \hline \frac{\hbar^3 y_{31}y_{41}}{y'_{12}y'_{13}y'_{23}y'_{14}y'_{24}} & \frac{\hbar^2 y_{31}y_{41}(\hbar^2 + y_{23}y_{32}y_{41} + y_{31}y_{41})}{y'_{12}y'_{13}y'_{23}y'_{14}y'_{24}y'_{34}} \end{array} \right)
 \end{aligned}$$

all other entries being irrelevant. From this we conclude

$$S^{3201} S^{2013} = \frac{\hbar^3 y_{13} y_{14}}{y'_{12} y'_{13} y'_{23} y'_{14} y'_{24}} S^{3201} + \frac{\hbar^3 y_{13} y'_{32} y_{14}}{y'_{12} y'_{13} y'_{23} y'_{14} y'_{24} y'_{34}} S^{3210}$$

In order to draw the corresponding puzzles, it is convenient to provide weights using the traditional multinumber notation. A label X translates into the weight \vec{f}_X multiplied by $1, -\tau, \tau^2$ for NE–SW, NW–SE, horizontal edges, where \vec{f}_X is defined inductively starting from the single-number labels $0, \dots, d$ by $\vec{f}_{YX} = -\tau\vec{f}_X - \tau^2\vec{f}_Y$ (see [KZ]17, §2.3] for details). We also provide the scalar products of weights, under the form of a blue number $k \in \{0, 1, 2\}$ where the scalar product is $-1 + ka$; as well as the corresponding nonequivariant triangles (in light gray).

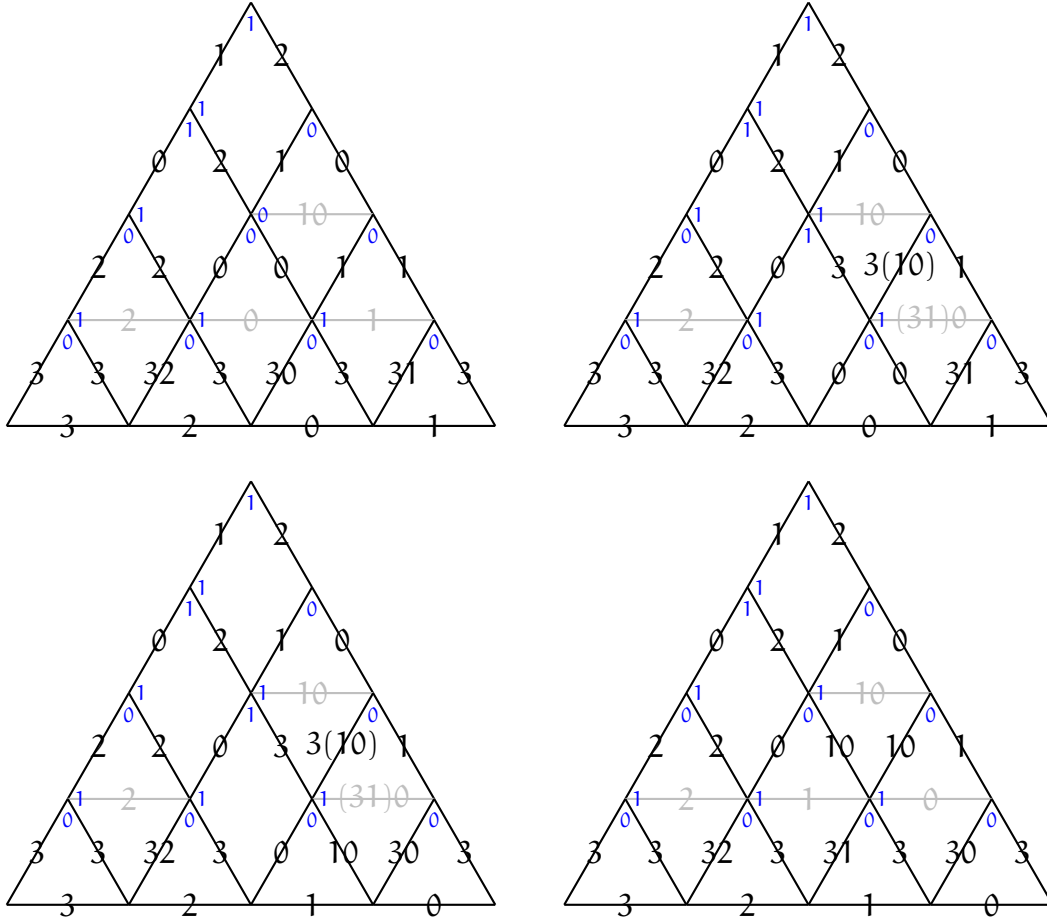

For example, the first puzzle could be written more explicitly as

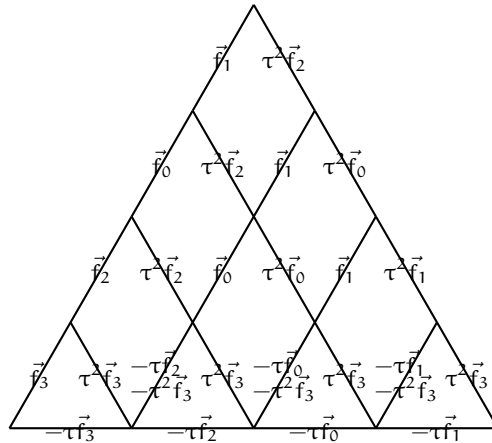

We leave it as an exercise to the reader to check that the fugacities of the puzzles sum up to the correct coefficients in the expansion of $S^{3201}S^{2013}$ (a table of scalar products can be found in appendix D).

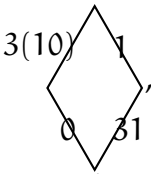
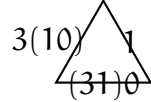
Note that neither the rhombus , nor the triangle , exist in the

puzzle rule for 3-step Schubert classes as formulated in [KZJ17]; they are suppressed as $\hbar \rightarrow \infty$.

The value of the scalar product $s = -1 + 2a$ only occurs in cases where manual computation would be difficult (and such examples would be too long to fit in a paper). Here is *one* puzzle (among the 30) contributing to the coefficient of S^{2310} in $S^{0213}S^{0321}$:

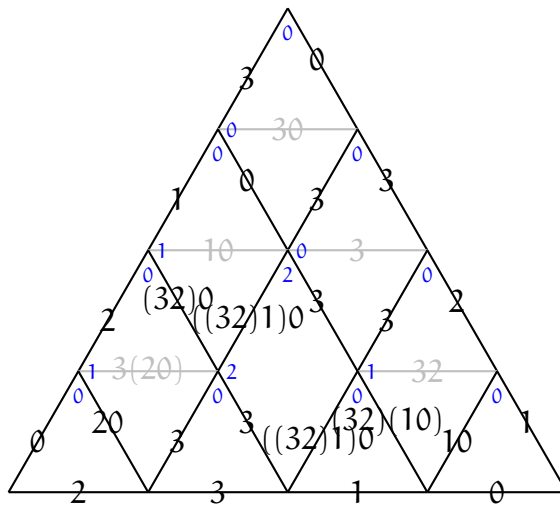

5.4. Some details on $d = 4$. 4-step puzzles involve several complications which have already been mentioned; for details on the underlying representation theory of $\mathcal{U}_q(\mathfrak{e}_8[z^\pm])$, we refer to the companion paper [ZJ20]. These complications are present even in cohomology. Note that all examples of $d = 4$ puzzles are relegated to appendix C.

In order to simplify the discussion, we first consider the case $q = 1$, where the q -deformation disappears (the required sign changes to set $q = -1$ will be provided shortly). The spaces $V_a(z)$ decompose under the action of \mathfrak{e}_8 as the direct sum of the adjoint representation and the trivial representation. Each of the 240 nonzero weight spaces is one-dimensional and has a natural basis vector which is for example provided by the stable envelope construction; in contrast, the zero weight space is nine-dimensional, and only has a natural decomposition as $\mathbb{C} \oplus \mathfrak{t}$, where we identify the Cartan subalgebra \mathfrak{t} of \mathfrak{e}_8 with its dual via the Killing form.

We start with the R-matrix provided in appendix C of [ZJ20]. We shall analyze it piece by piece. First there is the part living in the tensor square of the adjoint representation; with our choice (11) of normalization, and shifting the spectral parameter by $y \mapsto y - 10\hbar$ to match the difference of equivariant parameters, it is given diagrammatically by

$$(31) \quad \check{R}_{\text{ad}}(y) = \frac{6\hbar^2 y}{(\hbar - y)(5\hbar - y)(10\hbar - y)} \left(\begin{array}{c} \text{cup} \\ \text{cap} \end{array} \right) + \frac{6\hbar^2}{(\hbar - y)(5\hbar + y)} \left(\begin{array}{c} \text{cup} \\ \text{cap} \end{array} \right) \\ + \frac{\hbar}{\hbar - y} \left(\begin{array}{c} \text{trivalent vertex} \\ \text{trivalent vertex} \end{array} \right) + \frac{\hbar y}{(\hbar - y)(5\hbar - y)} \left(\begin{array}{c} \text{trivalent vertex} \\ \text{trivalent vertex} \end{array} \right) + \frac{y}{\hbar - y} \left(\begin{array}{c} \text{crossing} \\ \text{crossing} \end{array} \right)$$

These diagrams have the following meaning in our setting. The “cup” and “cap” are the Killing form and its inverse. The trivalent vertex is associated to the Lie bracket on \mathfrak{e}_8 . The crossing is the permutation of factors of the tensor product. We now provide their explicit expressions. Given two roots \vec{u} and \vec{v} , define the sign

$$\epsilon_{\vec{u}, \vec{v}} = \prod_{\substack{1 \leq i < j \leq 8 \\ \langle \vec{\alpha}_i, \vec{\alpha}_j \rangle = -1}} (-1)^{\langle \vec{\alpha}_i, \vec{u} \rangle \langle \vec{\alpha}_j, \vec{v} \rangle}$$

where the $\vec{\alpha}_i$ are the simple roots of \mathfrak{e}_8 . Note that it satisfies

$$\epsilon_{\vec{u}, \vec{v}} \epsilon_{\vec{v}, \vec{u}} = (-1)^{\langle \vec{u}, \vec{v} \rangle}$$

Given roots $\vec{u}, \vec{v}, \vec{w}$, we then have

$$\vec{u} \rightarrow \leftarrow \vec{v} = \delta_{\vec{u}+\vec{v}, 0} \epsilon_{\vec{u}, \vec{u}} \quad \begin{array}{c} \vec{u} \\ \swarrow \searrow \\ \vec{v} \end{array} \rightarrow \vec{w} = \delta_{\vec{u}+\vec{v}, \vec{w}} \epsilon_{\vec{u}, \vec{v}}$$

which also implies

$$\vec{u} \leftarrow \rightarrow \vec{v} = \delta_{\vec{u}+\vec{v}, 0} \epsilon_{\vec{u}, \vec{u}} \quad \begin{array}{c} \vec{u} \\ \swarrow \searrow \\ \vec{v} \end{array} \leftarrow \vec{w} = \delta_{\vec{u}+\vec{v}, \vec{w}} \epsilon_{\vec{v}, \vec{u}}$$

These can be plugged into the diagrams of (31), where all external lines are implicitly oriented downwards, resulting in

$$\left(\begin{array}{c} \vec{x} \\ \text{cup} \\ \vec{u} \end{array} \right) \left(\begin{array}{c} \vec{w} \\ \text{cap} \\ \vec{v} \end{array} \right) = \delta_{s,2} \quad \left(\begin{array}{c} \vec{x} \quad \vec{w} \\ \text{crossing} \\ \vec{u} \quad \vec{v} \end{array} \right) = \delta_{r,2} \quad \left(\begin{array}{c} \vec{x} \quad \vec{w} \\ \text{cup} \\ \vec{u} \quad \vec{v} \end{array} \right) = \delta_{t,2} \epsilon_{\vec{u}, \vec{u}} \epsilon_{\vec{w}, \vec{w}}$$

$$\left(\begin{array}{c} \vec{x} \quad \vec{w} \\ \text{trivalent vertex} \\ \vec{u} \quad \vec{v} \end{array} \right) = (\delta_{s,1} - \delta_{s,2} r) \epsilon_{\vec{u}, \vec{v}} \epsilon_{\vec{x}, \vec{w}} \quad \left(\begin{array}{c} \vec{x} \quad \vec{w} \\ \text{trivalent vertex} \\ \vec{u} \quad \vec{v} \end{array} \right) = (\delta_{r+s,1} - \delta_{r+s,0} r) \epsilon_{\vec{u}, \vec{v}} \epsilon_{\vec{x}, \vec{w}}$$

where we have defined as usual the scalar products $r = \langle \vec{u}, \vec{w} \rangle = \langle \vec{v}, \vec{x} \rangle$, $s = \langle \vec{u}, \vec{x} \rangle = \langle \vec{v}, \vec{w} \rangle$ and $t = \langle \vec{u}, \vec{v} \rangle = \langle \vec{w}, \vec{x} \rangle$ with $r = t - s + 2$.

It is convenient to switch to $q = -1$ now. It is not hard to see that it corresponds to twisting (in the same sense as in §3.5) with $\epsilon_{\cdot, \cdot}$; explicitly, multiplying the above by $\epsilon_{\vec{u}, \vec{v}} \epsilon_{\vec{x}, \vec{w}}$ results in

$$\begin{array}{ccc}
 \begin{array}{c} \vec{x} \\ \curvearrowright \\ \vec{u} \end{array} & \begin{array}{c} \vec{w} \\ \curvearrowleft \\ \vec{v} \end{array} & = \delta_{s,2} \\
 \begin{array}{c} \vec{x} \quad \vec{w} \\ \diagdown \quad \diagup \\ \vec{u} \quad \vec{v} \end{array} & & = \delta_{r,2} (-1)^s \\
 \begin{array}{c} \vec{x} \quad \vec{w} \\ \curvearrowright \quad \curvearrowleft \\ \vec{u} \quad \vec{v} \end{array} & & = \delta_{t,2} \\
 \\
 \begin{array}{c} \vec{x} \quad \vec{w} \\ \diagdown \quad \diagup \\ \text{---} \\ \diagup \quad \diagdown \\ \vec{u} \quad \vec{v} \end{array} & & = \delta_{s,1} - \delta_{s,2} r \\
 \begin{array}{c} \vec{x} \quad \vec{w} \\ \diagdown \quad \diagup \\ \text{---} \\ \diagup \quad \diagdown \\ \vec{u} \quad \vec{v} \end{array} & & = \delta_{r+s,1} - \delta_{r+s,0} r
 \end{array}$$

If all weight vectors $\vec{u}, \vec{v}, \vec{w}, \vec{x}$ are nonzero, there is no contribution from the trivial subrepresentation, and summing the diagrams above results in the following table:

(32)

$s \setminus t$	$-1 - a$	-1	$-1 + a$	$-1 + 2a$	$-1 + 3a$
$-1 - a$	$-\frac{4\hbar+y}{5\hbar+y}$				
-1	$\frac{\hbar}{5\hbar+y}$	1			
$-1 + a$	$\frac{6\hbar^2}{(\hbar-y)(5\hbar+y)}$	$\frac{\hbar}{\hbar-y}$	$\frac{y}{\hbar-y}$		
$-1 + 2a$	$\frac{\hbar^2(55\hbar-y)}{(\hbar-y)(5\hbar-y)(5\hbar+y)}$	$\frac{5\hbar^2}{(\hbar-y)(5\hbar-y)}$	$\frac{\hbar y}{(\hbar-y)(5\hbar-y)}$	$-\frac{y(4\hbar-y)}{(\hbar-y)(5\hbar-y)}$	0
$-1 + 3a$	$\frac{2\hbar^2(400\hbar^2-5\hbar y+y^2)}{(\hbar-y)(5\hbar-y)(5\hbar+y)(10\hbar-y)}$	$\frac{\hbar^2(50\hbar+y)}{(\hbar-y)(5\hbar-y)(10\hbar-y)}$	$\frac{6\hbar^2 y}{(\hbar-y)(5\hbar-y)(10\hbar-y)}$	$-\frac{\hbar y(4\hbar-y)}{(\hbar-y)(5\hbar-y)(10\hbar-y)}$	$\frac{y(4\hbar-y)(9\hbar-y)}{(\hbar-y)(5\hbar-y)(10\hbar-y)}$

where as usual $s = \langle \vec{u}, \vec{x} \rangle$, $t = \langle \vec{u}, \vec{v} \rangle$.

Some comments are in order. Firstly, as we shall see shortly when we discuss triangles, the first (resp. second) column corresponds to rhombi which nonequivariantly can be split as two triangles, with zero (resp. nonzero) weight diagonal.

Secondly, comparing the table above the one in the previous section for $d \leq 3$, we notice that the latter, namely (30), is *not* a subtable of the former, (32). In fact, the functoriality of [KZJ17, §2.2] does not apply at $d = 4$; this can be traced back to the fact that the inclusion $X_{2(d-1)} \subset X_{2d}$, which was implicitly respected in the construction of [KZJ17] for $d \leq 3$, cannot be respected at $d = 4$. See C.1 for an example of a 3-step problem that has a different puzzle solution at $d = 4$.

The case where some weight vectors are zero can be treated similarly. One needs to make a choice of basis of the zero weight space (i.e., the Cartan subalgebra); for example,

in the basis of simple (co)roots h_i and its dual basis h^i of fundamental weights,¹⁰ one has $h_i \rightarrow \leftarrow h_j = C_{i,j}$ and therefore $h^i \leftarrow \rightarrow h^j = C^{i,j}$ (where $C_{i,j}$ is the Cartan matrix, and

$C^{i,j}$ its inverse). One then has $\begin{array}{c} h_i \\ \swarrow \quad \searrow \\ \vec{v} \\ \swarrow \quad \searrow \\ \vec{u} \end{array} = \delta_{\vec{u},\vec{v}} u_i = \delta_{\vec{u},\vec{v}} C_{i,j} u^j$, $\begin{array}{c} h^i \\ \swarrow \quad \searrow \\ \vec{v} \\ \swarrow \quad \searrow \\ \vec{u} \end{array} = -\delta_{\vec{u},\vec{v}} C^{i,j} u_j = -\delta_{\vec{u},\vec{v}} u^i$ (and the opposite if one switches h_i and \vec{u}), where $\vec{u} = \sum_i u_i h^i = \sum_i u^i h_i$. Trivalent vertices involving two or three h s are zero.

These rules allow to compute the fugacity of any rhombus. For example, if one of the four weights is zero, say \vec{v} , and the basis vector there is h_i , then the last two terms of \check{R} contribute, with coefficients $-w_i \delta_{\vec{u},\vec{w}+\vec{x}}$ and $-u_i \delta_{\vec{u},\vec{w}+\vec{x}}$ respectively.

Finally, we need to include the contribution of the trivial representation; this is given by [ZJ20]

$$\begin{aligned} \check{R}_{\text{rest}} = & \frac{60\hbar^3}{(\hbar-y)(5\hbar-y)(10\hbar-y)} \left(\begin{array}{c} \cdot \\ \cdot \\ \cdot \end{array} + \begin{array}{c} \cdot \\ \cdot \\ \cdot \end{array} \right) \\ & + \frac{(6\hbar-y)(\hbar+y)}{(\hbar-y)(5\hbar-y)} \left(\begin{array}{c} \cdot \\ \cdot \end{array} + \begin{array}{c} \cdot \\ \cdot \end{array} \right) \\ & + \frac{60\hbar^3}{(\hbar-y)(5\hbar-y)(5\hbar+y)} \left(\begin{array}{c} \cdot \\ \cdot \end{array} + \begin{array}{c} \cdot \\ \cdot \end{array} \right) \\ & + \frac{\sqrt{30}\hbar^2}{(\hbar-y)(5\hbar-y)} \left(\begin{array}{c} \cdot \\ \cdot \end{array} + \begin{array}{c} \cdot \\ \cdot \end{array} + \begin{array}{c} \cdot \\ \cdot \end{array} + \begin{array}{c} \cdot \\ \cdot \end{array} \right) \\ & + \frac{(11\hbar-y)(4\hbar-y)(5\hbar+y)y + 60\hbar^3(20\hbar+y)}{(\hbar-y)(5\hbar-y)(10\hbar-y)(5\hbar+y)} \begin{array}{c} \cdot \\ \cdot \end{array} \end{aligned}$$

where the isolated dots correspond to trivial representations. The graphical rules are the same as before.

We discuss triangles now. At $x = 0$, in accordance with lemma 3.3, the R-matrix factorizes as a product of two trilinear operators. At $q = -1$ these two operators are in fact

¹⁰Elsewhere in the paper, fundamental weights are denoted $\vec{\omega}_i$, but the notation cannot be used here since we already label edges using weights, and here we want to think of the fundamental weights as forming a basis of the Cartan subalgebra.

identical up to the orientation of the lines; we have

$$U = \begin{array}{c} \diagup \\ | \\ \diagdown \end{array} + \sqrt{6/5} \left(\begin{array}{c} \text{---} \\ \cdot \end{array} + \begin{array}{c} \text{---} \\ \cdot \end{array} \right) + 2\sqrt{6/5} \begin{array}{c} \cdot \\ \cdot \end{array}$$

(all lines pointing downwards) and D its 180° rotation with orientation reversed.

Finally, this allows us to give a relatively simple *nonequivariant* cohomology rule at $d = 4$. Instead of breaking a puzzle along all edges into triangles, and multiplying the fugacities of these triangles (which depend on the choice of basis of the weight zero space), we break only along non-zero-weight edges (whose singleton bases are canonical). The resulting triangles have fugacity 1 and can be discarded; we just need give a formula for the fugacities of the larger regions (now independent of the choice of basis of the weight zero space), which we then multiply together to give that of the puzzle.

Proposition 5.2. *Nonequivariant $d = 4$ puzzles can be described as follows. Their boundaries form d -ary strings encoded as roots of ϵ_8 , as in the general setup of §3.3. Their insides (i.e., the internal edges in the underlying triangular lattice) are labeled in all possible ways with weights (i.e., roots, or zero) in such a way that weight conservation is satisfied at each elementary triangle. To compute their fugacity, one considers separately each connected component of the subgraph of the dual of the puzzle made of zero weight edges. This graph can only have 3-valent vertices or 1-valent vertices (endpoints). For each component, one sums over all possible sets of nonintersecting paths connecting pairs of endpoints (unpaired endpoints are allowed) the fugacity*

$$(6/5)^{\frac{1}{2}\#\{\text{vertices with some empty edges}\}} \prod_{\text{paired endpoints } p \text{ and } q} (-\text{weight}(p), \text{weight}(q))$$

where an empty edge is an edge not traversed by a path, and the weight of an endpoint is conventionally the weight of the edge counterclockwise from its zero weight edge. The fugacity of the puzzle is then the product of fugacities of these connected components.

The statement is just a reformulation of the expression for U and D above, and we skip the details of the proof.

Remark. Note that the rule is independent of the parameter \hbar , by homogeneity.

Example 5.3. *The simplest situation is when a single edge has zero weight, i.e.,*

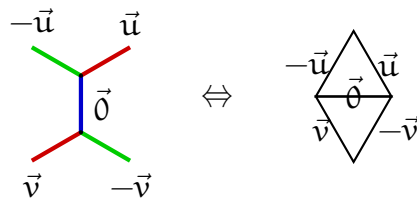

or its 120° rotations. There can be either a path or none, so that the fugacity is

$$\begin{array}{c} -\vec{u} \\ \diagup \\ \vec{0} \\ \diagdown \\ \vec{v} \end{array} = \frac{6}{5} - \langle \vec{u}, \vec{v} \rangle \quad \vec{u}, \vec{v} \neq \vec{0}$$

We reach the important conclusion that fugacities may not only be rational numbers, but also negative: $6/5 - \langle \vec{u}, \vec{v} \rangle \in \{-4/5, 1/5, 6/5, 11/5, 16/5\}$ (this is also the first column of (32) at $y = 0$).

See Appendix C.2 for a full example involving such a zero weight situation. The next simplest situation is a vertex with only zero weights:

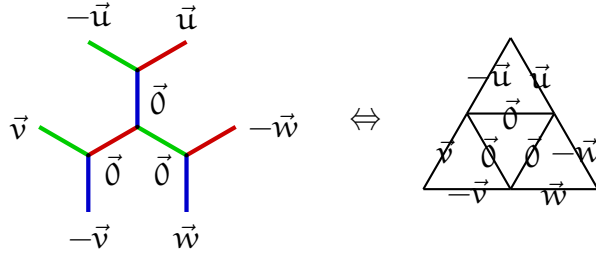

There can be either no path, or a single path connecting any two of the outermost vertices:

$$\begin{array}{c} \vec{v} \\ \vec{u} \\ \vec{w} \end{array} \triangleq \begin{array}{c} \vec{u} \\ \vec{v} \\ \vec{w} \end{array} = 2(6/5)^2 - 6/5(\langle \vec{u}, \vec{v} \rangle + \langle \vec{v}, \vec{w} \rangle + \langle \vec{w}, \vec{u} \rangle) \quad \vec{u}, \vec{v}, \vec{w} \neq \vec{0}$$

5.5. An interpretation of the nonequivariant-cohomology puzzle rule. In the previous sections we have provided explicit expressions for puzzle pieces computing products of SSM classes both equivariantly (in H_{\uparrow}^{*loc}) and “nonequivariantly” (in $H_{\mathbb{C}^{\times}}^{*loc}$). In the latter case, there is a particularly appealing geometric interpretation of the structure constants.¹¹

Theorem 5.4. Consider three Schubert cells $gX_0^{\lambda}, g'X_0^{\mu}, g''X_0^{\nu}$ in general position in a d -step flag variety $P \setminus G$ for $d \leq 4$. Then the Euler characteristic¹² χ_c of their intersection is given by

$$\chi_c(gX_0^{\lambda} \cap g'X_0^{\mu} \cap g''X_0^{\nu}) = (-1)^{\delta} \begin{array}{c} \lambda \\ \mu \\ \nu \end{array} = (-1)^{\delta} \sum_{\substack{\text{nonequivariant} \\ \text{puzzles } P \text{ with} \\ \text{sides } \lambda, \mu, \nu \\ \text{read clockwise}}} fug(P)$$

where $\overleftarrow{\nu} = (\nu_n, \dots, \nu_1)$, $\delta = \dim(P \setminus G) - (\ell(\lambda) + \ell(\mu) + \ell(\nu))$, and the contribution $fug(P)$ of each puzzle is simply 1 for $d \leq 3$, and given by proposition 5.2 for $d = 4$. (For $d > 4$ one still enjoys the equation relating Euler characteristics and SSM structure constants $c_{\lambda\mu}^{\overleftarrow{\nu}}$, but has no puzzles with which to compute the latter.)

In the simpler version with Schubert classes $\{[X^{\lambda}]\}$, this 3-fold symmetric calculation computes the number of points in the triple intersection when finite, and gives 0 when infinite. That simpler statement is based on the dual-basis statement

$$\int_{P \setminus G} [X^{\lambda}][X^{\mu}] = \delta_{\lambda, \overleftarrow{\mu}}$$

¹¹We thank L. Mihalcea for pointing out and explaining [Sch17] to us.

¹²It is slightly more natural to think in terms of “compactly supported Euler characteristic”, but the real reason we use the notation χ_c is to distinguish from the Coxeter elements χ mentioned later.

of the Schubert basis. The corresponding statement for us is (combining the cohomology limit of (10) and the nonequivariant version of (28))

$$\delta_{\lambda, \overleftarrow{\mu}} = \int_{T^*(P_- \setminus G)} \text{St}^\lambda \text{St}^\mu = \int_{P_- \setminus G} \text{St}^\lambda \text{St}^\mu \frac{1}{e_{\mathbb{C}^\times}(T^*(P_- \setminus G))} = \int_{P_- \setminus G} \text{St}^\lambda \text{S}^\mu$$

where the first integral is defined using AB/BV equivariant localization. In particular,

$$\alpha = \sum_{\nu} c_{\nu} \text{S}^{\nu} \iff c_{\nu} = \int_{P_- \setminus G} \alpha \text{St}^{\overleftarrow{\nu}} \quad \forall \nu$$

hence

$$(33) \quad c_{\lambda \overleftarrow{\mu}}^{\overleftarrow{\nu}} = \int_{P_- \setminus G} \text{S}^{\lambda} \text{S}^{\mu} \text{St}^{\nu} = \int_{P_- \setminus G} \text{St}^{\lambda} \text{St}^{\mu} \text{St}^{\nu} / e(T^*M)^2$$

The proof of theorem 5.4 is based on two properties of the *Chern–Schwartz–MacPherson* natural transformation $\text{csm} : \{\text{constructible functions on } M\} \rightarrow H_*(M)$, although we will work in cohomology $H^*(M)$. We recall a little of this theory here, primarily to provide pegs on which to hang the sign conventions that one need grapple with in comparing CSM classes with our SSM classes. The first key property of this natural transformation, suggesting its utility for the statement above, is that $\int_M \text{csm}(1_A) = \chi_c(A)$ for $A \subseteq M$ a locally closed subvariety of a proper smooth variety M .

Every constructible function on M is (nonuniquely) a linear combination of characteristic functions 1_A of locally closed submanifolds of M . In [Gin86] is given a formula for these $\text{csm}(1_A)$, using the class $[\text{cc}(\mathcal{O}_A)] \in H_{\mathbb{C}^\times}^*(T^*M) \cong H_{\mathbb{C}^\times}^*(M) \cong H^*(M)[\hbar]$ of the characteristic cycle of the \mathcal{D}_M -module \mathcal{O}_A , namely

$$\text{csm}(1_A) = (-1)^{\dim A} [\text{cc}(\mathcal{O}_A)] |_{\hbar \mapsto -1}$$

The dehomogenization $\hbar \mapsto -1$ is not so important, but the $(-1)^{\dim_M A}$ is crucial in order to make the CSM class independent of the expansion into characteristic functions, and more generally, to make the natural transformation additive. (The sign on \hbar then serves to make $\text{csm}(1_A) = +[\overline{A}]$, up to higher degree terms in cohomology.) Essentially, an Euler characteristic computation (not in topology – rather, of a Grothendieck–Cousin complex of \mathcal{D} -modules) is equipped with signs in order to become simply a *sum* rather than its more usual alternating sum. One effect of these signs is that when $A = M$, the class $\text{csm}(1_A)$ is the total Chern class of the *tangent* bundle of M , despite its derivation from the dilation-equivariant Euler class of the *cotangent* bundle.

For a small example, taking $\iota : \mathbb{C}P^1 \hookrightarrow T^*\mathbb{C}P^1$ to be the inclusion of the zero section, consider

A	$\mathbb{C}P^1$	$\{\infty\}$	\mathbb{C}
$\dim A$	1	0	1
$\text{cc}(\mathcal{O}_A)$	$\iota(\mathbb{C}P^1)$	T_∞^*	$\iota(\mathbb{C}P^1) \cup T_\infty^*$
$\iota^*([\text{cc}(\mathcal{O}_A)])$	$\hbar[\mathbb{C}P^1] - 2[\text{pt}]$	$[\text{pt}]$	$\hbar[\mathbb{C}P^1] - [\text{pt}]$
$\text{csm}(1_A)$	$[\mathbb{C}P^1] + 2[\text{pt}]$	$[\text{pt}]$	$[\mathbb{C}P^1] + [\text{pt}]$

verifying the additivity $\text{csm}(1_{\mathbb{C}P^1}) = \text{csm}(1_\infty) + \text{csm}(1_{\mathbb{C}^1})$, despite the geometric equality $[\text{cc}(\mathcal{O}_{\mathbb{C}P^1})] = [\text{cc}(\mathcal{O}_{\mathbb{C}^1})] - [\text{cc}(\mathcal{O}_\infty)]$ derivable from the Grothendieck–Cousin complex.

Lemma 5.5. *Let M be a smooth compact complex variety, and A, B two locally closed smooth subvarieties, such that their closures $\overline{A}, \overline{B}$ are “stratified-transverse”, i.e. each stratum in \overline{A} is*

transverse to each one in \overline{B} . Then

$$[\text{cc}(\mathcal{O}_A)] [\text{cc}(\mathcal{O}_B)] = [\text{cc}(\mathcal{O}_{A \cap B})] [M \subseteq T^*M]$$

as elements of $H_{\mathbb{C}^\times}^*(T^*M)$. If we pull these classes back to the base, $[M \subseteq T^*M]$ becomes the Euler class $e(T^*M)$.

Proof. Since every term is homogeneous (of, in fact, the same degree $\dim_{\mathbb{R}} M$) it suffices to prove the specialization at $\hbar = -1$. After canceling signs, the equation becomes

$$\text{csm}(1_A) \text{csm}(1_B) = \text{csm}(1_{A \cap B}) c(TM)$$

which is [AMSS17, theorem 10.5]. (Being able to quote this lemma is the other reason, besides the connection to Euler characteristics, that we need the connection to CSM classes.) \square

Proof of theorem 5.4. In the case at hand, the ambient manifold M is the flag manifold $P_- \backslash G$, the submanifold A is the Bruhat cell $X_\circ^\lambda := P_- \backslash P_- \lambda B_+$, and its $[\text{cc}(\mathcal{O}_A)]$ is the stable basis element St^λ from §2.5. One reference for this connection is [AMSS17].

Using Kleiman transversality (finitely many times), we pick g, g' generic enough that the stratified varieties $gX^\lambda, g'X^{\lambda'}$ are stratified-transverse, i.e. each B_+ -orbit in X^λ has been moved to be transverse to each B_+ -orbit in $X^{\lambda'}$. Then we pick g'' generic enough so that $g''X^{\lambda''}$ is stratified-transverse to $gX^\lambda \cap g'X^{\lambda'}$. In each case, the dilation-equivariant homology class of the characteristic cycle is unaffected by moving the Bruhat cell using these g, g', g'' .

We have all the pieces in place:

$$\begin{aligned} c_{\lambda\mu}^{\overline{\vee}} &= \int_{P_- \backslash G} \text{St}^\lambda \text{St}^\mu \text{St}^\nu / e(T^*M)^2 && \text{from (33)} \\ &= \int_{P_- \backslash G} [\text{cc}(\mathcal{O}_{X_\circ^\lambda})] [\text{cc}(\mathcal{O}_{X_\circ^\mu})] [\text{cc}(\mathcal{O}_{X_\circ^\nu})] / e(T^*M)^2 \\ &= \int_{P_- \backslash G} [\text{cc}(\mathcal{O}_{gX_\circ^\lambda})] [\text{cc}(\mathcal{O}_{g'X_\circ^\mu})] [\text{cc}(\mathcal{O}_{g''X_\circ^\nu})] / e(T^*M)^2 \\ &= \int_{P_- \backslash G} [\text{cc}(\mathcal{O}_{gX_\circ^\lambda \cap g'X_\circ^\mu \cap g''X_\circ^\nu})] e(T^*M)^2 / e(T^*M)^2 && \text{from lemma 5.5, twice} \\ \mapsto & \int_{P_- \backslash G} (-1)^{\dim(gX_\circ^\lambda \cap g'X_\circ^\mu \cap g''X_\circ^\nu)} \text{csm}(gX_\circ^\lambda \cap g'X_\circ^\mu \cap g''X_\circ^\nu) && \text{setting } \hbar \rightarrow -1 \\ &= (-1)^\delta \chi_c(gX_\circ^\lambda \cap g'X_\circ^\mu \cap g''X_\circ^\nu) && \square \end{aligned}$$

Corollary 5.6. *At $d \leq 3$, the sign of $\chi_c(gX_\circ^\lambda \cap g'X_\circ^\mu \cap g''X_\circ^\nu)$ (if nonzero) is $(-1)^{\dim(P_- \backslash G) - (\ell(\lambda) + \ell(\mu) + \ell(\nu))}$.*

This is one of those rare situations where positivity in (generalized) Schubert calculus was discovered through explicit formula before being given a geometric proof (others being Lesieur's observation that the Littlewood-Richardson rule computes Grassmannian Schubert calculus decades before Kleiman transversality, and [Buc02] antedating [Bri02]). Since releasing this paper, a geometric proof has been found that applies to all G/P [SSW23].

Example 5.7. *Consider the case $\lambda = \mu = \nu = 0101$, where the Bruhat cell w.r.t. a flag F^\bullet is*

$$\begin{aligned} X_\circ^{0101}(F) &= X^{0101} \setminus (X^{0110} \cup X^{1001}) \\ &= \{V \in \text{Gr}(2, 4) : \dim(V \cap F^2) \geq 1\} \setminus (\{V : V \geq F^1\} \cup \{V : V \leq F^3\}) \end{aligned}$$

If we take $F^\bullet, G^\bullet, H^\bullet$ generic flags, then by dimension count $X_\circ^{0101}(F) \cap X_\circ^{0101}(G) \cap X_\circ^{0101}(H)$ is a curve. By Kleiman–Bertini it is normal, hence smooth. Using K-theory puzzles one can determine

it to be arithmetic genus 0. Since we want however to intersect the open cells X_{\circ}^{0101} , we need to rip out the points

$$X^{0101}(F) \cap X^{0101}(G) \cap X^{0110}(H) \quad X^{0101}(F) \cap X^{0101}(G) \cap X^{1001}(H) \quad X^{0101}(F) \cap X^{0110}(G) \cap X^{0101}(H)$$

$$X^{0101}(F) \cap X^{1001}(G) \cap X^{0101}(H) \quad X^{1001}(F) \cap X^{0101}(G) \cap X^{0101}(H) \quad X^{0110}(F) \cap X^{0101}(G) \cap X^{0101}(H)$$

where the underlining points out the superscript changed from 0101. Hence $X_{\circ}^{0101}(F) \cap X_{\circ}^{0101}(G) \cap X_{\circ}^{0101}(H)$ is \mathbb{P}^1 minus 6 points, with $\chi_c = -4$. The four relevant puzzles are these:

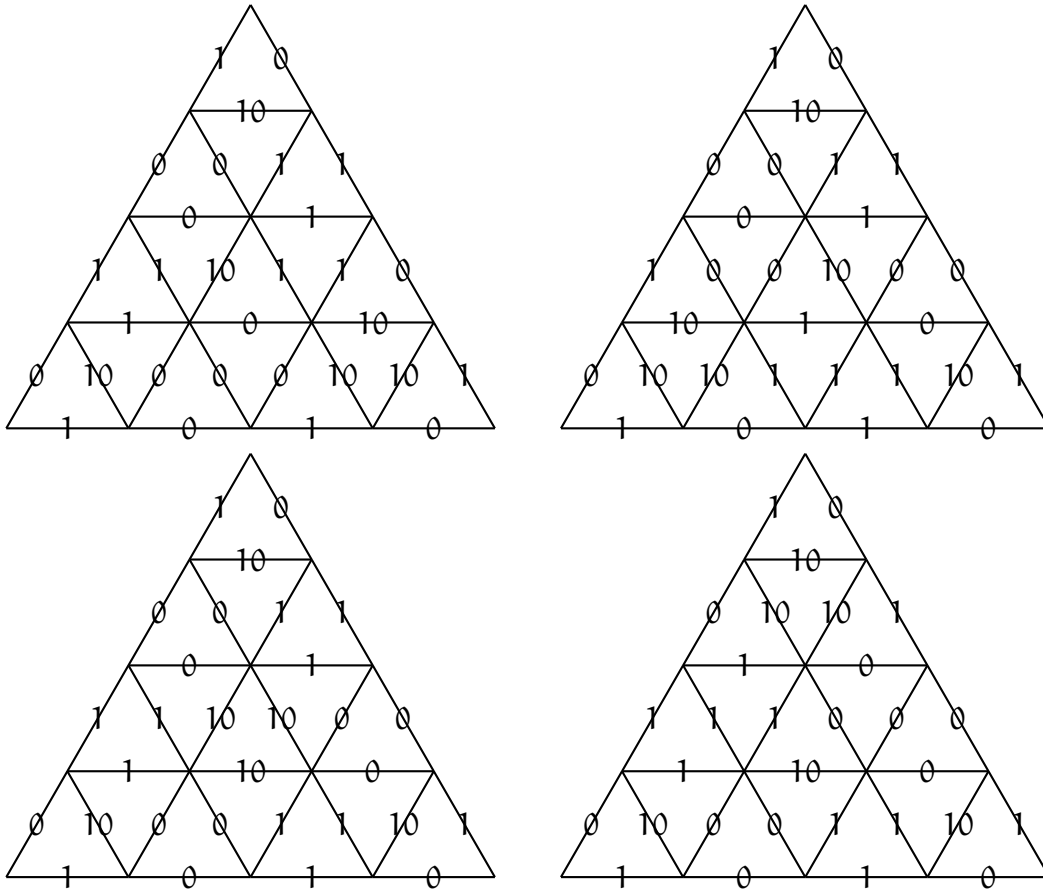

Example 5.8. The geometry of $X_{\circ}^{0101}(F) \cap X_{\circ}^{0101}(G) \cap X_{\circ}^{0011}(H)$ is more complicated, but still approachable. We list the triples $\lambda \geq 0101, \mu \geq 0101, \nu \geq 0011$ such that $X^{\lambda}(F) \cap X^{\mu}(G) \cap X^{\nu}(H)$ intersect:

λ	0101	1001	0110	0101	0101	0101
μ	0101	0101	0101	0110	1001	0101
ν	0011	0011	0011	0011	0011	0101
\cap	$\mathbb{P}^1 \times \mathbb{P}^1$	A	B	C	D	E

where $A \cong B \cong C \cong D \cong E \cong \mathbb{P}^1$, and point intersections

λ	1010	0101	0110	1001	1001	0110	0101	0101
μ	0101	1010	1001	0110	0101	0101	0110	1001
ν	0011	0011	0011	0011	0101	0101	0101	0101
\cap	$A \cap B$	$C \cap D$	$B \cap D$	$A \cap C$	$A \cap E$	$B \cap E$	$C \cap E$	$D \cap E$

(note that $A \cap D = B \cap C = \emptyset$) giving $\chi_c = \chi_c(\mathbb{P}^1 \times \mathbb{P}^1) - 5\chi_c(\mathbb{P}^1) + 8\chi_c(\text{pt}) = 4 - 10 + 8 = 2$. The two puzzles are these:

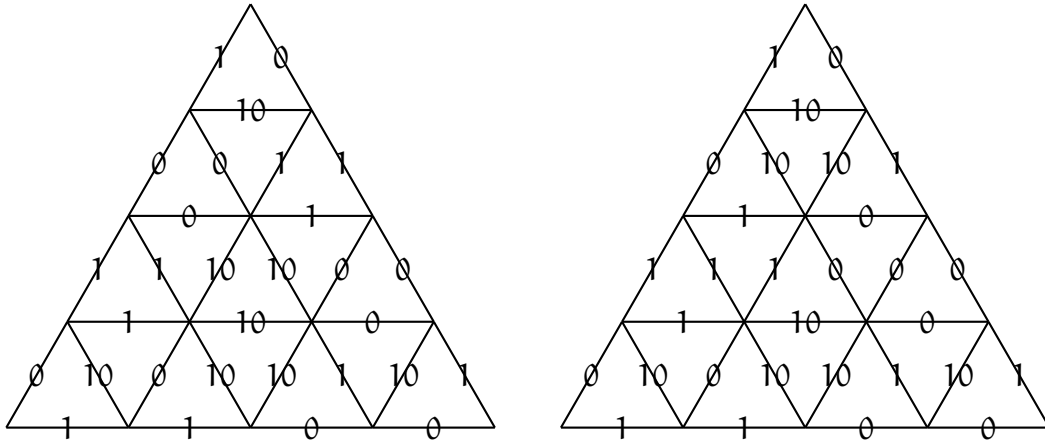

As mentioned in the proof, in the special case $\delta = 0$, or $\ell(\lambda) + \ell(\mu) + \ell(\nu) = \dim(P_- \backslash G)$, Theorem 5.4 reduces to ordinary Schubert calculus, i.e., counting points in the intersection of three Schubert varieties in general position. In fact, for $d \leq 3$, the puzzles of theorem 5.4 reduce to ordinary puzzles as formulated in e.g. [KZJ17]. The reason is that triangles at $d \leq 3$ can only have nonnegative inversion charge, which means that for $\ell(\lambda) + \ell(\mu) + \ell(\nu) = \dim(P_- \backslash G)$ to hold, the triangles with positive inversion charge cannot occur, and excluding them exactly turns our puzzles into ordinary puzzles. In contradistinction, at $d = 4$, triangles of both positive and negative charge exist, so no simplification occurs in the case of ordinary Schubert calculus (furthermore, as already pointed out in the previous section, the rule is nonpositive).

If $\ell(\lambda) + \ell(\mu) + \ell(\nu) > \dim(P_- \backslash G)$, theorem 5.4 implies that the structure constant, i.e., $\sum_P \text{fug}(P)$, is zero. Because of nonpositivity at $d = 4$, this does not imply that there aren't any puzzles with such boundaries; see appendix C.3 for a counterexample.

Finally, if one considers the $q \mapsto 1$ specialization instead of $q \mapsto -1$, some puzzle pieces at $d \leq 3$ acquire fugacity -1 (which is why we usually don't), making each $\text{fug}(P) = (-1)^\delta$. In that sense, the formula becomes simpler, as the prefactor has been absorbed.

6. POSITIVITY

Recall from §1.3 that a **positivity notion** in Schubert calculus is a submonoid M (under $+$) of the coefficient ring (either the cohomology of a point, or a localization thereof) s.t. $M \cap -M = 0$.

While it is frequently required that M be closed under multiplication as well as addition, there are sometimes stronger positivity statements to be made when this is not done. For example Graham positivity [Gra01], in which M is any sum of products of simple roots, can be tightened up to sums of products of *distinct positive* roots. (This follows from a careful reading of Graham's original proof. Note too that the formulæ in [KT03, KZJ17] for Schubert structure constants in $H_T^*(\text{Gr}(k, n))$ and $H_T^*(\text{Fl}(j, k; n))$ are manifestly M -positive for this tighter M .) [this whole paragraph should be moved

We now show that our main theorem 3.8 provides a *positive* product rule up to $d = 2$ equivariantly, and up to $d = 3$ nonequivariantly.

6.1. Positivity in equivariant K-theory. The explicit entries of the R -matrices involved in theorem 3.8 are given in §4.1 at $d = 1$ and in [KZJ17, appendix A] at $d = 2$.

We introduce the following

Lemma 6.1. *Let M be the set of sums of products of factors*

$$-q^\pm \quad z^\pm \quad \frac{1-q^2}{1-q^2z} \quad \frac{z-1}{1-q^2z}$$

where z varies over distinct z_j/z_i , $i < j$. Then M is a positivity notion, i.e. $M \cap -M = 0$.

Proof. If we specialize to $z_i = 2^i$, $q = -2^{-n/2}$, then every factor is a positive real number. \square

For $d = 1, 2$, by inspection, any nonzero R-matrix entry can be expressed as a product of the factors of lemma 6.1 only. We conclude that our puzzle rule for equivariant motivic Chern class is positive for $d = 1, 2$.

It seems impossible to find such an elementary proof of positivity at $d = 3$. This is in line with the fact that in [KZJ17], we were unable to provide a $d = 3$ equivariant rule in ordinary Schubert calculus. It is not obvious to find an explicit counter-example to positivity, so the issue remains open.

We do not expect any positivity in $d = 4$ equivariant K-theory.

6.2. Positivity in equivariant cohomology. The exact same statements hold in cohomology:

Lemma 6.2. *Let M be the set of sums of products of factors*

$$\frac{\hbar}{\hbar - y} \quad \frac{y}{\hbar - y}$$

where y varies over distinct $y_j - y_i$, $i < j$. Then M is a positivity notion, i.e. $M \cap -M = 0$.

Proof. Specialize at $y_i = i$, $\hbar = n$. \square

The nonzero entries of the rational R-matrices for $d = 1, 2$ are precisely one of the two factors of lemma 6.2. We conclude that our puzzle rule for equivariant SSM classes is positive for $d = 1, 2$.

6.3. Positivity in nonequivariant K-theory and cohomology. In nonequivariant K-theory, one can easily check that $d \leq 3$ rules only involve nonzero fugacities that are powers of $-q$, so positivity follows immediately for our rule for nonequivariant motivic Chern classes for $d = 1, 2, 3$.

In particular, as pointed out in theorem 5.4, the fugacity of nonequivariant puzzles for SSM classes is just 1, making the positivity statement trivial.

As already discussed in §5.4, the $d = 4$ cohomology puzzle rule is not positive, cf §C.3 for an example of puzzles whose sum of fugacities equals zero. The same puzzles also provide a counter-example to positivity in $d = 4$ nonequivariant K-theory.

7. A COUPLE OF RESULTS ON NAKAJIMA QUIVER VARIETIES

7.1. The varieties. A Nakajima quiver variety $\mathcal{M}_1(w, v, \theta)$ depends on five data (see e.g. [Gin12]):

- a quiver (directed graph) I of “gauge vertices” $\{\alpha_i\}$ spanning a lattice called \mathfrak{t}^* , to each of which we attach a “framed vertex” of degree 1, giving the dual basis in \mathfrak{t} ,
- a “dimension vector” (\mathbb{N} -valued) $w = (w^i)$ on the framing vertices,
- a similar dimension vector $v = (v^i)$ on the gauged vertices,
- the “complex moment” $\theta_{\mathbb{C}} \in \mathbb{C} \otimes \mathfrak{t}$ that will be zero (hence ignored) until §8, and

- the “stability vector” $\theta \in \mathbb{R} \otimes \mathfrak{t}$ we only partly explain below.

The points in $\mathcal{M}_I(w, v, \theta)$ index certain equivalence classes of representations of the (doubled) Nakajima quiver. Specifically, the representations satisfy a closed “moment map” condition at the gauged vertices, and an open “stability” condition depending on θ . We won’t detail these conditions (punting, again, to [Gin12]) but summarize what we need about them here.

Write $\vec{\alpha}_i \in \mathfrak{t}^*$ for the basis vector corresponding to the gauge vertex α_i . Call the stability vector θ **positive** if $\langle \theta, \vec{\alpha}_i \rangle > 0$ for all $\vec{\alpha}_i$, and just **v-positive** if $\langle \theta, \vec{\alpha}_i \rangle > 0$ for those $\vec{\alpha}_i$ with coefficient $v^i \neq 0$ (a generalization of (3.2.2) from [Gin12]). The θ s we use will always be v-positive, in which case we omit θ from the notation. The quiver will eventually be one of four Dynkin diagrams X_{2d} , $d = 1, \dots, 4$, and will similarly be suppressed in the notation, $\mathcal{M}(w, v)$. Since each X_{2d} is ADE, we can identify \mathfrak{t}^* with the corresponding root lattice, and make reference to fundamental weights $\vec{\omega}_i \in \mathbb{Q} \otimes \mathfrak{t}^*$.

Call (w, v) of **flag type** if $w^i \neq 0$ at only one vertex \boxed{c} , and (v^i) is supported on a type A_d subdiagram S of I with \boxed{c} attached to one end of S , which we call its **head**. For examples, see the first quiver in each of figures 1-4.

- Proposition 7.1.** (1) [Gin12, Lemma 3.2.3(i)] *If θ is v-positive, then a representation is θ -stable iff it contains no subrepresentations supported on the gauged vertices.*
- (2) [Nak94, §7] *If (w, v) is of flag type and θ is v-positive, then $\mathcal{M}_I(w, v, \theta)$ is isomorphic to the cotangent bundle of a d-step flag variety. If S is oriented toward its head, then the steps are given by $(v^i, i \in S)$.*
- (3) *Assume Q ’s underlying graph is an ADE Dynkin diagram. With w fixed and θ positive, the set of vectors v with $M_Q(w, v, \theta) \neq \emptyset$ forms the lattice points in a polytope $P(w)$ with integral vertices.*

Proof. For both (1) and (2), observe that the quiver variety is unchanged if we throw away all vertices $\alpha \in I$ with $v_i = 0$, then follow the stated references.

For (3), since I is ADE, it has an associated simply-laced Lie algebra \mathfrak{g}_I . We use [Nak94, Theorem 10.16] to observe that $M_I(w, v, \theta) \neq \emptyset$ iff a certain \mathfrak{g}_I -irrep determined by w has a nonzero weight space, weight determined by v . Then the result is standard from representation theory, e.g. see [GLS96]. □

We start with $d = 1$ in figure 1, where conveniently we need only consider (w, v) of flag type, and three of the varieties are

$$\begin{array}{c} \boxed{n} \\ | \\ \textcircled{j} - \textcircled{0} \end{array} \cong \begin{array}{c} \boxed{n} \\ | \\ \textcircled{n} - \textcircled{j} \end{array} \cong \begin{array}{c} \boxed{n} \\ | \\ \textcircled{j} - \textcircled{j} \end{array} \cong T^* \text{Gr}(j, n)$$

In each of $d = 2, 3, 4$ (figures 2–4) we will need several (w, v) that are *not* of flag type, but whose quiver varieties are nonetheless isomorphic to cotangent bundles of d-step flag varieties. To verify these isomorphisms, we will use the following proposition.

- Proposition 7.2.** (1) [Nak03] *Let $\pi \in W$, and define v' by*

$$\pi \cdot \left(\sum_i w^i \vec{\omega}_i - \sum_i v^i \vec{\alpha}_i \right) = \sum_i w^i \vec{\omega}_i - \sum_i v'^i \vec{\alpha}_i.$$

Then $\mathcal{M}_I(w, v', \pi \cdot \theta) \cong \mathcal{M}_I(w, v, \theta)$ as complex varieties, equivariantly w.r.t. the framing group action $\prod_{i \in I} \text{GL}(w^i)$ on both sides.

To calculate v' from v when $\pi = r_{\vec{\alpha}_i}$, one replaces the $\vec{\alpha}_i$ label v^i by the sum of all adjacent labels including labels on framed vertices, minus the original label v^i .

(2) Fix $\pi \in W$, and let w, v, v', S be as in (1). Assume that $\pi \cdot \theta$ is positive. Assume that (w, v) is of flag type, with v supported on a type A subdiagram S , and that π is chosen minimal in its W/W_S coset. Then

- (a) each entry of v' is a positive combination of the entries of w and v , when expressed using the reflection algorithm from (1), and
- (b) θ is v -positive.

Then by (1) and proposition 7.1 (2), we have $\mathcal{M}_1(w, v', \pi \cdot \theta) \cong \mathcal{M}_1(w, v, \theta) \cong$ the cotangent bundle of a d -step flag variety, where (assuming S is oriented toward its head) the steps are given by $(v^i, i \in S)$.

If v is nonzero on S , then π 's minimality in its coset doesn't merely imply condition (a), but can be inferred from it.

Proof. The calculation at the end of (1), based on $r_{\vec{\alpha}}\lambda = \lambda - \langle \vec{\alpha}, \lambda \rangle \vec{\alpha}$, is straightforward. It remains to prove (2).

The minimality condition on π is equivalent to " $\pi \cdot \vec{\alpha}_i$ is a positive root for each $i \in S$ ", which we will use in both (2a) and (2b). Note that this is a rephrasing of the last statement of the proposition.

First observe that $\pi \cdot \vec{\omega}_i$ is a weight of $V_{\vec{\omega}_i}$, hence $\vec{\omega}_i - \pi \cdot \vec{\omega}_i$ is a positive combination of simple roots. This and the quote in the previous paragraph prove (2a).

For (2b) we compute

$$\langle \theta, \vec{\alpha} \rangle = \langle \pi \cdot \theta, \pi \cdot \vec{\alpha} \rangle$$

then use the quote above and the assumed positivity of $\pi \cdot \theta$. □

We give an example of proposition 7.2, one of the cases appearing in figure 2. At each stage we color the label(s) where we're about to perform (commuting) reflections, using the recipe at the end of proposition 7.2 (1).

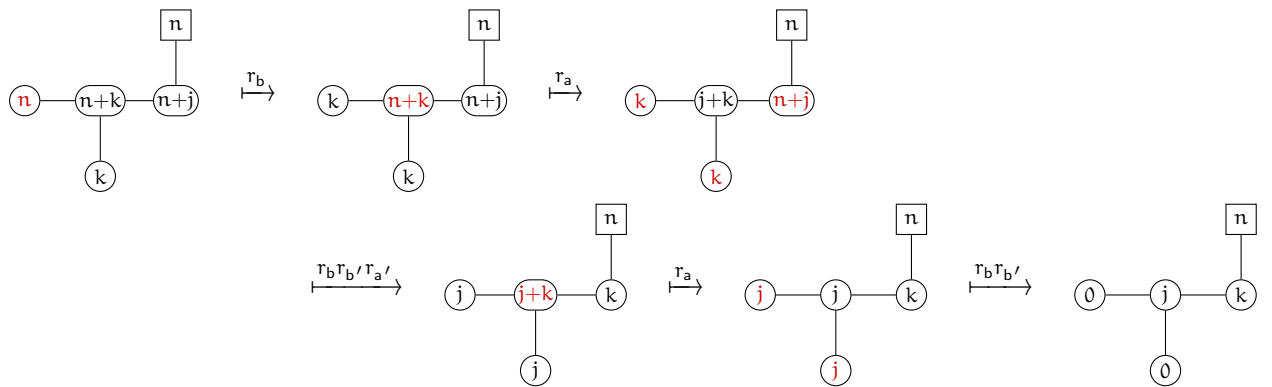

The v -coefficients $n, n + k, n + j, k$ in the D_4 quiver variety are positive combinations of n, j, k , so by the last statement in the proposition, this sequence $r_b r_a r_b r_a r_b r_a r_b r_b'$ of reflections defines a π with the minimality required to apply part (2). Hence this sequence demonstrates that (with θ chosen positive) the D_4 quiver variety first listed is isomorphic to $T^*\text{Fl}(j, k; n)$.

7.2. The geometry of figures 1–4. We can now fully explain the meaning of figures 1–4, (excepting the arrows, which will come in §8). In figure d we list a Dynkin diagram X_{2d} , a quiver variety $\mathcal{M}(w_{(1)}, v_{(1)})$ of flag type, a quiver variety $\mathcal{M}(w_{(2)}, v_{(2)})$ not usually of flag type but susceptible to proposition 7.2, an “intermediate” quiver variety

$\mathcal{M}(w_{(1)} + w_{(2)}, v_{(1)} + v_{(2)})$ usually neither of flag type nor susceptible to proposition 7.2 (except at $d = 1$), and finally another quiver variety $\mathcal{M}(w_{(3)}, v_{(3)})$ not usually of flag type but susceptible to proposition 7.2. For each of the non-intermediate quiver varieties, we give a reduced word for the π used in proposition 7.2 to show that those quiver varieties are just cotangent bundles.)

Each $\mathcal{M}(w, v)$ carries an action of $\prod_i \mathrm{GL}(w^i)$ changing basis on the framed vertices, which we shrink to a maximal torus $T := \prod_i T^{w^i}$. There is also a commuting action of \mathbb{C}^\times that scales the “backward” maps (between gauged vertices against I ’s orientation, or downward from framed to gauged) and $\theta_{\mathbb{C}}$ that one should think about differently: in terms of the complex symplectic form naturally borne by $\mathcal{M}(w, v)$, T *preserves* the symplectic form whereas the \mathbb{C}^\times -action *scales* the form. We put the tori together into

$$\hat{T} := T \times \mathbb{C}^\times$$

In [Nak01], Nakajima defines an action of $\mathcal{U}_q(\mathfrak{g}[z^\pm])$ on the K-theory $K_{\hat{T}}(\bigsqcup_v \mathcal{M}(w, v))$ (which we will take with complex coefficients) of a quiver variety, and identifies the latter with the tensor product $\bigotimes_{k=1}^n V_{\omega_{m_k}}(z_k)$ of certain fundamental representations, where $n = \sum_i w^i$, $\#\{m_k = i\} = w^i$, and the z_k (resp. t) are the equivariant parameters associated to the Cartan torus $T \cong (\mathbb{C}^\times)^n$ (resp. to the scaling action). These were the representations mentioned at the start of §3.

In the present case, fixing the framed dimension vector to be of the form of figure d, quiver (1), and summing over all gauged dimension vectors, we obtain an action of $\mathcal{U}_q(\mathfrak{g}_{2d}[z^\pm])$ on $V_a(z_1) \otimes \cdots \otimes V_a(z_n)$, recovering the representation theory discussed in §3.1.

In particular, at $n = 1$, for all one-dimensional weight spaces of $V_a(z)$ (which includes all of $V_a^\Lambda(z)$, and in fact, is all weight spaces except the zero weight space at $d = 4$), one has a natural basis given by the stable envelope construction (where we always make the same “canonical” choice of chamber, polarization and line bundle as for St^Λ in proposition 2.9).

Lemma 7.3. *Let $d = 1, 2, 3, 4$ and $\alpha = 1, 2, 3$, with $w_{(\alpha)}$ the framed dimension vector on quiver α of figure d. In particular $w_{(\alpha)}$ has \boxed{n} at exactly one vertex. Define **the α th single-number sector**¹³ for that quiver in that figure as the set of $v_{(\alpha)}$ pictured, a d -parameter rather than $2d$ -parameter set.*

- (1) *The α th single-number sector forms a face of the polytope from proposition 7.1 (3).*
- (2) *If $v_{(\alpha)}$ runs over a single-number sector, then*

$$K_{\hat{T}} \left(\bigsqcup_{v_{(\alpha)}} \mathcal{M}(w_{(\alpha)}, v_{(\alpha)}) \right) \cong \bigotimes_{k=1}^n V_a^\Lambda(z_k)$$

- (3) *The subspace $V_a^\Lambda(z_1) \otimes V_a^\Lambda(z_2)$ is invariant under the operator $\check{R}_{\alpha, \alpha}$.*
- (4) *The matrix of $\check{R}_{\alpha, \alpha}$ restricted to $V_a^\Lambda(z_1) \otimes V_a^\Lambda(z_2)$, in the basis $(e_{\alpha, i})_{i=0, \dots, d}$, matches the R-matrix from (1). (Note the subtlety mentioned before the lemma, that not all weight spaces come with natural bases, but those in the single-number sector do.)*

¹³This denomination comes from the labels $0, \dots, d$ of weight vectors of $V_a^\Lambda(z)$ which are single numbers, as opposed to other weight spaces of $V_a(z)$ which are traditionally labeled in Schubert puzzles by multinumbers.

- Proof.* (1) This statement is obvious for $a = 1$ – the conditions on v are that certain entries $\langle v, \bar{\alpha} \rangle$, obviously bounded below by 0, are in fact 0. To see it for $a = 2, 3$ we use the sequences of reflections in figure d to rotate the $a = 1$ face to the purported $a = 2, 3$ faces.
- (2) For $a = 1$, this is essentially an A_d calculation, using [Nak01] as above. For $a = 2, 3$ we use proposition 7.2 (and the sequences of reflections provided in the end of each figure) to identify the varieties with those from the $a = 1$ case.
- (3) This follows from part (1) of the lemma and $\check{R}_{a,a}$'s T -equivariance.
- (4) By part (2), at $n = 2$, $V_a^\Lambda(z_1) \otimes V_a^\Lambda(z_2) \cong K_\uparrow(\bigsqcup_{v(a)} \mathcal{M}(w_{(a)}, v_{(a)}))$, and the R-matrix then agrees with the geometrically defined R-matrix of §2.5, cf. the proof of proposition 2.9, up to normalization. Finally, one verifies the normalization $\check{R}_{00}^{00} = 1$ in (1). □

8. GEOMETRIC INTERPRETATION OF PUZZLES

The proof of theorem 3.8 comes down to equivariant localization and variants of YBE (found in proposition 3.4). In particular, that proof does not make clear why one might expect $\mathcal{U}_q(\mathfrak{r}_{2d}[z^\pm])$ R-matrices to be of use when studying partial flag varieties, and indeed we didn't know “why” they proved so useful in [KZJ17] at the time of writing. In this section we provide a retrodiction, deriving the puzzle rules directly from geometry. (Unfortunately we only understand the geometry well enough to work in cohomology, rather than K-theory.) We emphasize that our principal results do not depend on those of this section, and due to that, some of the proofs will be abbreviated.

It was first noted in [ZJ09, proposition 1] that the equivariant puzzle rule of [KT03] is based on an R-matrix. Drinfel'd and Jimbo showed that many R-matrices arise from the representation theory of quantized loop algebras. Nakajima [Nak01] showed that many representations of quantized loop algebras arise on the K-theory of quiver varieties, and Varagnolo [Var00] gave the corresponding result in cohomology.¹⁴ Maulik and Okounkov [MO19] interpreted R-matrices directly in cohomology, using their “stable envelope” construction of certain Lagrangian relations between quiver varieties. We review some of this latter work. One novel feature is that we need to mix in some Lagrangian relations other than stable envelopes; in particular for $d = 1$ we need a Hamiltonian reduction.

8.1. The “category” of correspondences. Let \mathcal{K} denote the “category” (terminology due to [Wei81]) whose objects are compact oriented manifolds, with morphisms $\text{Hom}_{\mathcal{K}}(A, B) := \{\text{oriented cycles } K \text{ in } A \times B\}$. It is not an actual category, because we only define a composition $K_1 \star K_2$ of $K_1 \in \text{Hom}_{\mathcal{K}}(A, B)$ with $K_2 \in \text{Hom}_{\mathcal{K}}(B, C)$ when $K_1 \times C$ and $A \times K_2$ are transverse inside $A \times B \times C$. The composite is defined as $K_1 \star K_2 := \pi_{AC}((K_1 \times C) \cap (A \times K_2))$, where π_{AC} is the projection $A \times B \times C \rightarrow A \times C$. Later, when we allow A, B, C to be non-compact, to define a composition we will also require that π_{AC} be proper on that intersection. Only under these two conditions do we say that K_1, K_2 are **composable**. (We will do something very weird in proposition 8.6 and compose two “non-composable” relations.)

The cohomology functor factors through this “category”, as follows. Consider $H^*(A) = H^*(A; \mathbb{R})$ as an inner product space, with pairing $\langle \alpha, \beta \rangle := \int_A (\alpha \cup \beta)$. Then H^* is a functor

¹⁴This is a rare case – like Atiyah–Bott's equivariant localization formulæ – where the K-theory result predates the cohomology result (see the arXiv references). Publication took place in the opposite order. We thank Sachin Gautam for setting us straight on the history.

from the category **COMfld** = (compact oriented manifolds, smooth maps) to the category **Inner** of real inner product spaces. This **Inner** is no different from **Vec** as a category, but is endowed with a contravariant endofunctor ‘transpose’. We can be ambiguous about whether H^* is covariant or contravariant, thanks to this transpose. The “category” \mathcal{K} has an obvious transpose as well, unlike **COMfld**.

Now we factor H^* as

$$\begin{array}{ccccc} \mathbf{COMfld} & \xrightarrow{\text{graph}} & \mathcal{K} & \xrightarrow{\bullet\text{-transform}} & \mathbf{Inner} \\ A & \mapsto & A & \mapsto & H^*(A) \\ (f : A \rightarrow B) & \mapsto & \text{graph}(f) & & \\ & & K \subseteq A \times B & \mapsto & \Upsilon_K := (\alpha \mapsto \text{P.D.}((\pi_B)_*(\pi_A^*(\alpha) \cap [K]))) \end{array}$$

The principal results to know, at this level of generality, are (1) when two correspondences are composable, the $(K_1 \star K_2)$ -transform is the composite of the two individual transforms, and (2) the $\text{graph}(f)$ -transform is the pushforward f_* in cohomology, whose transpose is the pullback f^* . In particular, the composite of the two functors above is H^* .

8.2. Weinstein’s “category” of symplectic manifolds. Our actual interest is in the “category” \mathcal{C} of (holomorphic) symplectic manifolds and Lagrangian correspondences, i.e.

$$\text{Hom}_{\mathcal{C}}(M, N) := \{L \subseteq M \times N : L \text{ is a Lagrangian cycle in } (-M) \times N\}$$

where $(-M)$ denotes M with the symplectic form negated. This “category” was introduced in [Wei81] and has seen much development since then, e.g. [WW12, Wei82, Wei10]. Note that it again enjoys a transpose.

The dimension of L is the average of the dimensions of M and N . When $\dim M \geq \dim N$, we might expect the projection $L \rightarrow M$ to be an immersion and $L \rightarrow N$ to be a submersion; when these hold we call the Lagrangian relation $L \subseteq M \times N$ a **reduction**. The transpose of such an L is called a **co-reduction**.

We mention five examples of Lagrangian relations, four of which date from the introduction of this “category” and one of which is much more recent. Each but the fourth is a reduction or a co-reduction.

- (1) If $\phi : M \rightarrow N$ is a symplectomorphism, then $\text{graph}(\phi) \in \text{Hom}_{\mathcal{C}}(M, N)$.
- (2) Elements $L \in \text{Hom}_{\mathcal{C}}(\text{pt}, N)$ are simply Lagrangian cycles in N .
- (3) If G acts on M Hamiltonianly with moment map $\Phi_G : M \rightarrow \mathfrak{g}^*$, and $N = \Phi^{-1}(c) // G$ is the GIT quotient of a central level set (i.e. $c \in (\mathfrak{g}^*)^G$), then $\Phi^{-1}(c) \in \text{Hom}_{\mathcal{C}}(M, N)$. This is essentially the Marsden-Weinstein theorem.
- (4) If $R \subseteq X \times Y$ is a submanifold of a product, e.g. the graph of a function, then its conormal bundle $CR \subseteq T^*(X \times Y) \cong T^*X \times T^*Y$ gives an element of $\text{Hom}_{\mathcal{C}}(T^*X, T^*Y)$.
- (5) If $\mathbb{C}^\times \curvearrowright M$ symplectically, with $F \subseteq M^{\mathbb{C}^\times}$ a fixed-point component, then

$$\text{attr}(F) := \{m \in M : \lim_{z \rightarrow 0} z \cdot m \in F\}$$

has obvious maps $\text{attr}(F) \hookrightarrow M$, $\text{attr}(F) \xrightarrow{\lim_{z \rightarrow 0} z \cdot} F$ which together give an inclusion $\text{attr}(F) \hookrightarrow M \times F$, whose image turns out to be Lagrangian. In the rare occurrence that $\text{attr}(F)$ is *closed* in M , it defines an element of $\text{Hom}_{\mathcal{C}}(M, F)$.

A basic example of the last construction¹⁵ has $M = G \cdot \lambda \subseteq \mathfrak{g}^*$, a generic coadjoint orbit of the complex group, so $M \cong G/T$ as a homogeneous space. (Don’t confuse this

¹⁵Intriguingly, it is also an example of the third construction, if one considers the symplectic reduction of $G \cdot \lambda$ by the maximal unipotent subgroup of G . The zero level set is $\coprod_W N_W T/T \subseteq G/T$.

with the projective variety G/B ; G/T is a bundle over G/B with contractible fibers, but no holomorphic sections $G/B \rightarrow G/T$, since $G/T \cong G \cdot \lambda$ is affine.) If the \mathbb{C}^\times -action on this M is by a regular dominant coweight, then the fixed points are the finite set $N(T)/T$, and for each $w \in W$ we have $\text{attr}(wT/T) = BwT/T$. Since $B \leq G$ is a closed subgroup we know that $B/T \subseteq G/T$ is closed. Then since the *right* action of W on G/T transitively permutes the submanifolds $\{BwT/T\}$, each of those submanifolds is closed, and of the same (Lagrangian) dimension. This situation is in strong contrast to the B -orbits on G/B !

To compare the graph of $f : Y \rightarrow X$ and its conormal bundle, as correspondences, we observe the following equation in the “category”:

Lemma 8.1. *Let $f : Y \rightarrow X$ be a smooth map of compact manifolds, and ι_X, ι_Y the inclusions of X, Y respectively into their cotangent bundles, as the zero sections. The following square of correspondences commutes (in particular, both compositions exist):*

$$\begin{array}{ccccc} & & T^*X & \xrightarrow{C\text{graph}(f)^T} & T^*Y \\ \text{graph}(\iota_X) & & \uparrow & = & \uparrow \text{graph}(\iota_Y) \\ & & X & \xrightarrow{\text{graph}(f)^T} & Y \end{array}$$

Proof. Three of these correspondences are easy. To get a hold of the conormal bundle atop, start with the map $f \times \text{Id} : Y \rightarrow X \times Y$, $y \mapsto (f(y), y)$, a diffeomorphism to the graph. Its derivative at y is $\vec{a} \mapsto (T_y f(\vec{a}), \vec{a})$ with dual $(\vec{a}, \vec{b}) \mapsto T_y^* f(\vec{a}) + \vec{b}$. The conormal space at y that we seek is the kernel $\{(\vec{a}, -T_y^* f(\vec{a})) : \vec{a} \in T_{f(y)}^* X\}$ of that dual map. In all

$$C\text{graph}(f)^T = \{((f(y), \vec{a}), (y, -T_y^* f(\vec{a}))) \in T^*X \times T^*Y\}$$

Now we try to compose

$$\text{graph}(\iota_X) = \{(x, (x, \vec{0})) \in X \times T^*X\}$$

with $C\text{graph}(f)^T$. The intersection is

$$(\text{graph}(\iota_X) \times T^*X) \cap (X \times C\text{graph}(f)^T) = \{(f(y), (f(y), \vec{0}), (y, \vec{0}))\}$$

whose projection to $\{(f(y), (y, \vec{0})) : y \in Y\}$ is a diffeomorphism, hence proper.

Also we try to compose

$$\text{graph}(f)^T = \{(f(y), y) : y \in Y\}$$

with $\text{graph}(\iota_Y)$, obtaining the intersection

$$(\text{graph}(f)^T \times T^*Y) \cap (X \times \text{graph}(\iota_Y)) = \{(f(y), y, (y, \vec{0})) : y \in Y\}$$

whose projection to $\{(f(y), (y, \vec{0})) : y \in Y\}$ is again a diffeomorphism, hence proper. \square

We would like to infer a result on cohomology from that lemma, but our definition of K -transform for $K \subseteq M \times N$ involves integrating over the fibers of $M \times N \rightarrow N$, so requires M compact. We sidestep this in the next section.

When $X \subseteq M$ is a closed and irreducible but possibly singular subvariety of a smooth variety, its **conormal variety** CX is by definition the closure of the conormal bundle to its smooth part X_{reg} . For use later we bring up a characterization, tracing to Monge (see [Kle86, p169]), of these subvarieties:

Lemma 8.2. [Tev03, Theorem 1.10] *A reduced closed subscheme $Y \subseteq T^*M$ is a conormal variety CX iff it is **conical** (invariant under scaling the cotangent fibers), irreducible, and Lagrangian. In this case X can be computed from Y either as the intersection of Y with the zero section in T^*M (hence closed), or as the image of the projection $Y \hookrightarrow T^*M \rightarrow M$ (hence irreducible).*

8.3. Correspondences and (equivariant) cohomology, and dividing by the zero section.

In equivariant cohomology, there is a handy trick: once one “localizes” to the fraction field $\text{frac } H_{\mathbb{T}}^*$, to define our transforms it is enough for $M^{\mathbb{T}}$ to be compact, since

$$\text{frac } H_{\mathbb{T}}^* \otimes_{H_{\mathbb{T}}^*} H_{\mathbb{T}}^*(M) \cong \text{frac } H_{\mathbb{T}}^* \otimes_{H_{\mathbb{T}}^*} H_{\mathbb{T}}^*(M^{\mathbb{T}}) \cong \text{frac } H_{\mathbb{T}}^* \otimes_{\mathbb{Z}} H^*(M^{\mathbb{T}}) = \text{frac } H_{\mathbb{T}}^* \otimes_{\mathbb{Z}} H_{\mathbb{C}}^*(M^{\mathbb{T}}).$$

Stated more baldly, every class on M is a $(\text{frac } H_{\mathbb{T}}^*)$ -linear combination of classes on $M^{\mathbb{T}}$, and by expressing classes that way we can define the application of the β -transforms Υ_{β} to them. This is more than just a trick for computation: it can happen that Υ_{β} applied to a class in $H_{\mathbb{T}}^*(M)$ does not lie in $H_{\mathbb{T}}^*(N)$, but lies only in $(\text{frac } H_{\mathbb{T}}^*) \otimes_{H_{\mathbb{T}}^*} H_{\mathbb{T}}^*(N)$.

Consider now the situation of lemma 8.1, with X, Y compact complex. Their cotangent bundles carry \mathbb{C}^{\times} -actions with compact fixed points, so as just explained lemma 8.1 gives us a commuting square

$$\begin{array}{ccc} H_{\mathbb{C}^{\times}}^*(T^*X) & \xrightarrow{\Upsilon_{\text{Cgraph}(f)^{\mathbb{T}}}} & H_{\mathbb{C}^{\times}}^*(T^*Y) \\ \uparrow & & \uparrow \\ H_{\mathbb{C}^{\times}}^*(X) & \xrightarrow{f^*} & H_{\mathbb{C}^{\times}}^*(Y) \end{array} \quad \text{all tensored with } \text{frac } H_{\mathbb{C}^{\times}}^*$$

where each vertical map is the degree-shifting map “pushforward in cohomology” ι_* along the inclusion ι of the zero section. Compared to $/$ composed with the isomorphism ι^* , this ι_* amounts to multiplying by the equivariant Euler class

$$e(T^*X) \in H_{\mathbb{C}^{\times}}^*(X) = H^*(X)[\hbar]$$

(for the left vertical map; replace X by Y for the right vertical map).

Before we analyze this class, we emphasize the differences between the pullback and pushforward maps induced from $X \hookrightarrow T^*X$. The pullback (on ordinary, equivariant, or localized equivariant cohomology) is a graded ring isomorphism, whereas the pushforward is an isomorphism only on localized equivariant cohomology, and only as an $H_{\mathbb{C}^{\times}}^*$ -module. The pushforward of 1 is the class $[X \subseteq T^*X]$ of the zero section, whose pullback is $e(T^*X)$. In particular either composite is multiplication by this class (in one of its guises).

Any complex vector bundle V on M can be regarded as a \mathbb{C}^{\times} -equivariant vector bundle by the scaling action, giving an equivariant Euler class $e(V) \in H_{\mathbb{C}^{\times}}^*(M) = H^*(M)[\hbar]$. Its dehomogenization $e(V)|_{\hbar \rightarrow 1}$ is the total Chern class $c(V)$ (we thank Shaun Martin for this point of view, which nicely retrodicts Stiefel–Whitney and Pontrjagin classes as well. The proof is pretty immediate from the usual characterizations of Chern classes). Note that this is not the dehomogenization we needed in §5.5). Since the total Chern class is $1 + \text{nilpotent}$, the vertical maps in the square above become isomorphisms already upon inverting \hbar , much less tensoring with $\text{frac } H_{\mathbb{C}^{\times}}^*$. (In practice we work with not just \mathbb{C}^{\times} but $(\mathbb{T} \times \mathbb{C}^{\times})$ -equivariant cohomology, in which case the total Chern class is only invertible after more fully localizing.)

In particular, from a known $\text{Cgraph}(f)^{\mathbb{T}}$ -transform $\rho \mapsto \Upsilon_{\beta}(\rho)$, we can infer thereby that $f^*(\rho/[X \subseteq T^*X]) = \Upsilon_{\beta}(\rho)/[Y \subseteq T^*Y]$. This result is what motivates the denominator in our SSM classes.

Hereafter our calculations happen to be in Weinstein’s symplectic “category”, though in fact we nowhere use the symplectic or Lagrangian structure.

8.4. Stable envelopes. In [MO19, Theorem 3.7.4] Maulik and Okounkov extend the attr construction from §8.2 as follows, perhaps inspired by the following phenomenon.

Lemma 8.3. *Let V be a linear representation of \mathbb{C}^\times , and $X \hookrightarrow V$ a closed \mathbb{C}^\times -invariant subscheme. Then for each component $F \subseteq X^{\mathbb{C}^\times}$ of X 's fixed-point set, the attracting set $\text{attr}(F \subseteq X)$ is closed.*

Proof. Break $V = V_- \oplus V_0 \oplus V_+$ into its negative, zero, and positive \mathbb{C}^\times -weight spaces. Then $V^{\mathbb{C}^\times} = V_0$ and $X^{\mathbb{C}^\times} = X \cap V_0$, and

$$\begin{aligned} \text{attr}(F \subseteq X) &= \{\vec{v} \in V : \vec{v} \in X, \lim_{z \rightarrow 0} z \cdot \vec{v} \in F\} \\ &= \{\vec{v} \in V : \vec{v} \in X\} \cap \{\vec{v} \in V : \lim_{z \rightarrow 0} z \cdot \vec{v} \in F\} = X \cap (F + V_+) \end{aligned}$$

where $F + V_+ = \{f + \vec{v} : f \in F, \vec{v} \in V_+\}$ is closed, being the preimage of F along the projection $V_0 \oplus V_+ \rightarrow V_0$. Since $\text{attr}(F \subseteq X)$ is the intersection of two closed sets, it is closed. \square

If $E \rightarrow S$ is a flat family with a fiberwise \mathbb{C}^\times -action, call it a **deformation to affine** if the fibers over a dense open set $S^\circ \subseteq S$ are subvarieties of affine space. Then given a flat subfamily $F \subseteq E^{\mathbb{C}^\times}$, define the **stable envelope** $\overline{\text{attr}(F \subseteq E)} \subseteq F \times E$ as the closure of the image of the injection

$$\text{attr}(F \subseteq E) \rightarrow F \times E, \quad m \mapsto \left(\lim_{z \rightarrow 0} z \cdot m, m \right)$$

(Note that it is *not* defined as the closure of $\text{attr}(F \subseteq E)$ inside E , and indeed, the composite $\overline{\text{attr}(F \subseteq E)} \hookrightarrow F \times E \rightarrow E$ is typically not injective.)

By lemma 8.3, $\overline{\text{attr}(F \subseteq E)} \subseteq F \times E$ agrees with $\text{attr}(F \subseteq E)$ over S° (nothing is added in the closure), but inside other fibers $E|_{s \notin S^\circ}$ one may have strict containment $\overline{\text{attr}(F \subseteq E)}|_s \supset \overline{\text{attr}(F|_s \subseteq E|_s)}$. Given a non-affine fiber $E|_o$ of such a family, one can ask whether that fiber $\overline{\text{attr}(F \subseteq E)}|_o$ of the stable envelope depends on the choice of deformation E to affine; in fact it does not, as the stable envelope in a fiber can be characterized as in [MO19, §3.3]. (Indeed, their definition of “stable envelope” is for one fiber at a time, without a deformation to affine assumed, and in particular is more general than the definition here.) This independence matters little for quiver varieties and more generally for symplectic resolutions M , as by [Kal09] any such M is the central fiber of a canonical deformation to affine, with T -diffeomorphic fibers.

To continue the basic example¹⁶ from §8.2, consider the Springer resolution $M = T^*G/B$, and its Grothendieck–Springer deformation to $M_{\text{def}} = G \cdot \lambda$. We can, for example, fix a regular λ and consider the one-parameter subfamily whose fibers are $G \cdot z\lambda$ for $z \neq 0$, T^*G/B for $z = 0$. Note that this family, and its zero fiber M , possess a \mathbb{C}^\times action (scaling of \mathfrak{g}^*) that the general fiber $G \cdot \lambda$ does not. This action is what we use to degenerate the attracting set in M_{def} to the stable envelope in M . Thanks to lemma 8.3 each attracting set BwT/T in $G \cdot \lambda$ is closed, and we obtain the stable envelope as $\lim_{z \rightarrow 0} z \cdot (BwT/T) \subseteq T^*G/B$.

Perhaps the most crucial property of stable envelopes is their following functoriality:

¹⁶The noncommutative analogue may be more familiar, in which T^*G/B deforms to the central-character-zero algebra $(U\mathfrak{g})_0$, whose Verma modules are very complicated. This deforms in an independent direction to $(U\mathfrak{g})_\lambda$ with generic central character, whose Verma modules are irreducible and bear no Exts with one another.

Proposition 8.4 (restatement of [MO19, Lemma 3.6.1]). *Let $A_1, A_2 : \mathbb{C}^\times \rightarrow \text{Aut}(E \rightarrow S)$ be two commuting fiberwise-actions on a deformation-to-affine $E \rightarrow S$. Let F_2 be a component of $E^{(A_1, A_2)}$, and $F_1 \subseteq E^{A_1}$ the component containing F_2 . Then for $N \gg 0$, the triangle of relations*

$$\begin{array}{ccc} F_2 & \xrightarrow{\text{env}(A_{1+})} & E \\ \text{env}(A_2) \searrow & & \nearrow \text{env}(A_1) \\ & F_1 & \end{array}$$

commutes, where $A_{1+}(z) = A_1(z^N)A_2(z)$.

(In [MO19] they only state the corresponding result in cohomology, but their proof is actually at the level of convolution of cycles, as stated here.)

8.5. The flag type case. The deformation-to-affine of Nakajima quiver varieties is easy to describe; this is the variation of complex moment $\theta_{\mathbb{C}}$ from §7.1. In the flag type case this deformation of quiver varieties is exactly the Grothendieck–Springer deformation of $T^*(\text{GL}_n/P)$ to GL_n/L (L a Levi subgroup of P), generalizing the $P = B$ example from §8.4.

Specifically, if we put a scalar ε_i at the n_i gauge vertex of  then our deformation is to the space

$$\{(X \in \text{End}(\mathbb{C}^n), 0 = V_0 \leq V_1 \leq V_2 \leq \dots \leq V_d \leq V_{d+1} = \mathbb{C}^n) : (X - \varepsilon_i \mathbf{1})V_{i+1} \leq V_i\}$$

where $\dim V_i = n_i$ and $\varepsilon_{d+1} := 0$. In particular X has spectrum $\varepsilon_1^{(n_1)} \varepsilon_2^{(n_2 - n_1)} \dots \varepsilon_d^{(n_d - n_{d-1})} 0^{(n - n_d)}$ and if these $d + 1$ values are distinct, then each subspace V_i can be recovered as a sum of eigenspaces of X . Consequently, the projection to $\text{End}(\mathbb{C}^n)$ is an affine embedding, with image the space \mathcal{O}_ε of semisimple operators X with this specified spectrum.

The T -fixed points on \mathcal{O}_ε are just the diagonal matrices $D \in \mathcal{O}_\varepsilon$, of which there are $\binom{n}{n_1, n_2 - n_1, \dots, n - n_d}$. With respect to the action of a regular dominant coweight, the attracting set $\text{attr}(D)$ is $\{D \text{ plus block strictly upper triangular matrices}\}$, with blocks of size $n_1, n_2 - n_1, \dots, n - n_d$. In particular each $\text{attr}(D)$ is closed (as predicted by lemma 8.3).

8.6. $d = 1$. In the $d = 1$ case from figure 1, we give here full detail on how to derive (the cohomology, not K -theory, version of) theorem 3.8 from quiver variety geometry. The exposition is easier in this case, in that the X_{2d} quiver variety for $d = 1$ is itself of flag type.

8.6.1. Reviewing the representation theory. The T^n -equivariant cohomology of the quiver

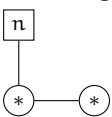
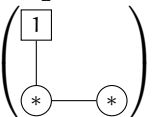
scheme  is a representation of $\mathcal{U}_q(\mathfrak{sl}_3[z])$ [Var00]. The T^n fixed points form ⁿ

whose cohomology bears the representation $\otimes_{i=1}^n \mathbb{C}^3(x_i)$, a tensor product of evaluation representations. As with $H_{T^n}^*$ of any space, when we tensor with $\text{frac } H_{T^n}^*$ (passing to the generic point in the space of equivariant parameters) we can identify the equivariant cohomology of the whole with that of the fixed points. In particular, the equivariant parameters from $H_T^*(\text{pt})$ enter as the evaluation parameters, and in turn are the spectral parameters in the (rational) R -matrices.

In [Nak01, §14.1] it is conjectured that this representation is a tensor product even at nongeneric values. In the next section we implicitly assume the truth of this for *motivating*

the geometry we pursue, but we don't actually make use of it in the eventual cohomological calculations.

The subtle step to come is in constructing the map $\mathbb{C}^3(x_i) \otimes \mathbb{C}^3(y_i) \rightarrow \text{Alt}^2 \mathbb{C}^3(z_i)$, as that tensor product is irreducible for generic values of $(x_i), (y_i)$. Indeed, this map will only exist when

$$(34) \quad y_i = x_i + \hbar, \quad z_i = x_i + \hbar/2$$

(which is the rational analogue of lemma 3.3 at $d = 1$). The value of z_i is not so important because the \hbar -shift can be absorbed in the geometric construction. The equality $y_i = x_i + \hbar$ however, is meaningful: specialization of equivariant parameters, $H_T^* \rightarrow H_S^*$, is equivalent to passage to a subtorus $S \hookrightarrow T$. This S will leave invariant more possible equations on our quiver varieties and motivates one of our choices in the next section.

This type of geometric fusion was first developed in [ZJ15], though only in type A – which in the present context encompasses the $d = 1$ construction.

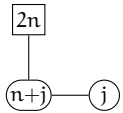
8.6.2. *Discovering the quiver geometry.* Being of flag type, the quiver variety  has a well-known description in Springer coordinates as

$$\left\{ (X \in \text{End}(\mathbb{C}^{2n}), \mathbb{C}^{2n} \geq V^{n+j} \geq W^j) : \mathbb{C}^{2n} \xrightarrow{X} V \xrightarrow{X} W \xrightarrow{X} 0 \right\}$$

where X is the composite $\boxed{2n} \rightarrow \boxed{n+j} \hookrightarrow \boxed{2n}$, and V, W are the images of $\boxed{n+j} \hookrightarrow \boxed{2n}$ and $\boxed{j} \hookrightarrow \boxed{n+j} \hookrightarrow \boxed{2n}$. The containments $X(V) \leq W$ etc. follow from the moment map conditions defining the quiver variety.

We have two representation-theoretic maps to study. The first, and simpler, one joins the two representations $\otimes_{i=1}^n \mathbb{C}^3(a_i)$ and $\otimes_{i=1}^n \mathbb{C}^3(b_i)$ into their tensor product and on the quiver scheme level, is achieved using a stable envelope we compute now.

Denote by Z the circle $z \mapsto \text{diag} \left(\overbrace{1, \dots, 1}^n, \overbrace{z, \dots, z}^n \right) \in \text{GL}(2n)$ acting on the quiver variety above. A triple (X, V, W) is Z -fixed if X is block diagonal (with two blocks each of size n) and V, W are graded subspaces w.r.t. the splitting $\mathbb{C}^{2n} = \mathbb{C}^n \oplus \mathbb{C}^n$. The fixed point set of this Z -action is not connected; rather, the components are distinguished by the statistics $\dim(V \cap (\mathbb{C}^n \oplus 0)), \dim(W \cap (\mathbb{C}^n \oplus 0))$.

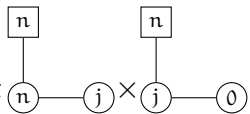
Our interest is in the component  where those statistics are maximized. Its Z -attracting set is

$$\left\{ \left(X = \begin{pmatrix} A & B \\ 0 & C \end{pmatrix}, V \geq (\mathbb{C}^n \oplus 0) \geq W \right) \right\}$$

which is *already closed* and hence is a component L_1 of a stable envelope, $\text{env}(Z)$. In the Springer coördinates of the two spaces, $L_1 \subseteq \text{env}(Z)$ is the following Lagrangian coreduction:

$$L_1 := \left\{ ((A, V', D, W'), (X, V, W)) : \begin{array}{l} X = \begin{pmatrix} A & * \\ 0 & D \end{pmatrix}, \quad \begin{array}{l} V = \mathbb{C}^n \oplus V' \\ W = W' \oplus 0 \end{array} \end{array} \right\}$$

↙

↘

$$\{(A \in \text{End}(\mathbb{C}^n), V'^j)\} \times \{(D \in \text{End}(\mathbb{C}^n), W'^j)\} \qquad \{(X \in \text{End}(\mathbb{C}^{2n}), V^{n+j}, W^j)\}$$

The image of the Southeast map, an inclusion, is the attracting locus determined above. The Southwest map fails to be an inclusion because of the unspecified “*”. Since L_1 is conical, lemma 8.2 applies, saying L_1 is the conormal variety to the graph of

$$\begin{array}{ccc} \text{Gr}(j; \mathbb{C}^n)^2 & \hookrightarrow & \text{Fl}(j, n+j; \mathbb{C}^{2n}) \\ (V', W') & \mapsto & (W' \oplus 0, \mathbb{C}^n \oplus V') \end{array}$$

but we won't make use of this description.

Our second map of representations is $\bigotimes_{i=1}^n \mathbb{C}^3(x_i) \otimes \bigotimes_{i=1}^n \mathbb{C}^3(x_i + \hbar) \rightarrow \bigotimes_{i=1}^n (\text{Alt}^2 \mathbb{C}^3)(x_i + \frac{\hbar}{2})$,

which we want to induce (in a certain weight) using a Lagrangian from $\begin{array}{c} \boxed{2n} \\ | \\ \textcircled{n+j} \text{---} \textcircled{j} \end{array}$ to $\begin{array}{c} \boxed{n} \\ | \\ \textcircled{j} \text{---} \textcircled{j} \end{array}$. The dimension of the first quiver variety is $2n^2$ more than that of the second (selected to have the same weight, i.e. $2n\omega_1 - (n+j)\alpha_1 - j\alpha_2 = n\omega_2 - j\alpha_1 - j\alpha_2$). Hence if we hope for our Lagrangian correspondence to be a reduction, we should impose n^2 many conditions on that first quiver variety and submerge the resulting submanifold onto the second quiver variety. In the next few paragraphs we motivate what will be our choice of the n^2 many equations.

Imposing equations on a scheme is the same as imposing them on the affinization, which in this case is a space of nilpotent matrices X . The torus acting on this space is the $2n$ -torus with weights $(x_i), (y_i)$ on $\mathbb{C}^n \oplus \mathbb{C}^n$, plus \hbar from the circle that acts by dilation on the cotangent fibers, or acts by scaling on these matrices. Hence the weights of the $(2n)^2$ matrix entries are

$$\begin{bmatrix} \hbar + x_i - x_j & \hbar + x_i - y_j \\ \hbar + y_i - x_j & \hbar + y_i - y_j \end{bmatrix} \quad i, j \in [n]$$

Recall from equation (34) that to intertwine our $\mathcal{U}_q(\mathfrak{sl}_3[z])$ -representations, one needs to specialize these evaluation parameters as $y_i = x_i + \hbar$. That would make the weights now

$$\begin{bmatrix} \hbar + x_i - x_j & x_i - x_j \\ 2\hbar + x_i - x_j & \hbar + x_i - x_j \end{bmatrix} \quad i, j \in [n]$$

with the intriguing consequence that the n inhomogeneous linear equations $m_{i, n+i} = 1$ become invariant.

We actually want to impose n^2 conditions, not just n , but those n conditions just found suggest the following: define the submanifold L_2 by the matrix statement that the entire Northeast quadrant be the identity matrix.

To make this L_2 into a reduction, we need to submerge it onto the $\begin{array}{c} \boxed{n} \\ | \\ \textcircled{j} \text{---} \textcircled{j} \end{array}$ quiver variety, with fibers the null foliation of the presymplectic form on L_2 restricted from the ambient quiver variety. In fact we are in especial luck (that will run out after $d = 1$): L_2 is a *level*

set of a moment map, for the action of the abelian unipotent group $U := \left\{ \begin{bmatrix} I_n & 0 \\ * & I_n \end{bmatrix} \right\}$. By the Marsden–Weinstein theorem, the leaves of the null foliation on the moment map level set are exactly the orbits of U . To mod out by U , we want to use U -invariant functions of $\begin{bmatrix} A & I_n \\ C & D \end{bmatrix}$, and we use $A + D$. Redefine L_2 as the *Hamiltonian* reduction

$$L_2 := \left\{ ((X, V, W), (Y, V'')) : \begin{array}{l} X = \begin{pmatrix} A & \text{Id} \\ * & D \end{pmatrix}, Y = A + D \\ V \cap (0 \oplus \mathbb{C}^n) = 0 \oplus V'' \\ W/(0 \oplus \mathbb{C}^n) = (W' + \mathbb{C}^n)/(0 \oplus \mathbb{C}^n) \end{array} \right\}$$

$$\begin{array}{ccc} \swarrow & & \searrow \\ \{(X \in \text{End}(\mathbb{C}^{2n}), V^{n+j}, W^j)\} & & \{(Y \in \text{End}(\mathbb{C}^n), V''^j)\} \end{array}$$

This group U is normalized by the Levi subgroup $GL_n \oplus GL_n \leq GL_{2n}$, and U 's moment map “Northeast quadrant” is therefore $(GL_n \oplus GL_n)$ -equivariant. However, the value I_n is only invariant under the diagonal subgroup $(GL_n)_\Delta$, which descends to give the action we expect on the target of the Hamiltonian reduction.

One very important difference between L_1 and L_2 is that L_1 is conical. The reduction at 0 would keep the full $GL_n \oplus GL_n$ action.

Proposition 8.5. *The two Lagrangian correspondences L_1, L_2*

$$\begin{array}{c} \boxed{n} \\ | \\ \textcircled{j} - \textcircled{0} \end{array} \times \begin{array}{c} \boxed{n} \\ | \\ \textcircled{n} - \textcircled{j} \end{array} \xrightarrow{L_1} \begin{array}{c} \boxed{2n} \\ | \\ \textcircled{n+j} - \textcircled{j} \end{array} \xrightarrow{L_2} \begin{array}{c} \boxed{n} \\ | \\ \textcircled{j} - \textcircled{j} \end{array}$$

can be composed. Under the identification of first and third spaces with $T^*\text{Gr}(j, n)^2$ and $T^*\text{Gr}(j, n)$, the composite is the transpose $C\text{graph}(\Delta)^T$ of the conormal bundle of the graph of the diagonal inclusion.

Proof. We check the transversality (condition #1 of composability) by first projecting L_1, L_2 into the middle quiver variety, and checking that even the images of these inclusions already are transverse. This is essentially because the equations imposed are on disjoint variables (the SW and NE quadrants). Properness is easier: once X, Y are specified, the conditions on V, W, V' are closed conditions inside a product of Grassmannians.

The set-theoretic composition is easy to compute:

$$L_1 \star L_2 = \{(A, V', D', W'), (Y, V'') : Y = A + D, V' = W' = V''\}$$

This is again conical (which is surprising, since L_2 isn't conical), and lemma 8.2 again lets us identify this as the conormal bundle to $\{(V', W'), V'' : V' = W' = V''\}$ i.e. the transpose of the graph of the diagonal inclusion. \square

In particular, if we can follow stable classes along $L_1 \star L_2$ we can use this to compute products in cohomology, as follows.

Let β be the class of the transpose of the conormal bundle to the graph $\{(A, A, A)\}$ of the diagonal inclusion $\text{Gr}(j, n) \hookrightarrow \text{Gr}(j, n) \times \text{Gr}(j, n)$, so its β -transform goes from $H_{T \times \mathbb{C}^\times}^*(T^*\text{Gr}(j, n))^{\otimes 2}$ to $H_{T \times \mathbb{C}^\times}^*(T^*\text{Gr}(j, n))$ (both suitably localized). Then according to §8.3,

$$\frac{\Upsilon_\beta(\alpha_1 \otimes \alpha_2)}{e(T^*\text{Gr}(j, n))} = \frac{\alpha_1}{e(T^*\text{Gr}(j, n))} \frac{\alpha_2}{e(T^*\text{Gr}(j, n))}$$

8.6.3. *Following the stable classes.* On our intermediate quiver variety $\begin{array}{c} \boxed{2n} \\ | \\ \textcircled{n+j} - \textcircled{k} \end{array}$ we have two commuting one-parameter subgroups inside the “flavor group” $GL(2n)$ that acts at the framed $\boxed{2n}$ vertex. One is $z \mapsto \text{diag}(z^1, z^2, \dots, z^n, z^1, z^2, \dots, z^n)$ which we will call $(\check{\rho}_n)_\Delta$. The other is $z \mapsto \text{diag}(1, \dots, 1, z, \dots, z)$ which we have been calling Z . This gives us the left square below (ignore the right square for now) of stable envelopes, and we call these envelopes $\text{env}()$ depending on the group used:

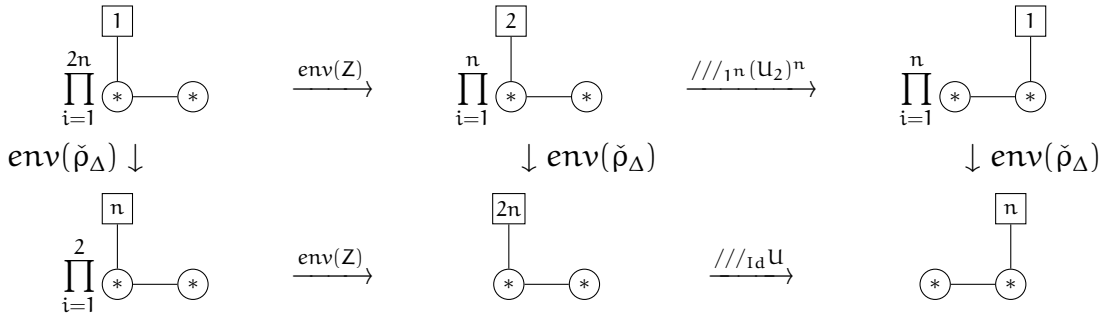

Note that this left square does *not* commute; rather, proposition 8.4 gives us ways to complete either the down-then-right or right-then-down paths in that square to *different* stable envelopes from Northwest to Southeast. Apply proposition 8.4 to down-then-right giving the circle

$$\text{diag}(z, z^2, \dots, z^n, z, z^2, \dots, z^n) \cdot \text{diag}(1, \dots, 1, z, \dots, z)^N$$

whose exponents are increasing (for $N \gg 0$, in particular, whenever $N \geq n$). Apply proposition 8.4 to right-then-down giving the circle

$$\text{diag}(z, z^2, \dots, z^n, z, z^2, \dots, z^n)^N \cdot \text{diag}(1, \dots, 1, z, \dots, z)$$

whose exponents are ordered in the riffle shuffle permutation of $2n$ cards. To express the first stable basis in the second requires multiplying $\binom{n}{2}$ R-matrices, as in [MO19, §4.1].

Consider the top of the right hand square, made of $\begin{array}{c} \boxed{2} \\ | \\ \textcircled{*} - \textcircled{*} \end{array} \xrightarrow{//_{1U_2}} \begin{array}{c} \boxed{1} \\ | \\ \textcircled{*} - \textcircled{*} \end{array}$ reductions. As explained in §8.6.1, this is modeling the quotient map $(\mathbb{C}^3)^{\otimes 2} \rightarrow \text{Alt}^2 \mathbb{C}^3$, losing

$\text{Sym}^2 \mathbb{C}^3$. The Hamiltonian reductions of the points $\begin{array}{c} \boxed{2} \\ | \\ \textcircled{0} - \textcircled{0} \end{array}, \begin{array}{c} \boxed{2} \\ | \\ \textcircled{2} - \textcircled{0} \end{array}, \begin{array}{c} \boxed{2} \\ | \\ \textcircled{2} - \textcircled{2} \end{array}$ are empty,

whereas the reductions of the $\begin{array}{c} \boxed{2} \\ | \\ \textcircled{1} - \textcircled{0} \end{array}, \begin{array}{c} \boxed{2} \\ | \\ \textcircled{1} - \textcircled{1} \end{array}, \begin{array}{c} \boxed{2} \\ | \\ \textcircled{2} - \textcircled{1} \end{array}$ spaces, each a $T^*\mathbb{P}^1$, are points.

A curious thing happens in the right-hand square: the down-then-right composite is not ordinarily defined insofar as the intersection is not transverse, but if one ignores this, the square commutes set-theoretically. This agreement is close enough that one can exploit it:

Proposition 8.6. *The induced map on localized equivariant cohomology, going down then right in the right-hand square above, is $\prod_{1 \leq i < j \leq n} \frac{x_j - x_i}{h + x_i - x_j}$ times the induced map from going right then down. In particular, it takes stable classes to either zero or to stable classes times that factor.*

Proof. We start with right-then-down, where the relations are composable. In all cases we work with the affine deformations, which as explained in §8.5 are varieties \mathcal{O}_ε of matrices with fixed spectrum. The right-moving, then down-moving, relations are

$$\left\{ \left(\left(\begin{bmatrix} a_1 & 1 \\ c_1 & d_1 \end{bmatrix}, \dots, \begin{bmatrix} a_n & 1 \\ c_n & d_n \end{bmatrix} \right), (a_1 + d_1, \dots, a_n + d_n) \right) \right\} : \prod_{i=1}^n \begin{array}{c} \boxed{2} \\ | \\ * \end{array} \text{---} * \rightarrow \prod_{i=1}^n \begin{array}{c} \boxed{1} \\ | \\ * \end{array} \text{---} *$$

$$\left\{ \left((e_1, \dots, e_n), \begin{bmatrix} e_1 & * & * \\ 0 & \ddots & * \\ 0 & 0 & e_n \end{bmatrix} \right) \right\} : \prod_{i=1}^n \begin{array}{c} \boxed{1} \\ | \\ * \end{array} \text{---} * \rightarrow * \text{---} \begin{array}{c} \boxed{n} \\ | \\ * \end{array}$$

This intersection is transverse, matching up each $a_i + d_i$ with its e_i . Also, the projection to the image is an isomorphism, resulting in the Lagrangian

$$\left\{ \left(\left(\begin{bmatrix} a_1 & 1 \\ c_1 & d_1 \end{bmatrix}, \dots, \begin{bmatrix} a_n & 1 \\ c_n & d_n \end{bmatrix} \right), \begin{bmatrix} a_1 + d_1 & * & * \\ 0 & \ddots & * \\ 0 & 0 & a_n + d_n \end{bmatrix} \right) \right\} : \prod_{i=1}^n \begin{array}{c} \boxed{2} \\ | \\ * \end{array} \text{---} * \rightarrow * \text{---} \begin{array}{c} \boxed{n} \\ | \\ * \end{array}$$

Now we write out the down-then-right Lagrangian relations we will try to compose, with partial success:

$$L_3 = \left\{ \left(\left(\begin{bmatrix} a_i & b_i \\ c_i & d_i \end{bmatrix} \right)_{i=1 \dots n}, \left[\begin{array}{ccc|ccc} a_1 & * & * & b_1 & * & * \\ 0 & \ddots & * & 0 & \ddots & * \\ 0 & 0 & a_n & 0 & 0 & b_n \\ \hline c_1 & * & * & d_1 & * & * \\ 0 & \ddots & * & 0 & \ddots & * \\ 0 & 0 & c_n & 0 & 0 & d_n \end{array} \right] \right) \right\} : \prod_{i=1}^n \begin{array}{c} \boxed{2} \\ | \\ * \end{array} \text{---} * \rightarrow * \text{---} \begin{array}{c} \boxed{2n} \\ | \\ * \end{array}$$

$$L_2 = \left\{ \left(\begin{bmatrix} A & I \\ C & D \end{bmatrix}, A + D \right) \right\} : \begin{array}{c} \boxed{2n} \\ | \\ * \end{array} \text{---} * \rightarrow * \text{---} \begin{array}{c} \boxed{n} \\ | \\ * \end{array}$$

The intersection is nontransverse, as the $B := \begin{bmatrix} b_1 & * & * \\ 0 & \ddots & * \\ 0 & 0 & b_n \end{bmatrix}$ matrix already has 0s in the

lower triangle, so asking $B = I$ imposes $\binom{n}{2}$ equations that are already satisfied. We deal with this as follows: remove those conditions on B . The result is a larger (non-Lagrangian) correspondence $L'_3 \supset L_3$, with class $[L'_3] = [L_3] / \prod \{x_j - x_{n+i} + \hbar : i < j\}$ as it has been divided by the weights of those equations.

Now the intersection *is* transverse, but its projection to $\left(\prod_{i=1}^n \begin{array}{c} \boxed{2} \\ | \\ * \end{array} \text{---} * \right) \times * \text{---} \begin{array}{c} \boxed{n} \\ | \\ * \end{array}$ is improper; specifically, the strict upper triangle of C cannot be reconstructed from the

first and third factors, nor can the strict upper triangles of A, D be determined individ-

ually. We will fix these two problems (soon) by asking that $A := \begin{bmatrix} a_1 & * & * \\ 0 & \ddots & * \\ 0 & 0 & a_n \end{bmatrix}$ be not

just triangular but diagonal. The result is a smaller correspondence $L_3'' \subset L_3'$, with class $[L_3''] = [L_3'] \prod \{x_i - x_j + \hbar : i < j\}$, having been multiplied by the weights of those newly imposed equations.

The intersection of the correspondences L_3'', L_2 is now

$$\left\{ \left(\left(\begin{bmatrix} a_i & b_i \\ c_i & d_i \end{bmatrix} \right)_{i=1 \dots n}, \left[\begin{array}{ccc|ccc} a_1 & 0 & 0 & b_1 & * & * \\ 0 & \ddots & 0 & * & \ddots & * \\ 0 & 0 & a_n & * & * & b_n \\ \hline c_1 & * & * & d_1 & * & * \\ 0 & \ddots & * & 0 & \ddots & * \\ 0 & 0 & c_n & 0 & 0 & d_n \end{array} \right] = \begin{bmatrix} A & I \\ C & D \end{bmatrix}, A + D \right\}$$

To show the properness of its projection to the first times third factors, it suffices to be able to uniquely reconstruct A, C, D from $\left(\begin{bmatrix} a_i & b_i \\ c_i & d_i \end{bmatrix} \right)_{i=1 \dots n}, A + D$. Since A is diagonal we can get it from $(a_i)_{i=1 \dots n}$. Knowing A and $A + D$ we get D . Obtaining C is trickier: since our $2n \times 2n$ matrix satisfies a cubic equation $(X - \varepsilon_1)(X - \varepsilon_2)(X - \varepsilon_3) = 0$, we get a linear relation between the NE quadrants of

$$I_{2n} = \begin{bmatrix} * & 0 \\ * & * \end{bmatrix} \quad X = \begin{bmatrix} * & I_n \\ * & * \end{bmatrix} \quad X^2 = \begin{bmatrix} * & A + D \\ * & * \end{bmatrix} \quad X^3 = \begin{bmatrix} * & A^2 + AD + D^2 + C \\ * & * \end{bmatrix}$$

(coefficient 1 on X^3) with which to determine C from A and D .

In order to bring in L_2 , we have to specialize as explained in §8.6.2 to $x_{n+i} = x_i + \hbar$.

Now the $L_3'' \star L_2$ convolution is defined and gives the same result as the right-then-down convolution, so, they induce the same map on localized equivariant cohomology. Consequently, the map on localized equivariant cohomology given by the original L_3 , then L_2 , is off by the factors above (specialized to $x_{n+i} = x_i + \hbar$). \square

We now give a schematic way of indexing the stable basis elements, on each of the six spaces in our double square diagram. There is a complication in that the intermediate space (bottom middle) has two relevant stable bases, related by a composition of $\binom{n}{2}$ R -matrices. In each of the below, a stable basis element corresponds to labeling $/, \backslash$ using $0, 1, 2$, and $_$ using $\{0, 1\}, \{0, 2\}, \{1, 2\}$. In these pictures, each stable envelope amounts to concatenating strings, whereas each of the reductions amounts to flattening an $\hat{\lambda}$ to an

$\{i, j\}$ if $i \neq j$.

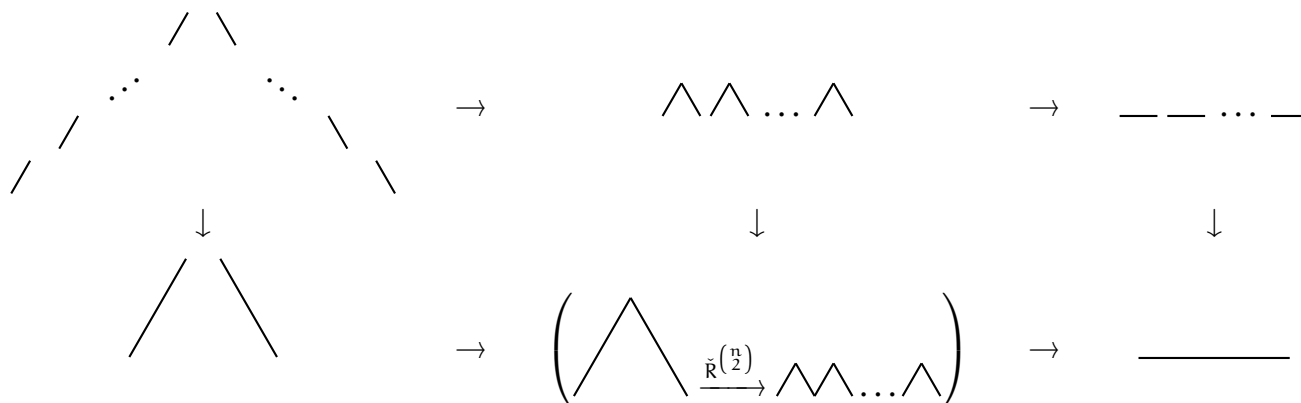

We have nearly arrived at puzzles.

- (1) We start with strings λ of content $1^k 2^{n-k}$, μ of content $0^k 1^{n-k}$, giving a point in the NW corner. Going down to the SW corner, we get the stable basis element $MO_\lambda \otimes MO_\mu$ on $(T^*Gr(k, n))^2$, which is of course where we want to start our product calculation (modulo the Gr vs. T^*Gr issue dealt with in §8.3).
- (2) Going East from the SW corner to the bottom middle, we get the stable basis element $MO_{\lambda\mu}$ on $T^*Fl(k, n+k; \mathbb{C}^{2n})$. So far nothing has happened on the puzzle side; we are just interpreting the NW-then-NE labels on the puzzle as a single stable class.
- (3) To rewrite our stable basis element $MO_{\lambda\mu}$ in terms of the stable basis coming from right-then-down in the left square, we use “the” reduced word for the riffle shuffle permutation. (It is unique up to commuting moves, no braiding necessary.) These correspond to filling in the $\binom{n}{2}$ rhombi in the puzzle, from top to bottom. We now have a linear combination of stable classes in the riffle-shuffle-permuted stable basis. We deal with them one by one. Let η be the labels on $\wedge \wedge \dots \wedge$.
- (4) Before attempting the reduction (bottom edge of the right square) of the η class, we pull this string apart into η_1, \dots, η_n labeling the individual sawteeth, and so seeing our η class as coming from a stable class from the top middle of the double square.
- (5) As we traverse the top of the right square, we either get a point (if $i \neq j$ in each $\hat{i}\hat{j}$) or the empty set. These correspond to being able or unable to complete each $\hat{i}\hat{j}$ to a triangular puzzle piece (with $\{i, j\}$ on the bottom).
- (6) Going down, we glue these $\{i, j\}$ into a string, taking the point to a class MO_ν on $T^*Gr(k, n)$.
- (7) The actual coefficient of MO_ν in the convolution we care about, down-right-right from the Northwest corner of the double square, comes from the $\binom{n}{2}$ R-matrix entries times the overall factor from proposition 8.6, summed over all the puzzles.

8.6.4. $d = 1$, computing fugacities. It remains to define the fugacities of the puzzle rhombus in position (i, j) , $i < j$, which in the planar dual cross the lines bearing rapidity $x_{n+i} = x_i + \hbar$ and x_j . These fugacities are the entries of the rational R-matrix $\check{R} \in \text{End}(\mathbb{C}^3 \otimes \mathbb{C}^3)$

(which was already given in (26)):

$$\vec{v}_a \otimes \vec{v}_b \mapsto \begin{cases} \frac{x_{n+i}-x_j}{\hbar+x_j-x_{n+i}} \vec{v}_b \otimes \vec{v}_a + \frac{\hbar}{\hbar+x_j-x_{n+i}} \vec{v}_a \otimes \vec{v}_b = \frac{\hbar+x_i-x_j}{x_j-x_i} \vec{v}_b \otimes \vec{v}_a + \frac{\hbar}{x_j-x_i} \vec{v}_a \otimes \vec{v}_b & \text{if } a \neq b \\ \vec{v}_a \otimes \vec{v}_a & \text{if } a = b \end{cases}$$

but we will scale the rhombus at position (i, j) by $\frac{x_j-x_i}{\hbar+x_i-x_j}$ in order to account for the overall factor from proposition 8.6. We then obtain fugacities

$$\vec{v}_a \otimes \vec{v}_b \mapsto \begin{cases} \vec{v}_b \otimes \vec{v}_a + \frac{\hbar}{\hbar+x_i-x_j} \vec{v}_a \otimes \vec{v}_b & \text{if } a \neq b \\ \frac{x_j-x_i}{\hbar+x_i-x_j} \vec{v}_a \otimes \vec{v}_a & \text{if } a = b \end{cases}$$

This is the desired result: compare with table 29. In particular, the rhombi with all labels 0 have fugacity 1, thus explaining the unusual choice of normalization of the R-matrix in (11). Equivalently, the factor of proposition 8.6 matches the lower right entry of table 29, which is due to the fact that highest weight R-matrix entries are always 1 in the geometric normalization.

With these, one can compute the action of the convolution $T^*Gr(k, n)^2 \xrightarrow{C_{\text{graph}(\Delta)}^T} T^*Gr(k, n)$ on stable basis elements, as a sum over puzzles. Using §8.3, we use that to compute the structure constants of multiplication of SSM classes, finally reproducing theorem 3.8 (in cohomology, for $d = 1$).

8.7. $d = 2$. The intermediate quiver varieties for $d = 2, 3, 4$ are not cotangent bundles, so to set the stage for them we revisit the $d = 1$ case from the quiver variety point of view. Consider the reduction L_2 as going between these not-quite-Nakajima quiver varieties:

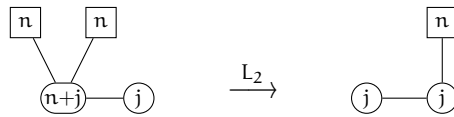

The image of L_2 embedded in the left quiver variety consists of those representations such

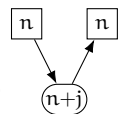
that the composite map  is the identity. This assumption produces a splitting of the $n + j$ vertex: the n -dimensional image of the map in, \oplus , the j -dimensional kernel of the map out. The splitting isn't really equitable – the n -dimensional image, despite sitting at a gauged vertex, has coordinates inherited from (either of) the two gauged \boxed{n} .

In this picture, the map from L_2 to the right-hand quiver variety does the following to a representation in the left-hand quiver variety: delete the two \boxed{n} vertices, and carry the newly found n -plane from the $n + j$ gauged vertex Northeast to become a framed \boxed{n} attached to the old j vertex. Written with spaces instead of their dimensions, this is

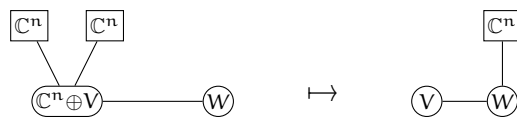

where each of the four morphisms in the second diagram (recall that each edge carries a morphism in each direction) is inferred from one of the horizontal morphisms in the first diagram.

Now we are ready to describe the Lagrangian correspondence required for $d = 2$, in

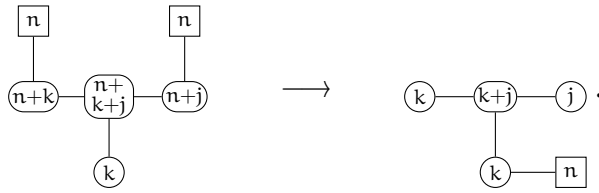

Once again, we seek a reduction losing $2n^2$ dimensions, so want to impose n^2 equations. The obvious gauge-invariant equations involve paths from one framed vertex to another. In addition, we want to split an \boxed{n} off of each of the three gauge vertices between the two frame vertices.

Accordingly, we ask that the composite map from the left \boxed{n} to the right \boxed{n} be the identity. This induces splittings of each of the $n+k$, $n+k+j$, $n+j$ gauge vertices into \boxed{n} plus a complement; throw all these n -planes away except the n -plane in the middle space (connected to the k below it), which we rip out and make into the \boxed{n} in the Southeast.

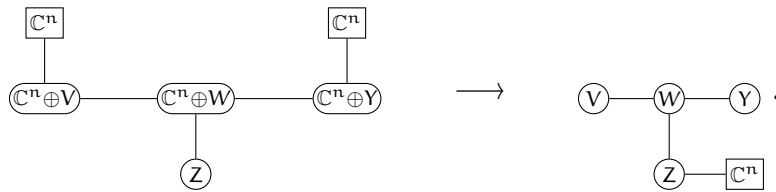

It is easy to derive an analogue of proposition 8.6 by following stable classes: we find that the length four path from the left \boxed{n} to the right \boxed{n} already has 0s in the lower triangle, resulting in a factor of $\prod_{i < j} (x_j - x_i)$; and the projection is improper, which can be fixed by zeroing out the upper triangle of e.g. the length 2 path from the left \boxed{n} to itself, resulting in a factor of $\prod_{i < j} (\hbar + x_i - x_j)^{-1}$. In the end we obtain the same table 29 of fugacities.

In contrast with the $d = 1$ case, the equations imposed do *not* form the moment map for a subgroup of the $(GL_n)^2$ that acts at the frame vertices. (The equations are not linear in the two GL_n moment maps, which are the endomorphisms of the \boxed{n} vertices.)

8.8. $d = 3, 4$. The principal new feature at $d = 3, 4$ is that the drop in dimension from the intermediate quiver variety to the final one is not $2n^2$ but is $4n^2, 6n^2$ respectively. Consequently, our reductions should result from imposing 2 or 3 matrix equations respectively instead of the 1 we imposed at each of $d = 1, 2$. We present here without proof how one can “guess” the form of the equations at $d = 3, 4$.

In equation (34) for $d = 1$, we learned that some of the equations should have weight $\hbar + x_i - y_i$. Since half the steps along a path contribute \hbar , there the path had two steps. By lemma 3.3, at $d = 1, 2, 3, 4$ the difference in spectral parameters is $\hbar_d/3 = 1, 2, 4, 10$ times \hbar . This retrodicts the $d = 2$ path having four steps. For all d we therefore expect an *inhomogeneous* equation of the form “some path of length $\hbar_d/3$, from one framed vertex to another, equals the identity matrix”.

The \hbar -weights of *all* the equations can be predicted from the factors in the numerator of the SE entry of the table of fugacities (see §5.3 and §5.4): we add $\hbar_d/3$ to their \hbar coefficients

to get the \hbar -weights, or half-lengths, of the paths:

d	1	2	3	4
$\hbar_d/3$	1	2	4	10
numerator	x	x	$x(x - 3\hbar)$	$x(x - 4\hbar)(x - 9\hbar)$
\hbar -weights	1	2	4, 1	10, 6, 1
path lengths	2	4	8, 2	20, 12, 2

The reasoning is that each path creates a redundant set of equations which is that its lower triangle is zero; necessarily, such paths have the same endpoints as the one of the inhomogeneous equation (trivially at $d = 1, 2$ because there's only one path; and trivially at $d = 3, 4$ because there's only one possible endpoint); the resulting weights of a path of length ℓ are of the form $\frac{\ell}{2}\hbar + x_j - y_i$, $i < j$, which upon substitution $y_i = x_i + \frac{\hbar_d}{3}\hbar$, $x = x_j - x_i$, gives $x - (\frac{\hbar_d}{3} - \frac{\ell}{2})\hbar$.

Studying the algebras of paths (modulo the moment map equations) leads to a unique solution to the constraints above for $d = 3, 4$ which we present now. (A related result is [EE07, Theorem 3.4.1], applied to the X_{2d} quiver plus the framed vertex.)

The $d = 3$ reduction

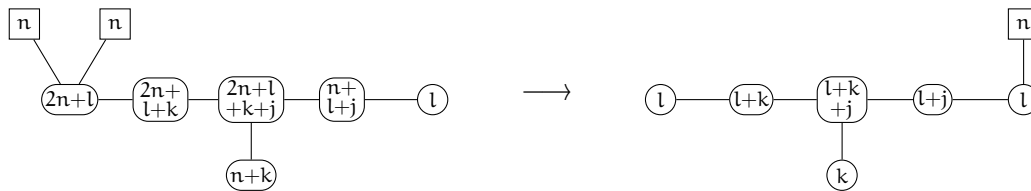

is obtained from the following two matrix equations, both described using paths from the left \boxed{n} to the right \boxed{n} : the length 8 path going to and from the $n + k$ vertex gives the identity, and the direct path of length 2 gives 0:

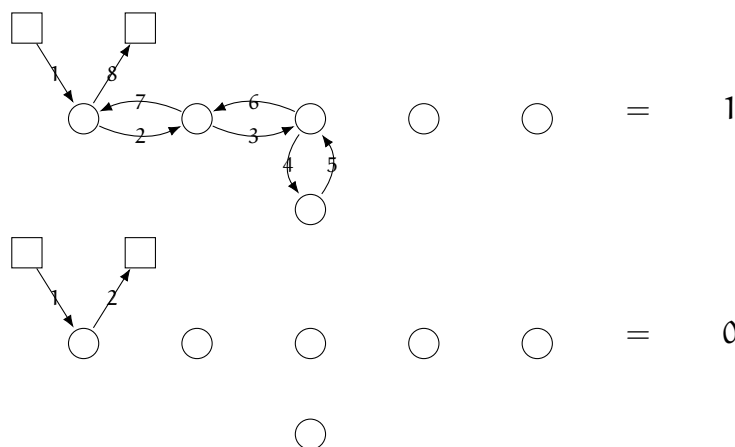

We already know how to use the length 8 path to split off an \boxed{n} from each of the vertices it passes through, but that doesn't help with the $n + l + j$ vertex. So we observe now that the other length 8 path, to $n + l + j$ and back, must also give the identity matrix (up to a sign choice). Proof: by the moment map condition at the trivalent vertex, the difference

of the paths gives (up to another sign choice)

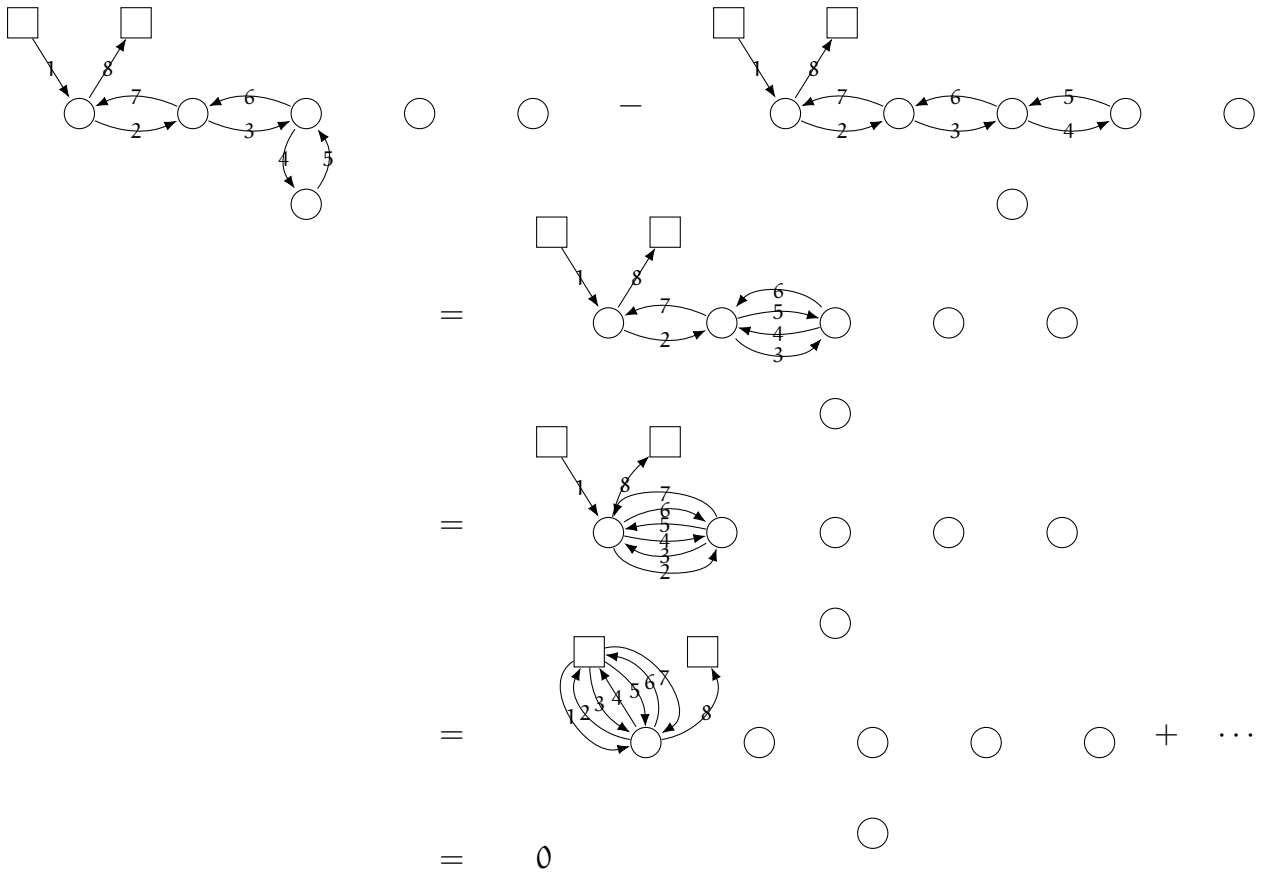

I.e., since the length 2 path (as an endomorphism of $\boxed{2n}$) is assumed to have NE quadrant zero, the same is true of its fourth power, verifying that the two length 8 paths (as endomorphisms of $\boxed{2n}$) agree in their NE quadrants, so *both* have the identity matrix there.

It is then a fun linear algebra exercise to show that these give direct sum decompositions of the $2n + \dots$ vertices into $\boxed{n} \oplus \boxed{n} \oplus \dots$, and also split an \boxed{n} off each of the $n + l + j, n + k$ vertices. We take the \boxed{n} split off the $n + l + j$ vertex and attach it as a new \boxed{n} to the l vertex.

The $d = 4$ reduction

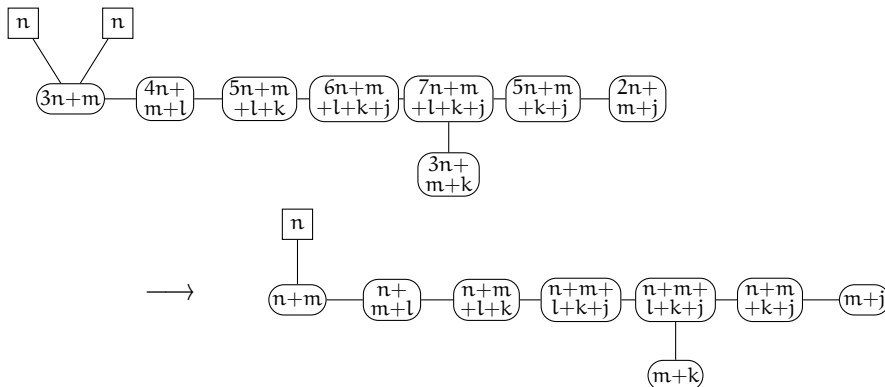

similarly results from the three paths:

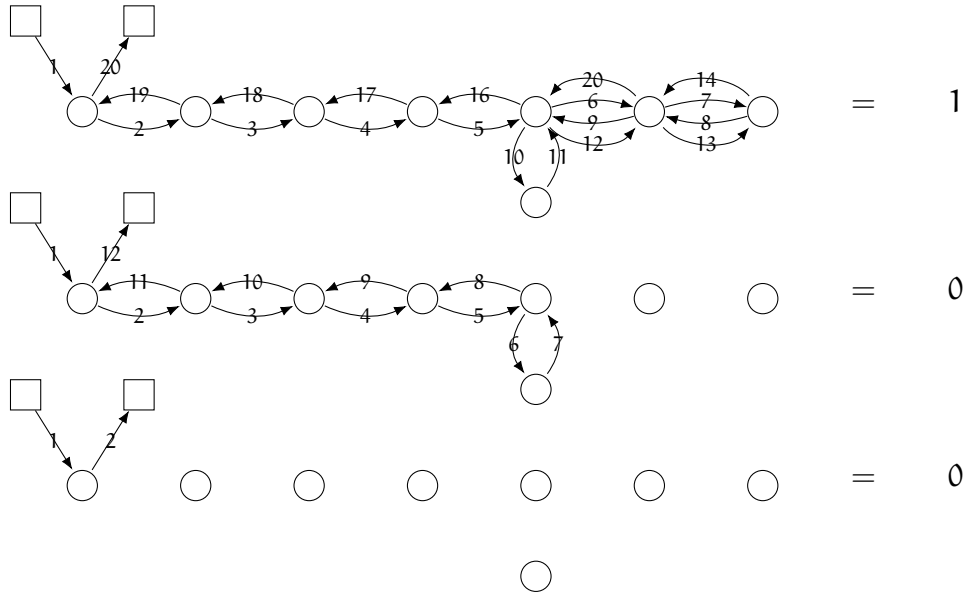

APPENDIX A. QUANTIZED AFFINE ALGEBRAS

A.1. Generators and relations. Let \mathfrak{g} be a simple or affine algebra, with a Cartan matrix C_{ij} . Since we are only interested in simply-laced simple Lie algebras and the corresponding untwisted affine algebras, all the formulæ below are written for C_{ij} *symmetric* (and $C = 2 - A$ where A is the adjacency matrix of the Dynkin diagram of \mathfrak{g}).

The quantized affine algebra $\mathcal{U}_q(\mathfrak{g})$ is the $\mathbb{C}(q)$ -algebra given by generators $\{E_i, F_i, K_i^{\pm 1}\}$ and relations

$$\begin{aligned} K_i K_j &= K_j K_i \\ K_i E_j K_i^{-1} &= q^{C_{ij}} E_j \quad K_i F_j K_i^{-1} = q^{-C_{ij}} F_j \quad [E_i, F_j] = \delta_{ij} \frac{K_i - K_i^{-1}}{q - q^{-1}} \\ \sum_{k=0}^{1-C_{ij}} (-1)^k \begin{bmatrix} 1 - C_{ij} \\ k \end{bmatrix}_q E_i^{1-C_{ij}-k} E_j E_i^k &= 0 \\ \sum_{k=0}^{1-C_{ij}} (-1)^k \begin{bmatrix} 1 - C_{ij} \\ k \end{bmatrix}_q F_i^{1-C_{ij}-k} F_j F_i^k &= 0 \end{aligned}$$

in terms of the q -binomials $\begin{bmatrix} m \\ n \end{bmatrix}_q := \frac{(q^m - q^{-m}) \dots (q^{m-n+1} - q^{-m+n-1})}{(q^n - q^{-n}) \dots (q - q^{-1})}$. Their coproduct is

$$\Delta(E_i) = E_i \otimes K_i + 1 \otimes E_i \quad \Delta(F_i) = F_i \otimes 1 + K_i^{-1} \otimes F_i \quad \Delta(K_i) = K_i \otimes K_i$$

(we omit counit and antipode since they will not be needed here).

A.2. Affine case. In the affine case, the labels are traditionally chosen to be $0, \dots, r$ where 0 is the affine root.

Because the Cartan matrix has rank r (one less than its size), the algebra possesses a nontrivial gradation (not induced by a Cartan element). A possible choice (homogeneous gradation) is

$$\delta(E_i) = \delta_{i,0} \quad \delta(F_i) = -\delta_{i,0} \quad \delta(K_i) = 0$$

We can then extend the algebra by adding a degree generator q^D such that $q^D \chi q^{-D} = q^{\delta(\chi)} \chi$ for any homogeneous element χ .

Relatedly, the Cartan matrix has a nullspace: $\sum_i m_i C_{ij} = 0$, which implies that $K := \prod_{i=0}^r K_i^{m_i}$ is central. The quotient of $\mathcal{U}_q(\mathfrak{g})$ (including the degree generator q^D) by the relation $K = 1$ is the corresponding quantized loop algebra $\mathcal{U}_q(\mathfrak{h}[z^{\pm}])$ where $\mathfrak{g} = \mathfrak{h}^{(1)}$.

A.3. Evaluation representation. Consider the case $\mathfrak{g} = \mathfrak{a}_d^{(1)}$, as in §2. We make $\mathcal{U}_q(\mathfrak{a}_d[z^{\pm}])$ act on $V^\Lambda(z)$, with basis e_0, \dots, e_d over $\mathbb{C}(q)[z^{\pm}]$, by

$$\begin{aligned} E_i e_{j-1} &= \delta_{i,j} z^{-\delta_{i,0}} e_j \\ F_i e_j &= \delta_{i,j} z^{\delta_{i,0}} e_{j-1} \\ K_i e_j &= q^{\delta_{i,j} - \delta_{i,j+1}} e_j \end{aligned}$$

where indices i, j are considered in $\mathbb{Z}/(d+1)\mathbb{Z}$. The degree operator is given by $D = -z \frac{d}{dz}$.

One can then check that $\check{R}(z''/z')$ given by (1) is the unique (up to normalization) intertwiner from $V^\Lambda(z') \otimes V^\Lambda(z'')$ to $V^\Lambda(z'') \otimes V^\Lambda(z')$.

APPENDIX B. R-MATRICES AT $d = 1$

As a special case of the previous appendix, consider the $d = 1$ case of $\mathfrak{r}_{2d}^{(1)} = \mathfrak{a}_2^{(1)}$, i.e., the Cartan matrix $C = \begin{pmatrix} 2 & -1 & -1 \\ -1 & 2 & -1 \\ -1 & -1 & 2 \end{pmatrix}$ corresponding to the affine Dynkin diagram



The representation matrices ρ_α on $V_\alpha(1)$ in the basis $\{e_{\alpha,1}, e_{\alpha,0}, e_{\alpha,10}\}$ are:

$$\begin{aligned} \rho_1(E_0) &= \begin{pmatrix} 0 & 0 & 0 \\ 0 & 0 & 0 \\ -q & 0 & 0 \end{pmatrix} & \rho_1(E_1) &= \begin{pmatrix} 0 & 1 & 0 \\ 0 & 0 & 0 \\ 0 & 0 & 0 \end{pmatrix} & \rho_1(E_2) &= \begin{pmatrix} 0 & 0 & 0 \\ 0 & 0 & -q^{-1} \\ 0 & 0 & 0 \end{pmatrix} \\ \rho_1(F_0) &= \begin{pmatrix} 0 & 0 & -q^{-1} \\ 0 & 0 & 0 \\ 0 & 0 & 0 \end{pmatrix} & \rho_1(F_1) &= \begin{pmatrix} 0 & 0 & 0 \\ 1 & 0 & 0 \\ 0 & 0 & 0 \end{pmatrix} & \rho_1(F_2) &= \begin{pmatrix} 0 & 0 & 0 \\ 0 & 0 & 0 \\ 0 & -q & 0 \end{pmatrix} \\ \rho_1(K_0) &= \begin{pmatrix} q^{-1} & 0 & 0 \\ 0 & 1 & 0 \\ 0 & 0 & q \end{pmatrix} & \rho_1(K_1) &= \begin{pmatrix} q & 0 & 0 \\ 0 & q^{-1} & 0 \\ 0 & 0 & 1 \end{pmatrix} & \rho_1(K_2) &= \begin{pmatrix} 1 & 0 & 0 \\ 0 & q & 0 \\ 0 & 0 & q^{-1} \end{pmatrix} \\ \\ \rho_2(E_0) &= \begin{pmatrix} 0 & 0 & 0 \\ 0 & 0 & -q^{-1} \\ 0 & 0 & 0 \end{pmatrix} & \rho_2(E_1) &= \begin{pmatrix} 0 & 0 & 0 \\ 0 & 0 & 0 \\ -q & 0 & 0 \end{pmatrix} & \rho_2(E_2) &= \begin{pmatrix} 0 & 1 & 0 \\ 0 & 0 & 0 \\ 0 & 0 & 0 \end{pmatrix} \\ \rho_2(F_0) &= \begin{pmatrix} 0 & 0 & 0 \\ 0 & 0 & 0 \\ 0 & -q & 0 \end{pmatrix} & \rho_2(F_1) &= \begin{pmatrix} 0 & 0 & -q^{-1} \\ 0 & 0 & 0 \\ 0 & 0 & 0 \end{pmatrix} & \rho_2(F_2) &= \begin{pmatrix} 0 & 0 & 0 \\ 1 & 0 & 0 \\ 0 & 0 & 0 \end{pmatrix} \\ \rho_2(K_0) &= \begin{pmatrix} 1 & 0 & 0 \\ 0 & q & 0 \\ 0 & 0 & q^{-1} \end{pmatrix} & \rho_2(K_1) &= \begin{pmatrix} q^{-1} & 0 & 0 \\ 0 & 1 & 0 \\ 0 & 0 & q \end{pmatrix} & \rho_2(K_2) &= \begin{pmatrix} q & 0 & 0 \\ 0 & q^{-1} & 0 \\ 0 & 0 & 1 \end{pmatrix} \\ \\ \rho_3(E_0) &= \begin{pmatrix} 0 & 0 & 0 \\ -1 & 0 & 0 \\ 0 & 0 & 0 \end{pmatrix} & \rho_3(E_1) &= \begin{pmatrix} 0 & 0 & 0 \\ 0 & 0 & 0 \\ 0 & 1 & 0 \end{pmatrix} & \rho_3(E_2) &= \begin{pmatrix} 0 & 0 & 1 \\ 0 & 0 & 0 \\ 0 & 0 & 0 \end{pmatrix} \\ \rho_3(F_0) &= \begin{pmatrix} 0 & -1 & 0 \\ 0 & 0 & 0 \\ 0 & 0 & 0 \end{pmatrix} & \rho_3(F_1) &= \begin{pmatrix} 0 & 0 & 0 \\ 0 & 0 & 1 \\ 0 & 0 & 0 \end{pmatrix} & \rho_3(F_2) &= \begin{pmatrix} 0 & 0 & 0 \\ 0 & 0 & 0 \\ 1 & 0 & 0 \end{pmatrix} \\ \rho_3(K_0) &= \begin{pmatrix} q^{-1} & 0 & 0 \\ 0 & q & 0 \\ 0 & 0 & 1 \end{pmatrix} & \rho_3(K_1) &= \begin{pmatrix} 1 & 0 & 0 \\ 0 & q^{-1} & 0 \\ 0 & 0 & q \end{pmatrix} & \rho_3(K_2) &= \begin{pmatrix} q & 0 & 0 \\ 0 & 1 & 0 \\ 0 & 0 & q^{-1} \end{pmatrix} \end{aligned}$$

We then include the effect of the gradation by writing, for $V_\alpha(z)$,

$$\rho_{\alpha,z}(g) = z^{-\delta(g)} \rho_\alpha(g)$$

for all homogeneous elements g .

Remark. One could have chosen the entries of E_i and F_i to be 0 or 1 (as in appendix A.3) since these representations are minuscule; it is however convenient to renormalize the basis elements labeled 10 by powers of $-q$, which is related to the different role of this label compared to single numbers (see §3.5, in particular footnote 8)

We list here the single-color R-matrices at $d = 1$:

$$\check{R}_{1,1}(z', z'') = \begin{pmatrix} 1 & 0 & 0 & 0 & 0 & 0 & 0 & 0 & 0 \\ 0 & \frac{(q^2-1)z''}{q^2z''-z'} & 0 & \frac{q(z''-z')}{q^2z''-z'} & 0 & 0 & 0 & 0 & 0 \\ 0 & 0 & \frac{(q^2-1)z''}{q^2z''-z'} & 0 & 0 & 0 & \frac{q(z''-z')}{q^2z''-z'} & 0 & 0 \\ 0 & \frac{q(z''-z')}{q^2z''-z'} & 0 & \frac{(q^2-1)z'}{q^2z''-z'} & 0 & 0 & 0 & 0 & 0 \\ 0 & 0 & 0 & 0 & 1 & 0 & 0 & 0 & 0 \\ 0 & 0 & 0 & 0 & 0 & \frac{(q^2-1)z''}{q^2z''-z'} & 0 & \frac{q(z''-z')}{q^2z''-z'} & 0 \\ 0 & 0 & \frac{q(z''-z')}{q^2z''-z'} & 0 & 0 & 0 & \frac{(q^2-1)z'}{q^2z''-z'} & 0 & 0 \\ 0 & 0 & 0 & 0 & 0 & \frac{q(z''-z')}{q^2z''-z'} & 0 & \frac{(q^2-1)z'}{q^2z''-z'} & 0 \\ 0 & 0 & 0 & 0 & 0 & 0 & 0 & 0 & 1 \end{pmatrix}$$

$$\check{R}_{2,2}(z', z'') = \begin{pmatrix} 1 & 0 & 0 & 0 & 0 & 0 & 0 & 0 & 0 \\ 0 & \frac{(q^2-1)z''}{q^2z''-z'} & 0 & \frac{q(z''-z')}{q^2z''-z'} & 0 & 0 & 0 & 0 & 0 \\ 0 & 0 & \frac{(q^2-1)z'}{q^2z''-z'} & 0 & 0 & 0 & \frac{q(z''-z')}{q^2z''-z'} & 0 & 0 \\ 0 & \frac{q(z''-z')}{q^2z''-z'} & 0 & \frac{(q^2-1)z'}{q^2z''-z'} & 0 & 0 & 0 & 0 & 0 \\ 0 & 0 & 0 & 0 & 1 & 0 & 0 & 0 & 0 \\ 0 & 0 & 0 & 0 & 0 & \frac{(q^2-1)z'}{q^2z''-z'} & 0 & \frac{q(z''-z')}{q^2z''-z'} & 0 \\ 0 & 0 & \frac{q(z''-z')}{q^2z''-z'} & 0 & 0 & 0 & \frac{(q^2-1)z''}{q^2z''-z'} & 0 & 0 \\ 0 & 0 & 0 & 0 & 0 & \frac{q(z''-z')}{q^2z''-z'} & 0 & \frac{(q^2-1)z''}{q^2z''-z'} & 0 \\ 0 & 0 & 0 & 0 & 0 & 0 & 0 & 0 & 1 \end{pmatrix}$$

$$\check{R}_{3,3}(z', z'') = \begin{pmatrix} 1 & 0 & 0 & 0 & 0 & 0 & 0 & 0 & 0 \\ 0 & \frac{(q^2-1)z''}{q^2z''-z'} & 0 & \frac{q(z''-z')}{q^2z''-z'} & 0 & 0 & 0 & 0 & 0 \\ 0 & 0 & \frac{(q^2-1)z''}{q^2z''-z'} & 0 & 0 & 0 & \frac{q(z''-z')}{q^2z''-z'} & 0 & 0 \\ 0 & \frac{q(z''-z')}{q^2z''-z'} & 0 & \frac{(q^2-1)z'}{q^2z''-z'} & 0 & 0 & 0 & 0 & 0 \\ 0 & 0 & 0 & 0 & 1 & 0 & 0 & 0 & 0 \\ 0 & 0 & 0 & 0 & 0 & \frac{(q^2-1)z'}{q^2z''-z'} & 0 & \frac{q(z''-z')}{q^2z''-z'} & 0 \\ 0 & 0 & \frac{q(z''-z')}{q^2z''-z'} & 0 & 0 & 0 & \frac{(q^2-1)z'}{q^2z''-z'} & 0 & 0 \\ 0 & 0 & 0 & 0 & 0 & \frac{q(z''-z')}{q^2z''-z'} & 0 & \frac{(q^2-1)z''}{q^2z''-z'} & 0 \\ 0 & 0 & 0 & 0 & 0 & 0 & 0 & 0 & 1 \end{pmatrix}$$

Note that these matrices are subtly different – even though $V_1(z)$ and $V_2(z)$ are isomorphic, the bases we choose for them are different.

We also provide $\check{R}_{1,2}(z', z'')$, which is the building block of puzzles (here $z := z''/z'$):

$$\begin{array}{c}
 \begin{array}{c} 1\wedge 1 \\ 1\wedge 0 \\ 1\vee 10 \\ 0\vee 1 \\ 0\vee 0 \\ 0\vee 10 \\ 10\vee 1 \\ 10\vee 0 \\ 10\vee 10 \end{array}
 \left[\begin{array}{ccc|ccc|ccc}
 1\wedge 1 & 1\wedge 0 & 1\wedge 10 & 0\wedge 1 & 0\wedge 0 & 0\wedge 10 & 10\wedge 1 & 10\wedge 0 & 10\wedge 10 \\
 1-z & 0 & 0 & 0 & 0 & 1-q^{-2} & 0 & 0 & 0 \\
 0 & 0 & 0 & q^{-1}-qz & 0 & 0 & 0 & 0 & 0 \\
 0 & 0 & 0 & 0 & (q^2-1)z & 0 & 1-z & 0 & 0 \\
 \hline
 0 & 1-z & 0 & 0 & 0 & 0 & 0 & 0 & q^{-1}(q^{-2}-1) \\
 0 & 0 & 0 & 0 & 1-z & 0 & 1-q^{-2} & 0 & 0 \\
 0 & 0 & 0 & 0 & 0 & 0 & 0 & q^{-1}-qz & 0 \\
 \hline
 0 & 0 & q^{-1}-qz & 0 & 0 & 0 & 0 & 0 & 0 \\
 (q^2-1)z & 0 & 0 & 0 & 0 & 1-z & 0 & 0 & 0 \\
 0 & q(1-q^2)z & 0 & 0 & 0 & 0 & 0 & 0 & 1-z
 \end{array} \right]
 \end{array}$$

$1-z$

At the specialization $z'' = q^{-2}z'$ (or $z = q^{-2}$) from lemma 3.3, this matrix drops to rank 3 and factors (nonuniquely) as

$$\begin{array}{c}
 \begin{array}{c} 1 \\ 0 \\ 10 \\ 0 \\ 0 \\ 0 \\ 10 \\ 10 \\ 10 \end{array}
 \left[\begin{array}{ccc}
 1 & 0 & 10 \\
 1 & 0 & 0 \\
 0 & 0 & 0 \\
 0 & 1 & 0 \\
 \hline
 0 & 0 & 1 \\
 0 & 1 & 0 \\
 0 & 0 & 0 \\
 \hline
 0 & 0 & 0 \\
 1 & 0 & 0 \\
 0 & 0 & -q
 \end{array} \right]
 \begin{array}{c}
 1 \\ 0 \\ 10
 \end{array}
 \left[\begin{array}{ccc|ccc|ccc}
 1\wedge 1 & 1\wedge 0 & 1\wedge 10 & 0\wedge 1 & 0\wedge 0 & 0\wedge 10 & 10\wedge 1 & 10\wedge 0 & 10\wedge 10 \\
 1 & 0 & 0 & 0 & 0 & 1 & 0 & 0 & 0 \\
 0 & 0 & 0 & 0 & 1 & 0 & 1 & 0 & 0 \\
 0 & 1 & 0 & 0 & 0 & 0 & 0 & 0 & -q^{-1}
 \end{array} \right]
 \end{array}$$

It is interesting to note that this rule again enjoys the \mathbb{Z}_3 rotational symmetry that was already notable in K-theory:

$$c_{\lambda\mu}^{\check{\vee}} = \pi_*([\mathcal{X}_\lambda][\mathcal{X}_\mu][\mathcal{X}_\nu][\mathcal{O}(1)]), \quad \pi: \text{Gr}(k, n) \rightarrow \text{pt}$$

(see [Buc02, §8]).

APPENDIX C. EXAMPLES OF $d = 4$ PUZZLES

We depict $d = 4$ puzzles using the standard multinumber notation. A word of warning is needed: this notation is *not* unique at $d = 4$, i.e., the same weight can be represented by several multinumbers. We make here an arbitrary choice (ordering equivalent multinumbers by length / lexicographically, then picking the smallest).

C.1. $d = 3$ vs $d = 4$. The coefficient of S^{2301} in $S^{2103}S^{0321}$ in H_{\uparrow}^{*loc} is given by 26 $d = 3$ puzzles; at $d = 4$, there are 11 additional puzzles, such as

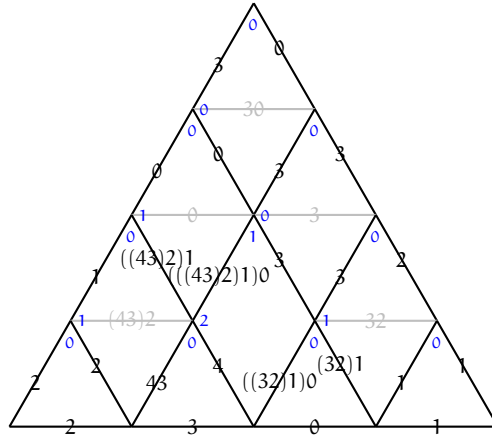

One can check that the sum of fugacities is the same in both cases:

$$\frac{\hbar^2 (x_2 - x_3) (x_1 - x_4)}{(\hbar + x_1 - x_3) (\hbar + x_2 - x_3) (\hbar + x_1 - x_4) (\hbar + x_2 - x_4)}$$

Note that the sum of fugacities of the $d = 4$ extra puzzles does *not* vanish! This is possible because fugacities are different at $d = 4$ (even for puzzles which would already appear at $d = 3$), as explained in §5.4.

C.2. Zero weight states. As explained in §5.4, a new feature of $d = 4$ puzzles is that the corresponding representation has a weight space of dimension greater than one, namely, the zero weight space. These zero weight states must be treated separately, cf proposition 5.2. Here is a full example involving them. Let us compute the expansion of $\underline{S}^{01432} \underline{S}^{21043}$ in ordinary Schubert calculus in the full flag variety of \mathbb{C}^5 ; equivalently, we work in $H_{\mathbb{C}^\times}^{*loc}$ and keep only the terms in the expansion of $S^{01432} S^{21043}$ whose labels have lowest inversion number $\ell(01432) + \ell(21043) = 7$:

$$S^{01432} S^{21043} = S^{41302} + S^{34102} + S^{43012} + S^{24301} + S^{42031} + S^{24130} + S^{41230} + \dots$$

Each of the terms in the r.h.s. except the last one is obtained from a single $d = 4$ puzzle:

This time the table of fugacities

$$\frac{1}{5} \begin{bmatrix} -4 & 1 & 1 & 1 & 1 \\ 1 & -4 & 1 & 1 & 1 \\ 1 & 1 & -4 & 1 & 1 \\ 1 & 1 & 1 & -4 & 1 \\ 1 & 1 & 1 & 1 & -4 \end{bmatrix}$$

sums up to 0, consistent with the fact that $\ell(10432) + \ell(21043) = 4 + 4 = 8 > 7 = \ell(41230)$.

APPENDIX D. SCALAR PRODUCTS

We provide here the scalar products (for $d \leq 3$) of weights given in terms of multinumbers. More precisely, given two multinumbers X and Y , the table below provides the scalar products $\langle \vec{f}_X, \tau \vec{f}_Y \rangle$ corresponding to any of the following configurations:

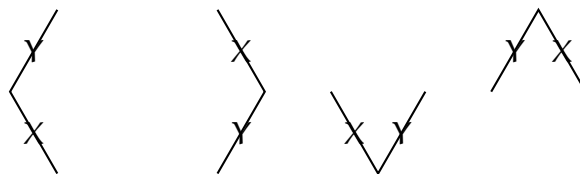

In the notations of §5, the first (resp. last) two compute the scalar product s (resp. t).

As in §5, we parametrize the scalar products as $-1 + ka$ where $a = 3, 2, 3/2$ for $d = 1, 2, 3$; and only indicate k in the table. This way, the tables for $d = 1, 2$ are subtables of the $d = 3$ table shown below.

X\Y	0	1	2	3	10	20	21	30	31	32	2(10)	3(10)	3(20)	(21)0	3(21)	(31)0	(32)0	(32)1	3(2(10))	(32)((21)0)	(3(21))0	((32)1)0	3(((32)1)0)						
0	0	0	0	0	1	1	0	1	0	0	1	1	1	1	0	1	1	0	1	0	1	1	1	1	2	1			
1	1	0	0	0	0	1	1	1	1	0	0	0	0	1	1	1	1	1	0	0	1	1	2	1	1	1			
2	1	1	0	0	1	0	0	1	1	1	0	1	0	1	0	2	1	1	1	0	0	0	1	1	1	1			
3	1	1	1	0	1	1	1	0	0	0	1	0	0	1	0	1	1	1	1	0	0	1	1	1	2	1	0		
10	0	1	0	0	0	0	1	0	1	0	1	1	0	1	0	1	0	1	1	1	1	1	1	2	1	1	1		
20	0	1	1	0	1	0	0	0	0	1	1	1	1	0	0	1	1	1	2	1	0	1	0	1	1	1	1		
21	1	0	1	0	1	1	0	1	0	1	0	0	1	0	1	1	2	1	1	0	0	1	1	0	1	1	1		
30	0	1	1	1	1	1	1	0	0	0	2	1	1	1	0	0	0	0	1	1	1	1	0	1	1	1	0		
31	1	0	1	1	1	2	1	1	0	0	1	0	1	1	1	0	1	0	0	0	1	1	1	0	1	1	0		
32	1	1	0	1	1	1	1	1	1	0	1	1	0	2	0	1	0	0	0	0	1	0	1	1	1	1	0		
2(10)	1	1	1	0	0	0	1	0	1	1	0	0	0	0	1	1	1	2	1	1	0	1	1	1	1	0	1		
3(10)	1	1	1	1	0	1	2	0	1	0	1	0	0	1	1	0	0	1	0	1	1	1	1	1	1	1	0	0	
3(20)	1	2	1	1	1	0	1	0	1	1	1	1	0	1	0	1	0	1	1	1	0	0	0	1	1	0	0		
(21)0	0	0	1	0	0	1	1	0	0	0	1	0	1	0	1	0	1	1	1	1	1	2	1	1	1	1	1		
3(21)	1	1	1	1	2	1	0	1	0	1	1	1	1	1	0	1	1	0	1	0	0	0	0	0	0	1	1	0	
(31)0	0	0	0	1	0	1	1	1	1	0	1	1	1	1	1	0	0	0	0	1	2	1	1	1	0	1	1		
(32)0	0	1	0	1	1	0	0	1	1	1	1	2	1	1	0	1	0	0	1	1	1	0	0	1	0	1	1		
(32)1	1	0	0	1	1	1	0	2	1	1	0	1	1	1	1	1	1	0	0	0	1	0	1	0	0	1	1		
(32)(10)	1	1	0	1	0	0	1	1	2	1	0	1	0	1	1	1	0	1	0	1	1	0	1	1	0	0	1		
3(2(10))	2	1	1	1	1	1	1	1	1	1	0	0	0	1	1	1	1	1	1	0	0	0	0	1	0	1	0	0	
3((21)0)	1	1	2	1	1	1	1	0	0	1	1	0	1	0	1	0	1	1	1	1	0	1	0	0	1	0	0		
(32)((21)0)	1	1	1	1	1	0	0	1	1	2	0	1	1	0	1	1	1	1	1	1	0	0	0	0	0	0	1		
(3(21))0	0	0	1	1	1	1	0	1	0	1	1	1	2	0	1	0	1	0	1	1	1	1	0	0	0	1	1		
(3(21))(10)	1	0	1	1	0	1	1	1	1	1	0	0	1	0	2	0	1	1	0	1	1	1	1	0	0	0	1		
((32)1)0	0	0	0	0	0	0	0	1	1	1	0	1	1	0	1	1	1	1	1	1	1	1	1	1	1	1	0	1	2
(3(2(10)))0	0	1	1	1	0	0	1	0	1	1	1	1	1	0	1	0	0	1	1	2	1	1	0	1	0	0	1		
3(((32)1)0)	1	1	1	2	1	1	1	1	1	1	1	1	1	1	1	0	0	0	0	1	1	0	0	0	0	0	0		

REFERENCES

- [AMSS17] P. Aluffi, L. Mihalcea, J. Schürmann, and C. Su, *Shadows of characteristic cycles, Verma modules, and positivity of Chern–Schwartz–MacPherson classes of Schubert cells*, 2017, arXiv:1709.08697.
- [AMSS19] ———, *Motivic Chern classes of Schubert cells, Hecke algebras, and applications to Casselman’s problem*, 2019, arXiv:1902.10101.
- [AO17] M. Aganagic and Andrei Okounkov, *Quasimap counts and Bethe eigenfunctions*, Mosc. Math. J. **17** (2017), no. 4, 565–600, arXiv:1704.08746, doi:10.17323/1609-4514-2017-17-4-565-600.
- [Bec94] J. Beck, *Braid group action and quantum affine algebras*, Comm. Math. Phys. **165** (1994), no. 3, 555–568, arXiv:hep-th/9404165. MR1301623.
- [Bri02] Michel Brion, *Positivity in the Grothendieck group of complex flag varieties*, J. Algebra **258** (2002), 137–159, Special issue in celebration of Claudio Procesi’s 60th birthday.
- [Buc02] Anders S. Buch, *A Littlewood–Richardson rule for the K-theory of Grassmannians*, Acta Math. **189** (2002), no. 1, 37–78, arXiv:math/0004137, doi:10.1007/BF02392644. MR1946917.
- [Cha02] Vyjayanthi Chari, *Braid group actions and tensor products*, Int. Math. Res. Not. (2002), no. 7, 357–382, arXiv:math/0106241, doi:10.1155/S107379280210612X. MR1883181.
- [Col16] V. Collins, *Crystal branching for non-levi subgroups and a puzzle formula for the equivariant cohomology of the cotangent bundle on projective space*, Ph.D. thesis, Cornell University, Ithaca, NY, June 2016.
- [CP94] V. Chari and A. Pressley, *A guide to quantum groups*, Cambridge University Press, Cambridge, 1994. MR1300632.
- [Dri88] V. Drinfeld, *Quantum groups*, J. Sov. Math. **41** (1988), 898–915, [Zap. Nauchn. Semin. LOMI 155 (1986) 18-49].
- [Dri89] ———, *Quasi-Hopf algebras*, Algebra i Analiz **1** (1989), no. 6, 114–148. MR1047964.
- [EE07] P. Etingof and C.-H. Eu, *Koszulity and the Hilbert series of preprojective algebras*, Math. Res. Lett. **14** (2007), no. 4, 589–596, doi:10.4310/MRL.2007.v14.n4.a4. MR2335985.
- [FM01] E. Frenkel and E. Mukhin, *Combinatorics of q-characters of finite-dimensional representations of quantum affine algebras*, Comm. Math. Phys. **216** (2001), no. 1, 23–57, arXiv:math/9911112, doi:10.1007/s002200000323. MR1810773.
- [FR18] L. Fehér and R. Rimányi, *Chern–Schwartz–MacPherson classes of degeneracy loci*, Geometry and Topology **22** (2018), no. 6, 3575–3622, doi:10.2140/gt.2018.22.3575.
- [FRW21] L. Fehér, R. Rimányi, and A. Weber, *Motivic chern classes and K-theoretic stable envelopes*, 2021, pp. 153–189, arXiv:1802.01503.
- [Gin86] V. Ginsburg, *Characteristic varieties and vanishing cycles*, Invent. Math. **84** (1986), no. 2, 327–402, doi:10.1007/BF01388811. MR833194.
- [Gin12] Victor Ginzburg, *Lectures on Nakajima’s quiver varieties*, Geometric methods in representation theory. I, Sémin. Congr., vol. 24, Soc. Math. France, Paris, 2012, pp. 145–219, arXiv:0905.0686.
- [GLS96] V. Guillemin, E. Lerman, and S. Sternberg, *Symplectic fibrations and multiplicity diagrams*, Cambridge University Press, Cambridge, 1996, doi:10.1017/CB09780511574788. MR1414677.
- [Gra01] W. Graham, *Positivity in equivariant Schubert calculus*, Duke Mathematical Journal **109** (2001), no. 3, 599–614, arXiv:math/9908172.
- [GS] Daniel Grayson and Michael Stillman, *Macaulay2, a software system for research in algebraic geometry*, Available at <https://macaulay2.com/>.
- [HL10] D. Hernandez and B. Leclerc, *Cluster algebras and quantum affine algebras*, Duke Math. J. **154** (2010), no. 2, 265–341, arXiv:0903.1452, doi:10.1215/00127094-2010-040. MR2682185.
- [Jim86] M. Jimbo, *Quantum R matrix for the generalized Toda system*, Comm. Math. Phys. **102** (1986), no. 4, 537–547, <http://projecteuclid.org/euclid.cmp/1104114539>. MR824090.
- [Kal09] D. Kaledin, *Geometry and topology of symplectic resolutions*, Algebraic geometry—Seattle 2005. Part 2, Proc. Sympos. Pure Math., vol. 80, Amer. Math. Soc., Providence, RI, 2009, pp. 595–628, doi:10.1090/pspum/080.2/2483948. MR2483948.
- [Kle86] S. Kleiman, *Tangency and duality*, Proceedings of the 1984 Vancouver conference in algebraic geometry, CMS Conf. Proc., vol. 6, Amer. Math. Soc., Providence, RI, 1986, pp. 163–225. MR846021.
- [KM05] Allen Knutson and Ezra Miller, *Gröbner geometry of Schubert polynomials*, Ann. of Math. (2) **161** (2005), no. 3, 1245–1318. MR2180402.
- [KT03] Allen Knutson and Terence Tao, *Puzzles and (equivariant) cohomology of Grassmannians*, Duke Math. J. **119** (2003), no. 2, 221–260, arXiv:math/0112150, doi:10.1215/S0012-7094-03-11922-5.

- [KZJ17] Allen Knutson and Paul Zinn-Justin, *Schubert puzzles and integrability I: invariant trilinear forms*, 2017, arXiv:1706.10019.
- [KZJ23] ———, *Schubert puzzles and integrability III: separated descents*, 2023, arXiv:2306.13855.
- [MO19] D. Maulik and Andrei Okounkov, *Quantum groups and quantum cohomology*, Astérisque (2019), no. 408, ix+209, arXiv:1211.1287.
- [Nak94] Hiraku Nakajima, *Instantons on ALE spaces, quiver varieties, and Kac–Moody algebras*, Duke Math. J. **76** (1994), no. 2, 365–416, doi:10.1215/S0012-7094-94-07613-8. MR1302318.
- [Nak01] ———, *Quiver varieties and finite-dimensional representations of quantum affine algebras*, J. Amer. Math. Soc. **14** (2001), no. 1, 145–238, arXiv:math/9912158, doi:10.1090/S0894-0347-00-00353-2. MR1808477.
- [Nak03] ———, *Reflection functors for quiver varieties and Weyl group actions*, Mathematische Annalen **327** (2003), no. 4, 671–721, doi:10.1007/s00208-003-0467-0.
- [Oko15] Andrei Okounkov, *Lectures on K-theoretic computations in enumerative geometry*, 2015, arXiv:1512.07363.
- [Res91] N. Reshetikhin, *A new exactly solvable case of an $O(n)$ -model on a hexagonal lattice*, J. Phys. A **24** (1991), no. 10, 2387–2396. MR1118538.
- [RTV15] R. Rimányi, V. Tarasov, and A. Varchenko, *Trigonometric weight functions as K-theoretic stable envelope maps for the cotangent bundle of a flag variety*, 2015, pp. 81–119, arXiv:1411.0478.
- [Sch17] J. Schürmann, *Chern classes and transversality for singular spaces*, Singularities in Geometry, Topology, Foliations and Dynamics (Cham) (José Luis Cisneros-Molina, Dũng Tráng Lê, Mut-suo Oka, and Jawad Snoussi, eds.), Springer International Publishing, 2017, pp. 207–231, arXiv:1510.01986.
- [Seg68] Graeme Segal, *Equivariant K-theory*, Inst. Hautes Études Sci. Publ. Math. (1968), no. 34, 129–151, http://www.numdam.org/item?id=PMIHES_1968__34__129_0. MR234452.
- [SSW23] Jörg Schürmann, Connor Simpson, and Botong Wang, *A new generic vanishing theorem on homogeneous varieties and the positivity conjecture for triple intersections of Schubert cells*, 2023, arXiv:2303.13833.
- [SZZ20] C. Su, G. Zhao, and C. Zhong, *On the K-theory stable bases of the Springer resolution*, Ann. Sci. École Norm. Sup. (4) **53** (2020), 663–711, arXiv:1708.08013.
- [Tev03] E. A. Tevelev, *Projectively dual varieties*, vol. 117, 2003, Algebraic geometry, pp. 4585–4732, doi:10.1023/A:1025366207448. MR2027446.
- [Var00] M. Varagnolo, *Quiver varieties and Yangians*, Lett. Math. Phys. **53** (2000), 273–283, arXiv:math/0005277.
- [Wei81] A. Weinstein, *Symplectic geometry*, Bull. Amer. Math. Soc. (N.S.) **5** (1981), no. 1, 1–13, doi:10.1090/S0273-0979-1981-14911-9. MR614310.
- [Wei82] ———, *The symplectic “category”*, Differential geometric methods in mathematical physics (Clausthal, 1980), Lecture Notes in Math., vol. 905, Springer, Berlin-New York, 1982, pp. 45–51. MR657441.
- [Wei10] ———, *Symplectic categories*, Port. Math. **67** (2010), no. 2, 261–278, doi:10.4171/PM/1866. MR2662868.
- [WW12] K. Wehrheim and C. Woodward, *Floer cohomology and geometric composition of Lagrangian correspondences*, Adv. Math. **230** (2012), no. 1, 177–228, doi:10.1016/j.aim.2011.11.009. MR2900542.
- [WZJ19] M. Wheeler and Paul Zinn-Justin, *Littlewood–Richardson coefficients for Grothendieck polynomials from integrability*, J. Reine Angew. Math. **757** (2019), 159–195, arXiv:1607.02396, doi:10.1515/crelle-2017-0033.
- [Zel85] A. V. Zelevinskii, *Two remarks on graded nilpotent classes*, Uspekhi Mat. Nauk **40** (1985), no. 1(241), 199–200. MR783619.
- [ZJ09] Paul Zinn-Justin, *Littlewood–Richardson coefficients and integrable tilings*, Electron. J. Combin. **16** (2009), Research Paper 12, arXiv:0809.2392.
- [ZJ15] ———, *Quiver varieties and the quantum Knizhnik–Zamolodchikov equation*, Theoretical and Mathematical Physics **185** (2015), no. 3, 1741–1758, arXiv:1502.01093, doi:10.1007/s11232-015-0376-x.
- [ZJ20] ———, *The trigonometric E_8 R-matrix*, Lett. Math. Phys. **110** (2020), 3279–3305, arXiv:2004.02044, doi:10.1007/s11005-020-01330-9.
- [ZJ21] ———, *The CotangentSchubert Macaulay2 package*, 2021, to appear in JSAG, <https://www.unimelb-macaulay2.cloud.edu.au/#tutorial-CotangentSchubert>.

ALLEN KNUTSON, CORNELL UNIVERSITY, ITHACA, NEW YORK
Email address: allenk@math.cornell.edu

PAUL ZINN-JUSTIN, SCHOOL OF MATHEMATICS AND STATISTICS, THE UNIVERSITY OF MELBOURNE,
VICTORIA 3010, AUSTRALIA
Email address: pzinn@unimelb.edu.au