

Privacy-Preserving Distributed Optimal Power Flow with Partially Homomorphic Encryption

Tong Wu, *Student Member, IEEE*, Changhong Zhao, *Member, IEEE* and Ying-Jun Angela Zhang, *Fellow, IEEE*

Abstract—Distribution grid agents are obliged to exchange and disclose their states explicitly to neighboring regions to enable distributed optimal power flow dispatch. However, the states contain sensitive information of individual agents, such as voltage and current measurements. These measurements can be inferred by adversaries, such as other participating agents or eavesdroppers. To address the issue, we propose a privacy-preserving distributed optimal power flow (OPF) algorithm based on partially homomorphic encryption (PHE). First of all, we exploit the alternating direction method of multipliers (ADMM) to solve the OPF in a distributed fashion. In this way, the dual update of ADMM can be encrypted by PHE. We further relax the augmented term of the primal update of ADMM with the ℓ_1 -norm regularization. In addition, we transform the relaxed ADMM with the ℓ_1 -norm regularization to a semidefinite program (SDP), and prove that this transformation is exact. The SDP can be solved locally with only the sign messages from neighboring agents, which preserves the privacy of the primal update. At last, we strictly prove the privacy preservation guarantee of the proposed algorithm. Numerical case studies validate the effectiveness and exactness of the proposed approach.

Index Terms—Distributed Optimal Power Flow, Privacy Preservation, Partially Homomorphic Encryption.

I. INTRODUCTION

With the increasing observability of power systems, the system operators carry out advanced operational practices to steer the system towards an optimal power flow (OPF) solution [1, 2]. In particular, when the synchronized measurements from different buses are transferred to the system operator, the sensitive information, such as voltage and current measurements, is likely to expose distribution grid buses to privacy breaches [3]. Several studies have shown that the high-resolution measurements of OPF variables can be used by adversaries to infer the users' energy consumption patterns and types of appliances [4, 5].

To reduce the global communication of different buses, distributed algorithms have been proposed to solve OPF, where only boundary variables are shared among agents that act as independent system operators in different regions [6–11]. In these works, one classical approach is alternating direction method of multipliers (ADMM) [6–8]. In particular, Reference [7] applied the ADMM to the semidefinite program (SDP) relaxation of OPF problem. Then, [8] solved the general form of OPF problems using ADMM in a distributed way, where the complex voltages on the boundary buses are shared with neighboring agents. Similarly, the OPF problem has been relaxed as a second order cone program (SOCP), and then solved in a distributed way by ADMM [6]. Noticeably, the complex

power flow measurements in [6] are transferred to neighboring agents. Another distributed approach is dual decomposition [11, 12]. Reference [12] proposed a dual algorithm to coordinate the subproblems decomposed from the SDP relaxation of OPF problem. In [11], the decomposed subproblem can be solved with a closed-form solution. Meanwhile, the solutions of the subproblems need to be communicated between each pair of agents iteratively, resulting in large privacy leakage. Other methods include the multiplier methods [9, 10], where the buses are required to exchange their states directly in the communication network.

To achieve or approximate the optimal solution in the above distributed algorithms, agents inevitably need to share their individual information with their neighbors, which leads to serious privacy leakage problems. For example, the direct communication among buses gives adversaries or eavesdroppers a chance to attack the grid system effectively [13]. In particular, adversaries are able to design the optimal attack to increase the generation costs or disturb the electricity market [5]. Therefore, it is desirable to design privacy-preserving distributed OPF (DOPF) algorithms.

Recently, some privacy-preserving methods have been proposed to solve distributed optimization problems. These methods are broadly classified into two categories, namely differential-privacy methods [14–16] and homomorphic encryption methods [17–19]. In particular, differential-privacy methods introduce a random perturbation to the shared messages to protect an agent's privacy [14]. In power systems, [15] optimized OPF variables as affine functions of the random noise. In addition, [16] introduced the OPF Load Indistinguishability (OLI) problem, which guarantees load privacy while achieving a feasible and near optimal energy dispatch. Note that there is an inevitable trade-off between optimality and privacy in differential-privacy methods, due to the random perturbation added to the shared messages. As to the homomorphic encryption methods, [17] studied how a system operator and a set of agents securely execute a distributed projected gradient-based algorithm. In [18, 19], the projected gradient-based algorithm and ADMM algorithm were incorporated with the partially homomorphic encryption scheme (PHE) to facilitate the privacy-preserving distributed optimization. However, these methods are applicable only when the optimization problems are unconstrained or a closed-form primal update is available. Therefore, the above methods are not applicable to the OPF problems directly.

To address the challenges mentioned above, we are moti-

vated to develop a privacy-preserving DOPF method based on partially homomorphic encryption. To enable the cryptographic techniques in DOPF, we first apply a sequence of strong SDP relaxations to the OPF problem. Then, we decouple the centralized SDP into multiple small-scale SDPs with boundary constraints. In this way, the ADMM method is employed to solve multiple SDPs in a distributed fashion. In particular, we protect the privacy of both primal and dual updates of ADMM based on PHE. Our main contributions are summarized as follows.

- We develop a privacy-preserving distributed optimal power flow method based on PHE. To the best of our knowledge, this is the first time that cryptographic techniques are incorporated in the distributed AC optimal power flow problem. Compared with differential-privacy based optimization methods, our approach obtains the solutions that are very close to the global optimum, and converges faster. In addition, our approach can preserve the privacy of gradients and intermediate primal states.
- To solve the primal update problem securely, we relax the augmented terms in ADMM by the ℓ_1 -norm regularization. We further transform the new primal update problem as an SDP problem, which only shares the sign information with other agents. In addition, the privacy of the dual update of ADMM is protected by PHE with random penalty parameters.
- We rigorously prove the privacy preservation of the proposed algorithm with two commonly encountered types of adversaries. For honest-but-curious agents, our analysis shows that the privacy information of neighboring agents cannot be inferred from the shared messages. Likewise, we prove that external eavesdroppers cannot infer the privacy of exchanged information.

The rest of the paper is organized as follows. In Section II, we introduce the preliminaries of the OPF problem and Paillier Cryptosystem. In Section III, we present the privacy-preserving distributed optimal power flow method. In Section IV, we strictly prove the privacy preservation guarantee of the proposed algorithm. The case studies are given in Section V. Finally, we conclude the paper in Section VI.

II. BACKGROUND

A. Definition

It is worth noticing that privacy has different meanings for different applications. For example, privacy has been defined as the non-disclosure of agent's states [17, 18], gradients or sub-gradients [15, 16]. In this paper, we define privacy as the non-disclosure of agents' intermediate states and gradients of the objective functions. Noticeably, agents' intermediate states are feasible solutions to power flow equations in corresponding regions. Besides, power flow equations can be regarded as a mapping function from intermediate states to the system information. Therefore, the parameters and topologies of sub-regions can be inferred by data mining tools from a long-term observation of agents' intermediate states [20]. In general,

distributed algorithms usually take multiple iterations to converge, which generates massive intermediate states that enable adversaries to infer the grid models effectively. Likewise, the objective parameters can be inferred from agents' intermediate states and gradients of the objective functions in the same way. In addition, undetectable attacks can be designed by partial observations of agents' intermediate states [21]. During this process, to make an attack undetectable, adversaries should successively inject false data into agents' intermediate states, since only injecting false data into the final states can be easily detected. Therefore, if unprotected, agents' intermediate states could be obtained by adversaries to attack the power grids or disturb the electricity market.

We also define two kinds of adversaries: honest-but-curious agents and external eavesdroppers [19]. Honest-but-curious agents are the agents that follow all protocol steps but are curious and collect all the intermediate states of other participating agents. External eavesdroppers are adversaries who steal information through eavesdropping all the communication channels and exchanged messages between agents. The differences between honest-but-curious agents and external eavesdroppers are:

- honest-but-curious agents only obtain information from the neighboring agents, while external eavesdroppers obtain all agents' shared information;
- honest-but-curious agents can decrypt the shared encrypted information, but external eavesdroppers cannot.

Preserving the privacy of agents' intermediate states can prevent eavesdroppers from inferring any information in optimization.

B. Optimal Power Flow

We represent the power network by a graph $\mathcal{G}(\mathcal{N}, \mathcal{M})$, with vertex set \mathcal{N} and edge set \mathcal{M} . We consider the following OPF optimization problem:

$$\min_{P_{G_i}, Q_{G_i}, V_i} C(P_{G_i}) = \sum_{i=1}^{|\mathcal{N}^g|} a_i P_{G_i}^2 + b_i P_{G_i} + c_i, \quad (1a)$$

$$\text{s.t.} \quad P_{G_i} - P_{D_i} = \text{Re}\{V_i \sum_{j \in \delta(i)} (Y_{ij} V_j)^*\}, i \in \mathcal{N}, \quad (1b)$$

$$Q_{G_i} - Q_{D_i} = \text{Im}\{V_i \sum_{j \in \delta(i)} (Y_{ij} V_j)^*\}, i \in \mathcal{N}, \quad (1c)$$

$$\underline{V}_i \leq |V_i| \leq \overline{V}_i, i \in \mathcal{N}, \quad (1d)$$

$$\underline{P}_{G_i} \leq P_{G_i} \leq \overline{P}_{G_i}, i \in \mathcal{N}, \quad (1e)$$

$$\underline{Q}_{G_i} \leq Q_{G_i} \leq \overline{Q}_{G_i}, i \in \mathcal{N}. \quad (1f)$$

where Y be the nodal admittance matrix and $\delta(i)$ is the set of neighboring buses of node i . The objective function (1a) describes the fuel cost. a_i , b_i and c_i are nonnegative coefficients. Note that \mathcal{N}^g is the set of generator buses and $|\mathcal{N}^g|$ is its cardinality. V_i is the complex voltage on bus i with magnitude $|V_i|$ and phase $|\theta_i|$. The constraints in (1b) and (1c) describe the power flow equations on each bus i .

The active power output P_{G_i} and reactive power output Q_{G_i} of generator i and the voltage magnitude $|V_i|$ are bounded in Eqs. (1d)-(1f) by constant bounds $\underline{P}_{G_i}, \overline{P}_{G_i}, \underline{Q}_{G_i}, \overline{Q}_{G_i}, \underline{V}_i$ and \overline{V}_i . In addition, we enforce $\underline{P}_{G_i} = 0, \overline{P}_{G_i} = 0, \underline{Q}_{G_i} = 0$ and $\overline{Q}_{G_i} = 0$ for non-generator buses $\mathcal{N}/\mathcal{N}^g$. Problem (1) is a non-convex problem because of the nonconvexity of constraints (1b)-(1c).

C. Partially Homomorphic Encryption

In this subsection, we introduce Paillier Cryptosystem, which will be used to enable privacy-preserving DOPF in the following section. The Paillier Cryptosystem is a public-key system consisting of three parts, i.e., key generation, encryption and decryption [22]. In particular, we have the public key and private key in the key generation stage. The public key are disseminated to all agents to encrypt messages. The private key is only known to one agent or the aggregator and used to decrypt messages. In particular, both the private key and the public key are time-varying. As shown in Algorithm 1, the three parts of Paillier cryptosystem are implemented by three functions, i.e., **Keygen**(), $c = \mathcal{E}(m)$ and $m = \mathcal{D}(c)$.

Noticeably, the Paillier system is additively homomorphic. In particular, the ciphertext of $m_1 + m_2$ can be obtained from the ciphertexts of m_1 and m_2 directly. We have

$$\mathcal{E}(m_1) * \mathcal{E}(m_2) = \mathcal{E}(m_1 + m_2), \quad (2)$$

$$\mathcal{E}(m)^k = \mathcal{E}(km), k \in \mathbb{Z}^+, \quad (3)$$

where m_1 and m_2 are the original messages, and c_1 and c_2 are the ciphertext of m_1 and m_2 , respectively.

Algorithm 1: Paillier cryptosystem

```

1 Function Keygen ()
   Output: Public key  $k_p: (n, g)$ , Private key  $k_s: (\lambda, \mu)$ 
2   Choose two large prime numbers  $p$  and  $q$  of equal
   bit-length and compute  $n = p \cdot q$ ;
3    $g \leftarrow n + 1$ ;
4    $\lambda = \phi(n) = (p - 1) \cdot (q - 1)$ , where  $\phi(\cdot)$  denotes the
   Euler's totient function;
5    $\mu = \phi^{-1}(n) \bmod n$ , which is the modular multiplicative
   inverse of  $\phi(n)$ ;
6 Function  $\mathcal{E}(m)$ 
   Output: Ciphertext  $c$ 
7   Choose a random  $r \in \mathbb{Z}_n^* = \{z | z \in \mathbb{Z}, 0 \leq z < n, \gcd(z, n) = 1\}$ ;
8   Generate the ciphertext by  $c = g^m \cdot r^n \bmod n^2$ , where
    $m \in \mathbb{Z}_n = \{z | z \in \mathbb{Z}, 0 \leq z < n\}$ ,  $c \in \mathbb{Z}_{n^2}^*$ ;
9 Function  $\mathcal{D}(c)$ 
   Output: Message  $m$ 
10  Define the integer division function  $L(\mu) = \frac{\mu-1}{n}$ ;
11  Generate the plaintext as  $m = L(c^\lambda \bmod n^2) \cdot \mu \bmod n$ ;

```

III. PRIVACY-PRESERVING DISTRIBUTED OPTIMAL POWER FLOW

A. Convex Relaxation

To deal with the nonconvexity of Problem (1), we apply SDP relaxation in this subsection.

Let \mathbf{v} define the vector of complex bus voltages $\mathbf{v} = (|V_1| \angle \theta_1, \dots, |V_N| \angle \theta_N)$, where N denotes the number of buses. We define variable matrix $\mathbf{W} = \mathbf{v}\mathbf{v}^H$. We use the notation $\text{Tr}\{\mathbf{X}\}$ to represent the trace of an arbitrary square matrix \mathbf{X} . Recall that Y is the admittance matrix. For $i \in \mathcal{N}$, e_i is the i th basis vector in \mathbb{R}^N , e_i^T is its transpose, and $Y_i = e_i e_i^T Y$. We define $\mathbf{Y}_i = 1/2(Y_i^H + Y_i)$, $\bar{\mathbf{Y}}_i = 1/2\sqrt{-1}(Y_i^H - Y_i)$ and $\mathbf{M}_i = e_i e_i^T$. Then, we have $P_{G_i} = \text{Tr}\{\mathbf{Y}_i \mathbf{W}\} + P_{D_i}$.

The active and reactive power balance equations Eq. (1b) and Eq. (1c) can be combined with constraints (1e) and (1f) as

$$\underline{P}_{G_i} \leq P_{G_i} = \text{Tr}\{\mathbf{Y}_i \mathbf{W}\} + P_{D_i} \leq \overline{P}_{G_i}, \quad (4)$$

$$\underline{Q}_{G_i} \leq Q_{G_i} = \text{Tr}\{\bar{\mathbf{Y}}_i \mathbf{W}\} + Q_{D_i} \leq \overline{Q}_{G_i}, \quad (5)$$

Moreover, Eq. (1d) can be transformed to

$$(\underline{V}_i)^2 \leq \text{Tr}\{\mathbf{M}_i \mathbf{W}\} \leq (\overline{V}_i)^2. \quad (6)$$

As such, we can write an equivalent form of Problem (1) as follows

$$(P1) : \quad \min \quad C(P_{G_i}) = \sum_{i=1}^{|\mathcal{N}^g|} a_i P_{G_i}^2 + b_i P_{G_i} + c_i, \quad (7a)$$

$$\text{s.t.} \quad (4)-(6), \quad (7b)$$

$$\mathbf{W} \text{ is hermitian, } \mathbf{W} \succeq 0, \quad (7c)$$

$$\text{rank}(\mathbf{W}) = 1, \quad (7d)$$

where the rank-1 constraint in (7d) makes the problem nonconvex. A convex SDP relaxation of (7) is obtained by removing the rank constraint (7d). By Theorem 9 of [23], when the cost function is convex and the network is a tree, the SDP relaxation is exact under mild technical conditions.

B. Distributed Formulation

For a large distribution network with hundreds or thousands of buses, solving the SDP problem swiftly is challenging. To expedite the solution, we decompose the power grid into multiple subregions to allow parallel computation. Let R be the total number of regions and \mathcal{R}_r be the set of buses assigned to region r with $\mathcal{R}_r \cap \mathcal{R}_l = \emptyset, \forall l \neq r$ and $\sum_{r=1}^R |\mathcal{R}_r| = |\mathcal{N}|$. Let \mathcal{B}_r denote the joint set including the buses in \mathcal{R}_r and the buses duplicated from the neighboring regions that are directly connected to the buses in \mathcal{R}_r . Here, the set of neighboring regions for region r can be expressed as $\mathcal{N}^{\delta(r)} = \{l | \mathcal{B}_r \cup \mathcal{B}_l \neq \emptyset\}$. Finally, we stack the complex voltages of the nodes in \mathcal{B}_r as \mathbf{v}^r , i.e., $\{V_i\}_{i \in \mathcal{B}_r}$.

In addition, $\mathbf{W} = \mathbf{X} + \sqrt{-1}\mathbf{Z}$, where \mathbf{X} is the real part of \mathbf{W} and \mathbf{Z} is the imaginary part of \mathbf{W} . Moreover, we define $\mathbf{Y}_i^r, \bar{\mathbf{Y}}_i^r, \mathbf{M}_i^r, \mathbf{W}^r, \mathbf{X}^r$ and \mathbf{Z}^r as the sub-matrices of $\mathbf{Y}_i, \bar{\mathbf{Y}}_i, \mathbf{M}_i, \mathbf{W}, \mathbf{X}$ and \mathbf{Z} , respectively. In particular, these sub-matrices are formed by extracting rows and columns corresponding to the nodes in \mathcal{B}_r . Next, $\mathcal{P}_{r,l}$ indexes voltages at the buses shared by \mathcal{B}_r and \mathcal{B}_l . For example, if region 1 and region 2 share nodes $n = 3$ and $n = 4$, then $\mathcal{P}_{1,2}$ indexes

the voltage $\{V_3\}$ and $\{V_4\}$. In addition, let \mathbf{W}_i^r denote the submatrix of \mathbf{W}^r , which collects the rows and columns of \mathbf{W}^r corresponding to the voltages in \mathcal{P}_{rl} . As such, we rewrite problem (P1) (after rank relaxation) in the following equivalent form:

$$(P2) : \min \sum_{r=1}^R C^r(P_G^r) = \sum_{r=1}^R \left(\sum_{i=1}^{|\mathcal{R}_r^g|} a_i P_{G_i}^2 + b_i P_{G_i} + c_i \right), \quad (8a)$$

$$\text{s.t. } \{\mathbf{W}^r, P_G^r, Q_G^r\} \in \mathcal{F}_r^{\mathbb{C}}, \forall r = 1, \dots, R, \quad (8b)$$

$$\mathbf{W}_i^r = \mathbf{W}_i^l, l \in \mathcal{N}^{\delta(r)}, r = 1, \dots, R, \quad (8c)$$

$$\mathbf{W}^r \succeq 0, \forall r = 1, \dots, R, \quad (8d)$$

where P_G^r and Q_G^r denote the entire vectors of P_{G_i} and Q_{G_i} $\forall i \in \mathcal{B}_r$ respectively, $\mathcal{F}_r^{\mathbb{C}}$ in constraint (8b) denotes the feasible set (4)-(6) restricted to buses \mathcal{B}_r . Besides, constraint (8c) enforces neighboring areas to consent on the entries of \mathbf{W}^r and \mathbf{W}^l that they have in common. \mathcal{R}_r^g denotes the set of generator buses in \mathcal{R}_r , and $|\mathcal{R}_r^g|$ denotes the number of generator buses in \mathcal{R}_r . We denote the real and imaginary part of \mathbf{W}_i^r by \mathbf{X}_i^r and \mathbf{Z}_i^r , respectively. Note that \mathbf{W}_i^r is the message that is transferred from region l to region r . To enforce the equivalence of \mathbf{W}_i^r and \mathbf{W}_i^l , we have $\mathbf{X}_i^r = \mathbf{X}_i^l$ and $\mathbf{Z}_i^r = \mathbf{Z}_i^l$. We also denote the number of buses in \mathcal{B}_r by $\bar{N}_r = |\mathcal{B}_r|$ and the number of buses in $\mathcal{B}_r \cap \mathcal{B}_l$ by $\bar{N}_{rl} = |\mathcal{B}_r \cap \mathcal{B}_l|$.

The main challenge to this decomposition is the positive semi-definite (PSD) constraints (7c). Indeed, all sub-matrices $\mathbf{W}^r \succeq 0, \forall r$ does not necessarily imply $\mathbf{W} \succeq 0$. Luckily, as established in [24], $\mathbf{W}^r \succeq 0$ for all region r is equivalent to $\mathbf{W} \succeq 0$ if the following assumption holds.

- Every maximal clique is contained in the subgraph formed by \mathcal{B}_r for at least one r .

When the network is a tree, every pair of adjacent nodes connected by an edge forms a maximal clique, and thus this assumption is trivially true.

Let \mathbf{G}_i^r denote the real part and \mathbf{Z}_i^r denote the imaginary part of \mathbf{Y}_i^r . Let $\bar{\mathbf{G}}_i^r$ denote the real part and $\bar{\mathbf{Z}}_i^r$ denote the imaginary part of $\bar{\mathbf{Y}}_i^r$. We have

$$\begin{aligned} \text{Tr}\{\mathbf{Y}_i^r \mathbf{W}^r\} &= \text{Tr}\{(\mathbf{G}_i^r \mathbf{X}^r - \mathbf{Z}_i^r \mathbf{Z}^r) + \sqrt{-1}(\mathbf{Z}_i^r \mathbf{X}^r + \mathbf{G}_i^r \mathbf{Z}^r)\} \\ &= \text{Tr}\{(\mathbf{G}_i^r \mathbf{X}^r - \mathbf{Z}_i^r \mathbf{Z}^r)\}, \end{aligned} \quad (9)$$

where $\text{Tr}\{\sqrt{-1}(\mathbf{Z}_i^r \mathbf{X}^r + \mathbf{G}_i^r \mathbf{Z}^r)\} = 0$ because P_{G_i} is a real number. In addition, $\mathcal{F}_r^{\mathbb{R}}$ in Eqs. (4)-(6) can be equivalently expressed as:

$$\underline{P}_{G_i} \leq P_{G_i} = \text{Tr}\{(\mathbf{G}_i^r \mathbf{X}^r - \mathbf{Z}_i^r \mathbf{Z}^r)\} + P_{D_i} \leq \bar{P}_{G_i}, \quad (10a)$$

$$\underline{Q}_{G_i} \leq Q_{G_i} = \text{Tr}\{(\bar{\mathbf{G}}_i^r \mathbf{X}^r - \bar{\mathbf{Z}}_i^r \mathbf{Z}^r)\} + Q_{D_i} \leq \bar{Q}_{G_i}, \quad (10b)$$

$$(\underline{V}_i)^2 \leq \text{Tr}\{\mathbf{M}_i^r \mathbf{X}^r\} \leq (\bar{V}_i)^2. \quad (10c)$$

We define the matrix $\mathbf{E}_{r \rightarrow l} \in \mathbb{R}^{\bar{N}_{rl} \times \bar{N}_r}$ as

$$\mathbf{E}_{r \rightarrow l} = \left[\bigoplus_{i \in \mathcal{P}_{rl}} e_i^{rT}; \right], \quad (11)$$

where $e_i^r \in \mathbb{R}^{\bar{N}_r}$ and \bigoplus denotes the operator of concatenating vectors.

Lemma 1: We have the following relationship:

$$\mathbf{W} \succeq 0 \iff \begin{bmatrix} \mathbf{X} & -\mathbf{Z} \\ \mathbf{Z} & \mathbf{X} \end{bmatrix} \succeq 0 \quad (12)$$

Proof: We show the detailed proof in the Appendix.

Based on Lemma 1, we write (P2) in terms of $\mathbf{X}^r, \mathbf{Z}^r$ as follows:

$$(P3) : \min \sum_{r=1}^R C^r(P_G^r) \quad (13a)$$

$$\text{s.t. } \{\mathbf{X}^r, \mathbf{Z}^r, P_G^r, Q_G^r\} \in \mathcal{F}_r^{\mathbb{R}}, \forall r = 1, \dots, R, \quad (13b)$$

$$\mathbf{E}_{r \rightarrow l} \mathbf{X}^r \mathbf{E}_{r \rightarrow l}^T = \mathbf{X}_i^l, l \in \mathcal{N}^{\delta(r)}, r = 1, \dots, R, \quad (13c)$$

$$\mathbf{E}_{r \rightarrow l} \mathbf{Z}^r \mathbf{E}_{r \rightarrow l}^T = \mathbf{Z}_i^l, l \in \mathcal{N}^{\delta(r)}, r = 1, \dots, R, \quad (13d)$$

$$\begin{bmatrix} \mathbf{X}^r & -\mathbf{Z}^r \\ \mathbf{Z}^r & \mathbf{X}^r \end{bmatrix} \succeq 0, \forall r = 1, \dots, R, \quad (13e)$$

where $\mathbf{X}_i^r = \mathbf{E}_{r \rightarrow l} \mathbf{X}^r \mathbf{E}_{r \rightarrow l}^T$, $\mathbf{Z}_i^r = \mathbf{E}_{r \rightarrow l} \mathbf{Z}^r \mathbf{E}_{r \rightarrow l}^T$, and $\mathbf{E}_{r \rightarrow l} \mathbf{E}_{r \rightarrow l}^T = \mathbf{I}_{r \rightarrow l} \in \mathbb{R}^{\bar{N}_{rl} \times \bar{N}_{rl}}$.

C. Distributed Optimal Power Flow

Solving (P3) directly is likely to incur infeasible solutions. In particular, when we solve (P3) for region r and pass the messages to region l , the additional equality constraints, i.e., (13c) - (13d), may cause the boundary variables described by the messages infeasible for (13d) in region l . This is because the number of equality constraints in each subproblem may be larger than the number of its variables or these messages do not lie in the intersection of the feasible regions of all the subproblems.

Therefore, in this subsection, we propose a distributed algorithm to solve (P3). Instead of solving (P3) directly, we relax (P3) by utilizing the augmented partial Lagrangian. In particular, (13c) - (13d) in region r are replaced by the augmented Lagrangian terms in its objective. Once the distributed algorithm converges, optimal solutions to the augmented partial Lagrangians of different regions will satisfy (13c) - (13d) simultaneously. We consider the partial augmented Lagrangian:

$$(P4) : \min_{\{\mathbf{X}^r, \mathbf{Z}^r, \{\Gamma_i^r\}, \{\Lambda_i^r\}, r=1, \dots, R\}} \mathcal{L}_{admm} = \sum_{r=1}^R \mathcal{L}_{admm}^r = \sum_{r=1}^R \left\{ C^r(P_G^r) + \sum_{l \in \mathcal{N}^{\delta(r)}} [\text{Tr}\{(\Gamma_l^r)^T (\mathbf{E}_{r \rightarrow l} \mathbf{X}^r \mathbf{E}_{r \rightarrow l}^T - \mathbf{X}_i^l)\} + \text{Tr}\{(\Lambda_l^r)^T (\mathbf{E}_{r \rightarrow l} \mathbf{Z}^r \mathbf{E}_{r \rightarrow l}^T - \mathbf{Z}_i^l)\} + \frac{1}{2} \|\sqrt{\rho_{rl}} \circ (\mathbf{E}_{r \rightarrow l} \mathbf{X}^r \mathbf{E}_{r \rightarrow l}^T - \mathbf{X}_i^l)\|_F^2 + \frac{1}{2} \|\sqrt{\kappa_{rl}} \circ (\mathbf{E}_{r \rightarrow l} \mathbf{Z}^r \mathbf{E}_{r \rightarrow l}^T - \mathbf{Z}_i^l)\|_F^2] \right\} \quad (14a)$$

$$\text{s.t. } \{\mathbf{X}^r, \mathbf{Z}^r, P_G^r, Q_G^r\} \in \mathcal{F}_r^{\mathbb{R}}, \forall r = 1, \dots, R, \quad (14b)$$

$$\begin{bmatrix} \mathbf{X}^r & -\mathbf{Z}^r \\ \mathbf{Z}^r & \mathbf{X}^r \end{bmatrix} \succeq 0, \forall r = 1, \dots, R, \quad (14c)$$

where $\rho_{rl}, \kappa_{rl} \in \mathbb{R}^{\bar{N}_{rl} \times \bar{N}_{rl}}$ are matrices with positive entries, and \circ denotes Hadamard product. In addition, $\{\Gamma_l^r\}$ and $\{\Lambda_l^r\}$ denote the multipliers associated with (13c) and (13d). Note that, the gradients of $\frac{1}{2} \|\sqrt{\rho_{rl}} \circ (\mathbf{E}_{r \rightarrow l} \mathbf{X}^r \mathbf{E}_{r \rightarrow l}^T - \mathbf{X}_r^l)\|_F^2$ and $\frac{1}{2} \|\sqrt{\kappa_{rl}} \circ (\mathbf{E}_{r \rightarrow l} \mathbf{Z}^r \mathbf{E}_{r \rightarrow l}^T - \mathbf{Z}_r^l)\|_F^2$ require successive communication between agents in each iteration, which can disclose the states of neighboring agents. Taking \mathbf{X}^r for example, the gradient of $\frac{1}{2} \|\sqrt{\rho_{rl}} \circ (\mathbf{E}_{r \rightarrow l} \mathbf{X}^r \mathbf{E}_{r \rightarrow l}^T - \mathbf{X}_r^l)\|_F^2$ is $\rho_{rl} \circ (\mathbf{E}_{r \rightarrow l} \mathbf{X}^r \mathbf{E}_{r \rightarrow l}^T - \mathbf{X}_r^l)$. Observing from the gradient, it is obvious that updating \mathbf{X}^r by agent r in each iteration requires the values of \mathbf{X}_r^l from neighboring agent l . As a result, the values of \mathbf{X}_r^l are exposed to both honest-but-curious agents and external eavesdroppers.

To solve this problem, we approximate the augmented terms by the ℓ_1 -norm regularization. The mechanism is motivated by the fact that the subgradients of the ℓ_1 -norm regularization terms are the sign messages. Therefore, we can introduce a third party to provide the sign messages to agent r to update \mathbf{X}^r . In this way, the two kinds of adversaries cannot infer any information through eavesdropping all the communication channels and exchanged messages between agents, as will be clearer in Algorithm 2. Based on the above discussion, the implementation of the relaxed ADMM method with the ℓ_1 -norm regularization is elaborated as follows:

S1) Update primal variables:

$$\begin{aligned} \{\mathbf{X}^r(t+1)\}, \{\mathbf{Z}^r(t+1)\} &= \min_{\{\mathbf{X}^r\}, \{\mathbf{Z}^r\}} \mathcal{L}_{admm}^{r,1} = \\ &C^r(P_G^r) + \sum_{l \in \mathcal{N}^{\delta(r)}} [\text{Tr}((\Gamma_l^r(t))^T (\mathbf{E}_{r \rightarrow l} \mathbf{X}^r \mathbf{E}_{r \rightarrow l}^T \\ &- \mathbf{X}_r^l)) + \text{Tr}((\Lambda_l^r(t))^T (\mathbf{E}_{r \rightarrow l} \mathbf{Z}^r \mathbf{E}_{r \rightarrow l}^T - \mathbf{Z}_r^l)) + \\ &\alpha \|\text{vec}(\mathbf{E}_{r \rightarrow l} \mathbf{X}^r \mathbf{E}_{r \rightarrow l}^T - \mathbf{X}_r^l)\|_1 + \\ &\alpha \|\text{vec}(\mathbf{E}_{r \rightarrow l} \mathbf{Z}^r \mathbf{E}_{r \rightarrow l}^T - \mathbf{Z}_r^l)\|_1] \end{aligned} \quad (15a)$$

$$\text{s.t. } \{\mathbf{X}^r, \mathbf{Z}^r, P_G^r, Q_G^r\} \in \mathcal{F}_r^{\mathbb{R}}, \quad (15b)$$

$$\begin{bmatrix} \mathbf{X}^r & -\mathbf{Z}^r \\ \mathbf{Z}^r & \mathbf{X}^r \end{bmatrix} \succeq 0, \quad (15c)$$

where (15) is an approximation to (14) by replacing the Frobenius norm by the ℓ_1 -norm regularization and $\text{vec}(\cdot)$ denotes the operator that reshapes a matrix to a vector. In addition, α is a fixed positive weighting factor, which is tuned to approach the global optimal solution to (P3).

S2) Update dual variables:

$$\{\Gamma_l^r(t+1)\} = \{\Gamma_l^r(t)\} + \rho_{rl} \circ ((\mathbf{X}_l^r(t+1) - \mathbf{X}_r^l)) \quad (16)$$

$$\{\Lambda_l^r(t+1)\} = \{\Lambda_l^r(t)\} + \kappa_{rl} \circ ((\mathbf{Z}_l^r(t+1) - \mathbf{Z}_r^l)) \quad (17)$$

In Step (S1), the per-area matrices $\mathbf{X}^r(t+1)$, $\mathbf{Z}^r(t+1)$ are obtained by minimizing (15) with $\{\Gamma_l^r\}$ and $\{\Lambda_l^r\}$ fixed to their previous iteration values. Likewise, the dual variables

$\{\Gamma_l^r\}$ and $\{\Lambda_l^r\}$ are updated by (16) and (17) by fixing $\mathbf{X}^r(t+1)$, $\mathbf{Z}^r(t+1)$ to their up-to-date values. In particular, the initial values of $\{\Gamma_l^r(0)\}$ and $\{\Lambda_l^r(0)\}$ are zero matrices. Therefore, $\{\Gamma_l^r(t)\}$ and $\{\Lambda_l^r(t)\}$, $\forall t, r, l$ are symmetric and skew-symmetric matrices, respectively. Notice that t indexes the outer iterations to conduct (S1) and (S2) steps alternately.

We are ready to write the subgradient of \mathcal{L}^r with respect to \mathbf{X}^r and \mathbf{Z}^r .

$$\begin{aligned} \partial \mathcal{L}_{admm}^{r,1} / \partial \mathbf{X}^r &= \sum_{i=1}^{|\mathcal{R}_r|} [2a_i (\mathbf{G}_i^r)^T (\text{Tr}\{(\mathbf{G}_i^r \mathbf{X}^r - \mathbf{Z}_i^r \mathbf{Z}^r)\} + P_{D_i}) \\ &+ b_i (\mathbf{G}_i^r)^T] + \sum_{l \in \mathcal{N}^{\delta(r)}} [\mathbf{E}_{r \rightarrow l}^T (\Gamma_l^r + \alpha(\text{sign}(\mathbf{X}_l^r - \mathbf{X}_r^l)) \mathbf{E}_{r \rightarrow l})], \end{aligned} \quad (18)$$

$$\begin{aligned} \partial \mathcal{L}_{admm}^{r,1} / \partial \mathbf{Z}^r &= \sum_{i=1}^{|\mathcal{R}_r|} [2a_i (-\mathbf{Z}_i^r)^T (\text{Tr}\{(\mathbf{G}_i^r \mathbf{X}^r - \mathbf{Z}_i^r \mathbf{Z}^r)\} + P_{D_i}) \\ &+ b_i (-\mathbf{Z}_i^r)^T] + \sum_{l \in \mathcal{N}^{\delta(r)}} [\mathbf{E}_{r \rightarrow l}^T (\Lambda_l^r + \alpha(\text{sign}(\mathbf{Z}_l^r - \mathbf{Z}_r^l)) \mathbf{E}_{r \rightarrow l})]. \end{aligned} \quad (19)$$

Here, $a_i = b_i = c_i = 0$ if $i \in \mathcal{R}_r / \mathcal{R}_r^g$. $\text{sign}(\mathbf{X})$ denotes the sign signals of each element in \mathbf{X} . Define

$$\mathcal{O}_{rl} = \{(i, i), (i, j), (j, i), (j, j)\}, \quad (20)$$

where line ij connects region r and region l . For example, $\mathbf{X}_{l,o}^r, \forall o \in \mathcal{O}_{rl}$ is a element of \mathbf{X}_l^r .

In particular, the subgradients of $|\mathbf{X}_{l,o}^r - \mathbf{X}_{r,o}^l|$ and $|\mathbf{Z}_{l,o}^r - \mathbf{Z}_{r,o}^l|$ are

$$\partial |\mathbf{X}_{l,o}^r - \mathbf{X}_{r,o}^l| / \partial \mathbf{X}_{l,o}^r = \begin{cases} 1, & \mathbf{X}_{l,o}^r > \mathbf{X}_{r,o}^l \\ -1, & \mathbf{X}_{l,o}^r < \mathbf{X}_{r,o}^l \\ [-1, 1], & \mathbf{X}_{l,o}^r = \mathbf{X}_{r,o}^l \end{cases}, \quad (21)$$

$$\partial |\mathbf{Z}_{l,o}^r - \mathbf{Z}_{r,o}^l| / \partial \mathbf{Z}_{l,o}^r = \begin{cases} 1, & \mathbf{Z}_{l,o}^r > \mathbf{Z}_{r,o}^l \\ -1, & \mathbf{Z}_{l,o}^r < \mathbf{Z}_{r,o}^l \\ [-1, 1], & \mathbf{Z}_{l,o}^r = \mathbf{Z}_{r,o}^l \end{cases}, \quad (22)$$

With the above subgradient, we utilize the standard subgradient method to iterate toward the optimal solution [25]. We write the iterative subgradient method to solve (15) as

$$\begin{bmatrix} \mathbf{X}^r(k+1) \\ \mathbf{Z}^r(k+1) \end{bmatrix} = \Phi \left(\begin{bmatrix} \mathbf{X}^r(k) \\ \mathbf{Z}^r(k) \end{bmatrix}, \begin{bmatrix} (\partial \mathcal{L}_{admm}^{r,1} / \partial \mathbf{X}^r)(k) \\ (\partial \mathcal{L}_{admm}^{r,1} / \partial \mathbf{Z}^r)(k) \end{bmatrix} \right), \quad (23)$$

where $\Phi(\cdot)$ denotes the iteration function that will be elaborated in (26) and (27). Note that k indexes the inner iterations to solve (15).

Proposition 1: Problem (15) can be formulated as the standard form:

$$\text{Primal: } \arg \min \text{Tr}(A_0(\boldsymbol{\theta})^T X), \quad (24a)$$

$$\text{Tr}(A_m^T X) = b_m, \forall m = \{1, \dots, M\} \quad (24b)$$

$$X \succeq 0. \quad (24c)$$

where $A_0(\boldsymbol{\theta})$ is relevant to the message communications of the subgradients and M is the number of constraints. In addition, $A_m \in \mathbb{R}^{D \times D}$, $X \in \mathbb{R}^{D \times D}$ and $b_m \in \mathbb{R}$ will be constructed in the Appendix, where D is the dimension of X . For conciseness, we omit the notation $\boldsymbol{\theta}$ in the following. The dual problem of (24) is

$$\text{Dual: } \max b^T y, \quad (25a)$$

$$A_0 - \sum_{m=1}^M y_m A_m \succeq 0, \quad (25b)$$

where $b = [b_1, \dots, b_m]^T$ and $y \in \mathbb{R}^m$ is the vector of dual variables.

Proof: We show the detailed proof in the Appendix.

Referring to [26], the update scheme $\Phi(\cdot)$ for (25) is

$$B\Delta y = r \quad (26a)$$

$$\Delta X = P + \sum_{m=1}^M A_m \Delta y_m \quad (26b)$$

$$\Delta \hat{Z} = (X^k)^{-1} (R - Z^k \Delta X) \quad (26c)$$

$$\Delta Z = (\hat{Z} + \hat{Z}^T)/2 \quad (26d)$$

where

$$B_{mn} = \text{Tr}([(X^k)^{-1} A_m Z^k]^T A_n), \forall m, n = 1, \dots, M, \quad (27a)$$

$$r_m = -d_m + \text{Tr}(A_m^T [(X^k)^{-1} (R - PZ^k)]), \forall m = 1, \dots, M, \quad (27b)$$

$$P = \sum_{m=1}^M A_m y_m^k - A_0 - X^k, \quad (27c)$$

$$d_m = b_m - \text{Tr}(A_m^T Z^k), \forall m = 1, \dots, M, \quad (27d)$$

$$R = \beta \mu^k I - X^k Z^k, \quad (27e)$$

$$\mu^k = \text{Tr}((X^k)^T Z^k)/D. \quad (27f)$$

The above algorithm cannot protect the privacy of multiple agents when the messages are exchanged and disclosed explicitly among neighboring agents. To avoid privacy leakage, we propose a privacy preserving distributed optimization method, which combines homomorphic cryptography and distributed optimization in the following subsection.

D. Privacy-Preserving Distributed Algorithm

In this subsection, we combine Paillier cryptosystem with DOPF to enable privacy preservation in the (S1) and (S2) steps. We illustrate the DOPF based on PHE in Fig. 1.

First of all, the proposed DOPF based on PHE has two loops, namely the inner (S1) primal update iterations and outer iterations. In the inner (S1) primal update, we first initialize the state variables $\mathbf{X}^r(k=0), \mathbf{Z}^r(k=0)$. Then, we update the iterative state variables $\mathbf{X}^r(k+1), \mathbf{Z}^r(k+1)$ according to Eq. (23), where the state variables during the inner (S1) update (i.e., the k th iteration) are infeasible to $\mathcal{F}_r^{\mathbb{R}}$ unless the inner (S1) update converges. In contrast, the state variables during the outer (S2) dual update (i.e., the t th iteration) are always feasible to $\mathcal{F}_r^{\mathbb{R}}$.

Privacy-Preserving Distributed OPF Algorithm

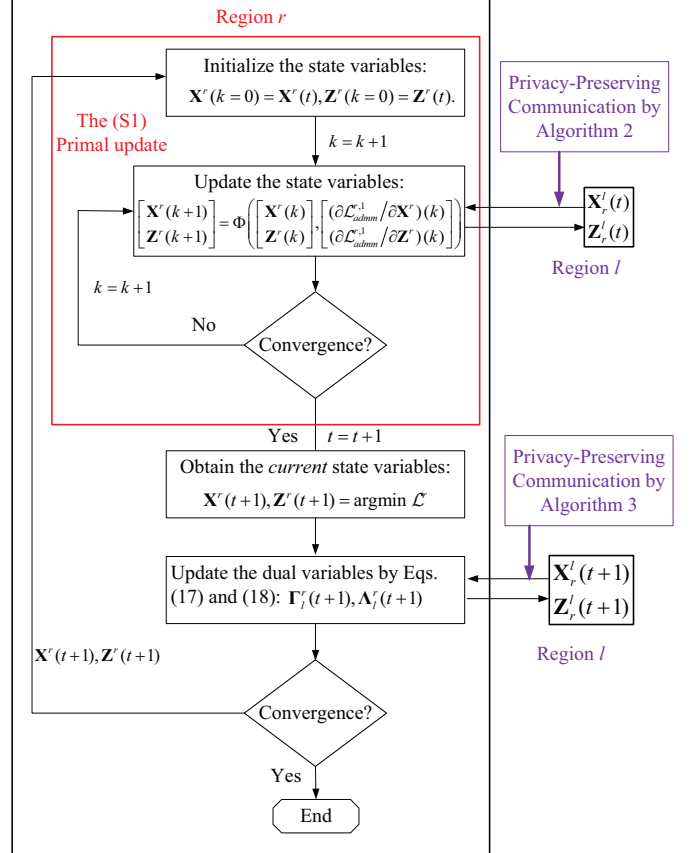

Fig. 1: The flowchart of the proposed algorithm.

In particular, Eq. (23) requires agent r to successively compare its iterative states (i.e., $\mathbf{X}_i^r(k), \mathbf{Z}_i^r(k)$) from agent l 's previous intermediate states (i.e., $\mathbf{X}_i^l(t), \mathbf{Z}_i^l(t)$) in each inner iteration k . In this process, the communication between agent r and agent l can expose its sensitive information to each other or eavesdroppers. Therefore, we propose Algorithm 2 to enable the privacy-preserving communication in the (S1) primal update.

After the inner (S1) primal update converges, agent r obtains the next intermediate states $\mathbf{X}^r(t+1), \mathbf{Z}^r(t+1)$. Then, agent r updates the dual variables $\{\Gamma_i^r(t+1)\}$ and $\{\Lambda_i^r(t+1)\}$ with the help of the communication from agent l about its current intermediate states, i.e., $\mathbf{X}_i^l(t+1), \mathbf{Z}_i^l(t+1)$. However, this process is likely to leak the agents' intermediate states. To address this problem, we propose Algorithm 3 to facilitate the privacy preserving communication in the dual update.

In the following, we introduce the privacy-preserving communications between participating agents. In particular, for the (S1) inner update, Eqs. (18) and (19) require the exchanged messages, i.e., $\text{sign}(\mathbf{X}_i^r - \mathbf{X}_i^l)$ and $\text{sign}(\mathbf{Z}_i^r - \mathbf{Z}_i^l)$. In Step (S2), we have $(\rho_{rl} \circ (\mathbf{X}_i^r - \mathbf{X}_i^l))$ and $(\kappa_{rl} \circ (\mathbf{Z}_i^r - \mathbf{Z}_i^l))$. They require message communications among regions. Noticeably, Paillier encryption cannot be performed on matrices directly. Therefore, each element of the matrix, e.g., \mathbf{X}_i^r and \mathbf{Z}_i^r , are encrypted separately. We summarize the Algorithms 2 and 3

Algorithm 2: Privacy-Preserving Message Communication for the (S1) (Primal) update

1 **Agent** r encrypts $\mathbf{X}_{l,o}^r(k)$ and $\mathbf{Z}_{l,o}^r(k)$ with its public key k_{pi} :

$$\begin{aligned}\mathbf{X}_{l,o}^r(k) &\mapsto \mathcal{E}(\mathbf{X}_{l,o}^r(k)), \forall o \in \mathcal{O}_{rl}, \\ \mathbf{Z}_{l,o}^r(k) &\mapsto \mathcal{E}(\mathbf{Z}_{l,o}^r(k)), \forall o \in \mathcal{O}_{rl},\end{aligned}\quad (28)$$

where the superscript r denotes encryption using the public key of **Agent** r ;

2 **Agent** r sends $\mathcal{E}(\mathbf{X}_{l,o}^r(k))$ and $\mathcal{E}(\mathbf{Z}_{l,o}^r(k))$, and its public key k_{pi} to neighboring **Agent** l ;

3 **Agent** l encrypts $\mathbf{X}_{r,o}^l(t)$ and $\mathbf{Z}_{r,o}^l(t)$ with its public key k_{pi} :

$$\begin{aligned}\mathbf{X}_{r,o}^l(t) &\mapsto \mathcal{E}(-\mathbf{X}_{r,o}^l(t)), \\ \mathbf{Z}_{r,o}^l(t) &\mapsto \mathcal{E}(-\mathbf{Z}_{r,o}^l(t)),\end{aligned}\quad (29)$$

where $\forall o \in \mathcal{O}_{rl}$;

4 **Agent** l computes the difference directly in ciphertext:

$$\begin{aligned}\mathcal{E}(\mathbf{X}_{l,o}^r(k) - \mathbf{X}_{r,o}^l(t)) &= \mathcal{E}(\mathbf{X}_{l,o}^r(k)) \cdot \mathcal{E}(-\mathbf{X}_{r,o}^l(t)), \\ \mathcal{E}(\mathbf{Z}_{l,o}^r(k) - \mathbf{Z}_{r,o}^l(t)) &= \mathcal{E}(\mathbf{Z}_{l,o}^r(k)) \cdot \mathcal{E}(-\mathbf{Z}_{r,o}^l(t)),\end{aligned}\quad (30)$$

since Paillier system is additively homomorphic;

5 **Agent** l computes the $c_{l \rightarrow r}(k)$ and $d_{l \rightarrow r}(k)$ -weighted difference in ciphertext:

$$\begin{aligned}\mathcal{E}(c_{l \rightarrow r}(k)(\mathbf{X}_{l,o}^r(k) - \mathbf{X}_{r,o}^l(t))) &= \\ (\mathcal{E}(\mathbf{X}_{l,o}^r(k) - \mathbf{X}_{r,o}^l(t)))^{c_{l \rightarrow r}(k)}, \\ \mathcal{E}(d_{l \rightarrow r}(k)(\mathbf{Z}_{l,o}^r(k) - \mathbf{Z}_{r,o}^l(t))) &= \\ (\mathcal{E}(\mathbf{Z}_{l,o}^r(k) - \mathbf{Z}_{r,o}^l(t)))^{d_{l \rightarrow r}(k)},\end{aligned}\quad (31)$$

and sends $\mathcal{E}(c_{l \rightarrow r}(k)(\mathbf{X}_{l,o}^r(k) - \mathbf{X}_{r,o}^l(t)))$ and $d_{l \rightarrow r}(k)(\mathbf{Z}_{l,o}^r(k) - \mathbf{Z}_{r,o}^l(t))$ back to **Aggregator**;

6 **Agent** r sends its private key k_{si}^a to **Aggregator**;

7 **Aggregator** decrypts the message received from **Agent** l with its private key k_{si}^a to get $c_{l \rightarrow r}(k)(\mathbf{X}_{l,o}^r(k) - \mathbf{X}_{r,o}^l(t))$ and $d_{l \rightarrow r}(k)(\mathbf{Z}_{l,o}^r(k) - \mathbf{Z}_{r,o}^l(t))$;

8 **Aggregator** obtains the sign of the two messages, i.e., $\text{sign}(c_{l \rightarrow r}(k)(\mathbf{X}_{l,o}^r(k) - \mathbf{X}_{r,o}^l(t)))$ and $\text{sign}(d_{l \rightarrow r}(k)(\mathbf{Z}_{l,o}^r(k) - \mathbf{Z}_{r,o}^l(t)))$, and sends the sign messages to **Agent** r ;

9 When the two messages $c_{l \rightarrow r}(k)(\mathbf{X}_{l,o}^r(k) - \mathbf{X}_{r,o}^l(t))$ and $d_{l \rightarrow r}(k)(\mathbf{Z}_{l,o}^r(k) - \mathbf{Z}_{r,o}^l(t)) \forall r, l$ are zeros, **Aggregator** informs all agents that the algorithm converges. As a result, primal intermediate states at $t + 1$ th iteration are obtained by (15);

as follows.

- For the (S1) update, agent l generates two random positive scalars, i.e., $c_{l \rightarrow r}(k)$ and $d_{l \rightarrow r}(k)$, to multiply the differences of the two messages in the k th iteration. Then, the encrypt weighted differences of the two messages (in ciphertext) are sent to the aggregator. The aggregator sends the sign signals to agent r . The privacy-preserving message communication for the primal update is elaborated in Algorithm 2.
- For the (S2) update, we constructe $\rho_{rl}(t)$ and $\kappa_{rl}(t)$, $r \neq l$ as the product of two random positive numbers, i.e., $\rho_{rl}(t) = a_{r \rightarrow l}(t) \cdot a_{l \rightarrow r}(t)$ and $\kappa_{rl}(t) = b_{r \rightarrow l}(t) \cdot b_{l \rightarrow r}(t)$.

Algorithm 3: Privacy-Preserving Message Communication for the (S2) (Dual) update

1 **Agent** r encrypts $-\mathbf{X}_{l,o}^r(t)$ and $-\mathbf{Z}_{l,o}^r(t)$ with its public key k_{pi} , similar to (28);

2 **Agent** r sends $\mathcal{E}(-\mathbf{X}_{l,o}^r(t))$ and $\mathcal{E}(-\mathbf{Z}_{l,o}^r(t))$, and its public key k_{pi} to neighboring **Agent** l ;

3 **Agent** l encrypts $\mathbf{X}_{r,o}^l(t)$ and $\mathbf{Z}_{r,o}^l(t)$ with its public key k_{pi} , similar to (29);

4 **Agent** l computes the difference, i.e., $\mathcal{E}(\mathbf{X}_{r,o}^l(t) - \mathbf{X}_{l,o}^r(t))$ and $\mathcal{E}(\mathbf{Z}_{r,o}^l(t) - \mathbf{Z}_{l,o}^r(t))$, directly in ciphertext, similar to (30);

5 **Agent** l computes the $a_{l \rightarrow r}(t)$ and $b_{l \rightarrow r}(t)$ -weighted difference, i.e., $\mathcal{E}(a_{l \rightarrow r}(t)(\mathbf{X}_{r,o}^l(t) - \mathbf{X}_{l,o}^r(t)))$ and $\mathcal{E}(b_{l \rightarrow r}(t)(\mathbf{Z}_{r,o}^l(t) - \mathbf{Z}_{l,o}^r(t)))$ in ciphertext, similar to (31);

6 **Agent** l sends $\mathcal{E}(a_{l \rightarrow r}(t)(\mathbf{X}_{r,o}^l(t) - \mathbf{X}_{l,o}^r(t)))$ and $\mathcal{E}(b_{l \rightarrow r}(t)(\mathbf{Z}_{r,o}^l(t) - \mathbf{Z}_{l,o}^r(t)))$ back to **Agent** r ;

7 **Agent** r decrypts the message received from **Agent** l with its private key k_{si} and multiplies the result with $a_{r \rightarrow l}(t)$ and $b_{r \rightarrow l}(t)$ to get $\rho_{rl}(t)(\mathbf{X}_{l,o}^r(t) - \mathbf{X}_{r,o}^l(t))$ and $\kappa_{rl}(t)(\mathbf{Z}_{l,o}^r(t) - \mathbf{Z}_{r,o}^l(t))$:

$$\begin{aligned}\rho_{rl}(t) &= a_{l \rightarrow r}(t) \cdot a_{r \rightarrow l}(t), \\ \kappa_{rl}(t) &= b_{l \rightarrow r}(t) \cdot b_{r \rightarrow l}(t).\end{aligned}\quad (32)$$

Computing (16) and (17) to update dual variables in iteration t ;

In particular, $a_{r \rightarrow l}(t)$ and $b_{r \rightarrow l}(t)$ are only known to agent r . This way, we further propose Algorithm 3 to enable the privacy-preserving message communication in the dual update.

Remark 1: In Step 5 of Algorithm 2, $c_{l \rightarrow r}(k)$ and $d_{l \rightarrow r}(k)$ are large random positive integers. The two numbers are only known to agent l and varying in each iteration.

Remark 2: In Steps 1-2 of Algorithm 3, agent r 's states $\mathbf{X}_{l,o}^r$ and $\mathbf{Z}_{l,o}^r$ are encrypted and will not be revealed to its neighbors.

Remark 3: In Steps 4-5 of Algorithm 3, agent l 's state will not be revealed to agent r because the decrypted messages obtained by agent r are $a_{l \rightarrow r}(t)(\mathbf{X}_{r,o}^l(t) - \mathbf{X}_{l,o}^r(t))$ and $b_{l \rightarrow r}(t)(\mathbf{Z}_{r,o}^l(t) - \mathbf{Z}_{l,o}^r(t))$, where $a_{l \rightarrow r}(t)$ and $b_{l \rightarrow r}(t)$ are only known to agent l and varying in each iteration.

Remark 4: Although Paillier cryptosystem only works for integers, we can take additional steps to convert real values in optimization to integers. This may lead to quantization errors. A common workaround is to scale the real value before quantization.

Remark 5: The key to achieve the privacy-preserving message communication is to construct ρ_{rl} , $r \neq l$ (or κ_{rl}) as the product of two random numbers $a_{r \rightarrow l}$ and $a_{l \rightarrow r}$ (or $b_{r \rightarrow l}$ and $b_{l \rightarrow r}$) generated by and only known by corresponding agents. Therefore, the convergence of algorithm is affected by the random, time-varying ρ_{rl} and κ_{rl} .

IV. PRIVACY ANALYSIS AND STOPPING CRITERION

In the section, we analyze the privacy of agents' immediate states, and convergence of Algorithms 2 and 3. In addition, we also prove that the private information, including agents'

gradients and the objective functions, cannot be inferred by honest-but-curious adversaries, external eavesdroppers, and the aggregator over time.

A. Privacy Analysis

Theorem 1: Assume that all agents follow Algorithm 2. Then agent l 's exact state values $\mathbf{X}_r^l(t)$ and $\mathbf{Z}_r^l(t)$ over the boundaries cannot be inferred by an honest-but-curious agent r and the aggregator unless $\mathbf{X}_l^r(k) = \mathbf{X}_r^l(t)$ and $\mathbf{Z}_l^r(k) = \mathbf{Z}_r^l(t)$. *Proof:* In Algorithm 2, we have two potential adversaries, i.e., the honest-but-curious agent r and the aggregator.

- The honest-but-curious agent r only obtains the sign messages from the agent l , i.e., $\text{sign}(c_{l \rightarrow r}(k)(\mathbf{X}_{l,o}^r(k) - \mathbf{X}_{r,o}^l(t)))$ and $\text{sign}(d_{l \rightarrow r}(k)(\mathbf{Z}_{l,o}^r(k) - \mathbf{Z}_{r,o}^l(t)))$. Taking \mathbf{X} for example, the honest-but-curious agent r collects information from K iterations:

$$\begin{aligned} \mathbf{y}_s^0 &= \text{sign}(c_{l \rightarrow r}(0)(\mathbf{X}_{l,o}^r(0) - \mathbf{X}_{r,o}^l(t))), \\ \mathbf{y}_s^1 &= \text{sign}(c_{l \rightarrow r}(1)(\mathbf{X}_{l,o}^r(1) - \mathbf{X}_{r,o}^l(t))), \\ &\dots \\ \mathbf{y}_s^K &= \text{sign}(c_{l \rightarrow r}(K)(\mathbf{X}_{l,o}^r(K) - \mathbf{X}_{r,o}^l(t))). \end{aligned}$$

To the honest-but-curious agent r , the sign signals \mathbf{y}_s^k and $\mathbf{X}_{r,o}^l(k)$ are known, while $\mathbf{X}_{l,o}^r(t)$ and $c_{l \rightarrow r}(k)$ are unknown. Therefore, $\mathbf{X}_{r,o}^l(t)$ cannot be inferred by the honest-but-curious agent r .

- The third-party aggregator only obtains the weighted differences of two messages from the agent l , i.e., $(c_{l \rightarrow r}(k)(\mathbf{X}_{l,o}^r(k) - \mathbf{X}_{r,o}^l(t)))$ and $(d_{l \rightarrow r}(k)(\mathbf{Z}_{l,o}^r(k) - \mathbf{Z}_{r,o}^l(t)))$. Taking \mathbf{X} for example, the third-party aggregator collects information from K iterations:

$$\begin{aligned} \mathbf{y}_t^0 &= (c_{l \rightarrow r}(0)(\mathbf{X}_{l,o}^r(0) - \mathbf{X}_{r,o}^l(t))), \\ \mathbf{y}_t^1 &= (c_{l \rightarrow r}(1)(\mathbf{X}_{l,o}^r(1) - \mathbf{X}_{r,o}^l(t))), \\ &\dots \\ \mathbf{y}_t^K &= (c_{l \rightarrow r}(K)(\mathbf{X}_{l,o}^r(K) - \mathbf{X}_{r,o}^l(t))). \end{aligned}$$

To the third-party aggregator, only the signals \mathbf{y}_t^k are known, while $\mathbf{X}_{l,o}^r(k)$, $\mathbf{X}_{r,o}^l(t)$ and $c_{l \rightarrow r}(k)$ are unknown. Therefore, $\mathbf{X}_{l,o}^r(k)$, $\forall k = 1, \dots, K$ and $\mathbf{X}_{r,o}^l(t)$ cannot be inferred by the the third-party aggregator.

This completes the proof. \blacksquare

Theorem 2: Assume that all agents follow Algorithm 3. Then agent l 's exact state values $\mathbf{X}_r^l(t)$ and $\mathbf{Z}_r^l(t)$ over the boundaries cannot be inferred by an honest-but-curious agent r unless $\mathbf{X}_l^r(t) = \mathbf{X}_r^l(t)$ and $\mathbf{Z}_l^r(t) = \mathbf{Z}_r^l(t)$.

Proof: Suppose that an honest-but-curious agent r collects information from T outer iterations to infer the information of a neighboring agent l . From the perspective of adversary agent r , the measurements received by agent r in the outer t th iteration are $\mathbf{y}_x^t = a_{r \rightarrow l}(t) \cdot a_{l \rightarrow r}(t)(\mathbf{X}_{l,o}^r(t) - \mathbf{X}_{r,o}^l(t))$ and $\mathbf{y}_z^t = b_{r \rightarrow l}(t) \cdot b_{l \rightarrow r}(t)(\mathbf{Z}_{l,o}^r(t) - \mathbf{Z}_{r,o}^l(t))$ ($o \in \mathcal{O}_{rl}$, $t = 0, 1, \dots, T$). In this way, the honest-but-curious agent r can

establish $(T + 1) \times |\mathcal{O}_{rl}| \times 2$ equations. In the following, we consider one element of \mathbf{X}_l^r .

$$\begin{aligned} \mathbf{y}_x^0 &= a_{r \rightarrow l}(0) \cdot a_{l \rightarrow r}(0)(\mathbf{X}_{l,o}^r(0) - \mathbf{X}_{r,o}^l(0)), \\ \mathbf{y}_x^1 &= a_{r \rightarrow l}(1) \cdot a_{l \rightarrow r}(1)(\mathbf{X}_{l,o}^r(1) - \mathbf{X}_{r,o}^l(1)), \\ &\dots \\ \mathbf{y}_x^T &= a_{r \rightarrow l}(T) \cdot a_{l \rightarrow r}(T)(\mathbf{X}_{l,o}^r(T) - \mathbf{X}_{r,o}^l(T)). \end{aligned} \quad (35)$$

To the honest-but-curious agent r in the above system, \mathbf{y}_x^t , $a_{r \rightarrow l}(t)$, $\mathbf{X}_{l,o}^r(t)$ ($t = 0, 1, \dots, T$) are known, but $a_{l \rightarrow r}(t)$ and $\mathbf{X}_{r,o}^l(t)$ ($t = 0, 1, \dots, T$) are unknown. Therefore, the system of Eq. (35) over $T + 1$ equations contains $2 * (T + 1)$ unknown variables. Therefore, the honest-but-curious agent r cannot solve the system of Eq. (35) to infer the exact values of unknowns $a_{l \rightarrow r}(t)$ and $\mathbf{X}_{r,o}^l(t)$ ($t = 0, 1, \dots, T$) of agent l , except when $\mathbf{y}_x^t = 0$ and $\mathbf{X}_{l,o}^r(t) = \mathbf{X}_{r,o}^l(t)$.

This completes the proof. \blacksquare

Theorem 3: Assume that all agents follow Algorithms 2 and 3. Then exact gradient of C^l of agent l cannot be inferred by an honest-but-curious agent r .

Proof: Recall that

$$\begin{aligned} \nabla_{\mathbf{X}^l} C_i^l &= [2a_i(\mathbf{G}_i^l)^T (\text{Tr}\{(\mathbf{G}_i^l \mathbf{X}^l - \mathbf{Z}_i^l \mathbf{Z}^l)\} + P_{D_i}) + b_i(\mathbf{G}_i^l)^T], \\ \nabla_{\mathbf{Z}^l} C_i^l &= [2a_i(-\mathbf{Z}_i^l)^T (\text{Tr}\{(\mathbf{G}_i^l \mathbf{X}^l - \mathbf{Z}_i^l \mathbf{Z}^l)\} + P_{D_i}) - b_i(\mathbf{Z}_i^l)^T]. \end{aligned}$$

If the generator G_i is not on the boundary of region r and region l , the messages \mathbf{X}_r^l and \mathbf{Z}_r^l do not include the generator G_i . Therefore, the above gradient of C^l of agent l cannot be inferred by an honest-but-curious agent r .

Otherwise, Theorem 2 proves that the messages \mathbf{X}_r^l and \mathbf{Z}_r^l cannot be inferred by an honest-but-curious agent r . Therefore, $\nabla_{\mathbf{X}^l} C_i^l$ and $\nabla_{\mathbf{Z}^l} C_i^l$ cannot be inferred. \blacksquare

Corollary 1: Assume that all agents follow Algorithm 2. The agent l 's intermediate states, gradients of objective functions, and objective functions cannot be inferred by an external eavesdropper.

Proof: Since all exchanged messages are encrypted, an external eavesdropper cannot learn anything by intercepting these messages. In addition, the sign signals do not expose any state information to eavesdroppers. Therefore, it cannot infer any agent's intermediate states, gradients of objective functions, and objective functions. \blacksquare

Corollary 2: Assume that all agents follow Algorithm 3. Both the agent r and agent l 's intermediate states, gradients of objective functions, and objective functions cannot be inferred by an external eavesdropper and the third party.

Proof: Following a similar line to the reasoning of Corollary 1 and Theorem 2, we can obtain Corollary 2. \blacksquare

B. Stopping Criterion

We define the residual as follows.

$$\Psi_r = \left\| \begin{bmatrix} \mathbf{X}_l^r \\ \mathbf{Z}_l^r \end{bmatrix} - \begin{bmatrix} \mathbf{X}_r^l \\ \mathbf{Z}_r^l \end{bmatrix} \right\|_2. \quad (36)$$

The residue gives rise to the following stopping criterion:

$$\Psi_r(t + 1) \leq \epsilon, \forall r = 1, \dots, R, \quad (37)$$

where $\Psi_r(t+1)$ is the primal residue after $t+1$ iterations. If $\Psi_r(t+1), \forall r$ approach zeros, the feasibility of the primal variables and the convergence of the dual variables are both satisfied.

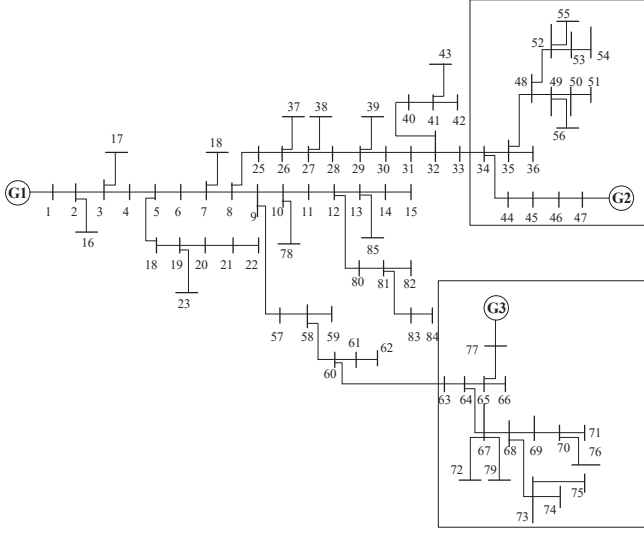

Fig. 2: The 85-bus tree distribution system with three regions.

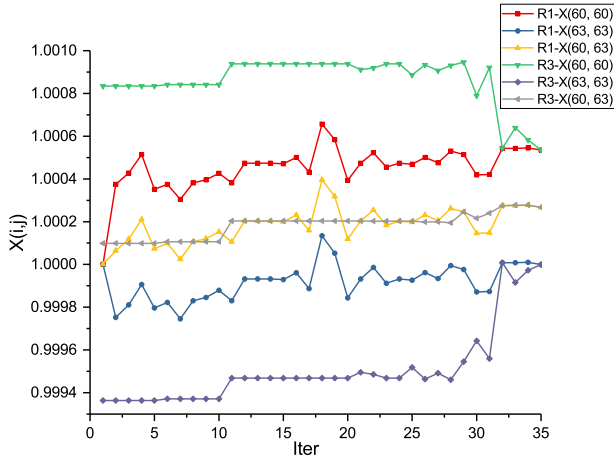

Fig. 3: The evolution of $\mathbf{X}_{l,o}^r$.

V. CASE STUDIES

In this section, we adopt the 85-bus tree distribution system to validate the proposed privacy-preserving distributed OPF algorithm. We partition the system into three regions, as shown in Fig. 2. In particular, two AC generators are added to buses 47 and 77, where fuel cost parameters are $a_i = 0.2$, $b_i = 2$ and $c_i = 2$. Other data for the 85-bus system can be found in MATPOWER's library. We set $\epsilon = 10^{-6}$ as the termination criterion of the distributed algorithm.

We set $N_{max} = 10^{10}$ to convert each element in \mathbf{X} and \mathbf{Z} to a 64-bit integer during intermediate computation. $a_{r \rightarrow l}(t)$, $b_{r \rightarrow l}(t)$, $c_{r \rightarrow l}(k)$ and $d_{r \rightarrow l}(k)$ are also scaled to 64-bit integers, respectively. In particular, $a_{r \rightarrow l}(t)$, $b_{r \rightarrow l}(t)$, $c_{r \rightarrow l}(k)$ and $d_{r \rightarrow l}(k)$ are random integers between [100, 200]. α in (15) is set to 0.48. Therefore, ρ_{rl} and κ_{rl} vary between

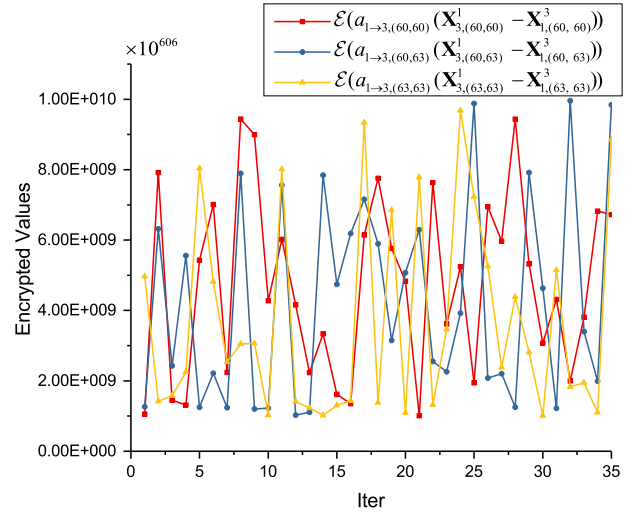

Fig. 4: The evolution of encrypt weighted differences (in ciphertext).

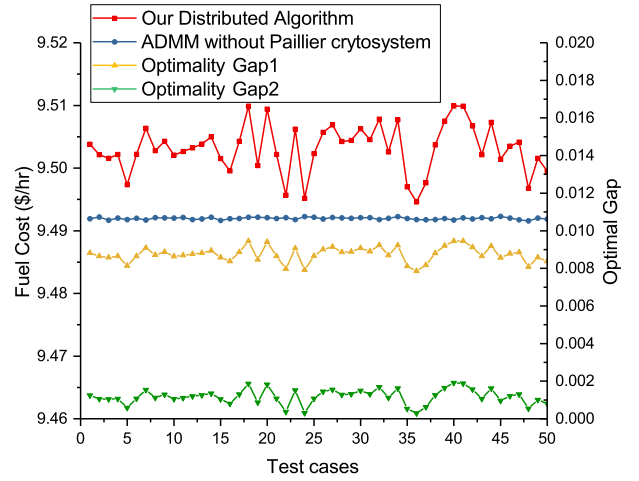

Fig. 5: The optimal values of the proposed algorithm, the ADMM algorithm, and optimal gaps.

$[10^4, 4 \times 10^4]$. The encryption and decryption keys are chosen to be 1028-bit long. All algorithms are executed on a 64-bit Mac with 2.4 GHz (Turbo Boost up to 5.0GHz) 8-Core Intel Core i9 and a total of 16 GB RAM.

A. Evaluation of Our Approach

Fig. 3 illustrates the evolution of optimal solution of $\mathbf{X}_{l,o}^r$ in one specific run of Algorithm 3. After 35 iterations, the algorithm converges. Fig. 4 visualizes the encrypted weighted differences (in ciphertext) of the states, i.e., $\mathcal{E}(a_{1 \rightarrow 3, (60,60)}(\mathbf{X}_{3,(60,60)}^1 - \mathbf{X}_{1,(60,60)}^3))$, $\mathcal{E}(a_{1 \rightarrow 3, (60,63)}(\mathbf{X}_{3,(60,63)}^1 - \mathbf{X}_{1,(60,63)}^3))$ and $\mathcal{E}(a_{1 \rightarrow 3, (63,63)}(\mathbf{X}_{3,(63,63)}^1 - \mathbf{X}_{1,(63,63)}^3))$. Although the states of all agents converge after 36 iterations, the encrypted weighted differences (in ciphertext) are random to an outside eavesdropper. In addition, it takes about 1ms for each agent to finish the encryption/decryption process at each iteration. Such a communication delay can be omitted compared with the time cost of each iteration.

In Fig. 5, we show that the optimality gap of the proposed algorithm is actually small. We define the optimality gap as difference of the obtained solution and the optimal

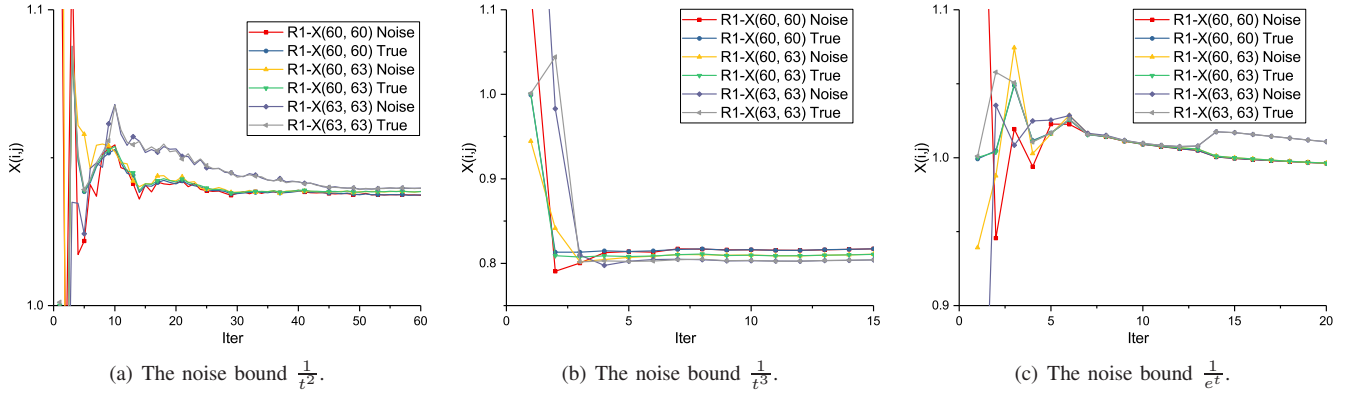

Fig. 6: The evolution of $\mathbf{X}_{l,o}^r$ in three noise bounds.

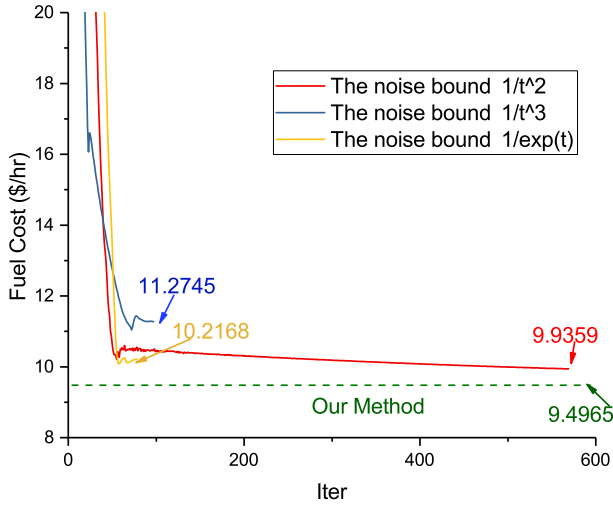

Fig. 7: The evolution of fuel costs under three noise bounds vs the optimal value achieved by our algorithm.

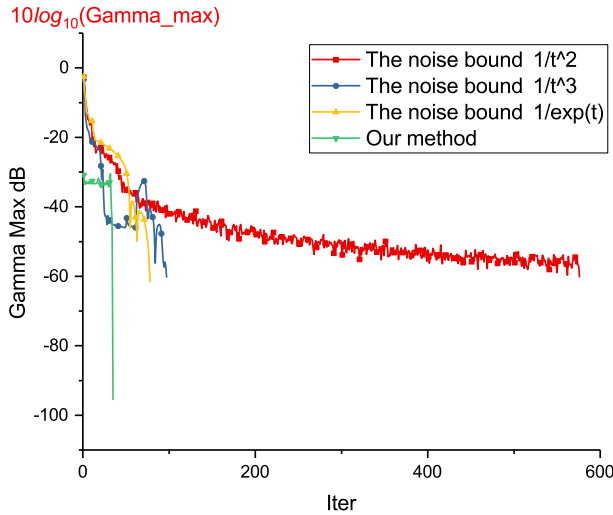

Fig. 8: Convergence of the proposed algorithm VS differential-privacy methods.

solution normalized to the obtained solution. In particular, gap_1 measures the optimality gap of the solution obtained by Algorithms 2&3. In addition, gap_2 measures the gap between the solutions obtained by Algorithms 2&3 and by ADMM without Paillier cryptosystem (normalized to the solution by

Algorithms 2&3). Fig. 5 shows that both gap_1 and gap_2 are very small, i.e., on average 0.87540% and 0.11815% for gap_1 and gap_2 , respectively. This indicates that the solutions by the proposed algorithms are very close to the global optimum.

B. Comparison with the Differential-Privacy Algorithm

We then compare our approach with the differential-privacy distributed optimization algorithm. In the differential-privacy distributed optimization algorithm, the messages are added with random noises. For example, a random noise $n_{l,o}^{r,x,t}$ is added into $\mathbf{X}_{l,o}^{r,t}$, denoted by $\tilde{\mathbf{X}}_{l,o}^{r,t} = \mathbf{X}_{l,o}^{r,t} + n_{l,o}^{r,x,t}$. Similarly, $n_{l,o}^{r,z,t}$ is added into $\mathbf{Z}_{l,o}^{r,t}$, denoted by $\tilde{\mathbf{Z}}_{l,o}^{r,t} = \mathbf{Z}_{l,o}^{r,t} + n_{l,o}^{r,z,t}$. In [27], both $n_{l,o}^{r,x,t}$ and $n_{l,o}^{r,z,t}$ are bounded in $[-\hat{n}_{l,o}^{r,t}, \hat{n}_{l,o}^{r,t}]$. The bound $\hat{n}_{l,o}^{r,t} \in \mathbb{R}^+$ satisfies the following conditions:

$$\sum_{t=0}^{\infty} \hat{n}_{l,o}^{r,t} < \infty, \quad \sum_{t=0}^{\infty} (\hat{n}_{l,o}^{r,t})^2 < \infty. \quad (38)$$

Therefore, we choose three kinds of harmonic series, i.e., $\hat{n}_{l,o}^{r,t} = \frac{\hat{n}_{l,o}^{r,0}}{t^2}$, $\hat{n}_{l,o}^{r,t} = \frac{\hat{n}_{l,o}^{r,0}}{t^3}$ and $\hat{n}_{l,o}^{r,t} = \hat{n}_{l,o}^{r,0} e^{-t}$ for comparison. Fig. 6 visualizes the true messages and the messages with noises. In particular, Fig. 6(a) shows that the differences between the true messages and the messages with noises are obvious before 20 iterations, while messages with noises are very close to the true messages after 20 iterations until convergence. Therefore, both honest-but-curious agents and eavesdroppers can infer the true messages easily. Similarly, other harmonic series are likely to disclose the true messages, as shown in Fig. 6(b) and Fig. 6(c).

Fig. 7 shows that the case with the noise bound $\frac{\hat{n}_{l,o}^{r,0}}{t^2}$ converges to 9.9359 \$/hr, the case with the noise bound $\frac{\hat{n}_{l,o}^{r,0}}{t^3}$ converges to 11.2745 \$/hr and the case with the noise bound $\hat{n}_{l,o}^{r,0} e^{-t}$ converges to 10.2168 \$/hr. In comparison, our algorithm achieves 9.4965 \$/hr of fuel costs, which is very close to the global optimal (i.e., 9.42 \$/hr) with a gap of 0.80556%. This is because the added noises disturb the shared messages and inevitably compromise the accuracy of optimization results, leading to a trade-off between privacy and accuracy.

C. Convergence of Our Approach

The maximal residue of Algorithm 2 and 3 at the t th iteration is defined as $\Psi_{max}^t = \max_{r=1, \dots, R} \Psi_r^t$. Fig. 8 shows that the cases with noise bounds $\hat{n}_{l,o}^{r,t} = \frac{\hat{n}_{l,o}^{r,0}}{t^2}$, $\hat{n}_{l,o}^{r,t} = \frac{\hat{n}_{l,o}^{r,0}}{t^3}$ and $\hat{n}_{l,o}^{r,t} = \hat{n}_{l,o}^{r,0} e^{-t}$ take 79, 97 and 576 iterations to converge, while the proposed algorithm converges within 35 iterations. It indicates that the proposed algorithm converges much faster than the differential-privacy distributed algorithm. This is because that the noise-polluted messages cannot reach a consensus before the noise attenuates to zero.

VI. CONCLUSION

This paper proposed a novel privacy-preserving DOPF algorithm based on PHE. The proposed algorithm utilized the ADMM method with the SDP relaxation to solve the OPF problem. For the dual update of the ADMM, we utilized the PHE to encrypt the difference of state variables across neighboring agents. As a result, neither the eavesdroppers nor honest-but-curious agents can infer the exact states. For the primal update, we relaxed the augmented term of the primal update of ADMM with the ℓ_1 -norm regularization, and then utilized the sign message communications to enable the privacy-preserving primal update. At last, we proved the privacy preservation guarantee of the proposed algorithm. In addition, numerical case studies showed that the optimality gap of the proposed algorithm is actually small, i.e., only 0.8754% between the solution obtained by the proposed algorithm and the global optimum. Compared with the differential-privacy distributed optimization methods, the proposed method yields a better solution, and converges much faster.

APPENDIX

In the appendix, we prove Proposition 1 and Proposition 2. First of all, let d_{g_i} be an auxiliary variable, which always equals to one. Obviously, $d_{g_i}^2 = 1$, $P_{G_i} = P_{G_i} d_{g_i}$ and $Q_{G_i} = Q_{G_i} d_{g_i}$. In the meantime, by introducing slack variables u_{g_i} , l_{g_i} , u_{r_i} , l_{r_i} , u_{b_i} and l_{b_i} , inequality constraints (10) can be transformed into equality constraints as $u_{g_i}^2 \geq 0$, $l_{g_i}^2 \geq 0$, $u_{r_i}^2 \geq 0$, $l_{r_i}^2 \geq 0$, $u_{b_i}^2 \geq 0$ and $l_{b_i}^2 \geq 0$.

A. Proposition 1

Problem (15) in region r can be equivalently written as:

$$\arg \min \sum_{i=1}^{|\mathcal{R}_r^g|} a_i P_{G_i}^2 + b_i P_{G_i} + c_i + \sum_{l \in \mathcal{N}^{\delta(r)}} [\text{Tr}((\mathbf{\Gamma}_l^r)^T (\mathbf{X}_l^r - \mathbf{X}_l^l)) + \text{Tr}((\mathbf{\Lambda}_l^r)^T (\mathbf{Z}_l^r - \mathbf{Z}_l^l)) + \alpha \|\mathbf{vec}(\mathbf{X}_l^r - \mathbf{X}_l^l)\|_1 + \alpha \|\mathbf{vec}(\mathbf{Z}_l^r - \mathbf{Z}_l^l)\|_1] \quad (39a)$$

$$\text{s.t.} \quad P_{G_i} d_{g_i} - P_{D_i} = \text{Tr}\{\mathbf{Y}_i^r \mathbf{W}^r\}, i \in \mathcal{R}_r^g, \quad (39b)$$

$$Q_{G_i} d_{g_i} - Q_{D_i} = \text{Tr}\{\mathbf{\bar{Y}}_i^r \mathbf{W}^r\}, i \in \mathcal{R}_r^g, \quad (39c)$$

$$-P_{D_i} = \text{Tr}\{\mathbf{Y}_i^r \mathbf{W}^r\}, i \in \mathcal{B}_r / \mathcal{R}_r^g, \quad (39d)$$

$$-Q_{D_i} = \text{Tr}\{\mathbf{\bar{Y}}_i^r \mathbf{W}^r\}, i \in \mathcal{B}_r / \mathcal{R}_r^g, \quad (39e)$$

$$\text{Tr}\{\mathbf{M}_i^r \mathbf{W}^r\} + u_{b_i}^2 = \bar{V}_i^2, i \in \mathcal{B}_r, \quad (39f)$$

$$\text{Tr}\{\mathbf{M}_i^r \mathbf{W}^r\} - l_{b_i}^2 = \underline{V}_i^2, i \in \mathcal{B}_r, \quad (39g)$$

$$P_{G_i} d_{g_i} + u_{g_i}^2 = \bar{P}_{G_i}, i \in \mathcal{R}_r^g, \quad (39h)$$

$$P_{G_i} d_{g_i} - l_{g_i}^2 = \underline{P}_{G_i}, i \in \mathcal{R}_r^g, \quad (39i)$$

$$Q_{G_i} d_{g_i} + u_{r_i}^2 = \bar{Q}_{G_i}, i \in \mathcal{R}_r^g, \quad (39j)$$

$$Q_{G_i} d_{g_i} - l_{r_i}^2 = \underline{Q}_{G_i}, i \in \mathcal{R}_r^g, \quad (39k)$$

$$d_{g_i}^2 = 1, i \in \mathcal{R}_r^g, \quad (39l)$$

$$\mathbf{W}^r \succeq 0. \quad (39m)$$

We transform the objective (39a) as

$$\arg \min \sum_{i=1}^{|\mathcal{R}_r^g|} a_i P_{G_i}^2 + b_i P_{G_i} + c_i + \sum_{l \in \mathcal{N}^{\delta(r)}} [\text{Tr}((\mathbf{\Gamma}_l^r + j \mathbf{\Lambda}_l^r)^H \mathbf{W}_l^r) + \alpha \sum_{o \in \mathcal{O}_{r,l}} (|\mathbf{X}_{l,o}^r - \mathbf{X}_{r,o}^l| + |\mathbf{Z}_{l,o}^r - \mathbf{Z}_{r,o}^l|)]. \quad (40a)$$

Recall that $\{\mathbf{\Gamma}_l^r(t)\}$ and $\{\mathbf{\Lambda}_l^r(t)\}$, $\forall t, r, l$ are symmetric and skew-symmetric matrices, respectively. Therefore, $\text{Tr}((\mathbf{\Gamma}_l^r)^T \mathbf{Z}_l^r)$ and $\text{Tr}((\mathbf{\Lambda}_l^r)^T \mathbf{X}_l^r)$ are both equal to zeros.

We further define $\mathbf{N}_{ij}^r = \frac{1}{2}(e_i^r e_j^{rT} + e_j^r e_i^{rT})$ and $\hat{\mathbf{N}}_{ij}^r = \frac{\sqrt{-1}}{2}(e_i^r e_j^{rT} - e_j^r e_i^{rT})$, where e_i^r is the i th basis vector in $\mathbb{R}^{|\mathcal{B}_r|}$. Therefore, Problem (39) is equivalent to

$$\arg \min \sum_{i=1}^{|\mathcal{R}_r^g|} a_i P_{G_i}^2 + b_i P_{G_i} + c_i + \sum_{l \in \mathcal{N}^{\delta(r)}} [\text{Tr}((\mathbf{\Gamma}_l^r + j \mathbf{\Lambda}_l^r)^H \mathbf{W}_l^r) + \alpha (\partial_{k,i}^{r,l} \text{Tr}\{\mathbf{M}_i^r \mathbf{W}^r\} + \partial_{k,i,j}^{r,l} \text{Tr}\{\mathbf{M}_j^r \mathbf{W}^r\} + \partial_{k,i,j}^{r,l} \text{Tr}\{\mathbf{N}_{ij}^r \mathbf{W}^r\} + \partial_{k,i,j}^{r,l} \text{Tr}\{\hat{\mathbf{N}}_{ij}^r \mathbf{W}^r\})] \quad (41a)$$

s.t. (39b)-(39m). (41b)

where $\partial_{k,i}^{r,l}$, $\partial_{k,j}^{r,l}$, $\partial_{k,i,j}^{r,l}$ and $\partial_{k,i,j}^{r,l}$ denote the subgradients of $|\mathbf{X}_{l,(i,i)}^r - \mathbf{X}_{r,(i,i)}^l|$, $|\mathbf{X}_{l,(j,j)}^r - \mathbf{X}_{r,(j,j)}^l|$, $|\mathbf{X}_{l,(i,j)}^r - \mathbf{X}_{r,(i,j)}^l|$ and $|\mathbf{Z}_{l,(i,j)}^r - \mathbf{Z}_{r,(i,j)}^l|$ in the k th iteration, respectively. Note that buses i, j are the boundary buses and these subgradients are the sign signals from the aggregator.

To transform the constraints to SDP, we also introduce some vectors:

- 1) Group of active powers of generators:

$$x_1 = [P_{G_1}, d_{g_1}, \dots, P_{G_i}, d_{g_i}, \dots], \forall i \in \mathcal{R}_r^g \quad (42)$$

- 2) Group of reactive powers of generators:

$$x_2 = [Q_{G_1}, d_{g_1}, \dots, Q_{G_i}, d_{g_i}, \dots], \forall i \in \mathcal{R}_r^g \quad (43)$$

- 3) Group of slack variables for active powers:

$$x_3 = [u_{g_1}, l_{g_1}, \dots, u_{g_i}, l_{g_i}, \dots], \forall i \in \mathcal{R}_r^g \quad (44)$$

- 4) Group of slack variables for reactive powers:

$$x_4 = [u_{r_1}, l_{r_1}, \dots, u_{r_i}, l_{r_i}, \dots], \forall i \in \mathcal{R}_r^g \quad (45)$$

- 5) Group of complex voltages:

$$x_5 = [V_1, \dots, V_i, \dots], \forall i \in \mathcal{B}_r \quad (46)$$

6) Group of slack variables for complex voltages:

$$x_6 = [u_{b_1}, l_{b_1}, \dots, u_{b_i}, l_{b_i}, \dots], \forall i \in \mathcal{B}_r \quad (47)$$

Afterward, the SDP variable can be defined by:

$$X = x^H x, \quad (48)$$

where $x = [x_1, x_2, x_3, x_4, x_5, x_6]$. Therefore, the matrix X is positive definite or semidefinite, i.e., $X \succeq 0$. Note that the rank of X should also be 1. A convex SDP relaxation is obtained by removing the rank constraint. By Theorem 9 of [23], when the cost function is convex and the network is a tree, the SDP relaxation is exact under mild technical conditions.

$$X = \begin{bmatrix} X_1 & \cdots & \cdots & \cdots & \cdots & \cdots \\ \vdots & X_2 & \ddots & \ddots & \ddots & \vdots \\ \vdots & \ddots & X_3 & \ddots & \ddots & \vdots \\ \vdots & \ddots & \ddots & X_4 & \ddots & \vdots \\ \vdots & \ddots & \ddots & \ddots & X_5 & \vdots \\ \vdots & \cdots & \cdots & \cdots & \cdots & X_6 \end{bmatrix}. \quad (49)$$

Note that some elements in X are replaced with ellipses, indicating that the relevant coefficients of those elements are always zeros. Therefore, the matrix X can be treated as a block-diagonal symmetric matrix. In particular, $X_5 = x_5^H x_5 = (\mathbf{W}^r)^T$. We define X_1, X_2, X_3, X_4 and X_6 as follows.

$$X_1 = \begin{bmatrix} P_{G_1}^2 & P_{G_1} d_{g_1} & P_{G_1} P_{G_2} & \cdots & \cdots \\ P_{G_1} d_{g_1} & d_{g_1}^2 & \ddots & \ddots & \vdots \\ P_{G_1} P_{G_2} & \ddots & P_{G_2}^2 & \ddots & \vdots \\ \vdots & \ddots & \ddots & d_{g_2}^2 & \vdots \\ \vdots & \cdots & \cdots & \cdots & \cdots \end{bmatrix}. \quad (50)$$

$$X_2 = \begin{bmatrix} Q_{G_1}^2 & Q_{G_1} d_{g_1} & Q_{G_1} P_{G_2} & \cdots & \cdots \\ Q_{G_1} d_{g_1} & d_{g_1}^2 & \ddots & \ddots & \vdots \\ Q_{G_1} P_{G_2} & \ddots & Q_{G_2}^2 & \ddots & \vdots \\ \vdots & \ddots & \ddots & d_{g_2}^2 & \vdots \\ \vdots & \cdots & \cdots & \cdots & \cdots \end{bmatrix}. \quad (51)$$

$$X_3 = \begin{bmatrix} u_{g_1}^2 & u_{g_1} l_{g_1} & u_{g_1} u_{g_2} & u_{g_1} l_{g_2} & \cdots \\ u_{g_1} l_{g_1} & l_{g_1}^2 & \ddots & \ddots & \vdots \\ u_{g_1} u_{g_2} & \ddots & u_{g_2}^2 & \ddots & \vdots \\ u_{g_1} l_{g_2} & \ddots & \ddots & l_{g_2}^2 & \vdots \\ \vdots & \cdots & \cdots & \cdots & \cdots \end{bmatrix}. \quad (52)$$

$$X_4 = \begin{bmatrix} u_{r_1}^2 & u_{r_1} l_{r_1} & u_{r_1} u_{r_2} & u_{r_1} l_{r_2} & \cdots \\ u_{r_1} l_{r_1} & l_{r_1}^2 & \ddots & \ddots & \vdots \\ u_{r_1} u_{r_2} & \ddots & u_{r_2}^2 & \ddots & \vdots \\ u_{r_1} l_{r_2} & \ddots & \ddots & l_{r_2}^2 & \vdots \\ \vdots & \cdots & \cdots & \cdots & \cdots \end{bmatrix}. \quad (53)$$

$$X_6 = \begin{bmatrix} u_{b_1}^2 & u_{b_1} l_{b_1} & u_{b_1} u_{b_2} & u_{b_1} l_{b_2} & \cdots \\ u_{b_1} l_{b_1} & l_{b_1}^2 & \ddots & \ddots & \vdots \\ u_{b_1} u_{b_2} & \ddots & u_{b_2}^2 & \ddots & \vdots \\ u_{b_1} l_{b_2} & \ddots & \ddots & l_{b_2}^2 & \vdots \\ \vdots & \cdots & \cdots & \cdots & \cdots \end{bmatrix}. \quad (54)$$

Ignoring the rank-1 constraint on X , problem (41) can be relaxed to the primal SDP (24), which is copied here for convenience:

$$\text{Primal: } \arg \min \text{Tr}(A_0(\boldsymbol{\theta}))^T X), \quad (55a)$$

$$\text{s.t. } \text{Tr}(A_m^T X) = b_m, \forall m = \{1, \dots, M\} \quad (55b)$$

$$X \succeq 0. \quad (55c)$$

Here, the coefficient matrices $A_m, m = 1, \dots, M$ have the same dimension as X and $\boldsymbol{\theta}$ is the set of all sign signals $\partial_{k,i}^{r,l}, \partial_{k,j}^{r,l}, \partial_{k,ij}^{r,l}$ and $\partial_{k,\hat{ij}}^{r,l}, \forall k, i, j, r, l$. The construction of the matrices $A_m, m = 1, \dots, M$, are defined as follows:

$$A_m = \begin{bmatrix} A_{1,m} & \cdots & \cdots & \cdots & \cdots & \cdots \\ \vdots & A_{2,m} & \ddots & \ddots & \ddots & \vdots \\ \vdots & \ddots & A_{3,m} & \ddots & \ddots & \vdots \\ \vdots & \ddots & \ddots & A_{4,m} & \ddots & \vdots \\ \vdots & \ddots & \ddots & \ddots & A_{5,m} & \vdots \\ \vdots & \cdots & \cdots & \cdots & \cdots & A_{6,m} \end{bmatrix}. \quad (56)$$

In order to construct A_0 , we first focus on the fuel cost of generator G_i on bus i , i.e., $\sum_{i=1}^{|\mathcal{R}_i^g|} a_i P_{G_i}^2 + b_i P_{G_i} + c_i$. Therefore, $A_{1,0}$ can be constructed as

$$A_{1,0} = \begin{bmatrix} a_1 & 0.5b_1 & \cdots & \cdots & \cdots & \cdots \\ 0.5b_1 & c_1 & \ddots & \ddots & \vdots & \cdots \\ \vdots & \ddots & \ddots & \ddots & \vdots & \cdots \\ \vdots & \ddots & \ddots & a_i & 0.5b_i & \cdots \\ \vdots & \cdots & \cdots & 0.5b_i & c_i & \cdots \\ \vdots & \cdots & \cdots & \cdots & \cdots & \cdots \end{bmatrix}. \quad (57)$$

In addition, we have $\text{Tr}((\Gamma_l^r + j\Lambda_l^r)^H \mathbf{W}_l^r)$ for $l \in \mathcal{N}^{\delta(r)}$, which can be constructed as

$$A_{5,0}^{l,tr} = \mathbf{E}_{r \rightarrow l}^T (\Gamma_l^r - j\Lambda_l^r) \mathbf{E}_{r \rightarrow l}. \quad (58)$$

Similarly, we define $A_{5,0}^{l,(i,i)} = \alpha \partial_{k,i}^{rl} \{\mathbf{M}_i^r\}$, $A_{5,0}^{l,(j,j)} = \alpha \partial_{k,j}^{rl} \{\mathbf{M}_j^r\}$, $A_{5,0}^{l,(i,j)} = \alpha \partial_{k,ij}^{rl} \{\mathbf{N}_{ij}^r\}$, $A_{5,0}^{l,(j,i)} = \alpha \partial_{k,ij}^{rl} \{\hat{\mathbf{N}}_{ij}^r\}$.

Therefore, $A_{5,0}$ can be constructed as

$$A_{5,0} = \sum_{l \in \mathcal{N}^{\delta(r)}} \left(A_{5,0}^{l,tr} + \left[\sum_{o \in \mathcal{O}_{rl}} A_{5,0}^{l,o} \right] \right). \quad (59)$$

In addition, $A_{2,0}$, $A_{3,0}$, $A_{4,0}$, and $A_{6,0}$ are zeros matrices.

In the following, we introduce the construction of A_i corresponding to the constraints. Here, we only consider (39b), (39f), (39h) and (39m). Other constraints can be constructed in a similar way.

For Eq. (39b) with P_{G_1} , the corresponding A_m can be constructed as follows:

$$A_{5,m} = -\mathbf{Y}_i^r. \quad (60)$$

In addition, we have

$$A_{1,m} = \begin{bmatrix} \dots & 0.5 & \dots & \dots & \dots & \dots \\ 0.5 & \ddots & \ddots & \ddots & \vdots & \dots \\ \vdots & \ddots & \ddots & \ddots & \vdots & \dots \\ \vdots & \ddots & \ddots & \ddots & \dots & \dots \\ \vdots & \dots & \dots & \dots & \dots & \dots \\ \vdots & \dots & \dots & \dots & \dots & \dots \\ \vdots & \dots & \dots & \dots & \dots & \dots \end{bmatrix}. \quad (61)$$

Other terms of A_m , i.e., $A_{2,m}$, $A_{3,m}$, $A_{4,m}$, and $A_{6,m}$ corresponding to Eq. (55b) are zeros matrices. Accordingly, b_m in (55b) is P_{D_i} .

For Eq. (39f) with V_1 , the corresponding A_m is constructed as follows. First of all, we have

$$A_{5,m} = \mathbf{M}_i^r, \quad (62)$$

and

$$A_{6,m} = \begin{bmatrix} 1 & \dots & \dots & \dots & \dots & \dots \\ \dots & \ddots & \ddots & \ddots & \vdots & \dots \\ \vdots & \ddots & \ddots & \ddots & \vdots & \dots \\ \vdots & \ddots & \ddots & \ddots & \dots & \dots \\ \vdots & \dots & \dots & \dots & \dots & \dots \\ \vdots & \dots & \dots & \dots & \dots & \dots \end{bmatrix}. \quad (63)$$

In addition, $A_{1,m}$, $A_{2,m}$, $A_{3,m}$, and $A_{4,m}$ corresponding to Eq. (39f) are zero matrices. Accordingly, b_m in (55b) is \bar{V}_1^2 .

For Eq. (39h) with P_{G_1} , the corresponding A_m is constructed as

$$A_{1,m} = \begin{bmatrix} \dots & 0.5 & \dots & \dots & \dots & \dots \\ 0.5 & \ddots & \ddots & \ddots & \vdots & \dots \\ \vdots & \ddots & \ddots & \ddots & \vdots & \dots \\ \vdots & \ddots & \ddots & \ddots & \dots & \dots \\ \vdots & \dots & \dots & \dots & \dots & \dots \\ \vdots & \dots & \dots & \dots & \dots & \dots \end{bmatrix}, \quad (64)$$

and

$$A_{3,m} = \begin{bmatrix} 1 & \dots & \dots & \dots & \dots & \dots \\ \dots & \ddots & \ddots & \ddots & \vdots & \dots \\ \vdots & \ddots & \ddots & \ddots & \vdots & \dots \\ \vdots & \ddots & \ddots & \ddots & \dots & \dots \\ \vdots & \dots & \dots & \dots & \dots & \dots \\ \vdots & \dots & \dots & \dots & \dots & \dots \end{bmatrix}. \quad (65)$$

Besides, $A_{2,m}$, $A_{4,m}$, $A_{5,m}$, and $A_{6,m}$ corresponding to Eq. (39h) are zero matrices. Accordingly, b_m in (55b) is \bar{P}_{G_1} .

Last, we give A_m corresponding to Eq. (39m) with P_{G_1} as

$$A_{1,m} = \begin{bmatrix} 0 & \dots & \dots & \dots & \dots & \dots \\ \dots & 1 & \ddots & \ddots & \vdots & \dots \\ \vdots & \ddots & \ddots & \ddots & \vdots & \dots \\ \vdots & \ddots & \ddots & \ddots & \dots & \dots \\ \vdots & \dots & \dots & \dots & \dots & \dots \\ \vdots & \dots & \dots & \dots & \dots & \dots \end{bmatrix}. \quad (66)$$

Moreover, $A_{2,m}$, $A_{3,m}$, $A_{4,m}$, $A_{5,m}$, and $A_{6,m}$ corresponding to Eq. (39m) are zero matrices and b_m in (55b) is 1.

This completes the proof of Proposition 1. \blacksquare

In the following, we show the equivalence between (40a) and (41a) if the subgradient KKT conditions are employed.

In order to construct A'_0 , we formulate $A'_{5,0}$ as follows:

$$A'_{5,0} = \sum_{l \in \mathcal{N}^{\delta(r)}} \left(A_{5,0}^{l,tr} \right). \quad (67)$$

Other terms of A'_0 are the same as those of A_0 .

Because (40a) is non-differentiable, subdifferential versions of KKT conditions (Chapter 7 of [28]) are:

$$\partial L_X = A'_0 - \mu X^{-1} - \sum_{m=1}^M A_m y_m - \sum_{l \in \mathcal{N}^{\delta(r)}} \bar{A}_0(\alpha \partial_l^r), \quad (68a)$$

$$\nabla L_y = b_m - \text{Tr}(A_m^T X) = 0, \forall m = \{1, \dots, M\} \quad (68b)$$

where $A_{5,0}$ of $\bar{A}_0(\alpha \partial_l^r)$ is denoted by

$$A_{5,0} = \alpha \partial_{k,i}^{rl} \{\mathbf{M}_i^r\} + \alpha \partial_{k,j}^{rl} \{\mathbf{M}_j^r\} + \alpha \partial_{k,ij}^{rl} \{\mathbf{N}_{ij}^r\} + \alpha \partial_{k,ij}^{rl} \{\hat{\mathbf{N}}_{ij}^r\}. \quad (69)$$

Recall that $A_{5,0}^{l,(i,i)} = \alpha \partial_{k,i}^{rl} \{\mathbf{M}_i^r\}$, $A_{5,0}^{l,(j,j)} = \alpha \partial_{k,j}^{rl} \{\mathbf{M}_j^r\}$, $A_{5,0}^{l,(i,j)} = \alpha \partial_{k,ij}^{rl} \{\mathbf{N}_{ij}^r\}$ and $A_{5,0}^{l,(j,i)} = \alpha \partial_{k,ij}^{rl} \{\hat{\mathbf{N}}_{ij}^r\}$. In addition, $\partial_{k,i}^{rl} = \pm 1$, $\partial_{k,j}^{rl} = \pm 1$, $\partial_{k,ij}^{rl} = \pm 1$ and $\partial_{k,ij}^{rl} = \pm 1$. By incorporating all $\sum_{l \in \mathcal{N}^{\delta(r)}} \bar{A}_0(\alpha \partial_l^r)$ into A'_0 , we can obtain A_0 . Therefore, Problem (41) is equivalent to Problem (39).

B. Proof of Lemma 1

For all non-zero $\mathbf{z} = \mathbf{x} + \mathbf{j}\mathbf{y}$ in \mathbb{C}^N with \mathbf{x} and \mathbf{y} in \mathbb{R}^N , we have

$$\begin{aligned} \mathbf{z}^H \mathbf{W} \mathbf{z} &= (\mathbf{x}^T - \mathbf{j}\mathbf{y}^T)(\mathbf{X} + \mathbf{j}\mathbf{Z})(\mathbf{x} + \mathbf{j}\mathbf{y}) \\ &= \mathbf{x}^T \mathbf{X} \mathbf{x} + \mathbf{y}^T \mathbf{X} \mathbf{y} - \mathbf{x}^T \mathbf{Z} \mathbf{y} + \mathbf{y}^T \mathbf{Z} \mathbf{x} \\ &\quad + \mathbf{j}(\mathbf{x}^T \mathbf{Z} \mathbf{x} + \mathbf{y}^T \mathbf{Z} \mathbf{y} + \mathbf{x}^T \mathbf{X} \mathbf{y} - \mathbf{y}^T \mathbf{X} \mathbf{x}) \end{aligned} \quad (70)$$

It is obviously that $\mathbf{x}^T \mathbf{Z} \mathbf{x} = 0$ for all non-zero \mathbf{x} in \mathbb{R}^N because \mathbf{Z} is skew-symmetric. Similarly, $\mathbf{y}^T \mathbf{Z} \mathbf{y} = 0$. In addition, $\mathbf{x}^T \mathbf{X} \mathbf{y} - \mathbf{y}^T \mathbf{X} \mathbf{x} = 0$ because \mathbf{X} is symmetric. Therefore, (70) is reduced into $\mathbf{x}^T \mathbf{X} \mathbf{x} + \mathbf{y}^T \mathbf{X} \mathbf{y} - \mathbf{x}^T \mathbf{Z} \mathbf{y} + \mathbf{y}^T \mathbf{Z} \mathbf{x}$.

$$\begin{bmatrix} \mathbf{x} \\ \mathbf{y} \end{bmatrix}^T \begin{bmatrix} \mathbf{X} & -\mathbf{Z} \\ \mathbf{Z} & \mathbf{X} \end{bmatrix} \begin{bmatrix} \mathbf{x} \\ \mathbf{y} \end{bmatrix} = \mathbf{x}^T \mathbf{X} \mathbf{x} + \mathbf{y}^T \mathbf{X} \mathbf{y} - \mathbf{x}^T \mathbf{Z} \mathbf{y} + \mathbf{y}^T \mathbf{Z} \mathbf{x}. \quad (71)$$

Therefore, the semi-definiteness of (70) and (71) can imply each other.

This completes the proof. \blacksquare

REFERENCES

- [1] J. Lavaei and S. H. Low, "Zero Duality Gap in Optimal Power Flow Problem," *IEEE Trans. Power Syst.*, vol. 27, no. 1, pp. 92–107, 2011.
- [2] T. Wu, Y. J. Zhang, and X. Tang, "A VSC-Based BESS Model for Multi-Objective OPF Using Mixed Integer SOCP," *IEEE Trans. Power Syst.*, vol. 34, no. 4, pp. 2541–2552, 2019.
- [3] V. Dvorkin, P. Van Hentenryck, J. Kazempour, and P. Pinson, "Differentially Private Distributed Optimal Power Flow," *Proceedings of the 59th IEEE Conference on Decision and Control*, 2019.
- [4] H. Wang, J. Zhang, C. Lu, and C. Wu, "Privacy Preserving in Non-Intrusive Load Monitoring: A Differential Privacy Perspective," *IEEE Trans. Smart Grid*, pp. 1–1, 2020.
- [5] J. Liu, Y. Xiao, S. Li, W. Liang, and C. P. Chen, "Cyber security and privacy issues in smart grids," *IEEE Commun. Surveys Tuts.*, vol. 14, no. 4, pp. 981–997, 2012.
- [6] Q. Peng and S. H. Low, "Distributed Optimal Power Flow Algorithm for Radial Networks, I: Balanced Single Phase Case," *IEEE Trans. Smart Grid*, vol. 9, no. 1, pp. 111–121, 2016.
- [7] E. Dall'Anese, H. Zhu, and G. B. Giannakis, "Distributed Optimal Power Flow for Smart Microgrids," *IEEE Trans. Smart Grid*, vol. 4, no. 3, pp. 1464–1475, 2013.
- [8] T. Erseghe, "Distributed Optimal Power Flow using ADMM," *IEEE Trans. Power Syst.*, vol. 29, no. 5, pp. 2370–2380, 2014.
- [9] B. Zhang, A. Y. Lam, A. D. Domínguez-García, and D. Tse, "An Optimal and Distributed Method for Voltage Regulation in Power Distribution Systems," *IEEE Trans. Power Syst.*, vol. 30, no. 4, pp. 1714–1726, 2014.
- [10] C. Lin, W. Wu, and M. Shahidehpour, "Decentralized AC Optimal Power Flow for Integrated Transmission and Distribution Grids," *IEEE Trans. Smart Grid*, vol. 11, no. 3, pp. 2531–2540, 2019.
- [11] M.-M. Zhao, Q. Shi, Y. Cai, M.-J. Zhao, and Y. Li, "Distributed Penalty Dual Decomposition Algorithm for Optimal Power Flow in Radial Networks," *IEEE Trans. Power Syst.*, vol. 35, no. 3, pp. 2176–2189, 2019.
- [12] A. Y. Lam, B. Zhang, and N. T. David, "Distributed Algorithms for Optimal Power Flow Problem," in *2012 IEEE 51st IEEE Conference on Decision and Control (CDC)*. IEEE, 2012, pp. 430–437.
- [13] A. S. Musleh, G. Chen, and Z. Y. Dong, "A Survey on the Detection Algorithms for False Data Injection Attacks in Smart Grids," *IEEE Trans. Smart Grid*, vol. 11, no. 3, pp. 2218–2234, 2019.
- [14] S. Han, U. Topcu, and G. J. Pappas, "Differentially Private Distributed Constrained Optimization," *IEEE Trans. Autom. Control*, vol. 62, no. 1, pp. 50–64, 2016.
- [15] V. Dvorkin, F. Fioretto, P. Van Hentenryck, P. Pinson, and J. Kazempour, "Differentially Private Optimal Power Flow for Distribution Grids," *IEEE Trans. Power Syst.*, 2020.
- [16] T. W. Mak, F. Fioretto, L. Shi, and P. Van Hentenryck, "Privacy-Preserving Power System Obfuscation: A Bilevel Optimization Approach," *IEEE Trans. Power Syst.*, vol. 35, no. 2, pp. 1627–1637, 2019.
- [17] Y. Lu and M. Zhu, "Privacy Preserving Distributed Optimization using Homomorphic Encryption," *Automatica*, vol. 96, pp. 314–325, 2018.
- [18] C. Zhang and Y. Wang, "Enabling Privacy-Preservation in Decentralized Optimization," *IEEE Trans. Control Netw. Syst.*, vol. 6, no. 2, pp. 679–689, 2018.
- [19] C. Zhang, M. Ahmad, and Y. Wang, "ADMM based Privacy-Preserving Decentralized Optimization," *IEEE Trans. Inf. Forensics Security*, vol. 14, no. 3, pp. 565–580, 2018.
- [20] J. Yu, Y. Weng, and R. Rajagopal, "Patopa: A data-driven parameter and topology joint estimation framework in distribution grids," *IEEE Trans. Smart Grid*, vol. 33, no. 4, pp. 4335–4347, 2017.
- [21] X. Liu and Z. Li, "False Data Attacks against AC State Estimation with Incomplete Network Information," *IEEE Trans. Smart Grid*, vol. 8, no. 5, pp. 2239–2248, 2016.
- [22] P. Paillier, "Public-key Cryptosystems based on Composite Degree Residuosity Classes," in *International conference on the theory and applications of cryptographic techniques*. Springer, 1999, pp. 223–238.
- [23] S. H. Low, "Convex Relaxation of Optimal Power Flow—Part II: Exactness," *IEEE Trans. Control Netw. Syst.*, vol. 1, no. 2, pp. 177–189, 2014.
- [24] R. Grone, C. R. Johnson, E. M. Sá, and H. Wolkowicz, "Positive Definite Completions of Partial Hermitian Matrices," *Linear Algebra and its Applications*, vol. 58, pp. 109–124, 1984.
- [25] S. Boyd, S. P. Boyd, and L. Vandenberghe, *Convex optimization*. Cambridge university press, 2004.
- [26] X. Bai, H. Wei, K. Fujisawa, and Y. Wang, "Semidefinite Programming for Optimal Power Flow Problems," *International Journal of Electrical Power & Energy Systems*, vol. 30, no. 6-7, pp. 383–392, 2008.
- [27] S. Mao, Y. Tang, Z. Dong, K. Meng, Z. Y. Dong, and F. Qian, "A privacy preserving distributed optimization algorithm for economic dispatch over time-varying directed networks," *IEEE Transactions on Industrial Informatics*, vol. 17, no. 3, pp. 1689–1701, 2021.
- [28] A. Ruszczyński, *Nonlinear optimization*. Princeton university press, 2011.