

A COMBINATORIAL SCHUR EXPANSION OF TRIANGLE-FREE HORIZONTAL-STRIP LLT POLYNOMIALS

FOSTER TOM

ABSTRACT. In recent years, Alexandersson and others proved combinatorial formulas for the Schur function expansion of the horizontal-strip LLT polynomial $G_{\lambda}(\mathbf{x}; q)$ in some special cases. We associate a weighted graph Π to λ and we use it to express a linear relation among LLT polynomials. We apply this relation to prove an explicit combinatorial Schur-positive expansion of $G_{\lambda}(\mathbf{x}; q)$ whenever Π is triangle-free. We also prove that the largest power of q in the LLT polynomial is the total edge weight of our graph.

1. INTRODUCTION

LLT polynomials are remarkable symmetric functions with many connections in algebraic combinatorics. Lascoux, Leclerc, and Thibon [11] originally defined LLT polynomials in terms of ribbon tableaux in order to study Fock space representations of the quantum affine algebra. Haglund, Haiman, Loehr, Remmel, and Ulyanov [9] redefined them in terms of tuples of skew shapes in their study of diagonal coinvariants. Haglund, Haiman, and Loehr [8] found a combinatorial formula for Macdonald polynomials, which implies a positive expansion in terms of these LLT polynomials $G_{\lambda}(\mathbf{x}; q)$. LLT polynomials are also closely connected to chromatic quasisymmetric functions and to the Frobenius series of the space of diagonal harmonics [4]. Grojnowski and Haiman [7] proved that LLT polynomials, and therefore Macdonald polynomials, are Schur-positive using Kazhdan–Lusztig theory, but it remains a major open problem to find an explicit combinatorial Schur-positive expansion. We give a brief account of some recent results in this direction.

In the unicellular case, meaning that every skew shape of λ consists of a single cell, we can associate a unit interval graph to λ . Huh, Nam, and Yoo [10] found an explicit Schur-positive expansion whenever this graph is a melting lollipop, namely

$$(1.1) \quad G_{\lambda}(\mathbf{x}; q) = \sum_{T \in \text{SYT}_n} q^{\text{wt}_{\mathbf{a}}(T)} s_{\text{shape}(T)}.$$

2010 *Mathematics Subject Classification.* Primary 05E05; Secondary 05E10, 05C15.

Key words and phrases. charge, chromatic symmetric function, cocharge, Hall–Littlewood polynomial, jeu de taquin, LLT polynomial, interval graph, Schur function, Schur-positive, symmetric function.

The author was supported in part by the National Sciences and Engineering Research Council of Canada.

Moreover, they proved that for arbitrary unit interval graphs, this formula gives the correct coefficient of s_μ whenever the partition μ is a hook.

More generally, we focus on the horizontal-strip case, meaning that every skew shape of λ is a row. Grojnowski and Haiman [7] showed that if the rows of λ are nested, then $G_\lambda(\mathbf{x}; q)$ is a transformed modified Hall–Littlewood polynomial and so its Schur expansion is given by the celebrated Lascoux–Schützenberger cocharge formula [13], namely

$$(1.2) \quad G_\lambda(\mathbf{x}; q) = \tilde{H}_\lambda(\mathbf{x}; q) = \sum_{T \in \text{SSYT}(\lambda)} q^{\text{cocharge}(T)} s_{\text{shape}(T)}.$$

Alexandersson and Uhlin [3] found a generalization of cocharge to prove an analogous formula when the rows of λ come from a skew shape σ/τ with no column having more than two cells. They formulated it for vertical-strips but we can equivalently state it as

$$(1.3) \quad G_\lambda(\mathbf{x}; q) = \sum_{T \in \text{SSYT}(\alpha)} q^{\text{cocharge}_\tau(T)} s_{\text{shape}(T)}.$$

D’Adderio [5] used recurrences in terms of Schröder paths to prove that the shifted vertical-strip LLT polynomial $G_\lambda(\mathbf{x}; q+1)$ is a positive linear combination of elementary symmetric functions. Alexandersson conjectured [1] and then proved with Sulzgruber [2] the explicit combinatorial formula

$$(1.4) \quad G_\lambda(\mathbf{x}; q+1) = \sum_{\theta \in \mathcal{O}(P)} q^{\text{asc}(\theta)} e_{\lambda(\theta)}$$

in terms of acyclic orientations of a decorated unit interval graph associated to λ .

In this paper, we define a *weighted graph* Π associated to λ . In Section 3, we use our weighted graph to express linear recurrences of horizontal-strip LLT polynomials. We further generalize cocharge and apply our recurrences in Section 4 to prove the explicit combinatorial Schur-positive formula

$$(1.5) \quad G_\lambda(\mathbf{x}; q) = \sum_{T \in \text{SSYT}(\alpha)} q^{\text{cocharge}_\Pi(T)} s_{\text{shape}(T)}$$

whenever the weighted graph Π is triangle-free. We also prove that the largest power of q in the LLT polynomial $G_\lambda(\mathbf{x}; q)$ is the total edge weight of Π .

2. BACKGROUND

A *partition* σ is a finite sequence of nonincreasing positive integers $\sigma = \sigma_1 \cdots \sigma_\ell$. By convention, we set $\sigma_i = 0$ if $i > \ell$. A *skew diagram* λ is a subset of $\mathbb{Z} \times \mathbb{Z}$ of the form

$$(2.1) \quad \lambda = \sigma/\tau = \{(i, j) : i \geq 1, \tau_i + 1 \leq j \leq \sigma_i\}$$

for some partitions σ and τ with $\sigma_i \geq \tau_i$ for every i . When τ is empty, we write σ instead of σ/\emptyset . The elements of λ are called *cells* and the *content* of a cell $u = (i, j) \in \lambda$ is the integer $c(u) = j - i$. We will focus heavily on *rows*, which are skew diagrams of the form

$$(2.2) \quad R = a/b = \{(1, j) : b + 1 \leq j \leq a\}$$

for some $a \geq b \geq 0$. We denote by $c(R) = \{b, b + 1, \dots, a - 1\}$ the set of contents of cells in R and by $\ell(R) = b$ and $r(R) = a - 1$ the smallest and largest contents of $c(R)$ respectively. A *semistandard Young tableau (SSYT)* of shape λ is a function $T : \lambda \rightarrow \{1, 2, 3, \dots\}$ that satisfies

$$(2.3) \quad T_{i,j} \leq T_{i,j+1} \text{ and } T_{i,j} < T_{i+1,j},$$

where we write $T_{i,j}$ to mean $T((i, j))$. The *weight* of T is the sequence $w(T) = (w_1, w_2, \dots)$, where $w_i = |T^{-1}(i)|$ is the number of times the integer i appears. We denote by SSYT_λ the set of SSYT of shape λ and by $\text{SSYT}(\alpha)$ the set of SSYT of weight α . We define the *skew Schur function* of shape $\lambda = \sigma/\tau$ to be

$$(2.4) \quad s_\lambda = \sum_{T \in \text{SSYT}_\lambda} \mathbf{x}^T,$$

where \mathbf{x}^T is the monomial $x_1^{w_1} x_2^{w_2} \dots$. When τ is empty, we call s_λ a *Schur function*.

A *multiskew partition* is a finite sequence of skew diagrams $\boldsymbol{\lambda} = (\lambda^{(1)}, \dots, \lambda^{(n)})$. If each $\lambda^{(i)}$ is a row, then we call $\boldsymbol{\lambda}$ a *horizontal-strip*. We denote by

$$(2.5) \quad \text{SSYT}_\boldsymbol{\lambda} = \{\mathbf{T} = (T^{(1)}, \dots, T^{(n)}) : T^{(i)} \in \text{SSYT}_{\lambda^{(i)}}\}$$

the set of *semistandard multiskew tableaux* of shape $\boldsymbol{\lambda}$. Cells $u \in \lambda^{(i)}$ and $v \in \lambda^{(j)}$ with $i < j$ *attack* each other if $c(u) = c(v)$ or $c(u) = c(v) + 1$. The skew shapes $\lambda^{(i)}$ and $\lambda^{(j)}$ *attack* each other if some cells $u \in \lambda^{(i)}$ and $v \in \lambda^{(j)}$ attack each other. Entries $T^{(i)}(u)$ and $T^{(j)}(v)$ with $i < j$ form an *inversion* if either

- $c(u) = c(v)$ and $T^{(i)}(u) > T^{(j)}(v)$, or
- $c(u) = c(v) + 1$ and $T^{(j)}(v) > T^{(i)}(u)$.

We denote by $\text{inv}(\mathbf{T})$ the number of inversions of \mathbf{T} . Now we define the *LLT polynomial*

$$(2.6) \quad G_\boldsymbol{\lambda}(\mathbf{x}; q) = \sum_{\mathbf{T} \in \text{SSYT}_\boldsymbol{\lambda}} q^{\text{inv}(\mathbf{T})} \mathbf{x}^{\mathbf{T}}.$$

Example 2.1. Let $\boldsymbol{\lambda} = (4/0, 5/2, 2/0)$. When $\boldsymbol{\lambda}$ is a horizontal-strip we draw it so that cells of the same content are aligned vertically as on the left. We have written the content in each cell using our convention that content increases from left to right. We have also drawn two

tableaux $\mathbf{T}, \mathbf{U} \in \text{SSYT}_\lambda$ with dotted red lines indicating the inversions.

$$\lambda = \begin{array}{c} \boxed{0 \mid 1} \\ \boxed{2 \mid 3 \mid 4} \\ \boxed{0 \mid 1 \mid 2 \mid 3} \end{array} \quad \mathbf{T} = \begin{array}{c} \boxed{2 \mid 2} \\ \boxed{1 \mid 1 \mid 1} \\ \boxed{3 \mid 3 \mid 3 \mid 3} \end{array} \quad \mathbf{U} = \begin{array}{c} \boxed{2 \mid 3} \\ \boxed{3 \mid 3 \mid 4} \\ \boxed{1 \mid 1 \mid 2 \mid 4} \end{array}$$

The tableau \mathbf{T} contributes $q^5 x_1^3 x_2^2 x_3^4$ to (2.6) and the tableau \mathbf{U} contributes $q^3 x_1^2 x_2^2 x_3^3 x_4^2$. We can expand the LLT polynomial $G_\lambda(\mathbf{x}; q)$ in the basis of Schur functions as

$$(2.7) \quad G_\lambda(\mathbf{x}; q) = q^5 s_{432} + q^5 s_{441} + q^5 s_{522} + (q^5 + q^4) s_{531} + 2q^4 s_{54} + 2q^4 s_{621} \\ + (q^4 + 2q^3) s_{63} + q^3 s_{711} + (2q^3 + q^2) s_{72} + (q^2 + q) s_{81} + s_9.$$

We cite some helpful properties of LLT polynomials. The first three are immediate from the definition.

Proposition 2.2. Let $\lambda = (\lambda^{(1)}, \dots, \lambda^{(n)})$ be a multiskew partition.

- (1) When $q = 1$ the LLT polynomial $G_\lambda(\mathbf{x}; 1)$ is a product of Schur functions $\prod_{i=1}^n s_{\lambda^{(i)}}$.
- (2) Suppose that λ can be partitioned into two subsequences of skew partitions $\mu = (\mu^{(i_1)}, \dots, \mu^{(i_r)})$ and $\nu = (\nu^{(j_1)}, \dots, \nu^{(j_{r'})})$ such that no $\mu^{(i_i)}$ attacks any $\nu^{(j_{i'})}$. Then $G_\lambda(\mathbf{x}; q) = G_\mu(\mathbf{x}; q) G_\nu(\mathbf{x}; q)$.
- (3) Let $\kappa(\lambda) = (\lambda^{(n)+}, \lambda^{(1)}, \dots, \lambda^{(n-1)})$, where $\lambda^{(n)+} = \{(i, j+1) : (i, j) \in \lambda^{(n)}\}$. Then $G_{\kappa(\lambda)}(\mathbf{x}; q) = G_\lambda(\mathbf{x}; q)$.
- (4) [11, Theorem 6.1] The LLT polynomial $G_\lambda(\mathbf{x}; q)$ is a symmetric function.
- (5) [8, Lemma 10.1] Let ω denote the standard involution on the algebra of symmetric functions. Denote by $\omega(\lambda)$ the multiskew partition where each skew shape of λ is conjugated and the tuple is reversed. Then

$$(2.8) \quad G_{\omega(\lambda)}(\mathbf{x}; q) = q^{I(\lambda)} \omega G_\lambda(\mathbf{x}; q^{-1}),$$

where $I(\lambda)$ is the number of attacking pairs of cells in λ . In particular, results about horizontal-strip and vertical-strip LLT polynomials are equivalent. In this paper, we choose to consider horizontal-strips.

In Example 2.1, we saw that $G_{(4/0, 5/2, 2/0)}(\mathbf{x}; q)$ is *Schur-positive*, meaning that it is an $\mathbb{N}[q]$ -linear combination of Schur functions. In fact, this property holds in general.

Theorem 2.3. [7, Corollary 6.9] For any multiskew partition λ , the LLT polynomial $G_\lambda(\mathbf{x}; q)$ is Schur-positive.

The special case where λ is a horizontal-strip was proven in [9, Theorem 3.1.3] using some results introduced in [14]. Both this special case and Theorem 2.3 were proven using Kazhdan–Lusztig theory. It is a major open problem to find an explicit combinatorial Schur-positive expansion of LLT polynomials. We conclude this section with a discussion of a successful solution in a special case. We first introduce the jeu de taquin algorithm.

Definition 2.4. Let $\lambda = \sigma/\tau$ be a skew shape and $T \in \text{SSYT}_\lambda$. An *inside corner* of λ is a cell $u \in \tau$ such that $\lambda \cup \{u\}$ is a skew shape. The *jeu de taquin slide* of T into an inside corner u is obtained as follows. There is a cell v directly above or directly right of u . If both, let v be the one with a smaller entry, and if they have the same entry, let v be the cell above u . We move the entry in v to u . We continue by considering the cells directly above and directly to the right of v and we stop when we vacate a cell on the outer boundary of λ , so that the result is a skew tableau. The *rectification* of T is the tableau obtained by successive jeu de taquin slides until the result is of partition shape.

Theorem 2.5. [16, Theorem A1.2.4] The rectification of T does not depend on the sequence of choices of inside corners into which the jeu de taquin slides are performed.

The following definition of cocharge is not the classical one but it is an equivalent characterization and it has the advantage that the weight of T is not required to be a partition.

Definition 2.6. Let $T \in \text{SSYT}_\lambda$. The *cocharge* of T is the integer defined by the following three properties.

- (1) Cocharge is invariant under jeu de taquin slides.
- (2) If T is a single row, then $\text{cocharge}(T) = 0$.
- (3) Suppose that the shape of T is disconnected so that $T = X \cup Y$ with every entry of X above and left of every entry of Y . Let i be the smallest entry of T and suppose that no entry of X is equal to i . Let S be a tableau obtained by swapping X and Y so that every entry of Y is above and left of every entry of X . Then $\text{cocharge}(T) = \text{cocharge}(S) + |X|$.

The classical definition of cocharge satisfies these three properties [12, Lemma 6.6.6]. Conversely, these properties suffice to calculate $\text{cocharge}(T)$ by using the following process called *catabolism*, which was introduced in [12, Problem 6.6.1]. If T is a single row, then $\text{cocharge}(T) = 0$, otherwise by applying jeu de taquin slides, we can slide the top row of T to the left to disconnect it, swap the pieces, and rectify to produce a new tableau S of smaller cocharge. Repeated catabolism will terminate with a single row of cocharge zero.

Example 2.7. Given the tableau T below left, repeated catabolism produces the following sequence of tableaux and $\text{cocharge}(T) = 1 + 2 + 1 = 4$.

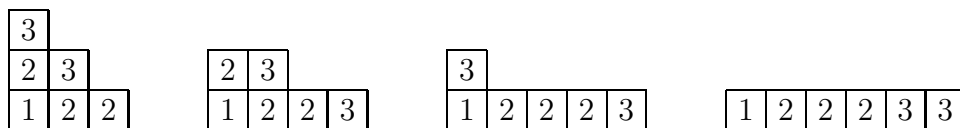

Example 2.8. If T is a tableau of partition shape and every entry equal to i or j with $i < j$, then T must be of the form

$$T = \begin{array}{|c|c|c|c|c|} \hline j & \cdot & \cdot & \cdot & j \\ \hline i & \cdot & \cdot & \cdot & i \\ \hline \end{array} i \cdot \cdot \cdot i j \cdot \cdot \cdot j$$

and a single catabolism will produce a tableau with one row, so the cocharge of T is the number of entries in the second row. We can think of $\text{cocharge}(T)$ as measuring the extent to which there are entries above others.

We now present a case in which a combinatorial formula for the Schur-positivity of a horizontal-strip LLT polynomial is known.

Theorem 2.9. [7, Theorem 7.15] Let $\lambda = (R_1, \dots, R_n)$ be a horizontal-strip such that $\ell(R_1) \leq \dots \leq \ell(R_n)$ and $r(R_1) \geq \dots \geq r(R_n)$ and let $\lambda_i = |R_i|$. Then the LLT polynomial $G_\lambda(\mathbf{x}; q)$ is a transformed modified Hall–Littlewood polynomial, whose Schur expansion is known [13] to be

$$(2.9) \quad G_\lambda(\mathbf{x}; q) = \tilde{H}_\lambda(\mathbf{x}; q) = \sum_{T \in \text{SSYT}(\lambda)} q^{\text{cocharge}(T)} s_{\text{shape}(T)}.$$

The central problem of this paper is to generalize cocharge in order to prove an analogous combinatorial formula for the Schur expansion of any horizontal-strip LLT polynomial. Our main result, Theorem 4.6, is such a combinatorial formula in the case where no three rows of λ pairwise attack each other. Our strategy is to define a weighted graph $\Pi(\lambda)$ associated to λ and to use it to express linear recurrences of LLT polynomials.

3. A WEIGHTED GRAPH DESCRIPTION OF HORIZONTAL-STRIP LLT POLYNOMIALS

We begin by defining our weighted graph $\Pi(\lambda)$.

Definition 3.1. Let R and R' be rows. We define the integer

$$(3.1) \quad M(R, R') = \begin{cases} |c(R) \cap c(R')| & \text{if } \ell(R) \leq \ell(R'), \\ |c(R) \cap c(R'^+)| & \text{if } \ell(R) > \ell(R'), \end{cases}$$

where as before, $R'^+ = \{(1, j+1) : (1, j) \in R'\}$. Note that $0 \leq M(R, R') \leq \min\{|R|, |R'|\}$.

Definition 3.2. Let $\lambda = (R_1, \dots, R_n)$ be a horizontal-strip. Consider the cells of λ that are the rightmost cells in their row and label these cells $1, \dots, n$ in *content reading order*, meaning in order of increasing content and from bottom to top along constant content lines. We define the *weighted graph* $\Pi(\lambda)$ with vertices v_1, \dots, v_n as follows. The weight of a vertex v_i , denoted $|v_i|$, is the size of the row $R_{i'}$ whose rightmost cell is labelled i . Vertices v_i and v_j corresponding to rows $R_{i'}$ and $R_{j'}$ with $i' < j'$ are joined by an edge if $R_{i'}$ and $R_{j'}$ attack each other and the weight of the edge (v_i, v_j) , denoted $M_{i,j}$, is given by $M(R_{i'}, R_{j'})$.

Example 3.3. Let $\lambda = (R_1, R_2, R_3) = (4/0, 5/2, 2/0)$ as in Example 2.1. We have drawn λ with the rightmost cells in each row labelled in content reading order, and we have drawn $\Pi(\lambda)$ below right. We have $M(R_1, R_2) = 2$, $M(R_1, R_3) = 2$, and $M(R_2, R_3) = 1$.

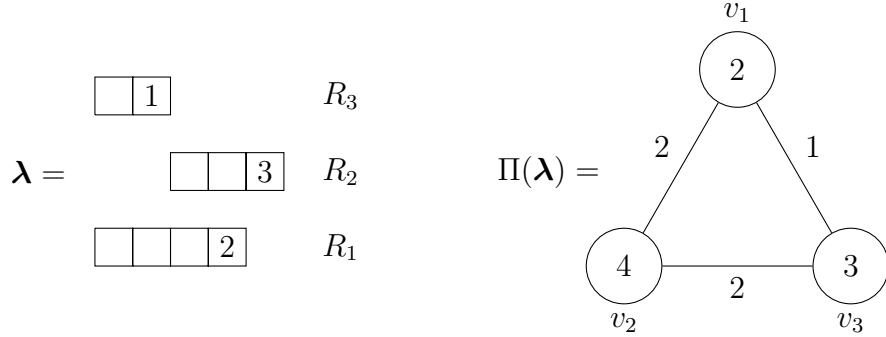

Remark 3.4. It follows immediately from the definition that $M(R, R') = M(R'^+, R)$ and therefore the map κ from Proposition 2.2, Part 3 preserves our weighted graph. We can think of the integers $M(R_i, R_j)$ as measuring the extent to which the rows R_i and R_j attack each other. We now present a result to make this idea precise.

Theorem 3.5. Let $\lambda = (\lambda^{(1)}, \dots, \lambda^{(n)})$ be a multiskew partition. Define the integer

$$(3.2) \quad M(\lambda) = \sum_{1 \leq i < j \leq n} \sum_{\substack{R \text{ a row of } \lambda^{(i)} \\ R' \text{ a row of } \lambda^{(j)}}} M(R, R').$$

Then every $\mathbf{T} \in \text{SSYT}_\lambda$ has $\text{inv}(\mathbf{T}) \leq M(\lambda)$. Moreover, this maximum is attained.

Remark 3.6. Theorem 3.5 tells us that $M(\lambda)$ is the largest power of q in the LLT polynomial $G_\lambda(\mathbf{x}; q)$. In particular, if $G_\lambda(\mathbf{x}; q) = G_\mu(\mathbf{x}; q)$, then $M(\lambda) = M(\mu)$. We also remark that by Proposition 2.2, Part 5, the smallest power of q is $I(\lambda) - M(\omega(\lambda))$. If λ is a horizontal-strip, the largest power of q in the LLT polynomial is the total edge weight of $\Pi(\lambda)$. In the Hall–Littlewood case of Theorem 2.9, we have $M(\lambda) = n(\lambda) = \sum_i (i - 1)\lambda_i$.

Proof. We first observe that an entry $x \in \mathbf{T}$ makes at most one inversion with the entries in each row. If x made an inversion with $y \in \mathbf{T}$ and $z \in \mathbf{T}$ in the same row with y to the left of z , then we would require $y > x > z$, but $y \leq z$ because the rows of \mathbf{T} are weakly increasing.

To prove the first statement, we show that for rows R of $\lambda^{(i)}$ and R' of $\lambda^{(j)}$ with $i < j$, the number of inversions $\text{inv}_{R,R'}(\mathbf{T})$ of \mathbf{T} between cells in these rows is at most $M(R, R')$. Suppose that $\ell(R) \leq \ell(R')$ and let v_1 be the leftmost cell of row R' . If there is no cell u_1 of R with $c(u_1) = c(v_1)$, then $\text{inv}_{R,R'}(\mathbf{T}) = 0$, so suppose otherwise. Let v_2, \dots, v_m be the cells in R' to the right of v_1 and let $u_2, \dots, u_{m'}$ be the cells in R to the right of u_1 as pictured below left. By our observation above, we have $\text{inv}_{R,R'}(\mathbf{T}) \leq \min\{m, m'\} = M(R, R')$. Similarly, if $\ell(R) > \ell(R')$, let u_1 be the leftmost cell of row R . If there is no cell v_1 of R' with $c(v_1) = c(u_1) - 1$, then $\text{inv}_{R,R'}(\mathbf{T}) = 0$, so suppose otherwise. Let v_2, \dots, v_m be the cells in R' to the right of v_1 and let $u_2, \dots, u_{m'}$ be the cells in R to the right of u_1 as pictured below right. Again, by our observation above, we have $\text{inv}_{R,R'}(\mathbf{T}) \leq \min\{m, m'\} = M(R, R')$.

$$\begin{array}{cccccccccc}
\boxed{v_1} & \boxed{v_2} & \boxed{\cdot} & \boxed{\cdot} & \boxed{\cdot} & \boxed{\cdot} & \boxed{\cdot} & \boxed{\cdot} & \boxed{\cdot} & \boxed{v_m} \\
\boxed{\cdot} & \boxed{\cdot} & \boxed{\cdot} & \boxed{v_1} & \boxed{v_2} & \boxed{\cdot} & \boxed{\cdot} & \boxed{\cdot} & \boxed{\cdot} & \boxed{v_m} \\
\boxed{\cdot} & \boxed{\cdot} & \boxed{\cdot} & \boxed{u_1} & \boxed{u_2} & \boxed{\cdot} & \boxed{\cdot} & \boxed{\cdot} & \boxed{\cdot} & \boxed{u_m} \\
\boxed{u_1} & \boxed{u_2} & \boxed{\cdot} & \boxed{\cdot} & \boxed{\cdot} & \boxed{\cdot} & \boxed{\cdot} & \boxed{\cdot} & \boxed{\cdot} & \boxed{u_m}
\end{array}$$

To prove the second statement, we construct a tableau $\mathbf{T} \in \text{SSYT}_\lambda$ with $\text{inv}(\mathbf{T}) = M(\lambda)$. Consider the cells of λ that are the leftmost cells in their row. We label these cells $1, 2, 3, \dots$ in reverse content reading order, meaning in order of decreasing content and from top to bottom along constant content lines. We then fill each cell with the label of the leftmost cell in its row. As an illustration, when $\lambda = (4/0, 5/2, 2/0)$, the tableau we have constructed is the tableau \mathbf{T} in Example 2.1.

By construction, the rows of \mathbf{T} are constant and therefore weakly increasing, and if a cell u is directly below a cell v in the same skew diagram, then the leftmost cell in the row of u must precede that of v in reverse content reading order, so $\mathbf{T}(u) < \mathbf{T}(v)$ and indeed $\mathbf{T} \in \text{SSYT}_\lambda$. Finally, we show that for rows R of $\lambda^{(i)}$ and R' of $\lambda^{(j)}$ with $i < j$, we have $\text{inv}_{R,R'}(\mathbf{T}) = M(R, R')$. If $\ell(R) \leq \ell(R')$, then every cell in R has a strictly larger entry than every cell in R' , so we have an inversion $\mathbf{T}(u) > \mathbf{T}(v)$ for every $u \in R$ and $v \in R'$ with $c(u) = c(v)$, meaning $|c(R) \cap c(R')| = M(R, R')$ inversions in all. Similarly, if $\ell(R) > \ell(R')$, then every cell in R' has a strictly larger entry than every cell in R , so we have an inversion $\mathbf{T}(v) > \mathbf{T}(u)$ for every $u \in R$ and $v \in R'$ with $c(u) = c(v) + 1$, meaning $|c(R) \cap c(R'^+)| = M(R, R')$ inversions in all. \square

We continue to use the integers $M(R, R')$ to describe relationships between rows. The following definition will be justified by Lemma 3.15.

Definition 3.7. We say that two rows R and R' *commute* if $M(R, R') = M(R', R)$. We write $R \leftrightarrow R'$ if R and R' commute and $R \nleftrightarrow R'$ otherwise.

Proposition 3.8. Let R and R' be rows with $\ell(R) \leq \ell(R')$.

(1) If $r(R) < \ell(R') - 1$, then

$$(3.3) \quad M(R, R') = M(R', R) = 0, \text{ so } R \leftrightarrow R'.$$

(2) If $\ell(R') = \ell(R)$ or $r(R') \leq r(R)$, then

$$(3.4) \quad M(R, R') = M(R', R) = \min\{|R|, |R'|\}, \text{ so } R \leftrightarrow R'.$$

(3) Otherwise, we have $\ell(R) < \ell(R') \leq r(R) + 1 \leq r(R')$ and

$$(3.5) \quad M(R, R') = r(R) - \ell(R') + 1 \text{ and } M(R', R) = r(R) - \ell(R') + 2, \text{ so } R \nleftrightarrow R'.$$

In particular, if $R \leftrightarrow R'$, then $M(R, R')$ is either 0 or $\min\{|R|, |R'|\}$.

Proof. We compute directly from the definition. If $r(R) < \ell(R') - 1$, then $R \cap R' = R' \cap R^+ = \emptyset$. If $\ell(R') = \ell(R)$, then either $R \subseteq R'$ or $R' \subseteq R$, and if $\ell(R) < \ell(R')$ and $r(R') \leq r(R)$,

then $R' \subseteq R$ and $R' \subseteq R^+$. Otherwise, the only remaining case is when $\ell(R) \leq \ell(R') - 1 \leq r(R) \leq r(R') - 1$, in which case we have

$$(3.6) \quad M(R, R') = |c(R) \cap c(R')| = |\{\ell(R'), \dots, r(R)\}| = r(R) - \ell(R') + 1 \text{ and}$$

$$(3.7) \quad M(R', R) = |c(R') \cap c(R^+)| = |\{\ell(R'), \dots, r(R) + 1\}| = r(R) - \ell(R') + 2.$$

This completes the proof. □

Remark 3.9. For a more visual description, we have that two rows R and R' commute if and only if they are disjoint and separated by at least one cell, or if one is contained in the other. In the examples below, only the pairs of rows on the left and on the right commute.

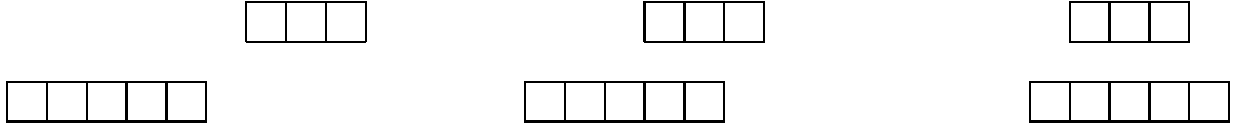

We now introduce the language of LLT-equivalence to describe some local linear relations of LLT polynomials. If $\lambda = (\lambda^{(1)}, \dots, \lambda^{(n)})$ and $\mu = (\mu^{(1)}, \dots, \mu^{(n')})$ are multiskew partitions, then we denote by $\lambda \cdot \mu$ the concatenation $(\lambda^{(1)}, \dots, \lambda^{(n)}, \mu^{(1)}, \dots, \mu^{(n')})$.

Definition 3.10. Multiskew partitions λ and μ are *LLT-equivalent*, denoted $\lambda \cong \mu$, if for every multiskew partition ν we have the equality of LLT polynomials

$$(3.8) \quad G_{\lambda \cdot \nu}(\mathbf{x}; q) = G_{\mu \cdot \nu}(\mathbf{x}; q).$$

More generally, finite formal $\mathbb{Q}(q)$ -combinations of multiskew partitions $\sum_i a_i(q) \lambda_i$ and $\sum_j b_j(q) \mu_j$ are *LLT-equivalent*, denoted $\sum_i a_i(q) \lambda_i \cong \sum_j b_j(q) \mu_j$, if for every ν we have

$$(3.9) \quad \sum_i a_i(q) G_{\lambda_i \cdot \nu}(\mathbf{x}; q) = \sum_j b_j(q) G_{\mu_j \cdot \nu}(\mathbf{x}; q).$$

Remark 3.11. By repeatedly applying the map κ from Proposition 2.2, Part 3, we have that if $\lambda \cong \mu$, then $G_{\nu \cdot \lambda \cdot \nu'}(\mathbf{x}; q) = G_{\nu \cdot \mu \cdot \nu'}(\mathbf{x}; q)$ for every multiskew partitions ν and ν' . We can think of LLT-equivalence as a *local* linear relation because we can locally replace λ with μ while preserving the LLT polynomial.

We can prove an LLT-equivalence by rearranging to an LLT-equivalence of $\mathbb{N}[q]$ -linear combinations of multiskew partitions and finding an appropriate bijection of tableaux.

Theorem 3.12. [15, Theorem 2.2.1] Let $\sum_i q^{a_i} \lambda_i$ and $\sum_j q^{b_j} \mu_j$ be $\mathbb{N}[q]$ -linear combinations of multiskew partitions. Then they are LLT-equivalent if there exists a bijection

$$(3.10) \quad f : \bigsqcup_i \text{SSYT}_{\lambda_i} \rightarrow \bigsqcup_j \text{SSYT}_{\mu_j}$$

such that if f maps $\mathbf{T} \in \text{SSYT}_{\lambda_i}$ to $\mathbf{U} \in \text{SSYT}_{\mu_j}$, then

$$(3.11) \quad \text{inv}(\mathbf{T}) + a_i = \text{inv}(\mathbf{U}) + b_j,$$

and for every $c \in \mathbb{Z}$, the multiset of entries in cells of content c are preserved, that is

$$(3.12) \quad \{\mathbf{T}(u) : c(u) = c\} = \{\mathbf{U}(u) : c(u) = c\}.$$

We now use Theorem 3.12 to establish some valuable LLT-equivalence relations. These relations appear in [5, Lemma 5.2] and [2, Theorem 2.1] in terms of operators on Dyck paths and Schröder paths.

Lemma 3.13. Let R and R' be rows such that $\ell(R') = r(R) + 1$. We have the LLT-equivalence

$$(3.13) \quad q(R, R') + (R \cup R') \cong q(R \cup R') + (R', R).$$

Proof. By Theorem 3.12, it suffices to find an appropriate bijection

$$(3.14) \quad f : \text{SSYT}_{(R, R')} \sqcup \text{SSYT}_{(R \cup R')} \rightarrow \text{SSYT}_{(R \cup R')} \sqcup \text{SSYT}_{(R', R)}.$$

For a tableau $\mathbf{T} \in \text{SSYT}_{(R, R')}$, let x and y denote the entries in the cells of content $r(R)$ and $\ell(R')$ respectively. We partition

$$(3.15) \quad \text{SSYT}_{(R, R')} = \text{SSYT}_{(R, R')}^{\leq} \sqcup \text{SSYT}_{(R, R')}^{>}$$

depending on whether $x \leq y$ or $x > y$, and we similarly partition $\text{SSYT}_{(R', R)}$. We will now assemble our bijection f as the union of the unique bijections

$$(3.16) \quad f_1 : \text{SSYT}_{(R, R')}^{>} \rightarrow \text{SSYT}_{(R', R)}^{>},$$

$$(3.17) \quad f_2 : \text{SSYT}_{(R, R')}^{\leq} \rightarrow \text{SSYT}_{(R \cup R')}, \text{ and}$$

$$(3.18) \quad f_3 : \text{SSYT}_{(R \cup R')} \rightarrow \text{SSYT}_{(R', R)}^{\leq}$$

satisfying (3.12). By definition, every $\mathbf{T} \in \text{SSYT}_{(R', R)}^{>}$ has the unique inversion (y, z) , while all of the other tableaux have zero inversions, so our aggregate function f satisfies (3.11). \square

Example 3.14. These bijections are illustrated in an example below. We have written q 's to indicate how the numbers of inversions are supposed to change.

$$f_1 : \quad q \quad \begin{array}{|c|c|} \hline y & z \\ \hline \end{array} \quad \mapsto \quad \begin{array}{|c|c|} \hline w & x \\ \hline \end{array} \quad (x > y)$$

$$\begin{array}{|c|c|} \hline w & x \\ \hline \end{array} \quad \begin{array}{|c|c|} \hline y & z \\ \hline \end{array}$$

$$f_2 : \quad q \quad \begin{array}{|c|c|} \hline y & z \\ \hline \end{array} \quad \mapsto \quad q \begin{array}{|c|c|c|c|} \hline w & x & y & z \\ \hline \end{array} \quad (x \leq y)$$

$$\begin{array}{|c|c|} \hline w & x \\ \hline \end{array}$$

$$f_3 : \quad \begin{array}{|c|c|c|c|} \hline w & x & y & z \\ \hline \end{array} \quad \mapsto \quad \begin{array}{|c|c|} \hline y & z \\ \hline \end{array} \quad (x \leq y)$$

$$\begin{array}{|c|c|} \hline w & x \\ \hline \end{array}$$

Our next LLT-equivalence relation justifies the terminology of commuting rows.

Lemma 3.15. Let R and R' be rows such that $R \leftrightarrow R'$. We have the LLT-equivalence

$$(3.19) \quad (R, R') \cong (R', R).$$

Remark 3.16. Lemma 3.15 tells us that if $\lambda = (R_1, \dots, R_n)$ and $R_i \leftrightarrow R_{i+1}$, then we can switch rows R_i and R_{i+1} so that $G_\lambda(\mathbf{x}; q) = G_\mu(\mathbf{x}; q)$, where $\mu = (R_1, \dots, R_{i+1}, R_i, \dots, R_n)$. Also note that Theorem 3.5 implies that if $(R, R') \cong (R', R)$, then $R \leftrightarrow R'$.

Proof. By Theorem 3.12, it suffices to find an appropriate bijection

$$(3.20) \quad f : \text{SSYT}_{(R, R')} \rightarrow \text{SSYT}_{(R', R)}.$$

By Proposition 3.8, we have $M(R, R') = 0$ or $\min\{|R|, |R'|\}$. If $M(R, R') = 0$, then the unique bijection f satisfying (3.12) trivially satisfies (3.11), so suppose without loss of generality that $M(R, R') = |R'|$. Denote by u_c and v_c the cells in R and R' of content c . Let $\mathbf{T} \in \text{SSYT}_{(R, R')}$. First suppose that either $\mathbf{T}(v_i) < \mathbf{T}(u_{i-1})$ for all $i \in c(R')$ or $\mathbf{T}(v_j) > \mathbf{T}(u_{j+1})$ for all $j \in c(R')$, where by convention $\mathbf{T}(u_i) = 0$ if $i < \ell(R)$ and $\mathbf{T}(u_i) = \infty$ if $i > r(R)$. Define $\mathbf{U} = f(\mathbf{T}) \in \text{SSYT}_{(R', R)}$ by $\mathbf{U}(u_c) = \mathbf{T}(u_c)$ and $\mathbf{U}(v_c) = \mathbf{T}(v_c)$. Then f satisfies (3.11) because $\text{inv}(\mathbf{U}) = \text{inv}(\mathbf{T}) = |R'|$ and f satisfies (3.12), so we are done.

Now suppose otherwise and let $i \in c(R')$ be minimal with $\mathbf{T}(v_i) \geq \mathbf{T}(u_{i-1})$ and $j \in c(R')$ be maximal with $\mathbf{T}(v_j) \leq \mathbf{T}(u_{j+1})$. Define $\mathbf{U} = f(\mathbf{T}) \in \text{SSYT}_{(R', R)}$ by $\mathbf{U}(u_c) = \mathbf{T}(u_c)$ and $\mathbf{U}(v_c) = \mathbf{T}(v_c)$ if $c < i$ or $c > j$, and $\mathbf{U}(u_c) = \mathbf{T}(v_c)$ and $\mathbf{U}(v_c) = \mathbf{T}(u_c)$ if $i \leq c$ and $c \leq j$. An example is given below, where we have marked the entries of content i and j in red. Informally, the entries between the red ones are fixed and the entries outside are switched.

$$\mathbf{T} = \begin{array}{|c|c|c|c|c|c|c|c|} \hline 1 & 1 & 5 & 5 & 6 & 8 & 9 & \\ \hline \end{array} \quad \mapsto \quad \mathbf{U} = \begin{array}{|c|c|c|c|c|c|c|c|c|c|c|c|c|c|} \hline 1 & 2 & 3 & 3 & 4 & 5 & 5 & 6 & 7 & 7 & 8 & 8 & 9 & \\ \hline \end{array}$$

$$\begin{array}{|c|c|c|c|c|c|c|c|c|c|} \hline 1 & 2 & 3 & 3 & 4 & 4 & 6 & 7 & 7 & 7 & 8 & 8 & 9 & \\ \hline \end{array} \quad \begin{array}{|c|c|c|c|c|c|} \hline 1 & 1 & 4 & 6 & 7 & 8 & 9 & \\ \hline \end{array}$$

By construction, $\mathbf{U} \in \text{SSYT}_{(R', R)}$ and f satisfies (3.12). By minimality of i , \mathbf{T} has inversions $(\mathbf{T}(u_c), \mathbf{T}(v_c))$ for $\ell(R') \leq c < i$ and by maximality of j , \mathbf{T} has inversions $(\mathbf{T}(v_c), \mathbf{T}(u_{c+1}))$ for $j < c \leq r(R)$. Similarly, \mathbf{U} has inversions $(\mathbf{U}(u_{c-1}), \mathbf{U}(v_c))$ for $\ell(R') \leq c < i$ and $(\mathbf{U}(v_c), \mathbf{U}(u_c))$ for $j < c \leq r(R')$. The four pairs

$$(\mathbf{T}(v_{i-1}), \mathbf{T}(u_i)), (\mathbf{T}(v_j), \mathbf{T}(u_{j+1})), (\mathbf{U}(u_{i-1}), \mathbf{U}(v_i)), \text{ and } (\mathbf{U}(u_j), \mathbf{U}(v_{j+1}))$$

are not inversions, and otherwise if $i \leq c$ and $c \leq j$ the cells of content c are unchanged so any inversions are preserved. Therefore, f also satisfies (3.11). We can recover the contents i and j from \mathbf{U} by noting that $i \in c(R')$ is minimal with $\mathbf{U}(v_i) \geq \mathbf{U}(u_{i-1})$ and $j \in c(R')$ is maximal with $\mathbf{U}(v_j) \leq \mathbf{U}(u_{j+1})$, so f is invertible. \square

By combining Lemma 3.13 and Lemma 3.15, we obtain the following recurrence relation.

Lemma 3.17. Let R and R' be rows such that $R \leftrightarrow R'$ and $\ell(R') < \ell(R)$. We have the LLT-equivalence

$$(3.21) \quad (R, R') \cong q(R', R) + (1 - q)(R \cup R', R \cap R').$$

Proof. Note that by Proposition 3.8, we must have that $\ell(R') < \ell(R) \leq r(R') + 1 \leq r(R)$. Let $R_1 = R' \setminus R$ and $R_2 = R \cap R'$, so that $R' = R_1 \cup R_2$, $R \cup R_1 = R \cup R'$, and $R \leftrightarrow R_2$. Now by Lemma 3.13 and Lemma 3.15, we have

$$(3.22) \quad \begin{aligned} (R, R') &\cong \frac{q}{q-1}(R, R_1, R_2) - \frac{1}{q-1}(R, R_2, R_1) \\ &\cong \frac{q}{q-1}(q(R_1, R, R_2) + (1-q)(R_1 \cup R, R_2)) - \frac{1}{q-1}(R_2, R, R_1) \\ &\cong \frac{q^2}{q-1}(R_1, R_2, R) - q(R_1 \cup R, R_2) - \frac{1}{q-1}(q(R_2, R_1, R) + (1-q)(R_2, R_1 \cup R)) \\ &\cong \frac{q^2}{q-1}(R_1, R_2, R) - q(R_1 \cup R, R_2) - \frac{q}{q-1}(R_2, R_1, R) + (R_1 \cup R, R_2) \\ &\cong \frac{q^2}{q-1}(R_1, R_2, R) + (1-q)(R_1 \cup R, R_2) - \frac{q}{q-1}(q(R_1, R_2, R) + (1-q)(R', R)) \\ &= q(R', R) + (1-q)(R \cup R', R \cap R'). \end{aligned}$$

□

The following Proposition will help us visualize the relation (3.21).

Proposition 3.18. Let R_1 , R_2 , and R be rows such that $R_1 \leftrightarrow R_2$ and $\ell(R_2) < \ell(R_1)$ and let $M = M(R_1, R_2)$, $M_1 = M(R_1, R)$, and $M_2 = M(R_2, R)$. Then

$$(3.23) \quad M(R_1 \cap R_2, R) = \min\{M - 1, M_1, M_2\} \text{ and}$$

$$(3.24) \quad M(R_1 \cup R_2, R) = \min\{|R|, \max\{M_1, M_2, M_1 + M_2 - (M - 1)\}\}.$$

In particular, if $M_2 = 0$, then $M(R_1 \cap R_2, R) = 0$ and $M(R_1 \cup R_2, R) = M_1$.

Proof. Recall that by Proposition 3.8, we must have $\ell(R_1) - 1 \leq r(R_2)$. We now consider several cases. If $\ell(R) \geq \ell(R_1)$, then

$$(3.25) \quad M(R_1 \cap R_2, R) = M(R_2, R) = M_2 \leq M - 1 \leq M(R_1 \cup R_2, R) = M(R_1, R) = M_1.$$

Similarly, if $r(R) < r(R_2) - 1$, then

$$(3.26) \quad M(R_1 \cap R_2, R) = M(R_1, R) = M_1 \leq M - 1 \leq M(R_1 \cup R_2, R) = M(R_2, R) = M_2.$$

Now suppose that $\ell(R) \leq \ell(R_1) - 1 \leq r(R_2) \leq r(R)$, so that $R_1 \cap R_2 \subseteq R$ and $M(R_1 \cap R_2, R) = |R_1 \cap R_2| = M - 1 \leq M_1, M_2$. If $\ell(R) < \ell(R_2)$, then

$$(3.27) \quad M(R_1 \cup R_2, R) = |R_1 \cap R^+| + |R_2 \cap R^+| - |R_1 \cap R_2 \cap R^+| = M_1 + M_2 - (M - 1) \leq |R|.$$

Similarly, if $\ell(R) \geq \ell(R_2)$, then

$$(3.28) \quad M(R_1 \cup R_2, R) = |R_1 \cap R| + |R_2 \cap R| - |R_1 \cap R_2 \cap R| = |R_1 \cap R| + M_2 - (M - 1).$$

At this point, if $r(R) \geq r(R_1)$, then $|R_1 \cap R| = M_1$ and again

$$(3.29) \quad M(R_1 \cup R_2, R) = M_1 + M_2 - (M - 1) \leq |R|,$$

while if $r(R) < r(R_1)$, then $|R_1 \cap R| = M_1 - 1$ and $R \subseteq R_1 \cup R_2$, so

$$(3.30) \quad M(R_1 \cup R_2, R) = |R| = (M_1 - 1) + M_2 - (M - 1) < M_1 + M_2 - (M - 1).$$

□

Remark 3.19. We can now visualize the relation (3.21) as below, where $c = a + b - (M - 1)$, $N_1 = \min\{M - 1, M_1, M_2\}$, and $N_2 = \min\{x, \max\{M_1, M_2, M_1 + M_2 - (M - 1)\}\}$.

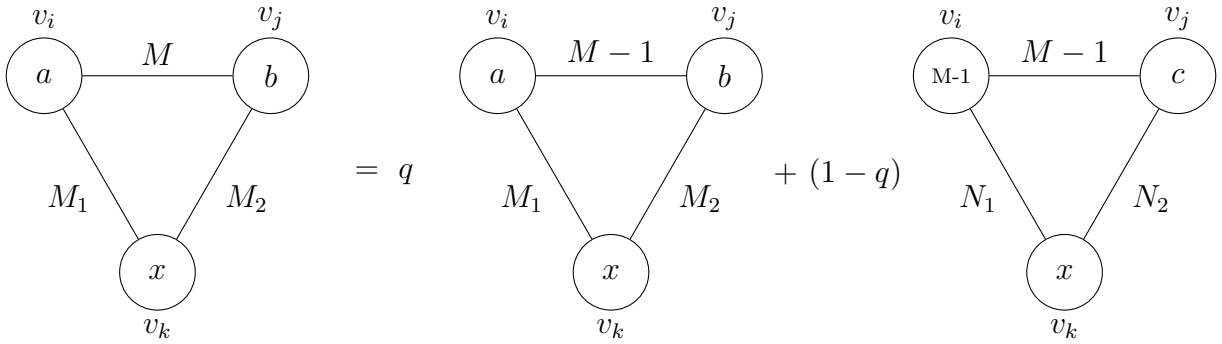

We conclude this section by characterizing the triangle-free weighted graphs $\Pi(\boldsymbol{\lambda})$ that can arise from a horizontal-strip $\boldsymbol{\lambda}$.

Definition 3.20. A graph G is a *caterpillar* if it is a tree and its vertices can be partitioned $V = P \sqcup L$ so that the induced subgraph $G[P]$ is a path and every $v \in L$ has degree one.

Proposition 3.21. Let $\boldsymbol{\lambda}$ be a horizontal-strip such that $\Pi = \Pi(\boldsymbol{\lambda})$ is triangle-free. Recall that for a vertex $v \in \Pi$, we denote by $|v|$ the size of the corresponding row of $\boldsymbol{\lambda}$.

- (1) If $i < j < k$ and v_i is adjacent to v_k , then $M_{j,k} = |v_j|$.
- (2) Every vertex v_i is adjacent to at most one vertex v_j for which $i < j$.
- (3) Every connected component of Π is a caterpillar $C = (P \sqcup L, E)$ and if $v_j \in L$ is adjacent to v_k , then $M_{j,k} = |v_j|$.
- (4) If v_i is adjacent to the vertices $\{v_{j_t}\}_{t=1}^r$, then

$$(3.31) \quad |v_i| + 1 \geq \sum_{t=1}^r M_{i,j_t}.$$

- (5) Let Π' be a graph whose vertices $\{v_1, \dots, v_n\}$ have positive integer weights $|v_i|$ and whose edges (v_i, v_j) have positive integer weights $M_{i,j} \leq \min\{|v_i|, |v_j|\}$. If Π' satisfies the above four conditions, then $\Pi' = \Pi(\boldsymbol{\mu})$ for some horizontal-strip $\boldsymbol{\mu}$.

Remark 3.22. In particular, Part 5 tells us that the property in Part 1 precisely characterizes the labellings of Π that can arise from a horizontal-strip.

Example 3.23. For the horizontal-strip λ below left, we have drawn the caterpillar $\Pi(\lambda)$ below right. We have $P = \{v_1, v_4, v_6\}$ and note that $8 + 1 \geq 3 + 2 + 2 + 2$ and $4 + 1 \geq 2 + 3$.

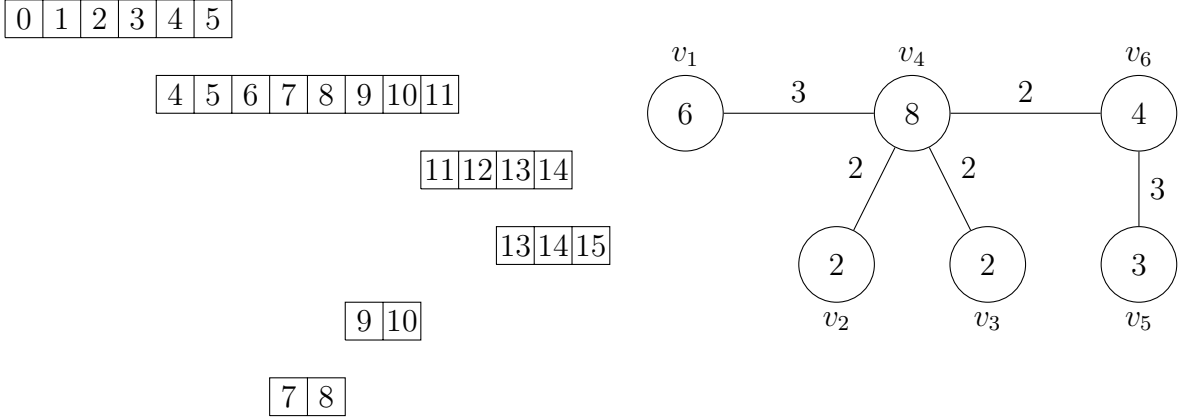

By Part 5, we could switch the labels of v_5 and v_6 and the resulting graph Π' would still be of the form $\Pi(\mu)$ for some horizontal-strip μ . In this case, we would have $P = \{v_1, v_4, v_5, v_6\}$. However, because of Part 1, we could not switch the labels of v_1 and v_2 .

Proof of Proposition 3.21. Let $\lambda = (R_1, \dots, R_n)$.

- (1) Let $R_{i'}$, $R_{j'}$, and $R_{k'}$ be the rows of λ corresponding to the vertices v_i , v_j , and v_k respectively. By Proposition 2.2, Part 3, we may assume without loss of generality that $i' = 1$. Because $i < j < k$, we have $r(R_{i'}) \leq r(R_{j'}) \leq r(R_{k'})$, and if v_i is adjacent to v_k , then $\ell(R_{k'}) \leq r(R_{i'})$, so $r(R_{j'}) \in c(R_{k'})$ and v_j is adjacent to v_k . Now using that Π is triangle-free, v_i is not adjacent to v_j , so $r(R_{i'}) < \ell(R_{j'})$, $R_{j'} \subseteq R_{k'}$, and $M_{j,k} = |v_j|$.
- (2) If v_i is adjacent to v_j and v_k with $i < j$ and $i < k$, then v_j and v_k are adjacent by Part 1, creating a triangle in Π .
- (3) We first note that Π must be acyclic because if the vertices $\{v_{i_t}\}_{t=1}^r$ with $i_1 < \dots < i_r$ form a cycle, then the vertex v_{i_1} is adjacent to two vertices v_{i_t} and $v_{i_{t'}}$ with $i_1 < i_t, i_{t'}$, contradicting Part 2. Therefore, the connected components of Π must be trees. Let $C = (V, E)$ be a connected component of Π and note that by Part 1, we must have $V = \{v_i : i_1 \leq i \leq i_r\}$ for some i_1, i_r . Because C is connected, there must be a path $P = (v_{i_1}, v_{i_2}, \dots, v_{i_{r-1}}, v_{i_r})$ and it follows from Part 2 that $i_1 < i_2 < \dots < i_{r-1} < i_r$. By Part 1, if $i_t < j < i_{t+1}$, then v_j must be adjacent to $v_{i_{t+1}}$. Because C is a tree, this accounts for all of the edges of C so indeed C is a caterpillar. Moreover, by Part 1, if $v_i \in L = C \setminus P$ is adjacent to v_j , then $M_{i,j} = |v_i|$.

- (4) Let $R_{i'}$ and $R_{j'_t}$ be the rows of λ corresponding to vertices v_i and v_{j_t} respectively, and again by Proposition 2.2, Part 3, we may assume that $i' = 1$. Because Π is triangle-free, we have $M_{j_t, j_{t'}} = 0$ for $t \neq t'$ so assuming without loss of generality that $j_1 < \dots < j_r$, we have $\ell(R_{j'_{t+1}}) \geq r(R_{j'_t}) + 1$ for every t . If $\ell(R_{j'_t}), \ell(R_{j'_{t'}}) < \ell(R_1)$ or if $r(R_{j'_t}), r(R_{j'_{t'}}) \geq r(R_1)$, then v_t and $v_{t'}$ are adjacent, so we must have $\ell(R_{j'_t}) \geq \ell(R_1)$ for every $t \geq 2$ and $r(R_{j'_t}) \leq r(R_1) - 1$ for every $t \leq r - 1$. Therefore

$$(3.32) \quad M_{i, j_1} \leq r(R_{j'_1}) - \ell(R_1) + 2,$$

$$(3.33) \quad M_{i, j_2} = |R_{j'_2}| = r(R_{j'_2}) - \ell(R_{j'_1}) + 1 \leq r(R_{j'_2}) - r(R_{j'_1}),$$

...

$$(3.34) \quad M_{i, j_{r-1}} = |R_{j'_{r-1}}| = r(R_{j'_{r-1}}) - \ell(R_{j'_{r-2}}) + 1 \leq r(R_{j'_{r-1}}) - r(R_{j'_{r-2}}),$$

$$(3.35) \quad M_{i, j_r} \leq r(R_1) - \ell(R_{j'_r}) + 1 \leq r(R_1) - r(R_{j'_{r-1}}),$$

and summing we have

$$(3.36) \quad \sum_{t=1}^r M_{i, j_t} \leq r(R_1) - \ell(R_1) + 2 = |R_1| + 1 = |v_i| + 1.$$

- (5) It suffices to construct a horizontal-strip μ for each connected component $C = (P \sqcup L, E)$ because in general we can translate each μ to avoid attacking the others. Let $P = \{v_{i_1}, \dots, v_{i_r}\}$ with $i_1 < \dots < i_r$ and define the integers

$$(3.37) \quad a_t = \sum_{t'=1}^{t-1} (|v_{i_{t'}}| - M_{i_{t'}, i_{t'+1}} + 1), \quad b_t = a_t + |v_{i_t}| - 1, \quad \text{and} \quad c_{t, t'} = \sum_{i_t+1 \leq k \leq i_t+t'} |v_k|.$$

Now our desired horizontal-strip is

$$(3.38) \quad \mu = (S_{i_1+1}, \dots, S_{i_2-1}, S_{i_2+1}, \dots, S_{i_3-1}, S_{i_3+1}, \dots, S_{i_r-1}, S_{i_r}, \dots, S_{i_1}),$$

where $\ell(S_j) = a_t$ and $r(S_j) = b_t$ if $j = i_t$ and $\ell(S_j) = b_{t-1} + c_{t, t'-1} + 2$ and $r(S_j) = b_{t-1} + c_{t, t'} + 1$ if $i_{t-1} < j = i_{t-1} + t' < i_t$. Indeed, we have that $r(S_j)$ is increasing, $|S_j| = |v_j|$, $M(S_{i_{t+1}}, S_{i_t}) = M_{i_t, i_{t+1}}$, $M(S_j, S_{i_t}) = |v_j|$ for $i_{t-1} < j < i_t$, and we have $M(S_j, S_{j'}) = 0$ otherwise because by Part 4, we have for $i_{t-1} < j < i_t$ that

$$(3.39) \quad \begin{aligned} r(S_{i_{t-1}}) + 1 &\leq b_{t-1} + 1 < \ell(S_j) \leq r(S_j) \leq b_{t-1} + \sum_{i_t+1 \leq k \leq i_t+t'-1} |v'_k| + 1 \\ &\leq b_{t-1} + |S_{i_t}| - M_{i_{t-1}, i_t} - M_{i_t, i_{t+1}} + 2 = a_{t+1} - 1 < \ell(S_{i_{t+1}}). \end{aligned}$$

As an illustration, the horizontal-strip in Example 3.23 is the one constructed here. □

4. THE COMBINATORIAL FORMULA

In this section, we generalize cocharge in order to prove a combinatorial formula for the LLT polynomial $G_{\lambda}(\mathbf{x}; q)$ whenever the weighted graph $\Pi(\lambda)$ is triangle-free.

Definition 4.1. Let μ be a partition and let $T \in \text{SSYT}_{\mu}$ be a tableau of shape μ with smallest entry i . We define the integer

$$(4.1) \quad f(T) = \max\{t : 0 \leq t \leq \mu_1 - \mu_2, t \leq w_i(T), T_{2,j'} > T_{1,j'+t} \text{ for all } 1 \leq j' \leq \mu_2\},$$

where as before, $w_i(T)$ is the number of i 's in T .

Remark 4.2. Informally, $f(T)$ is the maximum number of i 's that we can remove from T so that no entry moves down when we rectify the resulting skew tableau. Alternatively, $f(T)$ is the maximum number of cells that we can shift the bottom row of T to the left and still have the columns strictly increasing from bottom to top, as long as $f(T) \leq w_i(T)$.

Definition 4.3. Let T be an SSYT and let $i < j$ be integers. We denote by $T|_{i,j}$ the rectification of the skew tableau obtained by restricting T to the entries x with $i \leq x \leq j$, and we define the integer

$$(4.2) \quad \text{cocharge}_{i,j}(T) = w_i(T) - f(T|_{i,j}).$$

Example 4.4. For the tableaux S and T below left, we have drawn the tableaux $S|_{2,4}$ and $T|_{2,4}$ below right. We have $f(S|_{2,4}) = 3$ and $\text{cocharge}_{2,4}(S) = 5 - 3 = 2$, and we have $f(T|_{2,4}) = 3$ because we must have $t \leq w_2(T|_{2,4})$, so $\text{cocharge}_{2,4}(T) = 3 - 3 = 0$.

$$\begin{array}{c}
 S = \begin{array}{|c|c|c|c|c|c|} \hline 3 & 4 & & & & \\ \hline 2 & 2 & 3 & 4 & 5 & 5 \\ \hline 1 & 1 & 1 & 2 & 2 & 2 & 3 & 4 \\ \hline \end{array}
 \quad
 S|_{2,4} = \begin{array}{|c|c|c|c|c|c|c|} \hline 4 & & & & & & \\ \hline 3 & 3 & 4 & & & & \\ \hline 2 & 2 & 2 & 2 & 2 & 3 & 4 \\ \hline \end{array} \\
 \\
 T = \begin{array}{|c|c|c|c|c|c|c|c|} \hline 4 & 5 & & & & & \\ \hline 2 & 2 & 4 & 4 & 5 & 5 & \\ \hline 1 & 1 & 1 & 2 & 3 & 3 & 3 & 3 \\ \hline \end{array}
 \quad
 T|_{2,4} = \begin{array}{|c|c|c|c|c|c|c|} \hline 4 & 4 & 4 & & & & \\ \hline 2 & 2 & 2 & 3 & 3 & 3 & 3 \\ \hline \end{array}
 \end{array}$$

Example 4.5. In the case where $j = i + 1$, $\text{cocharge}_{i,i+1}(T)$ is the number of entries in the second row of $T|_{i,i+1}$, which in Example 2.8 we saw is $\text{cocharge}(T|_{i,i+1})$.

We now state our main Theorem.

Theorem 4.6. Let λ be a horizontal-strip such that the weighted graph $\Pi = \Pi(\lambda)$ is triangle-free and let $\alpha_i = |v_i|$. Then the LLT polynomial of λ is

$$(4.3) \quad G_{\lambda}(\mathbf{x}; q) = \sum_{T \in \text{SSYT}(\alpha)} q^{\text{cocharge}_{\Pi}(T)} s_{\text{shape}(T)},$$

where $\text{cocharge}_{\Pi}(T) = \sum_{i < j} \min\{M_{i,j}, \text{cocharge}_{i,j}(T)\}$.

Before we prove Theorem 4.6, we will present some examples and special cases to familiarize ourselves with this generalization of cocharge.

Example 4.7. Let $\lambda = (6/5, 9/6, 7/2, 4/0)$ be the horizontal-strip below left with the right-most cells in each row labelled in content reading order, so that $\Pi(\lambda)$ is the caterpillar below right.

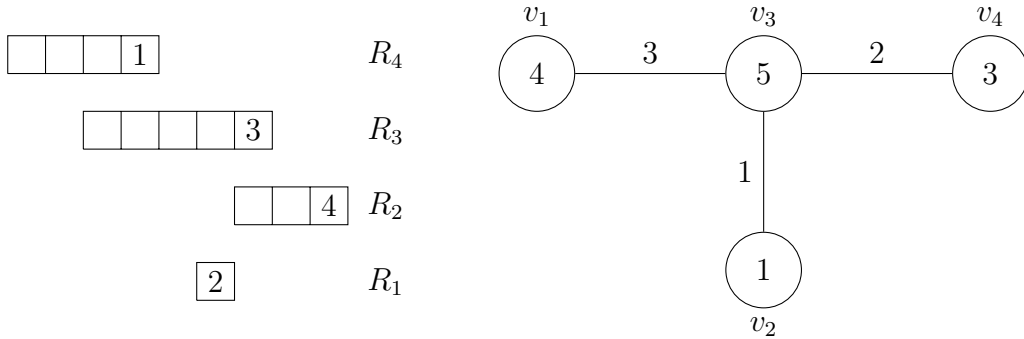

To calculate the coefficient of s_{733} , we consider the three tableaux of weight $\alpha = 4153$ and shape 733 as follows. The values of cocharge_{Π} are calculated below.

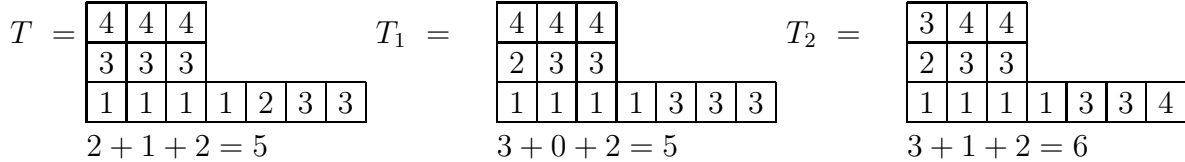

Therefore, the coefficient of s_{733} is $(q^6 + 2q^5)$.

Corollary 4.8. Let λ be a horizontal-strip whose weighted graph $\Pi(\lambda)$ is the path below.

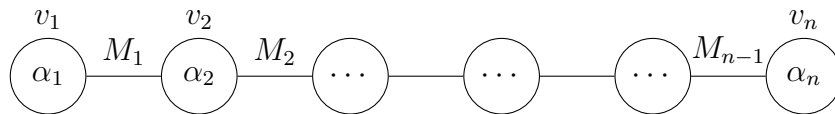

Then the LLT polynomial of λ is

$$(4.4) \quad G_{\lambda}(\mathbf{x}; q) = \sum_{T \in \text{SSYT}(\alpha)} q^{\text{cocharge}_{\Pi}(T)} s_{\text{shape}(T)},$$

where $\text{cocharge}_{\Pi}(T) = \sum_{i=1}^{n-1} \min\{M_i, \text{number of entries in the second row of } T|_{[i, i+1]}\}$.

Remark 4.9. Corollary 4.8 generalizes [3, Theorem 1], which gives a combinatorial formula for $G_{\lambda}(\mathbf{x}; q)$ in certain cases where $\Pi(\lambda)$ is a path as above, with the additional constraint that $M_{i-1} + M_i \leq \alpha_i$ for $2 \leq i \leq n - 1$. Note that by Proposition 3.21, Part 4, the weaker inequality $M_{i-1} + M_i \leq \alpha_i + 1$ holds for $2 \leq i \leq n - 1$.

Example 4.10. Let λ be a horizontal-strip with exactly two rows, so that $\Pi(\lambda)$ is

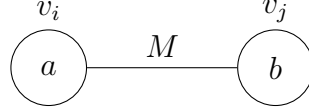

for some $a \geq b \geq M$, where (i, j) is either $(1, 2)$ or $(2, 1)$, so $\alpha = (a, b)$ or $\alpha = (b, a)$ respectively. In either case, for each $0 \leq k \leq b$, there is a unique tableau T_k with content α and shape $(a + b - k)k$. Therefore, by Corollary 4.8, the LLT polynomial is

$$(4.5) \quad G_\lambda(\mathbf{x}; q) = \sum_{k=0}^b q^{\min\{M, k\}} s_{(a+b-k)k} = s_{(a+b)} + \cdots + q^M s_{(a+b-M)M} + \cdots + q^M s_{ab}.$$

Note that in this example, the formula (4.3) does not depend on the labelling of Π .

We now illustrate the idea of the proof in the case of Example 4.7.

Proof of Theorem 4.6 in the case of Example 4.7. We will use induction on $M(\lambda)$. By applying Lemma 3.17 to rows R_3 and R_4 and by using Proposition 3.18, we can write

$$(4.6) \quad G_\lambda(\mathbf{x}; q) = qG_{\lambda'}(\mathbf{x}; q) + (1 - q)G_{\lambda''}(\mathbf{x}; q),$$

where the weighted graphs $\Pi = \Pi(\lambda)$, $\Pi' = \Pi(\lambda')$, and $\Pi'' = \Pi(\lambda'')$ are given below.

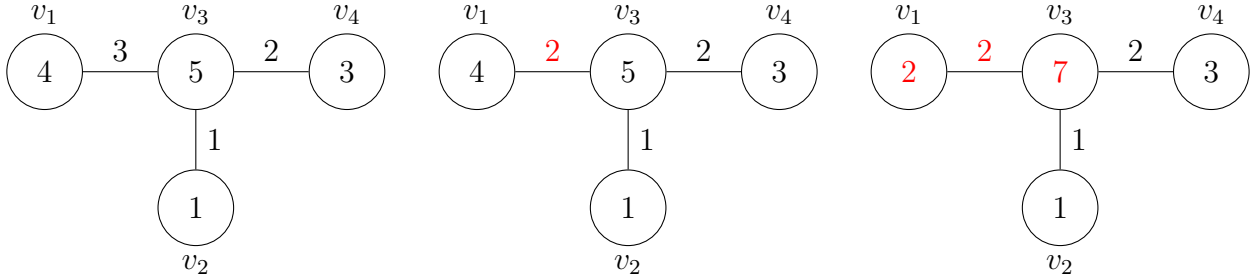

By our induction hypothesis, our task is now to prove that

$$(4.7) \quad \sum_{T \in \text{SSYT}(4153)} q^{\text{cocharge}_\Pi(T)} s_{\text{shape}(T)} = q \sum_{T \in \text{SSYT}(4153)} q^{\text{cocharge}_{\Pi'}(T)} s_{\text{shape}(T)} + (1 - q) \sum_{S \in \text{SSYT}(2173)} q^{\text{cocharge}_{\Pi''}(S)} s_{\text{shape}(S)}.$$

Let us consider the coefficient of s_{733} . The first sum on the right hand side corresponds to the three tableaux from Example 4.7 with the values of $\text{cocharge}_{\Pi'}$ calculated below.

$$T = \begin{array}{|c|c|c|} \hline 4 & 4 & 4 \\ \hline 3 & 3 & 3 \\ \hline 1 & 1 & 1 \\ \hline \end{array} \quad T_1 = \begin{array}{|c|c|c|} \hline 4 & 4 & 4 \\ \hline 2 & 3 & 3 \\ \hline 1 & 1 & 1 \\ \hline \end{array} \quad T_2 = \begin{array}{|c|c|c|} \hline 3 & 4 & 4 \\ \hline 2 & 3 & 3 \\ \hline 1 & 1 & 1 \\ \hline \end{array}$$

$2 + 1 + 2 = 5$
 $2 + 0 + 2 = 4$
 $2 + 1 + 2 = 5$

The factor of q tells us to increase these values by one, and this corresponds to increasing $M_{1,3}$ from 2 to 3. Indeed, for the tableaux T_1 and T_2 , because $\text{cocharge}_{1,3}(T_i) = 3$, the contribution to $\text{cocharge}_{\Pi}(T_i)$ is now $\min\{3, 3\} = 3$ instead of $\min\{2, 3\} = 2$. However, the tableau T has $\text{cocharge}_{1,3}(T) = 2$, so in this case we do not want to increase the cocharge by one. The second sum allows us to make this correction. It corresponds to the tableau below.

$$S = \begin{array}{|c|c|c|} \hline 4 & 4 & 4 \\ \hline 3 & 3 & 3 \\ \hline 1 & 1 & 2 & 3 & 3 & 3 & 3 \\ \hline \end{array}$$

$$2 + 1 + 2 = 5$$

The factor of $(1 - q)$ tells us to change the term $q^6 s_{733}$ corresponding to T back into the term $q^5 s_{733}$. In general, this second sum precisely corrects for those tableaux for which we do not want to increase the cocharge by one when we increase $M_{1,3}$ by one. To be specific, we will define a bijection

$$(4.8) \quad \varphi : \text{SSYT}(2173) \rightarrow \{T \in \text{SSYT}(4153) : \text{cocharge}_{1,3}(T) \leq 2\}$$

such that $\text{cocharge}_{\Pi''}(S) = \text{cocharge}_{\Pi'}(\varphi(S))$. Informally, this bijection is given by changing two 3's on the bottom row of S into 1's. We have defined $\text{cocharge}_{1,3}$ specifically to measure the property of being in the image of φ . In this case, this image is precisely those tableaux T for which two 1's on the bottom row can be removed and two 3's can be added, meaning that $f(T) \geq 2$ and $\text{cocharge}_{1,3}(T) \leq 4 - 2 = 2$. Also note that by definition we have

$$(4.9) \quad \text{cocharge}_{\Pi}(T) = \begin{cases} \text{cocharge}_{\Pi'}(T), & \text{if } \text{cocharge}_{1,3}(T) \leq 2, \\ \text{cocharge}_{\Pi'}(T) + 1, & \text{if } \text{cocharge}_{1,3}(T) \geq 3. \end{cases}$$

Therefore, we have

$$(4.10) \quad \begin{aligned} & q \sum_{T \in \text{SSYT}(4153)} q^{\text{cocharge}_{\Pi'}(T)} s_{\text{shape}(T)} + (1 - q) \sum_{S \in \text{SSYT}(2173)} q^{\text{cocharge}_{\Pi''}(S)} s_{\text{shape}(S)} \\ &= q \sum_{\substack{T \in \text{SSYT}(4153) \\ \text{cocharge}_{1,3}(T) \geq 3}} q^{\text{cocharge}_{\Pi'}(T)} s_{\text{shape}(T)} \\ &+ q \sum_{\substack{T \in \text{SSYT}(4153) \\ \text{cocharge}_{1,3}(T) \leq 2}} q^{\text{cocharge}_{\Pi'}(T)} s_{\text{shape}(T)} + (1 - q) \sum_{S \in \text{SSYT}(2173)} q^{\text{cocharge}_{\Pi''}(S)} s_{\text{shape}(S)} \\ &= q \sum_{\substack{T \in \text{SSYT}(4153) \\ \text{cocharge}_{1,3}(T) \geq 3}} q^{\text{cocharge}_{\Pi'}(T)+1} s_{\text{shape}(T)} + \sum_{\substack{T \in \text{SSYT}(4153) \\ \text{cocharge}_{1,j}(T) \leq 2}} q^{\text{cocharge}_{\Pi'}(T)} s_{\text{shape}(T)} \\ &= \sum_{T \in \text{SSYT}(4153)} q^{\text{cocharge}_{\Pi}(T)} s_{\text{shape}(T)}, \end{aligned}$$

as desired. □

We will now make this argument precise and check the details. We first recall the Littlewood–Richardson rule, which gives a combinatorial formula for the product of two Schur functions.

Theorem 4.11. [6, Section 5.1, Corollary 2 and Corollary 3] (The Littlewood–Richardson rule) Let λ , μ , and ν be partitions and fix a tableau $S \in \text{SSYT}_\mu$. Denote by $c_{\mu,\nu}^\lambda$ the number of tableaux $T \in \text{SSYT}_{\lambda/\nu}$ whose rectification is S . Then the product of Schur functions s_μ and s_ν expands in the basis of Schur functions as

$$(4.11) \quad s_\mu s_\nu = \sum_{\lambda} c_{\mu,\nu}^\lambda s_\lambda.$$

We now prove Theorem 4.6.

Proof of Theorem 4.6. Let $\boldsymbol{\lambda} = (R_1, \dots, R_n)$ and let $R_{i'}$ be the row corresponding to the vertex v_1 . We use induction on n . If $n = 1$, then both sides of (4.3) are s_{α_1} , so we may assume that $n \geq 2$.

We first consider the case where the vertex v_1 has no neighbour. Let $\tilde{\alpha} = (0, \alpha_2, \dots, \alpha_n)$ and note that we can associate a tableau $\tilde{T} \in \text{SSYT}_{\lambda/(\alpha_1)}(\tilde{\alpha})$ with a tableau $T \in \text{SSYT}_\lambda(\alpha)$ by placing α_1 1's underneath \tilde{T} . Because cocharge_Π is defined by restricting to the appropriate entries and rectifying, we have $\text{cocharge}_\Pi(T) = \text{cocharge}_\Pi(T|_{2,n})$. Now using Proposition 2.2, Part 2, our induction hypothesis, and the Littlewood–Richardson rule, we have

$$(4.12) \quad \begin{aligned} G_{\boldsymbol{\lambda}}(\mathbf{x}; q) &= G_{(R_{i'})}(\mathbf{x}; q) G_{(R_1, \dots, R_{i'-1}, R_{i'+1}, \dots, R_n)}(\mathbf{x}; q) = \sum_{S \in \text{SSYT}(\tilde{\alpha})} q^{\text{cocharge}_\Pi(S)} s_{\text{shape}(S)} s_{\alpha_1} \\ &= \sum_{S \in \text{SSYT}(\tilde{\alpha})} \sum_{\substack{T \in \text{SSYT}(\alpha) \\ T|_{2,n} = S}} q^{\text{cocharge}_\Pi(T)} s_{\text{shape}(T)} = \sum_{T \in \text{SSYT}(\alpha)} q^{\text{cocharge}_\Pi(T)} s_{\text{shape}(T)}, \end{aligned}$$

as desired. So we now suppose that the vertex v_1 has a neighbour v_j corresponding to some row $R_{j'}$ and note that by Proposition 3.21, Part 2, this neighbour is unique. We also use induction on $M(\boldsymbol{\lambda})$. If $M(\boldsymbol{\lambda}) = 0$, then the vertex v_1 has no neighbour, so we may assume that $M(\boldsymbol{\lambda}) \geq 1$. Using Proposition 3.21, Part 2 again, the vertex v_j has at most one neighbour v_k for which $j < k$. By Proposition 2.2, Part 2, we may assume that $i' > j'$. We claim that we may further assume that $i' = j' + 1$ and that $R_{i'} \leftrightarrow R_{j'}$.

For $1 \leq t < i'$ with $t \neq j'$, because $M(R_t, R_{i'}) = 0$ and $r(R_{i'}) \leq r(R_t)$, we must in fact have $r(R_{i'}) < \ell(R_t) - 1$ and $R_{i'} \leftrightarrow R_t$ by Proposition 3.8. Therefore, by Lemma 3.15, we may move row $R_{i'}$ down to assume without loss of generality that $i' = j' + 1$. If $R_{i'} \leftrightarrow R_{j'}$, then we have established our claim. Otherwise, if $R_{i'} \leftrightarrow R_{j'}$, then we continue to use Lemma 3.15 to move the row $R_{i'}$ down, then we use Proposition 2.2, Part 2, to move $R_{i'}$ back to the top and decrease $\ell(R_{i'})$ by one, and we use Lemma 3.15 to again assume that $i' = j' + 1$.

If $R_{i'} \leftrightarrow R_{j'}$ then we are done, otherwise we continue this process, decreasing $\ell(R_{i'})$ by one each time. Because $R_{i'}$ and $R_{j'}$ will not commute when $\ell(R_{i'}) < \ell(R_{j'})$, this process will eventually terminate and we may assume that $i' = j' + 1$ and $R_{i'} \leftrightarrow R_{j'}$. Now we can apply Lemma 3.17 in order to write

$$(4.13) \quad G_{\lambda}(\mathbf{x}; q) = qG_{\lambda'}(\mathbf{x}; q) + (1 - q)G_{\lambda''}(\mathbf{x}; q),$$

where $\lambda' = (R_1, \dots, R_{i'}, R_{j'}, \dots, R_n)$ and $\lambda'' = (R_1, \dots, R_{i'} \cup R_{j'}, R_{i'} \cap R_{j'}, \dots, R_n)$. By Proposition 3.18, the graphs $\Pi = \Pi(\lambda)$, $\Pi' = \Pi(\lambda')$, and $\Pi'' = \Pi(\lambda'')$ are as below, where $M = M_{1,j}$ and $c = \alpha_1 + \alpha_j - (M - 1)$.

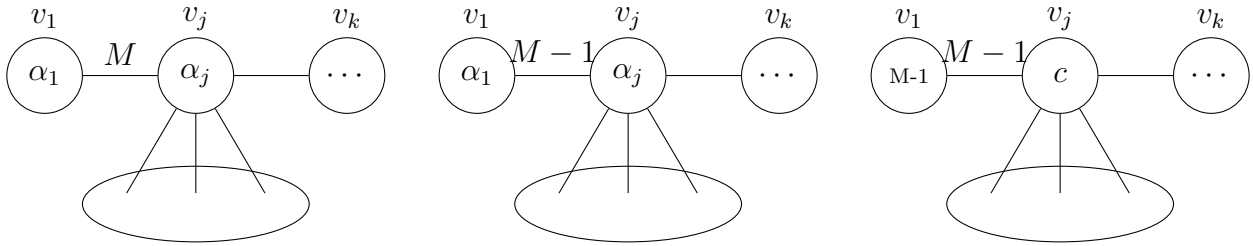

Let $\beta = (M - 1, \alpha_2, \dots, \alpha_{j-1}, c, \alpha_{j+1}, \dots, \alpha_n)$ and let $t = \alpha_1 - (M - 1)$. We define a map

$$(4.14) \quad \varphi : \text{SSYT}(\beta) \rightarrow \{T \in \text{SSYT}(\alpha) : \text{cocharge}_{1,j}(T) \leq M - 1\}$$

as follows. For $S \in \text{SSYT}(\beta)$, let $\varphi(S) = T$ be the tableau of the same shape given by

$$(4.15) \quad T_{i',j'} = \begin{cases} 1 & \text{if } i' = 1 \text{ and } j' \leq t, \\ S_{1,j'-t} & \text{if } i' = 1 \text{ and } t < j' \leq j_1, \\ S_{i',j'} & \text{otherwise,} \end{cases}$$

where j_1 is the column of the rightmost j in S . As an illustration, for $t = 2$ and the tableaux S_1 and S_2 below left, we have $T_1 = \varphi(S_1)$ and $T_2 = \varphi(S_2)$ below right. Informally, we change the two red 3's on the bottom row into 1's.

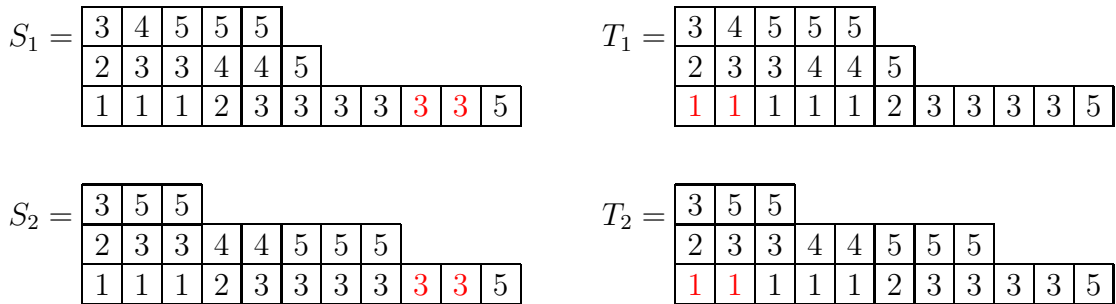

We first show that the map φ is well-defined and is a bijection. Let n_j denote the number of j 's in S that are not on the bottom row. Because the columns of S are strictly increasing, n_j is at most the number of entries in S less than j , that is $n_j \leq (M - 1) + \alpha_2 + \dots + \alpha_{j-1}$. By Proposition 3.21, Part 3 and Part 4, this means that $n_j \leq \alpha_j$, so S has at least $c - \alpha_j = t$ j 's on the bottom row and indeed t j 's have been replaced by t 1's and $\varphi(T) \in \text{SSYT}(\alpha)$.

Furthermore, by construction, $f(T) = f(S) + t \geq t$, so $\text{cocharge}_{1,j}(T) = \text{cocharge}_{1,j}(S) \leq \alpha_1 - t = M - 1$. Also, given $T \in \text{SSYT}(\beta)$ such that $\text{cocharge}_{1,j}(T) \leq M - 1$, then $f(T) \geq t$ and we can define $S = \varphi^{-1}(T) \in \text{SSYT}(\alpha)$ by

$$(4.16) \quad S_{i',j'} = \begin{cases} T_{1,j'+t} & \text{if } i' = 1 \text{ and } j' \leq j_1 - t, \\ j & \text{if } i' = 1 \text{ and } j_1 - t < j' \leq j_1, \\ T_{i',j'} & \text{otherwise.} \end{cases}$$

We now claim that $\text{cocharge}_{\Pi''}(S) = \text{cocharge}_{\Pi'}(T)$. We have already shown that $f(T) = f(S) + t$ and therefore $\text{cocharge}_{1,j}(S) = \text{cocharge}_{1,j}(T)$. For $2 \leq i \leq j - 1$, the tableau $S|_{i,j}$ is simply $T|_{i,j}$ with t j 's appended to the right of the first row, and therefore $f(S|_{i,j}) = f(T|_{i,j})$ and $\text{cocharge}_{i,j}(S) = \text{cocharge}_{i,j}(T)$. It remains to consider $\text{cocharge}_{j,k}$. In fact, it could happen that $\text{cocharge}_{j,k}(S) \neq \text{cocharge}_{j,k}(T)$. However, we claim that this is only possible when both integers are at least $M_{j,k}$, so that

$$(4.17) \quad \min\{M_{j,k}, \text{cocharge}_{j,k}(S)\} = M_{j,k} = \min\{M_{j,k}, \text{cocharge}_{j,k}(T)\}.$$

We restrict S and T to entries x with $j \leq x \leq k$ and we consider how the entries move when we rectify these tableaux. By Theorem 2.5, the rectification does not depend on the order of choices of inside corners, so let us begin by performing jeu de taquin slides into all inside corners that are not on the first row to produce tableaux S' and T' . Because S and T differ only in their first row, that is $S_{i',j'} = T_{i',j'}$ for all $i' \geq 2$, we also have $S'_{i',j'} = T'_{i',j'}$ for all $i' \geq 2$. Also note that the n_j j 's of S' and T' that are not on the first row must now be on the second row, or in other words $S'_{2,j'} = T'_{2,j'} = j$ for $1 \leq j' \leq n_j$.

Now repeatedly perform jeu de taquin slides on S' until we obtain a skew tableau S'' of shape $\sigma/(n_j)$ for some σ and define T'' similarly. Let t_0 be the number of jeu de taquin slides performed on S' to produce S'' , so that $t + t_0$ is the number of slides performed on T' to produce T'' . We have two cases to consider.

If $T'_{2,t'} > T'_{1,t'+t+t_0}$ for all $n_j < t' \leq \sigma_2$, then no entry of T' moves down in this step, and because $T'_{2,t'} = S'_{2,t'}$ and $T'_{1,t'+t+t_0} = S'_{1,t'+t_0}$, no entry of S' moves down either. Now because $S''_{2,n_j} = T''_{2,n_j} = j$, when we perform the final n_j jeu de taquin slides, the entries of the first rows of S'' and T'' do not move, and because $S''_{i',j'} = T''_{i',j'}$ for all $i' \geq 2$, we now have

$$(4.18) \quad (S|_{j,k})_{i',j'} = \begin{cases} j & \text{if } i' = 1 \text{ and } j' \leq t, \\ (T|_{j,k})_{1,j'-t} & \text{if } i' = 1 \text{ and } j' > t, \\ (T|_{j,k})_{i',j'} & \text{otherwise.} \end{cases}$$

In particular, we have $f(S|_{j,k}) = f(T|_{j,k}) + t$ and $\text{cocharge}_{j,k}(S) = \text{cocharge}_{j,k}(T)$. As an illustration, for $j = 3$ and $k = 5$, these stages in the rectification of the tableaux S_1 and T_1 are given below.

$S_1 = \begin{array}{ c c c c c } \hline 3 & 4 & 5 & 5 & 5 \\ \hline 2 & 3 & 3 & 4 & 4 & 5 \\ \hline 1 & 1 & 1 & 2 & 3 & 3 & 3 & 3 & 3 & 3 & 5 \\ \hline \end{array}$	$T_1 = \begin{array}{ c c c c c } \hline 3 & 4 & 5 & 5 & 5 \\ \hline 2 & 3 & 3 & 4 & 4 & 5 \\ \hline 1 & 1 & 1 & 1 & 1 & 2 & 3 & 3 & 3 & 3 & 5 \\ \hline \end{array}$
$S'_1 = \begin{array}{ c c c c } \hline 4 & 5 & 5 & 5 \\ \hline 3 & 3 & 3 & 4 & 4 & 5 \\ \hline & & & 3 & 3 & 3 & 3 & 3 & 3 & 3 & 5 \\ \hline \end{array}$	$T'_1 = \begin{array}{ c c c c } \hline 4 & 5 & 5 & 5 \\ \hline 3 & 3 & 3 & 4 & 4 & 5 \\ \hline & & & 3 & 3 & 3 & 3 & 3 & 5 \\ \hline \end{array}$
$S''_1 = \begin{array}{ c c c c } \hline 4 & 5 & 5 & 5 \\ \hline 3 & 3 & 3 & 4 & 4 & 5 \\ \hline & & & 3 & 3 & 3 & 3 & 3 & 3 & 3 & 5 \\ \hline \end{array}$	$T''_1 = \begin{array}{ c c c c } \hline 4 & 5 & 5 & 5 \\ \hline 3 & 3 & 3 & 4 & 4 & 5 \\ \hline & & & 3 & 3 & 3 & 3 & 5 \\ \hline \end{array}$
$S_1 _{3,5} = \begin{array}{ c c } \hline 5 & 5 \\ \hline 4 & 4 & 4 & 5 & 5 \\ \hline 3 & 3 & 3 & 3 & 3 & 3 & 3 & 3 & 3 & 5 \\ \hline \end{array}$	$T_1 _{3,5} = \begin{array}{ c c } \hline 5 & 5 \\ \hline 4 & 4 & 4 & 5 & 5 \\ \hline 3 & 3 & 3 & 3 & 3 & 3 & 3 & 5 \\ \hline \end{array}$

Now suppose that $T'_{2,t'} \leq T'_{1,t'+t+t_0}$ for some t' with $n_j < t' \leq \sigma_2$. Then when we perform jeu de taquin slides to produce T'' , an entry $x > j$ of the second row must move down on some slide. On subsequent slides, because the second row of T' was weakly increasing, entries of the second row will continue to move down, and we will have $j < T''_{2,t'} \leq T''_{1,t'+1}$ for some $t' > n_j$. Meanwhile, we must have $j < S''_{2,t'} \leq S''_{2,t'+t}$ for some $t' > n_j$ because if we delete t j 's on the first row of S'' and then perform t jeu de taquin slides, we would obtain T'' so some entry of the second row must move down.

When we perform the final n_j jeu de taquin slides, the entries of the first rows of S'' and T'' do not move, the n_j j 's in the second rows of S'' and T'' each move one cell down, and the remaining entries in the second rows move at most n_j cells to the left. Therefore, we now have $f(T|_{j,k}) \leq n_j$ and $f(S|_{j,k}) \leq n_j + t$. By Proposition 3.21, Part 3 and Part 4, we have $n_j \leq (M-1) + \alpha_2 + \dots + \alpha_{j-1} \leq \alpha_j - M_{j,k}$, and therefore $\text{cocharge}_{j,k}(S), \text{cocharge}_{j,k}(T) \geq M_{j,k}$.

As an illustration, for $j = 3$ and $k = 5$, these stages in the rectification of S_2 and T_2 are given below. When we rectify T'_2 , a 5 moves down from the second row so the second rows of S''_2 and T''_2 will be different. However, when we rectify S''_2 and T''_2 , these 5's move at most three cells to the left, so $f(S_2|_{3,5}) \leq 5$ and $f(T_2|_{3,5}) \leq 3$, which means that $\text{cocharge}_{3,5}(S), \text{cocharge}_{3,5}(T) \geq 4$. Informally, the only way that $\text{cocharge}_{j,k}(S)$ could differ from $\text{cocharge}_{j,k}(T)$ is if a cell in the second row of T moves down prematurely, but if this happens, then $f(T|_{j,k})$ will be small enough to make $\text{cocharge}_{j,k}(T) \geq M_{j,k}$.

$$\begin{array}{l}
S_2 = \begin{array}{|c|c|c|c|c|c|c|c|c|c|c|} \hline 3 & 5 & 5 & & & & & & & & \\ \hline 2 & 3 & 3 & 4 & 4 & 5 & 5 & 5 & & & \\ \hline 1 & 1 & 1 & 2 & 3 & 3 & 3 & 3 & 3 & 3 & 5 \\ \hline \end{array} & T_2 = \begin{array}{|c|c|c|c|c|c|c|c|c|c|c|} \hline 3 & 5 & 5 & & & & & & & & \\ \hline 2 & 3 & 3 & 4 & 4 & 5 & 5 & 5 & & & \\ \hline 1 & 1 & 1 & 1 & 1 & 2 & 3 & 3 & 3 & 3 & 5 \\ \hline \end{array} \\
\\
S'_2 = \begin{array}{|c|c|c|c|c|c|c|c|c|c|c|} \hline 5 & 5 & & & & & & & & & \\ \hline 3 & 3 & 3 & 4 & 4 & 5 & 5 & 5 & & & \\ \hline & & & & 3 & 3 & 3 & 3 & 3 & 3 & 5 \\ \hline \end{array} & T'_2 = \begin{array}{|c|c|c|c|c|c|c|c|c|c|c|} \hline 5 & 5 & & & & & & & & & \\ \hline 3 & 3 & 3 & 4 & 4 & 5 & 5 & 5 & & & \\ \hline & & & & & & 3 & 3 & 3 & 3 & 5 \\ \hline \end{array} \\
\\
S''_2 = \begin{array}{|c|c|c|c|c|c|c|c|c|c|c|} \hline 5 & 5 & & & & & & & & & \\ \hline 3 & 3 & 3 & 4 & 4 & 5 & 5 & 5 & & & \\ \hline & & & & 3 & 3 & 3 & 3 & 3 & 3 & 5 \\ \hline \end{array} & T''_2 = \begin{array}{|c|c|c|c|c|c|c|c|c|c|c|} \hline 5 & 5 & & & & & & & & & \\ \hline 3 & 3 & 3 & 4 & 4 & 5 & 5 & & & & \\ \hline & & & & 3 & 3 & 3 & 3 & 5 & 5 & \\ \hline \end{array} \\
\\
S_2|_{3,5} = \begin{array}{|c|c|c|c|c|c|c|c|c|c|c|} \hline 5 & 5 & & & & & & & & & \\ \hline 4 & 4 & 5 & 5 & 5 & & & & & & \\ \hline 3 & 3 & 3 & 3 & 3 & 3 & 3 & 3 & 3 & 3 & 5 \\ \hline \end{array} & T_2|_{3,5} = \begin{array}{|c|c|c|c|c|c|c|c|c|c|c|} \hline 5 & 5 & & & & & & & & & \\ \hline 4 & 4 & 5 & 5 & & & & & & & \\ \hline 3 & 3 & 3 & 3 & 3 & 3 & 3 & 3 & 5 & 5 & \\ \hline \end{array}
\end{array}$$

In summary, the map φ is a bijection and it satisfies $\text{cocharge}_{\Pi''}(S) = \text{cocharge}_{\Pi'}(\varphi(S))$. Also note that by definition we have

$$(4.19) \quad \text{cocharge}_{\Pi}(T) = \begin{cases} \text{cocharge}_{\Pi'}(T) & \text{if } \text{cocharge}_{1,j}(T) \leq M-1, \\ \text{cocharge}_{\Pi'}(T) + 1 & \text{if } \text{cocharge}_{1,j}(T) \geq M. \end{cases}$$

Therefore, using our induction hypothesis, we have

$$\begin{aligned}
(4.20) \quad G_{\lambda}(\mathbf{x}; q) &= qG_{\lambda'}(\mathbf{x}; q) + (1-q)G_{\lambda''}(\mathbf{x}; q) \\
&= q \sum_{T \in \text{SSYT}(\alpha)} q^{\text{cocharge}_{\Pi'}(T)} s_{\text{shape}(T)} + (1-q) \sum_{S \in \text{SSYT}(\beta)} q^{\text{cocharge}_{\Pi''}(S)} s_{\text{shape}(S)} \\
&= q \sum_{\substack{T \in \text{SSYT}(\alpha) \\ \text{cocharge}_{1,j}(T) \geq M}} q^{\text{cocharge}_{\Pi'}(T)} s_{\text{shape}(T)} \\
&\quad + q \sum_{\substack{T \in \text{SSYT}(\alpha) \\ \text{cocharge}_{1,j}(T) \leq M-1}} q^{\text{cocharge}_{\Pi'}(T)} s_{\text{shape}(T)} + (1-q) \sum_{S \in \text{SSYT}(\beta)} q^{\text{cocharge}_{\Pi''}(S)} s_{\text{shape}(S)} \\
&= q \sum_{\substack{T \in \text{SSYT}(\alpha) \\ \text{cocharge}_{1,j}(T) \geq M}} q^{\text{cocharge}_{\Pi'}(T)+1} s_{\text{shape}(T)} + \sum_{\substack{T \in \text{SSYT}(\alpha) \\ \text{cocharge}_{1,j}(T) \leq M-1}} q^{\text{cocharge}_{\Pi'}(T)} s_{\text{shape}(T)} \\
&= \sum_{T \in \text{SSYT}(\alpha)} q^{\text{cocharge}_{\Pi}(T)} s_{\text{shape}(T)}.
\end{aligned}$$

This completes the proof. \square

Theorem 4.6 expresses the LLT polynomial $G_{\lambda}(\mathbf{x}; q)$ in terms of the weighted graph $\Pi(\lambda)$ but not in terms of λ itself. In other words, if $\Pi(\lambda)$ and $\Pi(\mu)$ are equal and triangle-free, then $G_{\lambda}(\mathbf{x}; q) = G_{\mu}(\mathbf{x}; q)$. We conjecture that the formula (4.3) does not depend on the labelling of the vertices of $\Pi(\lambda)$, provided that whenever $i < j < k$ and v_i is adjacent to v_k , then $M_{j,k} = |v_j|$. By Proposition 3.21, Part 5, this is equivalent to the following statement.

Conjecture 4.12. Let λ and μ be horizontal-strips. If the weighted graphs $\Pi(\lambda)$ and $\Pi(\mu)$ are isomorphic and triangle-free, then the LLT polynomials $G_{\lambda}(\mathbf{x}; q)$ and $G_{\mu}(\mathbf{x}; q)$ are equal.

We further conjecture that in general a horizontal-strip LLT polynomial $G_{\lambda}(\mathbf{x}; q)$ is determined by its unlabelled weighted graph.

Conjecture 4.13. Let λ and μ be horizontal-strips. If the weighted graphs $\Pi(\lambda)$ and $\Pi(\mu)$ are isomorphic, then the LLT polynomials $G_{\lambda}(\mathbf{x}; q)$ and $G_{\mu}(\mathbf{x}; q)$ are equal.

REFERENCES

- [1] P. ALEXANDERSSON, *LLT polynomials, elementary symmetric functions and melting lollipops*. J. Algebraic Combin. (2020).
- [2] P. ALEXANDERSSON AND R. SULZGRUBER, *A combinatorial expansion of vertical-strip LLT polynomials in the basis of elementary symmetric functions*. arXiv:2004.09198 (2020).
- [3] P. ALEXANDERSSON AND J. UHLIN, *Cyclic sieving, skew Macdonald polynomials and Schur positivity*. arXiv:1908.00083 (2019).
- [4] E. CARLSSON AND A. MELLIT, *A proof of the shuffle conjecture*. J. Amer. Math. Soc. 31 661–697 (2018).
- [5] M. D’ADDERIO, *e-Positivity of vertical strip LLT polynomials*. arXiv:1906.02633 (2019).
- [6] W. FULTON, *Young Tableaux: With Applications to Representation Theory and Geometry*. Cambridge University Press (1997).
- [7] I. GROJNOWSKI AND M. HAIMAN, *Affine Hecke algebras and positivity of LLT and Macdonald polynomials*. (2007).
- [8] J. HAGLUND, M. HAIMAN, AND N. LOEHR, *A combinatorial formula for Macdonald polynomials*. J. Amer. Math. Soc. 18 (2005) 735–761.
- [9] J. HAGLUND, M. HAIMAN, N. LOEHR, J. REMMEL, AND A. ULYANOV, *A combinatorial formula for the character of the diagonal coinvariants*. Duke Math. J. 126 195–232 (2005).
- [10] J. HUH, S. NAM, AND M. YOO, *Melting lollipop chromatic quasisymmetric functions and Schur expansion of unicellular LLT polynomials*. arXiv:1812.03445 (2018).
- [11] A. LASCOUX, B. LECLERC, AND J-Y. THIBON, *Ribbon tableaux, Hall–Littlewood functions, quantum affine algebras, and unipotent varieties*. J. Math. Phys. 38 (1997), no. 2, 1041–1068.
- [12] A. LASCOUX, B. LECLERC, J-Y. THIBON, *The plactic monoid*. Encyclopedia of Mathematics and its Applications (2002) vol. 90, 164–196.
- [13] A. LASCOUX AND M-P. SCHÜTZENBERGER, *Sur une conjecture de H. O. Foulkes*. C. R. Acad. Sci. 286 no. 7, (1978).
- [14] B. LECLERC AND J-Y. THIBON, *Littlewood–Richardson coefficients and Kazhdan–Lusztig polynomials*. Adv. Stud. Pure Math. 28 155–220 (2000).
- [15] C. MILLER, *On the k -Schur Positivity of k -Bandwidth LLT Polynomials*. (2019).
- [16] R. STANLEY, *Enumerative Combinatorics. Vol. 2*. Cambridge University Press (1999).