

PATCHWORKING ORIENTED MATROIDS

MARCEL CELAYA, GEORG LOHO, CHI HO YUEN

ABSTRACT. In a previous work, we gave a construction of (not necessarily realizable) oriented matroids from a triangulation of a product of two simplices. In this follow-up paper, we use a variant of Viro's patchworking to derive a topological representation of the oriented matroid directly from the polyhedral structure of the triangulation, hence finding a combinatorial manifestation of patchworking besides tropical algebraic geometry. We achieve this by rephrasing the patchworking procedure as a controlled cell merging process, guided by the structure of tropical oriented matroids. A key insight is a new promising technique to show that the final cell complex is regular.

1. INTRODUCTION

Oriented matroids are ordinary matroids equipped with extra sign data, which capture and extend the combinatorics of directed graphs, real hyperplane arrangements, and more generally linear dependence over \mathbb{R} . They appear in many subjects in mathematics and related areas, from discrete geometry and optimization algorithms to algebraic geometry and topology; we refer the reader to [5, Chapter 1 & 2] for more examples. Besides having various equivalent combinatorial axiom systems, a major result in the theory of oriented matroids is the *Topological Representation Theorem* of Folkman and Lawrence [12], which states that every oriented matroid can be represented by a *pseudosphere arrangement* (a topological generalization of real hyperplane arrangements) and vice versa.

Inspired by the work of Sturmfels and Zelevinsky on maximal minors, and connections with tropical geometry and optimization problems, the authors of the current paper introduced in [7] a construction of (uniform) oriented matroids from triangulations of $\Delta_{d-1} \times \Delta_{n-1}$ with suitable sign data. While the case of regular triangulations is implicit in the literature using *signed tropicalization*, considering general triangulations allows us to obtain non-realizable oriented matroids, including Ringel's classical example (see [7, Section 4.2]). The construction given in [7] expresses an oriented matroid using a chirotope, which assigns signs to the ordered bases of the underlying matroid. More precisely, by encoding the cells of the triangulations by forests of the complete bipartite graph $K_{d,n}$, every basis is associated with a matching, and the sign of the basis is the sign of the matching as a permutation. However, in view of the polyhedral structure of a triangulation, it is natural to ask whether the topological realization of such oriented matroids can be related to the triangulation directly. In this paper, we provide a construction to achieve this.

2020 *Mathematics Subject Classification.* 52C40; 05E45, 14T15, 52C30, 57N60, 57Q99 .

Key words and phrases. oriented matroid, triangulation, product of simplices, tropical oriented matroid, topological representation theorem, pseudosphere arrangement, patchworking, PL-topology, poset topology, poset quotient .

To do so, we adapt the method of patchworking, which goes back to Viro in the 1980s [31]. Viro’s method has numerous applications in real algebraic geometry and tropical geometry (see the survey by Viro [32]¹), and is related to the Gelfand–Kapranov–Zelevinsky theory [14]. The idea of (combinatorial) patchworking is that one can construct piecewise linear objects isotopic to real algebraic varieties by some “cut and paste” procedure, starting with a *regular* subdivision of a Newton polytope with sign data. Sturmfels used this idea in [30] to study complete intersections, where mixed subdivisions play the crucial role to derive the structure of the intersecting hypersurfaces. While the latter are focused on the study of the intersections, we deal with the whole cellular complex cut out by them.

Theorem A. *Given a fine mixed subdivision of $n\Delta_{d-1}$ and a sign matrix, we can construct a pseudosphere arrangement representing the oriented matroid in [7] via a patchworking procedure.*

From this patchworking procedure, we implicitly derive an abstract real phase structure in the sense of [4, 27] from the interplay of the subdivision and the sign matrix. Since most works on patchworking aim to construct real algebro geometric objects, their proofs usually use *tropicalization* of polynomials or similar techniques. In contrast, the aforementioned non-realizable example shows that we can produce non-algebro geometric objects. This suggests that patchworking could be applied for other topological problems beyond tropicalization.

Our proof uses a combination of combinatorial and topological methods, and is loosely based on Horn’s second Topological Representation Theorem for tropical oriented matroids [18]. Roughly speaking, we show that it is possible to interpolate between the dual complex of a patchworking complex, which may be regarded as a cell decomposition of the boundary of the sphere, and a pseudosphere arrangement representing our oriented matroid. This is done by carefully “merging” cells together, ensuring at each step that the combinatorics and the topology are controlled. A similar technique was used by Hersh in her work on total positivity [17]. Actually, our results imply a “Topological Representation Theorem” for each interpolation step between Horn’s result and the result of Folkman and Lawrence.

We note the work of De Loera and Wicklin in [10] which extends and studies patchworking in dimension two giving rise to a combinatorial version of Hilbert’s Lemma. Furthermore, Itenberg and Shustin derive for dimension two in [20] that patchworking with arbitrary subdivisions produces real pseudoholomorphic curves. However, it seems not much work on patchworking with general subdivisions has been done in higher dimension before us.

The paper is organized as follows. In Section 2, we collect essential definitions and background for the central objects in this paper, as well as a summary of results from [7] which are needed in this part. Section 3 is devoted to stating the main theorem, Theorem A, and contains an illustration of the rank 3 case. Sections 4 and 5 elaborate on the two main ingredients in the proof of Theorem A, namely *elimination systems* and *quotients of regular cell complexes*. The main theorem itself is proved in Section 6. The dependencies of each of the sections on each other are shown below:

¹The title of our paper is inspired by the title of this survey.

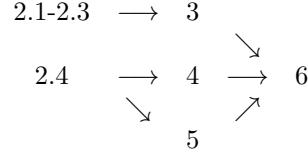

2. BACKGROUND

Throughout the paper, we fix a ground set E of size n and a set R of size $d \leq n$. We often identify E, R with $[n] = \{1, 2, \dots, n\}$ and $[d]$, hence fixing an ordering for them. We use $\{+, -, 0\}$ and $\{1, -1, 0\}$ for signs interchangeably, and we adopt the ordering $+, - > 0$ of signs. This is extended componentwise to a partial order on sign vectors. For a sign vector X and a sign $s \in \{+, -, 0\}$, we denote by X^s the set of all indices e such that $X_e = s$.

2.1. Oriented Matroids. We refer the reader to [5] for a comprehensive survey on oriented matroids.

Definition 2.1. A *chirotope* on E of rank d is a non-zero, alternating map $\chi : E^d \rightarrow \{+, -, 0\}$ that satisfies the *Grassmann–Plücker (GP) relation*:

For any $x_1, \dots, x_{d-1}, y_1, \dots, y_{d+1} \in E$, the $d + 1$ expressions

$$(-1)^k \chi(x_1, \dots, x_{d-1}, y_k) \chi(y_1, \dots, \widehat{y}_k, \dots, y_{d+1}), \quad k = 1, \dots, d + 1,$$

either contain both a positive and a negative term, or are all zeros. Here \widehat{y}_k means that we remove y_k from the list.

By the alternating property, we can specify a chirotope by its values over all d -tuples of strictly increasing elements, which are identified with d -subsets of E .

For the purpose of topological constructions, we switch to an alternative axiom system. We recall that the *composition* $X \circ Y$ of two signed vectors agrees with X in all positions $e \in E$ with $X_e \neq 0$, and agrees with Y otherwise.

Definition 2.2. A collection of sign vectors $\mathcal{L} \subset \{+, -, 0\}^E$ is the collection of *covectors* of an oriented matroid if

- (1) $\mathbf{0} \in \mathcal{L}$.
- (2) If $X \in \mathcal{L}$, then $-X \in \mathcal{L}$.
- (3) If $X, Y \in \mathcal{L}$, then $X \circ Y \in \mathcal{L}$.
- (4) For any $X, Y \in \mathcal{L}$ and $e \in X^+ \cap Y^-$, there exists $Z \in \mathcal{L}$ such that $Z_e = 0$, and $Z_f = (X \circ Y)_f = (Y \circ X)_f$ for all f for which the latter equality holds.

Example 2.3. Let M be an oriented matroid realized by the real matrix $A \in \mathbb{R}^{d \times n}$, i.e.,

$$\chi(j_1, j_2, \dots, j_d) = \text{sign det} \left(a^{(j_1)}, a^{(j_2)}, \dots, a^{(j_d)} \right).$$

The covectors of M are precisely the sign patterns of the vectors in the row space of A .

Finally, we give the definition of pseudosphere arrangements in the statement of the Topological Representation Theorem mentioned in the introduction.

Definition 2.4. A *pseudosphere arrangement* of rank d is a collection $(S_e : e \in E)$ of $(d-2)$ -spheres piecewise-linearly (PL), central symmetrically embedded on S^{d-1} together with sign data, i.e., for each S_e , specify a positive and a negative side for the two connected components of $S^{d-1} \setminus S_e$. Furthermore, we require that for any $E' \subset E$, $S_{E'} := \bigcap_{e \in E'} S_e$ is also a PL sphere, and that for every other S_e , either $S_{E'} \subset S_e$ or $S_{E'} \cap S_e$ is a PL sphere of codimension 1 within S_e .

The face lattice of such an arrangement is isomorphic to the *covector lattice* of the oriented matroid; we again refer the reader to [5, Chapter 5] for details.

2.2. Triangulations of $\Delta_{d-1} \times \Delta_{n-1}$ and Polyhedral Matching Fields. We refer the reader to [9], respectively [7, 24], for details in polyhedral geometry and matching fields. We denote the $(k-1)$ -simplex, respectively the product of a $(d-1)$ -simplex and an $(n-1)$ -simplex, by Δ_{k-1} and respectively $\Delta_{d-1} \times \Delta_{n-1}$. We fix their embeddings in \mathbb{R}^k (respectively $\mathbb{R}^d \times \mathbb{R}^n$) as $\text{conv}\{\mathbf{e}_i : i \in [k]\}$ (respectively $\text{conv}\{\mathbf{e}_i, \mathbf{e}_j : i \in [d], j \in [n]\}$).

A collection \mathcal{T} of full-dimensional simplices is a *triangulation* of $\Delta_{d-1} \times \Delta_{n-1}$ if

- (1) the vertices of each simplex is a subset of the vertices of $\Delta_{d-1} \times \Delta_{n-1}$,
- (2) the union of all simplices in \mathcal{T} is $\Delta_{d-1} \times \Delta_{n-1}$,
- (3) the intersection of any two simplices in \mathcal{T} is a common face of them.

By identifying the vertices of $\Delta_{d-1} \times \Delta_{n-1}$ with the edges of the complete bipartite graph $K_{R,E}$, each full-dimensional simplex satisfying (1) gives rise to a spanning tree of $K_{R,E}$. A combinatorial characterization of when a collection of trees forms a triangulation is given in [1, Proposition 7.2].

Definition 2.5 ([7, Section 2.3]). A *polyhedral matching field* is the collection of all R -saturating matchings (those covering all nodes in R) that are subgraphs of the trees encoding a triangulation of $\Delta_{d-1} \times \Delta_{n-1}$, which consists of exactly one perfect matching M_σ between R and σ for every d -subset $\sigma \subset E$.

We describe another (larger) matching field induced from a triangulation, which comprises the full information of the original triangulation. We augment the ground set E by a copy \tilde{R} of R to obtain a ground set \tilde{E} of size $n+d$, and we set all elements of \tilde{R} to be smaller than all elements of E . The collection $\tilde{\mathcal{T}}$ contains, for every tree T in \mathcal{T} , the tree on $R \sqcup \tilde{E}$ obtained from T by adding an edge between i and its copy for every $i \in R$.

Definition 2.6. The *pointed polyhedral matching field* associated with a triangulation \mathcal{T} of $\Delta_{d-1} \times \Delta_{n-1}$ is the collection of R -saturating matchings on $R \sqcup \tilde{E}$ that are subgraphs of the trees in $\tilde{\mathcal{T}}$.

The *Cayley trick* [29] establishes a bijective correspondence between triangulations of $\Delta_{d-1} \times \Delta_{n-1}$ and *fine mixed subdivisions* of the dilated simplex $n\Delta_{d-1}$ as follows: For each tree G corresponding to a simplex in the triangulation \mathcal{T} , we form the Minkowski sum

$$\sum_{j \in E} \text{conv}\{\mathbf{e}_i : i \in \mathcal{N}_G(j)\} ,$$

where $\mathcal{N}_G(j)$ is the neighbourhood of an element $j \in E$ in G . The collection of these Minkowski sums tiles $n\Delta_{d-1}$.

In [2], Ardila and Develin studied the dual of these mixed subdivisions as *tropical pseudohyperplane arrangements*, which generalizes tropical hyperplane arrangements as the dual of coherent mixed subdivisions [11]. In [18, 26], it was shown that these objects are equivalent to *tropical oriented matroids*, defined by purely combinatorial axioms back in [2].

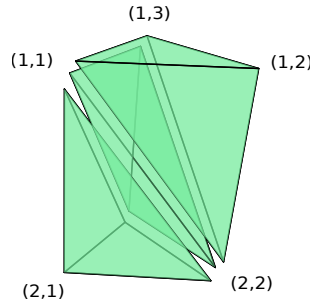

FIGURE 1. A triangulation of $\Delta_1 \times \Delta_2$. The vertices are labeled by the corresponding edges in $K_{2,3}$. This picture was created with `polymake` [13].

2.3. Oriented Matroids from Triangulations of $\Delta_{d-1} \times \Delta_{n-1}$. We recall the results of [7] which are needed in this paper. For the rest of this paper, we fix a sign matrix $A \in \{-, +\}^{\mathbb{R} \times \mathbb{E}}$ and a polyhedral matching field (M_σ) extracted from a triangulation of $\Delta_{d-1} \times \Delta_{n-1}$. We also denote by (\widetilde{M}_σ) the pointed polyhedral matching field encoding the starting triangulation, and by \widetilde{A} the sign matrix $(I_{d,d}|A)$.

Using the ordering on \mathbb{R} and $\sigma \subset \mathbb{E}$, we can interpret a matching M_σ as a permutation, and we define the sign of the matching by the sign of the permutation.

Theorem 2.7. [7, Theorem A] *The sign map $\chi : \binom{\mathbb{E}}{d} \rightarrow \{+, -\}$ given by*

$$(1) \quad \sigma \mapsto \text{sign}(M_\sigma) \prod_{e \in M_\sigma} A_e ,$$

is the chirotope of an oriented matroid.

We denote the oriented matroid described by χ as \mathcal{M} . Similarly, (\widetilde{M}_σ) induces an oriented matroid $\widetilde{\mathcal{M}}$ on $\widetilde{\mathbb{E}}$.

Now, we describe how to convert cells of a fine mixed subdivision of $n\Delta_{d-1}$, as special subgraphs of $K_{\mathbb{R}, \mathbb{E}}$, into a covector of \mathcal{M} (resp. $\widetilde{\mathcal{M}}$).

Definition 2.8. [7, Definition 3.26] Given $S \in \{-1, 0, 1\}^{\mathbb{R}}$ and $F \subseteq \mathbb{R} \times \mathbb{E}$, the sign matrix $SA_F \in \{-1, 0, 1\}^{\mathbb{R} \times \mathbb{E}}$ is defined as

$$(SA_F)_{i,j} = \begin{cases} S_i A_{i,j}, & (i,j) \in F, \\ 0, & \text{otherwise.} \end{cases}$$

Definition 2.9. [7, Definition 3.27] Given a subgraph F of $K_{R,E}$ and a sign vector $S \in \{-1, 0, 1\}^R$, the sign vector $\psi_A(S, F) = Z \in \{-1, 0, 1\}^E$ is given by

$$Z_j = \begin{cases} 0, & \text{column } j \text{ of } SA_F \text{ contains positive and negative entries, or all zeros} \\ 1, & \text{column } j \text{ of } SA_F \text{ contains only non-negative entries} \\ -1, & \text{column } j \text{ of } SA_F \text{ contains only non-positive entries.} \end{cases}$$

Proposition 2.10. [7, Proposition 3.32] *Let F be a subgraph of a tree in $\tilde{\mathcal{T}}$ without isolated nodes in $E \subset \tilde{E}$, and such that a node in $\tilde{R} \subset \tilde{E}$ is isolated only if the corresponding node in R is isolated as well. Let $S \in \{-1, 0, 1\}^R$ be a sign vector whose support contains the set of non-isolated nodes of F in R .*

Then the sign vector $\psi_{\tilde{A}}(S, F)$ is a covector of $\tilde{\mathcal{M}}$.

Corollary 2.11. [7, Corollary 3.33] *For a subgraph F of a tree in \mathcal{T} with no isolated node in E , the sign vector $\psi_A(S, F)$ is a covector of \mathcal{M} for every sign vector S .*

Note that the latter subgraphs are called *covector pd-graphs* in [7].

2.4. Poset and Lattice Quotients. The following definition is due to Hallam and Sagan [15], which proved useful in their work on factorizing characteristic polynomials of lattices. This definition turns out to be the right one for us as well.

Definition 2.12. Let P be a finite poset. An equivalence relation \sim on the ground set of P is *P-homogeneous* provided the following condition holds: if $\tau \leq \sigma$ in P , then for every $u \in \tilde{\tau}$ there exists $v \in \tilde{\sigma}$ such that $u \leq v$ in P . We denote by either $\tilde{\sigma}$ or σ/\sim the equivalence class of σ in \sim .

Proposition 2.13 ([15, Lemma 5]). *Suppose \sim is P-homogeneous. Then we have a well-defined poset P/\sim on the classes of \sim defined as follows: $\tilde{\tau} \leq \tilde{\sigma}$ in P/\sim if and only if there exists $u \in \tilde{\tau}$ and $v \in \tilde{\sigma}$ such that $u \leq v$ in P . Equivalently, for every $u \in \tilde{\tau}$ there exists $v \in \tilde{\sigma}$ such that $u \leq v$ in P .*

We call the poset P/\sim the *homogeneous quotient of P by \sim* . We are particularly interested in homogeneous quotients which have nice factorizations in the following sense:

Definition 2.14. A homogeneous quotient P/\sim is an *elementary quotient* if every equivalence class of \sim is either a singleton, or consists of exactly three elements $\sigma, \tau, \gamma \in P$ such that σ and τ both cover γ in P .

Definition 2.15. We say that P/\sim *admits a factorization into elementary quotients* if there exist posets $P = P_0, P_1, \dots, P_k = P/\sim$ such that $P_i = P_{i-1}/\sim_i$ is an elementary quotient of P_{i-1} for all $i = 1, 2, \dots, k$.

Since the following notion appears several times in this paper, we give the definition here:

Definition 2.16. The *augmented poset* of a poset P is the poset $\mathcal{L}(P) := P \cup \{\hat{\mathbf{0}}, \hat{\mathbf{1}}\}$, where $\hat{\mathbf{0}}$ and $\hat{\mathbf{1}}$ are two additional elements such that $\hat{\mathbf{0}} < \sigma < \hat{\mathbf{1}}$ for all $\sigma \in P$.

3. PATCHWORKING PSEUDOSPHERE ARRANGEMENTS

3.1. Patchworking Pseudolines on an Example. The classical theory of patchworking states that the structure of the real zero set of a polynomial in one orthant,

parameterized by $t > 0$, is captured for sufficiently small t by the regular triangulation of its Newton polytope induced by the exponents of t . Hence, one can recover the structure of the real zero set by gluing the triangulations for all orthants. This uses an appropriate assignment of signs to the vertices of the Newton polytope. By considering coherent fine mixed subdivisions, see Section 2.2, this was extended to complete intersections in [30].

We use patchworking of not-necessarily coherent fine mixed subdivisions of $n\Delta_{d-1}$ to derive a representation theorem for the oriented matroids induced from polyhedral matching fields. This can be seen as a generalization of the linear case of [30, Thm. 4] for generic hyperplane arrangements. While a complete intersection for generic hyperplanes would only yield one specific cell, the oriented matroid captures the information of all intersections in a generic hyperplane arrangement.

Example 3.1 is a toy example that illustrates our construction, which is generalized to larger E and higher rank in this section.

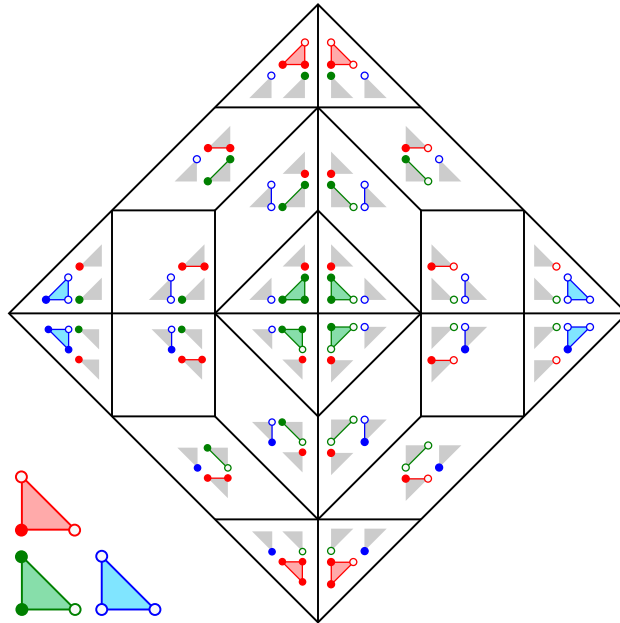

FIGURE 2. Fine mixed subdivision of $3\Delta_2$ with cells labeled by their summands and sign; filled vertices denote '+', empty ones '-'.

Example 3.1. We start with the regular triangulation of $\Delta_2 \times \Delta_2$ induced by the height matrix

$$H = \begin{pmatrix} 0 & 3 & 2 \\ 0 & 0 & 0 \\ 1 & 3 & 0 \end{pmatrix}.$$

This gives rise to the following height function on the lattice points of $3\Delta_2$:

$(300; 5), (201; 6), (210; 5), (102; 6), (111; 5), (120; 3), (003; 4), (012; 4), (021; 3), (030; 0)$

Here, the height of the lattice point (p_1, p_2, p_3) is the weight of the maximal matching on $K_{3,3}$ for which the weight function is obtained from H by taking p_ℓ copies of

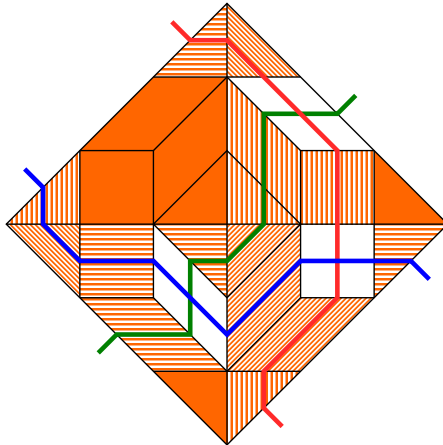

FIGURE 3. Pseudohyperplane arrangement derived from a fine mixed subdivisions of $3\Delta_2$ with signs indicated in Figure 2.

the ℓ -th row of H . Note that, alternatively, the latter height function of the mixed subdivision can be obtained by multiplying the max-tropical linear polynomials $(x_0 \oplus 3 \odot x_1 \oplus 3 \odot x_2) \odot (x_0 \oplus x_1 \oplus 2 \odot x_2) \odot (x_0 \oplus 1 \odot x_1 \oplus x_2)$. We refer the reader further interested in this connection to [22].

Additionally, we equip the subdivision by the sign matrix

$$\begin{pmatrix} - & + & - \\ + & + & - \\ - & - & - \end{pmatrix}.$$

The fine mixed subdivision of $3\Delta_2$ induced by H is shown in the upper-right quartile of Figure 2. The cells are labeled by their Minkowski summands (cf. the Cayley trick in Section 2.2) as follows. The elements of \mathbf{E} (as the three columns from left to right) are represented by the red, green, and blue simplices, respectively; the elements of \mathbf{R} (as the three rows from top to bottom) are represented by the top, lower-left, and right vertices of each simplex, respectively. Furthermore, the vertices of these simplices are labeled with signs coming from the sign matrix.

The faces of a mixed cell correspond to the subgraphs of its spanning tree without isolated nodes in \mathbf{E} . In particular, a vertex of a mixed cell can be specified by choosing a vertex from each colored simplex, thus it encodes a sign vector $\{+, -\}^{\mathbf{E}}$. Such a forest associated with a vertex is independent of the mixed cell containing it. Hence, we have a well-defined assignment of sign vectors to the vertices of the mixed subdivision. For example, the lower left vertex v of the square in the upper-right quartile of Figure 2 is the Minkowski sum of a filled red vertex, an empty green and an empty blue vertex. Therefore, it encodes the sign vector $(+, -, -)$.

Next we reflect the dilated simplex across the coordinate hyperplanes in \mathbb{R}^3 so that there is a copy in every octant². We keep the same subdivision in all copies and label the vertices of these copies with sign vectors similar to the above, but instead of the original sign matrix, we negate a row of it if the corresponding coordinate in

²We only show the upper half of that *patchworking complex* in Figure 2 as the construction is centrally symmetric.

the octant is negative. For the vertex v , e. g., this yields $(+, +, -)$ for its reflection in the upper-left quartile of Figure 2. Again, the sign vector assigned to a vertex that appears in multiple copies of the dilated simplex is independent of the copy chosen: whenever a vertex lies on a hyperplane $\{x_i = 0\}$, the i -th node of R must be an isolated one in the forest corresponding to the vertex, thus the negation of the i -th row does not affect the sign vector.

As our example is of rank 3, we obtain a subdivision of the boundary of a dilated octahedron (which is PL homeomorphic to S^2), with vertices of the subdivision labeled by sign vectors.

Finally, we define a “zero locus” for each element $e \in E$ as a subset of the patchworking complex. This zero locus is dual to the cells which have a Minkowski summand with vertices of different sign. Given a cell of the subdivision, select the edges (one-dimensional faces) of the cell in which the sign vectors of their endpoints disagree on the e -th coordinate, and take the convex hull of the midpoints of them. Take the union of all such convex hulls, it can be seen from Figure 3 that each of such “zero loci” is a pseudosphere on the patchworking complex.

Note that the boundary of $3\Delta_2$ in \mathbb{R}^3 can be seen as the intersection with the three hyperplanes bounding the non-negative orthant. Extending these through the reflections of $3\Delta_2$ yields three further pseudospheres. This gives rise to an interpretation of Figure 3 as an arrangement of six pseudospheres. By ‘fattening’ the latter three coordinate pseudospheres we arrive at the *extended patchworking complex* introduced in the next section.

Remark 3.2. Since oriented matroids coming from regular triangulations are all realizable, the pseudosphere arrangements constructed from a coherent fine mixed subdivision are all stretchable, which gives some non-trivial structural constraints on coherence.

We recall the example from [7] that treats Ringel’s non-realizable uniform oriented matroid \mathbf{R} of rank 3 on 9 elements. It can be realized by patchworking a suitable non-coherent fine mixed subdivision of $6\Delta_2$ and choosing appropriate signs as depicted in Figure 4. It is not clear to the authors, if the oriented matroid \mathbf{R} can be constructed from another non-coherent fine mixed subdivision of $6\Delta_2$.

It is an interesting experimental question of which of the 24 (non-isomorphic) non-realizable oriented matroids of rank 4 on 8 elements arise from the non-regular triangulation constructed by de Loera in [8] or its modifications by choosing appropriate signs.

Remark 3.3. It is also an interesting problem to interpret our construction here as a limit with respect to some one-dimensional family of (meaningful) geometric objects; the regular (and non-singular) case is closely related to the theory of amoebas [25]. The rank 3 case is worth to put emphasis on, not only because it is already combinatorially rich enough, but the work of Ruberman–Starkton indicates that every pseudoline arrangement can be complexified into an arrangement of symplectic spheres [28], hence suggesting a symplectic flavored answer here (see also the aforementioned work of Itenberg–Shustin [20]).

3.2. From Fine Mixed Subdivisions to Pseudosphere Arrangements. We now state precisely our method for constructing a pseudosphere arrangement representing an oriented matroid associated to a polyhedral matching field. For this, we fix a fine mixed subdivision \mathcal{S} of $n\Delta_{d-1}$. By the Cayley trick, this corresponds to

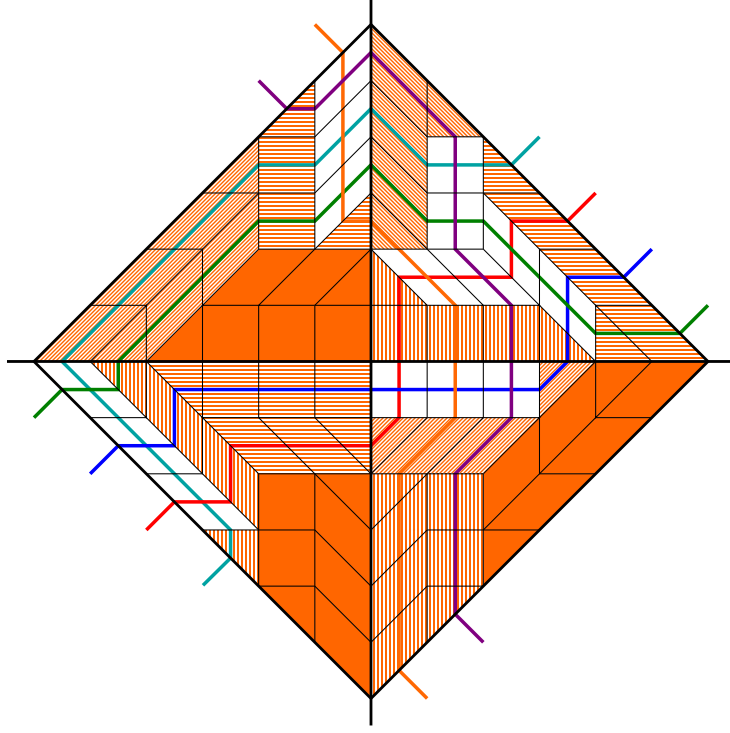

FIGURE 4. Non-coherent fine mixed subdivision of $6\Delta_2$ patch-working the Ringel arrangement discussed in Remark 3.2.

a triangulation \mathcal{T} of $\Delta_{d-1} \times \Delta_{n-1}$. By means of Definition 2.6, it gives rise to a pointed polyhedral matching field (\widetilde{M}_σ) on $\mathbb{R} \sqcup \widetilde{E}$ with $\widetilde{E} = \widetilde{R} \cup E$. For an arbitrary matrix $A \in \{+, -\}^{\mathbb{R} \times E}$, we consider the augmented matrix $\widetilde{A} = (I_{\mathbb{R}} \mid A)$ as sign matrix for (\widetilde{M}_σ) . Let $\widetilde{\mathcal{M}}$ denote the oriented matroid on $\widetilde{E} = \widetilde{R} \cup E$ associated to the pointed polyhedral matching field (\widetilde{M}_σ) with the sign matrix \widetilde{A} , and let \mathcal{M} be its restriction to E .

Recall from Section 2.2 that we may identify the maximal simplices in \mathcal{T} with spanning trees of $K_{\mathbb{R}, E}$. The cells σ_F of \mathbf{S} are in 1-1 correspondence with the forests F contained in a spanning tree of \mathcal{T} for which $\deg_F(j) \geq 1$ for all $j \in E$.

We denote the cube $[-1, 1]^d \subset \mathbb{R}^d$ and its polar dual, the crosspolytope, by \square_d and \diamond_d , respectively. For a sign vector $S \in \{-1, 0, 1\}^d$ and a set K contained in the coordinate subspace $\mathbb{R}^{\text{supp}(S)} \times \{0\}^{\overline{\text{supp}(S)}}$ of \mathbb{R}^d , define

$$S \cdot K := \{(S_1 x_1, \dots, S_d x_d) \in \mathbb{R}^d : (x_1, \dots, x_d) \in K\}$$

$$\square_S := \{x \in \square_d : x_i = S_i \text{ for all } i \in \text{supp}(S)\}.$$

Hence, $S \cdot K$ denotes the reflections of K to the orthant indicated by S , and \square_S comprises the sign patterns of orthants containing the sign vector S . For a subgraph F of $K_{\mathbb{R}, E}$, let $\text{supp}_{\mathbb{R}}(F) := \{i \in \mathbb{R} : \deg_F(i) \geq 1\}$. This set encodes the unique minimal face of $n\Delta_{d-1}$ containing F .

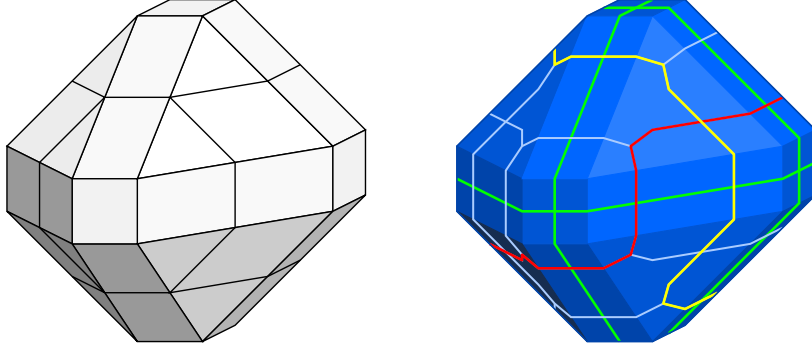

FIGURE 5. The complex $\bigcirc_{\mathbf{S}}$ (left) and its dual $\Delta = \bigcirc_{\mathbf{S}}^{\vee}$ (right). The five subcomplexes of Δ that yield pseudospheres are highlighted: there are three of the form Δ_i , $i \in \tilde{\mathbf{R}}$ (shown in green) and two of the form Δ_j , $j \in \mathbf{E}$ (shown in red and yellow).

Proposition 3.4. *The subdivision \mathbf{S} of $n\Delta_{d-1}$ gives rise to the subdivision*

$$\bigcirc_{\mathbf{S}} := \{\sigma_{(S,F)} : \sigma_F \in \mathbf{S}, S \in \{-1, 0, 1\}^{\mathbf{E}}, \text{supp}(S) \supseteq \text{supp}_{\mathbf{R}}(F)\}$$

of the boundary of $\bigcirc_d := \square_d + n\Diamond_d$, where $\sigma_{(S,F)} := \square_S + S \cdot \sigma_F$.

We call the complex arising in the latter Proposition the *extended patchworking complex*; we prove the statement together with more technical properties of the extended patchworking complex in Section 6.1. This complex is analogous to the complex Δ'_ω defined in [30, Theorem 5], with additional cells that are dual to the coordinate hyperplanes of \mathbb{R}^d . The extended patchworking complex subdivides the boundary of a polytope, and is therefore a PL sphere. Hence, we may consider its dual complex

$$\Delta := \bigcirc_{\mathbf{S}}^{\vee} := \{\sigma_{(S,F)}^{\vee} : \sigma_{(S,F)} \in \bigcirc_{\mathbf{S}}\}.$$

The realization of the poset as a polyhedral cell complex is further explained in Section 5.1. For $i \in \tilde{\mathbf{R}}$ and $j \in \mathbf{E}$, define the subcomplexes

- (2) $\Delta_i := \{\sigma_{(S,F)}^{\vee} \in \Delta : i \notin \text{supp}(S)\},$
- (3) $\Delta_j := \{\sigma_{(S,F)}^{\vee} \in \Delta : \text{there exist edges } (i, j), (\ell, j) \text{ in } F$
such that $S_i A_{i,j} = -S_\ell A_{\ell,j} \neq 0\}.$

Recall the notion of a pseudosphere arrangement from Definition 2.4.

Theorem 3.5. *The spaces $\|\Delta_k\|$ ranging over all $k \in \tilde{\mathbf{E}}$ form an arrangement of pseudospheres within $\|\Delta\|$ representing the oriented matroid $\tilde{\mathcal{M}}$.*

Deleting the pseudospheres $\|\Delta_i\|$ for $i \in \tilde{\mathbf{R}}$ yields the following.

Corollary 3.6. *The spaces $\|\Delta_j\|$ ranging over all $j \in \mathbf{E}$ form an arrangement of pseudospheres representing the oriented matroid \mathcal{M} .*

3.3. Overview of the Proof of Theorem 3.5. Before getting into the technical details of our proof, we explain the overall picture. The codimension one skeleton of Δ in each orthant is a tropical pseudohyperplane arrangement in the sense of [2], that is, a union of PL homeomorphic images of tropical hyperplanes (codimension one skeleton of Δ_{d-1}^\vee). Including the sign data, each Δ_k restricted to an orthant is either empty or is (the boundary of) a *tropical (pseudo)halfspace* in the sense of [21]. The latter is obtained from a tropical pseudohyperplane by removing the facets that lie between two regions of the same sign. As such, the arrangement of Δ_k 's can be thought as the end product of a facet removal process for multiple tropical pseudohyperplanes across multiple orthants.

Using the results from [7] (as summarized in Section 2.3 here), we can show that the face poset of the arrangement of Δ_k 's equals the covector lattice of \mathcal{M} . The challenge now becomes topological: we need to make sure that the facet removal process does not create pathologies, so the topological structure reflects the combinatorial structure. Our approach is to formulate this process as a stepwise cell merging process, using the formalism of regular cell complexes. The removal of a facet determines an equivalence relation on the cells of the tropical pseudohyperplane arrangement: two cells are equivalent if their interiors intersect the interior of a common cell once the facet is removed. By taking the union of the cells in each equivalence class, we show that we get another regular cell complex with the same underlying topological space. Iterating this procedure, we show that we end up at a regular cell complex. Since the face poset of a regular cell complex determines the complex up to cellular homeomorphism, this completes the proof. Figure 6 depicts a two-dimensional example where naïve cell merging does not preserve regularity, hence justifying the technical work here.

Hersh describes a similar step-by-step process in [17, §4] to simplify a regular cell complex while preserving homeomorphism type. Her single step involves collapsing a single cell to a cell on the boundary, while ours involves merging two neighbouring cells together. Thus, in some sense, her approach might be considered dual to ours.

We remark that the work in this section is very closely related to the work done by Horn in [18, Chapter 6]. Indeed, one approach to proving Theorem 3.5 is to directly use her second Topological Representation Theorem for tropical oriented matroids. Taking this approach, one would then show that the 2^d affine pseudohyperplane arrangements guaranteed by Horn's theorem (some can be empty) glue together to form a pseudosphere arrangement, and that this pseudosphere arrangement represents the desired oriented matroid \mathcal{M} .

However, one of our goals in this paper is to furnish a proof of Theorem 3.5 that is almost entirely combinatorial. We achieve this by making use of the correspondence between tropical hyperplane arrangements and generic tropical oriented matroids, as well as the correspondence between a regular cell complex and its face poset. In particular, we show how the *elimination axiom* of tropical oriented matroids enables our cell merging process to work, which might lead to extensions of our method.

3.4. Relation to Real Bergman Fan and Complex. To close this section, we sketch the relation of our construction with the *real Bergman fan* of the oriented matroid, considered by the first author in [6, Chapter 2]. The real Bergman fan generalizes to oriented matroids the more well-known *Bergman fan* of a matroid, which is itself the tropical analogue of a linear subspace. In particular, the Bergman

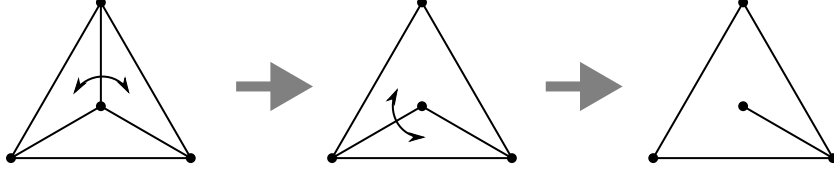

FIGURE 6. Two cell-merging steps of a planar embedding of the complete graph K_4 into the plane. The first merging step results in a regular CW complex, however the second does not.

fan of a matroid is the union of cones taken over all flags of flats, whereas the real Bergman fan is the union of cones over all flags of *conformal covectors*:

Definition 3.7. Let \mathcal{L} be the collection of nonzero covectors of an oriented matroid \mathcal{M} . Identify each sign vector $X \in \mathcal{L}$ with its associated lattice point $\mathbf{e}_X \in [-1, 1]^E \cap \mathbb{Z}^E$. Then the *real Bergman fan* $\Sigma_{\mathcal{M}}^*$ of \mathcal{M} is the collection of all cones of the form

$$\text{cone}\{\mathbf{e}_{X_1}, \dots, \mathbf{e}_{X_k}\} \subset \mathbb{R}^E$$

where $X_1 < \dots < X_k$ and each $X_i \in \mathcal{L}$. The *real Bergman complex* $\Delta_{\mathcal{M}}^*$ of \mathcal{M} is the intersection of $\Sigma_{\mathcal{M}}^*$ with the boundary of the hypercube $[-1, 1]^E$.

We note that, after taking the componentwise logarithm, the real Bergman fan (resp. complex) restricted positive orthant coincides with the positive Bergman fan (resp. complex) considered by Ardila, Klivans, and Williams [3]. Conversely, the real Bergman fan can be recovered from the positive Bergman fans of all reorientations of \mathcal{M} . Such fans were used in the realizable setting by Jürgens in [23]. See [6, Chapter 2.4] for further combinatorial properties of the real Bergman fan.

The complex $\Delta_{\mathcal{M}}^*$ is a geometric realization of the order complex of \mathcal{L} . Hence, a direct consequence of the Topological Representation Theorem is that this complex is PL homeomorphic to a sphere of dimension $d - 1$, and its intersection with the coordinate hyperplanes of \mathbb{R}^E are the pseudospheres representing the elements. It is therefore natural to ask if there is a piecewise linear map from the extended patchworking complex $\Delta = \bigcirc_{\mathbb{S}}^{\vee}$ defined in Section 3.2 to the real Bergman complex of the associated oriented matroid $\widetilde{\mathcal{M}}$, one which respects the pseudosphere arrangement structure. This can indeed be carried out; we omit the details as they are routine:

Proposition 3.8. Define the following map on the vertices $\sigma_{(S,F)}$ of $\bigcirc_{\mathbb{S}}$ into $\mathbb{R}^{\widetilde{E}}$:

$$\sigma_{(S,F)} \mapsto (S, \mathbf{1}^{\top}(SA_F)) \in \mathbb{R}^{\widetilde{E}}.$$

Here SA_F is the matrix as in Definition 2.8, and $\mathbf{1}$ denotes the vector of all ones. Extend this map linearly on each maximal cell of $\bigcirc_{\mathbb{S}}$, to get a map

$$\|\Delta\| = \|\bigcirc_{\mathbb{S}}\| \rightarrow \mathbb{R}^{\widetilde{E}}.$$

Then this map is well defined, and the image of this map is precisely $\Delta_{\widetilde{\mathcal{M}}}^*$.

Furthermore, the choices implicit in the construction of $\bigcirc_{\mathbb{S}}^{\vee}$ can be made so that this map respects the cellular structure of the pseudosphere arrangement $\|\Delta_k\|$ over all $k \in \widetilde{E}$ as given by Theorem 3.5, and the pseudosphere arrangement obtained by intersecting $\Delta_{\widetilde{\mathcal{M}}}^*$ with each of coordinate hyperplane of $\mathbb{R}^{\widetilde{E}}$.

Example 3.9. In Figure 4, the map can be visualized as contracting each shaded cell to a point, and each striped cell into a segment by contracting each stripe to a point on that segment.

4. ELIMINATION SYSTEMS

In order to interpolate between fine mixed subdivisions and oriented matroid covectors, we consider a generalization of the set of forests arising from a fine mixed subdivision which we call an *elimination system*. The main result in this section is Theorem 4.12, which states that a particular poset quotient associated to an elimination system admits a factorization into elementary quotients, as defined in Section 2.4.

4.1. Elimination Systems and their posets. For a subgraph $F \subseteq R \times E$ of the complete bipartite graph $K_{R,E}$ and $j \in E$, define the neighbourhood $F_j := \{i : (i, j) \in F\}$.

Definition 4.1. Let \mathbf{S} be a collection of subsets of $R \times E$. Then \mathbf{S} is an *elimination system* provided:

- (E1) For each $F \in \mathbf{S}$ and for each $j \in E$, F_j is non-empty.
- (E2) If $F \subseteq G \in \mathbf{S}$ and F_j is non-empty for all $j \in E$, then $F \in \mathbf{S}$.
- (E3) If $F, G \in \mathbf{S}$ and $j \in E$, then there exists $H \in \mathbf{S}$ such that $H_j = F_j \cup G_j$ and $H_k \in \{F_k, G_k, F_k \cup G_k\}$ for all $k \in E$ with $k \neq j$.

Elimination systems are the same as generic tropical oriented matroids except without the comparability axiom; see [2, Definition 3.5].

Generalizing the face poset of the polyhedral complex of Proposition 3.4 subdividing the boundary of $\bigcirc_d := \square_d + n\blacklozenge_d$, we introduce a poset associated with an elimination system.

Definition 4.2. Given an elimination system \mathbf{S} , we define the following poset:

$$\mathbf{P}(\mathbf{S}) := \{(S, F) : S \in \{-1, 0, 1\}^R, F \in \mathbf{S}, \text{supp}(S) \supseteq \text{supp}_R(F)\}.$$

Recall from Proposition 3.4 that $\text{supp}_R(F)$ denotes those $i \in R$ such that $(i, j) \in F$ for at least one $j \in E$. The ordering of the poset $\mathbf{P}(\mathbf{S})$ is given as follows: $(S, F) \leq (T, G)$ if and only if $S \leq T$ and $F \subseteq G$. Recall that here $S \leq T$ means that S is obtained from T by setting some entries to zero. For example, $0 - 0+ \leq + - -+$; another way to see it is that the orthant labeled by S is contained in the orthant labeled by T .

4.2. An Equivalence Relation of $\mathbf{P}(\mathbf{S})$. Let Π be a partition of a finite set K . We say that two sign vectors $X, Y \in \{-1, 0, 1\}^K$ are *equivalent* (with respect to Π), and write $X \sim Y$, if for all $s \in \{-, +\}$ and $\pi \in \Pi$, we have $X^s \cap \pi$ is nonempty iff $Y^s \cap \pi$ is nonempty. For example, the following two sign vectors are equivalent with respect to the indicated partition of the coordinates:

$$\begin{array}{l} X : \\ Y : \end{array} \begin{array}{|c|c|c|c|c|c|c|c|c|c|} \hline 0 & + & 0 & - & 0 & 0 & + & - & 0 & 0 & 0 & + & + \\ \hline 0 & + & - & 0 & 0 & - & + & 0 & + & + & 0 & + & 0 \\ \hline \end{array}$$

This defines an equivalence relation on $\{-1, 0, 1\}^K$. We may think of each equivalence class X/\sim of this equivalence relation as a sign vector in $\{0, +, -, \pm\}^\Pi$. For the above example, this would look like

$$X/\sim = Y/\sim: \begin{array}{|c|c|c|c|c|} \hline 0 & + & - & \pm & + \\ \hline \end{array}$$

Recall the construction of the sign matrix SA_F associated with a sign vector S and a graph F on $\mathbf{R} \sqcup \mathbf{E}$ from Definition 2.8. We introduce an equivalence relation \sim_A based on the set of signs in each column of the sign matrix SA_F .

Definition 4.3. Let $\Pi := \{\mathbf{R} \times \{j\} : j \in \mathbf{E}\}$ be a partition of the edges of $K_{\mathbf{R}, \mathbf{E}}$. Define the following equivalence relation \sim_A on $\mathbf{P}(\mathbf{S})$: Given (S, F) and (T, G) in $\mathbf{P}(\mathbf{S})$, we say that $(S, F) \sim_A (T, G)$ if $S = T$ and $SA_F \sim SA_G$ with respect to the partition of $\mathbf{R} \times \mathbf{E}$ given by Π .

Example 4.4. Depicted below are four elements from the poset $\mathbf{P}(\mathbf{S})$ for Example 3.1. We show each element (S, F) as (S, SA_F) , noting that $F = \text{supp}(SA_F)$:

$$\begin{aligned} (S_1, S_1 A_{F_1}) &= \left(\begin{pmatrix} - \\ + \\ + \end{pmatrix}, \begin{pmatrix} + & - & + \\ + & 0 & 0 \\ - & 0 & 0 \end{pmatrix} \right), (S_2, S_2 A_{F_2}) = \left(\begin{pmatrix} - \\ + \\ + \end{pmatrix}, \begin{pmatrix} 0 & - & + \\ + & 0 & 0 \\ - & - & 0 \end{pmatrix} \right), \\ (S_3, S_3 A_{F_3}) &= \left(\begin{pmatrix} - \\ + \\ + \end{pmatrix}, \begin{pmatrix} 0 & 0 & + \\ + & 0 & - \\ - & - & 0 \end{pmatrix} \right), (S_4, S_4 A_{F_4}) = \left(\begin{pmatrix} + \\ + \\ + \end{pmatrix}, \begin{pmatrix} 0 & 0 & - \\ + & 0 & - \\ - & - & 0 \end{pmatrix} \right). \end{aligned}$$

Observe that these four sign vectors correspond to four full-dimensional cells in Figure 2, of which three are in the lower right orthant and the last is in the upper right orthant. They correspond to cells following the red pseudoline in Figure 3, starting from the triangle in the lower right orthant. We see right away that $(S_4, F_4) \not\sim_A (S_\ell, F_\ell)$ for $\ell = 1, 2, 3$ as they differ in the first component. To check for the equivalence of the other three pairs, we can consider the image of the columns of $S_1 A_{F_1}, S_2 A_{F_2}, S_3 A_{F_3}$ to $\{0, +, -, \pm\}^3$ as indicated before Definition 4.3. This yields the three vectors $(\pm, -, +), (\pm, -, +), (\pm, -, \pm)$. Hence, we get $(S_1, F_1) \sim_A (S_2, F_2) \sim_A (S_3, F_3)$.

4.3. Properties of the Quotient $\mathbf{P}(\mathbf{S})/\sim_A$. We assume we are given an elimination system \mathbf{S} on $\mathbf{R} \times \mathbf{E}$, and a sign matrix $A \in \{-1, 1\}^{\mathbf{R} \times \mathbf{E}}$. We denote the poset $\mathbf{P}(\mathbf{S})$ by \mathbf{P} .

Proposition 4.5. *Suppose (S, F) is covered by (T, G) in \mathbf{P} . Then either $F = G$ and $|S| = |T| - 1$, or $S = T$ and $|F| = |G| + 1$.*

Proof. The fact that $(S, F) \leq (T, G)$ means that $S \leq T$ and $F \supseteq G$, and either $S \leq T$ or $F \supseteq G$. If $S \leq T$, then let $i \in \text{supp}(T) \setminus \text{supp}(S)$. Then $i \notin \text{supp}(S)$, which means $i \notin \text{supp}_R(F)$. Since $F \supseteq G$, this means $i \notin \text{supp}_R(G)$. Hence, $(T \setminus i, G)$ is an element of \mathbf{P} such that

$$(S, F) \leq (T \setminus i, G) \leq (T, G).$$

Since (S, F) is covered by (T, G) , we conclude the first inequality holds with equality, and hence $F = G$ and $|S| = |T| - 1$.

Otherwise, $F \supseteq G$. Let $(i, j) \in F \setminus G$. Then (i, j) is not the only element of F_j , since otherwise we would have $G_j = \emptyset$ which is forbidden by (E1). We therefore have $(S, F \setminus (i, j)) \in \mathbf{P}$ by (E2), and hence

$$(S, F) \leq (S, F \setminus (i, j)) \leq (T, G).$$

By covering, we conclude the second inequality holds with equality, and hence $S = T$ and $|F| = |G| - 1$. \square

Corollary 4.6. *The poset P is graded, with grading $\rho(S, F) = n + |S| - |F|$.* \square

Given two sign vectors $S, T \in \{-1, 0, 1\}^{\mathsf{R}}$, define their *intersection* $S \cap T \in \{-1, 0, 1\}^{\mathsf{R}}$ to be the sign vector such that $(S \cap T)^+ = S^+ \cap T^+$ and $(S \cap T)^- = S^- \cap T^-$.

Proposition 4.7. *The augmented poset $\mathcal{L}(\mathsf{P}) := \mathsf{P} \cup \{\hat{\mathbf{0}}, \hat{\mathbf{1}}\}$ is a lattice: if $(S, F), (T, G) \in \mathsf{P}$ have a common lower bound, then a greatest lower bound for both is given by $(S \cap T, F \cup G)$.*

Proof. Let (S, F) and (T, G) be elements of P with a common lower bound (L, H) . Then $H \supseteq F \cup G \supseteq F, G$ which implies by (E2) that $F \cup G \in \mathsf{S}$. Similarly, we have $L \leq S \cap T$ and so

$$\text{supp}_{\mathsf{R}}(F \cup G) \subseteq \text{supp}_{\mathsf{R}}(H) \subseteq \text{supp}(L) \subseteq \text{supp}(S \cap T).$$

We conclude $(S \cap T, F \cup G) \in \mathsf{P}$ and is a lower bound of (S, F) and (T, G) . The fact that $H \supseteq F \cup G$ and $L \leq S \cap T$ shows that $(S \cap T, F \cup G)$ is in fact a greatest lower bound, as (L, H) was chosen arbitrarily. \square

Our next task is to generalize the equivalence relation \sim_A on P from Definition 4.3, by allowing the partition Π of $\mathsf{R} \times \mathsf{E}$ to vary. We assume fixed a partition Π of $\mathsf{R} \times \mathsf{E}$ which refines the partition $\{\mathsf{R} \times \{j\} : j \in \mathsf{E}\}$. In terms of this partition, we say $X \sim Y$ if $X^s \cap \pi$ is nonempty iff $Y^s \cap \pi$ is nonempty, for all $s \in \{-, +\}$ and $\pi \in \Pi$.

Definition 4.8. For $(S, F), (T, G) \in \mathsf{P}$, we say $(S, F) \sim_A (T, G)$ if and only if $S = T$ and $SA_F \sim SA_G$.

Proposition 4.9. *The equivalence relation \sim_A on P is P -homogeneous. In particular, P/\sim_A is a poset.*

Proof. Let $(S, F) \leq (T, G)$ be two elements of P , and choose $(S, F') \sim_A (S, F)$. Our goal is to find $G' \in \mathsf{S}$ such that $(T, G') \in \mathsf{P}$ and $(S, F') \leq (T, G') \sim_A (T, G)$. Define

$$G' := \{(i, j) \in F' : \text{if } \pi \in \Pi \text{ contains } (i, j), \text{ then there exists } (\ell, j) \in \pi \text{ such that } (TA_G)_{\ell, j} = (SA_{F'})_{i, j}\}.$$

Thus $(S, F') \leq (T, G')$. The definition of G' ensures that every sign appearing in the restricted sign vector $TA_{G'}|_{\pi}$ also appears in $TA_G|_{\pi}$, for all $\pi \in \Pi$. Conversely, if $\pi \in \Pi$ and $(TA_G)_{\ell, j}$ is nonzero for some $(\ell, j) \in \pi$, then $SA_F \sim SA_G = TA_G$ implies there exists $(i, j) \in \pi$ such that $(TA_G)_{\ell, j} = (SA_F)_{\ell, j} = (SA_{F'})_{i, j}$, and therefore $TA_{G'}|_{\pi}$ contains the sign $(TA_G)_{\ell, j}$. Note that we are using here the fact that Π refines the partition $\{\mathsf{R} \times \{j\} : j \in \mathsf{E}\}$. We conclude $TA_G \sim TA_{G'}$.

Observe that G_j is nonempty for every $j \in \mathsf{E}$ by (E1), and since $TA_G \sim TA_{G'}$ we also have G'_j is nonempty for every $j \in \mathsf{E}$. Therefore, since $G' \subseteq F'$, we have by (E2) that $G' \in \mathsf{S}$. Moreover, $\text{supp}_{\mathsf{R}}(G') \subseteq \text{supp}_{\mathsf{R}}(F') \subseteq \text{supp}(S) \subseteq \text{supp}(T)$, so that $(T, G') \in \mathsf{P}$. We conclude $(T, G') \sim_A (T, G)$. \square

For a generalized sign vector $X/\sim \in \{0, +, -, \pm\}^{\Pi}$, let $|X/\sim|$ count the number of nonzero coordinates in X/\sim , with each \pm counted twice. For example, if $X/\sim = (0, \pm, -, +, -, \pm)$ then $|X/\sim| = 7$. Note that if Π is the singleton partition, then X/\sim is an ordinary sign vector and $|X/\sim| = |X|$.

Proposition 4.10. *The poset \mathcal{P}/\sim_A is graded, with grading*

$$\rho((S, F)/\sim_A) = n + |S| - |SA_F/\sim|.$$

Proof. Fix $(S, F) \in \mathcal{P}$. First note that (S, F) is a maximal element in the equivalence class $(S, F)/\sim_A$ if and only if $|(SA_F)^s \cap \pi| \leq 1$ for all $s \in \{-, +\}$ and all $\pi \in \Pi$. Indeed, choose any $(S, G) \sim_A (S, F)$. Then (E2) implies that we may find $(S, H) \geq (S, G)$ inside $(S, F)/\sim_A$ such that $|(SA_H)^s \cap \pi| \leq 1$ for all $s \in \{-, +\}$ and all $\pi \in \Pi$. In particular, this statement holds for the maximal elements of $(S, F)/\sim_A$.

Now, for every maximal element $(S, G) \sim_A (S, F)$, we have

$$\begin{aligned} \rho((S, G)/\sim_A) &= n + |S| - |SA_G/\sim| \\ &= n + |S| - \sum_{\pi \in \Pi} (|(SA_G)^+ \cap \pi| + |(SA_G)^- \cap \pi|) \\ &= n + |S| - |G| \\ &= \rho(S, G). \end{aligned}$$

It remains to show that ρ respects the covering relations. Suppose that $(S, F)/\sim_A$ is covered by $(T, G)/\sim_A$ in \mathcal{P}/\sim_A . By homogeneity, we may choose representatives (S, F) and (T, G) so that (S, F) is covered by (T, G) in \mathcal{P} . Such an element (S, F) is necessarily a maximal element of the equivalence class $(S, F)/\sim_A$, which implies $|(SA_F)^+ \cap \pi| \leq 1$ and $|(SA_F)^- \cap \pi| \leq 1$ for all $\pi \in \Pi$. Since $(S, F) < (T, G)$, we have $TA_G = SA_G \leq SA_F$, and hence $|(TA_G)^+ \cap \pi| \leq 1$ and $|(TA_G)^- \cap \pi| \leq 1$ for all $\pi \in \Pi$. It follows (T, G) is maximal in $(T, G)/\sim_A$. We conclude

$$\rho((S, F)/\sim_A) = \rho(S, F) = \rho(T, G) - 1 = \rho((T, G)/\sim_A) - 1. \quad \square$$

Proposition 4.11. *The augmented poset $\mathcal{L}(\mathcal{P}/\sim_A)$ is a lattice.*

Proof. Choose $(S, F)/\sim_A$ and $(T, G)/\sim_A$ with a common lower bound in \mathcal{P}/\sim_A . By homogeneity and Proposition 4.7, we may choose the representatives (S, F) and (T, G) so that $(S \cap T, F \cup G) \in \mathcal{P}$. By homogeneity, then, $(S \cap T, F \cup G)/\sim_A$ is a lower bound for both $(S, F)/\sim_A$ and $(T, G)/\sim_A$.

We show this is a greatest lower bound. Given a lower bound $(L, H)/\sim_A$, we may find $(S, F') \sim_A (S, F)$ and $(T, G') \sim_A (T, G)$ such that $(L, H) \leq (S, F')$ and $(L, H) \leq (T, G')$ in \mathcal{P} . Hence, by Proposition 4.7, $(L, H) \leq (S \cap T, F' \cup G') \in \mathcal{P}$. Therefore, it suffices to show

$$(S \cap T, F' \cup G') \sim_A (S \cap T, F \cup G).$$

For all $\pi \in \Pi$ and $s \in \{-, +\}$, we have

$$\begin{aligned} ((S \cap T)A_{F' \cup G'})^s \cap \pi \text{ nonempty} &\iff ((SA_{F'})^s \cup (TA_{G'})^s) \cap \pi \text{ nonempty} \\ &\iff ((SA_F)^s \cup (TA_G)^s) \cap \pi \text{ nonempty} \\ &\iff ((S \cap T)A_{F \cup G})^s \cap \pi \text{ nonempty.} \end{aligned}$$

In particular, this shows $(S \cap T, F' \cup G') \sim_A (S \cap T, F \cup G)$. \square

We now come to the main theorem of this section:

Theorem 4.12. *The poset $\mathcal{P}(\mathcal{S})/\sim_A$ admits a factorization $\mathcal{P}(\mathcal{S}) = \mathcal{P}_0, \mathcal{P}_1, \dots, \mathcal{P}_k = \mathcal{P}(\mathcal{S})/\sim_A$ into elementary quotients, such that the augmented poset $\mathcal{L}(\mathcal{P}_i)$ is a lattice for each $i = 0, 1, \dots, k - 1$.*

Proof. By Proposition 4.7, $\mathcal{L}(\mathbb{P})$ is a lattice. Thus, let $\bar{\Pi}$ be a partition of $\mathbb{R} \times \mathbb{E}$ which refines the partition Π and has at least one part $\pi \in \bar{\Pi}$ such that $|\pi| \geq 2$. Let $e := (i, j) \in \pi$, and let $\check{\Pi}$ be the refinement of $\bar{\Pi}$ obtained by splitting the part π into two parts: $\{e\}$ and $\pi \setminus \{e\}$. That is,

$$\check{\Pi} = (\bar{\Pi} \setminus \{\pi\}) \cup \{\{e\}, \pi \setminus \{e\}\}.$$

Let $\check{\sim}$ and \sim denote the equivalence relations on sign vectors on $\mathbb{R} \times \mathbb{E}$ induced by $\check{\Pi}$ and $\bar{\Pi}$, respectively. These determine \mathbb{P} -homogeneous equivalence relations $\check{\sim}_A$ and \sim_A by Proposition 4.9. Let $\check{\mathbb{P}} = \mathbb{P}/\check{\sim}_A$. Since $\check{\sim}_A$ is \mathbb{P} -homogeneous, and since $\check{\sim}_A$ refines \sim_A , we have that $\check{\sim}_A$ is $\check{\mathbb{P}}$ -homogeneous. Moreover, there is a natural identification $\check{\mathbb{P}}/\check{\sim}_A = \mathbb{P}/\sim_A$. Therefore, by induction, the theorem is proved if we can show that $\check{\mathbb{P}}/\check{\sim}_A$ is an elementary quotient whose augmented poset is a lattice. In fact the lattice assertion follows from Proposition 4.11.

Fix $(S, F) \in \mathbb{P}$. We would like to show that the equivalence class containing $(S, F)/\check{\sim}_A$ in $\check{\mathbb{P}}/\check{\sim}_A$ is either a singleton, or consists of exactly three elements two of which cover a third. Note that if $SA_F|_\pi$ is the zero vector, then this equivalence class is indeed a singleton. This is because we would immediately know that $(SA_F)_e = 0$ and $SA_F|_{\pi \setminus e} = \mathbf{0}$, hence in this case $(S, F)/\check{\sim}_A$ is completely determined by $(S, F)/\sim_A$.

Otherwise, the sign vector $SA_F|_\pi$ is non-zero, and in this case there are exactly three generalized sign vectors $X_1, X_2, X_3/\check{\sim} \in \{0, -, +, \pm\}^{\check{\Pi}}$, depending on $SA_F|_\pi$ and $(SA)_e$, such that $X_1 \check{\sim} X_2 \check{\sim} X_3 \check{\sim} SA_F$. The restrictions of these to π are depicted below, in all of four possible cases:

$$\begin{array}{ccc} \begin{array}{c} e \\ \pi \setminus e \end{array} \begin{array}{|c|c|c|} \hline 0 & + & + \\ \hline \pm & - & \pm \\ \hline \end{array} \begin{array}{c} \rightarrow \\ \end{array} \begin{array}{|c|} \hline \pm \\ \hline \end{array} \begin{array}{c} \pi \\ SA_F \end{array} & \begin{array}{c} e \\ \pi \setminus e \end{array} \begin{array}{|c|c|c|} \hline 0 & - & - \\ \hline \pm & + & \pm \\ \hline \end{array} \begin{array}{c} \rightarrow \\ \end{array} \begin{array}{|c|} \hline \pm \\ \hline \end{array} \begin{array}{c} \pi \\ SA_F \end{array} \\ X_1 & X_2 & X_3 & & X_1 & X_2 & X_3 & & SA_F & & SA_F \\ \\ \begin{array}{c} e \\ \pi \setminus e \end{array} \begin{array}{|c|c|c|} \hline 0 & + & + \\ \hline + & 0 & + \\ \hline \end{array} \begin{array}{c} \rightarrow \\ \end{array} \begin{array}{|c|} \hline + \\ \hline \end{array} \begin{array}{c} \pi \\ SA_F \end{array} & \begin{array}{c} e \\ \pi \setminus e \end{array} \begin{array}{|c|c|c|} \hline 0 & - & - \\ \hline - & 0 & - \\ \hline \end{array} \begin{array}{c} \rightarrow \\ \end{array} \begin{array}{|c|} \hline - \\ \hline \end{array} \begin{array}{c} \pi \\ SA_F \end{array} \\ X_1 & X_2 & X_3 & & X_1 & X_2 & X_3 & & SA_F & & SA_F \end{array}$$

The following argument applies simultaneously to all four cases shown above. Suppose there are at least two distinct elements $(S, F)/\check{\sim}_A$ and $(S, F')/\check{\sim}_A$ in the same equivalence class of $\check{\mathbb{P}}/\check{\sim}_A$. Then there exists a unique $i \in \{1, 2, 3\}$ such that

$$\{SA_F/\check{\sim}, SA_{F'}/\check{\sim}, X_i/\check{\sim}\} = \{X_1/\check{\sim}, X_2/\check{\sim}, X_3/\check{\sim}\}.$$

for some $i \in \{1, 2, 3\}$. We consider the three cases separately.

- If $i = 1$ or 2 , then without loss of generality assume $SA_F \check{\sim} X_3$.
 - If $i = 1$, then by (E2) the set $F'' = F \setminus e$ is in \mathbb{S} , and $SA_{F''} \check{\sim} X_1$.
 - If $i = 2$, then by (E2) the set $F'' = F \setminus ((SA_F)^s \cap \pi)$ is in \mathbb{S} , where s is the unique sign appearing in $X_3|_{\pi \setminus e}$ but not $X_2|_{\pi \setminus e}$, and $SA_{F''} \check{\sim} X_2$.
- If $i = 3$, then by (E3), we can find $F'' \in \mathbb{S}$ such that

$$SA_{F''}|_\pi = SA_{F \cup F'}|_\pi$$

$$SA_{F''}|_\tau \in \{SA_F|_\tau, SA_{F'}|_\tau, SA_{F \cup F'}|_\tau\} \text{ for all } \tau \in \bar{\Pi} \setminus \pi.$$

This shows $SA_{F''} \sim X_3$. We remark that this is the only time (E3) is used. In all three cases, we therefore have found $(S, F'') \sim_A (S, F)$ such that $SA_{F''} \sim X_i$. Therefore the equivalence class of $(S, F)/\sim_A$ in \dot{P}/\sim_A consists of the three distinct elements $(S, F)/\sim_A$, $(S, F')/\sim_A$, and $(S, F'')/\sim_A$. Their gradings in $\dot{P} = P/\sim$ are given by, by Proposition 4.10, $n - |S| - |X_i/\sim|$ for $i = 1, 2, 3$. Inspecting the above four tables, we conclude that two of these elements cover the third in \dot{P} . \square

5. QUOTIENTS OF REGULAR CELL COMPLEXES

5.1. Background: Regular Cell Complexes and PL Topology. We quickly review the key aspects of combinatorial topology we wish to use. The main reference here is [5, Section 4.7].

5.1.1. *Regular Cell Complexes.*

Definition 5.1. A *regular cell complex* Δ is a Hausdorff space $\|\Delta\|$ together with a finite collection of balls Δ such that:

- (1) The interiors of the balls in Δ partition the space: $\|\Delta\| = \bigcup_{\sigma \in \Delta} \sigma^\circ$.
- (2) The boundary of any $\sigma \in \Delta$ is a union of members of Δ : $\text{bd}(\sigma) = \bigcup_{\tau \subset \sigma} \tau$.

Definition 5.2. An important special case of the above definition is a *polyhedral cell complex*. This is a regular cell complex Δ such that each $\sigma \in \Delta$ is a polytope in \mathbb{R}^d , and for each $\sigma, \tau \in \Delta$ we have $\sigma \cap \tau$ is a face of both σ and τ . If every polytope in Δ is a simplex, we call Δ a *geometric simplicial complex*. A *triangulation* of a set $Q \subset \mathbb{R}^d$ is a geometric simplicial complex with underlying space Q .

Definition 5.3. The *face poset* $P(\Delta)$ of a regular cell complex Δ is the poset whose underlying set is the set of balls Δ , and whose ordering is given by inclusion.

Definition 5.4. The *order complex* $\Delta(P)$ of a poset P is the simplicial complex whose vertices are the elements of P and whose simplices are the chains of P . We denote by $\|P\|$ the topological space $\|\Delta(P)\|$.

Proposition 5.5. *Every abstract simplicial complex (i.e. set system closed under taking subsets) can be realized as a geometric simplicial complex in some Euclidean space.*

5.1.2. *PL Balls and Spheres.*

Definition 5.6. Given $P \subset \mathbb{R}^k$, $Q \subset \mathbb{R}^\ell$, a map $f : P \rightarrow Q$ is *piecewise linear* (PL) if there is a triangulation Δ of P into simplices such that f restricted to each simplex of Δ is an affine function. That is, if $\sigma = \text{conv}(v_0, \dots, v_k) \in \Delta$ then $f|_\sigma$ satisfies

$$f(\lambda_0 v_0 + \lambda_1 v_1 + \dots + \lambda_k v_k) = \lambda_0 f(v_0) + \lambda_1 f(v_1) + \dots + \lambda_k f(v_k)$$

for all convex combinations $\sum_i \lambda_i v_i$ of the vertices v_0, \dots, v_k of σ . We call a PL map that is also a homeomorphism a *PL homeomorphism*.

Definition 5.7. Let $P \subset \mathbb{R}^k$ be the underlying space of a polyhedral cell complex. Then P is a *PL d -sphere* (resp. *PL d -ball*) if there is a PL homeomorphism from P to the boundary of the standard d -simplex (resp. to the standard d -simplex).

Proposition 5.8.

- (1) [5, Theorem 4.7.21(i)] *The union of two PL d -balls, whose intersection is a PL $(d - 1)$ -ball lying in the boundary of each, is a PL d -ball.*

- (2) [5, Theorem 4.7.21(ii)] *The union of two PL d -balls, which intersect along their entire boundaries, is a PL d -sphere.*
- (3) [5, Theorem 4.7.21(iii)] (*Newman's Theorem*) *The closure of the complement of a PL d -ball embedded in a PL d -sphere is itself a PL d -ball.*

Lemma 5.9. *Let σ, τ be two PL d -balls, such that $\sigma \cap \tau$ is a PL $(d-1)$ -ball contained in the boundaries of both σ and τ . Then the interior of $\sigma \cup \tau$ is equal to $\sigma^\circ \cup \tau^\circ \cup (\sigma \cap \tau)^\circ$.*

Proof. By Proposition 5.8 (1), $\sigma \cup \tau$ is a PL d -ball. We start by showing that σ° contains $(\sigma \cup \tau)^\circ \setminus \tau$. Let $x \in (\sigma \cup \tau)^\circ \setminus \tau$. Then there is an open set $\mathcal{U} \subset (\sigma \cup \tau)^\circ$ containing x and a homeomorphism $\varphi : \mathcal{U} \rightarrow B_d^\circ \subset \mathbb{R}^d$ sending x to $\mathbf{0}$. Here B_d denotes the ball of radius 1 in \mathbb{R}^d centred at the origin. Since τ is closed in $\sigma \cup \tau$, and since $x \notin \tau$, we further have that $\varphi(\mathcal{U} \setminus \tau)$ is an open set which contains the origin; hence there exists $\delta > 0$ such that the scaled open ball $\delta \cdot B_d^\circ$ is contained in $\varphi(\mathcal{U} \setminus \tau) = \varphi(\mathcal{U}) \setminus \varphi(\tau)$. It follows that $\varphi^{-1}(\delta \cdot B_d^\circ)$ is an open neighbourhood of x , homeomorphic to B_d° , and entirely contained in σ . In particular, this means that $x \in \sigma^\circ$. We conclude $\sigma^\circ \supseteq (\sigma \cup \tau)^\circ \setminus \tau$.

From this containment we immediately get

$$\partial\sigma \subseteq \sigma \setminus ((\sigma \cup \tau)^\circ \setminus \tau) = (\sigma \cap \tau) \cup (\sigma \cap \partial(\sigma \cup \tau)),$$

and in particular

$$U := \partial\sigma \setminus (\sigma \cap \tau) \subseteq \partial(\sigma \cup \tau).$$

Since boundaries are closed, $V := \partial(\sigma \cup \tau) \cap \partial\sigma$ is closed inside $\partial\sigma$. Now $W := \partial(\sigma \cap \tau)$ is the boundary of U in $\partial\sigma$, thus it is contained in $\bar{U} \subset V \subset \partial(\sigma \cup \tau)$. Similarly, $U' := \partial\tau \setminus (\sigma \cap \tau) \subset \partial(\sigma \cup \tau)$. By Proposition 5.8 (3), both $U \cup W, U' \cup W$ are PL $(d-1)$ -balls with common boundary W , so by Proposition 5.8 (2), $U \cup W \cup U'$ is a PL $(d-1)$ -sphere contained in $\partial(\sigma \cup \tau)$. Invariance of Domain implies the containment is an equality, see for example [16, Corollary 2B.4]. After taking the complement with respect to $\sigma \cup \tau$, this equality yields an expression for $(\sigma \cup \tau)^\circ$ which simplifies to $\sigma^\circ \cup \tau^\circ \cup (\sigma \cap \tau)^\circ$. \square

5.1.3. Regular Cell Complexes that are PL Spheres.

Definition 5.10. We say that a regular cell complex Δ with face poset \mathbf{P} is a *PL sphere* if some realization of the order complex $\Delta(\mathbf{P})$ in some Euclidean space is a PL sphere.

Proposition 5.11 ([5, Proposition 4.7.26(iii)]). *Let Δ be a regular cell complex that is a PL sphere. Then every $\sigma \in \Delta$ is a PL ball.*

An important fact about PL spheres is that they admit a dual cell structure:

Proposition 5.12 ([5, Proposition 4.7.26(iv)]). *Let Δ be a regular cell complex that is a PL sphere. Then there exists a regular cell complex Δ^\vee , also a PL sphere, such that $\|\Delta\| = \|\Delta^\vee\|$ and $\mathbf{P}(\Delta^\vee) \simeq \mathbf{P}(\Delta)^\vee$.*

Here \mathbf{P}^\vee denotes the dual poset of \mathbf{P} . In the special case when Δ is a polyhedral cell complex, there is a non-canonical way to construct this Δ^\vee :

Definition 5.13. Let Δ be a polyhedral cell complex. A *first derived subdivision* Δ^1 is a subdivision of Δ obtained as follows: choose a point x_σ in the relative interior of each $\sigma \in \Delta$. Then, Δ^1 is given by

$$\Delta^1 := \{\text{conv}(x_{\sigma_1}, \dots, x_{\sigma_k}) : \sigma_1 \subsetneq \sigma_2 \subsetneq \dots \subsetneq \sigma_k, \text{ each } \sigma_i \in \Delta\}.$$

Theorem 5.14 ([19, § 1.6]). *If Δ is a polyhedral cell complex then Δ^\vee may be constructed as follows: Choose a first derived subdivision Δ^1 of Δ . For each cell $\sigma \in \Delta$, define*

$$\sigma^\vee := \bigcap_{v \text{ vertex of } \sigma} \|\overline{\text{star}}(v; \Delta^1)\|$$

where $\overline{\text{star}}(\sigma; \Delta) := \{\tau \in \Delta : \tau \text{ is contained in a cell containing } \sigma\}$. Then let

$$\Delta^\vee := \{\sigma^\vee : \sigma \in \Delta\}.$$

5.2. Quotients of Regular Cell Complexes. Our next goal is to develop a notion of a quotient of a regular cell complex Δ , in which cells are merged together according to a given equivalence relation on the cells of Δ .

Let Δ be a regular cell complex with face poset \mathbf{P} , so that $\|\Delta\| \subseteq \mathbb{R}^d$. Given a homogeneous quotient \mathbf{P}/\sim of \mathbf{P} , define the set

$$\Delta/\sim := \left\{ \bigcup \tilde{\sigma} : \tilde{\sigma} \in \mathbf{P}/\sim \right\}$$

where $\bigcup \tilde{\sigma}$ denotes the union $\bigcup_{\tau \in \tilde{\sigma}} \tau$. Note that homogeneity of \sim implies that $\bigcup \tilde{\sigma} \subseteq \bigcup \tilde{\tau}$ as sets if and only if $\bigcup \tilde{\sigma} \leq \bigcup \tilde{\tau}$ in \mathbf{P}/\sim .

Under certain conditions, Δ/\sim is again a regular cell complex:

Theorem 5.15. *Suppose:*

- (1) *The poset \mathbf{P}/\sim is an elementary quotient,*
- (2) *The augmented poset $\mathcal{L}(\mathbf{P})$ is a lattice, and*
- (3) *Each $\sigma \in \Delta$ is a PL ball.*

Then Δ/\sim is a regular cell complex with face poset \mathbf{P}/\sim , such that each $\bigcup \tilde{\sigma} \in \Delta/\sim$ is a PL ball.

Corollary 5.16. *Suppose \mathbf{P} admits a factorization $\mathbf{P} = \mathbf{P}_0, \mathbf{P}_1, \dots, \mathbf{P}_k = \mathbf{P}/\sim$ into elementary quotients, such that $\mathcal{L}(\mathbf{P}_i)$ is a lattice for each $i = 0, 1, 2, \dots, k - 1$. Suppose further that each $\sigma \in \Delta$ is a PL ball. Then Δ/\sim is a regular cell complex with face poset \mathbf{P}/\sim .*

In the remainder of this section we prove Theorem 5.15. The main ingredient is a topological criterion for Δ/\sim to be a regular cell complex:

Lemma 5.17. *Suppose that each $\bigcup \tilde{\sigma}$ in Δ/\sim is a ball whose interior equals the union of the interiors of the cells of $\tilde{\sigma}$. Then Δ/\sim is a regular cell complex with face poset \mathbf{P}/\sim .*

Proof. We first show that Δ/\sim is a regular cell complex. It is clear that the underlying topological spaces of Δ and Δ/\sim are the same. To see that the interiors of the balls in Δ/\sim are disjoint, let $\bigcup \tilde{\sigma}_1$ and $\bigcup \tilde{\sigma}_2$ be two balls in Δ/\sim such that

$$\left(\bigcup \tilde{\sigma}_1 \right)^\circ \cap \left(\bigcup \tilde{\sigma}_2 \right)^\circ = \left(\bigcup_{\tau_1 \in \tilde{\sigma}_1} \tau_1^\circ \right) \cap \left(\bigcup_{\tau_2 \in \tilde{\sigma}_2} \tau_2^\circ \right) = \bigcup_{\substack{\tau_1 \in \tilde{\sigma}_1 \\ \tau_2 \in \tilde{\sigma}_2}} \tau_1^\circ \cap \tau_2^\circ$$

is non-empty. In particular, there must exist $\tau_1 \in \tilde{\sigma}_1$ and $\tau_2 \in \tilde{\sigma}_2$ such that τ_1° and τ_2° intersect. This can only happen if $\tau_1 = \tau_2$, and hence $\tilde{\sigma}_1 = \tilde{\sigma}_2$. To see that the boundary of each $\bigcup \tilde{\sigma}$ in Δ/\sim is a union of members of Δ/\sim , let $\bigcup \tilde{\sigma}$ be an element of Δ/\sim . Then

$$(4) \quad \bigcup_{\tilde{\tau} < \tilde{\sigma}} \left(\bigcup \tilde{\tau} \right) = \bigcup_{\substack{\delta \in \tilde{\sigma} \\ \tau \in \delta \\ \tau \notin \tilde{\sigma}}} \bigcup_{\substack{\delta \in \tilde{\sigma} \\ \tau \in \delta \\ \tau \notin \tilde{\sigma}}} \tau = \bigcup_{\substack{\delta \in \tilde{\sigma} \\ \tau \in \delta \\ \tau \notin \tilde{\sigma}}} \tau^\circ.$$

We justify the last equality. We may write $\tau = \bigcup_{\gamma \leq \tau} \gamma^\circ$ for every $\tau \in \Delta$. Hence, the last equality holds provided we can show the following statement: whenever we have $\gamma \leq \tau < \delta \in \tilde{\sigma}$ where $\tau \notin \tilde{\sigma}$, we must also have $\gamma \notin \tilde{\sigma}$. The condition $\gamma \leq \tau$ implies $\tilde{\gamma} \leq \tilde{\tau}$. The condition $\tau < \delta$ implies $\tilde{\tau} \leq \tilde{\delta} = \tilde{\sigma}$. On the other hand, the condition $\tau \notin \tilde{\sigma}$ implies $\tilde{\tau} \neq \tilde{\sigma}$, and therefore $\tilde{\tau} < \tilde{\sigma}$. We conclude $\tilde{\gamma} \leq \tilde{\tau} < \tilde{\sigma}$, and in particular $\gamma \notin \tilde{\sigma}$. Note that this argument uses the fact that \mathbf{P}/\sim is a poset, which follows from homogeneity of \sim . Now, since the interiors of cells of Δ partition $\|\Delta\|$, we have by (4) that

$$\bigcup_{\tilde{\tau} < \tilde{\sigma}} (\bigcup \tilde{\tau}) = \bigcup_{\delta \in \tilde{\sigma}} \left(\left(\bigcup_{\tau \leq \delta} \tau^\circ \right) \setminus \bigcup_{\gamma \in \tilde{\sigma}} \gamma^\circ \right) = \bigcup_{\delta \in \tilde{\sigma}} \left(\delta \setminus \bigcup_{\gamma \in \tilde{\sigma}} \gamma^\circ \right) = (\bigcup \tilde{\sigma}) \setminus \bigcup_{\gamma \in \tilde{\sigma}} \gamma^\circ.$$

We therefore conclude

$$\text{bd}(\bigcup \tilde{\sigma}) = (\bigcup \tilde{\sigma}) \setminus (\bigcup \tilde{\sigma})^\circ = (\bigcup \tilde{\sigma}) \setminus \bigcup_{\gamma \in \tilde{\sigma}} \gamma^\circ = \bigcup_{\tilde{\tau} < \tilde{\sigma}} (\bigcup \tilde{\tau}).$$

The proof that the face poset of Δ/\sim is \mathbf{P}/\sim is straightforward. If $\bigcup \tilde{\tau} \subseteq \bigcup \tilde{\sigma}$, then this means in particular that $\tau \subseteq \sigma$, hence $\tau \leq \sigma$ in \mathbf{P} , hence $\tilde{\tau} \leq \tilde{\sigma}$ in \mathbf{P}/\sim . Conversely, if $\tilde{\tau} \leq \tilde{\sigma}$ in \mathbf{P}/\sim , then there exists a cell of $\tilde{\tau}$ contained in some cell of $\tilde{\sigma}$. By homogeneity, then, every cell of $\tilde{\tau}$ is contained in some cell of $\tilde{\sigma}$. Hence $\bigcup \tilde{\tau} \subseteq \bigcup \tilde{\sigma}$. \square

Proposition 5.18 ([5, Section 4.7, pp.204]). *Let Δ be a regular cell complex with face poset \mathbf{P} . Then the augmented poset $\mathcal{L}(\mathbf{P}) = \mathbf{P} \cup \{\hat{\mathbf{0}}, \hat{\mathbf{1}}\}$ is a lattice if and only if Δ is closed under non-empty intersections: for all $\sigma, \tau \in \Delta$ such that $\sigma \cap \tau$ is non-empty, we have $\sigma \cap \tau \in \Delta$.* \square

Proof of Theorem 5.15. It is clear that for any singleton class $\tilde{\sigma} = \{\sigma\}$, $\bigcup \tilde{\sigma}$ satisfies the hypothesis of Lemma 5.17. Now suppose $\tilde{\sigma} = \{\sigma, \tau, \gamma\}$ is a class in \sim . It is known that the function $\sigma \mapsto \dim(\sigma)$ is a rank function on \mathbf{P} . In particular, since σ and τ cover γ , then we must have $\dim(\sigma) = \dim(\tau) = \dim(\gamma) + 1$. Moreover, since $\mathcal{L}(\mathbf{P})$ is a lattice, we must have $\gamma = \sigma \cap \tau$ by Proposition 5.18. Proposition 5.8 (1) and Lemma 5.9 then show that $\bigcup \tilde{\sigma}$ is a PL ball which satisfies the hypothesis of Lemma 5.17. \square

6. PROOF OF THE MAIN THEOREM

In this section we prove Theorem 3.5. We assume the fine mixed subdivision \mathbf{S} of $n\Delta_{d-1}$, the sign matrix A , and the oriented matroid $\widetilde{\mathcal{M}}$ are as defined in Section 3.2.

6.1. Properties of the Extended Patchworking Complex. We begin this section by establishing some technical details of the extended patchworking complex defined in Section 3.2. Note that each face of the polytope $n\Delta_{d-1}$ is in bijection with a nonempty subset $I \subseteq \mathbf{R}$. Let \mathbf{S}_I denote the cells of \mathbf{S} contained in the coordinate subspace $\mathbb{R}^I \times \{0\}^{\overline{I}}$ of \mathbb{R}^d . For $S \in \{-1, 0, 1\}^d \setminus \mathbf{0}$ and $\sigma \in \mathbf{S}_{\text{supp}(S)}$, let $\sigma_S := \square_S + S \cdot \sigma$.

Proposition 6.1. *Define the collection of polytopes given by*

$$\mathcal{O}_{\mathbf{S}} := \left\{ \sigma_S : S \in \{-1, 0, 1\}^d \setminus \mathbf{0}, \sigma \in \mathbf{S}_{\text{supp}(S)} \right\}.$$

Then the following statements hold:

- (1) $\mathcal{O}_{\mathbf{S}}$ is a polyhedral cell complex which subdivides the boundary of $\square_d + n\triangle_d$.
- (2) For each $\sigma_S \in \mathcal{O}_{\mathbf{S}}$, both S and σ can be recovered from σ_S .
- (3) For $\sigma_S, \tau_T \in \mathcal{O}_{\mathbf{S}}$, we have $\sigma_S \subseteq \tau_T$ if and only if $S \geq T$ and $\sigma \subseteq \tau$.

Remark 6.2. The subdivision \mathbf{S} in the statement of Proposition 6.1 can be replaced by any polyhedral subdivision of $n\triangle_{d-1}$.

Proof. First note that (2) follows from the fact that each $\sigma_S = \square_S + S \cdot \sigma$ is a Minkowski sum of two affinely independent polytopes. Therefore, projection allows us to recover both \square_S and $S \cdot \sigma$, and therefore the pair (S, σ) .

Recall the general fact that F is a proper face of the Minkowski sum $K + L$ of two full-dimensional polytopes K and L if and only if there exists a non-zero objective function \mathbf{c} such that $F = K_{\mathbf{c}} + L_{\mathbf{c}}$, where $K_{\mathbf{c}}$ and $L_{\mathbf{c}}$ denote the faces of K and L , respectively, maximized by \mathbf{c} . Specializing to the case $K = \square_d$ and $L = n\triangle_d$, we have $K_{\mathbf{c}} = \square_S$ and $L_{\mathbf{c}} = S \cdot (n\triangle_I)$, where S is the componentwise sign vector of \mathbf{c} , I is the set of all $i \in \mathbb{R}$ such that $|\mathbf{c}_i| = \max_{k \in \mathbb{R}} |\mathbf{c}_k|$, and $\triangle_I := \text{conv}(\mathbf{e}_i : i \in I)$. It follows that the collection of proper faces of $\square_d + n\triangle_d$ is given by

$$\left\{ \square_S + S \cdot (n\triangle_I) : S \in \{-1, 0, 1\}^d \setminus \mathbf{0}, \emptyset \subsetneq I \subseteq \text{supp}(S) \right\}.$$

Since $\square_S + S \cdot (n\triangle_I)$ is the union of the cells $\{\sigma_S : \sigma \in \mathbf{S}_I\}$, this shows that the cells in $\mathcal{O}_{\mathbf{S}}$ cover the boundary of $\square_d + n\triangle_d$. The above fact about faces of Minkowski sums can also be used to show that the faces of $\sigma_S = \square_S + S \cdot \sigma$ are given by $\{\tau_T : \tau \text{ face of } \sigma, T \supseteq S\}$. This establishes (3), and that $\mathcal{O}_{\mathbf{S}}$ is closed under taking faces.

To establish (1), it remains to show that the intersection of two intersecting cells of $\sigma_S, \tau_T \in \mathcal{O}_{\mathbf{S}}$ is a face of both. If $\sigma_S \cap \tau_T$ is non-empty, then S and T are conformal sign vectors since otherwise, if (say) $i \in S^+ \cap T^-$, then σ_S would lie in the halfspace $x_i \geq 1$, while τ_T lies in the halfspace $x_i \leq -1$. Now, we would like to show $\sigma_S \cap \tau_T = (\sigma \cap \tau)_{S \circ T}$, where $S \circ T$ denotes sign vector composition. As argued above, $(\sigma \cap \tau)_{S \circ T}$ is a face of both σ_S and τ_T . Thus, it remains to show that $\sigma_S \cap \tau_T$ is contained in $(\sigma \cap \tau)_{S \circ T}$.

Suppose $u + s = v + t$, where $u \in \square_S$, $v \in \square_T$, $s \in S \cdot \sigma$, $t \in T \cdot \tau$. We are done if we can show $u = v$ and $s = t$. For this it suffices to show $u_i = v_i$ for all $i \in \mathbb{R}$. Since S, T are conformal, we have $u_i = v_i$ for all $i \in \text{supp}(S) \cap \text{supp}(T)$. For $i \in \mathbb{R} \setminus (\text{supp}(S) \cup \text{supp}(T))$, we have $s_i = t_i = 0$, and hence $u_i = v_i$. Thus it remains to show $u_i = v_i$ in the case when $i \in \text{supp}(S) \setminus \text{supp}(T)$ or $i \in \text{supp}(T) \setminus \text{supp}(S)$.

Suppose $i \in \text{supp}(S) \setminus \text{supp}(T)$. The fact $i \in \text{supp}(S)$ implies $|u_i| = 1$, and the fact $i \notin \text{supp}(T)$ implies $t_i = 0$. Now $u_i s_i \geq 0$, which implies

$$1 + |s_i| = |u_i + s_i| = |v_i + t_i| = |v_i| \leq 1.$$

Hence $s_i = 0 = t_i$, and so $u_i = v_i$. The case $i \in \text{supp}(T) \setminus \text{supp}(S)$ is proven analogously. \square

Recall that, by the Cayley trick, the cells in \mathbf{S} encode the simplices in \mathcal{T} , for which no node in \mathbf{E} is isolated. This directly shows that they fulfill property (E1) and (E2) of elimination systems (Definition 4.1). A proof that \mathbf{S} satisfies (E3) can be found in [26, Proposition 4.12], and this result has been generalized to arbitrary mixed subdivisions in [18, Theorem 7.11]. Hence, we conclude:

Proposition 6.3. *The set of forests encoded by \mathbf{S} form an elimination system. \square*

Observing that $\sigma_F \in \mathbf{S}_I$ if and only if $\text{supp}_R(F) \subseteq I$, and that on the level of posets, taking the dual just amounts to reversing the ordering, we have

Corollary 6.4. *The map $(\sigma_F)_{\mathbf{S}}^{\vee} \mapsto (S, F)$ determines an isomorphism from the face poset of the dual complex $\bigcirc_{\mathbf{S}}^{\vee}$ to the poset $\mathbf{P}(\mathbf{S})$ defined in Definition 4.2.*

6.2. The Map $\varphi : \mathbf{P}(\mathbf{S})/\sim_A \rightarrow \mathcal{L}(\widetilde{\mathcal{M}})$. We next consider the labeling of the elements of $\mathbf{P}(\mathbf{S})/\sim_A$ by sign vectors. For this, we use the connection between the pairs (S, F) denoting cells of the extended patchworking complex and covectors established in Corollary 2.11.

Now, we look at the particular elimination system given by the fine mixed subdivision \mathbf{S} . In the following proposition, let $\mathcal{L}(\widetilde{\mathcal{M}})$ denote the poset of non-zero covectors of $\widetilde{\mathcal{M}}$. Let $\mathbf{P}(\mathbf{S})/\sim_A$ be the poset as in Section 4.3.

Recall from Section 4.3 the system of mixed signs $\{0, +, -, \pm\}$. Using this as an intermediate step, one sees that the following map extending the map ψ_A of Definition 2.9 is well-defined on its equivalence classes.

Definition 6.5. Define the map $\varphi : \mathbf{P}(\mathbf{S})/\sim_A \rightarrow \{-1, 0, 1\}^{\widetilde{\mathbf{E}}}$ by $\varphi_A(S, F) = (S, \psi_A(S, F))$.

As we fix A most of the time, we just set $\varphi(S, F) = \varphi_A(S, F)$.

Example 6.6 (Ex. 4.4 continued). Recall that we could identify the equivalence classes of the four sign vectors $S_{\ell}A_{F_{\ell}}$ for $\ell \in [4]$ with $(\pm, -, +)$, $(\pm, -, +)$, $(\pm, -, \pm)$ and $(\pm, -, -)$. This shows that the images of the three equivalence classes of (S_{ℓ}, F_{ℓ}) (as $(S_1, A_{F_1}) \sim_A (S_2, A_{F_2})$) are the sign vectors

$$(-, +, +, 0, -, +), (-, +, +, 0, -, 0), (+, +, +, 0, -, -).$$

Note that a similar map was used in [18, §6] to prove the representation theorem for tropical oriented matroids.

Since φ is constant on the equivalence classes of $/\sim_A$, we just fix an element $(S, F) \in \mathbf{P}(\mathbf{S})$. With this, we associate the bipartite graph T on $\mathbf{R} \sqcup \widetilde{\mathbf{E}}$ having the edges of F and edges between the nodes of \mathbf{R} and its copy $\widetilde{\mathbf{R}}$ within $\widetilde{\mathbf{E}}$ for each element \mathbf{R} in the support of S . Now, the claim follows from Proposition 2.10.

Corollary 6.7. *For all $(S, F) \in \mathbf{P}(\mathbf{S})/\sim_A$, we have $\varphi(S, F) \in \mathcal{L}(\widetilde{\mathcal{M}})$.*

Proposition 6.8. *The map $\varphi : \mathbf{P}(\mathbf{S})/\sim_A \rightarrow \mathcal{L}(\widetilde{\mathcal{M}})$ is a poset map.*

Proof. Suppose $(S, F) \leq (S', F')$ in \mathbf{P} . Let $(S, X) = \varphi(S, F)$, and let $(S', X') = \varphi(S', F')$. Then $S \leq S'$, and because $F \supseteq F'$, the passage from SA_F to $SA_{F'}$ only decreases the number of non-zero entries in each column of SA_F . However $SA_{F'}$ still has at least one non-zero entry in each column. From this we conclude $X \leq X'$, and therefore φ respects order. \square

Recall that a poset \mathbf{P} is a *sphere* if its order complex is a sphere; see Definition 5.4.

Theorem 6.9 (Borsuk–Ulam). *Let \mathbf{P}, \mathbf{Q} be posets such that both are homeomorphic to S^{d-1} and both are equipped with a fixed-point free involutive automorphism $x \mapsto -x$. Let $\varphi : \mathbf{P} \rightarrow \mathbf{Q}$ be a poset map satisfying $\varphi(-x) = -\varphi(x)$ for all $x \in \mathbf{P}$. Then φ is surjective.*

Corollary 6.10. *Assuming $\mathbf{P}(\mathbf{S})/\sim_A$ is a $(d-1)$ -sphere, the map $\varphi : \mathbf{P}(\mathbf{S})/\sim_A \rightarrow \mathcal{L}(\widetilde{\mathcal{M}})$ is an isomorphism.*

Remark 6.11. We show that $\mathbf{P}(\mathbf{S})/\sim_A$ is indeed a $(d-1)$ -sphere in Section 6.4.

Proof. For $(S, F) \in \mathbf{P}(\mathbf{S})/\sim_A$, the interpretation of SA_F/\sim as a generalized sign vector in $\{0, -, +, \pm\}^{\Pi}$ shows that φ is injective. To see that φ is surjective, we simply note that $(S, F) \mapsto -(S, F) := (-S, F)$ is a fixed-point free involutive automorphism of $\mathbf{P}(\mathbf{S})$ which descends to $\mathbf{P}(\mathbf{S})/\sim_A$, while $X \mapsto -X$ is one of $\mathcal{L}(\widetilde{\mathcal{M}})$. Furthermore, by definition of φ , we have $\varphi(-S, F) = (-S, -X) = -(S, X) = -\varphi(S, F)$. As $\widetilde{\mathcal{M}}$ has rank d , the poset $\mathcal{L}(\widetilde{\mathcal{M}})$ is a $(d-1)$ -sphere by Theorem 6.12, and hence the conclusion follows from the Borsuk-Ulam Theorem. \square

6.3. Pseudosphere Arrangements from Regular Cell Complexes. The following result shows how to get pseudosphere arrangements from regular cell complexes:

Theorem 6.12 ([5, Theorem 4.3.3, Proposition 4.3.6]). *Let \mathcal{M} be an oriented matroid of rank d on the ground set E . Let Δ be a regular cell complex with face poset \mathbf{P} , such that there is a poset isomorphism $\mathbf{P} \simeq \mathcal{L}(\mathcal{M})$. Thus each cell σ_X of Δ is labeled by some non-zero covector X of \mathcal{M} . For each $k \in E$, define the subcomplex*

$$\Delta_k := \{\sigma_X \in \Delta : X_k = 0\}.$$

Then $\|\Delta\|$ is a $(d-1)$ -sphere, and the spaces $\|\Delta_k\|$ ranging over all $e \in E$ form an arrangement of pseudospheres within $\|\Delta\|$ representing \mathcal{M} .

Remark 6.13. This theorem is really the uniqueness assertion of [5, Theorem 4.3.3], whose proof can be traced back to [5, Proposition 4.7.23].

6.4. Putting it all Together. With all the pieces now in place, we are ready to prove Theorem 3.5, which asserts that our patchworking procedure yields a pseudosphere representation of $\widetilde{\mathcal{M}}$.

Proof of Theorem 3.5. As shown for Proposition 6.3, a fine mixed subdivision \mathbf{S} of $n\Delta_{d-1}$ gives rise to an elimination system as in Definition 4.1. Abusing notation, we denote this elimination system also by \mathbf{S} . We let $\mathbf{P}(\mathbf{S})$ be the poset of \mathbf{S} obtained by introducing signs as in Definition 4.2.

Let $\mathbf{P}(\Delta)$ denotes the face poset of $\Delta = \bigcirc_{\mathbf{S}}^{\vee}$. By Corollary 6.4, we have $\mathbf{P}(\Delta) \simeq \mathbf{P}(\mathbf{S})$. Hence the poset quotient $\mathbf{P}(\mathbf{S})/\sim_A$ induces a quotient $\mathbf{P}(\Delta)/\sim_A$. By Theorem 4.12, then, $\mathbf{P}(\Delta)/\sim_A$ admits a factorization $\mathbf{P}(\Delta) = \mathbf{P}_0, \mathbf{P}_1, \dots, \mathbf{P}_k = \mathbf{P}(\Delta)/\sim_A$ into elementary quotients, such that the augmented poset $\mathcal{L}(\mathbf{P}_i)$ is a lattice for each $i = 0, 1, \dots, k-1$.

As a polyhedral complex on the boundary of a d -dimensional polytope, $\bigcirc_{\mathbf{S}}$ is a PL $(d-1)$ -sphere. Hence, by Proposition 5.12, $\Delta = \bigcirc_{\mathbf{S}}^{\vee}$ is also a PL $(d-1)$ -sphere. In particular, by Proposition 5.11, each cell σ^{\vee} in Δ is a PL ball. It follows, by Corollary 5.16, that Δ/\sim_A is a regular cell complex with face poset $\mathbf{P}(\Delta)/\sim_A$. In particular, $\mathbf{P}(\Delta)/\sim_A$ is a $(d-1)$ -sphere.

By Corollary 6.10, we have isomorphisms $\mathbf{P}(\Delta)/\sim_A \simeq \mathbf{P}(\mathbf{S})/\sim_A \simeq \mathcal{L}(\widetilde{\mathcal{M}})$. For $k \in \tilde{E}$, define the subcomplex

$$(\Delta/\sim_A)_k := \left\{ \bigcup (\sigma_{(S,F)}^{\vee}/\sim_A) \in \Delta/\sim_A : \varphi(S, F)_k = 0 \right\}$$

of Δ/\sim_A . Now, Theorem 6.12 implies that the spaces $\|(\Delta/\sim_A)_k\|$ ranging over all $k \in \tilde{E}$ form an arrangement of pseudospheres within $\|\Delta/\sim_A\| = \|\Delta\|$ representing $\tilde{\mathcal{M}}$.

It remains to show that $\|(\Delta/\sim_A)_k\| = \|\Delta_k\|$ for all $k \in \tilde{E}$, where Δ_k is a subcomplex of Δ defined in (2) and (3). For this note that the closed cells of Δ/\sim_A , and hence all subcomplexes of Δ/\sim_A , each consist of a union of members of Δ . Hence, it suffices to show that for all $\sigma^\vee \in \Delta$ and $k \in \tilde{E}$, we have $\sigma^\vee \subseteq \|(\Delta/\sim_A)_k\|$ if and only if $\sigma^\vee \in \Delta_k$.

For $\sigma^\vee \in \Delta$ and $k \in \tilde{E}$, we have $\sigma^\vee \subseteq \|(\Delta/\sim_A)_k\|$ if and only if there exists $(S, F) \in \mathcal{P}(\mathcal{S})$ such that $\varphi(S, F)_k = 0$ and

$$\sigma^\vee \subseteq \bigcup_{(S, G) \sim_A (S, F)} \sigma_{(S, G)}^\vee.$$

As Δ is a regular cell complex, the interiors of the balls in Δ are disjoint, and so the above containment holds true if and only if $\sigma^\vee = \sigma_{(S, F)}^\vee$ for some $(S, F) \in \mathcal{P}(\mathcal{S})$ such that $\varphi(S, F)_k = 0$. If $k \in \mathcal{R}$, then $\varphi(S, F)_k = 0$ iff $S_k = 0$. If $k \in \mathcal{E}$, we have $\varphi(S, F)_k = 0$ if and only if there exist $(i, k), (\ell, k) \in F$ such that $S_i A_{i, k} = -S_\ell A_{\ell, k} \neq 0$. In either case, we conclude $\sigma^\vee \subseteq \|(\Delta/\sim_A)_k\|$ if and only if $\sigma^\vee \in \Delta_k$. \square

ACKNOWLEDGEMENT. The first author was funded by the Deutsche Forschungsgemeinschaft (DFG, German Research Foundation) under Germany's Excellence Strategy – The Berlin Mathematics Research Center MATH+(EXC-2046/1, project ID: 390685689). He is grateful to Josephine Yu for helpful discussions on patchworking, in particular pointing out the reference [30]. This project has received funding from the European Research Council (ERC) under the European Union's Horizon 2020 research and innovation programme (grant agreement n° ScaleOpt-757481). The second author also thanks Xavier Allamigeon and Mateusz Skomra for inspiring discussions and Ben Smith for helpful comments. The third author was supported by Croucher Fellowship for Postdoctoral Research and Netherlands Organisation for Scientific Research Vici grant 639.033.514 during his affiliation to Brown University and University of Bern, respectively. He also thanks Cheuk Yu Mak for pointing out [28]. The second and third author both thank the *Tropical Geometry, Amoebas, and Polyhedra* semester program at Institut Mittag-Leffler for the introduction that started the project. The authors thank Laura Anderson and Jesus De Loera for comments on our work.

REFERENCES

1. Federico Ardila and Sara Billey, *Flag arrangements and triangulations of products of simplices*, Adv. Math. **214** (2007), no. 2, 495–524.
2. Federico Ardila and Mike Develin, *Tropical hyperplane arrangements and oriented matroids*, Math. Z. **262** (2009), no. 4, 795–816.
3. Federico Ardila, Caroline Klivans, and Lauren Williams, *The positive Bergman complex of an oriented matroid*, European J. Combin. **27** (2006), no. 4, 577–591.
4. Benoît Bertrand, Erwan Brugallé, and Arthur Renaudineau, *Haas' theorem revisited*, Épijournal Geom. Algébrique **1** (2017), Art. 9, 22.
5. Anders Björner, Michel Las Vergnas, Bernd Sturmfels, Neil White, and Günter M. Ziegler, *Oriented matroids*, Encyclopedia of Mathematics and its Applications, vol. 46, Cambridge University Press, Cambridge, 1993.
6. Marcel Celaya, *Lattice points, oriented matroids, and zonotopes*, 2019, Ph.D. Thesis, Georgia Institute of Technology.

7. Marcel Celaya, Georg Loho, and Chi Ho Yuen, *Oriented matroids from triangulations of products of simplices*, 2020, preprint arXiv:2005.01787.
8. J. A. de Loera, *Nonregular triangulations of products of simplices*, *Discrete Comput. Geom.* **15** (1996), no. 3, 253–264.
9. Jesús A. De Loera, Jörg Rambau, and Francisco Santos, *Triangulations*, Algorithms and Computation in Mathematics, vol. 25, Springer-Verlag, Berlin, 2010, Structures for algorithms and applications.
10. Jesús A. De Loera and Frederick J. Wicklin, *On the need of convexity in patchworking*, *Adv. Appl. Math.* **20** (1998), no. 2, 188–219 (English).
11. Mike Develin and Bernd Sturmfels, *Tropical convexity*, *Doc. Math.* **9** (2004), 1–27 (electronic), erratum *ibid.*, pp. 205–206.
12. Jon Folkman and Jim Lawrence, *Oriented matroids*, *J. Combin. Theory Ser. B* **25** (1978), no. 2, 199–236.
13. Ewgenij Gawrilow and Michael Joswig, *polymake: a framework for analyzing convex polytopes*, Polytopes—combinatorics and computation (Oberwolfach, 1997), DMV Sem., vol. 29, Birkhäuser, Basel, 2000, pp. 43–73.
14. I. M. Gelfand, M. M. Kapranov, and A. V. Zelevinsky, *Discriminants, resultants, and multidimensional determinants*, Mathematics: Theory & Applications, Birkhäuser Boston, Inc., Boston, MA, 1994.
15. Joshua Hallam and Bruce Sagan, *Factoring the characteristic polynomial of a lattice*, *J. Combin. Theory Ser. A* **136** (2015), 39–63.
16. A. Hatcher, Cambridge University Press, and Cornell University. Dept. of Mathematics, *Algebraic topology*, Algebraic Topology, Cambridge University Press, 2002.
17. Patricia Hersh, *Regular cell complexes in total positivity*, *Invent. Math.* **197** (2014), no. 1, 57–114.
18. Silke Horn, *A topological representation theorem for tropical oriented matroids*, *J. Combin. Theory Ser. A* **142** (2016), 77–112.
19. J.F.P. Hudson, J.L. Shaneson, and Chicago (Ill.). University. Dept. of Mathematics, *Piecewise linear topology*, Mathematics lecture note series, no. Bd. 1, Department of Mathematics, University of Chicago, 1967.
20. Ilia Itenberg and Eugeni Shustin, *Combinatorial patchworking of real pseudo-holomorphic curves*, *Turkish J. Math.* **26** (2002), no. 1, 27–51.
21. Michael Joswig, *Tropical halfspaces*, Combinatorial and computational geometry, *Math. Sci. Res. Inst. Publ.*, vol. 52, Cambridge Univ. Press, Cambridge, 2005, pp. 409–431.
22. ———, *Essentials of tropical combinatorics*, in preparation.
23. Christian Jürgens, *Real tropical singularities and Bergman fans*, 2018, preprint arXiv:1802.01838.
24. Georg Loho and Ben Smith, *Matching fields and lattice points of simplices*, *Advances in Mathematics* **370** (2020), 107232.
25. Grigory Mikhalkin, *Amoebas of algebraic varieties and tropical geometry*, Different faces of geometry, *Int. Math. Ser. (N. Y.)*, vol. 3, Kluwer/Plenum, New York, 2004, pp. 257–300. MR 2102998
26. Suho Oh and Hwanchul Yoo, *Triangulations of $\Delta_{n-1} \times \Delta_{d-1}$ and tropical oriented matroids*, 23rd International Conference on Formal Power Series and Algebraic Combinatorics (FPSAC 2011), *Discrete Math. Theor. Comput. Sci. Proc.*, AO, Assoc. Discrete Math. Theor. Comput. Sci., Nancy, 2011, pp. 717–728.
27. Arthur Renaudineau and Kristin Shaw, *Bounding the betti numbers of real hypersurfaces near the tropical limit*, 2019, preprint arXiv:1805.02030.
28. Daniel Ruberman and Laura Starkston, *Topological realizations of line arrangements*, *Int. Math. Res. Not. IMRN* (2019), no. 8, 2295–2331.
29. Francisco Santos, *The Cayley trick and triangulations of products of simplices*, Integer points in polyhedra—geometry, number theory, algebra, optimization, *Contemp. Math.*, vol. 374, Amer. Math. Soc., Providence, RI, 2005, pp. 151–177.
30. Bernd Sturmfels, *Viro’s theorem for complete intersections*, *Ann. Scuola Norm. Sup. Pisa Cl. Sci. (4)* **21** (1994), no. 3, 377–386.
31. Oleg Viro, *Gluing algebraic hypersurfaces and constructions of curves*, Tezisy Leningradskoj Mezhdunarodnoj Topologicheskoy Konferentsii 1982, Nauka, 1983, pp. 149–197 (Russian).
32. ———, *Patchworking real algebraic varieties*, 2006, preprint arXiv:0611382.

TECHNISCHE UNIVERSITÄT BERLIN, INSTITUT FÜR MATHEMATIK, SEKR. MA4-1,
STRASSE DES 17 JUNI 136, D-10623 BERLIN
Email address: celaya@math.tu-berlin.de

DEPARTMENT OF MATHEMATICS, LONDON SCHOOL OF ECONOMICS AND POLITICAL
SCIENCE, LONDON, WC2A 2AE, UK
Email address: g.loho@lse.ac.uk

DIVISION OF APPLIED MATHEMATICS, BROWN UNIVERSITY, PROVIDENCE, RI
02912, USA
Email address: Chi.Ho.Yuen@Brown.edu