

Are Crises Predictable? An Review of the Early Warning Systems in the Currency and Stock Markets

Peiwan Wang^{a,b}, Lu Zong^{a,b,*}

^a*Department of Mathematical Sciences, Xi'an Jiaotong-Liverpool University.*

^b*111 Ren'ai Road, Dushu Lake Science and Education Innovation District, Suzhou Industrial Park, Suzhou, Jiangsu Province, P.R. China, 215123.*

Abstract

The study efforts to explore and extend the crisis predictability by synthetically reviewing and comparing a full mixture of early warning models into two constitutions: crisis identifications and predictive models. Given empirical results on Chinese currency and stock markets, three-strata findings are concluded as (i) the SWARCH model conditional on an elastic thresholding methodology can most accurately classify crisis observations and greatly contribute to boosting the predicting precision, (ii) stylized machine learning models are preferred given higher precision in predicting and greater benefit in practicing, (iii) leading factors sign the crisis in a diversified way for different types of markets and varied prediction periods.

1. Introduction

1.1. Crisis predictability

The predictability of financial crises is a continually debating open question and yet settled through trans-centuries' arguments among economists and practitioners. The core of controversies focuses on whether the crisis is triggered by unexpected exogenous factors or the market endogenous instability. According to the classic Efficient Market Hypothesis (EMH) theory that is proposed by Malkiel and Fama in 70's of last century, the securities prices in an ideal market can fully reflect all available information and the financial crises occur as long as external shocks, known as the 'black swan' factors, arise. In that situation, governors can contribute little to minimize the economic losses after the crisis. Malkiel and Fama (1970)' theory shows strong assumption on human behaviours' rationality, however market participants are hardly to be always rational and quickly respond to market information in practice. Arthur (1999) then relax the strong assumption by pointing out the evolution process of the economy is dynamic, nonlinear and uncertain, which also inherently coincides to Schiller (2000)'s revolutionary proposal of the market endogenous imperfection being mainly induced by the irrational factors. In fact, the essence of this argument fertilizes the flourishing studies on financial crisis forecasting system development as the theoretic basis renders inclination to dilute the assertion that crisis is randomly unpredictable. Sornette (2009) formally advocates the argument that crises are predictable, as the study announced, the crisis is the 'dragon-king', not the unpredictable 'black swan', since before the crisis abruptly bursts, precursory symptoms like substantial outliers, will be teeming observed in reality. It is inspiring to acknowledge the crisis predictability with a positive attitude given a series of rigorous statistical test on predicted results, even though yet deliver 100% trust. EMH (Malkiel and Fama, 1970) and 'dragon-king' (Arthur, 1999; Schiller, 2000; Sornette, 2009) holders, they both admit the fact that perfectly grasping the exact time of crises seems less attainable, but gaining the awareness on precursory signals of potential financial shocking in advance is achievable.

1.2. Comparative early warning system

The disputes between two against arguing mainstreams are yet settled, particularly in the contemporary data science background, academics and practitioners have ignited a great volume of diligent works on developing early warning systems to back up the precursory evidence before crisis shocking occurs. The first generation of crisis prediction studies started up in the late 1990's, which concentrates to apply the economic models

*Corresponding author

Email address: Lu.Zong@xjtlu.edu.cn (Lu Zong)

and statistical approaches (Eichengreen et al., 1995; Frankel and Rose, 1996; Patel and Sarkar, 1998; Berg and Pattillo, 1999b; Kaminsky and Reinhart, 1999; Kaminsky et al., 1998) to forecast nationwide banking and currency crises. The vulnerability of crisis may not be convincingly revealed by first generation of models cluster, as IMF published paper (Berg and Pattillo, 1999a) summarized and exercised on the 1997 Asian currency crisis, their predicting power is barely satisfactory unless under plausible modifications. Machine learning techniques (Nag and Mitra, 1999; Oh et al., 2006; Celik and Karatepe, 2007) are then locked to construct the second generation of early warning systems considering its specialization on predicting big size non-linear data. The impetus brought by these state-of-art models accelerates the progress of predicting financial crises in the data driven situation (Holopainen and Sarlin, 2017; Beutel et al., 2019), albeit gives concessions to the interpretable expressiveness on detecting leading crisis factors. In general, there are three layers of absences in both first and second generations of crisis predicting model. First, most studies identify the crisis observations on the single index with an arbitrary cutoff, that lacks the elasticity as the back-forward looking historic sample horizons are varied. Second, the good-of-fitness evaluation is either deficient or ambiguous on marking the leading time, such as Bussiere and Fratzscher (2006); Sevim et al. (2014) estimate the probability of crisis occurring within a future horizon interval to soothe the pain of matching to exact crashing time point (this is actually the case of omission for measuring leading time), Kaminsky et al. (1998); Dawood et al. (2017) state each leading factors that contribute to the crisis warning thus the leading period is given by counting the periods of leading indicators in advance of the first crisis signal occurs (there are a series of factors leading time), and Kim et al. (2004); Oh et al. (2006) directly chronicles the crashing event and the produced signaling levels to visualize how the output precedes to the true crises (impacting but not applicable to high-frequency and long-horizon data). Last, the developed predicting system is rarely assessed in practice. Specifically, it is indispensable to test whether the investors' wealth will be gained as the crisis forecasting system participates.

A board scope of theoretical and experimental research studies on either developing crisis predictive models or investigating leading economic factors for a wide range of countries in various development situations, such as developed, developing, emerging, and low-income countries (Frankel and Rose, 1996; Demirgüç-Kunt and Detragiache, 1998; Koyuncugil and Ozgulbas, 2012; Babecký et al., 2013; Kim et al., 2020) have been explored by scholars and practitioners. For policymakers, institutional researchers and public investors, to have a competent early warning system (EWS) to forewarn the crisis, is equivalent to grasp the opportunity to counter the risks that potentially lead destructive damaging as well as to make the economy vigorously circulating and the society comfortably steady-going. Thus, how to distinguish robust EWS model among a great quantity of qualified models based on prominent predictive models seems more than momentous. In fact, the horse race among EWS models (Holopainen and Sarlin, 2017) that predict either macroscopic economic crises or market-specific turbulence, has never been suspended, especially in comparing the merits and shortages between the classic regression models and stylized machine learning techniques. Sevim et al. (2014) compare the EWS models developed with binary logistic regressions and machine learning techniques of artificial neural networks (ANN) and decision trees to predict the Turkish currency crisis and accredit that both decision supporting models and ANNs superior to the traditional regression models. The against conservative opinion, as Beutel et al. (2019) which systematically examine the out-of-sample performance for almost full series of proposed EWS models hold, deems that the conventional logit regression is fairly efficient to predict systematic banking crises, machine learning based EWS models however need more enhancements before being fully granted in real-world prediction. Such comparison studies, though predicting models are categorized and uniformly verified, yet comprehensively discuss the varied crisis definitions but thetically adopt one classifier for harmonizing comparison metrics in convenience. Therefore, to fully explore the comparative EWS models, various combinations of different types of classifiers and predictive models are required to be implemented and investigated.

1.3. Objective

Our aim is not either to advocate the EWS predicting as mythological oracle or to investigate all proposed EWS models with a overloaded ambition. We effort to preen the pending issues in comparative EWS models with the hope to inspire further exploring sparkles for subsequent researches. To implement this goal, we specify candidate EWS models that will be compared in a unified frameworks with two partitioned constituents to sensibly reason their potentials in addressing crisis identification and warning signal production challenges. In addition to use the chronology critical events, we novelly bootstrap the classified samples and calculate the average misspecification rates to reveal the classifier performance in an statistically objective way. To support the investors render better verdicts in a credible and operational way, we propose the EWS participated portfolio constructing process and compare the Sharpe ratios and CER values under varied aversion levels.

The study will be explored in the following sequence. Section 2 will review and summarize the EWS models in terms of crisis classification techniques, predictive models, performance measurements and variable contributing

degree estimation. Section 3 shows the empirical results of examining EWS models on Chinese currency and stock markets in terms of classified crisis observations, model predicting robustness and detected leading crisis factors respectively. Section 4 will conclude the compared results and key implications, as well as give further suggestion and discussion.

2. Methodology Reviews

Main concerns for developing EWS models embody into two aspects, that respective pros and cons are yet systematically reviewed in terms of structural components of (1) the identification techniques for labelling crisis observations with data frequency variations¹, and (2) the predictive models' forecasting power of producing warning signals in a unified measurement frameworks.

The current developed EWS models are mainly designed for two types of financial crisis: the crisis that concerns the systematic risks, such as the banking crisis and the debt crisis, and the market specific crisis that relates more to iconic price or index dynamics' turbulences, such as the currency and stock market crashes. The classification for first type of crisis gravely relies on central bank's reports, financial institution research publications and experts' opinions (Demirgüç-Kunt and Detragiache, 1998; Kaminsky and Reinhart, 1999; Lestano et al., 2004; Beckmann, 2007; Celik and Karatepe, 2007; Davis and Karim, 2008; Reinhart and Rogoff, 2011; Dawood et al., 2017), which data are either difficult to quantized (Davis and Karim, 2008) or costly to access for the public. Otherwise, the market specific crisis dating technique that commonly labels the crisis level of the market price index or the technically quantized price index (TQI)², such as the exchange market pressure index (Patel and Sarkar, 1998; Lestano et al., 2004; Peng and Bajona, 2008; Yu et al., 2010; Sevim et al., 2014) and the market instability index (Kim et al., 2009; Yoon and Park, 2014; Li et al., 2015; Chatzis et al., 2018) are more accessible and processable.

The TQI classifier is though popular for market crisis studies, generally puzzled by the crisis cutoff determination, in other words, the value of threshold to produce crisis observations is either crudely imposed a arbitrary value (or a fixed percentile) or mildly taken the mean plus a factor of standard deviations, which fails to dynamically adapt to the crisis severity level in different market turbulence scenarios. An alternative path to classify the market specific crisis is in virtue of the Markovian switching regime model, which first clusters observations into several leveled (for example, low- and high-) volatility states and then recognizes crises by taking (conventionally) the top half of the filtering probability for high-volatility state (Hamilton and Susmel, 1994; Hamilton and Gang, 1996; Abiad, 2007). The gap of cutoff optimization is further bridged according to the market turmoil level variation by imposing an automatically thresholding approach on the two-peak methodology theoretical basis (Rosenfeld and Torre, 1983; Ohtsu, 2007) on the SWARCH classifier. This dynamically adaptive classifier has been successfully verified in predicting stock crashes (Wang et al., 2020a). The other issue that is rarely mentioned in previous studies for EWS classifier construction is the variation of data frequency. The crisis observed on low frequently distributed data, such as monthly, quarterly and annually data, includes the pre-crisis effect into the crisis binary dependent variable definition (Bussiere and Fratzscher, 2006; Sevim et al., 2014; Candelon et al., 2014), which is reasonable to instruct the long term macro-economic policy adjustments, but yet suitable to direct short term investment portfolio improvement. While, for daily data, to imitate the timeliness in real trading scenarios, it seems more reasonable to eliminate the pre-crisis effect from the crisis variable definition. Except the issue of determining 'true' crisis labels, how to validate the classifier's credibility is alike pended, specifically, the way of listing the chronology of historic crisis events or significant turning point for crises against the classifiers' dated crisis episodes (Oh et al., 2006; Abiad, 2007) lacks of statistical persuasion. In the study, a more logical validation approach will be proposed to examine the classifier's performance besides the chronological table list.

The predictive models that support EWS constructions will be clustered as three main branches: the logit/probit regression model - which classic methodology pioneers the EWS construction and keeps most prevailing in the crisis prediction studies (Eichengreen et al., 1995; Frankel and Rose, 1996; Berg and Pattillo, 1999b; Bussiere and Fratzscher, 2006; Candelon et al., 2014; Dawood et al., 2017); the indicator approach - which provides an alternative nonparametric methodology to detect the leading factors and uses the refined factors to construct the crisis indicator (Kaminsky et al., 1998; Kaminsky and Reinhart, 1999; Lestano et al., 2004; Berg et al., 2005; Coudert and Gex, 2008; Reinhart and Rogoff, 2011, 2013; Peng and Bajona, 2008); the state-of-art machine learning and deep learning models (Nag and Mitra, 1999; Oh et al., 2006; Celik and Karatepe, 2007; Yu et al., 2010; Yoon and Park, 2014; Chatzis et al., 2018; Beutel et al., 2019; Wang et al.,

¹To the best of our knowledge, most studies yet clearly pinpoint how data frequency effect the EWS model performance.

²TQI is commonly a composite of weighing several market price index factors.

2020a; Samitas et al., 2020) - which are not merely expert in modeling the data with significant non-linearity and non-normality, but barely subject to the data size as well. Comparing to the first two classic models, the stylized machine learning models generally perform best in forecasting ability, but meanwhile suffers the pain of deteriorating performance on out-of-samples as the model structure complexity is gained that leads serious over-fitting effect (Beutel et al., 2019; Holopainen and Sarlin, 2017) especially for low frequency data prediction. To evaluate the EWS performance in a unified frameworks, metrics will be categorized into three types: first, the calibration of scores, such as QPS (Quadratic Probability Score), Youden J and SAR; second, the hit-ratio or goodness-of-fit based on the statistics of correct predicted signals and produced false alarms; and third, the back-testing and reality check in practice. The leading factors that greatly contribute to producing crisis signals will also be estimated and compared among three models, such as the parametric coefficients in the logistic regression, the noise-to-signal ratio (NSR) value in KLR approach, feature importance in neural networks and classification trees, and attention weight in attention mechanism hybrid recurrent neural networks (Wang et al., 2020b).

2.1. Crisis classifiers

2.1.1. Technically quantized index (TQI)

Eichengreen et al. (1995), Frankel and Rose (1996) and Kaminsky et al. (1998) almost simultaneously propose the concept of EWS for currency crisis prediction. To quantize the crisis variable into binary case for zero and one, the market pressure index of EPI is defined. Specifically, the formula for EPI are different in Eichengreen et al. (1995) and Kaminsky et al. (1998), which are denoted as EPI_{ERW} and EPI_{KLR} in the following formulae respectively.

$$EPI_{ERW} = \frac{1}{\sigma_e} \frac{\Delta e_t}{e_t} - \frac{1}{\sigma_r} \left(\frac{\Delta r m_t}{r m_t} - \frac{\Delta r m_{US,t}}{r m_{US,t}} \right) + \frac{1}{\sigma_i} \Delta(i_t - i_{US,t}) \quad (1)$$

$$EPI_{KLR} = \frac{\Delta e_t}{e_t} - \frac{\sigma_e}{\sigma_r} \frac{\Delta r_t}{r_t} + \frac{\sigma_e}{\sigma_i} \Delta u_t, \quad (2)$$

e_t denotes the currency exchange rate per US dollars and $\frac{\Delta e_t}{e_t}$ is the relative change in the exchange rate. σ_e is the standard deviation for $\frac{\Delta e_t}{e_t}$. Since the US is the reference country for EPI_{ERW} construction, $(\frac{\Delta r m_t}{r m_t} - \frac{\Delta r m_{US,t}}{r m_{US,t}})$ and σ_r are the difference between the relative change in the ratio of foreign reserves and M1 and the reference country and its standard deviation respectively. σ_i is the standard deviation of nominal interest rate differential of $\Delta(i_t - i_{US,t})$. In the EPI_{KLR} , e_t , Δe_t and σ_e keep same as EPI_{ERW} . σ_r denotes the standard deviation of the relative change in the gross foreign reserves $\frac{\Delta r_t}{r_t}$ and σ_i denotes the standard deviation for the nominal interest rate change Δi_t .

Lestano et al. (2004) and Lestano (2007) then further compare the sensitivity of dating currency crisis under between EPI_{ERW} (Eichengreen et al., 1995) and EPI_{KLR} (Kaminsky et al., 1998) to different thresholds by varying the value of λ , and find the EPI_{KLR} is the preferred index with higher sensitivity. Sevim et al. (2014) validates the conclusion and further proposes a more concise index of financial pressure index (FPI) to measure the currency crisis in a standardized average among gross foreign exchange reserves, exchange rate and interest rate, which reasonably synthesizes domestic currency and expels the dispute of choosing the reference country.

$$FPI_t = \frac{1}{3} \left(\frac{e_t - \mu_e}{\sigma_e} - \frac{r_t - \mu_r}{\sigma_r} + \frac{i_t - \mu_i}{\sigma_i} \right), \quad (3)$$

where e_t, r_t and i_t are the percentage changes in the exchange rate, monthly gross foreign exchange reserves and monthly change of overnight interest rates at time t , respectively. μ 's and σ 's are the mean and standard deviation value for each accounted terms.

The crisis variable, in our study, thus will be constructed by hiring the binary function of

$$C_t = \begin{cases} 1, & \text{if } FPI_t > \mu_{FPI} + \lambda_{fpi} \sigma_{FPI} \\ 0, & \text{otherwise.} \end{cases} \quad (4)$$

μ_{FPI} and σ_{FPI} are the mean and standard deviation for the FPI, and λ is the coefficient to control the bound to classify crisis observations.

One of the top cited study of Bussiere and Fratzscher (2006), greatly contributes to specify the crisis variable including either the pre-crisis effect or both of the pre-crisis and post-crisis effect, in other words, the binary forward-looking or the ternary forward- and backward-looking variable will be defined to grasp the

crisis information in a fixed window of future and past period to rationalize the goal of predicting ‘whether a crisis occurs within a specific time horizon’ and fixing ‘post-crisis bias that fails to distinguish between tranquil periods and recovery periods’. For the long-term predicting system, the post-crisis bias effect, however, keeps controversial in EWS studies since the crisis variable that covers the sustainable impact distracts the goal of early notifying warning signals. In the study, the binary case which is same defined as Bussiere and Fratzscher (2006) will be adopted for allowing the general comparisons with other binary classified models (Berg and Pattillo, 1999b; Lestano et al., 2004; Abiad, 2007; Davis and Karim, 2008; Sevim et al., 2014). The definition is listed as follows.

$$Y_t = \begin{cases} 1 & \text{if } \exists k = 0, \dots, 12^3 \text{ s.t. } C_{t+k} = 1, \\ 0 & \text{otherwise.} \end{cases} \quad (5)$$

For stocks, the crisis variable refers to the quantified index of CMAX, which is first proposed in Patel and Sarkar (1998) and further developed in studies of either dating equity market risks or predicting stock crashes (Coudert and Gex, 2008; Li et al., 2015; Fauzi and Wahyudi, 2016; Fu et al., 2019). CMAX is a ratio index of maximizing the period up to t within the past rolling window size of m^4 .

$$CMAX_t = \frac{P_t}{\max(P_t, \dots, P_{t-m})} \quad (6)$$

P_t is the price index at time t . The binary crisis variable for short-term will be similarly defined as follows and the ‘perfect signaling’ variable for long-term keeps the same with equation (2.1.1).

$$C_t = \begin{cases} 1, & \text{if } CMAX_t \leq \mu_{CMAX} - \lambda_{cmx} \sigma_{CMAX} \\ 0, & \text{otherwise.} \end{cases} \quad (7)$$

As Table 1 lists, the upper panel shows calculating formulae for classic TQI defined crisis variables. In this study, to make the classifier generally comparable, the TQI of FPI and $CMAX$ will not use the ad-hoc thresholding coefficient $\lambda_{fpi} = 3$ and $\lambda_{cmx} = 2.5$ but gradient search a series of values to define the best performed crisis binary dependent variable for currency and stock markets respectively.

2.1.2. Markov regime switching model (SWARCH)

An flexible alternative to define the crisis by distinguishing the volatility state between tranquil and turmoil periods is inspired by Hamilton and Susmel (1994), which study proposes the SWARCH model to project the market turmoil level in the business cycle by first clustering the (price) index into different regimes/states and then inferring the probability of observations staying in high-volatility state. Its robustness in financial crisis and contagion detections have been further studied and verified (Ramchand and Susmel, 1998; Edwards and Susmel, 2001; BenSaïda, 2018; Wang and Zong, 2019). IMF has (Abiad, 2007) straightforward adopted the SWARCH to predict the currency crisis in Asian countries, which intrinsically defines the crisis dependent variable based on half cutting the filtering probability for high-volatility state (that will be referred as FPH in the following content). Given consistency of conserving the pre-crisis effect for long-term prediction, Abiad (2007) similarly defines a ‘perfect signal variable’ to indulge a 12 months window length for long-term forecasting. Table 2 shows the long-term dependent variable Y_t based SWARCH as an equivalent transformation of the short-term forecasting⁵.

In the study, we adopted AR(p)-SWARCH(K,q) model to classify the stock and currency price index volatility.

$$y_t = u + \theta_1 y_{t-1} + \theta_2 y_{t-2} + \dots + \theta_p y_{t-p} + \epsilon_t, \epsilon_t | \mathcal{I}_{t-1} \sim N(0, h_t); \quad (8)$$

$$\frac{h_t^2}{\gamma_{s_t}} = \alpha_0 + \alpha_1 \frac{\epsilon_{t-1}^2}{\gamma_{s_{t-1}}} + \dots + \alpha_q \frac{\epsilon_{t-q}^2}{\gamma_{s_{t-q}}}, s_t = \{1, \dots, K\}. \quad (9)$$

ϵ_t is normally distributed error term with variance of h_t . α 's are non-negative coefficients for modeling scaled variance term, γ 's are scaling parameters relating to the state-dependent variable s_t . There are K regimes for

⁴The rolling window size is customarily equal to 24. In our study, the lengthy window however will result in unexpected information loss, hence shorter length of 12 will be substituted

⁵The deriving process of the transformed equivalence is referred to Abiad (2007). It constructs on the imposed assumption of the crisis probability in the future months will be neither worsen or improved.

Table 1: The table summarizes crisis dating methodologies.

Classifier	Market	Index	Formula	Sourced reference
			$C_{i,t}^a = 1 \text{ if } \% \Delta e_{i,t}^b > 25\%$ $\text{and } \% \Delta e_{i,t} > (10\% + \% \Delta e_{i,t-1})$	Frankel and Rose (1996)
			$C_{i,t} = 1 \text{ if } EPI_{i,t} > \mu_{EPI_t}^c + 2\sigma_{EPI_t}^c$	Eichengreen et al. (1995)
			$C_{i,t} = 1 \text{ if } EPI_{i,t} > \mu_{EPI_t} + 3\sigma_{EPI_t}$	Kaminsky et al. (1998)
	currency	<i>EPI</i>	$Y_{i,t}^d = 1 \text{ if } \exists k = 1, \dots, 12 \text{ s.t. } C_{i,t+k} = 1$ $Y_{i,t} = 2 \text{ if } \exists k = 0, \dots, p \text{ s.t. } C_{i,t-k} = 1$	Bussiere and Fratzscher (2006)
TQI			$C1_{i,t}^e = 1 \text{ if } KLRm_{i,t}^f > \mu_{KLRm_t} + 2\sigma_{KLRm_t}$ $C6_{i,t} = 1 \text{ if } \sum_{j=1}^6 C1_{i,t+j} > 0$	Candelon et al. (2014)
	currency	<i>FPI</i>	$K_t = 1 \text{ if } FPI_t > \mu_{FPI_t} + 3\sigma_{FPI_t}$ $P_{S_t} = 1 \text{ if } \exists k = 1, \dots, 12 \text{ s.t. } K_{t+k} = 1$	Sevim et al. (2014)
	stock	<i>CMAx</i>	$CC_t = 1 \text{ if } CMAx_t \leq \mu_{CMAx_t} - 2.5\sigma_{CMAx_t}$ $Y_t = 1 \text{ if } \exists k = 0, \dots, 12 \text{ s.t. } CC_{t+k} = 1$ $Y_t = 2 \text{ if } \exists k = 1, \dots, 11 \text{ s.t. } CC_{t-k} = 1$	Li et al. (2015)
	stock		$C_t = 1 \text{ if } FPH_t > 0.5$	Hamilton and Susmel (1994)
SWARCH			$C_t = 1 \text{ if } FPH_t > c,$ <p>where c is the two-peak method optimized cutoff value.</p>	Wang et al. (2020a)
	currency		$C_t = 1 \text{ if } 1 - (1 - FPH_t)^{12} > 0.5,$ <p>where 12 is the length of predictive months.</p>	Abiad (2007)

^a $C_{i,t}$ is the crisis variable for country i at time t .

^b $\% \Delta e_{i,t}$ denotes the nominal depreciation of the currency for country i in the period t .

^c μ and σ is the mean and standard deviation of the defined index.

^d $Y_{i,t}^d$ is the look-forwarding dependent variable with more than two values of 0 (for non-crises) and 1 (for crises) being proposed for solving the *post-crisis bias*.

^e $C1_{i,t}$ is same with $C_{i,t}$ and $C6_{i,t}$ defines the crisis dummy variable conditioning on at least one crisis in the following six months appears, which proposes the forward looking concept to define crisis variable.

^f $KLRm$ is the modified KLR pressure index, and is formulated as $KLRm_{i,t} = \frac{\Delta e_{i,t} - \sigma_e \Delta \tau_{i,t}}{e_{i,t}} + \frac{\sigma_e \Delta \tau_{i,t}}{\sigma_\tau \tau_{i,t}} + \frac{\sigma_e \Delta i_{i,t}}{\sigma_i}$. Specific notations in the formula can be found in Candelon et al. (2014).

^g $FPH_t = \text{filtering probability for high-volatility state for time } t$.

Table 2: The table clarifies crisis dating formulae for currency and stock markets.

classifier	market	perfect signal variable	crisis variable
TQI	currency	$Y_t = 1$ if $\exists k = 1, \dots, 12$ s.t. $C_{t+k} = 1$	$C_t = 1$ if $FPI_t > \mu_{FPI_t} + \lambda_{fdi}\sigma_{FPI_t}$
	stock		$C_t = 1$ if $CMAx_t \leq \mu_{CMAx_t} - \lambda_{cmx}\sigma_{CMAx_t}$
SWARCH	currency	$Y_t = 1$ if $1 - (1 - FPH_t)^{12} > 0.5$,	$C_t = 1$ if $FPH_t > 0.5$
	stock		
SWARCH _{2pk_{opt}}	currency	$Y_t = 1$ if $1 - (1 - FPH_t)^{12} > c^{opt}$,	$C_t = 1$ if $FPH_t > c^{opt}$
	stock		

s_t to present the index volatility states, and the count of regimes is determined by the value of RCM (Ang and Bekaert, 2002; Wang et al., 2020b), which metric is proven effective to decide the most suitable value for distinguishing the volatility state.

The filtering probability for high-volatility state (FPH) that is inferred from historic observations Y_t can be written as follows

$$P(s_t = \text{high-vol.} | Y_t; \boldsymbol{\theta}_t), \quad (10)$$

$\boldsymbol{\theta}_t$ is the parameter vector to be estimated. The crisis variable is henceforth defined as

$$C_t = \begin{cases} 1, & P(s_t = \text{high-vol.} | Y_t; \boldsymbol{\theta}_t) \geq 0.5 \\ 0, & \text{otherwise.} \end{cases} \quad (11)$$

For long-term horizon prediction, we follow the definition in Abiad (2007) as

$$Y_t = \begin{cases} 1, & 1 - (1 - P(s_t = \text{high-vol.} | Y_t; \boldsymbol{\theta}_t))^{12} \geq 0.5 \\ 0, & \text{otherwise.} \end{cases} \quad (12)$$

2.1.3. SWARCH with two-peak optimized cutoff

The arbitrary cutoff in SWARCH classifier has been further improved with greater robustness in Wang et al. (2020a), that achieves dynamically identifying stock market turbulences by recursively applying the two-peak method (Rosenfeld and Torre, 1983; Ohtsu, 2007) to each newly included segment of observations to detect the valley bottom point as the optimal cutoff value in the forward moving estimation process⁶. In our study, to justify the newly proposed SWARCH classifier on the two-peak method thresholding basis performance on currency market, the study will implement both SWARCH classifiers thereafter.

The two-peak method is first proposed and applied to distinguish the difference between the object and the background grey pixels (Prewitt and Mendelsohn, 1966) by locating the frequency density histogram concavity (Rosenfeld and Torre, 1983; Weszka, 1978). The optimizing process of the cutoff value for producing crises is thus inspired by recursively applying the two-peak method to the SWARCH filtering probabilities for the high-volatility state i.e. $P(s_t = \text{high-vol.} | Y_t; \hat{\boldsymbol{\theta}}_t)$ as expanding the time horizon from $t = l$ to $t = T$, where l is the fixed window size and T is the full sample size. As the example Figure 1 shows, the orange density histogram is plotted for filtering probabilities of high-volatility state, then the concavity of histogram is detected at $c = \alpha$, thus α is the optimized cutoff for this time slice. A series of cutoff values will be produced as the time slice observations move forward, that means, the crises will be adaptive to a new cutoff as the volatility information dynamically changes.

⁶The algorithm has been specified in Wang et al. (2020a).

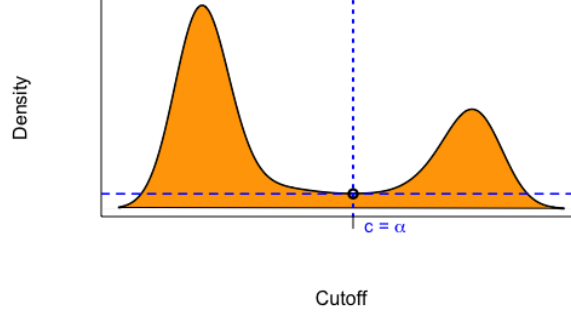

Figure 1: Illustrating the two-peak thresholding methodology: density histogram plot and the concavity detection for optimizing the cutoff value.

The binary crisis variable is thus similarly defined as

$$C_t = \begin{cases} 1, & P(s_t = \text{high-vol.} | Y_t; \boldsymbol{\theta}_t) \geq c_t^{opt} \\ 0, & \text{otherwise.} \end{cases} \quad (13)$$

For long-term horizon prediction, the crisis formula is written as

$$Y_t = \begin{cases} 1, & 1 - (1 - P(s_t = \text{high-vol.} | Y_t; \boldsymbol{\theta}_t))^{12} \geq c_t^{opt} \\ 0, & \text{otherwise.} \end{cases} \quad (14)$$

where c_t^{opt} is the two-peak optimized cutoff value for time t .

2.2. Predictive models

2.2.1. Logistic regression (LR)

Logistic regression is one of most toiling econometric models that is empirically used to construct EWS for predicting currency crisis (Eichengreen et al., 1995; Frankel and Rose, 1996; Bussiere and Fratzscher, 2006), debt crisis (Dawood et al., 2017) and financial crisis based on market index and option (Li et al., 2015). The advantage of logit regression model sticks two benefits: the latent assumption that the dependent variable is linearly linked to other explanatory variables by adding a logistically distributed error, can distinctly convey the relationship among variables and explain the model uncertainty; on the other side, coefficients (with p-value of t-test) magnify the model interpretability and reliability in discovering influential factors. To mitigating the curse of dimensionality in regressing large explanatory variables on one dependent variable, we adopt the stepwise regression to extract and retain the effective combination of variables that maximally explain the dependent variable variation. As mentioned in Beutel et al. (2019), the fixed effect will be removed from the regression since it should be more comparable to other predictive models without extra terms. The Logit regression for modeling the probability of binary crisis variable y_t at time $t \in \{1, \dots, T\}$ can be formulated as follows,

$$Pr(y_t = 1) = \frac{e^{\mathbf{x}_t \boldsymbol{\beta}}}{1 + e^{\mathbf{x}_t \boldsymbol{\beta}}}, \quad (15)$$

where the \mathbf{x}_t is the vector of explanatory variables at time t , $\boldsymbol{\beta}$ is the vector of coefficients. Coefficients will be obtained by maximum likelihood estimation and the joint log likelihood function is written as

$$\log L = \sum_{t=1}^T (y_t \log(Pr(y_t = 1)) + (1 - y_t) \log(1 - Pr(y_t = 1))). \quad (16)$$

In the stepwise backward algorithm, assumed m is the dimension of parameter vector, following steps will be attempted to search for the optimal model.

1. Establish the regression model between y and all explanatory variables of $\mathbf{x} = \{x_1, x_2, \dots, x_m\}$, and do F -test for each x , take the minimum as $F_{l_1} = \min\{F_1, F_2, \dots, F_m\}$.
2. If $F_{l_1} > F_\alpha(1, T - m + 1)$, no variable will be eliminated, the regression model is the optimal one. Otherwise, we eliminate x_{l_1} and denote the rest of variables as $\mathbf{x}_{-l_1} = \{x_1^1, x_2^1, \dots, x_{m-1}^1\}$.

3. Establish the regression model between y and \mathbf{x}_{-l_1} , again do the F -test for each x and take the minimum as $F_{l_2} = \min\{F_1^1, F_2^1, \dots, F_{m-1}^1\}$.
4. If $F_{l_2} > F_\alpha(1, (T - m + 1) - 1)$, no variable will be eliminated. Otherwise, we eliminate x_{l_2} and repeat the steps of F -test, comparing minimum with the margin and elimination, till not further variable is eliminated from the regression.

In general, the backward stepwise first put all variables into the model, and then attempt to remove one variable to examine whether significant change appears after the elimination. If there is no significant change, this elimination will be retained until all factors that lead significant change to the model are left. Thus, explanatory variables will be eliminated in turn and finally reordered according to their contribution degree to the model from small to large.

2.2.2. KLR signal extraction

KLR indicator approach is introduced in Kaminsky et al. (1998) on the basis of nonparametric methodology, which also stands out in the EWS developing realm as this signal extraction approach not only directly assesses the abnormality of single variable behaviour before or during the crisis period without the linearity assumption constraint, but provides a more comprehensive way to policy makers without training background of econometric and statistical modelling as well (Kaminsky and Reinhart, 1999; Lestano et al., 2004; Davis and Karim, 2008; Peng and Bajona, 2008), even though in the EWS model comparison study of Berg et al. (2005) and Davis and Karim (2008), the improved logit regression⁷ is proven to perform better than the signal extraction approach for predicting currency and banking crises. The approach monitors economic variables in a specified period and detects the ones deviates from the noise-to-signal ratio (NSR) minimized threshold as leading factors. The factors that are detected to anticipate the crisis will be counted into constructing the composite indicator by weighing each variable by their respective inverse of NSR (Kaminsky and Reinhart, 1999; Davis and Karim, 2008). The implementing process of KLR methodology is presented as a flowchart diagram, i.e. Figure 2, to simplify words described steps in a more concise way.

Table 3: Confusing table for calculating the noise-to-signal ratio for each cutoff.

	Crisis	No crisis
Signal was issued	A	B
No signal was issued	C	D

In the diagram, we first take 80% to 90% percentile of observations for each variable and gradient search the optimal cutoff by producing the confusing matrix, as Table 3 shows, calculating (adjusted) noise-to-signal ratio (NSR) of $\frac{B/(B+D)}{A/(A+C)}$, and searching for the minimal NSR corresponding cutoff value. Then, factor variables will be sifted by the extracted minimal NSR of NSR_{min}^j and the optimized cutoff of $cutoff_{opt}^j$ for variable X^j . As green blocks label in the diagram, two decision conditions are (1) whether the variable value is greater than the optimized cutoff and (2) whether the noise-to-signal ratio is smaller than 0.75⁸. Then condition filtered m out of n factor variables will be synthesized by assigning the corresponding inverse of NSR_{min} as their weights to compose the final output, normalized crisis indicator of I_t^c .

2.2.3. Machine learning

Machine learning models are the state-of-art techniques that are more flexible than traditional econometric models to predict on complex data with non-linearity. A wide range of EWS models constructed on machine learning techniques, such as neural networks (Nag and Mitra, 1999; Oh et al., 2006; Celik and Karatepe, 2007; Dong et al., 2009; Sevim et al., 2014; Yoon and Park, 2014), decision trees (Tanaka et al., 2016; Samitas et al., 2020; Holopainen and Sarlin, 2017), support vector machine (Ahn et al., 2011), and deep neural networks (Wang et al., 2020a,b), have been studied. According to former comparison work (Beutel et al., 2019; Chatzis et al., 2018) and our previous studies on stock and bond markets (Wang et al., 2020a,b), we select the neural networks, the tree model of random forest and gradient boost and the attention based long-short term memory networks as the candidate machine learning models, to explore deeper comparisons as well as to cover our preceding outstanding work.

⁷Both study adopt the multivariate logit regression.

⁸The significant level could be varied for specific markets according to the range of NSR values. Some studies (Davis and Karim, 2008) use 0.5 but find the strict value lead none of factors can be drawn as leading factors.

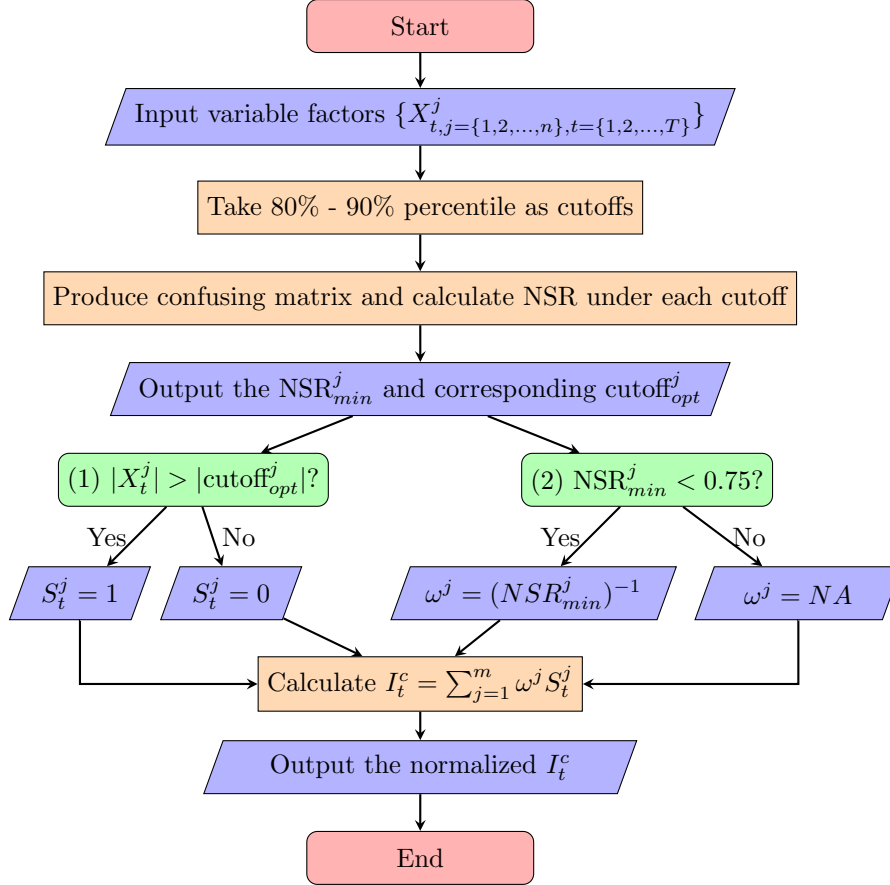

Figure 2: Diagram of implementing the KLR signal extraction approach. NSR_{min}^j and $cutoff_{opt}^j$ are minimal noise-to-signal ratio and corresponding optimal cutoff for input variable j . I_t^c is the composite crisis indicator (Kaminsky and Reinhart, 1999).

Neural Networks. As the booming computational vision and big data science unseal a nova technology era, more powerful models are required to solve the nonlinear problems with greater precision and less cost. The artificial neural networks (ANN) are born in this background, and by far, in spite of brimming with disputes on the transparency and interpretability, are generally acknowledged as the most robust and flexible model especially for predicting work. In the ANN applications on EWS model construction, Nag and Mitra (1999), Oh et al. (2006) and Fioramanti (2008) have successfully predicted the currency, stock and debt crises by hiring the feed-forward multi-layer perceptron. Figure 3 shows such architecture of a three-layer neural networks embedded on 4-cell input later, 6-cell hidden layer and 1-cell output layer. In practice, the count of neurons in the input layer is required to be same with the dimension of input predictors and the cell number determination for hidden layer will be in trials that start from 2 and increase at a rate of 2 power⁹. As increasing the structural complexity will influence the networks predicting performance, especially highly winded networks will bring over-parameterization and then make the model less generalized beyond the trained samples, some techniques such as *drop out* and *early stopping* thus will be hired to alleviate the over-fitting problem.

The neurons in each layer provide driving force to aggregate information by hiring activation functions. A plenty of activation functions, such as *sigmoid*, *ReLU* and *tanh*, are available to process various nonlinear relationships according to the property of learning target. In the study, we hire *ReLU* and *sigmoid* activation functions for the hidden and the output layers respectively. They have formulations as follows.

$$\text{ReLU: } f^1(x) = \begin{cases} x, & \text{if } x > 0, \\ 0, & \text{otherwise.} \end{cases} \quad (17)$$

$$\text{sigmoid: } f^2(x) = \frac{1}{1 + e^{-x}}. \quad (18)$$

⁹The experimental options for hidden layer structure are 2,4,8,16,32.

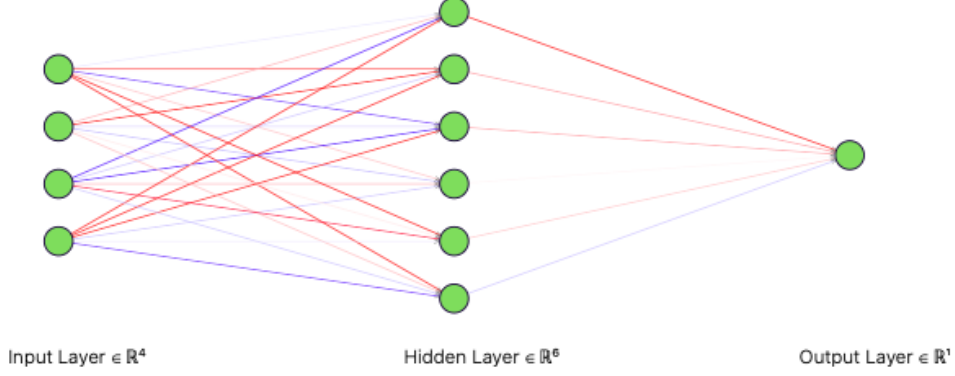

Figure 3: The structure of a sample three-layer artificial neural networks. Green circles are cells of activation functions to process information before passing through the corresponding layer. The arrows represent the information flow direction from input to output, where red and blue label the positive and negative edge proportional to assigned weights.

Before the output being processed, the weight parameters vector will be applied for each layer neurons, thus the aggregated information can be normally connected. Denote \mathbf{w}^1 and \mathbf{w}^2 to be the weight parameters for bridging between (1) input layer and hidden layer and (2) hidden layer and output layer. Thus, the predicted result for a three-layer ANN with n input variables, m -cell hidden layer and single cell output layer, can be written as follows,

$$\hat{y}_{t+1} = f^2\left(\sum_{j=0}^m w_j^2 \cdot f^1\left(\sum_{i=0}^n w_{j,i}^1 \cdot x_{i,t}\right)\right), \quad (19)$$

where $x_{i,t}$ is the value of variable i at time t , $w_{j,i}$ is the applied weight to the i^{th} input neuron for producing the input for j^{th} hidden neuron and w_j is the applied weight to j^{th} hidden neuron output for the final singular prediction. For more than three layers model, the process can be recursively implemented by assigning various dimensional weight parameters. The parameters will then be optimized by minimizing the L_2 penalized objective function in 100 epoch iterations.

Random Forest and Gradient Boosting Tree. Both random forest and gradient boosting tree are tree-based model on the ensemble learning base. The core idea for decision tree is to continuously partition data into homogeneous clusters by refining the selection rules as either building or pruning tree branches to get the optimal tree structure. The tree-based model can naturally visualize the categorizing rules and extract the variable importance, the model interpretability is thus more remarkable than other machine learning techniques. Koyuncugil and Ozgulbas (2012) and Tanaka et al. (2016) use the tree-based model construct EWS for predicting risk pressure for small enterprises and nationwide bank failures, which alters the practitioners' perspective in nonparametric models' predicting power. We thus put two advanced tree-based models in the stylish ensemble learning technique, random forest and gradient boosting tree, into model contrasts.

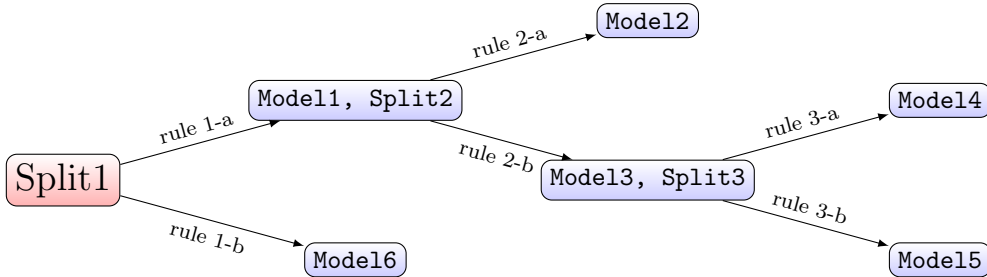

Figure 4: An example of tree model structure with three clustering rules, three splits and six regression models. Model 4, for instance, will be implemented by all split predictors from 1 to 3 and rule 1-a, 2-b and 3-a filtered data points.

Random forest solves the decision tree's weakness in generalization by growing multiple trees with bootstrapping aggregation. The process is implemented as follows.

1. Bootstrap a sample from original data and build a tree on the bootstrapped sample.

2. On each split of the trained tree, randomly select k features from original n predictors, where $k \leq n$, then determine the best one among k features and partition data.
2. Repeated step 1 and 2 M times, thus M different decision trees are built with corresponding randomly combined k features and partitioned data.
3. The best tree model will be determined by monitoring the error value that continuously decrease to most stable level.
4. Keep the best performed model and extract the variable importance.

Hence, from the implementation process for random forests, tuning parameters of k and M are inevitable to designated. The default value for k is equal to $\frac{n}{3}$, one third of predictors count. While, in the study, we alter to run a loop for k taking from 1 to $(n - 1)$ and search for the most efficient value that minimizes the error rate¹⁰. For determination of M , the iteration will first run 200 times til stabilize the error value in a low level band. The value for M , according to our experiments, is around 50 – 80¹¹.

Gradient boosting machines make the tree-based model algorithm more adaptive. It shares the similarity of random forest that the final prediction is produced on an ensemble of tree models, but its constructing way is substantially different. Trees in random forests are built independently and each one will reach the maximum depth, while in gradient boosting, the trees are dependent on previous fitted trees by allowing the minimum depth. The computation steps are listed as follows.

1. Initialize D and M to be the tree depth and number of iterations. Compute the average of response \bar{y} as the initial predicted value.
2. Start from the first iteration 1, calculate the residual, the difference between predicted value and observed value, and fit a D depth tree by setting the residuals as response.
3. Produce new predictions by using the fitted tree.
4. The predicted value will thus be updated by recursively implementing the step 2 and 3 and adding up the previous predicted value from past iterations.

Similarly, D and M are the tuning parameters for the gradient boosting machine. In the study, we across validate $D = \{1, 2, \dots, 5\}$ and $M = \{50, 100, 150, \dots, 500\}$, find the combination of $D = 3$ and $M = 100$ performs best by maximizing the AUC value for binary classification¹². The time cost of implementing the gradient boosting machine is more pricey than random forest since the random forest constructs independent trees in parallel, the gradient boosting, though restricts the tree grown depth, aggregates previous results in an adaptive recurring process.

Attention based Long-short term memory networks. The deeper variant of neural networks, the multi-layer perceptron models that inherently suit the time dependency, such as recurrent neural networks (RNN) and long-short term memory networks (LSTM), have been generally applied in financial prediction studies (Fischer and Krauss, 2018; Liu, 2019; Cao et al., 2019) and present more promising forecasting power than plain neural networks. As Figure 5 shows, the input at time t will access the LSTM perceptron and then pass through three ‘gates’ and a series of processing calculations to purify and aggregate information, and in final, carry the activation function a_t and peehole function C_t to next cell and produce (intermediate output for) predicted results. Specific formulations for the LSTM cell can be written as follows.

$$\Gamma_f = \sigma(x_t U^f + a_{t-1} W^f), \quad (20)$$

$$\Gamma_u = \sigma(x_t U^u + a_{t-1} W^u), \quad (21)$$

$$\Gamma_o = \sigma(x_t U^o + a_{t-1} W^o), \quad (22)$$

$$\tilde{C}_t = \tanh(x_t U^g + a_{t-1} W^g), \quad (23)$$

where σ 's refer to activation function for each gate, x_t is the input at time t , U 's and W 's are assigned weight parameters to connect two neighbour cells by passing processed information from past to future.

¹⁰The R package ‘randomForest’ implements the random forest model.

¹¹The value of M is fluctuating for different data frequency.

¹²R package of ‘xgboost’ helps to fit the gradient boosting model.

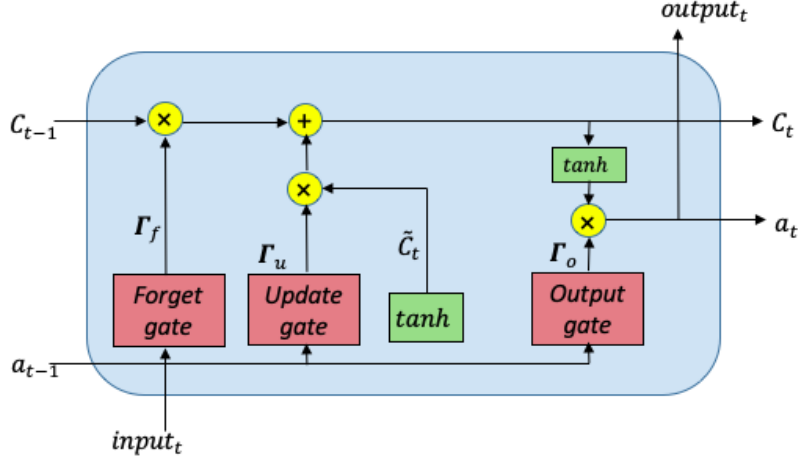

Figure 5: The inner structure of LSTM cell. Γ_f , Γ_u , Γ_o are sigmoid functions of the forget gate, the update gate and the output gate that determine the information to be discarded, added and reproduced. \tilde{C}_t is the new candidate output created by the \tanh layer, which is limited in the range $[-1, 1]$. a_t and C_t are recurrently employed activation function and peehole function that carry historic information flow to the future memory block. The initial values of C_0 and a_0 are both zero.

The LSTM based EWS has been proven more effective in the comparison to other two machine learning predictive models, back-propagation neural networks (BPNN) and support vector machine (SVM), for predicting stock crashes (Wang et al., 2020a). The model is then made more comparable in terms of extracting variable importance by stacking an upper attention layer on the LSTM layer (Wang et al., 2020b), as Figure 6 shows, before entering into LSTM cells, attention mechanism will filter out high-value information among a large amount of inputs. It revolutionizes the weakness of traditional way that assigns the same weight vector to each input, by varying the weight according to the inputs' value. Thus, a sequence of $\{h_{t=\{1,\dots,T\}}^t\}$ will be made from a network of T LSTM memory cells that process the generated output $\{d_{t=\{1,\dots,T\}}^t\}$ from the attention layer, and the final prediction \hat{y}^{T+1} will be produced by a sigmoid function to squash the value into $[0,1]$. The process then will be recursively carried out on sequential sample pieces from $t = \{2, \dots, T+1\}$ onward till the end at \mathcal{T} .

2.3. Measurements for classifier and predicting robustness

Three types of measurements will be adopted to examine the EWS effectiveness in terms of classifiers, predicted results and practical usefulness.

2.3.1. Misspecification rate

For the crisis classifier, except matching to the chronology of critical events, we take an objective way of first calculating the misspecification rate for identified crises on the out-of-sample size truncated full samples and the out-of-samples for each classifier, and recognizing the best performed one with the least misspecification rate. The performance is then further validated by statistically bootstrapping the 1000 sample pieces from full observations and taking the average misspecifications.

Table 2 lists the classifiers that will be put in contrast, thus a justification approach will be proposed to investigate the classifier identifying precision as compared with 'true' crisis observations. This judgement is yet objectively committed because the exact timing of 'true' crisis is ambiguously personalized corresponding to individuals' cognition level on crises. Most studies alter to match the either critical events or significant signs (Oh et al., 2006; Abiad, 2007; Sevim et al., 2014; Eijffinger and Karatas, 2019) that once appeared in notorious financial crisis periods to the identified results, but this judgement somewhat lacks of persuasion. The study will though, in the intuitive judgement way, collect the chronologically published evidence to clarify the classifier's identifying performance, a more statistical-oriented evaluating method to compare the identified crises difference between for full samples and for test set, as following itemized procedure described, will be proposed and implemented to avoid the subjectivity.

1. Classifiers will first identify crisis observations for full samples (with size of N_f) and test set (with size of N_t) respectively, then identified crises on full sample is the vector of $\mathbf{C}_f = \{C_1, C_2, \dots, C_{N_f}\}$ and that on test set is $\mathbf{C}_t = \{C_1, C_2, \dots, C_{N_t}\}$;

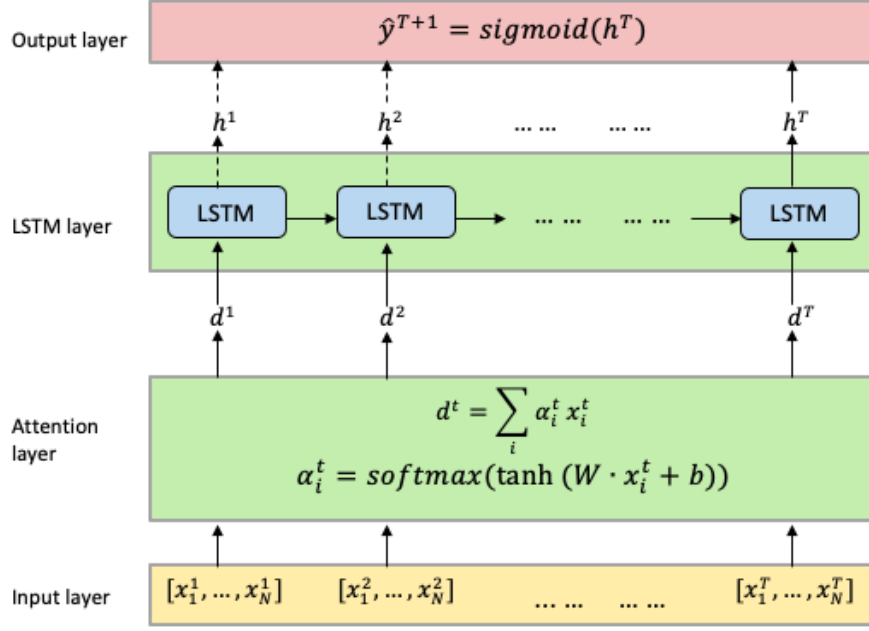

Figure 6: The attention based LSTM networks structure. T is the preset time step size. Vectors of observed variables $[x_1^t, \dots, x_N^t]$ at time t for $t = \{1, \dots, T\}$ will be processed by activation function of \tanh and probability transformation function of softmax given uniformly distributed weight vector W and a constant vector b . Then, attention filtered information will be passed to the LSTM layer for further processing til final predicted results \hat{y}^{T+1} is generated. The dotted arrows that direct $\{h_{t,t=\{1,\dots,T-1\}}\}$ means the intermediate output before T will not be memorized by LSTM cell and further be participated into the final prediction.

2. Full samples will be truncated as the same time horizon of test set and then the identified crises on truncated full samples will be denoted as the vector of $C_{f_{truc}} = \{C_{N_f - N_t + 1}, \dots, C_{N_f}\}$;
3. Misspecification rate on the test set will be calculated as

$$\text{misspecification rate} = \frac{\sum_{i=1}^{N_t} (C_{f_{truc}} \neq C_t)}{N_t}, \quad (24)$$

To avoid the opportunist result, bootstrapping will be further required to validate the classifier average performance, and the most preferred classifier will give the lowest average misspecification rate on bootstrapped samples. The implementing procedure is to repeat the above step 1-2 on the randomly selected piece of samples with the size of $N_{t,j}$ for B times¹³. Then, from $j = 1$ to $j = B$, the average misspecification rate be calculated as

$$\text{avg. misspecification rate} = \frac{1}{B} \sum_{j=1}^B \left[\frac{\sum_{i=1}^{N_{t,j}} (C_{f_{truc},j} \neq C_{t,j})}{N_{t,j}} \right] \quad (25)$$

2.3.2. Statistical metrics

To examine the predicting robustness, as previous EWS studies adopt, two types of statistical measurements will be taken (1) the goodness-of-fit, such as the ratio of correctly called crisis observations and crisis onsets, and false alarms (Berg and Pattillo, 1999b; Bussiere and Fratzscher, 2006; Davis and Karim, 2008; Dawood et al., 2017) on out-of-samples, and (2) credit-score calibrations, such as quadratic probability score (QPS), Youden index J (Candelon et al., 2012) and SAR¹⁴ (Caruana and Niculescu-Mizil, 2004).

¹³ B is usually great larger than the sample size.

¹⁴The composite score of averaging the accuracy, AUC and 1-RMSE.

$$\text{Quadratic Probability Score : } QPS = \frac{1}{T} \sum_{t=1}^T 2(\hat{y}_t - y_t) \quad (26)$$

$$\text{Youden } J : J = \text{sensitivity} + \text{specificity} - 1 \quad (27)$$

$$\text{SAR : SAR} = \frac{1}{3}(\text{Accuracy} + \text{AUC} + (1 - \text{RMSE})) \quad (28)$$

2.3.3. Invigilation in practice

To invigilate the predicted signals usefulness in practice, back testing and reality check will be hired in assigning varied portfolio weights according to the investors' risk aversion in turmoil periods. The risk aversion level is proven dynamic as the financial situation shifts from tranquility to turmoil, specifically, both macro- and micro-level shocks increase the investors risk aversion level (Sakha, 2019), and then the asset allocation will be necessarily re-adjusted to improve the portfolio returns (Hasler et al., 2019) and lower the amplifying degree from institutional investors' negative behaviour to exacerbate subsequent crashes (Fan and Fu, 2020).

The implementing back test process is on the basis of constructing a moving forward the dynamics for asset allocation by referring to the warning signals. Similarly to previous studies for portfolio construction (Rapach et al., 2009; Dai et al., 2020), in the study, for each asset of $\{r_{i,i=1,\dots,S}\}$, at time t , the portfolio weight will be given as

$$w_{i,t} = \frac{1}{\gamma + \hat{y}_{i,t+1}} \left(\frac{\eta_{i,t}}{\sigma_{i,t}} \right), \quad (29)$$

where $\eta_{i,t}$ is the return rate for asset r_i at time t , $\sigma_{i,t}$ is the realized volatility with one-year rolling window for asset r_i at time t . γ denotes the initial risk aversion level for investors, which will be varied from 1 to 3 to represent the innate risk preference tastes from low to high in the real market. $\hat{y}_{i,t+1}$ is the produced crisis warning signal from each EWS model for asset r_i . Here, the short sales is restrained no more than 50% and the long position is allowed no more than 150%, the value of $w_{i,t}$ will be hence limited into $(-0.5, 1.5)$ (Campbell and Thompson, 2007; Dai et al., 2020).

Sharpe ratios and the average certainty equivalent return (CER) will be then calculated as follows,

$$\text{Sharpe ratio} = \frac{\overline{R_p}}{\sigma_p} \quad (30)$$

$$\text{CER} = \overline{R_p} - \frac{1}{2}\gamma\sigma_p \quad (31)$$

where $\overline{R_p}$ and σ_p denote the mean and standard deviation of portfolio returns, $R_p = \sum_{i=1}^S w_{i,t}\eta_{i,t}$.

The reality check will be implemented by revisiting the Eq. 32, portfolios' realized variance (Wang et al., 2020a) between the EWS involved and non-EWS benchmarks, and make judgement on whether the null hypothesis of EWS not improving the return variance level, i.e. $H_0 : E(f) \geq 0$, will be rejected after stationary bootstrapping 1000 times for p-value calculation.

$$f_t = V_{EWS,t} - V_{Bench,t} \quad (32)$$

3. Experimental study on currency and stock markets in China

As the world's second largest economy, financial markets in China have been continuously improving in a blossom development and rapidly expanding international economic interactions. It is, however, the high-speed "Oreint Express" opts to an unpredictably changing economic situation and follows the endeavour to maintain the market stability, especially for two principal markets of currency and stocks, in the financial crisis triggered turbulence. For the currency market, after the "8.11" Exchange Rate Reform in 2005, the Central Bank has been reduced their intervention in manipulating the exchange-rate to lowest portion. According to the released data released from the Bank for International Settlements (BIS), the nominal effective exchange rate of the Chinese yuan (CNY) appreciated 38% from the beginning of 2005 to June 2019, and the real effective exchange rate appreciated 47%, which not only leads China to be one of the largest currencies in the globe, but gains the exposure risk to financial crises as well. For the Chinese stock market, it has experienced tremendous ups and downs in financial crises and also has been playing as the barometer of economic situation for more than three decades, from the original grassroots era (1990-1995), the golden age (1995-2000) to the era of returning to reason (2000-2005) and prosperity (2005-2010), and to the most recent fanaticism caused stock crash (2015-2016). The

possibility of constructing an effective predictive system to monitor two primary investment markets turbulence will gain the economy reliance to crash risks and guide the policymakers and investors to avoid devastating losses in the withering attacks.

To fulfill the aim of comparing EWS model predicting effectiveness on market specific crises and unravel mystery of whether any forecasting system will work on Chinese markets, which were once thought to be less transparent and highly government-manipulated, we thus experiment on both currency and stocks markets of China.

3.1. Data summary

Two prerequisites for sourcing data are (1) substantial variables are reserved in the a credible database, and (2) the variables have been studied and proven closely linked to predicting financial crises. Referring to Kaminsky et al. (1998) study who have listed the most comprehensive table for crisis leading factors from various economic sectors, we similarly source 36 variables, including 8 daily, 17 monthly and 11 annually distributed factors corresponding to the currency and stock turbulence variations. For instance, in the national economy sector, external factors such as reserves and the real exchange rate, and financial factors such as domestic credit to GDP and interest rate, have already been proven capable of signalling the economic vulnerability in currency crashes for China (Peng and Bajona, 2008). Most variables are obtainable from WIND¹⁵ database, except discount rate and crude oil price from St. Louis Fed and gold price from World Gold Council (WGC). Time horizon covers from December 1st of 1995 to December 1st 2019, the most recent 24 years, which period is believed to contain sufficient crisis samples. Full data set is then split into 75% in-sample and 25% out-of-sample for both monthly and daily distributed data frames.

Table 5 describes the key statistics for sourced variables on the full time length. From the columns of skewness and J.B. statistic, most of daily variables, such as stock index, exchange rates, interest rates and globe economy indicators, are fairly not normally distributed with sloppy values, which laterally attributes the market endogenous non-normality and exactly contributes to validate the EWS model predicting sensitivity on alienated outliers in financial series.

3.2. Identified crises

In this section, we first calculate the misspecification rate for each crisis classifier to compare the identifying robustness on different size samples, and then, similarly to previous studies, put the critical crisis events in chronological order to contrast the identified periods. The classifiers all listed in 2 will be implemented. In practice, the value for scaling coefficients of λ_{fpi} and λ_{cmx} are experimented¹⁶ as 1.5 and 2 in the TQI classifier. The SWARCH classifier will be applied to stock with 2 regimes and currency with 3 regimes¹⁷, respectively.

The crisis classifier robustness will be measured in evaluating the stability of classified results as vary the crisis turmoil intensities for different pieces of observations. We implement all classifiers on full samples and test set to clarify their each performance by following the described procedure in the Section 2.3.1. The test set for both non-boostrapping and boostrapping experiments is taken as one thirds of full samples. Table 6 shows that, among the classifiers, the (average) misspecification rates given by the SWARCH_{opt} classifier are smallest, 1.81% and 13% for currency and 2.09% and 9.56% for stocks, on daily and monthly identifications respectively. The classifier based on the SWARCH with the arbitrary cutoff, however, gives the most miserable misspecification rates of 4.63% and 14.1% for currency on daily and monthly basis, and 4.51% for stock daily basis. It gives 10.4% for identifying monthly stocks, which is not worse than the CMAX brought value of 11.6% but not enough to reverse its feebleness on crisis identification. In short, the crisis classifier built on the SWARCH with two-peak dynamically threshold is statistically proven to be the most robust one. In further comparisons, the SWARCH with arbitrary cutoff of 0.5 classifier will be ruled out to condense the distinction between the classic quantization index and the SWARCH methodologies.

The ‘observable’ financial crisis periods and their relevant starting sign evidences during the most recent 24 years from 1996 to 2019 will be chronologically displayed and visualized, as Table 7, 8 and Figure 7 in Appendix II show, to investigate the credibility of crisis classifier’s identifications in an intuitive way.

The highlighting session, such as 1997 Asian financial crisis, 2007-08 Global financial crisis, 2010-11 Sovereign Debt crisis and 2018 Sino-US trading war are cross-national financial crises for both markets, otherwise are

¹⁵WIND is a popular qualified financial database in mainland China. It contains both micro- and macro- economic variable data for researchers and practitioners. The only shortage is that the access is limited to commercial usage.

¹⁶Gradient searching is implemented in the set of $\{1, 1.5, 2, 2.5, 3\}$ and the best performed value is taken with the minimal misspecification rate.

¹⁷The count of regimes K is determined by calculating the RCM.

Table 4: Summary of factor variables.

Sector	Label	Variable	Frequency	Source
Stock market	ssec	Shanghai composite index	daily	WIND
	ssec_r	return rate of Shanghai composite index	daily	
	sez	Shenzhen composite index	daily	
	sez_r	return rate of Shenzhen composite index	daily	
Currency market	frx	USD/CNY exchange price	daily	WIND
	frx_r	return rate of USD/CNY exchange price	daily	
Interest rate	dis_r	discount rate	monthly	St. Louis Fed
	int_r	demand deposit interest rate	monthly	WIND
National economy	bal_g	balance of international payments (% in GDP)	annually	WIND
	cci	consumer confidence index	monthly	
	cpi	consumer price index (year-on-year basis)	monthly	
	comd_g	commodity trade (% in GDP)	annually	
	deb_g	total debts (% in GDP)	annually	
	dom_c	domestic credit	monthly	
	dom_g	banking departments offered domestic credit (% in GDP)	annually	
	fix_a	completed investment in fixed asset(cumulative year-on-year basis)	monthly	
	frx_res	official foreign exchange reserve	monthly	
	gdp_p	per capital GDP	annually	
	gdp_p2	per capital GDP (year-on-year basis)	annually	
	gdp_c	GDP growth contribution rate (to consumption)	annually	
	im_ex	total import-export volume(year-on-year basis)	monthly	
	ind_g	industrial added value (% in GDP)	annually	
	ind_p	production and sales ratio of industrial products	monthly	
	ind_v	industrial added value (year-on-year basis)	monthly	
	inf_r	inflation rate	annually	
	mac_c	macro-economic climate index	monthly	
	m2_g	board money supply (% in GDP)	annually	
	ppi	producer price index (year-on-year basis)	monthly	
real_c	real-estate climate index	monthly		
rpi	retail price index (year-on-year basis)	monthly		
rrr	reserve requirement ratio	monthly		
shibor	Shanghai interbank offered rate (weighted average)	monthly		
tax_r	tax revenue	monthly		
Global economy	gold	global gold price (US dollarwise)	daily	World Gold Council
	oil	crude oil price (West Texas Intermediate)	daily	St. Louis Fed
	vix	S&P500 volatility index	daily	WIND

Table 5: Statistic descriptions

Variable	Mean	Standard Dev.	Skewness	J.B. Statistic	Count
ssec	1793.40	1039.33	1.08	1632.6	5686
ssec_r	0.09	2.65	12.15	48754295	5685
sez	5793.46	4209.13	0.96	829.22	5686
sez_r	0.07	2.21	0.96	45313	5685
frx	7.39	0.85	-0.12	706.4	5686
frx_r	0.00	0.11	0.43	529747	5685
dis_r	3.80	1.84	2.40	466.99	257
int_r	0.78	0.59	2.09	427.95	257
bal_g	4.83	3.80	0.25	0.94875	26
cci	109.42	6.22	0.50	10.857	257
cpi	2.26	2.53	0.81	32.581	257
comd_g	42.75	10.56	0.67	2.803	26
deb_g	27.19	12.32	0.33	1.2994	26
dom_c	599448	606773	1.18	60.85	257
dom_g	148.22	39.80	0.53	1.9997	26
fix_a	19.59	8.87	0.19	2.1097	257
frx_res	16761	13999	0.19	30.582	257
gdp_p	28953	22391	0.57	2.7291	26
gdp_p2	8.22	1.99	0.82	3.4763	26
gdp_c	56.57	11.92	0.65	2.2989	26
im_ex	13.66	15.97	0.02	2.6891	257
ind_g	44.70	2.52	-0.77	3.6808	26
ind_p	97.73	1.29	0.32	210	257
ind_v	11.46	4.27	0.21	10.587	257
inf_r	2.82	3.60	2.22	75.228	26
mac_c	96.44	3.31	-0.03	8.5258	257
m2_g	162.25	32.64	-0.18	1.2309	26
ppi	0.95	4.09	0.02	7.3328	257
real_c	101.28	3.63	-0.58	15.889	257
rpi	1.23	2.61	0.53	11.965	257
rrr	12.88	5.20	0.01	22.948	257
shibor	3.39	2.73	2.32	434.42	257
tax_r	5061.64	4341.54	0.82	30.973	257
gold	829.69	481.28	0.24	549.98	5686
oil	54.46	28.87	0.46	329.34	5686
vix	19.90	8.14	2.08	1766	5686

Table 6: Compare classifiers' robustness: count of misspecified crisis observations.

panel (a) : currency	FPI		SWARCH		SWARCH _{opt}	
	days	months	days	months	days	months
Count of crises on full samples	25.0	48.0	1529	83	1517	83
Count of crises on truncated full set	22.0	24.0	1092	52	1086	52
Count of crises on test set	21.0	12.0	1034	55	1075	51
Count of misspecified obs.	20.0	12.0	75.0	13.0	15.0	9.0
% of misspecified obs.	1.05	13.9	3.96	15.1	0.791	10.5
Avg. count of misspecification	25.9	12.0	87.7	12.3	34.4	11.3
Avg. % of misspecification	1.37	13.8	4.63	14.1	1.81	13.0
panel (b) : stock	CMAX		SWARCH		SWARCH _{opt}	
	days	months	days	months	days	months
Count of crises on full samples	509	38.0	2097	148	2135	137
Count of crises on truncated full set	172	15.0	641	25.0	653	21.0
Count of crises on test set	202	21.0	646	37.0	640	27.0
Count of misspecified obs.	30.0	6.00	25.0	12.0	25.0	6.00
% of misspecified obs.	1.60	6.89	1.32	13.8	1.32	6.89
Avg. count of misspecification	53.5	10.1	85.5	9.07	39.7	8.32
Avg. % of misspecification	2.86	11.6	4.51	10.4	2.09	9.56

national stylized critical facts, such as 2013 ‘Cash Crunch’, 2015 Chinese stock market crash and macroeconomic control policy for specific market. In end of 90’s Asian crisis, the currency market experienced seemly vibrations in the ‘managed floating’ scheme, unlike the violent up and down stock index which heavily oscillated till 2000. In 2001, to deepen the enterprise reform, government decided to reduce the state-owned shares from stocks, which directly led an almost 40% decline of SSEC in a half year. During 2004-2005, both markets were announced to be reformed, which made 2.1% overnight depreciation for RMB against U.S. dollar and 11% annual fall for A-shares price in both SSEC and SZSE. In the periods of notorious 2008-09 financial crisis and its follow-up 2010-11 Sovereign debt crisis, Chinese yuan devalued 15% before pegging to the U.S. dollar and the bear market for stocks lasted for more than three years till the second half of 2012. In late May of 2013, the panic induced by inter-bank market capital shortage, alternatively called ‘Cash Crunch’, spread to the stock market, which led SSEC a 16% reduce in June. In 2014 Feb., China took actions to guide the Chinese yuan weaker and swiftly turned to expand the volatility range into $\pm 2\%$ in March, which brought in Chinese yuan against U.S dollar drastic vibration in a few months. 2015 is the nightmare for Chinese stock investors. On June of 2015, after a chain of reactions between off-site allocation clean-up, on-site financing and deleveraging of graded funds, Chinese stock market was led to a severe crash that most stocks declined more than 50% in twin-weeks, which touched off the fusing mechanism by imposing dual-thresholds of 5% and 7% on the index fusing benchmark. Even worse, a resonant effect was formed between the currency and stocks as soon as the ‘one basket currencies’ policy was published, which devaluate yuan against U.S. dollar by 5.8%. Starting from May 2017, China introduced “counter-cyclical factor” (Allison Nathan, 2019) to reinforce market communication to the currency, and henceforth the exchange rate turned on “roller coaster” mode, especially during the 2018 Sino-US trading war, yuan was devaluated by 11% and hardly rallied to a strong level. The trade war also became the catalyst for stock market shocking decline of more than 30% in a few months.

Comparing identified results in Table 7 and 8, the FPI and CMAX defined crisis classifiers show less sensitivity, even numbness, than SWARCH modeled volatility state jump classifier as match to the critical events. For instance, both FPI and CMAX sensors missed out 1997 Asian Crisis, SWARCH however sharply caught it and provided varied turmoil episodes given market-characteristic volatility dispersion. Without exception, SWARCH defined crisis classifier almost conquers all relative price dynamics variation between crisis and non-crisis periods. As for the detection precision, SWARCH classifier that includes the pre-crisis effect is superior to FPI and CMAX since all SWARCH model identified starting point is either earlier or more accurate than TQI index. For instance, the starting time for 2014 China managing floating is March, which time is precisely pinned by SWARCH but three months delayed by FPI, and the TQI inaccurate detection is embodied in identifying the 2005 Exchange rate reform, where FPI generates a dislocated period that yet covers the start point of the true turbulence. The visualized comparison as Figure 7 suggested makes the conclusion that SWARCH is more superior to traditional TQI index to sense the market turbulence more persuasive, as the volatile log returns can be perfectly reflected by SWARCH inferred filtering probabilities but scantily by FPI and CMAX. We hence reason that the SWARCH model with automatically optimized thresholds is not only statistically convincing

Table 7: Identified crisis episodes for currency market.

critical event	evident sign	FPI	SWARCH _{opt}
1997 Asian Crisis	Since the spring of 1996, Chinese yuan against U.S. dollar began to vibrate around 8.2 after deepening the 94's published 'managed floating exchange rate market system'	--	1996.06-08; 1997.02-03; 1997.05,10
2005 Exchange rate reform	On July 21, 2005, Chinese yuan appreciated 2.1% overnight as China Central Bank announced to reform the exchange rate	2003.09-2004.09	2005.07-11
2007-08 Globe Financial Crisis	Starting from 2006, U.S. dollar to yuan continually depreciated 15% till the mid-2008 China re-pegging yuan to U.S. dollar at 6.83	2006.12-2007.12	2006.02,06; 2007.09-2009.06
2010-11 Sovereign Debt Crisis	Since June of 2010, the exchange rate to U.S. dollar depreciated 2.49% in a half year, till April of 2012 as China kept expanding the currency volatility range to $\pm 1.0\%$	--	2010.06-12; 2012.05-10
2014 China managing float	The RMB currency volatility range was continually expanded to $\pm 2.0\%$ since 2014 March.	2014.06-12; 2015.03-07	2014.03,04,09,12; 2015.03,04
2015 'One basket currencies' scheme and Chinese stock crash	Starting from 2015 summer, the 'stock-exchange resonance' led yuan against U.S. dollar dropped 5.8% over a year	--	2015.08-12; 2016.03-12
2018 Sino-US trading war	In 2018, U.S. dollar to yuan depreciated from 6.9 to 6.3 and then pulled back to 7 in 2019 spring	2017.05-12; 2018.03-06	2017.03-12; 2018.04-12; 2019.03-12

Table 8: Identified crisis episodes for stock market.

critical event	evident sign	CMAX	SWARCH _{opt}
1997 Asian Crisis	Starting from Jan. 1996, SSEC index swung up from 550 points to 1300 points over a year, then drastically dropped to 860 points at the start of 1997 and finally surged to 2500 points till 2000 Spring	--	1995.12-1998.05; 1998.08-1999.03; 1999.05-2000.05
2001 State-owned Shares Reduction	SSEC index reduced 39.93% in a half year after the 'State-owned Shares Reduction' measure issued in June 2001	--	2001.07-10; 2002.05-10
2004-05 Stock Market Reform	The average fall of A share prices for both SZSE and SSEC exceeded 11% over the year of 2004, SSEC even drowned below 1000 points till June of 2005.	--	2004.04-07; 2005.02-06
2007-08 Globe Financial Crisis and 2010-11 Sovereign Debt Crisis	In 2008, the greatest drop of SSEC approximated to 70%, and in following 2010-2011, the bear market, the maximal decline was approaching 35%.	2007.02-2009.02	2006.04-2011.02,09; 2012.02-04
2013 'Cash Crunch'	The overall decline of SSEC was nearly 16% in 2013, June	--	2013.06-09
2015 Chinese stock crash	Since 2015 mid-June, SSEC twice plunged from climax 5187 to nearly below 3000 in two months	2014.12-2016.06	2014.11-2016.07
2018 Sino-US trading war	Since mid-June 2018, SSEC depreciated more than 30% in a few months	--	2018.06,10

among crisis classifiers in crisis identification for both daily and monthly predictions, but evidently persuasive as match to the historic critical events that lead severe market turmoils in reality.

3.3. Forecasting power

The predicted results will be displayed in two aspects of the hit-ratio calculations, including the correct predictions, correctly called onsets, false alarms and predicted days in advance, and the statistical calibration metrics of QPS, Youden J and SAR. Table 9 and 10 give the calculated values on out-of-samples in terms of daily (short-term) and monthly (long-term) data frames for currency and stock markets respectively, where the best performed metrics are bold-type in each row to present the corresponding combined EWS model performance.

Comparing the results in sub-panels of (a)/(b)-1 and (a)/(b)-2, we verify that SWARCH classifier can truly boost the EWS performance in terms of either higher predicting precision or lower false calling alarms especially as combine econometric models of logistic regressions. For instance, the FPI combined LR gives 61.5% correctly called crisis observations and 28.1% false alarm rate while the SWARCH hybrid LR improves the values by 20.8% (to be 82.3% correctly predicted crises) and 28.1% (to be 0.00% false alarms) for currency market short-term prediction. SWARCH shares a similar boosting on KLR, except for stock long-term prediction, neither the hit ratios for predicted crisis observations and predicted crisis onsets nor the statistical metrics for Youden J and SAR get significant improvements. Among the machine learning techniques, the classification tree models of RF and XGBoost can benefit from SWARCH classifier by diminishing the false alarms. For example, for the short-term prediction on currency market, the percentage of false alarms produced by FPI combined RF model is 23.1% while being decreased to be 0.00% as substituting the SWARCH classifier. Besides, the SWARCH combined EWS model will provide longer early warning periods especially for long-term predictions. The typical evidence can be found as compare the row of hit(4) between (b)-1 and (b)-2 in Table 9, that the called advanced days for crisis onsets have been prolonged for 1-2 months, which implies ample reaction time will be suggested to regulators or decision makers to respond the market vulnerability.

In addition, the EWS model based on machine learning predictive techniques outperforms that based on traditional econometric models with better goodness-of-fit and statistical scores especially as the SWARCH classifier joins. The average hit ratio of correct predicted crises extracted from NN, RF, XGBoost and AttnLSTM based EWS is greater than 90% for both markets predictions (except the short-term prediction for stock with CMAX classifier), which wins the LR and KLR that model hardly get more than 90% correct predictions with a commanding lead. Furthermore, most zeros of QPS and ones of Youden J metric values are given by SWARCH combined machine learning models, which also strongly validates the predicting robustness of these hybrid state-of-art brain-like learning models. In fact, it is quite differential to specify machine learning models forecasting power, for instance, even though classification tree models of RF and XGBoost bring in 100% predicting precision on crisis observations and 0.00% false alarms (as refer to the hit (1) and hit (3) in (a)-2 and (b)-2 sub-panels for both markets), the neural networks of NN and AttnLSTM generally perform better on predicting crisis onsets and advanced days (as refer to hit (2) and hit (4) in (a)-2 and (b)-1 of Table 9 and (a)/(b)-2 of Table 10).

In contrast to previous study on comparing econometric models constructed and machine learning based warning system for predicting banking crisis that claims conventional models already fairly efficient to use available information (Beutel et al., 2019), we conclude a different pattern in line with the measured results that the machine learning based predictive models, especially the deep learning based EWS, will not lose either credibility or robustness on out-of-sample predictions given sufficient endogenous and exogenous features data and SWARCH model inferences.

To concentrate the model comparisons in a compact way, we further clarify a series of refining conditions¹⁸ into a unified system. As Table 11 shows, the selection standards are listed at the left side and models that can pass through each selection condition will then be screened till the the final row, the most frequently screened model that is picked as the best EWS for predicting corresponding market and required term displays. According to final model options, SWARCH crisis classifier is indisputably preferred to both markets for both short- and long- term prediction. The market however shows idiosyncrasy in predictive model selection. Particularly, the stock market is solely partial to the AttnLSTM, while the currency market seems to prefer both of NN and AttnLSTM for short-term prediction and extra includes the RF for long-term prediction. To avoid ambiguous model determinations, further comparisons for currency market are required. Back to Table 9, AttnLSTM and RF produced more bold-labelled results for short-term panel (refer to (a)-2) and long-term panel (refer to (b)-2) respectively. Thus in brief, the unified comparison suggests the SWARCH-AttnLSTM as the best option for

¹⁸The refining conditions are statistical metrics with appropriate threshold level to rule out unsatisfied models. The threshold value can be country or market personalized in practice.

Table 9: Compare EWS models predictive power: hit-ratios and score metrics for currency.

panel (a): short-term						
	LR	KLR	NN	RF	XGBoost	AttnLSTM
<hr/> (a)-1: FPI <hr/>						
hit(1) ^a	61.5	74.3	94.8	100	94.8	97.4
hit(2) ^b	51.0	71.8	84.4	59.3	22.0	86.8
hit(3) ^c	28.1	38.9	29.4	23.1	0.00	29.2
hit(4) ^d	2.57	2.51	2.92	2.81	3.13	2.45
QPS	0.209	0.501	0.00*	0.00*	0.00**	0.00*
Youden <i>J</i>	0.498	0.432	0.773	0.993	0.948	0.899
SAR	0.692	0.591	0.789	0.834	0.679	0.798
<hr/> (a)-2: SWARCH <hr/>						
hit(1)	82.3	81.7	96.8	100	100	100
hit(2)	45.5	55.3	84.5	0.00	54.5	90.9
hit(3)	0.00	32.9	0.00	0.00	0.00	0.00**
hit(4)	3.07	2.39	3.18	0.00	3.13	2.32
QPS	-0.17	-0.254	0.00*	0.00**	0.00**	0.00*
Youden <i>J</i>	0.823	0.159	0.986	1.00	1.00	0.969
SAR	0.865	0.646	0.792	1.00	0.667	0.896
<hr/> panel (b): long-term <hr/>						
	LR	KLR	NN	RF	XGBoost	AttnLSTM
<hr/> (b)-1: FPI <hr/>						
hit(1)	66.7	70.8	91.7	100	83.3	95.8
hit(2)	0.00	100	50.0	0.00	0.00	50.0
hit(3)	15.0	36.8	14.8	12.5	4.17	7.41
hit(4)	0.00	2.20	1.00	0.00	0.00	1.00
QPS	-0.129	-0.167	0.097	0.129	-0.096	0.105
Youden <i>J</i>	0.561	0.290	0.785	0.895	0.807	0.837
SAR	0.723	0.612	0.736	0.758	0.734	0.782
<hr/> (b)-2: SWARCH <hr/>						
hit(1)	84.6	95.8	100	100	100	98.0
hit(2)	88.9	100	88.9	88.9	88.9	87.5
hit(3)	18.5	33.8	0.00	0.00	0.00	0.00
hit(4)	2.46	2.5	2.8	2.9	2.9	2.4
QPS	0.062	0.254	0.00*	0.00**	0.00**	0.00*
Youden <i>J</i>	0.581	0.127	0.923	1.00	1.00	0.934
SAR	0.769	0.679	0.889	0.889	0.667	0.897

^a % of correctly called crisis observations.^b % of correctly called onsets.^c % of false alarms.^d count of alarming advanced days.

*,** refer to with 5% and 1% significance level respectively.

Table 10: Compare EWS models predictive power: hit-ratios and score metrics for stock.

panel (a): short-term	LR	KLR	NN	RF	XGBoost	AttnLSTM
<hr/> (a)-1: CMAX <hr/>						
hit(1)	49.1	47.2	79.2	63.2	56.6	86.8
hit(2)	50.0	50.0	50.0	33.3	0.00	50.0
hit(3)	43.1	46.4	36.1	0.00	0.00	44.4
hit(4)	2.71	2.43	2.00	1.80	0.00	2.5
QPS	0.00*	-0.10	0.00*	-0.07	-0.07	0.00*
Youden J	0.038	0.028	0.770	0.132	0.056	0.836
SAR	0.643	0.656	0.581	0.102	0.718	0.663
<hr/> (a)-2: SWARCH <hr/>						
hit(1)	92.1	53.2	96.3	100	100	100
hit(2)	63.2	61.9	47.4	47.4	47.4	89.5
hit(3)	38.7	50.4	0.00	0.00	0.00	0.00*
hit(4)	2.74	2.47	3.21	3.15	3.15	2.42
QPS	1.14	0.08	0.00*	0.00**	0.00**	0.00*
Youden J	0.218	0.182	0.963	1.00	1.00	0.965
SAR	0.554	0.548	0.821	0.712	0.767	0.855
<hr/> panel (b): long-term <hr/>						
<hr/> (b)-1: CMAX <hr/>						
hit(1)	59.3	76.3	100	93.3	60.0	100
hit(2)	0.00	50.0	100	0.00	0.00	100
hit(3)	40.6	48.2	11.1	12.0	0.00	11.1
hit(4)	0.00	1.50	1.00	0.00	0.00	1.50
QPS	0.813	0.180	0.102	0.610	-0.203	0.111
Youden J	0.454	0.605	0.932	0.502	0.60	0.923
SAR	0.549	0.712	0.805	0.589	0.739	0.834
<hr/> (b)-2: SWARCH <hr/>						
hit(1)	84.2	73.0	100	100	100	100
hit(2)	0.00	50.0	100	0.00	0.00	100
hit(3)	39.3	26.2	20.0	0.00	0.00	33.3
hit(4)	0.00	2.40	1.5	0.00	0.00	2.50
QPS	0.277	-0.127	0.185	0.00**	0.00**	0.00*
Youden J	0.581	0.442	0.870	1.00	1.00	0.942
SAR	0.678	0.713	0.852	1.00	0.667	0.827

Table 11: Model selection for currency and stock markets.

market classifier	FPI	currency	SWARCH	CMAX	stocks	SWARCH
panel (a): short-term						
hit(1) > 90	NN,RF,XGBoost,AttnLSTM		NN,XGBoost,AttnLSTM	-	LR,NN,RF,XGBoost,AttnLSTM	
hit(2) > 80	NN,AttnLSTM		NN,AttnLSTM	-		AttnLSTM
hit(3) < 10	-	LR,NN,RF,XGBoost,AttnLSTM	LR,NN,RF,XGBoost,AttnLSTM	RF,XGBoost	NN,RF,XGBoost,AttnLSTM	
hit(4) > 3 days	XGBoost		LR,NN,XGBoost	-	NN,RF,XGBoost	
QPS < 0.05	NN,RF,XGBoost,AttnLSTM		NN,RF,XGBoost,AttnLSTM	LR,NN,AttnLSTM	NN,RF,XGBoost,AttnLSTM	
Youden $J > 0.9$	RF,XGBoost		NN,RF,XGBoost,AttnLSTM	-	NN,RF,XGBoost,AttnLSTM	
SAR > 0.8	RF		LR,RF,AttnLSTM	-		AttnLSTM
best model		SWARCH-NN/AttnLSTM		SWARCH-AttnLSTM		
panel (b): long-term						
hit(1) > 90	NN,RF,AttnLSTM	KLR,NN,RF,XGBoost,AttnLSTM	NN,RF,AttnLSTM	NN,RF,XGBoost,AttnLSTM	NN,RF,XGBoost,AttnLSTM	
hit(2) > 80	KLR	LR,KLR,NN,RF,XGBoost,AttnLSTM	NN,AttnLSTM	NN,AttnLSTM	NN,AttnLSTM	
hit(3) < 10	XGBoost,AttnLSTM	NN,RF,XGBoost,AttnLSTM	XGBoost	XGBoost	RF,XGBoost	
hit(4) > 2 month	KLR	LR,KLR,NN,RF,XGBoost,AttnLSTM		-	KLR,AttnLSTM	
QPS < 0.05	-	NN,RF,XGBoost,AttnLSTM		-	RF,XGBoost,AttnLSTM	
Youden $J > 0.9$	-	NN,RF,XGBoost,AttnLSTM	NN,AttnLSTM	NN,AttnLSTM	RF,XGBoost,AttnLSTM	
SAR > 0.8	-	NN,RF,AttnLSTM	NN,AttnLSTM	NN,AttnLSTM	NN,RF,AttnLSTM	
best model		SWARCH-NN/RF/AttnLSTM		SWARCH-AttnLSTM		

predicting currency and stock crises, particularly yet for long-term currency crises prediction, recommends the SWARCH-RF.

3.4. Back testing and Reality check

The predictive models in the financial applications that are blamed for its lack of practical verification bear the questioning on whether the predictability is equivalent to the effectiveness in real world. Thus the dynamical portfolio allocation will be applied according to investors' risk aversion variation given properly predicted the crisis episodes, thereby to validate whether the prominent crisis forecasting system will bring attractive returns in practice.

Table 12: Back-test results of asset allocation on out-of-samples.

risk aversion level		low: $\gamma = 1$		medium: $\gamma = 2$		high: $\gamma = 3$	
panel(a): daily		Sharpe ratio	CER	Sharpe ratio	CER	Sharpe ratio	CER
benchmark	buy-and-hold	0.236	7.74	0.241	-2.66	0.244	-6.12
	TQI	0.307	8.42	0.306	0.204	0.291	-3.67
	SWARCH	0.454	10.2	0.442	2.25	0.390	-2.82
TQI -	-LR	0.344	8.04	0.302	1.33	0.288	-2.36
	-KLR	0.234	7.76	0.238	-0.943	0.243	-3.37
	-NN	0.362	7.83	0.312	1.65	0.295	-2.24
	-RF	0.351	7.84	0.305	1.40	0.289	-2.31
	-XGBoost	0.336	7.85	0.340	0.893	0.344	-2.34
	-AttnLSTM	0.368	8.67	0.372	1.43	0.391	-2.28
SWARCH -	-LR	0.498	10.8	0.441	2.92	0.391	0.015
	-KLR	0.504	9.31	0.440	2.86	0.389	0.010
	-NN	0.517	11.8	0.443	2.89	0.391	0.020
	-RF	0.508	11.0	0.442	2.89	0.390	0.004
	-XGBoost	0.508	10.5	0.442	2.89	0.391	0.008
	-AttnLSTM	0.518	11.5	0.461	3.22	0.407	0.024
panel(b): monthly		Sharpe ratio	CER	Sharpe ratio	CER	Sharpe ratio	CER
benchmark	buy-and-hold	0.409	20.3	0.448	-14.1	0.478	-26.3
	TQI	0.448	22.2	0.469	-15.6	0.481	-27.6
	SWARCH	0.497	22.4	0.502	-10.8	0.509	-20.5
TQI -	-LR	0.517	24.5	0.495	-3.65	0.496	-14.3
	-KLR	0.505	23.8	0.487	-2.27	0.503	-13.6
	-NN	0.534	27.2	0.455	-2.92	0.462	-15.8
	-RF	0.492	22.4	0.499	-0.07	0.508	-11.3
	-XGBoost	0.493	22.5	0.499	-0.07	0.509	-11.1
	-AttnLSTM	0.541	26.8	0.519	1.57	0.526	-10.3
SWARCH -	-LR	0.503	22.6	0.505	0.350	0.506	-11.4
	-KLR	0.519	25.8	0.492	-0.741	0.497	-15.8
	-NN	0.516	23.9	0.509	0.473	0.512	-11.0
	-RF	0.513	23.8	0.512	0.782	0.513	-11.3
	-XGBoost	0.513	23.8	0.512	0.781	0.514	-11.2
	-AttnLSTM	0.556	29.8	0.534	2.24	0.528	-10.5

In the study, three assets of SSEC index, exchange rate against U.S. dollar and risk-free interest¹⁹ will be accounted into the back test. To make a fair situation, we impose a key assumption that no informative asymmetry exists as practitioners access the early warning model outputs and construct the portfolio based on the produced warning signals varied risk aversion. Three benchmark portfolios will be constructed by taking 'buy-and-hold', solely applied 'TQI' and solely applied 'SWARCH' strategies that not involve predicted results.

Table 12 shows the Sharpe ratios and Certainty Equivalent Return (CER) under different constant base risk aversion levels of low, medium and high for both daily and monthly exercising scenarios. Among three benchmarks, the crisis classifier adopted portfolios, especially the SWARCH classifier adopted, is most preferred by either doubling (for short-term daily panel) or gaining a quarter (for long-term monthly panel) than the low risk aversion buy-and-holders produced Sharpe ratios. In panel (a), as compare to buy-and-hold, the TQI based

¹⁹The risk-free rate is adopted as the bank short-term deposit interest rate.

EWS though contributes the investors by gaining Sharpe ratio, the gain is in a mild range of no more than 50%, in contrast, SWARCH based forecasting system boosts the gain to more than 100%. Further referring to the CER, SWARCH hybrid EWS even remarkably turns the value from negative to positive (even though close to zero) in the high risk aversion column. The situation for monthly case, as panel (b) shows, however, is quite different since neither the TQI based nor SWARCH based EWS models involved portfolios returns on Sharpe ratios and CERs are significantly improved as compare to benchmarks. But it is worthy to note, as the risk aversion is in medium level, the positive CER can only be retrieved by SWARCH based EWS and TQI-AttnLSTM models, which advocates the Attention based deep learning model robustness in gaining the practical benefits. In short, SWARCH-AttnLSTM is highly recommended to short-term investors regardless of the risk preference since it universally issues the greatest Sharpe ratios of 0.518, 0.461 and 0.407, and maximal CERs, except SWARCH-NN gives 11.8 given $\gamma = 1$, of 3.22 and 0.024 among all calculations, and it still wins in the long-term investment but with a weak edge.

We also find the EWS may reverse investors earning profit situation according to their risk aversion level. Particularly, the high-risk seeker ($\gamma = 1$) who previously have lower Sharpe ratios than conservative investors ($\gamma = 3$) as holding benchmark portfolios will benefit more as apply the EWS to adjust portfolio weights especially for short-term investment. This conclusion is consistent with Hasler et al. (2019) who claim that accounting for timing of equity risks will advantage the investing portfolio returns by increasing the CER of 3%. Meanwhile, since the selling pressure of short-term investors is proven positively linked to market crash (Fan and Fu, 2020), the dynamically constructed portfolio according to EWS produced warning signals will faithfully support practical solution to adjust asset weights and to further avert dreadful panic that always manifests in uninstructed situation.

To investigate whether the EWS forecasting robustness in back-testing is accidental or not, reality check will be implemented. The benchmarks mainly keep same settings as back-testing, but will be slightly changed in opting the EWS contrast group, that is the benchmark of TQI crisis classifier will only appoint to TQI based EWS models group and vice versa. This setting will project the predictive models effort more in comparisons.

Table 13 reasons the credibility of back-testing results given p-values below 0.1, which indicates the null hypothesis that the EWS does not help to diminish the return variance can be strongly rejected. The p-values that exceed 0.1 or close to 0.1, mainly locate in TQI-XGBoost based EWS for daily prediction and traditional econometric models of LR and KLR based EWS for monthly prediction, which cautions investors against such EWS models that may produce less reliable results to minimize the volatility triggered risks in returns. Besides, the SWARCH combined machine learning EWS models, especially combined tree models of RF, are most likely to pass through the reality check by harvesting more zero or close to zero p-values in the comparison. The highly recommended model in back-testing, SWARCH-AttnLSTM, however puts a bit of damper by losing credibility at 0.05 level, specifically providing 0.054, 0.049 and 0.062, as compare to the benchmark of solely adopting SWARCH classifier in terms of daily prediction. In the comparisons, the suspect on the credibility of composing a hybrid warning system in contrast to solely exercising identified crises from classifiers, though, cannot be fully dislodged since most presented p_{B1} 's are generally smaller than p_{B2} 's, which implies the return variance harder to be kept lowering as predictive model is introduced after identified crisis being applied to ameliorate the asset returns, the machine learning hybrid EWS models adopted on monthly prediction strike the this suspicious assertion by giving smaller p_{B2} than p_{B1} , for example SWARCH-NN/RF/XG present p_{B2} zero at 0.1% significant level but p_{B1} greater than 0.01 for low and medium risk aversion investors.

In general, the SWARCH combined machine learning models generally outperform among the developed hybrid EWS models, and such stylized models show comparative practical persuasion in varied investing risk preference. Traditional econometric models, especially combined with the classic technically quantified index crisis classifier, seem to faintly satisfy modern requisite on not only the high predicting precision but the demanding portability in practice. Hence, on the premise that both data quantity and quality can be guaranteed, the investors or decision makers are more likely to appeal to the stylized warning systems instructed warning signals.

3.5. Leading factors

The estimation on leading factors will not only attribute the contributing degree to inform of predicting crises, also distinguish the factors that should be regularly inspected among multi-source information as well. For each applied predictive model, the input features importance can be estimated and extracted from model produced results, specifically, the logistic regression bases on the parameter's coefficient, non-parametric KLR approach relies on the calculation for noise-to-signal ratios, neural networks have dropping one factor each time to infer the accuracy loss as feature importance, random forest hires the metric of mean decrease accuracy

Table 13: Reality check on EWS model robustness.

risk aversion level		low: $\gamma = 1$	medium: $\gamma = 2$	high: $\gamma = 3$			
panel (a): daily		$p_{B_1}^a$	$p_{B_2}^a$	p_{B_1}	p_{B_2}	p_{B_1}	p_{B_2}
TQI-	-LR	0.039	0.054	0.016	0.084	0.021	0.083
	-KLR	0.031	0.110	0.029	0.091	0.021	0.086
	-NN	0.060	0.090	0.047	0.111	0.036	0.102
	-RF	0.001	0.011	0.005	0.012	0.010	0.011
	-XG	0.087	0.125	0.079	0.092	0.078	0.083
	-AttnLSTM	0.051	0.081	0.043	0.082	0.037	0.072
SWARCH-	-LR	0***	0.073	0.002	0.066	0.003	0.061
	-KLR	0.013	0.087	0.032	0.072	0.034	0.088
	-NN	0***	0.083	0.002	0.078	0.002	0.072
	-RF	0***	0***	0.002	0***	0.002	0***
	-XG	0***	0.026	0.002	0.017	0.002	0.023
	-AttnLSTM	0***	0.054	0.001	0.049	0.002	0.062
panel (b): monthly		$p_{B_1}^a$	$p_{B_2}^a$	p_{B_1}	p_{B_2}	p_{B_1}	p_{B_2}
TQI-	-LR	0.070	0.156	0.071	0.159	0.071	0.121
	-KLR	0.050	0.171	0.064	0.124	0.049	0.133
	-NN	0.031	0.066	0.032	0.067	0.036	0.067
	-RF	0.018	0.014	0.016	0.015	0.008	0.013
	-XG	0.017	0.014	0.019	0.020	0.008	0.010
	-AttnLSTM	0.019	0***	0.024	0***	0.006	0***
SWARCH-	-LR	0.019	0.091	0.017	0.083	0.007	0.075
	-KLR	0.057	0.079	0.054	0.076	0.056	0.092
	-NN	0.020	0***	0.024	0***	0.006	0***
	-RF	0.020	0***	0.025	0***	0.008	0***
	-XG	0.019	0***	0.021	0***	0.008	0.014
	-AttnLSTM	0.014	0.009	0.023	0.002	0.010	0.007

^a B_1 is the benchmark of buy-and-hold. B_2 is TQI for TQI based EWS and SWARCH for SWARCH based EWS. *** denote at 0.1% significance level.

(MDA)²⁰, XGBoost uses the gain that represents the fractional contribution of each factor based on the total gain of this factor's split, and the attention based LSTM extracts the final learnt attention weights for each features.

Table 14 further summarizes the model detected leading factors by collecting the estimated results on factor contribution that are displayed in Table 15-18, where the highlighted bold numbers are recognized significant impact on the crisis prediction. According to the Table 14, the most frequently drawn factors are frx (exchange rate), gdp_p2 (per capital GDP year-on-year basis) and ind.g (industrial added value as the percentage of annual GDP), which suggests that currency exchange rate dynamics itself and macroeconomic factors relating to the national production situation should be early cautioned for crisis prediction regardless of the prediction term. In fact, the real exchange rate has been proven to be the most significant leading factor for predicting currency crisis (Kaminsky et al., 1998; Berg and Pattillo, 1999b; Babecký et al., 2013), and meanwhile provides the significant evidence to be contagious to the stock market (Chatzis et al., 2018), which factor also gets accreditation in our study. It is noted that, the reverse contagion relationship from stock to currency seems to not exist since the neither stock index dynamics nor stock return rate significantly contribute to currency crisis prediction. Different from previous argument (Kaminsky et al., 1998; Berg and Pattillo, 1999b) that claims the reserves and exports are crucial to indicate currency crisis, we find rare connection between such factors (frx_res and im_ex) and Chinese currency and stock market crisis forewarning, in contrary, the domestic economy related indicators (gdp_p2 and ind.g) are highlighted. It implies that the market turbulence is more likely to be prepeded by the forthcoming economy recession, not be fully signed by the monetary policy control and international trades. Furthermore, the leading factors that precede to the market crisis are essentially different,

²⁰There are in fact two metrics for RF to draw the feature importance, mean decrease accuracy (MDA) and mean decrease Gini (MDG). In the study, we take MDA since its observed value variation is more distinctive than MDG provided in terms of information gain.

in some case, even market-characteristic, for instance, the inflation factors, such as discount rate and CPI, are hardly ignored in signing the long-term currency crisis but do not share any contribution to warn stocks. This may imply the domestic money purchasing power could drive the volatile level of foreign exchange market in the fiscal policy channel, but seems not possibly to rock the share prices.

Table 14: Leading factors: summary of model detected leading factors for currency and stock market.

	currency		stocks	
	short-term	long-term	short-term	long-term
ssec			(1)RF	(4)NN,RF,XG,Attn
ssec_r			(2)XG,Attn	
sez			(2)RF,XG	
sez_r				
frx	(3)KLR,NN,RF	(3)KLR,NN,Attn	(2)NN,Attn	(3)LR,KLR,Attn
frx_r	(4)NN,RF,XG,Annt			
frx_res				
dis_r		(3)NN,RF,XG		
int_r			(1)LR	
bal_g		(2)KLR,RF	(2)XG,Attn	(3)KLR,RF,Attn
cci	(2)KLR, Attn			
cpi		(1)XG		
comd_g	(1)LR		(2)KLR,Attn	
deb_g	(1)LR	(1)LR	(2)LR,KLR	
dom_c		(2)RF,XG		
dom_g	(1)LR		(3)KLR,NN,Attn	
fix_a				
gdp_p		(1)KLR		(1)KLR
gdp_p2	(2)LR,NN	(2)RF,XG	(2)KLR,Attn	(1)RF
gdp_c		(1)NN		
im_ex				
ind_g	(2)LR,NN	(2)NN,Attn	(3)LR,NN,Attn	(1)LR
ind_p	(3)KLR,XG,Attn			
ind_v				
inf_r	(1)KLR		(1)LR	(4)NN,RF,XG,Attn
mac_c	(3)LR,KLR,RF			
m2_g			(1)KLR	
ppi	(2)RF,XG		(3)NN,XG,Attn	
real_c	(1)LR		(1)XG	
rpi			(2)LR,XG	
rrr	(1)KLR			
shibor				
tax_r				
vix	(2)XG,Attn		(2)RF,Attn	
gold			(3)NN,RF,XG	
oil				

The summarized table information also instructs short-term and long-term investments in inspecting the leading factors with varied perspectives. On one hand, the return rates more influence than the price/index itself on short-term prediction, for instance, XGBoost and Attention-LSTM catch the ssec_r, and neural networks, random forest, XGBoost and Attention-LSTM catch the frx_r to predict stocks and currency market in short-term, but disappear to hint the long-term crisis. On the other hand, the short-term prediction requires more government published composite factors from external economy sectors, such as the macroeconomic climate indicator (mac_c), the real-estate climate index (real_c) and PPI (ppi), and globe market dynamics index, for instance VIX (vix), to be referred than long-term. It thus advises short-term investors to take full considerations, not merely on the price dynamics and market directly related factors, but recruit external economic information, especially the authority labeled index and globe economy dynamics, as well, to improve their risk resistance before the economy sloping down begins.

Table 15: Estimated contribution degree of factor variables for currency market: short-term prediction.

	Coef. ^a _{LR}	NSR _{KLR}	Imp. ^b _{NN}	MDA _{RF}	Imp. _{XGBoost}	Wgt. ^c _{AttnLSTM}
ssec	9.19(0)	2.375	---	4.105	1.07	1.152
ssec_r	-37.45(0)	0.8562	--	0.4071	1.27	1.512
sez	-3.32(0)	2.189	0.1	1.248	2.05	3.326
sez_r	73.7(0)	0.9599	--	1.010	0.55	3.160
fx	-228.2(0)	0.311	0.73	5.743	2.04	1.962
fx_r	720.3(0)	---	0.95	15.29	65.01	5.380
fx_res	-2.97(0)	1.559	0.32	0	---	2.507
dis_r	531.9(0)	1.197	0.16	1.010	0.04	0.7376
int_r	227.4(0)	Inf ^d	0.22	0	--	0.4926
bal_g	-528(0)	1.596	--	0	--	0.849
cci	-165.9(0)	0.7493	0.11	4.037	0.36	5.252
cpi	15.22(0)	--	--	1.733	--	2.930
comd_g	2122.3(0)	1.097	--	0	--	1.242
deb_g	1198.2(0)	0.8869	--	1.010	--	3.517
dom_c	-0.141(0)	1.018	0.12	0.6468	--	3.496
dom_g	-1613(0)	1.272	--	1.720	--	3.507
fx_a	671.5(0)	2.165	0.45	0	0.07	1.030
gdp_p	-0.717(0)	1.026	--	1.010	--	3.514
gdp_p2	2587.5(0)	Inf	0.54	2.058	--	0.5556
gdp_c	-856.5(0)	2.053	--	0	0.97	2.300
im_ex	100.5(0)	--	--	0	0.50	1.886
ind_g	-1452(0)	1.013	1.53	1.075	--	1.341
ind_p	-877.4(0)	0.7153	--	2.948	9.86	5.410
ind_v	-346.2(0)	1.150	0.25	1.010	--	2.705
inf_r	-451(0)	0.7809	--	1.436	--	1.962
mac_c	1075(0)	0.7619	0.14	2.457	0.05	3.239
m2_g	447.4(0)	1.437	0.13	1.229	--	2.516
ppi	-150.5(0)	--	--	5.210	7.05	2.958
real_c	1382(0)	0.9522	--	1.602	0.89	1.645
rpi	-299.4(0)	--	--	2.291	--	2.097
rrr	-620.9(0)	0.5799	0.15	0	--	3.462
shibor	-917(0)	0.8523	0.48	1.010	--	1.578
tax_r	0.116(0)	1.035	0.16	2.983	2.84	2.399
vix	210.4(0)	0.8092	--	1.248	5.76	6.038
gold	16.67(0)	1.569	--	2.107	--	3.448
oil	61.84(0)	0.9192	--	3.535	0.61	1.879

^a the stepwise logistic regression is adopted. The p-value is labelled in the bracket.

^b the noise-signal ratio for some variable is either not available or infinity (Inf) since the divider (of the last time point) value is or extremely approaching to zero.

^c for neural networks model estimation, the importance value below 0.1% will not be displayed.

^d variables that are assessed to be utterly useless will not be calculated the importance in XGBoost, and the value will be transformed to percentage of 100%

^e both the importance for neural networks and the attention weight for attention-LSTM have been transformed to percentage, i.e. the each weight value times 100%.

Table 16: Estimated contribution degree of factor variables for currency market: long-term prediction.

	Coef. _{LR}	NSR _{KLR}	Imp _{NN}	MDA _{RF}	Imp _{XGBoost}	Wgt. _{AttnLSTM}
ssec	-0.317(0.59)	0.7238	1.01	3.479	1.10	1.938
ssec_r	--	1.086	--	0.6342	--	2.798
sez	-0.318(0.43)	0.8685	0.79	1.765	--	1.948
sez_r	--	1.194	--	1.612	--	3.452
frx	--	0.5429	4.52	1.556	--	5.812
frx_r	--	--	1.26	0.8380	--	2.648
frx_res	--	0.5664	0.25	2.791	--	1.457
dis_r	--	1.086	3.38	5.681	15.69	3.252
int_r	--	1.396	--	0	--	1.394
bal_g	--	0.543	0.37	6.422	--	2.962
cci	--	0.8143	1.71	1.742	--	3.380
cpi	--	--	1.35	2.698	22.97	3.095
comd_g	--	0.8531	1.49	2.202	4.13	1.688
deb_g	469.2(0.16)	6.287	--	1.663	--	1.965
dom_c	--	0.8821	0.41	5.114	20.53	2.2
dom_g	--	0.8143	--	1.391	0.8217	2.028
fix_a	--	1.021	--	4.175	0.1466	1.448
gdp_p	-0.190(0.87)	0.5428	--	1.381	--	1.475
gdp_p2	--	1.086	2.73	6.047	22.41	2.040
gdp_c	--	2.081	4.49	3.787	--	3.946
im_ex	--	1.683	--	3.405	--	1.424
ind_g	--	0.5428	2.21	2.755	0.1445	5.038
ind_p	--	1.357	--	2.472	--	4.286
ind_v	--	1.154	--	1.767	--	2.403
inf_r	--	2.171	--	1.737	--	1.966
mac_c	--	0.9396	1.64	4.445	4.06	1.651
m2_g	-32.95(0.31)	6.514	--	2.451	--	2.295
ppi	-40.29(0.34)	0.9952	--	1.483	--	2.006
real_c	--	1.670	0.74	1.989	1.17	1.437
rpi	101.6(0.14)	1.469	--	1.484	--	3.799
rrr	69.82(0.16)	0.9870	1.19	2.2	1.12	1.471
shibor	177.8(0.55)	1.163	--	1.340	--	3.20
tax_r	--	0.7367	--	0	--	3.116
vix	--	1.493	1.3	4.247	5.72	2.795
gold	--	1.706	5.18	1.642	--	3.1
oil	--	1.425	2.36	1.006	--	2.564

Table 17: Estimated contribution degree of factor variables for stock market: short-term prediction.

	Coef. $_{LR}$	NSR $_{KLR}$	Imp. $_{NV}$	MDA $_{RF}$	Imp. $_{XGBoost}$	Wgt. $_{AttnLSTM}$
ssec	-4.439(1E-13)	0.815	2.54	19.67	3.723	2.513
ssec_r	-86.34(7E-04)	0.9288	--	6.601	6.348	5.467
sez	0.8479(2E-07)	0.8982	1.25	15.94	6.914	1.485
sez_r	-99.11(1E-03)	1.013	--	7.343	1.021	2.649
fx	--	1.502	14.8	9.588	1.816	5.605
fx_r	--	--	--	8.254	1.182	1.182
fx_res	--	1.256	1.62	5.405	--	0.1031
dis_r	-229.2(6E-07)	Inf	--	2.758	--	4.603
int_r	3473 (0.03)	Inf	--	1.750	--	4.588
bal_g	-799.3(9E-11)	0.6569	0.87	2.540	7.752	5.974
cci	69.73(0.135)	0.7915	1.75	4.776	1.858	1.446
cpi	1418(2E-06)	--	1.07	7.420	--	3.396
comd_g	577.5(2E-09)	0.4778	--	12.11	0.927	5.323
deb_g	-2131 (2E-14)	0.5915	--	1.805	--	0.0339
dom_c	0.0592(8E-08)	0.6995	--	5.768	3.769	0.1986
dom_g	-275.6(2E-11)	0.4977	5.88	1.744	--	5.460
fix_a	131.6(3E-06)	0.8305	--	6.866	3.231	0.1257
gdp_p	1.563(1E-11)	0.6271	--	2.307	--	0.0525
gdp_p2	--	0.5773	0.96	4.483	2.967	5.571
gdp_c	-175.6(3E-15)	0.8029	3.66	3.308	2.217	1.651
im_ex	97.78(2E-15)	0.7117	0.65	10.59	3.354	3.221
ind_g	-2292 (5E-04)	1.085	5.78	3.703	--	5.026
ind_p	-374.4(1E-07)	0.7202	--	12.83	4.944	0.9214
ind_v	-99.84(4E-04)	0.8155	--	12.57	4.687	4.116
infr	-1865 (1E-14)	0.8162	1.90	2.064	--	3.4
mac_c	444.3(4E-08)	1.718	--	6.047	--	1.529
m2_g	326.2(5E-09)	0.4629	--	2.577	--	0.0388
ppi	-548.2(5E-08)	--	9.37	10.42	9.090	5.399
real_c	-409.3(4E-07)	0.9107	4.08	9.425	8.144	2.65
rpi	-1803 (6E-07)	--	0.34	7.656	8.452	2.707
rrr	964.6(4E-07)	Inf	0.67	3.036	--	0.4772
shibor	--	1.342	--	5.992	--	2.445
tax_r	-0.1786(0.03)	0.7438	--	8.948	1.234	0.9698
vix	--	1.137	--	14.46	--	5.539
gold	-3.169(0.03)	1.359	5.94	19.43	6.864	0.593
oil	31.61(0.04)	1.189	--	12.76	3.856	3.341

Table 18: Estimated contribution degree of factor variables for stock market: long-term prediction.

	Coef. _{LR}	NSR _{KLR}	Imp. _{NN}	MDA _{RF}	Imp. _{XGB_{oost}}	Wgt. _{AttnLSTM}
ssec	--	0.5134	3.77	8.645	53.88	5.451
ssec_r	--	0.8956	--	0.7281	--	4.052
sez	--	0.6135	2.03	2.795	--	1.282
sez_r	--	1.037	--	0.8754	2.033	3.119
frx	-1.489(0.17)	0.4242	1.45	2.678	1.236	6.282
frx_r	--	--	--	1.421	0.4794	2.986
frx_res	-0.063(0.68)	0.5805	--	1.865	--	0.9285
dis_r	--	--	--	1.004	--	2.766
int_r	--	1.527	--	0	--	4.581
bal_g	--	0.4243	1.08	7.403	3.08	5.395
cci	--	0.8485	0.25	2.44	--	3.174
cpi	--	--	--	2.988	--	2.074
comd_g	61.0(0.66)	14.0	0.74	1.644	--	1.516
deb_g	--	1.556	--	1.886	--	1.779
dom_c	--	1.349	--	3.069	0.8384	0.9928
dom_g	--	1.1167	0.68	2.087	--	1.602
fix_a	--	Inf	0.37	2.109	--	1.840
gdp_p	--	0.4242	--	3.196	--	0.9738
gdp_p2	--	0.8485	1.73	5.368	--	1.689
gdp_c	--	1.591	0.50	1.573	--	4.643
im_ex	--	1.157	2.27	0.4827	--	4.118
ind_g	-230.2(0.27)	0.8485	2.13	2.418	--	4.709
ind_p	--	1.219	--	1.004	--	3.339
ind_v	--	9.121	--	2.656	0.0525	3.423
inf_r	--	9.30	4.97	11.34	31.64	5.038
mac_c	--	1.303	--	1.475	--	2.842
m2_g	-6.76(0.86)	1.468	1.26	2.682	--	1.851
ppi	--	2.121	1.23	2.916	--	3.432
real_c	--	1.612	2.53	2.423	2.734	2.140
rpi	--	2.439	0.95	2.177	--	1.740
rrr	--	--	--	0.7252	--	1.605
shibor	--	0.9015	3.44	0.8355	--	3.014
tax_r	--	0.5874	--	1.424	0.0506	1.062
vix	--	1.113	--	2.439	--	3.258
gold	--	0.5833	3.33	2.091	1.496	0.9897
oil	-6.82(0.89)	1.023	0.79	1.286	2.482	1.329

4. Conclusions

This paper contributes to uniformly reorganize the debating arguments on constructing early warning systems to predict financial crises in a full comprehending way to compare two essential components of crisis identifier and crisis predictive models in a unified frameworks, and discuss the variation of leading factors' linkage to sign the market-specific crisis as the deep-going inspection is demanded by policy makers and practitioners to give adjustment and further diminish risks that potentially drive the economic downturn.

We experiment a full mixing of hybrid EWS models, including classic technical quantified index and Markov switching ARCH model based crisis classifiers, and traditional econometric and state-of-art machine learning based predictive models, on Chinese currency and stock markets in the past twenty-four years daily and monthly data, and mainly get three-fold results. First and foremost, the argument of crisis being predictable seems not be possible to sink but float, even wander, in the debating pool, as the market endogenous instability is proven to be inferred from sufficient forewarning data sources given the modern blossoming powerful predicting techniques. Second, the crisis variable definition should be diversified for a varied predicting period and the SWARCH classified crisis observations is statistically examined more effective as it distinguishes the price index volatility dynamics into several state levels, such as low and high, or low, medium and high, according to the amplitude of fluctuations, and elastically adjusts the value of threshold to augment the crisis identifying flexibility. Third, the SWARCH with automatically optimized threshold combined deep neural networks models cluster outperform other EWS combinations, more specifically, in the view of predicting power, it show greatest robustness given highest precision and widest precautionary periods, and in the practical perspective, it has been back tested to succeed most in terms of lowering the EWS involved portfolio returns instability, especially for daily exercising. Last but not least, the leading factors' variation, the point has yet been discussed in previous studies but begins to start up in our study, is assignable for market-specific crisis prediction. Besides, the predicting term is investigated to negatively effect the quantity of included leading factors, in other words, shorter the term is, more factors will be drawn as leading indicators to foresee crises, albeit in a somewhat overloaded information disturbance in the real world.

According to the results, we conclude major implications in the practical application perspective. First of all, the necessity of introducing an effective classifier to the crisis prediction is verified in the study, since such crisis identification technique, for example the SWARCH with dynamically optimized cutoff model, is capable of, not only weakening the impact from imbalanced sample distribution, as Chatzis et al. (2018) previously mentioned, but boosting the warning system's predicting power as well. Second, the machine learning model based EWS cluster, though often bears the criticism on over-parameterization and weak interpretability (of inner cell parameters and structural weights), does give compelling performance on crisis predicting effectiveness and lowering investment risk in empirical application. It is though hard to dogmatically assert that machine learning based warning systems generally dominate the traditional models, especially considering there should be a great diversity among different types of financial crises, at least, proportional to the market information symmetry, machine learning, especially deep learning, base early warning system should be designated as long as the data sources are abundantly acquired. Third, there is a unilateral contagious effect across the stock and currency crises, that is the exchange rate dynamics can be referred as a precognition factor to forewarn the stock market crisis, but the reverse risk transmission from stocks to currency is yet revealed by evident proofs. Thus, in final, for decision makers, constructing an early warning system is required to considerately examine whether the classification methodology is competent to fully reflect the market fluctuation according to their each volatility rules, in addition to select the most suitable model in line with different objectives, such as either solely pursuing high predicting accuracy or ensuring the output reliability, and either searching for striking factors to crises or implementing mixed aims. On the other hand, in the investor's view, especially for short-term investors with low risk aversion, the requirements to model producing timely and effective warning signals share a greater priority considering they may undertake higher risk of loss in crises, therefore, referring forewarned results from an ensemble of EWS models probably keep them safer than solely relying on one.

The concluded remarks in the study do not aim for depriving the privilege on open questioning and further exploring the predicting system generalizations, but to achieve the extensibility on the crisis predictability arguments and the comprehensiveness on the early warning system predicting precision and practical value. This study suggests, among a broad aggregation of crisis forecasting methodologies, the crisis identification that relies on the volatility regime switching frameworks partnering with the predictive models that entrust stylized machine learning techniques (especially deep neurons networks), seem to earn rather more accreditation than traditional means under the high-frequency data preliminaries. Further efforts, based on current inspiring findings, are thus worthy of being paid in following aspects: (i) at the methodological level, the diversity of machine learning methods are encouraged to be explored, especially in arithmetic and structures design; (ii) at the computational level, as the computing capacity is continuously boosting, precisely forecasting the timing

of crises or crashing events will no longer be unattainable goal if the real-time computation can be introduced; (iii) at the data level, either cross-section or cross-country is yet discussed but highly valued in research on the crisis recurrences for regional and global economies as long as the database accessing is not restricted.

References

- Abiad, A.. Early Warning Systems for Currency Crises: A Regime-Switching Approach; Boston, MA: Springer US. p. 155–184. URL: https://doi.org/10.1007/0-387-71163-5_10. doi:10.1007/0-387-71163-5_10.
- Ahn, J.J., Oh, K.J., Kim, T.Y., Kim, D.H.. Usefulness of support vector machine to develop an early warning system for financial crisis. *Expert Systems with Applications* 2011;38(4):2966 – 2973. URL: <http://www.sciencedirect.com/science/article/pii/S095741741000881X>. doi:<https://doi.org/10.1016/j.eswa.2010.08.085>.
- Allison Nathan, D.G.. Currency wars. *Top of Mind* 2019;URL: <https://www.goldmansachs.com/insights/pages/currency-wars-f/report.pdf>.
- Ang, A., Bekaert, G.. Regime switches in interest rates. *Journal of Business & Economic Statistics* 2002;20(2):163–182.
- Arthur, W.B.. Complexity and the economy. *Science* 1999;284(5411):107–109. URL: <https://science.sciencemag.org/content/284/5411/107>. doi:10.1126/science.284.5411.107.
- Babecký, J., Havránek, T., Matějů, J., Rusnák, M., Šmídková, K., Vašíček, B.. Leading indicators of crisis incidence: Evidence from developed countries. *Journal of International Money and Finance* 2013;35:1 – 19. URL: <http://www.sciencedirect.com/science/article/pii/S0261560613000028>.
- Beckmann, R.. Profitability of Western European banking systems: panel evidence on structural and cyclical determinants. *Discussion Paper Series 2: Banking and Financial Studies* 2007,17; Deutsche Bundesbank; 2007. URL: <https://ideas.repec.org/p/zbw/bubdp2/6929.html>.
- BenSaïda, A.. The contagion effect in European sovereign debt markets: A regime-switching vine copula approach. *International Review of Financial Analysis* 2018;58(C):153–165. doi:10.1016/j.irfa.2017.10.00.
- Berg, A., Borensztein, E., Pattillo, C.. Assessing early warning systems: How have they worked in practice? *IMF Staff Papers* 2005;52(3):462–502. URL: <http://www.jstor.org/stable/30035972>.
- Berg, A., Pattillo, C.. Are Currency Crises Predictable? A Test. *IMF Staff Papers* 1999a;46(2):1–1.
- Berg, A., Pattillo, C.. Predicting currency crises: The indicators approach and an alternative. *Journal of International Money and Finance* 1999b;18(4):561 – 586. URL: <http://www.sciencedirect.com/science/article/pii/S0261560699000248>. doi:[https://doi.org/10.1016/S0261-5606\(99\)00024-8](https://doi.org/10.1016/S0261-5606(99)00024-8).
- Beutel, J., List, S., [von Schweinitz], G.. Does machine learning help us predict banking crises? *Journal of Financial Stability* 2019;45:100693. URL: <http://www.sciencedirect.com/science/article/pii/S1572308918305801>. doi:<https://doi.org/10.1016/j.jfs.2019.100693>.
- Bussiere, M., Fratzscher, M.. Towards a new early warning system of financial crises. *Journal of International Money and Finance* 2006;25(6):953 – 973. URL: <http://www.sciencedirect.com/science/article/pii/S0261560606000532>. doi:<https://doi.org/10.1016/j.jimonfin.2006.07.007>.
- Campbell, J.Y., Thompson, S.B.. Predicting excess stock returns out of sample: Can anything beat the historical average? *The Review of Financial Studies* 2007;21(4):1509–1531. URL: <https://doi.org/10.1093/rfs/hhm055>. doi:10.1093/rfs/hhm055. [arXiv:https://academic.oup.com/rfs/article-pdf/21/4/1509/24453399/hhm055.pdf](https://academic.oup.com/rfs/article-pdf/21/4/1509/24453399/hhm055.pdf).
- Candelon, B., Dumitrescu, E.I., Hurlin, C.. How to evaluate an early-warning system: Toward a unified statistical framework for assessing financial crises forecasting methods. *IMF Economic Review* 2012;60(1):75 – 113. URL: <https://doi.org/10.1057/imfer.2012.4>. doi:10.1057/imfer.2012.4.
- Candelon, B., Dumitrescu, E.I., Hurlin, C.. Currency crisis early warning systems: Why they should be dynamic. *International Journal of Forecasting* 2014;30(4):1016 – 1029. URL: <http://www.sciencedirect.com/science/article/pii/S0169207014000624>. doi:<https://doi.org/10.1016/j.ijforecast.2014.03.015>.
- Cao, J., Li, Z., Li, J.. Financial time series forecasting model based on ceemdan and lstm. *Physica A: Statistical Mechanics and its Applications* 2019;519:127–139.
- Caruana, R., Niculescu-Mizil, A.. Data mining in metric space: an empirical analysis of supervised learning performance criteria. In: *Proceedings of the tenth ACM SIGKDD international conference on Knowledge discovery and data mining*. ACM; 2004. p. 69–78.
- Celik, A.E., Karatepe, Y.. Evaluating and forecasting banking crises through neural network models: An application for turkish banking sector. *Expert Systems with Applications* 2007;33(4):809 – 815. URL: <http://www.sciencedirect.com/science/article/pii/S0957417406002132>. doi:<https://doi.org/10.1016/j.eswa.2006.07.005>.
- Chatzis, S.P., Siakoulis, V., Petropoulos, A., Stavroulakis, E., Vlachogiannakis, N.. Forecasting stock market crisis events using deep and statistical machine learning techniques. *Expert Systems with Applications* 2018;112:353 – 371. URL: <http://www.sciencedirect.com/science/article/pii/S0957417418303798>. doi:<https://doi.org/10.1016/j.eswa.2018.06.032>.
- Coudert, V., Gex, M.. Does risk aversion drive financial crises? testing the predictive power of empirical indicators. *Journal of Empirical Finance* 2008;15(2):167 – 184. URL: <http://www.sciencedirect.com/science/article/pii/S0927539807000679>. doi:<https://doi.org/10.1016/j.jempfin.2007.06.001>.
- Dai, Z., Dong, X., Kang, J., Hong, L.. Forecasting stock market returns: New technical indicators and two-step economic constraint method. *The North American Journal of Economics and Finance* 2020;53:101216. URL: <http://www.sciencedirect.com/science/article/pii/S1062940820301133>. doi:<https://doi.org/10.1016/j.najef.2020.101216>.
- Davis, E.P., Karim, D.. Comparing early warning systems for banking crises. *Journal of Financial Stability* 2008;4(2):89 – 120. URL: <http://www.sciencedirect.com/science/article/pii/S1572308908000144>. doi:<https://doi.org/10.1016/j.jfs.2007.12.004>.
- Dawood, M., Horsewood, N., Strobel, F.. Predicting sovereign debt crises: an early warning system approach. *Journal of Financial Stability* 2017;28:16–28.
- Demirgüç-Kunt, A., Detragiache, E.. The determinants of banking crises in developing and developed countries. *Staff Papers (International Monetary Fund)* 1998;45(1):81–109. URL: <http://www.jstor.org/stable/3867330>.
- Dong, H.K., Lee, S.J., Oh, K.J., Kim, T.Y.. An early warning system for financial crisis using a stock market instability index. *Expert Systems* 2009;26(3):260–273.

- Edwards, S., Susmel, R.. Volatility Dependence and Contagion in Emerging Equity Markets. *Journal of Development Economics* 2001;66(2):505–532. URL: <https://ideas.repec.org/a/eee/deveco/v66y2001i2p505-532.html>.
- Eichengreen, B., Rose, A.K., Wyplosz, C., Dumas, B., Weber, A.. Exchange market mayhem: The antecedents and aftermath of speculative attacks. *Economic Policy* 1995;10(21):249–312. URL: <http://www.jstor.org/stable/1344591>.
- Eijffinger, S., Karatas, B.. Together or apart? the relationship between currency and banking crises. *Journal of Banking & Finance* 2019;105631doi:10.1016/j.jbankfin.2019.105631.
- Fan, Y., Fu, H.. Institutional investors, selling pressure and crash risk: Evidence from china. *Emerging Markets Review* 2020;42:100670. URL: <http://www.sciencedirect.com/science/article/pii/S1566014119302985>. doi:<https://doi.org/10.1016/j.ememar.2019.100670>.
- Fauzi, R., Wahyudi, I.. The effect of firm and stock characteristics on stock returns: Stock market crash analysis. *The Journal of Finance and Data Science* 2016;2(2):112 – 124. URL: <http://www.sciencedirect.com/science/article/pii/S2405918816300204>. doi:<https://doi.org/10.1016/j.jfds.2016.07.001>.
- Fioramanti, M.. Predicting sovereign debt crises using artificial neural networks: A comparative approach. *Journal of Financial Stability* 2008;4(2):149–164. URL: <https://ideas.repec.org/a/eee/finsta/v4y2008i2p149-164.html>.
- Fischer, T., Krauss, C.. Deep learning with long short-term memory networks for financial market predictions. *European Journal of Operational Research* 2018;270(2):654–669.
- Frankel, J.A., Rose, A.K.. Currency crashes in emerging markets: an empirical treatment. *Social Science Electronic Publishing* 1996;41(3-4):351–366.
- Fu, J., Zhou, Q., Liu, Y., Wu, X.. Predicting stock market crises using daily stock market valuation and investor sentiment indicators. *The North American Journal of Economics and Finance* 2019;.
- Hamilton, J., Gang, L.. Stock Market Volatility and the Business Cycle. *Journal of Applied Econometrics* 1996;11(5):573–93.
- Hamilton, J.D., Susmel, R.. Autoregressive conditional heteroskedasticity and changes in regime. *Journal of Econometrics* 1994;64(1):307 – 333. URL: <http://www.sciencedirect.com/science/article/pii/0304407694900671>. doi:[https://doi.org/10.1016/0304-4076\(94\)90067-1](https://doi.org/10.1016/0304-4076(94)90067-1).
- Hasler, M., Khapko, M., Marfè, R.. Should investors learn about the timing of equity risk? *Journal of Financial Economics* 2019;132(3):182 – 204. URL: <http://www.sciencedirect.com/science/article/pii/S0304405X18303209>. doi:<https://doi.org/10.1016/j.jfineco.2018.11.011>.
- Holopainen, M., Sarlin, P.. Toward robust early-warning models: a horse race, ensembles and model uncertainty. *Quantitative Finance* 2017;17(12):1933–1963. URL: <https://doi.org/10.1080/14697688.2017.1357972>. doi:10.1080/14697688.2017.1357972.
- Kaminsky, G., Lizondo, S., Reinhart, C.. Leading indicators of currency crises. *International Monetary Fund* 1998;45. doi:10.1596/1813-9450-1852.
- Kaminsky, G.L., Reinhart, C.M.. The twin crises: The causes of banking and balance-of-payments problems. *The American Economic Review* 1999;89(3):473–500. URL: <http://www.jstor.org/stable/117029>.
- Kim, D.H., Lee, S.J., Oh, K.J., Kim, T.Y.. An early warning system for financial crisis using a stock market instability index. *Expert Systems* 2009;26(3):260–273. doi:10.1111/j.1468-0394.2009.00485.x.
- Kim, H., Batten, J.A., Ryu, D.. Financial crisis, bank diversification, and financial stability: Oecd countries. *International Review of Economics & Finance* 2020;65:94 – 104. URL: <http://www.sciencedirect.com/science/article/pii/S1059056019300371>. doi:<https://doi.org/10.1016/j.iref.2019.08.009>.
- Kim, T.Y., Oh, K.J., Sohn, I., Hwang, C.. Usefulness of artificial neural networks for early warning system of economic crisis. *Expert Systems with Applications* 2004;26(4):583 – 590. URL: <http://www.sciencedirect.com/science/article/pii/S0957417403002161>. doi:<https://doi.org/10.1016/j.eswa.2003.12.009>.
- Koyuncugil, A.S., Ozgulbas, N.. Financial early warning system model and data mining application for risk detection. *Expert Systems with Applications* 2012;39(6):6238 – 6253. doi:<https://doi.org/10.1016/j.eswa.2011.12.021>.
- Lestano, J.P.A.M.. Dating currency crises with ad hoc and extreme value-based thresholds: East asia 1970-2002 [dating currency crises];. *International Journal of Finance & Economics* 2007;12(4):371–388.
- Lestano, L., Jacobs, J., Kuper, G.. Indicators of financial crises do work! An early-warning system for six Asian countries. *International Finance; University Library of Munich, Germany*; 2004. URL: <https://EconPapers.repec.org/RePEc:wpa:wuwpif:0409001>.
- Li, W.X., Chen, C.C.S., French, J.J.. Toward an early warning system of financial crises: What can index futures and options tell us? *The Quarterly Review of Economics and Finance* 2015;55:87 – 99. URL: <http://www.sciencedirect.com/science/article/pii/S1062976914000611>. doi:<https://doi.org/10.1016/j.qref.2014.07.004>.
- Liu, Y.. Novel volatility forecasting using deep learning—long short term memory recurrent neural networks. *Expert Systems with Applications* 2019;132:99–109.
- Malkiel, B.G., Fama, E.F.. Efficient capital markets: A review of theory and empirical work*. *The Journal of Finance* 1970;25(2):383–417. URL: <https://onlinelibrary.wiley.com/doi/abs/10.1111/j.1540-6261.1970.tb00518.x>. doi:10.1111/j.1540-6261.1970.tb00518.x. arXiv:<https://onlinelibrary.wiley.com/doi/pdf/10.1111/j.1540-6261.1970.tb00518.x>.
- Nag, A.K., Mitra, A.. Neural networks and early warning indicators of currency crisis. 1999. In: Reserve Bank of India occasional papers.
- Oh, K.J., Kim, T.Y., Kim, C.. An early warning system for detection of financial crisis using financial market volatility. *Expert Systems* 2006;23(2):83–98. URL: <https://onlinelibrary.wiley.com/doi/abs/10.1111/j.1468-0394.2006.00326.x>. doi:10.1111/j.1468-0394.2006.00326.x.
- Ohtsu, N.. A threshold selection method from gray-level histograms. *IEEE Transactions on Systems Man & Cybernetics* 2007;9(1):62–66.
- Patel, S.A., Sarkar, A.. Crises in developed and emerging stock markets. *Financial Analysts Journal* 1998;54(6):50–61. URL: <https://doi.org/10.2469/faj.v54.n6.2225>. doi:10.2469/faj.v54.n6.2225.
- Peng, D., Bajona, C.. China’s vulnerability to currency crisis: A klr signals approach. *China Economic Review* 2008;19(2):138 – 151. doi:<https://doi.org/10.1016/j.chieco.2007.09.003>.
- Prewitt, J., Mendelsohn, M.. The analysis of cell images. *Annals of the New York Academy of Sciences* 1966;128:1035–53. doi:10.1111/j.1749-6632.1965.tb11715.x.
- Ramchand, L., Susmel, R.. Volatility and Cross Correlation across Major Stock Markets. *Journal of Empirical Finance* 1998;5(4):397–416. URL: <https://EconPapers.repec.org/RePEc:eee:empfin:v:5:y:1998:i:4:p:397-416>.
- Rapach, D.E., Strauss, J.K., Zhou, G.. Out-of-Sample Equity Premium Prediction: Combination Forecasts and Links to the Real

- Economy. The Review of Financial Studies 2009;23(2):821–862. URL: <https://doi.org/10.1093/rfs/hhp063>. doi:10.1093/rfs/hhp063. arXiv:<https://academic.oup.com/rfs/article-pdf/23/2/821/24436245/hhp063.pdf>.
- Reinhart, C.M., Rogoff, K.S.. From financial crash to debt crisis. American Economic Review 2011;101(5):1676–1706.
- Reinhart, C.M., Rogoff, K.S.. Banking crises: an equal opportunity menace. Journal of Banking & Finance 2013;37(11):4557–4573.
- Rosenfeld, A., Torre, P.D.L.. Histogram concavity analysis as an aid in threshold selection. IEEE Transactions on Systems Man & Cybernetics 1983;SMC-13(2):231–235.
- Sakha, S.. Determinants of risk aversion over time: Experimental evidence from rural thailand. Journal of Behavioral and Experimental Economics 2019;80:184 – 198. URL: <http://www.sciencedirect.com/science/article/pii/S2214804318301204>. doi:<https://doi.org/10.1016/j.socec.2019.03.008>.
- Samitas, A., Kampouris, E., Kenourgios, D.. Machine learning as an early warning system to predict financial crisis. International Review of Financial Analysis 2020;71:101507. URL: <http://www.sciencedirect.com/science/article/pii/S1057521920301514>. doi:<https://doi.org/10.1016/j.irfa.2020.101507>.
- Schiller, R.. Irrational Exuberance. Wiley Online Library, 2000.
- Sevim, C., Oztekin, A., Bali, O., Gumus, S., Guresen, E.. Developing an early warning system to predict currency crises. European Journal of Operational Research 2014;237(3):1095–1104.
- Sornette, D.. Dragon-kings, black swans and the prediction of crises. Swiss Finance Institute, Swiss Finance Institute Research Paper Series 2009;2. doi:10.2139/ssrn.1596032.
- Tanaka, K., Kinkyo, T., Hamori, S.. Random forests-based early warning system for bank failures. Economics Letters 2016;148:118 – 121. URL: <http://www.sciencedirect.com/science/article/pii/S0165176516303834>. doi:<https://doi.org/10.1016/j.econlet.2016.09.024>.
- Wang, P., Zong, L.. Contagion effects and risk transmission channels in the housing, stock, interest rate and currency markets: An empirical study in china and the u.s. (accepted). North American Journal of Economics and Finance 2019;.
- Wang, P., Zong, L., Ma, Y.. An integrated early warning system for stock market turbulence. Expert Systems with Applications 2020a;153:113463. URL: <http://www.sciencedirect.com/science/article/pii/S0957417420302876>. doi:<https://doi.org/10.1016/j.eswa.2020.113463>.
- Wang, P., Zong, L., Yang, Y.. Predicting chinese bond market turbulences:attention-bilstm based early warning system (2020 bde conference paper). ACM; 2020b. .
- Weszka, J.S.. A survey of threshold selection techniques. Computer Graphics & Image Processing 1978;7(2):259–265.
- Yoon, W., Park, K.. A study on the market instability index and risk warning levels in early warning system for economic crisis. Digital Signal Processing 2014;29:35 – 44. URL: <http://www.sciencedirect.com/science/article/pii/S1051200413002169>. doi:<https://doi.org/10.1016/j.dsp.2013.09.011>.
- Yu, L., Wang, S., Lai, K.K., Wen, F.. A multiscale neural network learning paradigm for financial crisis forecasting. Neurocomputing 2010;73(4-6):716–725.

Appendix I

The table is being processed and will be pasted later...

Appendix II

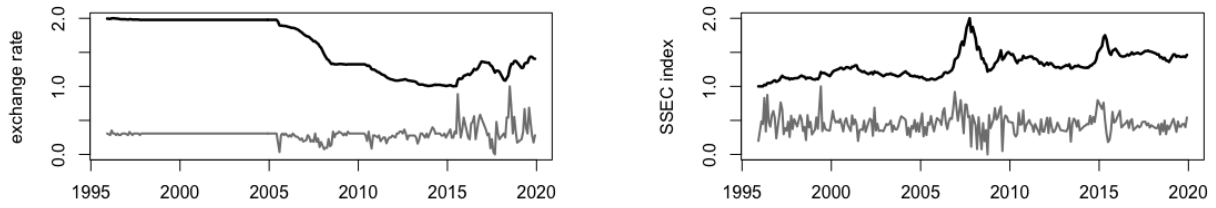

(a) Exchange rate and SSEC index dynamics.

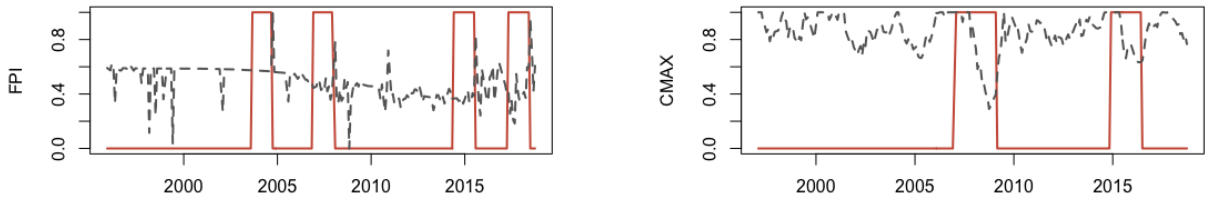

(b) FPI and CMAX identified crises.

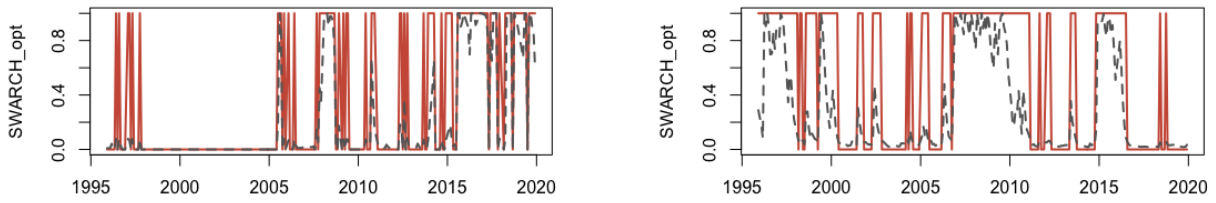

(c) $SWARCH_{opt}$ identified crises.

Figure 7: Visualized TQI and $SWARCH_{opt}$ identified crises on full samples for monthly data. (a) plots the exchange rate and SSEC index including their change return dynamics (under the price index). The grey dotted lines in (b) label the normalized FPI index and CMAX index and that in (c) label the filtering probability value extracted from AR(1)-SWARCH(2,1). Red solid lines represent the identified crises.