

# Replica Analysis of the Linear Model with Markov or Hidden Markov Signal Priors

Lan V. Truong

## Abstract

This paper estimates free energy, average mutual information, and minimum mean square error (MMSE) of a linear model under two assumptions: (1) the source is generated by a Markov chain, (2) the source is generated via a hidden Markov model. Our estimates are based on the replica method in statistical physics. We show that under the posterior mean estimator, the linear model with Markov sources or hidden Markov sources is decoupled into single-input AWGN channels with state information available at both encoder and decoder where the state distribution follows the left Perron-Frobenius eigenvector with unit Manhattan norm of the stochastic matrix of Markov chains. Numerical results show that the MMSEs obtained via the replica method are good lower bounds to the mean square errors (MSEs) achieved by some well-known approximate message passing algorithms in the research literature.

## I. INTRODUCTION

In the canonical compressed sensing problem, the primary goal is to reconstruct an  $n$ -dimensional vector  $\mathbf{X} = (X_1, X_2, \dots, X_n)$  with independent and identical prior from an  $m$ -dimensional vector of noisy linear observations  $\mathbf{Y} = (Y_1, Y_2, \dots, Y_m)$  of the form  $Y_k = \langle \Phi_k, \mathbf{X} \rangle + W_k, k = 1, 2, \dots, m$ , where  $\{\Phi_k\}$  is a sequence of  $n$ -dimensional measurement vectors,  $\{W_k\}$  is a sequence of standard Gaussian random variables, and  $\langle \cdot, \cdot \rangle$  denotes the Euclidean inner product between vectors. In this paper, under the assumption that  $\mathbf{X}$  has a Markov or hidden Markov prior, we wish to estimate the asymptotic mutual information  $\lim_{n \rightarrow \infty} \frac{1}{n} I(\mathbf{X}; \mathbf{Y})$  and the MMSE  $\lim_{n \rightarrow \infty} \frac{1}{n} \mathbb{E}[\|\mathbf{X} - \mathbb{E}[\mathbf{X} | \mathbf{Y}, \Phi]\|^2]$ . Our estimates are based on the replica method which was developed originally to study mean field approximations in spin glasses [1]. Although this method lacks of rigorous mathematical proof in some particular parts, it has been widely accepted as an analytic tool and utilized to investigate a variety of problems in applied mathematics, information processing, and coding [2].

L. V Truong is with the Department of Engineering, University of Cambridge. Emails: lt407@cam.ac.uk.

### A. Related Work

The use of the replica method for studying multiuser estimators goes back to [3] where Tanaka determined the asymptotic bit error rate of Marginal-Posterior-Mode (MPM) estimators by employing the replica method. The study demonstrated interesting large-system properties of multiuser estimators. As a result, the statistical physics approach received more attention in the context of multiuser systems [4], [5] with a subsequent work focusing on the compressed sensing directly [6]–[11]. Guo and Verdú [4] studied the same CDMA detection problem as [3] but under more general (arbitrary) input distributions. They assumed that a generic posterior mean estimator is applied before single-user decoding. The generic detector can be particularized to the matched filter, decorrelator, linear minimum mean-square error (MMSE) detector, the jointly or the individual optimal detector, and others. It is found that the detection output for each user, although in general asymptotically non-Gaussian conditioned on the transmitted symbol, converges as the number of users go to infinity to a deterministic function of a “hidden” Gaussian statistic independent of the interferers. Thus, the multi-user channel can be decoupled.

The results of replica method have been rigorously in a number of settings in compressed sensing. One example is given by message passing on matrices with special structure, such as sparsity [12]–[14] or spatial coupling [15]–[17]. In [8], Rangan et al. studied the asymptotic performance of a class of Maximize-A-Posterior (MAP) estimators. Using standard large deviation techniques, the authors represented the MAP estimator as the limit of an indexed MMSE estimator’s sequence. Consequently, they determined the estimator’s asymptotics employing the results from [4] and justified the decoupling property of MAP estimators under Replica Symmetry (RS) assumption for an i.i.d. measurement matrix  $\Phi$ . The asymptotic performance for the MAP estimator where the RS assumption does not hold but satisfies some looser symmetric assumptions, called Replica Symmetry Breaking (RSB) is considered in [2]. Under the RSB assumption with  $b$  steps of breaking (bRSB), the equivalent noisy single-user channel is given in form of an input term added by an impairment term. The impairment term, moreover, is expressed as a sum of an independent Gaussian random variable and  $b$  correlated non-Gaussian interference terms.

Recently, there have been some works which aim to close the gap between mathematically rigorous proof and results from the replica method. Reeves and Pfister considered the fundamental limit of compressed sensing for i.i.d. signal distributions and i.i.d. Gaussian measurement matrices [18]. Under some mild technical conditions, their results show that the limiting mutual information and Minimum Mean Square Error (MMSE) are equal to the values predicted by the replica method. Their proof techniques are based on establishing relationships between mutual information and MMSE at finite  $n, m$  such as [19], and extending obtained results in large system limits. In [20], Barbier et al. showed that

the results for Generalized Linear Models (GLM) and i.i.d. sources stemming from the replica method are indeed correct and imply the optimal value of both estimation and generalization error. The proof is based on the adaptive interpolation method [21] which is an extension of interpolation method developed by Guerra and Toninelli [22] in the context of spin glasses, with an adaptive interpolation path. More specifically, this scheme interpolates between the original problem and the solution via replica method in small steps, each step involving its own set of trial parameters and Gaussian mean-fields in the spirit of Guerra and Toninelli. We are then able to choose the set of trial parameters in various ways so that the upper and lower bounds are eventually matched.

In all above research literature, the authors assume that the source is independently and identically distributed (i.i.d.). In many practical applications, samples of input data may be dependent on each other, e.g., Markov chains or hidden Markov models. To the best of our knowledge, there exists no analytic result which was developed based on replica-related methods for these models. The adaptive interpolation method looks hard to apply for the linear model with Markov sources or hidden Markov sources since it requires that  $X_1, X_2, \dots, X_n$  are i.i.d. (or at least i.i.d. block-by-block) to guarantee a fixed interpolating free energy at the final  $(k, t)$ -interpolation model for each finite value of  $n$  [21]. However, there were some existing works related to Mean Square Errors (MSE) achieved by Approximate Message Passing algorithms (AMP) for the linear model with Markov or hidden Markov sources [23]–[25]. AMP is initially proposed for sparse signal recovery and compressed sensing [26]–[28]. AMP algorithms achieve state-of-the-art performance for several high-dimensional statistical estimation problems, including compressed sensing and low-rank matrix estimation [29], [30].

### B. Main Contributions

In this paper, based on the same replica assumptions as [4], we establish free energy, mutual information, and MMSE for the linear model with Markov or hidden Markov sources. When limiting to the linear model with i.i.d. sources as case, we recover Guo and Verdú's results [4], which extends Tanaka work [3] to more general alphabets. More specially, our main contributions are as follows:

- Using the replica method, we estimate the free energy, the normalized mutual information in the large system limit for two models: linear model with Markov sources and linear model with hidden Markov sources (cf. Theorem 18 and Theorem 21).
- Using the replica method, we characterize MMSEs in the large system limit for two estimation problems (cf. Theorem 18 and Theorem 21). We show that under the posterior mean estimator, the linear model with Markov sources or hidden Markov sources is decoupled into single-input AWGN channels with state information available at both encoder and decoder where the state distribution

follows the left Perron-Frobenius eigenvector with unit Manhattan norm of the stochastic matrix of Markov chains<sup>1</sup>.

- We show that replica predictions for Markov and hidden Markov sources are good lower bounds on the MMSEs by comparing replica predictions with MSEs achieved by some well-known AMP algorithms or LMMSE (cf. Section IV). Especially, the replica prediction (MMSE) for the linear model with hidden Markov sources is very close to the MSE of the Turbo AMP algorithm in [23] for some simulation cases.

Compared with the linear model with i.i.d. sources [4], we need to deal with some new technical challenges as follows:

- Solving the optimization problem associated with the linear model with Markov or hidden Markov sources (cf. [4, Eq. (107)]) requires an estimation of the derivative of Perron-Frobenius eigenvalue of non-negative matrices. In the following Lemma 8, we develop a new technique to estimate this derivative in the large system limit.
- It is quite challenging to compare our replica predictions with AMP algorithms for the linear model with Markov or hidden Markov prior since the optimal AMPs are sometimes not known in the existing research literature. In Section IV, we have to develop some new approximate message passing algorithms for this comparison purpose such as an AMP with forward-backward denoiser (AMPFB).

### C. Paper Organization

The problem setting is placed in Section II, where we introduce the system model, posterior mean estimation, free energy and replica method in statistical physics. We also introduce some new concepts such as single-symbol Posterior Mean Estimation (PME) channel with state information, free energy functions, and other related notations in this section. Our main results are stated and proved in Section III. We apply our main results to estimate free energy, mutual information, and MMSE for some specific Markov chains or hidden Markov models in Section IV, where we also compare our obtained MMSEs with achievable MSEs by some well-known AMP algorithms in research literature. In Appendix A, we introduce some related results on large deviations and develop new ones for specific applications in this paper. Appendix B begins with some results on Perron-Frobenius eigenvalues, and ends with an estimation of the derivative of the Perron-Frobenius eigenvalue for a Markov chain formed by covariance matrices.

<sup>1</sup>For any irreducible Markov process  $\{Z_n\}_{n=1}^{\infty}$ , the left Perron-Frobenius eigenvector with unit Manhattan norm is the stationary distribution of this Markov process, and the Perron-Frobenius eigenvalue is equal to 1 [31].

The proof of joint moments in Section III is placed in Appendix C since the proof technique is similar to the proof of another theorem in Section III.

#### D. Notation

Use  $[n]$  to denote the set  $\{1, \dots, n\}$ . Random vectors and matrices are in bold letters. Expectations with respect to “quenched” random variables (i.e., the variables that are fixed by the realization of the problem) are denoted by  $\mathbb{E}$  and those with respect to “annealed” random variables (i.e., dynamical variables) are denoted by Gibbs bracket  $\langle - \rangle$  possibly with appropriate subscripts. This choice follows the standards of statistical physics.

As standard literature, we define  $x^n = (x_1, x_2, \dots, x_n)^T$  to denote a vector of length  $n$ . However, if the dimension of a vector  $x$  is clear from context, we omit it for simplicity. Define two loss functions  $l_1 : \mathbb{R} \times \mathbb{R} \rightarrow \mathbb{R}$  and  $l_2 : \mathbb{R} \times \mathbb{R} \rightarrow \mathbb{R}$  as  $l_1(x, y) = |x - y|$  and  $l_2(x, y) = (x - y)^2$ . Let  $\log x := \log_2 x$  and  $\ln x$  be the natural logarithm of  $x$  for all  $x \in \mathbb{R}^+$ . Manhattan and Euclidean norms of a vector  $x \in \mathbb{R}^n$  are defined as

$$\|x\|_1 := \sum_{i=1}^n |x_i|, \quad (1)$$

$$\|x\|_2 := \sqrt{\sum_{i=1}^n |x_i|^2}, \quad (2)$$

respectively.

The moment generating function of a random vector  $\mathbf{X} \in \mathbb{R}^n$  is defined as  $\mathcal{M}(\lambda) := \mathbb{E}[\exp(\lambda^T \mathbf{X})]$  for all  $\lambda \in \mathbb{R}^n$ . Let  $\mathcal{M}(\tilde{Q}) := \mathbb{E}[\exp(\text{tr}(\tilde{Q}\mathbf{Q}))]$  be the moment generating function of a random matrix  $\mathbf{Q} \in \mathbb{R}^{n \times n}$  for all matrix  $\tilde{Q} \in \mathbb{R}^{n \times n}$ .

Denote by

$$\mathcal{Q} := \left\{ sxx^T \text{ for some } (x, s) \in \mathcal{X}^{\nu+1} \times \mathcal{S} \right\}. \quad (3)$$

For simplicity of presentation, we enumerate all matrices in  $\mathcal{Q}$  as  $\bar{Q}_0, \bar{Q}_1, \dots, \bar{Q}_M$  where  $M := |\mathcal{Q}| - 1$ .

## II. PROBLEM SETTING

We consider the linear model

$$\mathbf{Y} = \Phi \mathbf{X} + \mathbf{W} = \mathbf{A} \mathbf{S}^{1/2} \mathbf{X} + \mathbf{W}. \quad (4)$$

Here  $\mathbf{Y} \in \mathbb{R}^m$  is a vector of observations,  $\mathbf{X} \in \mathbb{R}^n$  is the signal vector,  $\mathbf{A} \in \mathbb{R}^{m \times n}$  is a measurement matrix,  $\mathbf{S}$  is diagonal matrix of positive scale factors:

$$\mathbf{S} = \text{diag}(S_1, S_2, \dots, S_n), \quad S_j \in \mathbb{R}^+, \quad (5)$$

and  $\mathbf{W} \in \mathbb{R}^m$  is a noise vector. We consider a sequence of problems indexed by  $n$ , and make the following assumptions on the model. These assumptions are identical to those in earlier works [4], [8] except for the signal prior, which we allow to be Markov or hidden Markov in contrast to the i.i.d. priors considered in earlier works.

- 1) We assume that the number of measurements  $m$  scales linearly with  $n$ , and  $\lim_{n \rightarrow \infty} \frac{n}{m} = \beta$ , for some  $\beta > 0$ .
- 2) The elements  $\{A_{ij}\}_{i \in [m], j \in [n]}$  of the matrix  $\mathbf{A}$  are i.i.d. and distributed as  $A_{ij} \stackrel{d}{=} \frac{1}{\sqrt{m}}A$ , where  $A$  is a random variable with zero mean, unit variance and all moments finite.
- 3) The scale factors  $(S_1, \dots, S_n)$  are i.i.d. according to  $P_S$ , which is supported on a set  $\mathcal{S} \subset \mathbb{R}^+$ . The scale factors  $(S_1, \dots, S_n)$  are independent of  $\mathbf{A}$ ,  $\mathbf{X}$ , and  $\mathbf{W}$ .
- 4) The noise vector  $\mathbf{W}$  is standard normal, i.e.,  $W_j \sim_{\text{i.i.d.}} \mathcal{N}(0, 1)$  for  $j \in [m]$ .
- 5) *Signal prior*: We assume that the components of  $\mathbf{X}$  take values in a finite set  $\mathcal{X}$ , and are distributed according to either a Markov or a hidden Markov prior.

- *Markov chain prior*: This model assumes that

$$\mathbb{P}(\mathbf{X} = (x_1, \dots, x_n)) = p(x_1)\pi(x_1, x_2) \cdots \pi(x_{n-1}, x_n) \quad (6)$$

for some initial probability distribution  $p(\cdot)$  on  $\mathcal{X}$ , where  $\pi(\cdot, \cdot)$  is the transition probability of a time-homogeneous, irreducible Markov chain on  $\mathcal{X}$ .

- *Hidden Markov prior*: The second model assumes that  $\{X_n\}_{n=1}^\infty$  are generated by a Hidden Markov Model (HMM), with hidden states  $\{\Upsilon_n\}_{n=1}^\infty$  on a finite set  $\mathcal{H}_\Upsilon$ . That is,  $\mathbb{P}(\Upsilon = (v_1, \dots, v_n)) = p_\Upsilon(v_1)\pi_\Upsilon(v_1, v_2) \cdots \pi_\Upsilon(v_{n-1}, v_n)$  for some initial probability distribution  $p_\Upsilon(\cdot)$  on  $\mathcal{H}_\Upsilon$ , where  $\pi_\Upsilon(\cdot, \cdot)$  is the transition probability of a time-homogeneous, irreducible Markov chain on  $\mathcal{H}_\Upsilon$ . Then,

$$\mathbb{P}(X_i = x_i \mid \Upsilon_1 = v_1, \dots, \Upsilon_i = v_i) = p_{X|\Upsilon}(x_i \mid v_i), \quad i \in [n],$$

for some stationary emission probability  $p_{X|\Upsilon}(\cdot|\cdot)$  on  $\mathcal{S}_\Upsilon \times \mathcal{X}$ .

For both models, we will denote the joint pmf of the signal by  $p(x_1, \dots, x_n)$ . For simplicity of analysis, the state space of the Markov chain is assumed to be finite in both cases. We expect the results to hold for Markov chains on countable state spaces and Polish spaces on  $\mathbb{R}$ .

#### A. Posterior Mean Estimation

The problem setting described above induces a posterior distribution  $p_{\mathbf{X}|\mathbf{Y}, \Phi}$ , given by

$$p_{\mathbf{X}|\mathbf{Y}, \Phi}(\mathbf{x} \mid \mathbf{y}, \phi) = \frac{p_{\mathbf{Y}|\mathbf{X}, \Phi}(\mathbf{y} \mid \mathbf{x}, \phi)p_{\mathbf{X}}(\mathbf{x})}{p_{\mathbf{Y}|\Phi}(\mathbf{y} \mid \phi)}, \quad (7)$$

where

$$p_{\mathbf{Y}|\mathbf{X},\Phi}(\mathbf{y} | \mathbf{x}, \Phi) = (2\pi)^{-m/2} \exp \left[ -\frac{\|\mathbf{y} - \Phi\mathbf{x}\|^2}{2} \right], \quad (8)$$

and

$$p_{\mathbf{Y}|\Phi}(\mathbf{y} | \phi) = \mathbb{E}_p[p_{\mathbf{Y}|\mathbf{X},\Phi}(\mathbf{y} | \mathbf{X}, \phi)] = \sum_{\mathbf{x}} p_{\mathbf{Y}|\mathbf{X},\Phi}(\mathbf{y} | \mathbf{x}, \phi) p_{\mathbf{X}}(\mathbf{x}).$$

The (canonical) posterior mean estimator (PME), which computes the mean value of the posterior distribution  $p_{\mathbf{X}|\mathbf{Y},\Phi}$  is given by,

$$\langle \mathbf{X} \rangle = \mathbb{E}_p[\mathbf{X} | \mathbf{Y}, \Phi]. \quad (9)$$

This estimator achieves MMSE between the estimated and the original signal.

As in Guo and Verdú [4], we consider a more general class of posterior mean estimators, based on a *postulated* posterior distribution  $q_{\mathbf{X}|\mathbf{Y},\Phi}$ , to model that scenario that the true posterior mean may be infeasible to compute or the estimator may not know the exact prior and the noise variance. The postulated posterior distribution is defined via a postulated prior and a postulated noise variance. The postulated prior  $q_{\mathbf{X}}(\mathbf{x})$  is of the form

$$q_{\mathbf{X}}(\mathbf{x}) = q(x_1) \tilde{\pi}(x_1, x_2) \cdots \tilde{\pi}(x_{n-1}, x_n) \quad (10)$$

for some initial distribution  $q(\cdot)$  on  $\mathcal{X}$ , and  $\tilde{\pi}(\cdot, \cdot)$  is the transition probability of an irreducible Markov chain on  $\mathcal{X}$ . The postulated likelihood is Gaussian with variance  $\sigma^2$ , which may not be equal to the true noise variance 1:

$$q_{\mathbf{Y}|\mathbf{X},\Phi}(\mathbf{y} | \mathbf{x}, \phi) = (2\pi)^{-m/2} \exp \left[ -\frac{\|\mathbf{y} - \Phi\mathbf{x}\|^2}{2\sigma^2} \right] \quad (11)$$

The postulated prior and noise variance induce the posterior distribution  $q_{\mathbf{X}|\mathbf{Y},\Phi}$  given by

$$q_{\mathbf{X}|\mathbf{Y},\Phi}(\mathbf{x} | \mathbf{y}, \phi) = \frac{q_{\mathbf{Y}|\mathbf{X},\Phi}(\mathbf{y} | \mathbf{x}, \phi) q_{\mathbf{X}}(\mathbf{x})}{q_{\mathbf{Y}|\Phi}(\mathbf{y} | \phi)}, \quad (12)$$

where

$$q_{\mathbf{Y}|\Phi}(\mathbf{y} | \phi) = \mathbb{E}_q[q_{\mathbf{Y}|\mathbf{X},\Phi}(\mathbf{y} | \mathbf{x}, \phi) | \Phi = \phi] = \sum_{\mathbf{x}} q_{\mathbf{X}}(\mathbf{x}) q_{\mathbf{Y}|\mathbf{X},\Phi}(\mathbf{y} | \mathbf{x}, \phi). \quad (13)$$

The posterior mean estimator computed using (12), which we call the ‘generalized PME’, is denoted by

$$\langle \mathbf{X} \rangle_q = \mathbb{E}_q[\mathbf{X} | \mathbf{Y}, \Phi]. \quad (14)$$

As described in [4], with suitable choices of the postulated distribution, the generalized PME can recover various commonly used sub-optimal estimators such as the linear MMSE estimator and the matched filter. The postulated prior can also be used to model estimators that ignore the memory in the signal  $\mathbf{X}$ , e.g., estimator based on an i.i.d. prior.

In the remainder of the paper, we will use the subscript  $p$  to denote expectations computed using the true prior/posterior, and  $q$  to denote expectations using the postulated prior/posterior.

### B. Free Energy and Replica Method

Let

$$Z(\mathbf{Y}, \Phi) := q_{\mathbf{Y}|\Phi}(\mathbf{Y}|\Phi). \quad (15)$$

The free energy of the model in (4) is defined as

$$\mathcal{F}_n := -\frac{1}{n} \log Z(\mathbf{Y}, \Phi). \quad (16)$$

The expectation of the free energy (with respect to  $q_{\mathbf{Y}|\Phi}(\mathbf{Y}|\Phi)$ ) is equal to the conditional entropy of the observation  $\frac{1}{n}H_q(\mathbf{Y}|\Phi)$  as well as (up to an additive constant) to the mutual information density between the signal and the observations  $\frac{1}{n}I_q(\mathbf{X}, \mathbf{Y})$ .

The asymptotic free energy is the limit of the sequence  $\{F_n\}_{n=1}^{\infty}$ , i.e.,

$$\mathcal{F}_q := \lim_{n \rightarrow \infty} \mathcal{F}_n. \quad (17)$$

In general, it is very challenging to prove the existence and estimate the limit in (17). Replica method, originally developed in statistical physics, is usually used to evaluate this limit [3], [4] because the linear model is similar to the thermodynamic system. For this model, replica method is based on the following assumptions (A) and facts (F):

- (A1) The free energy  $\mathcal{F}_n$  has the self-averaging property as  $n \rightarrow \infty$ . This means that

$$\mathcal{F} := \lim_{n \rightarrow \infty} \mathbb{E}[\mathcal{F}_n]. \quad (18)$$

The self-averaging property essentially assumes that the variations of  $Z(\mathbf{Y}, \Phi)$  due to the randomness of the measurement matrix  $\Phi$  vanish in the limit  $n \rightarrow \infty$ . Although a large number of statistical physics quantities exhibit such self-averaging, the self-averaging of the relevant quantities for the general PME (PMMSE) and Postulated MAP (PMAP) analyses has not been rigorously established [8]. For the purpose of estimating the average mutual information of the Markov model only, we don't need to make use of this assumption.

- (F1) The following identity holds:

$$\mathbb{E}[\log Z(\mathbf{Y}, \Phi)] = \lim_{\nu \rightarrow 0} \frac{\partial}{\partial \nu} \log \mathbb{E}[Z^\nu(\mathbf{Y}, \Phi)]. \quad (19)$$

- (A2) Estimation of  $\mathbb{E}[Z(\mathbf{Y}, \Phi)^\nu]$  for a positive real number  $\nu$  in the neighbourhood of 0 can be done by two steps: (1) Estimate  $\mathbb{E}[Z^\nu(\mathbf{Y}, \Phi)]$  for a general positive integer  $\nu$  (2) Take the limit of the obtained result as  $\nu \rightarrow 0$ . This is called ‘‘replica trick’’ in statistical physics.



- (F2) For any positive integer  $\nu$  and a realization  $(\mathbf{y}, \Phi)$  of  $(\mathbf{Y}, \Phi)$ , the quantity  $Z^\nu(\mathbf{y}, \Phi)$  can be written as

$$Z^\nu(\mathbf{y}, \Phi) = \left\{ q_{\mathbf{Y}|\Phi}(\mathbf{y}|\Phi) \right\}^\nu \quad (20)$$

$$= \left\{ \mathbb{E}_{q_{\mathbf{X}}} \left[ q_{\mathbf{Y}|\mathbf{X}, \Phi}(\mathbf{y}|\mathbf{X}, \Phi) \right] \right\}^\nu \quad (21)$$

$$= \mathbb{E}_{q_{\mathbf{X}}} \left\{ \prod_{a=1}^{\nu} q_{\mathbf{Y}|\mathbf{X}, \Phi}(\mathbf{y}|\mathbf{X}^{(a)}, \Phi) \right\}. \quad (22)$$

where the last expectation is taken over replicated vectors  $\mathbf{X}^{(a)}$ ,  $a = 1, 2, \dots, \nu$  which are independent copies of a random vector with postulated distribution  $q_{\mathbf{X}}$ .

- (A3) The order of limit  $n \rightarrow \infty$  and  $\nu \rightarrow 0$  can be interchanged. Mathematically, under some conditions such as Theorem Moore-Osgood [32], the interchange between limits work. This theorem is used in [33] for a similar purpose.
- (A4) Usually, the free energy can be expressed an optimal value of an optimization problem over the space of covariance matrices of replica samples, say  $\mathcal{Q}$ . This optimization is general difficult to perform. To overcome this, the replica method also makes an additional assumption that the optimizer  $Q^*$  is symmetric with respect to permutations of  $\nu$  replica indices. This assumption is called Replica Symmetry (RS) in statistical physics. See Definition 11 for our assumption about RS in this paper.

### III. MAIN RESULTS

#### A. Results for Markov Priors

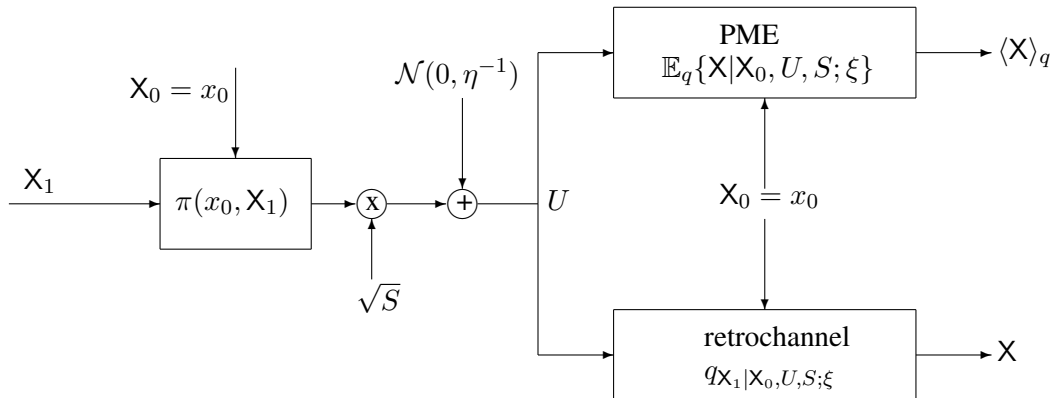

Fig. 1. The equivalent single-symbol Gaussian channel with state available at both encoder and decoder, PME, and retrochannel.

Our results on the free energy and MMSE will be stated in terms of a *single-symbol* channel, similar to the equivalent single-user Gaussian channel which is obtained via decoupling as in [4, Section D]. Given an initial state  $X_0 = x_0$ , the input-output relationship of this single-symbol channel is given by

$$U = \sqrt{S} X_1 + \frac{1}{\sqrt{\eta}} W, \quad (23)$$

where the input  $X_1 \sim p_{X_1|X_0}(\cdot|x_0) := \pi(x_0, \cdot)$ ,  $S \sim P_S$  is the input Signal-to-Noise Ratio (SNR) which is independent  $X_0$  and  $X_1$ ,  $W \sim \mathcal{N}(0, 1)$  the noise independent of  $X_0$  and  $X_1$ , and  $\eta > 0$  the inverse noise variance. The conditional distribution associated with the channel is

$$p_{U|X_0, X_1, S; \eta}(u | x_0, x_1, s; \eta) = \sqrt{\frac{\eta}{2\pi}} \exp \left[ -\frac{\eta}{2} (u - \sqrt{s}x_1)^2 \right]. \quad (24)$$

Let  $q_{U|X_0, X_1, S; \xi}$  represent Gaussian channel with state  $X_0$  available at both encoder and decoder akin to (23), the only difference being that the inverse noise variance is  $\xi$  instead of  $\eta$

$$q_{U|X_0, X_1, S; \xi}(u | x_0, x_1, s; \xi, x_0) = \sqrt{\frac{\xi}{2\pi}} \exp \left[ -\frac{\xi}{2} (u - \sqrt{s}x_1)^2 \right]. \quad (25)$$

Similar to that in the vector channel setting, by postulating the input distribution to be  $q_{X_1|X_0}(\cdot|x_0) = \tilde{\pi}(x_0, \cdot)$ , a posterior probability distribution  $q_{X_1|X_0, U, S; \xi}$  is induced by  $q_{X_1|X_0}$  and  $q_{U|X_0, X_1, S; \xi}$  using the Bayes rule, i.e.,

$$q_{X_1|X_0, S, U; \xi}(x | x_0, s, u; \xi) = \frac{q_{X_1|X_0}(x | x_0) q_{U|X_0, X_1, S; \xi}(u | x_0, x_1, s; \xi)}{q_{U|X_0, S; \xi}(u | x_0, s; \xi)}. \quad (26)$$

This induces a single-use retrochannel with random transformation  $q_{X_1|X_0, U, S; \xi}$ , which outputs a random variable  $X$  given the channel output  $U$  and the channel state  $X_0$  (Fig. 1). A (generalized) single-symbol PME with state available  $X_0 = x_0$  is defined naturally as (cf. (14))

$$\langle X | X_0 = x_0 \rangle_q = \mathbb{E}_q [X | X_0 = x_0, U, S; \xi], \quad (27)$$

where the expectation is taken over the (conditionally) postulated distribution in (26).

The single-symbol PME (27) is merely a decision function applied to the Gaussian channel output with state  $X_0 = x_0$  available at both encoder and decoder (or input and output), which can expressed explicitly as

$$\mathbb{E}_q [X | U, X_0 = x_0, S; \xi] = \frac{q_1(U, x_0, S; \xi)}{q_0(U, x_0, S; \xi)}, \quad (28)$$

where

$$q_0(u, x_0, S; \xi) := q_{U|X_0, S; \xi}(u | x_0, s; \xi) = \mathbb{E}_{\tilde{\pi}(x_0, \cdot)} \left[ q_{U|X_0, X_1, S; \xi}(u | x_0, X, S; \xi) \middle| S \right], \quad (29)$$

$$q_1(z, x_0, S; \xi) = \mathbb{E}_{\tilde{\pi}(x_0, \cdot)} \left[ X q_{U|X_0, X_1, S; \xi}(z | x_0, X, S; \xi) \middle| S \right]. \quad (30)$$

The probability law of the (composite) single-symbol channel depicted by Fig. 1 is determined by  $S$  and two parameters  $\eta$  and  $\xi$  given state  $\mathsf{X}_0$ . We define the conditional mean-square error of the PME as

$$\mathcal{E}(S; \eta, \xi | x_0) = \mathbb{E}[(\mathsf{X}_1 - \langle \mathsf{X} \rangle_q)^2 | \mathsf{X}_0 = x_0, S; \eta, \xi] \quad (31)$$

and also define the conditional variance of the retrochannel as

$$\mathcal{V}(S; \eta, \xi | x_0) = \mathbb{E}[(\mathsf{X}_1 - \langle \mathsf{X} \rangle_q)^2 | \mathsf{X}_0 = x_0, S; \eta, \xi]. \quad (32)$$

Let  $\lambda^{(\pi)}$  be the left Perron-Frobenius with unit Manhattan norm<sup>2</sup> of  $P_\pi = \{\pi(x, y)\}_{x \in \mathcal{X}, y \in \mathcal{X}}$ , which is the stochastic matrix of the Markov chain  $\{\mathsf{X}_n\}_{n=1}^\infty$ , and let  $\lambda_{x_0}^{(\pi)}$  be the component of  $\lambda^{(\pi)}$  associated with the  $x_0$ -th row of  $P_\pi$ . Define

$$\mathcal{G} := \sum_{x_0 \in \mathcal{X}} \lambda_{x_0}^{(\pi)} \mathcal{G}(x_0), \quad (33)$$

where

$$\begin{aligned} \mathcal{G}(x_0) := & -\mathbb{E} \left\{ \int p_{U|\mathsf{X}_0, S; \eta}(u | x_0, S; \eta) \log q_{U|\mathsf{X}_0, S; \xi}(u | x_0, S; \xi) du \right\} \\ & + \frac{1}{2\beta} \left[ (\xi - 1) \log e - \log \xi \right] - \frac{1}{2} \log \frac{2\pi}{\xi} - \frac{\xi}{2\eta} \log e \\ & + \frac{\sigma^2 \xi (\eta - \xi)}{2\beta \eta} \log e + \frac{1}{2\beta} \log(2\pi) + \frac{\xi}{2\beta \eta} \log e, \end{aligned} \quad (34)$$

and  $\eta$  and  $\xi$  is the solution of the following equation system

$$\eta^{-1} = 1 + \beta \sum_{x_0 \in \mathcal{X}} \lambda_{x_0}^{(\pi)} \mathbb{E}[S\mathcal{E}(S; \eta, \xi | x_0)], \quad (35)$$

$$\xi^{-1} = \sigma^2 + \beta \sum_{x_0 \in \mathcal{X}} \lambda_{x_0}^{(\pi)} \mathbb{E}[S\mathcal{V}(S; \eta, \xi | x_0)] \quad (36)$$

such that they minimize  $\mathcal{G}$ . Observe that for the case  $\mathsf{X}_0, \mathsf{X}_1, \dots, \mathsf{X}_n$  are i.i.d.,  $\mathcal{G}(x_0)$  does not depend on  $x_0$  and is defined in [4, Eq. (22)].

**Claim 1.** *The free energy of the linear model with Markov sources in Section II satisfies*

$$\mathcal{F}_q = \mathcal{G}, \quad (37)$$

where  $\mathcal{G}$  is defined in (33). In addition, the average mutual information of this model satisfies:

$$C = \lim_{n \rightarrow \infty} \frac{1}{n} I(\mathbf{X}^n; \mathbf{Y}^m) = \mathcal{F}_q \Big|_{\sigma=1} - \frac{1}{2\beta}. \quad (38)$$

<sup>2</sup>Since there exists a unique left Perron-Frobenius eigenvector up to a positive scaling factor [31],  $\lambda^{(\pi)}$  exists uniquely.

**Claim 2.** Recall the definition of  $\{\lambda_{x_0}^{(\pi)}\}_{x_0 \in \mathcal{X}}$  in Section III-A. Assume that the generalized PME defined in (14) is used for estimation. Then, for all  $k \in \{1, 2, \dots, n\}$ , the joint moments satisfy:

$$\lim_{n \rightarrow \infty} \mathbb{E} \left[ X_k^{i_0} \tilde{X}_k^{j_0} \langle X_k \rangle_q^{l_0} \right] = \sum_{x_0 \in \mathcal{X}} \lambda_{x_0}^{(\pi)} \mathbb{E} \left[ X_1^{i_0} X^{j_0} \langle X | X_0 \rangle_q^{l_0} | X_0 = x_0 \right] \quad \forall i_0, j_0, l_0 \in \mathbb{Z}_+, \quad (39)$$

where  $(X_1, X, \langle X | X_0 = x_0 \rangle_q)$  is the input and outputs defined in the (composite) single-symbol PME channel in Fig. 1, and  $(X_k, \tilde{X}_k, \langle X_k \rangle)$  is the  $k$ -th symbol in the vector  $\mathbf{X} \in \mathcal{X}^n$ , the  $k$ -th output of the vector retrochannel defined in (12), and its corresponding estimated symbol by using the PME estimate in (14).

In addition, the average MMSE satisfies:

$$\frac{1}{n} \mathbb{E} [\|\mathbf{X} - \langle \mathbf{X} \rangle\|_2^2] = \mathbb{E}[X_1^2] - \sum_{x_0 \in \mathcal{X}} \lambda_{x_0}^{(\pi)} \mathbb{E}[\langle X_1 | X_0 \rangle^2 | X_0 = x_0], \quad (40)$$

where  $X_1, \langle X \rangle, X_0$  are the input, output, and state in the single-symbol PME channel with available states at both encoder and decoder defined Section III-A, and  $X_1 \sim \sum_{x_0 \in \mathcal{X}} \pi(x_0, \cdot) p(x_0)$ .

### B. Results for Hidden Markov Priors

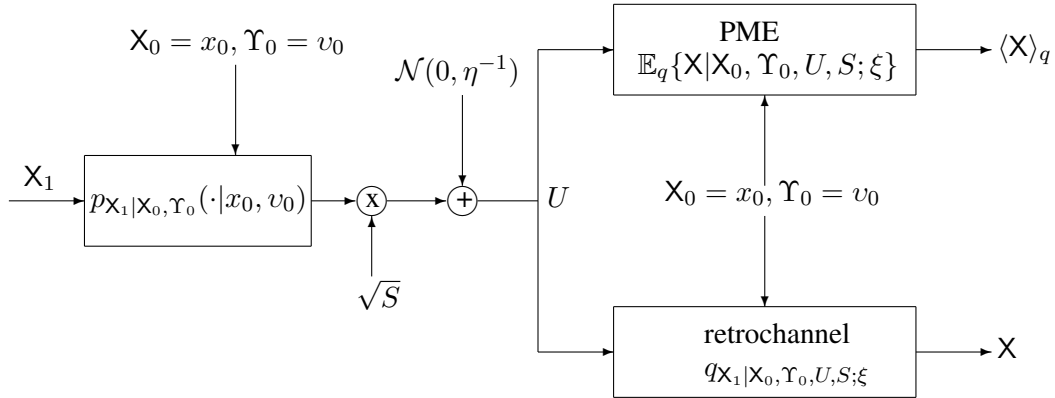

Fig. 2. The equivalent single-symbol Gaussian channel with two states available at both encoder and decoder, PME, and retrochannel.

As the previous section, for the case that  $\{X_n\}_{n=1}^\infty$  are hidden states of a Markov chain  $\{\Upsilon_n\}_{n=1}^\infty$  on the space  $\mathcal{S}_\Upsilon$ , we define a new single-symbol channel with state which is similar to the conditional PME channel defined in Section III-A. Let us consider the composition of a Gaussian channel with two states  $(X_0, \Upsilon_0) = (x_0, v_0)$  available at both encoder and decoder, a two-state PME, and a companion retrochannel in the single-symbol setting depicted in Fig. 2. The input and output are related by

$$U = \sqrt{S}X_1 + \frac{1}{\sqrt{\eta}}W, \quad (41)$$

where the input  $X_1 \sim p_{X_1|X_0, \Upsilon_0}(\cdot | x_0, v_0)$  such that

$$p_{X_1|X_0, \Upsilon_0}(x_1 | x_0, v_0) = \sum_{v_1 \in \mathcal{S}_\Upsilon} p_{X_1, \Upsilon_1|X_0, \Upsilon_0}(x_1, v_1 | x_0, v_0) \quad (42)$$

$$= \sum_{v_1 \in \mathcal{S}_\Upsilon} \pi_\Upsilon(v_0, v_1) p_{X|\Upsilon}(x_1 | v_1), \quad (43)$$

$S \sim P_S$  is the input Signal-to-Noise Ratio (SNR) which is independent  $X_0, \Upsilon_0$  and  $X_1, \Upsilon_1$ ,  $W \sim \mathcal{N}(0, 1)$  the noise independent of  $X_0, \Upsilon_0$  and  $X_1, \Upsilon_1$ , and  $\eta > 0$  the inverse noise variance. The conditional distribution associated with the channel is

$$p_{U|X_0, \Upsilon_0, X_1, S; \eta}(u | x_0, v_0, x_1, s; \eta) = \sqrt{\frac{\eta}{2\pi}} \exp \left[ -\frac{\eta}{2}(u - \sqrt{s}x_1)^2 \right]. \quad (44)$$

Let  $q_{U|X_0, \Upsilon_0, X_1, S; \xi}$  represent Gaussian channel with two states  $X_0$  and  $\Upsilon_0$  available at both encoder and decoder akin to (41), the only difference being that the inverse noise variance is  $\xi$  instead of  $\eta$

$$q_{U|X_0, \Upsilon_0, X_1, S; \xi}(u | x_0, v_0, x_1, s; \eta, x_0) = \sqrt{\frac{\xi}{2\pi}} \exp \left[ -\frac{\xi}{2}(u - \sqrt{s}x_1)^2 \right]. \quad (45)$$

Similar to that in the vector channel setting, by postulating the input distribution to be  $q_{\Upsilon_1|\Upsilon_0}(\cdot | v_0) = \tilde{\pi}_\Upsilon(v_0, \cdot)$ , a posterior probability distribution  $q_{X_1|X_0, \Upsilon_0, U, S; \xi}$  is induced by  $q_{X_1|X_0, \Upsilon_0}$  and  $q_{U|X_0, \Upsilon_0, X_1, S; \xi}$  using the Bayes rule, i.e.,

$$q_{X_1|X_0, \Upsilon_0, S, U; \xi}(x | x_0, v_0, s, u; \xi) = \frac{q_{X_1|X_0, \Upsilon_0}(x | x_0, v_0) q_{U|X_0, \Upsilon_0, X_1, S; \xi}(u | x_0, v_0, x_1, s; \xi)}{q_{U|X_0, \Upsilon_0, S; \xi}(u | x_0, v_0, s; \xi)}. \quad (46)$$

This induces a single-use retrochannel with random transformation  $q_{X_1|X_0, \Upsilon_0, U, S; \xi}$ , which outputs a random variable  $X$  given the channel output  $U$  and the channel states  $X_0, \Upsilon_0$  (Fig. 2). A (generalized) single-symbol PME with two available states  $X_0 = x_0$  and  $\Upsilon_0 = v_0$  is defined naturally as (cf. (27))

$$\langle X | X_0 = x_0, \Upsilon_0 = v_0 \rangle_q = \mathbb{E}_q[X | X_0 = x_0, \Upsilon_0 = v_0, U, S; \xi], \quad (47)$$

where the expectation is taken over the (conditionally) postulated distribution in (26).

The single-symbol PME (27) is merely a decision function applied to the Gaussian channel output with two states  $X_0 = x_0$  and  $\Upsilon_0 = v_0$  available at both encoder and decoder (or input and output), which can be expressed explicitly as

$$\mathbb{E}_q[X | U, X_0 = x_0, \Upsilon_0 = v_0, S; \xi] = \frac{q_1(U, x_0, v_0, S; \xi)}{q_0(U, x_0, v_0, S; \xi)}, \quad (48)$$

where

$$q_0(u, x_0, v_0, S; \xi) := q_{U|X_0, \Upsilon_0, S; \xi}(u | x_0, v_0, s; \xi) = \mathbb{E}[q_{U|X_0, \Upsilon_0, X_1, S; \xi}(u | x_0, v_0, X, S; \xi) | S], \quad (49)$$

$$q_1(u, x_0, v_0, S; \xi) = \mathbb{E}[X q_{U|X_0, \Upsilon_0, X_1, S; \xi}(u | x_0, v_0, X, S; \xi) | S]. \quad (50)$$

The probability law of the (composite) single-symbol channel depicted by Fig. 2 is determined by  $S$  and two parameters  $\eta$  and  $\xi$  given states  $X_0$  and  $\Upsilon_0$ . We define the conditional mean-square error of the PME as

$$\mathcal{E}(S; \eta, \xi | x_0, v_0) = \mathbb{E}[(X_1 - \langle X | X_0 = x_0, \Upsilon_0 = v_0 \rangle_q)^2 | X_0 = x_0, \Upsilon_0 = v_0, S; \eta, \xi] \quad (51)$$

and also define the conditional variance of the retrochannel as

$$\mathcal{V}(S; \eta, \xi | x_0, v_0) = \mathbb{E}[(X_1 - \langle X \rangle_q)^2 | X_0 = x_0, \Upsilon_0 = v_0, S; \eta, \xi]. \quad (52)$$

Let  $\lambda^{(\pi_r)}$  be the left Perron-Frobenius with unit Manhattan norm<sup>3</sup> of

$$\begin{aligned} P_{\pi, \mathcal{X}} &= \left\{ P_{X_1, \Upsilon_1 | X_0, \Upsilon_0}(x_1, v_1 | x_0, v_0) \right\}_{(x_0, v_0) \in \mathcal{X} \times \mathcal{S}_r, (x_1, v_1) \in \mathcal{X} \times \mathcal{S}_r}, \\ &= \left\{ \pi_r(v_0, v_1) P_{X | \Upsilon}(x_1 | v_1) \right\}_{(x_0, v_0) \in \mathcal{X} \times \mathcal{S}_r, (x_1, v_1) \in \mathcal{X} \times \mathcal{S}_r}, \end{aligned}$$

which is the stochastic matrix of the Markov chain  $\{(X_n, \Upsilon_n)\}_{n=1}^\infty$ <sup>4</sup>, and let  $\lambda_{x_0, v_0}^{(\pi)}$  be the component of  $\lambda^{(\pi)}$  associated with the  $(x_0, v_0)$ -th row of  $P_{\pi, \mathcal{X}}$ . Define

$$\tilde{G} := \sum_{(x_0, v_0) \in \mathcal{X} \times \mathcal{S}_r} \lambda_{x_0, v_0}^{(\pi_r)} \tilde{G}(x_0, v_0), \quad (53)$$

where

$$\begin{aligned} \tilde{G}(x_0, v_0) &:= -\mathbb{E} \left\{ \int p_{U | X_0, \Upsilon_0, S; \eta}(u | x_0, v_0, S; \eta) \log q_{U | X_0, \Upsilon_0, S; \xi}(u | x_0, v_0, S; \xi) du \right\} \\ &+ \frac{1}{2\beta} \left[ (\xi - 1) \log e - \log \xi \right] - \frac{1}{2} \log \frac{2\pi}{\xi} - \frac{\xi}{2\eta} \log e \\ &+ \frac{\sigma^2 \xi (\eta - \xi)}{2\beta \eta} \log e + \frac{1}{2\beta} \log(2\pi) + \frac{\xi}{2\beta \eta} \log e, \end{aligned} \quad (54)$$

and  $\eta$  and  $\xi$  is the solution of the following equation system

$$\eta^{-1} = 1 + \beta \sum_{(x_0, v_0) \in \mathcal{X} \times \mathcal{S}_r} \lambda_{x_0, v_0}^{(\pi_r)} \mathbb{E}[S\mathcal{E}(S; \eta, \xi | x_0, v_0)], \quad (55)$$

$$\xi^{-1} = \sigma^2 + \beta \sum_{(x_0, v_0) \in \mathcal{X} \times \mathcal{S}_r} \lambda_{x_0, v_0}^{(\pi_r)} \mathbb{E}[S\mathcal{V}(S; \eta, \xi | x_0, v_0)] \quad (56)$$

such that they minimize  $\tilde{G}$ .

<sup>3</sup>Since there exists a unique left Perron-Frobenius eigenvector unique up to a positive scaling factor [31], so  $\lambda^{(\pi_r)}$  exists uniquely.

<sup>4</sup>The fact that  $\{(X_n, \Upsilon_n)\}_{n=1}^\infty$  forms a Markov chain will be proved in Theorem 21.

**Claim 3.** Assume that  $\{X_n\}_{n=1}^\infty$  is the hidden states (outputs) of a hidden Markov model generated by a Markov chain  $\{\Upsilon_n\}_{n=1}^\infty$  with transition probability (function)  $\pi_\Upsilon(\cdot, \cdot)$  on some Polish space  $\mathcal{S}_\Upsilon$ , i.e.,

- $\Upsilon_n$  is a Markov process and is not directly observable.
- $\mathbb{P}(X_n \in \mathcal{A} | \Upsilon_1 = v_1, \Upsilon_2 = v_2, \dots, \Upsilon_n = v_n) = \mathbb{P}(X_n \in \mathcal{A} | \Upsilon_n = v_n) = P_{X|\Upsilon}(\mathcal{A} | v_n)$ ,

for every  $n \geq 1$ ,  $v_1, v_2, \dots, v_n$ , and an arbitrary measurable set  $\mathcal{A}$ , where  $P_{X|\Upsilon}(\cdot | \cdot)$  is some probability measure called emission probability. Then, the following holds:

- $\{X_n, \Upsilon_n\}_{n=1}^\infty$  forms a Markov chain on  $\mathcal{X} \times \mathcal{S}_\Upsilon$  with transition probability  $P_{X_1, \Upsilon_1 | X_0, \Upsilon_0}(x_1, v_1 | x_0, v_0) = P_{X|\Upsilon}(x_1 | v_1) \pi_\Upsilon(v_0, v_1)$ .
- Recall the definitions of  $\{\lambda_{x_0, v_0}^{(\pi_\Upsilon)}\}_{(x_0, v_0) \in \mathcal{X} \times \mathcal{S}_\Upsilon}$  and  $\tilde{G}$  in (54). Then, the free energy, mutual information, joint moments, the average MMSE of the linear model with hidden Markov sources in II satisfy:

$$\mathcal{F}_q = \tilde{G}, \quad (57)$$

$$C = \mathcal{F}_q \Big|_{\sigma=1} - \frac{1}{2\beta}, \quad (58)$$

$$\lim_{n \rightarrow \infty} \mathbb{E} \left[ X_k^{i_0} \tilde{X}_k^{j_0} \langle X_k \rangle_q^{l_0} \right] = \sum_{x_0, v_0 \in \mathcal{X} \times \mathcal{S}_\Upsilon} \lambda_{x_0, v_0}^{(\pi_\Upsilon)} \mathbb{E} \left[ X_1^{i_0} X_1^{j_0} \langle X \rangle_q^{l_0} | X_0 = x_0, \Upsilon_0 = v_0 \right], \forall i_0, j_0, l_0 \in \mathbb{Z}_+, \quad (59)$$

$$\lim_{n \rightarrow \infty} \frac{1}{n} \mathbb{E} [\| \mathbf{X} - \langle \mathbf{X} \rangle \|_2^2] = \mathbb{E} [X_1^2] - \sum_{x_0, v_0 \in \mathcal{X}_1 \times \mathcal{S}_\Upsilon} \lambda_{x_0, v_0}^{(\pi_\Upsilon)} \mathbb{E} [\langle X | X_0 = x_0, \Upsilon_0 = v_0 \rangle^2], \quad (60)$$

where  $(X_1, X, \langle X | X_0 = x_0, \Upsilon_0 = v_0 \rangle_q)$  is the input and outputs defined in the (composite) single-symbol PME channel in Fig. 2, and  $(X_k, \tilde{X}_k, \langle X_k \rangle)$  is the  $k$ -th symbol in the vector  $\mathbf{X} \in \mathcal{X}^n$ , the  $k$ -th output of the vector retrochannel defined in (12), and its corresponding estimated symbol by using the generalized PME estimate in (14). In addition, in (60),  $X_1 \sim \sum_{v \in \mathcal{S}_\Upsilon} P_{X|\Upsilon}(\cdot | v) \pi_\Upsilon(v_0, v)$ , where  $P_{X|\Upsilon}$  is the stationary emission probability of the hidden Markov process.

#### IV. NUMERICAL EXAMPLES AND COMPARISON WITH ALGORITHMIC PERFORMANCE

##### A. Binary-valued Markov Prior

Homogeneous Markov chain on the alphabet  $\mathcal{X} = \{-1, 1\}$  with the stochastic matrix as follows:

$$P_\pi = \begin{bmatrix} \pi(-1, -1) & \pi(-1, 1) \\ \pi(1, -1) & \pi(1, 1) \end{bmatrix} = \begin{bmatrix} 1 - \alpha & \alpha \\ \delta & 1 - \delta \end{bmatrix} \quad (61)$$

for some  $\alpha$  and  $\delta$  in  $(0, 1)$ .

1) *Free Energy and Average Mutual Information:* It is easy to see that the left Perron-Frobenius eigenvector  $\lambda^{(\pi)}$  of  $P_\pi$  defined in Claim 1 is

$$\lambda^{(\pi)} = \left( \frac{\delta}{\alpha + \delta}, \frac{\alpha}{\alpha + \delta} \right)^T. \quad (62)$$

First, we estimate  $\mathcal{G}(-1)$  as a function of  $\alpha$ . We assume that all postulated distributions are the same as their true ones for simplicity. We also assume that  $S = 1$  with probability 1. Now from (29), we have

$$q_0(u, -1, 1; \eta) = \mathbb{E}_{\pi(-1, \cdot)} \left[ q_{U|X_0, X_1, S; \xi}(u \mid -1, \mathbf{X}, 1; \xi) \mid S = 1 \right] \quad (63)$$

$$= \mathbb{E}_{\pi(-1, \cdot)} \left[ \sqrt{\frac{\eta}{2\pi}} \exp \left[ -\frac{\eta}{2}(u - \mathbf{X})^2 \right] \right] \quad (64)$$

$$= \sum_{x \in \mathcal{X}} \sqrt{\frac{\eta}{2\pi}} \exp \left[ -\frac{\eta}{2}(u - x)^2 \right] \pi(-1, x) \quad (65)$$

$$= (1 - \alpha) \sqrt{\frac{\eta}{2\pi}} \exp \left[ -\frac{\eta}{2}(u + 1)^2 \right] + \alpha \sqrt{\frac{\eta}{2\pi}} \exp \left[ -\frac{\eta}{2}(u - 1)^2 \right]. \quad (66)$$

Similarly, from (30), we also have

$$q_1(u, -1, 1; \eta) = \mathbb{E}_{\pi(-1, \cdot)} \left[ X q_{U|X_0, X_1, S; \xi}(u \mid -1, \mathbf{X}, 1; \xi) \mid S = 1 \right] \quad (67)$$

$$= \mathbb{E}_{\pi(-1, \cdot)} \left[ X \sqrt{\frac{\eta}{2\pi}} \exp \left[ -\frac{\eta}{2}(u - \mathbf{X})^2 \right] \right] \quad (68)$$

$$= \sum_{x \in \mathcal{X}} x \sqrt{\frac{\eta}{2\pi}} \exp \left[ -\frac{\eta}{2}(u - x)^2 \right] \pi(-1, x) \quad (69)$$

$$= -(1 - \alpha) \sqrt{\frac{\eta}{2\pi}} \exp \left[ -\frac{\eta}{2}(u + 1)^2 \right] + \alpha \sqrt{\frac{\eta}{2\pi}} \exp \left[ -\frac{\eta}{2}(u - 1)^2 \right]. \quad (70)$$

Therefore, from (27), (28), (66), and (70), we have

$$\langle \mathbf{X} | \mathbf{X}_0 = -1 \rangle_q = \mathbb{E}_q \left[ \mathbf{X} | \mathbf{X}_0 = -1, U, 1; \eta \right] \quad (71)$$

$$= \frac{q_1(U, -1, 1; \eta)}{q_0(U, -1, 1; \eta)} \quad (72)$$

$$= \frac{1 - \left(\frac{1-\alpha}{\alpha}\right) \exp(-2\eta U)}{1 + \left(\frac{1-\alpha}{\alpha}\right) \exp(-2\eta U)}. \quad (73)$$



It follows from (31) and (32) that

$$\mathcal{V}(1; \eta, \eta | -1) = \mathcal{E}(1; \eta, \eta | -1) \quad (74)$$

$$= \mathbb{E} \left[ (\mathbf{X}_1 - \langle \mathbf{X} | \mathbf{X}_0 = -1 \rangle_q)^2 | \mathbf{X}_0 = -1, 1; \eta, \eta \right] \quad (75)$$

$$= \mathbb{E} \left[ \mathbf{X}_1^2 | \mathbf{X}_0 = -1, 1; \eta, \eta \right] - \langle \mathbf{X} | \mathbf{X}_0 = -1 \rangle_q^2 \quad (76)$$

$$= \sum_{x \in \mathcal{X}} x^2 \pi(-1, x) - \left( \frac{1 - \left(\frac{1-\alpha}{\alpha}\right) \exp(-2\eta U)}{1 + \left(\frac{1-\alpha}{\alpha}\right) \exp(-2\eta U)} \right)^2 \quad (77)$$

$$= 1 - \left( \frac{1 - \left(\frac{1-\alpha}{\alpha}\right) \exp(-2\eta U)}{1 + \left(\frac{1-\alpha}{\alpha}\right) \exp(-2\eta U)} \right)^2. \quad (78)$$

Similarly, we have

$$\mathcal{V}(1; \eta, \eta | 1) = \mathcal{E}(1; \eta, \eta | 1) \quad (79)$$

$$= 1 - \left( \frac{1 - \left(\frac{\delta}{1-\delta}\right) \exp(-2\eta U)}{1 + \left(\frac{\delta}{1-\delta}\right) \exp(-2\eta U)} \right)^2. \quad (80)$$

Now, by (27), the single-symbol PME for this special case is

$$U = \mathbf{X}_1 + \frac{1}{\sqrt{\eta}} W. \quad (81)$$

Now, observe that

- Under the condition that  $\mathbf{X}_1 \sim \pi(-1, \cdot)$ , we have

$$F_U(u) = \mathbb{P}(U \leq u) \quad (82)$$

$$= \mathbb{P}(U \leq u | \mathbf{X}_1 = -1) \pi(-1, -1) + \mathbb{P}(U \leq u | \mathbf{X}_1 = 1) \pi(-1, 1) \quad (83)$$

$$= (1 - \alpha) \mathbb{P}(W \leq (u + 1)\sqrt{\eta}) + \alpha \mathbb{P}(W \leq (u - 1)\sqrt{\eta}) \quad (84)$$

$$= (1 - \alpha) \Phi((u + 1)\sqrt{\eta}) + \alpha \Phi((u - 1)\sqrt{\eta}) \quad (85)$$

where  $\Phi(x) := \frac{1}{\sqrt{2\pi}} \int_{-\infty}^x \exp(-t^2/2) dt$ . From (85), we obtain<sup>5</sup>

$$f_Z^{(\text{MS},1)}(u) = \frac{1}{\sqrt{2\pi}} (1 - \alpha) \sqrt{\eta} \exp\left(-\frac{(u+1)^2 \eta}{2}\right) + \frac{1}{\sqrt{2\pi}} \alpha \sqrt{\eta} \exp\left(-\frac{(u-1)^2 \eta}{2}\right). \quad (86)$$

- Similarly, under the condition  $\mathbf{X}_1 \sim \pi(1, \cdot)$ , we have

$$f_Z^{(\text{MS},2)}(u) = \frac{1}{\sqrt{2\pi}} \delta \sqrt{\eta} \exp\left(-\frac{(u+1)^2 \eta}{2}\right) + \frac{1}{\sqrt{2\pi}} (1 - \delta) \sqrt{\eta} \exp\left(-\frac{(u-1)^2 \eta}{2}\right). \quad (87)$$

<sup>5</sup>We can derive it use the convolution since  $W$  and  $X_1$  are independent random variables.

Hence, from Theorem 15,  $\eta$  is a solution of the following equation

$$\eta^{-1} = 1 + \beta \left( \frac{\delta}{\delta + \alpha} \mathbb{E}[1\mathcal{E}(1; \eta, \eta | -1)] + \frac{\alpha}{\delta + \alpha} \mathbb{E}[1\mathcal{E}(1; \eta, \eta | 1)] \right), \quad (88)$$

$$\begin{aligned} &= 1 + \beta \left( \frac{\delta}{\delta + \alpha} \mathbb{E}_{f_Z^{(\text{MS},1)}} \left[ 1 - \left( \frac{1 - \left( \frac{1-\alpha}{\alpha} \right) \exp(-2\eta U)}{1 + \left( \frac{1-\alpha}{\alpha} \right) \exp(-2\eta U)} \right)^2 \right] \right. \\ &\quad \left. + \frac{\alpha}{\delta + \alpha} \mathbb{E}_{f_Z^{(\text{MS},2)}} \left[ 1 - \left( \frac{1 - \left( \frac{\delta}{1-\delta} \right) \exp(-2\eta U)}{1 + \left( \frac{\delta}{1-\delta} \right) \exp(-2\eta U)} \right)^2 \right] \right). \end{aligned} \quad (89)$$

Now, since  $S = 1, \xi = \eta, \sigma = 1, \tilde{\pi} = \pi$ , from (33), we have

$$\begin{aligned} \mathcal{G}(-1) \Big|_{\sigma=1, \tilde{\pi}=\pi} &= - \int p_{U|X_0, S; \eta}(u | -1, 1; \eta) \log p_{U|X_0, S; \eta}(u | -1, 1; \eta) du \\ &\quad + \frac{1}{2\beta} \left[ (\eta - 1) \log e - \log \eta \right] - \frac{1}{2} \log \frac{2\pi}{\eta} - \frac{1}{2} \log e \\ &\quad + \frac{1}{2\beta} \log(2\pi) + \frac{1}{2\beta} \log e. \end{aligned} \quad (90)$$

On the other hand,

$$p_{U|X_0, 1; \eta}(u | -1, 1; \eta) = \sum_{x \in \mathcal{X}} p_{U|X_0, X_1, 1; \eta}(u | -1, x, 1; \eta) \pi(-1, x) \quad (91)$$

$$= \sum_{x \in \mathcal{X}} \sqrt{\frac{\eta}{2\pi}} \exp \left[ -\frac{\eta}{2}(u-x)^2 \right] \pi(-1, x) \quad (92)$$

$$= (1-\alpha) \sqrt{\frac{\eta}{2\pi}} \exp \left[ -\frac{\eta}{2}(u+1)^2 \right] + \alpha \sqrt{\frac{\eta}{2\pi}} \exp \left[ -\frac{\eta}{2}(u-1)^2 \right]. \quad (93)$$

It follows that

$$\mathcal{G}(-1) \Big|_{S=1, \sigma=1, \tilde{\pi}=\pi} = \bar{G}(-1, \eta, \alpha), \quad (94)$$

where

$$\begin{aligned} \bar{G}(-1, \eta, \alpha) &:= - \int_{-\infty}^{\infty} \left( (1-\alpha) \sqrt{\frac{\eta}{2\pi}} \exp \left[ -\frac{\eta}{2}(u+1)^2 \right] + \alpha \sqrt{\frac{\eta}{2\pi}} \exp \left[ -\frac{\eta}{2}(u-1)^2 \right] \right) \\ &\quad \times \log \left( (1-\alpha) \sqrt{\frac{\eta}{2\pi}} \exp \left[ -\frac{\eta}{2}(u+1)^2 \right] + \alpha \sqrt{\frac{\eta}{2\pi}} \exp \left[ -\frac{\eta}{2}(u-1)^2 \right] \right) du \\ &\quad + \frac{1}{2\beta} \left[ (\eta - 1) \log e - \log \eta \right] - \frac{1}{2} \log \frac{2\pi}{\eta} - \frac{1}{2} \log e \\ &\quad + \frac{1}{2\beta} \log(2\pi) + \frac{1}{2\beta} \log e. \end{aligned} \quad (95)$$

By the symmetry, it is not hard to see that

$$\mathcal{G}(1) \Big|_{S=1, \sigma=1, \tilde{\pi}=\pi} = \bar{G}(1, \eta, \delta), \quad (96)$$

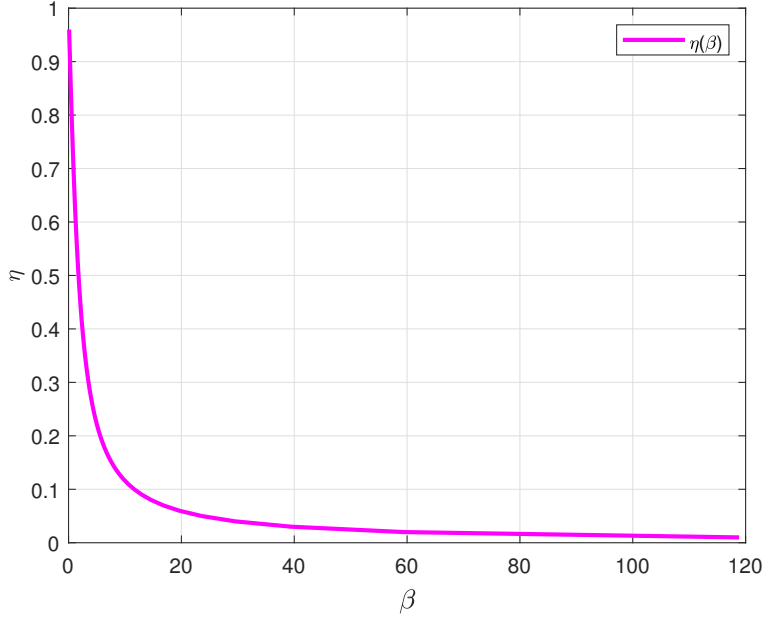

Fig. 3.  $\eta$  as a decreasing function in  $\beta$  for the symmetric case  $\alpha = \delta = 0.3$ .

where

$$\begin{aligned}
\bar{G}(1, \eta, \delta) &:= - \int_{-\infty}^{\infty} \left( \delta \sqrt{\frac{\eta}{2\pi}} \exp \left[ -\frac{\eta}{2}(u+1)^2 \right] + (1-\delta) \sqrt{\frac{\eta}{2\pi}} \exp \left[ -\frac{\eta}{2}(u-1)^2 \right] \right) \\
&\quad \times \log \left( \delta \sqrt{\frac{\eta}{2\pi}} \exp \left[ -\frac{\eta}{2}(u+1)^2 \right] + (1-\delta) \sqrt{\frac{\eta}{2\pi}} \exp \left[ -\frac{\eta}{2}(u-1)^2 \right] \right) du \\
&\quad + \frac{1}{2\beta} \left[ (\eta-1) \log e - \log \eta \right] - \frac{1}{2} \log \frac{2\pi}{\eta} - \frac{1}{2} \log e \\
&\quad + \frac{1}{2\beta} \log(2\pi) + \frac{1}{2\beta} \log e.
\end{aligned} \tag{97}$$

Now, let  $\mathcal{C}_\beta(\alpha, \delta)$  is the set of all solutions  $\eta$  of the equation (89) given  $\beta$  and  $\alpha$  and  $\delta$ . Then, by Theorem 15 and (62), the free energy can be expressed as

$$\mathcal{F} \Big|_{S=1, \sigma=1, \tilde{\pi}=\pi} = \min_{\eta \in \mathcal{C}_\beta(\alpha, \delta)} \left[ \frac{\delta}{\alpha + \delta} \mathcal{G}(-1) + \frac{\alpha}{\alpha + \delta} \mathcal{G}(1) \right], \tag{98}$$

where  $\mathcal{G}(-1)$  and  $\mathcal{G}(1)$  are given in (94) and (96), respectively.

Solving the optimization problem in (98) is very challenging. However, by observing that given  $\alpha$  and  $\delta$ ,  $\beta$ ,  $\bar{G}(-1, \eta, \alpha)$  and  $\bar{G}(1, \eta, \alpha)$  are functions of  $\eta$ . Hence, we can numerically plot the free energy  $\mathcal{F}$  and the average mutual information as functions of  $(\alpha, \delta)$ . For the symmetric case  $\delta = \alpha = 0.3$ ,  $\beta$  is a monotone function in  $\eta$  (cf. 3)<sup>6</sup>, hence  $\mathcal{C}_\beta$  in (94) contains only one element  $\eta$ , at which we achieve

<sup>6</sup>We can prove this fact by taking derivative  $\frac{d\beta}{d\eta}$ .

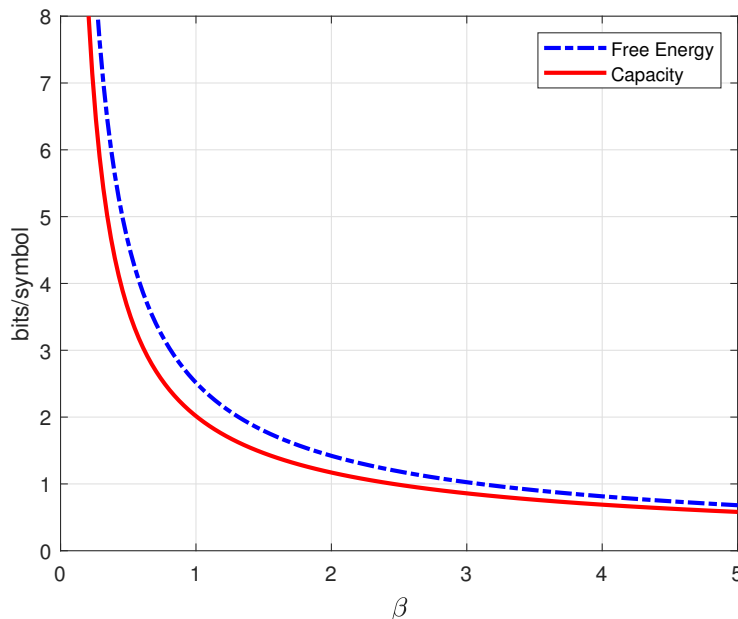

Fig. 4. Free energy and average mutual information as functions of  $\beta$  for the symmetric case  $\alpha = \delta = 0.3$ .

the average mutual information and free energy. For example, in Fig. 4, we plot the free energy and the average mutual information for symmetric case  $\delta = \alpha = 0.3$ .

For the non-symmetric case  $\alpha = 0.2$  and  $\delta = 0.5$ ,  $\beta$  is also a monotone function in  $\eta$  (cf. Fig. 5), so  $\mathcal{C}_\beta(\alpha, \delta)$  contains only one element. Then, we obtain the free energy and the average mutual information for this case as in Fig. 6.

2) *Approximate Message Passing vs. Replica Prediction:* As in Section IV-A1, we consider the Markov chain with the state space  $\{-1, 1\}$  and the probability transition matrix is

$$\begin{bmatrix} \pi(-1, -1) & \pi(-1, 1) \\ \pi(1, -1) & \pi(1, 1) \end{bmatrix} = \begin{bmatrix} 1 - \alpha & \alpha \\ \delta & 1 - \delta \end{bmatrix} \quad (99)$$

for some  $\alpha$  and  $\delta$  in  $(0, 1)$ .

Since  $\mathbf{X}_1 \in \{-1, 1\}$ , we have

$$\mathbb{E}[\mathbf{X}_1^2] - \mathbb{E}[\langle \mathbf{X}_1 | \mathbf{X}_0 = -1 \rangle^2] = 1 - \mathbb{E}[\langle \mathbf{X}_1 | \mathbf{X}_0 = -1 \rangle^2] \quad (100)$$

$$= \mathbb{E}[\mathbf{X}_1^2 | \mathbf{X}_0 = -1] - \mathbb{E}[\langle \mathbf{X}_1 | \mathbf{X}_0 = -1 \rangle^2] \quad (101)$$

$$= \mathbb{E} \left[ (\mathbf{X}_1 - \langle \mathbf{X}_1 | \mathbf{X}_0 = -1 \rangle)^2 \middle| \mathbf{X}_0 = -1 \right] \quad (102)$$

$$= \mathbb{E}_{f_Z^{(\text{MS}, 1)}} \left[ 1 - \left( \frac{1 - \left( \frac{1-\alpha}{\alpha} \right) \exp(-2\eta U)}{1 + \left( \frac{1-\alpha}{\alpha} \right) \exp(-2\eta U)} \right)^2 \right], \quad (103)$$

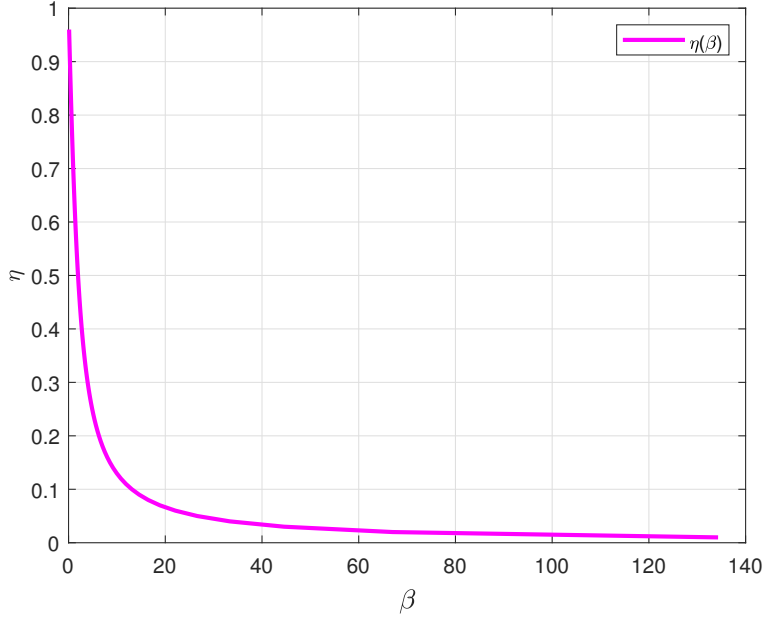

Fig. 5.  $\eta$  as a decreasing function in  $\beta$  for the non-symmetric case  $\alpha = 0.2$  and  $\delta = 0.5$ .

where (103) follows from (78). Here, the expectation in (103) is taken over  $Z$  with distribution (cf. (86))

$$f_Z^{(\text{MS},1)}(u) = \frac{1}{\sqrt{2\pi}}(1-\alpha)\sqrt{\eta}\exp\left(-\frac{(u+1)^2\eta}{2}\right) + \frac{1}{\sqrt{2\pi}}\alpha\sqrt{\eta}\exp\left(-\frac{(u-1)^2\eta}{2}\right). \quad (104)$$

Similarly, by symmetry, given  $X_0 = 1$ , we also have:

$$\mathbb{E}[X_1^2] - \mathbb{E}[\langle X_1 | X_0 = x_0 \rangle^2] = \mathbb{E}\left[\langle X_1 - \langle X_1 | X_0 = 1 \rangle \rangle^2 \middle| X_0 = 1\right] \quad (105)$$

$$= \mathbb{E}\left[\mathcal{E}(1; \eta, \eta|1)\right] \quad (106)$$

$$= \mathbb{E}_{f_Z^{(\text{MS},2)}}\left[1 - \left(\frac{1 - \left(\frac{\delta}{1-\delta}\right)\exp(-2\eta U)}{1 + \left(\frac{\delta}{1-\delta}\right)\exp(-2\eta U)}\right)^2\right], \quad (107)$$

where the expectation is taken over  $U$  with distribution

$$f_Z^{(\text{MS},2)}(u) = \frac{1}{\sqrt{2\pi}}\delta\sqrt{\eta}\exp\left(-\frac{(u+1)^2\eta}{2}\right) + \frac{1}{\sqrt{2\pi}}(1-\delta)\sqrt{\eta}\exp\left(-\frac{(u-1)^2\eta}{2}\right). \quad (108)$$

Then, by Theorem 15 and (62), we can express the MMSE of this model as follows:

$$\begin{aligned} \text{MMSE}_{\text{DMS}} &= \frac{\delta}{\alpha + \delta} \mathbb{E}_{f_Z^{(\text{MS},1)}}\left[1 - \left(\frac{1 - \left(\frac{1-\alpha}{\alpha}\right)\exp(-2\eta U)}{1 + \left(\frac{1-\alpha}{\alpha}\right)\exp(-2\eta U)}\right)^2\right] \\ &\quad + \frac{\alpha}{\alpha + \delta} \mathbb{E}_{f_Z^{(\text{MS},2)}}\left[1 - \left(\frac{1 - \left(\frac{\delta}{1-\delta}\right)\exp(-2\eta U)}{1 + \left(\frac{\delta}{1-\delta}\right)\exp(-2\eta U)}\right)^2\right]. \end{aligned} \quad (109)$$

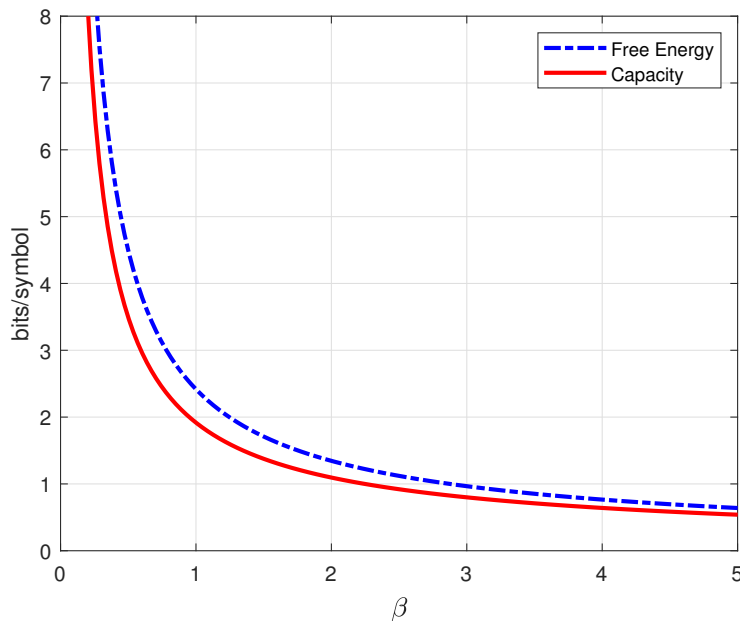

Fig. 6. Free energy and average mutual information as functions of  $\beta$  for the non-symmetric case  $\alpha = 0.2$  and  $\delta = 0.5$ .

In this section, we compare the MSE bounds in Theorem 18 with an MSE achieved by a our newly-developed AMP algorithm called AMP with forward-backward denoiser (AMPFB). This algorithm is developed based on AMP algorithm for the linear model with i.i.d. prior in [29, Sect. 2-C]. This algorithm is as follows:

$$x^{t+1} = \eta(A^T z^t + x^t; \hat{\tau}_t) \quad (110)$$

$$z^t = y - Ax^t + z^{t-1} \frac{\text{div}(\eta(A^T z^t + x^t; \hat{\tau}_t))}{m} \quad (111)$$

$$(\hat{\tau}_t)^2 = \frac{\|z^t\|^2}{m} \quad (112)$$

Initialize with  $x^0 = 0$  and  $z^0 = y$ .

Define

$$f(s; (\mu, \tau)) := \frac{1}{\sqrt{2\pi\tau^2}} e^{-\frac{(s-\mu)^2}{2\tau^2}}. \quad (113)$$

Here, for  $s = (s_1, s_2, \dots, s_n)$

$$\eta(s; \tau) = [\eta_1(s; \tau), \eta_2(s; \tau), \dots, \eta_m(s; \tau)] \quad (114)$$

where

$$\eta_i(s, \tau) = 2\mathbb{P}(X_i = 1|s) - 1 \quad (115)$$

$$= \frac{2f(s_i; (1, \tau))\alpha_i(1)\beta_i(1)}{f(s_i; (1, \tau))\alpha_i(1)\beta_i(1) + f(s_i; (-1, \tau))\alpha_i(-1)\beta_i(-1)} - 1. \quad (116)$$

In addition,  $\alpha(\cdot)$  and  $\beta(\cdot)$  are computed with the forward-backward algorithm as follows. For  $x \in \{+1, -1\}$ :

$$\alpha_i(X_i = x) = \alpha_{i-1}(1)f(s_{i-1}; (1, \tau))\pi(1, x) + \alpha_{i-1}(-1)f(s_{i-1}; (-1, \tau))\pi(-1, x), \quad (117)$$

$$\beta_i(X_i = x) = \beta_{i+1}(1)f(s_{i+1}; (1, \tau))\pi(x, 1) + \beta_{i+1}(-1)f(s_{i+1}; (-1, \tau))\pi(x, -1) \quad (118)$$

with initialization

$$\alpha_1(X_1 = x) = \pi_0(x) \quad (119)$$

$$\beta_n(X_n = x) = 1. \quad (120)$$

The chosen  $\eta$  function is the MMSE-optimal estimator of  $X$  given  $S = X + \hat{\tau}_t Z$ . It can be shown that

$$\frac{\partial \eta_i(s)}{\partial s_i} = \frac{4}{D_{\tau_i}^2 \tau^2} \alpha_i(1)\alpha_i(-1)\beta_i(1)\beta_i(-1)f(s_i; (1, \tau))f(s_i; (-1, \tau)), \quad (121)$$

where

$$D_{\tau_i} = f(s_i; (1, \tau))\alpha_i(1)\beta_i(1) + f(s_i; (-1, \tau))\alpha_i(-1)\beta_i(-1). \quad (122)$$

Therefore,

$$\text{div}(\eta(s; \tau)) = \frac{4}{\tau^2} \frac{\alpha_i(1)\beta_i(1)\alpha_i(-1)\beta_i(-1)f(s_i; (1, \tau))f(s_i; (-1, \tau))}{(f(s_i; (1, \tau))\alpha_i(1)\beta_i(1) + f(s_i; (-1, \tau))\alpha_i(-1)\beta_i(-1))^2}. \quad (123)$$

Our obtained results are as follows.

- For the symmetric case  $\alpha = \delta = 0.3$ , the Markov model in Section II is different from the linear model in [4, Sect. II] where the authors assume  $\{X_n\}_{n=1}^\infty$  is i.i.d.. For this special case, Fig. 3 shows that  $\mathcal{C}_\beta(\alpha, \delta)$ , which is the set of solutions  $\eta$  of the equation (89), has a unique element for each  $\beta$  and given pair  $(\alpha, \delta)$ . Fig. 7 shows that MMSE by replica prediction in Theorem 18 is a good lower bound to MSE by AMPFB.
- For the non-symmetric case  $(\alpha, \delta) = (0.15, 0.3)$ , the Markov models in Section II is very different from the linear model with i.i.d. sources in [4, Sect. II]. For this special case, Fig. 8 shows that  $\mathcal{C}_\beta(\alpha, \delta)$ , which is the set of solutions  $\eta$  of the equation (89), has a unique element for each  $\beta$  and given pair  $(\alpha, \delta)$ . Fig. 9 shows that MMSE by replica prediction in Theorem 18 is also a good lower bound to MSE by AMPFB. However, the gap is bigger than the symmetric case.

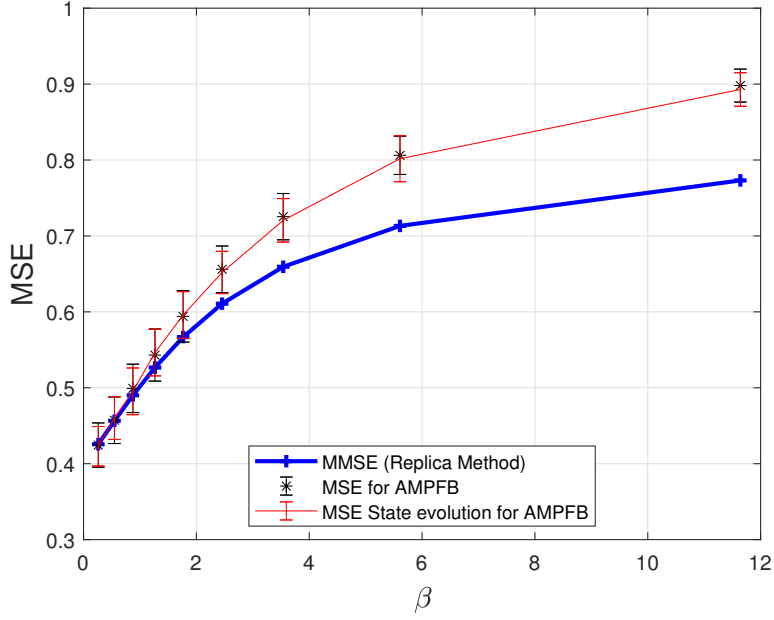

Fig. 7. MMSE by the Replica Method and MSE by AMPFB as functions of  $\beta$  for the symmetric case  $\alpha = 0.3$  and  $\delta = 0.3$ .

### B. Gauss-Markov Prior

We consider a Gauss-Markov prior  $\{X_n\}_{n=1}^\infty$  on  $\mathcal{X} = \mathbb{R}$ , i.e.,  $X_n = \nu X_{n-1} + Z$ , where  $Z \sim \mathcal{N}(0, \sigma_0^2)$  and  $\nu \in (0, 1)$ . Then, the transition probability is

$$\pi(x_0, x) := \frac{1}{\sigma_0 \sqrt{2\pi}} \exp \left[ -\frac{1}{2\sigma_0^2} (x - \nu x_0)^2 \right]. \quad (124)$$

This means that  $X_n | X_{n-1} = x_0 \sim \mathcal{N}(\nu x_0, \sigma_0^2)$  for all  $n \in \mathbb{Z}_+$ .

1) *Free Energy and Average Mutual Information*: We assume that all postulated distributions are the same as their true ones for simplicity. Now, given  $S = s \in \mathcal{S}$ , for any  $x_0 \in \mathcal{X} = \mathbb{R}$  and  $X_1 \sim \mathcal{N}(\nu x_0, \sigma_0^2)$ , from (27) and (28), we have

$$\rho_s := \frac{\mathbb{E}[X_1 U | X_0 = x_0] - \mathbb{E}[X_1 | X_0 = x_0] \mathbb{E}[U | X_0 = x_0]}{\sigma_0 \sqrt{\sigma_0^2 + \frac{1}{\eta}}} \quad (125)$$

$$= \frac{\sqrt{s}(\nu^2 x_0^2 + \sigma_0^2) - \nu^2 x_0^2 \sqrt{s}}{\sigma_0 \sqrt{s\sigma_0^2 + \frac{1}{\eta}}} \quad (126)$$

$$= \sqrt{\frac{s\sigma_0^2}{s\sigma_0^2 + \frac{1}{\eta}}}. \quad (127)$$



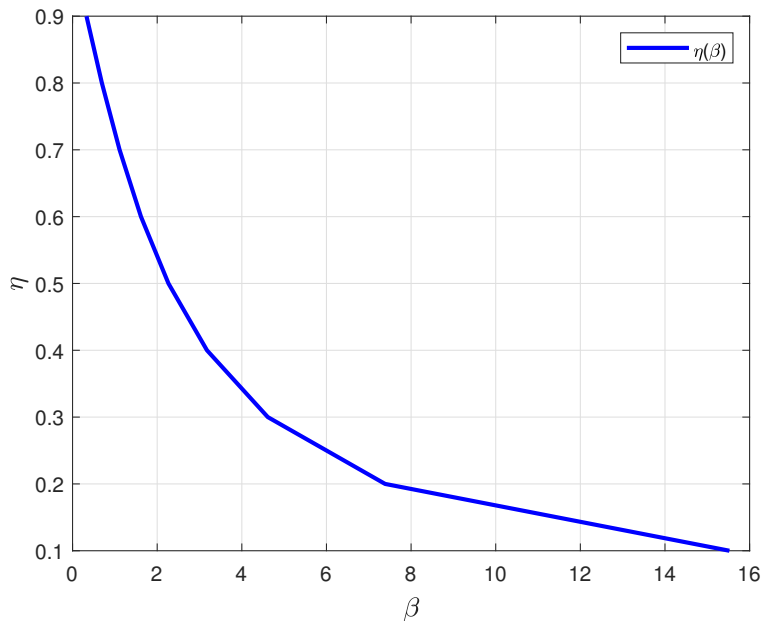

Fig. 8.  $\eta$  as a function of  $\beta$  for the asymmetric case  $\alpha = 0.15$  and  $\delta = 0.3$ .

From (31), (32), and the standard result for MMSE of the bivariate Gaussian distribution (e.g., [34]), given any  $s \in \mathcal{K}$  and  $x_0 \in \mathcal{X} = \mathbb{R}$ , it holds that

$$\mathcal{V}(s; \eta, \eta | x_0) = \mathcal{E}(s; \eta, \eta | x_0) \quad (128)$$

$$= \mathbb{E} \left[ (X_1 - \langle X | X_0 = x_0 \rangle)^2 | X_0 = x_0, s; \eta, \eta \right] \quad (129)$$

$$= \text{Var}(X_1 | X_0 = x_0) (1 - \rho_s^2) \quad (130)$$

$$= \sigma_0^2 \left( 1 - \frac{s\sigma_0^2}{s\sigma_0^2 + \frac{1}{\eta}} \right) \quad (131)$$

$$= \frac{\sigma_0^2 \frac{1}{\eta}}{s\sigma_0^2 + \frac{1}{\eta}}. \quad (132)$$

Hence, from (35) and (132),  $\eta$  is a solution of the following equation

$$\eta^{-1} = 1 + \beta \mathbb{E}[S \mathcal{E}(S; \eta, \eta | 0)], \quad (133)$$

$$= 1 + \beta \mathbb{E} \left[ \frac{S \frac{\sigma_0^2}{\eta}}{S \sigma_0^2 + \frac{1}{\eta}} \right]. \quad (134)$$

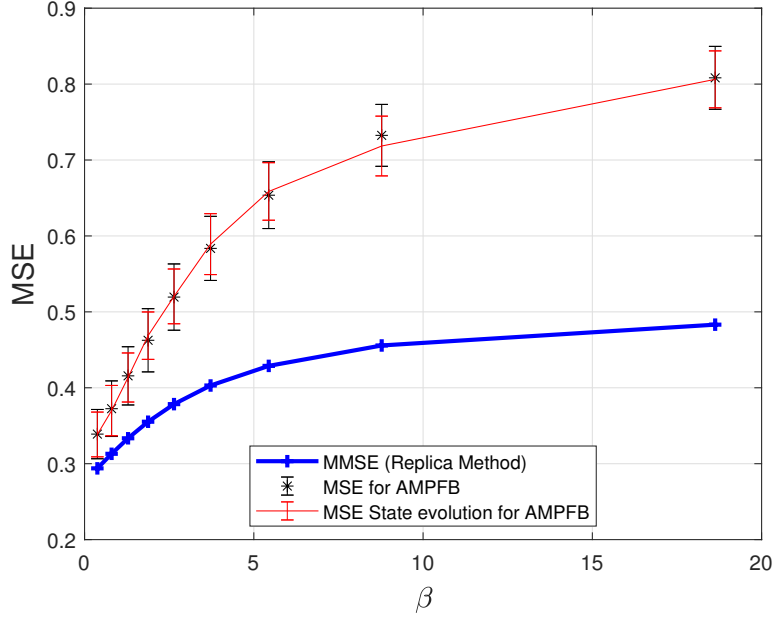

Fig. 9. MMSE by the Replica Method and MSE by AMPFB as functions of  $\beta$  for the asymmetric case  $\alpha = 0.15$  and  $\delta = 0.3$ .

In addition, since  $\xi = \eta$  and  $\sigma = 1$ , from (33), we have

$$\begin{aligned}
\mathcal{G}(x_0) &= -\mathbb{E} \left[ \int p_{U|X_0, S; \eta}(u | x_0, S; \eta) \log p_{U|X_0, S; \eta}(u | x_0, S; \eta) du \right] \\
&\quad + \frac{1}{2\beta} \left[ (\eta - 1) \log e - \log \eta \right] - \frac{1}{2} \log \frac{2\pi}{\eta} - \frac{1}{2} \log e \\
&\quad + \frac{1}{2\beta} \log(2\pi) + \frac{1}{2\beta} \log e
\end{aligned} \tag{135}$$

$$\begin{aligned}
&= h(U|X_0 = x_0, S; \eta) \\
&\quad + \frac{1}{2\beta} \left[ (\eta - 1) \log e - \log \eta \right] - \frac{1}{2} \log \frac{2\pi}{\eta} - \frac{1}{2} \log e \\
&\quad + \frac{1}{2\beta} \log(2\pi) + \frac{1}{2\beta} \log e
\end{aligned} \tag{136}$$

$$\begin{aligned}
&= \frac{1}{2} \mathbb{E} \left[ \log \left( 2\pi e \left( S\sigma_0^2 + \frac{1}{\eta} \right) \right) \right] + \frac{1}{2\beta} \left[ (\eta - 1) \log e - \log \eta \right] - \frac{1}{2} \log \frac{2\pi}{\eta} - \frac{1}{2} \log e \\
&\quad + \frac{1}{2\beta} \log(2\pi) + \frac{1}{2\beta} \log e.
\end{aligned} \tag{137}$$

Since  $\mathcal{G}(x_0)$  does not depend on  $x_0$ , hence we also have a tight bound for this case, and the free energy is equal to

$$\mathcal{F}_q \Big|_{\sigma=1, \tilde{\pi}=\pi} = \frac{1}{2} \mathbb{E} \left[ \log \left( 2\pi e \left( S\sigma_0^2 + \frac{1}{\eta} \right) \right) \right] + \frac{1}{2\beta} \left[ (\eta - 1) \log e - \log \eta \right]$$

$$-\frac{1}{2} \log \frac{2\pi}{\eta} - \frac{1}{2} \log e + \frac{1}{2\beta} \log(2\pi) + \frac{1}{2\beta} \log e, \quad (138)$$

where  $\eta$  is a solution of (134), which is chosen to minimize  $\mathcal{F}_q$ .

Hence, we come up with the following result:

**Theorem 4.** *For the case  $\{X_n\}_{n=1}^\infty$  is a continuous-space time-homogeneous Markov process with transition function  $\pi(x_0, x) = \frac{1}{\sigma_0\sqrt{2\pi}} \exp[-\frac{1}{2\sigma_0^2}(x - x_0)^2]$ , the free energy for the exact postulated model satisfies*

$$\begin{aligned} \mathcal{F}_q \Big|_{\sigma=1, \tilde{\pi}=\pi} &= \frac{1}{2} \mathbb{E} \left[ \log \left( 2\pi e \left( S\sigma_0^2 + \frac{1}{\eta} \right) \right) \right] + \frac{1}{2\beta} \left[ (\eta - 1) \log e - \log \eta \right] \\ &\quad - \frac{1}{2} \log \frac{2\pi}{\eta} - \frac{1}{2} \log e + \frac{1}{2\beta} \log(2\pi) + \frac{1}{2\beta} \log e \end{aligned} \quad (139)$$

where  $\eta$  is a solution of the following equation

$$\eta^{-1} = 1 + \beta \mathbb{E}[S\mathcal{E}(S; \eta, \eta|0)], \quad (140)$$

$$= 1 + \beta \mathbb{E} \left[ \frac{S\frac{\sigma_0^2}{\eta}}{S\sigma_0^2 + \frac{1}{\eta}} \right], \quad (141)$$

which is chosen to minimize  $\mathcal{F}_q$ .

In addition, the average mutual information of this vector channel satisfies

$$C = \mathcal{F}_q \Big|_{\sigma=1, \tilde{\pi}=\pi} - \frac{1}{2\beta}. \quad (142)$$

Now, we consider two specific cases:

- Assume that  $S = s_0$  for some  $s_0 \in \mathbb{R}^+$ <sup>7</sup>, then for a fixed  $\beta$ , (141) is equivalent to

$$s_0\sigma_0^2\eta^2 + ((\beta - 1)s_0\sigma_0^2 + 1)\eta - 1 = 0, \quad (143)$$

which has solution

$$\eta \in \left\{ \frac{-((\beta - 1)s_0\sigma_0^2 + 1) \pm \sqrt{((\beta - 1)s_0\sigma_0^2 + 1)^2 + 4s_0\sigma_0^2}}{2s_0\sigma_0^2} \right\}. \quad (144)$$

Note that  $\eta \in (0, 1)$  (cf. (134)), it follows that

$$\eta = \frac{-((\beta - 1)s_0\sigma_0^2 + 1) + \sqrt{((\beta - 1)s_0\sigma_0^2 + 1)^2 + 4s_0\sigma_0^2}}{2s_0\sigma_0^2}. \quad (145)$$

<sup>7</sup>For example, in BPSK or QPSK modulation schemes in communications, all symbols in the constellation have a fixed energy

Hence, by Theorem 4, the free energy satisfies

$$\begin{aligned} \mathcal{F}_q \Big|_{S=s_0, \sigma=1, \tilde{\pi}=\pi} &= \frac{1}{2} \log \left( 2\pi e \left( s_0 \sigma_0^2 + \frac{1}{\eta} \right) \right) + \frac{1}{2\beta} \left[ (\eta - 1) \log e - \log \eta \right] \\ &\quad - \frac{1}{2} \log \frac{2\pi}{\eta} - \frac{1}{2} \log e + \frac{1}{2\beta} \log(2\pi) + \frac{1}{2\beta} \log e \end{aligned} \quad (146)$$

where

$$\eta = \frac{-((\beta - 1)s_0\sigma_0^2 + 1) + \sqrt{((\beta - 1)s_0\sigma_0^2 + 1)^2 + 4s_0\sigma_0^2}}{2s_0\sigma_0^2}. \quad (147)$$

The following figures plot the free energy and the average mutual information as functions of  $\sigma_0^2$  (cf. Fig. 10) for a fixed pair  $(\beta, s_0)$  or as a function of  $\beta$  for a fixed pair  $(\sigma_0^2, s_0)$  (cf. Fig. 11) or as a function of  $s_0$  for a fixed pair  $(\beta, \sigma_0^2)$  (cf. Fig. 12). As seen in Fig. 11, as  $\beta$  big enough,

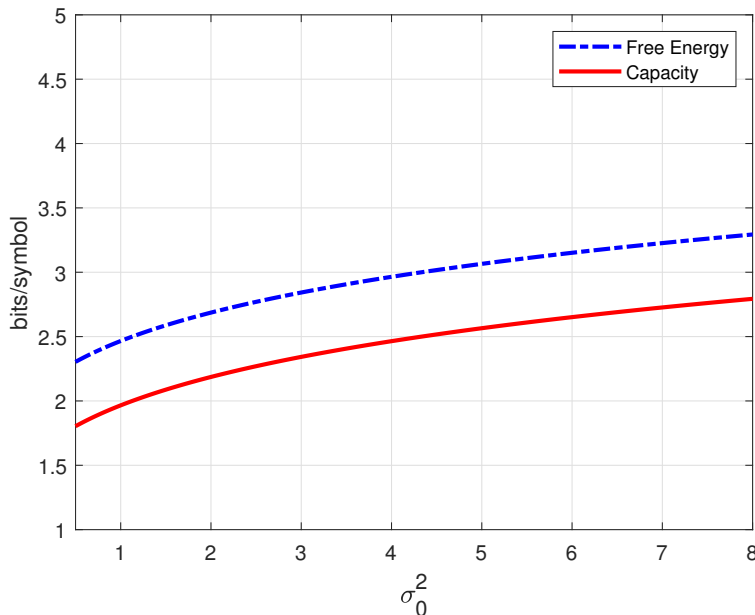

Fig. 10. Free energy and average mutual information as functions of  $\sigma_0^2$  for  $\beta = 1$  and  $s_0 = 1$ .

the average mutual information is very small (tends to zero) since the number of observations  $m$  is too small compared with the signal dimension  $n$ . In addition, as  $s_0$  increases, the free energy and mutual information also increase as in Fig. 12.

- We assume that  $S$  is uniformly distributed in  $\mathcal{S} := \{1, 2, \dots, |\mathcal{S}|\}$  for some  $|\mathcal{S}| \in \mathbb{Z}^+$ <sup>8</sup>. Then, by

<sup>8</sup>For example, there are  $K$  different power levels in the constellation of QAMs in communications.

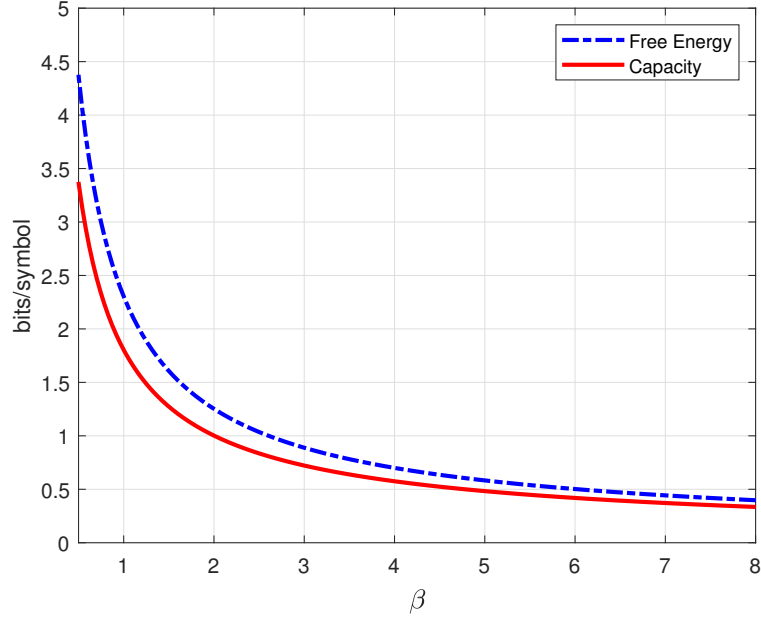

Fig. 11. Free energy and average mutual information as functions of  $\beta$  for  $\sigma_0^2 = 4$  and  $s_0 = 1$ .

Theorem 4,  $\eta$  is a solution of the following equation:

$$\eta^{-1} = 1 + \beta \mathbb{E}[S \mathcal{E}(S; \eta, \eta|0)], \quad (148)$$

$$= 1 + \beta \mathbb{E} \left[ \frac{S \frac{\sigma_0^2}{\eta}}{S \sigma_0^2 + \frac{1}{\eta}} \right] \quad (149)$$

$$= 1 + \frac{\beta \sigma_0^2}{|\mathcal{S}|} \sum_{k=1}^{|\mathcal{S}|} \frac{k}{k \eta \sigma_0^2 + 1}. \quad (150)$$

In addition, by Theorem 4, the free energy satisfies

$$\begin{aligned} \mathcal{F}_q \Big|_{\sigma=1, \tilde{\pi}=\pi} &= \frac{1}{2|\mathcal{S}|} \sum_{k=1}^{|\mathcal{S}|} \log \left( 2\pi e \left( k \sigma_0^2 + \frac{1}{\eta} \right) \right) + \frac{1}{2\beta} \left[ (\eta - 1) \log e - \log \eta \right] \\ &\quad - \frac{1}{2} \log \frac{2\pi}{\eta} - \frac{1}{2} \log e + \frac{1}{2\beta} \log(2\pi) + \frac{1}{2\beta} \log e, \end{aligned} \quad (151)$$

where  $\eta$  is a solution of (150), which is chosen to minimize  $\mathcal{F}$ . For example, as  $|\mathcal{S}| = 2$ ,  $\eta$  is the solution in  $(0, 1)$  of the following equation:

$$4\sigma_0^4 \eta^3 + (4\sigma_0^4 \beta + 6\sigma_0^2 - 4\sigma_0^4) \eta^2 + (3\beta \sigma_0^2 - 6\sigma_0^2 + 2) \eta - 2 = 0 \quad (152)$$

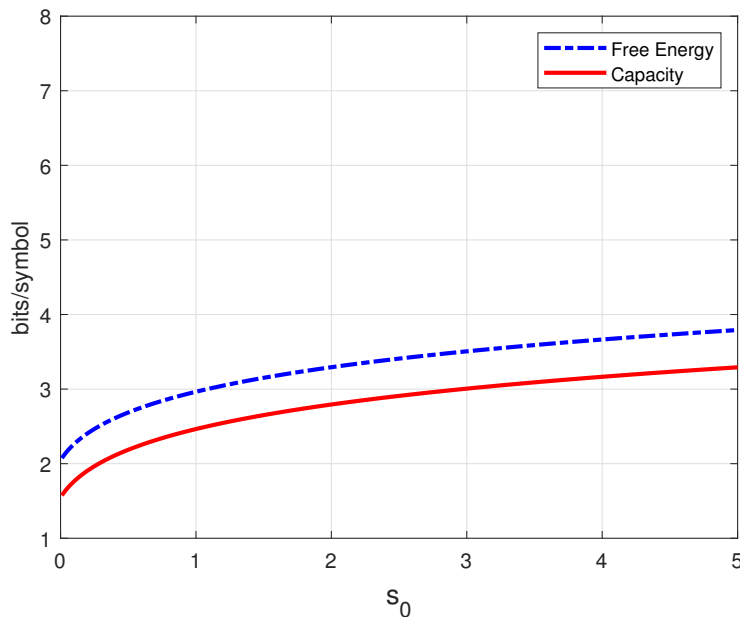

Fig. 12. Free energy and average mutual information as functions of  $s_0$  for  $\sigma_0^2 = 4$  and  $\beta = 1$ .

such that it minimizes

$$\begin{aligned} \mathcal{F}_q \Big|_{\sigma=1, \tilde{\pi}=\pi} &= \frac{1}{4} \left[ \log \left( 2\pi e \left( \sigma_0^2 + \frac{1}{\eta} \right) \right) + \log \left( 2\pi e \left( 2\sigma_0^2 + \frac{1}{\eta} \right) \right) \right] + \frac{1}{2\beta} \left[ (\eta - 1) \log e - \log \eta \right] \\ &\quad - \frac{1}{2} \log \frac{2\pi}{\eta} - \frac{1}{2} \log e + \frac{1}{2\beta} \log(2\pi) + \frac{1}{2\beta} \log e. \end{aligned} \quad (153)$$

The following figures plot the free energy and the average mutual information as functions of  $\sigma_0^2$  (cf. Fig. 13) for a fixed pair  $(\beta, |\mathcal{S}| = 2)$  or as a function of  $\beta$  for a fixed pair  $(\sigma_0^2, |\mathcal{S}| = 2)$  (cf. Fig. 14).

2) *Linear Minimum Mean Square Error Estimation (LMMSE) vs. Replica Method Prediction:* For the linear model  $\mathbf{Y} = \Phi \mathbf{X} + \mathbf{W}$  in Section II, the LMMSE estimator is as follows [34]:

$$\hat{\mathbf{x}} = C_{\mathbf{X}} \Phi^T (\Phi C_{\mathbf{X}} \Phi^T + \sigma^2 \mathbf{I})^{-1} (\mathbf{y} - \Phi \bar{\mathbf{x}}) + \bar{\mathbf{x}} l. \quad (154)$$

Here,  $\bar{\mathbf{x}} = \mathbb{E}[\mathbf{X}]$  and  $C_{\mathbf{X}} = \mathbb{E}[(\mathbf{X} - \mathbb{E}[\mathbf{X}])(\mathbf{X} - \mathbb{E}[\mathbf{X}])^T]$ . The error covariance is

$$C_e = C_{\mathbf{X}} - C_{\mathbf{X}} \Phi^T (\Phi C_{\mathbf{X}} \Phi^T + \sigma^2 \mathbf{I})^{-1} \Phi C_{\mathbf{X}}. \quad (155)$$

The average mean square error by LMMSE is  $\frac{1}{n} \text{Tr}(C_e)$ . In this section, we compare the MMSE by replica method and LMMSE for the linear model  $\Phi = \sqrt{s_0} \mathbf{A}$  where  $\mathbf{A}$  are i.i.d. and distributed as  $A_{ij} \stackrel{(d)}{=} \frac{1}{\sqrt{m}} A$ , where  $A \sim \mathcal{N}(0, 1)$ ,  $n = 1000$ , and  $m = \lceil \beta n \rceil$ . Since the LMMSE estimator in (154) is

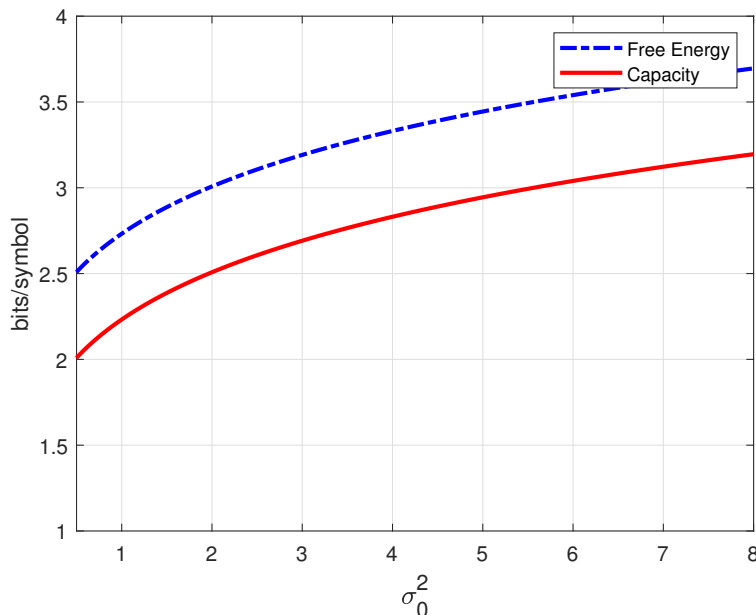

Fig. 13. Free energy and average mutual information as functions of  $\sigma_0^2$  for  $\beta = 1$  and  $|\mathcal{S}| = 2$ .

the MMSE-optimal for the linear model with Gauss-Markov prior, the plot in Fig. 15 shows that our replica prediction is a lower bound on the MMSE for this model.

### C. Hidden Markov Prior

In this section, we estimate free energy and mutual information for the linear model in Section II with hidden Markov sources defined in [23, Sect. 7]. The sequence  $\{X_n\}_{n=1}^{\infty}$  which takes values on  $\mathbb{R}$  is generated via

$$p_{X_n|\Upsilon_n}(x_n | v_n) = v_n \mathcal{N}(x_n; 0, 1) + (1 - v_n) \delta(x_n) \quad (156)$$

$$= \frac{v_n}{\sqrt{2\pi}} \exp\left(-\frac{x_n^2}{2}\right) + (1 - v_n) \delta(x_n) \quad (157)$$

using a time-homogeneous irreducible Markov chain-generated sparsity pattern  $\{\Upsilon_n\}_{n=1}^{\infty}$  on  $\mathcal{S}_\gamma = \{0, 1\}$ . Such a Markov chain is fully described by the following transition stochastic matrix

$$P_\Upsilon = \begin{bmatrix} 1 - \kappa\gamma & \gamma\kappa \\ (1 - \kappa)\gamma & 1 - (1 - \kappa)\gamma \end{bmatrix} \quad (158)$$

for some  $\gamma \in (0, 1]$  called the Markov independence parameter. This irreducible Markov chain yields a stationary distribution with activity rate  $P(\Upsilon_n = 1) = \kappa$  for all  $n \in \mathbb{Z}^+$ .

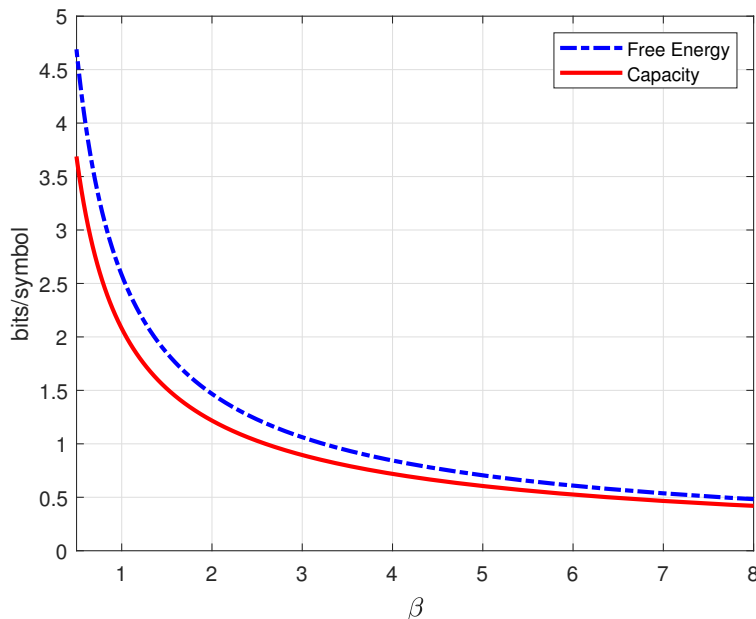

Fig. 14. Free energy and average mutual information as functions of  $\beta$  for  $\sigma_0^2 = 4$  and  $|\mathcal{S}| = 2$ .

1) *Free Energy and Average Mutual Information:* First, it is easy to see that the left Perron-Frobenius eigenvector of the stochastic matrix  $P_\Upsilon$  with unit norm-1 is

$$\lambda_0 = (1 - \kappa, \kappa)^T. \quad (159)$$

Observe that

$$P_{X_1, \Upsilon_1 | X_0, \Upsilon_0}(x_1, v_1 | x_0, v_0) = P_{X|\Upsilon}(x_1 | v_1) \pi_\Upsilon(v_0, v_1) \quad (160)$$

where  $P_{X|\Upsilon}(\cdot|\cdot)$  is the emission probability of the hidden Markov process.

Hence, the left Perron-Frobenius eigenvector of the stochastic matrix  $P_{\pi_\Upsilon, \mathcal{X}}$  in Theorem 21 has the following form:

$$\lambda^{(\pi_\Upsilon)} = ((1 - \kappa)\{l_0(x)\}_{x \in \mathcal{X}}, \kappa\{l_1(x)\}_{x \in \mathcal{X}})^T, \quad (161)$$

where  $l_0 : \mathcal{X} \rightarrow \mathbb{R}_+$  and  $l_1 : \mathcal{X} \rightarrow \mathbb{R}_+$  and

$$\int_{\mathcal{X}} l_i(x) dx = 1, \quad \forall i \in \{0, 1\}. \quad (162)$$

It follows that

$$\int_{\mathcal{X}} \lambda_{x,0}^{(\pi_\Upsilon)} dx = 1 - \kappa, \quad (163)$$

$$\int_{\mathcal{X}} \lambda_{x,1}^{(\pi_\Upsilon)} dx = \kappa. \quad (164)$$



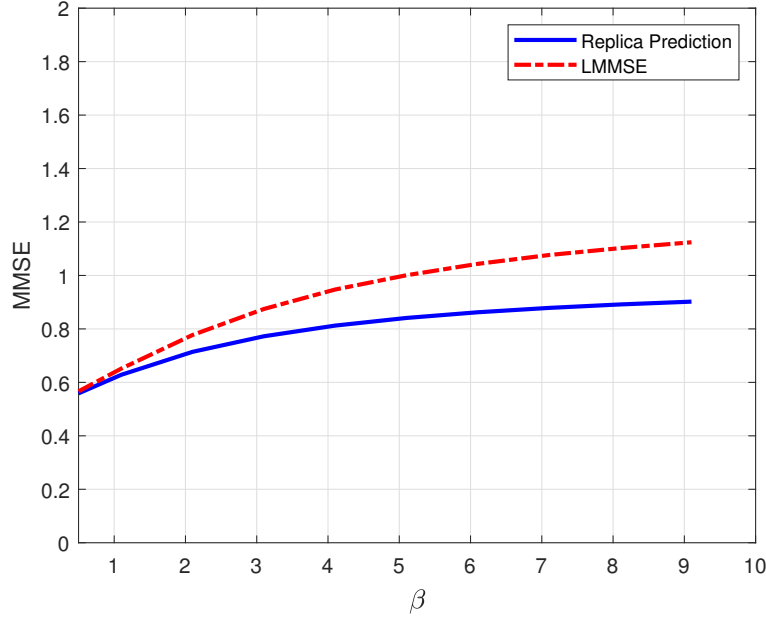

Fig. 15. Replica Prediction and LMMSE

First, we estimate  $\tilde{G}(x_0, 0)$  as a function of  $\kappa, \gamma$ , and  $x_0$  for  $x_0 \in \mathcal{X}$ . We assume that all postulated distributions are the same as their true ones for simplicity. We also assume that  $S = 1$  with probability

1. Now from (49), we have

$$q_0(u, x_0, 0, 1; \eta) = \mathbb{E} \left[ q_{U|X_0, Y_0, X_1, S; \xi}(u | x_0, 0, X, 1; \xi) \middle| S = 1 \right] \quad (165)$$

$$= \mathbb{E} \left[ \sqrt{\frac{\eta}{2\pi}} \exp \left[ -\frac{\eta}{2}(u - X)^2 \right] \middle| X_0 = x_0, Y_0 = 0 \right] \quad (166)$$

$$= \int_{\mathbb{R}} \sum_{v \in \{0,1\}} \sqrt{\frac{\eta}{2\pi}} \exp \left[ -\frac{\eta}{2}(u - x)^2 \right] P_{X_1|Y_1}(x|v) \pi_Y(0, v) dx \quad (167)$$

$$= \int_{\mathbb{R}} \sqrt{\frac{\eta}{2\pi}} \exp \left[ -\frac{\eta}{2}(u - x)^2 \right] \delta(x) \pi_Y(0, 0) dx \\ + \int_{\mathbb{R}} \sqrt{\frac{\eta}{2\pi}} \exp \left[ -\frac{\eta}{2}(u - x)^2 \right] \frac{1}{\sqrt{2\pi}} \exp \left( -\frac{x^2}{2} \right) \pi_Y(0, 1) dx \quad (168)$$

$$= (1 - \gamma\kappa) \int_{\mathbb{R}} \sqrt{\frac{\eta}{2\pi}} \exp \left[ -\frac{\eta}{2}(u - x)^2 \right] \delta(x) dx \\ + \kappa\gamma \int_{\mathbb{R}} \sqrt{\frac{\eta}{2\pi}} \exp \left[ -\frac{\eta}{2}(u - x)^2 \right] \frac{1}{\sqrt{2\pi}} \exp \left( -\frac{x^2}{2} \right) dx \quad (169)$$

$$= (1 - \gamma\kappa) \sqrt{\frac{\eta}{2\pi}} \exp \left[ -\frac{\eta u^2}{2} \right] + \kappa\gamma \sqrt{\frac{\eta}{2\pi(1 + \eta)}} \exp \left( -\frac{\eta u^2}{2(1 + \eta)} \right), \quad (170)$$

which does not depend on  $x_0$ .

Similarly, from (50), for all  $x_0 \in \mathcal{X}$ , we also have

$$q_1(u, x_0, 0, 1; \eta) = \mathbb{E} \left[ \mathbf{X} q_{U|\mathbf{X}_0, \Upsilon_0, \mathbf{X}_1, S; \xi}(u | x_0, 0, \mathbf{X}, 1; \xi) \middle| S = 1 \right] \quad (171)$$

$$= \mathbb{E} \left[ \mathbf{X} \sqrt{\frac{\eta}{2\pi}} \exp \left[ -\frac{\eta}{2}(u - \mathbf{X})^2 \right] \middle| \mathbf{X}_0 = x_0, \Upsilon_0 = 0 \right] \quad (172)$$

$$= \int_{\mathbb{R}} \sum_{v \in \{0,1\}} x \sqrt{\frac{\eta}{2\pi}} \exp \left[ -\frac{\eta}{2}(u - x)^2 \right] P_{\mathbf{X}_1|\Upsilon_1}(x|v) \pi_{\Upsilon}(0, v) dx \quad (173)$$

$$= \int_{\mathbb{R}} \sqrt{\frac{\eta}{2\pi}} x \exp \left[ -\frac{\eta}{2}(u - x)^2 \right] \delta(x) \pi_{\Upsilon}(0, 0) dx \\ + \int_{\mathbb{R}} \sqrt{\frac{\eta}{2\pi}} x \exp \left[ -\frac{\eta}{2}(u - x)^2 \right] \frac{1}{\sqrt{2\pi}} \exp \left( -\frac{x^2}{2} \right) \pi_{\Upsilon}(0, 1) dx \quad (174)$$

$$= (1 - \gamma\kappa) \int_{\mathbb{R}} \sqrt{\frac{\eta}{2\pi}} x \exp \left[ -\frac{\eta}{2}(u - x)^2 \right] \delta(x) dx \\ + \kappa\gamma \int_{\mathbb{R}} \sqrt{\frac{\eta}{2\pi}} x \exp \left[ -\frac{\eta}{2}(u - x)^2 \right] \frac{1}{\sqrt{2\pi}} \exp \left( -\frac{x^2}{2} \right) dx \quad (175)$$

$$= \kappa\gamma \int_{\mathbb{R}} \sqrt{\frac{\eta}{2\pi}} x \exp \left[ -\frac{\eta}{2}(u - x)^2 \right] \frac{1}{\sqrt{2\pi}} \exp \left( -\frac{x^2}{2} \right) dx \quad (176)$$

$$= \kappa\gamma \sqrt{\frac{\eta}{2\pi(1+\eta)}} \exp \left( -\frac{\eta u^2}{2(1+\eta)} \right) \left( \frac{\eta u}{1+\eta} \right). \quad (177)$$

Therefore, from (47), (48), (170), and (177), we have

$$\langle \mathbf{X} | x_0, 0 \rangle_q = \mathbb{E}_q \left[ \mathbf{X} | \mathbf{X}_0 = x_0, \Upsilon_0 = 0, U, 1; \eta \right] \quad (178)$$

$$= \frac{q_1(U, x_0, 0, 1; \eta)}{q_0(U, x_0, 0, 1; \eta)} \quad (179)$$

$$= \frac{\kappa\gamma \sqrt{\frac{\eta}{2\pi(1+\eta)}} \exp \left( -\frac{\eta u^2}{2(1+\eta)} \right) \left( \frac{\eta u}{1+\eta} \right)}{(1 - \gamma\kappa) \sqrt{\frac{\eta}{2\pi}} \exp \left( -\frac{\eta u^2}{2} \right) + \kappa\gamma \sqrt{\frac{\eta}{2\pi(1+\eta)}} \exp \left( -\frac{\eta u^2}{2(1+\eta)} \right)}. \quad (180)$$

It follows from (51) and (52) that

$$\mathcal{V}(1; \eta, \eta | x_0, 0) = \mathcal{E}(1; \eta, \eta | x_0, 0) \quad (181)$$

$$= \mathbb{E} \left[ (\mathbf{X}_1 - \langle \mathbf{X} | x_0, 0 \rangle_q)^2 | \mathbf{X}_0 = x_0, \Upsilon_0 = 0, 1; \eta, \eta \right] \quad (182)$$

$$= \mathbb{E} \left[ \mathbf{X}_1^2 | \mathbf{X}_0 = x_0, \Upsilon_0 = 0, 1; \eta, \eta \right] - \langle \mathbf{X} | \mathbf{X}_0 = x_0, \Upsilon_0 = 0 \rangle_q^2 \quad (183)$$

$$= \int_{\mathbb{R}} \sum_{v \in \{0,1\}} x^2 P_{\mathbf{X}_1|\Upsilon_1}(x|v) \pi_{\Upsilon}(0, v) dx \\ - \left( \frac{\kappa\gamma \sqrt{\frac{\eta}{2\pi(1+\eta)}} \exp \left( -\frac{\eta u^2}{2(1+\eta)} \right) \left( \frac{\eta u}{1+\eta} \right)}{(1 - \gamma\kappa) \sqrt{\frac{\eta}{2\pi}} \exp \left[ -\frac{\eta u^2}{2} \right] + \kappa\gamma \sqrt{\frac{\eta}{2\pi(1+\eta)}} \exp \left( -\frac{\eta u^2}{2(1+\eta)} \right)} \right)^2 \quad (184)$$

$$\begin{aligned}
&= (1 - \kappa\gamma) \int_{\mathbb{R}} x^2 P_{X_1|\Upsilon_1}(x | 0) dx + \kappa\gamma \int_{\mathbb{R}} x^2 P_{X_1|\Upsilon_1}(x | 1) dx \\
&\quad - \left( \frac{\kappa\gamma \sqrt{\frac{\eta}{2\pi(1+\eta)}} \exp\left(-\frac{\eta u^2}{2(1+\eta)}\right) \left(\frac{\eta u}{1+\eta}\right)}{(1 - \gamma\kappa) \sqrt{\frac{\eta}{2\pi}} \exp\left[-\frac{\eta u^2}{2}\right] + \kappa\gamma \sqrt{\frac{\eta}{2\pi(1+\eta)}} \exp\left(-\frac{\eta u^2}{2(1+\eta)}\right)} \right)^2 \tag{185}
\end{aligned}$$

$$\begin{aligned}
&= (1 - \kappa\gamma) \int_{\mathbb{R}} x^2 \delta(x) dx + \kappa\gamma \int_{\mathbb{R}} x^2 \frac{1}{\sqrt{2\pi}} \exp\left(-\frac{x^2}{2}\right) dx \\
&\quad - \left( \frac{\kappa\gamma \sqrt{\frac{\eta}{2\pi(1+\eta)}} \exp\left(-\frac{\eta u^2}{2(1+\eta)}\right) \left(\frac{\eta u}{1+\eta}\right)}{(1 - \gamma\kappa) \sqrt{\frac{\eta}{2\pi}} \exp\left[-\frac{\eta u^2}{2}\right] + \kappa\gamma \sqrt{\frac{\eta}{2\pi(1+\eta)}} \exp\left(-\frac{\eta u^2}{2(1+\eta)}\right)} \right)^2 \tag{186}
\end{aligned}$$

$$= \kappa\gamma - \left( \frac{\kappa\gamma \sqrt{\frac{\eta}{2\pi(1+\eta)}} \exp\left(-\frac{\eta u^2}{2(1+\eta)}\right) \left(\frac{\eta u}{1+\eta}\right)}{(1 - \gamma\kappa) \sqrt{\frac{\eta}{2\pi}} \exp\left(-\frac{\eta u^2}{2}\right) + \kappa\gamma \sqrt{\frac{\eta}{2\pi(1+\eta)}} \exp\left(-\frac{\eta u^2}{2(1+\eta)}\right)} \right)^2, \tag{187}$$

which does not depend on  $x_0$ .

Similarly, by symmetry, we also have

$$\mathcal{V}(1; \eta, \eta | x_0, 1) = \mathcal{E}(1; \eta, \eta | x_0, 1) \tag{188}$$

$$= 1 - (1 - \kappa)\gamma - \mathbb{E} \left[ \left( \frac{(1 - (1 - \kappa)\gamma) \sqrt{\frac{\eta}{2\pi(1+\eta)}} \exp\left(-\frac{\eta U^2}{2(1+\eta)}\right) \left(\frac{\eta U}{1+\eta}\right)}{(1 - \gamma)\kappa \sqrt{\frac{\eta}{2\pi}} \exp\left(-\frac{\eta U^2}{2}\right) + (1 - (1 - \kappa)\gamma) \sqrt{\frac{\eta}{2\pi(1+\eta)}} \exp\left(-\frac{\eta U^2}{2(1+\eta)}\right)} \right)^2 \right], \tag{189}$$

which holds for any  $x_0 \in \mathcal{X}$ .

Now, by (47), the single-symbol PME for this special case is

$$U = X_1 + \frac{1}{\sqrt{\eta}} W. \tag{190}$$

Observe that

- Under the condition  $\Upsilon_0 = 0$ , we have

$$P_{X_1}(x) = \sum_{v \in \{0,1\}} P_{X_1|\Upsilon_1}(x | v) \pi_{\Upsilon}(0, v) \tag{191}$$

$$= (1 - \kappa\gamma) \delta(x) + \frac{\kappa\gamma}{\sqrt{2\pi}} \exp\left(-\frac{x^2}{2}\right). \tag{192}$$

It follows that:

$$F_U(u) = \mathbb{P}(U \leq u) \quad (193)$$

$$= \int_{\mathbb{R}} \mathbb{P}(U \leq u | X_1 = x) P_{X_1}(x) dx \quad (194)$$

$$= \int_{\mathbb{R}} \mathbb{P}(W \leq (u-1)\sqrt{\eta}) P_{X_1}(x) dx \quad (195)$$

$$= (1 - \kappa\gamma) \int_{\mathbb{R}} \mathbb{P}(W \leq (u-x)\sqrt{\eta}) \delta(x) dx + \kappa\gamma \int_{\mathbb{R}} \mathbb{P}(W \leq (u-x)\sqrt{\eta}) \frac{1}{\sqrt{2\pi}} \exp\left(-\frac{x^2}{2}\right) dx \quad (196)$$

$$= (1 - \kappa\gamma) \int_{\mathbb{R}} \Phi((u-x)\sqrt{\eta}) \delta(x) dx + \frac{\kappa\gamma}{2\pi} \int_{-\infty}^{\infty} \int_{-\infty}^{(u-x)\sqrt{\eta}} \exp\left(-\frac{x^2+t^2}{2}\right) dt dx \quad (197)$$

$$= (1 - \kappa\gamma) \Phi(u\sqrt{\eta}) + \frac{\kappa\gamma}{2\pi} \int_{-\infty}^{\infty} \int_{-\infty}^{(u-x)\sqrt{\eta}} \exp\left(-\frac{x^2+t^2}{2}\right) dt dx \quad (198)$$

where  $\Phi(x) := \frac{1}{\sqrt{2\pi}} \int_{-\infty}^x \exp(-t^2/2) dt$ . From (198), we obtain<sup>9</sup>

$$f_U^{(\text{HM},1)}(u) = \frac{(1 - \gamma\kappa)\sqrt{\eta}}{\sqrt{2\pi}} \exp\left(-\frac{u^2\eta}{2}\right) + \frac{\kappa\gamma\sqrt{\eta}}{2\pi} \int_{\mathbb{R}} \exp\left(-\frac{x^2 + (u-x)^2\eta}{2}\right) dx \quad (199)$$

$$= (1 - \gamma\kappa) \sqrt{\frac{\eta}{2\pi}} \exp\left(-\frac{u^2\eta}{2}\right) + \kappa\gamma \sqrt{\frac{\eta}{2\pi(1+\eta)}} \exp\left(-\frac{u^2\eta}{2(1+\eta)}\right). \quad (200)$$

- Similarly, under the condition  $\Upsilon_0 = 1$ , we have

$$f_U^{(\text{HM},2)}(u) = (1 - \kappa)\gamma \sqrt{\frac{\eta}{2\pi}} \exp\left(-\frac{u^2\eta}{2}\right) + (1 - (1 - \kappa)\gamma) \sqrt{\frac{\eta}{2\pi(1+\eta)}} \exp\left(-\frac{u^2\eta}{2(1+\eta)}\right). \quad (201)$$

Hence, from (55),  $\eta$  is a solution of the following equation

$$\eta^{-1} = 1 + \beta \left( \int_{\mathcal{X}} \lambda_{x,0}^{(\pi\tau)} \mathbb{E}[1\mathcal{E}(1; \eta, \eta|x, 0)] dx + \int_{\mathcal{X}} \lambda_{x,1}^{(\pi\tau)} \mathbb{E}[1\mathcal{E}(1; \eta, \eta|x, 1)] dx \right), \quad (202)$$

$$= 1 + \beta \left( \int_{\mathcal{X}} \lambda_{x,0}^{(\pi\tau)} dx \right) \left( \gamma\kappa - \mathbb{E} \left[ \left( \frac{\kappa\gamma \sqrt{\frac{\eta}{2\pi(1+\eta)}} \exp\left(-\frac{\eta U^2}{2(1+\eta)}\right) \left(\frac{\eta U}{1+\eta}\right)}{(1 - \gamma\kappa) \sqrt{\frac{\eta}{2\pi}} \exp\left(-\frac{\eta U^2}{2}\right) + \kappa\gamma \sqrt{\frac{\eta}{2\pi(1+\eta)}} \exp\left(-\frac{\eta U^2}{2(1+\eta)}\right)} \right)^2 \right] \right) \\ + \beta \left( \int_{\mathcal{X}} \lambda_{x,1}^{(\pi\tau)} dx \right) \\ \times \left( 1 - (1 - \kappa)\gamma - \mathbb{E} \left[ \left( \frac{(1 - (1 - \kappa)\gamma) \sqrt{\frac{\eta}{2\pi(1+\eta)}} \exp\left(-\frac{\eta U^2}{2(1+\eta)}\right) \left(\frac{\eta U}{1+\eta}\right)}{(1 - \kappa)\gamma \sqrt{\frac{\eta}{2\pi}} \exp\left(-\frac{\eta U^2}{2}\right) + (1 - (1 - \kappa)\gamma) \sqrt{\frac{\eta}{2\pi(1+\eta)}} \exp\left(-\frac{\eta U^2}{2(1+\eta)}\right)} \right)^2 \right] \right) \quad (203)$$

<sup>9</sup>We can derive it use the convolution since  $W$  and  $X_1$  are independent random variables.

$$\begin{aligned}
&= 1 + \beta(1 - \kappa) \left( \gamma\kappa - \mathbb{E} \left[ \left( \frac{\kappa\gamma\sqrt{\frac{\eta}{2\pi(1+\eta)}} \exp\left(-\frac{\eta U^2}{2(1+\eta)}\right) \left(\frac{\eta U}{1+\eta}\right)}{\left(1 - \gamma\kappa\right)\sqrt{\frac{\eta}{2\pi}} \exp\left(-\frac{\eta U^2}{2}\right) + \kappa\gamma\sqrt{\frac{\eta}{2\pi(1+\eta)}} \exp\left(-\frac{\eta U^2}{2(1+\eta)}\right)} \right)^2 \right] \right) \\
&+ \beta\kappa \left( 1 - (1 - \kappa)\gamma - \mathbb{E} \left[ \left( \frac{(1 - (1 - \kappa)\gamma)\sqrt{\frac{\eta}{2\pi(1+\eta)}} \exp\left(-\frac{\eta U^2}{2(1+\eta)}\right) \left(\frac{\eta U}{1+\eta}\right)}{\left(1 - \kappa\right)\gamma\sqrt{\frac{\eta}{2\pi}} \exp\left(-\frac{\eta U^2}{2}\right) + (1 - (1 - \kappa)\gamma)\sqrt{\frac{\eta}{2\pi(1+\eta)}} \exp\left(-\frac{\eta U^2}{2(1+\eta)}\right)} \right)^2 \right] \right),
\end{aligned} \tag{204}$$

where (204) follows from (163) and (164).

Now, since  $S = 1, \xi = \eta, \sigma = 1, \tilde{\pi}_\Upsilon = \pi_\Upsilon$ , from (53), we have

$$\begin{aligned}
\tilde{G}(x_0, 0) \Big|_{\sigma=1, \tilde{\pi}_\Upsilon=\pi_\Upsilon} &= - \int p_{U|X_0, \Upsilon_0, S; \eta}(u | x_0, 0, 1; \eta) \log p_{U|X_0, \Upsilon_0, S; \eta}(u | x_0, 0, 1; \eta) du \\
&+ \frac{1}{2\beta} \left[ (\eta - 1) \log e - \log \eta \right] - \frac{1}{2} \log \frac{2\pi}{\eta} - \frac{1}{2} \log e \\
&+ \frac{1}{2\beta} \log(2\pi) + \frac{1}{2\beta} \log e.
\end{aligned} \tag{205}$$

On the other hand,

$$p_{U|X_0, \Upsilon_0, 1; \eta}(u | x_0, 0, 1; \eta) = \int_{\mathbb{R}} p_{U|X_0, \Upsilon_0, X_1, 1; \eta}(u | x_0, 0, x, 1; \eta) P_{X_1|X_0, \Upsilon_0}(x | x_0, 0) dx \tag{206}$$

$$= \int_{\mathbb{R}} \sqrt{\frac{\eta}{2\pi}} \exp\left[-\frac{\eta}{2}(u-x)^2\right] \left( \sum_{v \in \{0,1\}} p_{X_1|X_0, \Upsilon_0}(x | x_0, 0) \right) dx \tag{207}$$

$$= \int_{\mathbb{R}} \sqrt{\frac{\eta}{2\pi}} \exp\left[-\frac{\eta}{2}(u-x)^2\right] \left( \sum_{v \in \{0,1\}} p_{X_1|\Upsilon_1}(x | v) \pi_\Upsilon(0, v) \right) dx \tag{208}$$

$$= (1 - \kappa\gamma) \int_{\mathbb{R}} \sqrt{\frac{\eta}{2\pi}} \exp\left[-\frac{\eta}{2}(u-x)^2\right] \delta(x) dx \tag{209}$$

$$+ \kappa\gamma \int_{\mathbb{R}} \sqrt{\frac{\eta}{2\pi}} \exp\left[-\frac{\eta}{2}(u-x)^2\right] \frac{1}{\sqrt{2\pi}} \exp\left(-\frac{x^2}{2}\right) dx \tag{210}$$

$$= (1 - \kappa\gamma) \sqrt{\frac{\eta}{2\pi}} \exp\left[-\frac{\eta u^2}{2}\right] + \kappa\gamma \sqrt{\frac{\eta}{2\pi(1+\eta)}} \exp\left[-\frac{\eta u^2}{2(1+\eta)}\right], \tag{211}$$

which does not depend on  $x_0$ .

It follows that

$$\tilde{G}(x_0, 0) \Big|_{S=1, \sigma=1, \tilde{\pi}_\Upsilon=\pi_\Upsilon} = \hat{G}(0, \eta, \kappa, \gamma), \quad \forall x_0 \in \mathcal{X}, \tag{212}$$

where

$$\begin{aligned}
\hat{G}(0, \eta, \kappa, \gamma) &:= - \int_{-\infty}^{\infty} \left( (1 - \kappa\gamma) \sqrt{\frac{\eta}{2\pi}} \exp \left[ -\frac{\eta u^2}{2} \right] + \kappa\gamma \sqrt{\frac{\eta}{2\pi(1+\eta)}} \exp \left[ -\frac{\eta u^2}{2(1+\eta)} \right] \right) \\
&\quad \times \log \left( (1 - \kappa\gamma) \sqrt{\frac{\eta}{2\pi}} \exp \left[ -\frac{\eta u^2}{2} \right] + \kappa\gamma \sqrt{\frac{\eta}{2\pi(1+\eta)}} \exp \left[ -\frac{\eta u^2}{2(1+\eta)} \right] \right) du \\
&\quad + \frac{1}{2\beta} \left[ (\eta - 1) \log e - \log \eta \right] - \frac{1}{2} \log \frac{2\pi}{\eta} - \frac{1}{2} \log e \\
&\quad + \frac{1}{2\beta} \log(2\pi) + \frac{1}{2\beta} \log e.
\end{aligned} \tag{213}$$

By the symmetry, it is not hard to see that

$$\tilde{G}(x_0, 1) \Big|_{S=1, \sigma=1, \tilde{\pi}_\Upsilon=\pi_\Upsilon} = \hat{G}(1, \eta, \kappa, \gamma), \quad \forall x_0 \in \mathcal{X}, \tag{214}$$

where

$$\begin{aligned}
\hat{G}(1, \eta, \kappa, \gamma) &:= - \int_{-\infty}^{\infty} \left( (1 - \kappa)\gamma \sqrt{\frac{\eta}{2\pi}} \exp \left[ -\frac{\eta u^2}{2} \right] + (1 - (1 - \kappa)\gamma) \sqrt{\frac{\eta}{2\pi(1+\eta)}} \exp \left[ -\frac{\eta u^2}{2(1+\eta)} \right] \right) \\
&\quad \times \log \left( (1 - \kappa)\gamma \sqrt{\frac{\eta}{2\pi}} \exp \left[ -\frac{\eta u^2}{2} \right] + (1 - (1 - \kappa)\gamma) \sqrt{\frac{\eta}{2\pi(1+\eta)}} \exp \left[ -\frac{\eta u^2}{2(1+\eta)} \right] \right) du \\
&\quad + \frac{1}{2\beta} \left[ (\eta - 1) \log e - \log \eta \right] - \frac{1}{2} \log \frac{2\pi}{\eta} - \frac{1}{2} \log e \\
&\quad + \frac{1}{2\beta} \log(2\pi) + \frac{1}{2\beta} \log e.
\end{aligned} \tag{215}$$

Now, let  $\hat{C}_\beta(\kappa, \gamma)$  is the set of all solutions  $\eta$  of equation (204) given  $\beta$  and  $\kappa$  and  $\gamma$ .

From Theorem 21 and (163) and (164), we have

$$\mathcal{F} \Big|_{S=1, \sigma=1, \tilde{\pi}_\Upsilon=\pi_\Upsilon} = \min_{\eta \in \hat{C}_\beta(\kappa, \gamma)} \left[ \int_{\mathcal{X}} \lambda_{x,0}^{(\pi_\Upsilon)} \tilde{G}(x, 0) dx + \int_{\mathcal{X}} \lambda_{x,1}^{(\pi_\Upsilon)} \tilde{G}(x, 1) dx \right] \tag{216}$$

$$= \min_{\eta \in \hat{C}_\beta(\kappa, \gamma)} \left[ (1 - \kappa) \hat{G}(0, \eta, \kappa, \gamma) + \kappa \hat{G}(1, \eta, \kappa, \gamma) \right]. \tag{217}$$

Solving the optimization problems in (204) is very challenging. However, by observing that given  $\kappa$  and  $\gamma$ ,  $\beta$ ,  $\hat{G}(0, \eta, \kappa, \gamma)$  and  $\hat{G}(1, \eta, \kappa, \gamma)$  are functions of  $\eta$ . Hence, we can plot lower and upper bounds for the free energy  $\mathcal{F}$  and the average mutual information as functions of  $(\kappa, \gamma)$ . In Fig. 16, we plot the free energy and the average mutual information for  $\kappa = 0.5$  and  $\gamma = 1$ , i.e., the sequence  $\{X_n\}_{n=1}^{\infty}$  is i.i.d. generated.

For the non-symmetric case where  $\kappa = 0.3$  and  $\gamma = 0.8$ , we obtain the free energy and the average mutual information as in Fig. 17.

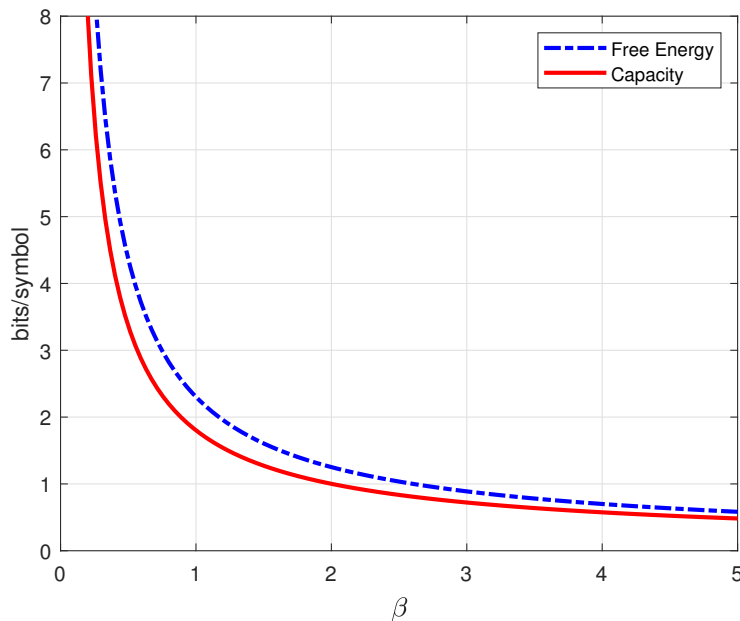

Fig. 16. Free energy and average mutual information as functions of  $\beta$  for the symmetric i.i.d. case  $\lambda = 0.5$  and  $\gamma = 1$ .

2) *Approximate Message Passing Algorithm vs. Replica Prediction:* As in Section IV-C1, we consider the linear model in Section II with hidden Markov sources defined in [23, Sect. 7]. Observe that

$$\begin{aligned} & \mathbb{E} \left[ X_1^2 \middle| X_0 = x_0, \Upsilon_0 = v_0 \right] \\ &= \int_{\mathbb{R}} \sum_{v \in \{0,1\}} x^2 P_{X_1, \Upsilon_1 | X_0, \Upsilon_0}(x, v | x_0, v_0) dx \end{aligned} \quad (218)$$

$$= \sum_{v \in \{0,1\}} \int_{\mathbb{R}} x^2 P_{X_1 | \Upsilon_1}(x | v) \pi_{\Upsilon}(v_0, v) dx \quad (219)$$

$$= \int_{\mathbb{R}} x^2 \delta(x) \pi_{\Upsilon}(v_0, 0) dx + \int_{\mathbb{R}} x^2 \frac{1}{\sqrt{2\pi}} \exp\left(-\frac{x^2}{2}\right) \pi_{\Upsilon}(v_0, 1) dx \quad (220)$$

$$= \pi_{\Upsilon}(v_0, 1). \quad (221)$$

Hence, we have

$$\mathbb{E}[X_1^2] = \mathbb{E} \left[ \mathbb{E} \left[ X_1^2 \middle| X_0, \Upsilon_0 \right] \right] \quad (222)$$

$$= \mathbb{E}[\pi_{\Upsilon}(\Upsilon_0, 1)] \quad (223)$$

$$= P_{\Upsilon}(0) \pi_{\Upsilon}(0, 1) + P_{\Upsilon}(1) \pi_{\Upsilon}(1, 1) \quad (224)$$

$$= (1 - \kappa) \kappa \gamma + \kappa (1 - (1 - \kappa) \gamma) \quad (225)$$

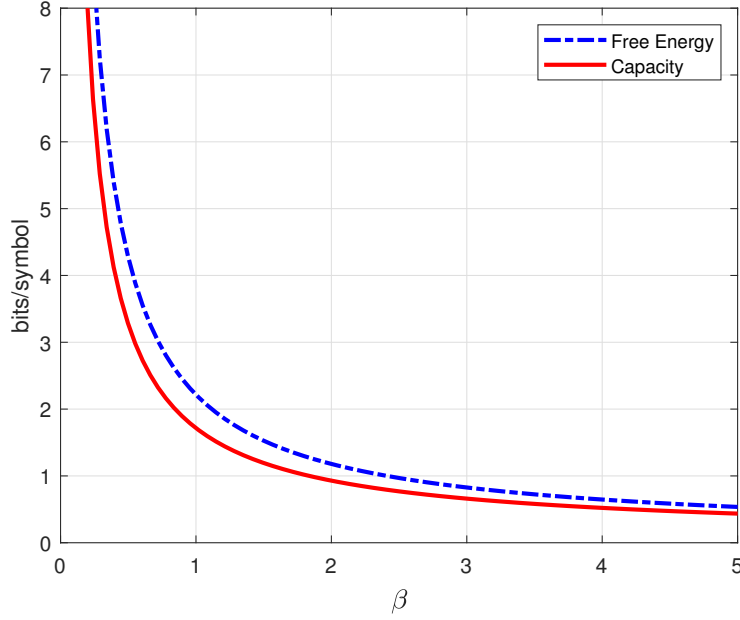

Fig. 17. Free energy and average mutual information as functions of  $\beta$  for the non-symmetric case  $\lambda = 0.3$  and  $\gamma = 0.8$ .

$$= \kappa. \quad (226)$$

On the other hand, given  $\Upsilon_0 = 0$ , for any  $x_0 \in \mathcal{X}$ , we also have

$$\mathbb{E}[\langle X_1 | X_0 = x_0, \Upsilon_0 = 0 \rangle^2] = \mathbb{E}[X_1^2 | X_0 = x_0, \Upsilon_0 = 0] - \mathbb{E}[(X_1 - \langle X_1 | X_0 = x_0, \Upsilon_0 \rangle)^2 | X_0 = x_0, \Upsilon_0 = 0] \quad (227)$$

$$= \pi_{\Upsilon}(0, 1) - \mathbb{E}[\mathcal{E}(1; \eta, \eta | x_0, 0)] \quad (228)$$

$$= \kappa\gamma - \mathbb{E}[\mathcal{E}(1; \eta, \eta | x_0, 0)] \quad (229)$$

$$= \mathbb{E} \left[ \left( \frac{\kappa\gamma \sqrt{\frac{\eta}{2\pi(1+\eta)}} \exp\left(-\frac{\eta U^2}{2(1+\eta)}\right) \left(\frac{\eta U}{1+\eta}\right)}{\left( (1-\gamma\kappa) \sqrt{\frac{\eta}{2\pi}} \exp\left(-\frac{\eta U^2}{2}\right) + \kappa\gamma \sqrt{\frac{\eta}{2\pi(1+\eta)}} \exp\left(-\frac{\eta U^2}{2(1+\eta)}\right) \right)} \right)^2 \right] := R_1 \quad (230)$$

which does not depend on  $x_0$ , where (230) follows from (187). Here, the expectation in (230) is taken over  $U$  with distribution (cf. (200))

$$f_U^{(\text{HM},1)}(u) = \frac{(1-\gamma\kappa)\sqrt{\eta}}{\sqrt{2\pi}} \exp\left(-\frac{u^2\eta}{2}\right) + \frac{\kappa\gamma\sqrt{\eta}}{2\pi} \int_{\mathbb{R}} \exp\left(-\frac{x^2 + (u-x)^2\eta}{2}\right) dx \quad (231)$$

$$= (1-\gamma\kappa)\sqrt{\frac{\eta}{2\pi}} \exp\left(-\frac{u^2\eta}{2}\right) + \kappa\gamma\sqrt{\frac{\eta}{2\pi(1+\eta)}} \exp\left(-\frac{u^2\eta}{2(1+\eta)}\right). \quad (232)$$



Similarly, by symmetry, given  $\Upsilon_0 = 1$ , for any  $x_0 \in \mathcal{X}$ , we also have:

$$\mathbb{E}[\langle \mathbf{X}_1 | \mathbf{X}_0 = 1, \Upsilon_0 = 1 \rangle^2] = \mathbb{E}[\mathbf{X}_1^2 | \mathbf{X}_0 = 1, \Upsilon_0 = 1] - \mathbb{E}[(\mathbf{X}_1 - \langle \mathbf{X}_1 | \mathbf{X}_0 = 1 \rangle)^2 | \mathbf{X}_0 = 1, \Upsilon_0 = 1] \quad (233)$$

$$= 1 - (1 - \kappa)\gamma - \mathbb{E}\left[\mathcal{E}(1; \eta, \eta | 1, 1)\right] \quad (234)$$

$$= \mathbb{E}\left[\left(\frac{(1 - (1 - \kappa)\gamma)\sqrt{\frac{\eta}{2\pi(1+\eta)}} \exp\left(-\frac{\eta U^2}{2(1+\eta)}\right) \left(\frac{\eta U}{1+\eta}\right)}{(1 - \kappa)\gamma\sqrt{\frac{\eta}{2\pi}} \exp\left(-\frac{\eta U^2}{2}\right) + (1 - (1 - \kappa)\gamma)\sqrt{\frac{\eta}{2\pi(1+\eta)}} \exp\left(-\frac{\eta U^2}{2(1+\eta)}\right)}\right)^2\right] := R_2 \quad (235)$$

which does not depend on  $x_0$ , where the expectation is taken over  $U$  with distribution (cf. (201))

$$f_U^{(\text{HM},2)}(u) = (1 - \kappa)\gamma\sqrt{\frac{\eta}{2\pi}} \exp\left(-\frac{u^2\eta}{2}\right) + (1 - (1 - \kappa)\gamma)\sqrt{\frac{\eta}{2\pi(1+\eta)}} \exp\left(-\frac{u^2\eta}{2(1+\eta)}\right). \quad (236)$$

Hence, from (226), (230), and (235), we obtain from Theorem 21 that

$$\text{MMSE}_{\text{HM}} := \lim_{n \rightarrow \infty} \frac{1}{n} \mathbb{E}[\|\mathbf{X} - \langle \mathbf{X} \rangle\|_2^2] \quad (237)$$

$$= \kappa - \left[ \left( \int_{\mathcal{X}} \lambda_{x,0}^{(\pi_\tau)} \right) R_1 + \left( \int_{\mathcal{X}} \lambda_{x,1}^{(\pi_\tau)} \right) R_2 \right] \quad (238)$$

$$= \kappa - ((1 - \kappa)R_1 + \kappa R_2), \quad (239)$$

where  $R_1$  and  $R_2$  are defined in (230) and (235), respectively. Here, (239) follows from (163) and (164).

In this section, we compare the MMSE in Theorem 21 with the MSE achieved by the AMP algorithm in [23] for  $n = 1000$  (signal dimension) and  $m = \lceil \frac{n}{\beta} \rceil$  (observations). We assume that  $S = 1$  and  $A$  is a random matrix where each element is normal distributed  $\mathcal{N}(0, 1)$  as the Rayleigh fading model. However, this algorithm assumes some level of sparsity in signal  $\mathbf{X}$ . Before introducing the algorithm, we define some new functions:

$$\alpha_l(c) = \frac{1}{c+1}, \quad (240)$$

$$\beta_l(c) = \left(\frac{1-\kappa}{\kappa}\right) \left(\frac{c+1}{c}\right), \quad (241)$$

$$\zeta_l(c) = \frac{1}{c(c+1)}, \quad (242)$$

$$F_l(\theta; c) = \frac{\alpha_l(c)\theta}{1 + \beta_n(c)e^{-\zeta_l(c)|\theta|^2}}, \quad (243)$$

$$G_l(\theta; c) = \beta_n(c)e^{-\zeta_n(c)|\theta|^2} |F_n(\theta; c)|^2 + \frac{c}{\theta} F_l(\theta; c) \quad (244)$$

$$F'_l(\theta; c) = \frac{\alpha_l(c)}{1 + \beta_l(c)e^{-\zeta_l(c)|\theta|^2}} \left[ 1 + \frac{\zeta_l(c)|\theta|^2}{1 + (\beta_l(c)e^{-\zeta_l(c)|\theta|^2})^{-1}} \right], \quad \forall l \in \{1, 2, \dots, n\}. \quad (245)$$

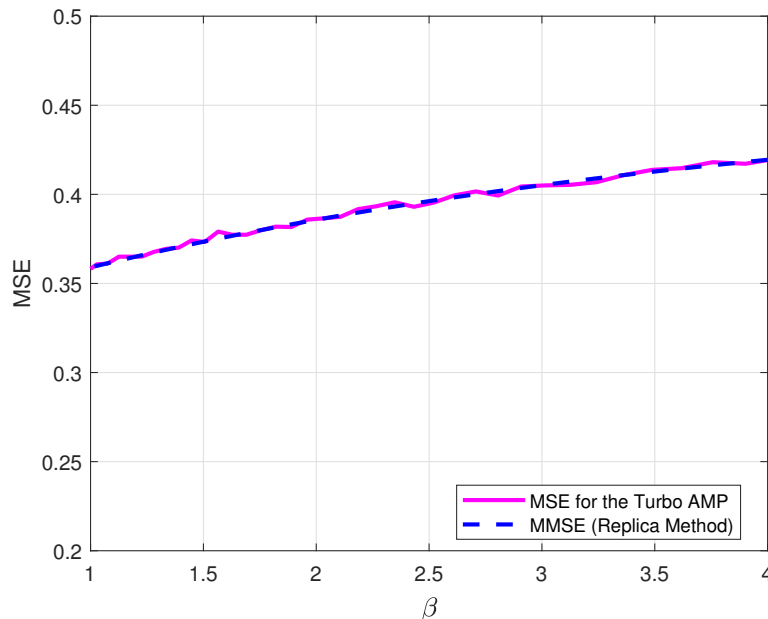

Fig. 18. MSE by Turbo AMP algorithm and MMSE by the Replica Method as functions of  $\beta$  for the symmetric case  $\kappa = 0.5, \gamma = 1$ , i.e.,  $\{X_n\}_{n=1}^{\infty}$  is an i.i.d. sequence.

We call this algorithm Turbo AMP since it is based on an approximation of a loopy BP which has demonstrated very accurate results in LDPC and Turbo decoding [23]. The algorithm for our setting is as follows:

1) Initialize

$$c^0 = 10; \quad \mu_l^0 = 0 \quad \forall l \in \{1, 2, \dots, n\}; \quad z_k^0 = y_k \quad \forall k \in \{1, 2, \dots, m\}. \quad (246)$$

2) Repeat the following for all  $i = 0, 1, 2, \dots$  (we use 10 iterations in our simulations):

$$\theta_l^i = \frac{1}{\sqrt{n}} \sum_{k=1}^m A_{kl} z_k^i + \mu_l^i, \quad \forall l \in \{1, 2, \dots, n\}, \quad (247)$$

$$\mu_l^{i+1} = F_l(\theta_l^i; c^i), \quad \forall l \in \{1, 2, \dots, n\}, \quad (248)$$

$$v_l^{i+1} = G_l(\theta_l^i; c^i), \quad \forall l \in \{1, 2, \dots, n\}, \quad (249)$$

$$c^{i+1} = 1 + \frac{\beta}{n} \sum_{l=1}^n v_l^{i+1}, \quad (250)$$

$$z_k^{i+1} = y_k - \sum_{l=1}^n A_{kl} \mu_l^{i+1} + \frac{z_k^i}{m} \sum_{l=1}^n F_l'(\theta_l^i; c^i), \quad \forall k \in \{1, 2, \dots, m\}. \quad (251)$$

Our obtained results are as follows.

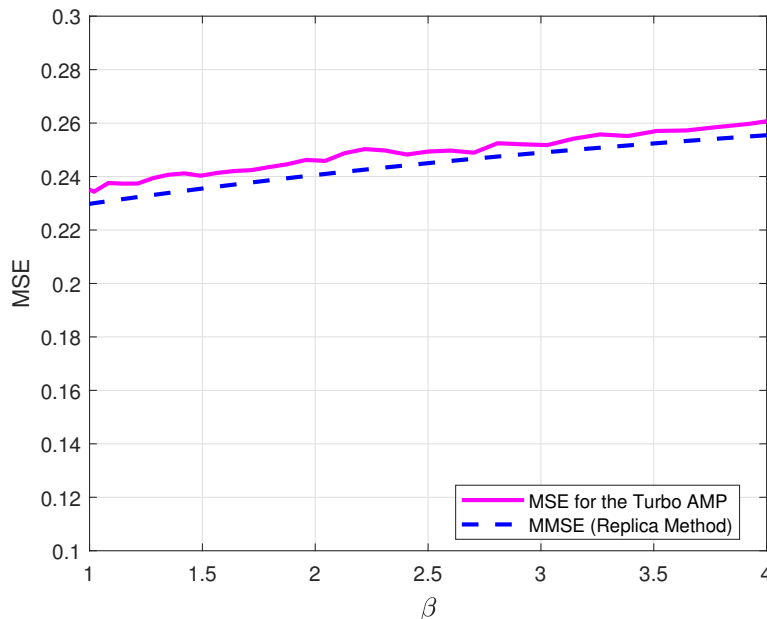

Fig. 19. MSE by Turbo AMP algorithm and MMSE by the Replica Method as functions of  $\beta$  for the asymmetric case  $\kappa = 0.3$  and  $\gamma = 0.8$ .

- For the symmetric case  $\kappa = 0.5$  and  $\gamma = 1$ , the Markov model in Section II becomes the linear model in [4, Sect. II] with i.i.d. sequence  $\{X_n\}_{n=1}^{\infty}$ . Fig. 18 shows that the AMP works well for this case. The gap between the MSE of AMP and the MSE of the Replica Method in Theorem 21 is very small.
- For the non-symmetric case  $\kappa = 0.3$  and  $\gamma = 0.8$ , the Markov model in Section II is very different from the linear model in [4, Sect. II] with i.i.d. sequence  $\{X_n\}_{n=1}^{\infty}$ . However, Fig. 19 shows that the AMP also works well for this case. The gap between the MSE of AMP and the upper bound of MSE by using the Replica Method in Theorem 21 is also very small. This can be explained by the fact that Turbo AMP exploits the Markov structure of the sequence  $\{X_n\}_{n=1}^{\infty}$  very well. More specially, this algorithm makes use of the knowledge of the stationary distribution (i.e.,  $1 - \kappa, \kappa$ ) in its algorithm.

## V. PROOFS OF MAIN RESULTS

This section proves Claims 1–3 using the replica method. We first state some related lemmas which are required to estimate the free energy of the linear model with Markov sources. Then, we obtain the joint moments for the linear model with Markov sources. Finally, we obtain the free energy and joint

moments for the linear model with hidden Markov sources based on the results of the linear model with Markov sources.

**Lemma 5.** [4, p. 1998] Let  $X_n^{(a)}$  be replicated vectors with distribution  $q_{\mathbf{X}}$ . Define a sequence of  $(\nu + 1) \times (\nu + 1)$  random matrices  $\{\mathbf{Q}_n\}_{n=1}^{\infty}$  such that

$$Q_n^{(a,b)} = S_n X_n^{(a)} X_n^{(b)} \quad (252)$$

for all  $a \in [\nu]$  and  $b \in [\nu]$  for all  $n = 1, 2, \dots$ . Let

$$\mathbf{T}_n = \frac{1}{n} \sum_{k=1}^n \mathbf{Q}_k, \quad n = 1, 2, \dots \quad (253)$$

Then, the following holds:

$$\frac{1}{n} \log \mathbb{E}[Z^\nu(\mathbf{Y}, \Phi)] = \frac{1}{n} \log \mathbb{E} \left\{ \exp \left[ m \left( G^{(\nu)}(\mathbf{T}_n) + O(n^{-1}) \right) \right] \right\}, \quad (254)$$

where

$$G^{(\nu)}(Q) := -\frac{1}{2} \log \det(I + \Sigma Q) - \frac{1}{2} \log \left( 1 + \frac{\nu}{\sigma^2} \right) - \frac{\nu}{2} \log(2\pi\sigma^2), \quad (255)$$

and  $\Sigma$  is a  $(\nu + 1) \times (\nu + 1)$  matrix

$$\Sigma = \frac{\beta}{\sigma^2 + \nu} \begin{bmatrix} \nu & -e^T \\ -e & (1 + \frac{\nu}{\sigma^2})I - \frac{1}{\sigma^2}ee^T \end{bmatrix}, \quad (256)$$

where  $e$  is a  $\nu \times 1$  column vector whose entries are all 1.

The following two lemmas state some new results on large deviations for Markov chains induced by the channel setting. The proofs of these results can be found in Appendix A.

**Lemma 6.** Let  $\{S_n\}_{n=1}^{\infty}$  be an i.i.d. sequence of random variable on a finite set  $\mathcal{S} \subset \mathbb{R}^+$ . Let  $\mathbf{X} := \{X_n\}_{n=1}^{\infty}$  be a Markov chain with states on a Polish space  $\mathcal{X}$  with the transition matrix  $P = \{P_{i,j}\}_{i,j \in \mathcal{X}}$ . Assume this Markov chain is irreducible. Set  $\mathbf{X}^{(0)} = \mathbf{X}$ . Let  $\mathbf{X}^{(a)} := \{X_n^{(a)}\}_{n=1}^{\infty}$  be a set of  $\nu$  replica sequences with (postulated) distribution  $q_{\mathbf{X}}$  for each  $a = 1, 2, \dots, \nu$ . This means that

$$p_{\mathbf{X}^{(0)} \mathbf{X}^{(1)} \mathbf{X}^{(2)} \dots \mathbf{X}^{(\nu)}}(x^{(0)}, x^{(1)}, x^{(2)}, \dots, x^{(\nu)}) \sim p_{\mathbf{X}}(x^{(0)}) \prod_{i=1}^{\nu} q_{\mathbf{X}}(x^{(i)}). \quad (257)$$

Define a new sequence of  $(\nu + 1) \times (\nu + 1)$  random matrices  $\{\mathbf{Q}_n\}_{n=1}^{\infty}$  such that

$$Q_n^{(a,b)} = S_n X_n^{(a)} X_n^{(b)} \quad (258)$$

for all  $a \in [\nu]$  and  $b \in [\nu]$  and for all  $n = 1, 2, \dots$ . Then,  $\{\mathbf{Q}_n\}_{n=1}^{\infty}$  is also an irreducible Markov chain with states on  $\mathcal{Q}$ .

**Lemma 7.** Let  $\mathcal{X}$  be a Polish space with finite cardinality and a irreducible Markov chain  $\mathbf{X} := \{X_n\}_{n=1}^\infty$  defined on  $\mathcal{X}$  and  $\nu$  be a positive integer number. Let  $X_n^{(a)}$  for  $a \in \{1, 2, \dots, \nu\}$  be replicas of the Markov process  $\mathbf{X}$ . Recall the definition of the sequence  $\mathbf{Q}_n$  in Lemma 6 and  $\mathbf{T}_n = \frac{1}{n} \sum_{j=1}^n \mathbf{Q}_j$ . Let  $P_n(U) := \mathbb{P}(\mathbf{T}_n \in U)$  for any measurable set  $U$  on the  $\sigma$ -algebra generated by  $\{\mathbf{Q}_n\}_{n=1}^\infty$ . Then, for and bounded and continuous function  $F : \mathcal{Q} \rightarrow \mathbf{R}$

$$\lim_{n \rightarrow \infty} \frac{1}{n} \log \mathbb{E}[e^{nF(\mathbf{T}_n)}] = \lim_{n \rightarrow \infty} \frac{1}{n} \log \int e^{nF(Q)} dP_n(Q) \quad (259)$$

$$= \sup_Q \left[ F(Q) - I(Q) \right] \quad (260)$$

where  $I(Q) = \sup_{\tilde{Q}} (\text{tr}(\tilde{Q}Q) - \log \rho(P_{\tilde{Q}}))$  and  $\rho(P_{\tilde{Q}})$  is the Perron-Frobenius eigenvalue of the matrix  $P_{\tilde{Q}} = \{e^{\text{tr}(\tilde{Q}\bar{Q}_i)} P_{\bar{Q}_i, \bar{Q}_j}\}_{0 \leq i, j \leq M}$  and  $M = |\mathcal{Q}| - 1$ , where  $\mathcal{Q}$  is defined in (3).

**Lemma 8.** The following holds:

$$\frac{\partial \log \rho(P_{\tilde{Q}})}{\partial \tilde{Q}}(\tilde{Q}) = \frac{1}{\rho(P_{\tilde{Q}})} \sum_{i=0}^M \lambda_i(\tilde{Q}) \sum_{j=0}^M \psi_j(\tilde{Q}) \bar{Q}_j P(\bar{Q}_j | \bar{Q}_i) e^{\text{tr}(\tilde{Q}\bar{Q}_i)}, \quad (261)$$

where  $\lambda(\tilde{Q})$  and  $\psi(\tilde{Q})$  are left and right eigenvectors associated with the Perron-Frobenius eigenvalue  $\rho(P_{\tilde{Q}})$  which are normalized such that  $\lambda(\tilde{Q})^T \psi(\tilde{Q}) = 1$ .

*Proof:* Refer to Appendix B for a detailed proof. ■

**Theorem 9.** Recall the definition of  $G^{(\nu)}(Q)$  in Lemma 5. In the large system limit, given any initial state  $x_0$ , the free energy satisfies:

$$\mathcal{F}_q = - \lim_{\nu \rightarrow 0} \frac{\partial}{\partial \nu} \sup_Q \left[ \beta^{-1} G^{(\nu)}(Q) - I^{(\nu)}(Q) \right], \quad (262)$$

where

$$I^{(\nu)}(Q) := \sup_{\tilde{Q}} \left[ \text{tr}(\tilde{Q}Q) - \log \rho(P_{\tilde{Q}}) \right], \quad (263)$$

and  $\rho(P_{\tilde{Q}})$  is the Perron-Frobenius eigenvalue of the matrix  $P_{\tilde{Q}} = \{e^{\text{tr}(\tilde{Q}\bar{Q}_i)} P_{\bar{Q}_i, \bar{Q}_j}\}_{0 \leq i, j \leq M}$  and  $M = |\mathcal{Q}| - 1$  where  $\mathcal{Q} := \{sxx^T \text{ for some } s \in \mathcal{S}, x \in \mathcal{X}^{\nu+1}\}$ .

*Proof:* The proof follows the same idea as [4, Part A, Sect. IV] with some important changes to account for the Markov setting.

1) By applying Lemma 7, from (254), we obtain

$$\lim_{n \rightarrow \infty} \frac{1}{n} \log \mathbb{E}[Z^\nu(\mathbf{Y}, \Phi)] = \lim_{n \rightarrow \infty} \frac{1}{n} \log \mathbb{E} \left\{ \exp \left[ \frac{n}{\beta} \left( G^{(\nu)}(\mathbf{T}_n) + O(n^{-1}) \right) \right] \right\} \quad (264)$$

$$= \sup_Q \left[ \frac{1}{\beta} G^{(\nu)}(Q) - I^{(\nu)}(Q) \right]. \quad (265)$$

2) Estimate the free energy.

Now, observe that

$$\mathcal{F} = - \lim_{n \rightarrow \infty} \frac{1}{n} \lim_{\nu \rightarrow 0} \frac{\partial}{\partial \nu} \log \mathbb{E}[Z^\nu(\mathbf{Y}, \Phi)] \quad (266)$$

$$= - \lim_{\nu \rightarrow 0} \frac{\partial}{\partial \nu} \lim_{n \rightarrow \infty} \frac{1}{n} \log \mathbb{E}[Z^\nu(\mathbf{Y}, \Phi)] \quad (267)$$

$$= - \lim_{\nu \rightarrow 0} \frac{\partial}{\partial \nu} \sup_Q \left[ \frac{1}{\beta} G^{(\nu)}(Q) - I^{(\nu)}(Q) \right] \quad (268)$$

where (266) follows from the assumption (A1), (A2), and the fact (F1), (267) follows from the assumption (A3), and (268) follows from (265). ■

**Theorem 10.** Recall the definitions of  $\Sigma$  and the matrix  $P_{\tilde{Q}}$  in Theorem 9. The optimal matrix  $Q^*$  of equation (262) in Theorem 9 must satisfy the following constraints:

$$Q^* = \frac{\partial \log \rho(P_{\tilde{Q}^*})}{\partial \tilde{Q}^*}, \quad (269)$$

$$\tilde{Q}^* = -(2\beta)^{-1} (I + \Sigma Q^*)^{-1} \Sigma, \quad (270)$$

$$\frac{\partial \log \rho(P_{\tilde{Q}^*})}{\partial \tilde{Q}^*} = \frac{1}{\rho(P_{\tilde{Q}^*})} \sum_{i=0}^M \lambda_i(\tilde{Q}^*) \sum_{j=0}^M \psi_j(\tilde{Q}^*) \tilde{Q}_j P(\tilde{Q}_j | \tilde{Q}_i) e^{\text{tr}(\tilde{Q}^* \tilde{Q}_i)}, \quad (271)$$

where  $\lambda(\tilde{Q}^*)$  and  $\psi(\tilde{Q}^*)$  are left and right eigenvectors associated with the Perron-Frobenius eigenvalue  $\rho(P_{\tilde{Q}^*})$  which are normalized such that  $\lambda(\tilde{Q}^*)^T \psi(\tilde{Q}^*) = 1$ .

*Proof:* Recall the definition of  $I^{(\nu)}$  in Theorem 9. It is easy to see that the optimization problem in (265) is equivalent to the following optimization problem:

$$\sup_Q \inf_{\tilde{Q}} T^{(\nu)}(Q, \tilde{Q}) \quad (272)$$

where

$$T^{(\nu)}(Q, \tilde{Q}) := -\frac{1}{2\beta} \log \det(I + \Sigma Q) - \text{tr}(\tilde{Q} Q) + \log \rho(P_{\tilde{Q}}) - \frac{1}{2\beta} \log \left( 1 + \frac{\nu}{\sigma^2} \right) - \frac{\nu}{2\beta} \log(2\pi\sigma^2). \quad (273)$$

For an arbitrary  $Q$ , we first seek critical points with respect to  $\tilde{Q}$  and find that for any given  $Q$ , the extremum in  $\tilde{Q}$  satisfies

$$Q = \frac{\partial \log \rho(P_{\tilde{Q}})}{\partial \tilde{Q}} \quad (274)$$

Let  $\tilde{Q}(Q)$  be a solution to (274). We then seek the critical point of  $T^{(\nu)}(Q, \tilde{Q}(Q))$  with respect to  $Q$ .

Let

$$K_{Q, \tilde{Q}} := \left[ \frac{\partial \tilde{Q}_{a,b}}{\partial Q_{a,b}} \right]_{a,b=0}^{\nu} \in \mathbb{R}^{\nu+1 \times \nu+1}. \quad (275)$$

Observe that

$$\frac{\partial \text{tr}(\tilde{Q}Q)}{\partial Q} = \frac{\partial \text{tr}(Q\tilde{Q})}{\partial Q} \quad (276)$$

$$= \tilde{Q} + Q \odot K_{Q, \tilde{Q}}, \quad (277)$$

where  $\odot$  is the Hadamard product.

It follows that

$$\frac{\partial T^{(\nu)}(Q, \tilde{Q})}{\partial Q} = -\frac{1}{2\beta}(I + \Sigma Q)^{-1}\Sigma - \left( \tilde{Q} + Q \odot K_{Q, \tilde{Q}} \right) + \frac{\partial \log \rho(P_{\tilde{Q}})}{\partial Q} \quad (278)$$

$$= -\frac{1}{2\beta}(I + \Sigma Q)^{-1}\Sigma - \left( \tilde{Q} + Q \odot K_{Q, \tilde{Q}} \right) + \frac{\partial \log \rho(P_{\tilde{Q}})}{\partial \tilde{Q}} \odot K_{Q, \tilde{Q}} \quad (279)$$

$$= -\frac{1}{2\beta}(I + \Sigma Q)^{-1}\Sigma - \tilde{Q} - \left[ Q - \frac{\partial \log \rho(P_{\tilde{Q}})}{\partial \tilde{Q}} \right] \odot K_{Q, \tilde{Q}} \quad (280)$$

$$= -\frac{1}{2\beta}(I + \Sigma Q)^{-1}\Sigma - \tilde{Q}, \quad (281)$$

where (278) follows from (277), and (281) follows from (274). Hence, the optimal value of the Theorem 9 is the solution of the following equation systems:

$$Q = \frac{\partial \log \rho(P_{\tilde{Q}})}{\partial \tilde{Q}}, \quad (282)$$

$$\tilde{Q} = -(2\beta)^{-1}(I + \Sigma Q)^{-1}\Sigma. \quad (283)$$

Finally, from Lemma 8, we also obtain an additional constraint in (271). ■

Observe that the matrix  $\Sigma$  defined in Theorem 9 is invariant if two non-zero indices are interchanged, i.e.,  $\Sigma$  is symmetric in replicas. Now, we use the RS assumption (A4) to simplify the result in Theorem 9. More specifically, we use the following RS assumption:

**Definition 11.** [4, p. 1999] An solution  $(\tilde{Q}^*, Q^*)$  of the optimization problem in Theorem 9, i.e.,

$$\begin{aligned} & \sup_Q \left[ \beta^{-1} G^{(\nu)}(Q) - I^{(\nu)}(Q) \right] \\ & = \sup_Q \inf_{\tilde{Q}} \left[ -\frac{1}{2\beta} \log \det(I + \Sigma Q) - \text{tr}(\tilde{Q}Q) + \log \rho(P_{\tilde{Q}}) - \frac{1}{2\beta} \log \left( 1 + \frac{\nu}{\sigma^2} \right) - \frac{\nu}{2\beta} \log(2\pi\sigma^2) \right] \end{aligned} \quad (284)$$

is called to satisfy the Replica Symmetry (RS) if both  $Q^*$  and  $\tilde{Q}^*$  are invariant if two (nonzero) replica indices are interchanged. In other words, the extremum can be written as

$$Q^* = \begin{bmatrix} r & m & m & \cdots & m \\ m & p & q & \cdots & q \\ m & q & p & \ddots & \vdots \\ \vdots & \vdots & \ddots & \ddots & q \\ m & q & \cdots & q & p \end{bmatrix}, \quad (285)$$

$$\tilde{Q}^* = \begin{bmatrix} c & d & d & \cdots & d \\ d & g & f & \cdots & f \\ d & f & g & \ddots & \vdots \\ \vdots & \vdots & \ddots & \ddots & q \\ d & f & \cdots & f & g \end{bmatrix}, \quad (286)$$

where  $r, m, p, q, c, d, f, g$  are some real numbers which are not dependent on  $\nu$ .

First, we show the following auxiliary results:

**Lemma 12.** *Under the RS assumption in Definition 11, the following holds:*

$$\lim_{\nu \rightarrow 0} \rho(P_{\tilde{Q}^*}) = 1. \quad (287)$$

**Remark 13.** *For the i.i.d. case, Guo and Verdú [4] already pointed out that*

$$\lim_{\nu \rightarrow 0} \mathcal{M}(\tilde{Q}^*) = 1, \quad (288)$$

where  $\mathcal{M}(\tilde{Q}^*) = \mathbb{E}[e^{\text{tr}(\tilde{Q}^* Q)}]$ . Lemma 12 shows that this fact still holds in our more general setting. The following proof follows the same steps as in [4].

*Proof:* Observe that  $Q_0 - Q_1 - \cdots - Q_n$  is a Markov chain with the transition matrix

$$P_{\tilde{Q}} = \begin{bmatrix} P(\bar{Q}_0|\bar{Q}_0)e^{\text{tr}(\tilde{Q}\bar{Q}_0)} & P(\bar{Q}_1|\bar{Q}_0)e^{\text{tr}(\tilde{Q}\bar{Q}_1)} & \cdots & P(\bar{Q}_M|\bar{Q}_0)e^{\text{tr}(\tilde{Q}\bar{Q}_M)} \\ P(\bar{Q}_0|\bar{Q}_1)e^{\text{tr}(\tilde{Q}\bar{Q}_0)} & P(\bar{Q}_1|\bar{Q}_1)e^{\text{tr}(\tilde{Q}\bar{Q}_1)} & \cdots & P(\bar{Q}_M|\bar{Q}_1)e^{\text{tr}(\tilde{Q}\bar{Q}_M)} \\ \vdots & \vdots & \vdots & \vdots \\ P(\bar{Q}_0|\bar{Q}_M)e^{\text{tr}(\tilde{Q}\bar{Q}_0)} & P(\bar{Q}_1|\bar{Q}_M)e^{\text{tr}(\tilde{Q}\bar{Q}_2)} & \cdots & P(\bar{Q}_M|\bar{Q}_M)e^{\text{tr}(\tilde{Q}\bar{Q}_M)} \end{bmatrix}. \quad (289)$$

where

$$P(\bar{Q}_j|\bar{Q}_i) := \mathbb{P}(Q_1 = \bar{Q}_j | Q_0 = \bar{Q}_i) \quad (290)$$

and  $Q_0$  and  $Q_1$  are random (state) matrices at time 0 and 1, respectively, which are defined in Lemma 5.



By [31], we have

$$\min_{i \in [M]} \sum_{j=0}^M P(\mathbf{Q}_1 = \bar{Q}_j | \mathbf{Q}_0 = \bar{Q}_i) e^{\text{tr}(\tilde{Q}\bar{Q}_i)} \leq \rho(P_{\tilde{Q}}) \leq \max_{i \in [M]} \sum_{j=0}^M P(\mathbf{Q}_1 = \bar{Q}_j | \mathbf{Q}_0 = \bar{Q}_i) e^{\text{tr}(\tilde{Q}\bar{Q}_i)}. \quad (291)$$

It follows that

$$\min_{i \in [M]} \mathbb{E} \left[ e^{\text{tr}(\tilde{Q}\mathbf{Q}_1)} | \mathbf{Q}_0 = \bar{Q}_i \right] \leq \rho(P_{\tilde{Q}}) \leq \max_{i \in [M]} \mathbb{E} \left[ e^{\text{tr}(\tilde{Q}\mathbf{Q}_1)} | \mathbf{Q}_0 = \bar{Q}_i \right]. \quad (292)$$

Hence, it is enough to show that

$$\mathbb{E} \left[ e^{\text{tr}(\tilde{Q}\mathbf{Q}_1)} | \mathbf{Q}_0 = \bar{Q}_i \right] \rightarrow 1 \quad (293)$$

for all  $i \in [M]$ . Indeed, by the definition of  $\{\mathbf{Q}_n\}_{n=1}^\infty$  in Lemma 5, we can assume that  $\bar{Q}_i = s x_i x_i^T$  for some  $s \in \mathcal{S}$  and  $x_i \in \mathcal{X}^{\nu+1}$ . Then, we have

$$\mathbb{E} \left[ e^{\text{tr}(\tilde{Q}\mathbf{Q}_1)} | \mathbf{Q}_0 = \bar{Q}_i \right] = \mathbb{E} \left[ e^{S_1 \mathbf{X}_1 \tilde{Q} \mathbf{X}_1^T} | \mathbf{Q}_0 = \bar{Q}_i \right] \quad (294)$$

$$= \mathbb{E} \left[ e^{S_1 \mathbf{X}_1 \tilde{Q} \mathbf{X}_1^T} | \mathbf{Q}_0 = \bar{Q}_i \right] \quad (295)$$

$$= \mathbb{E} \left[ \exp \left( 2d \sum_{a=1}^{\nu} X_1^{(0)} X_1^{(a)} + 2f \sum_{1 \leq a < b \leq \nu} X_1^{(a)} X_1^{(b)} + c(X_1^{(0)})^2 + g \sum_{a=1}^{\nu} (X_1^{(a)})^2 \right) | \mathbf{Q}_0 = \bar{Q}_i \right], \quad (296)$$

where (296) follows from RS assumption in Definition 11 and the definition of  $\mathbf{Q}_1$  in Lemma 5.

Now, the eight parameters  $(r, m, p, q, f, g)$  that define  $Q^*$  and  $\tilde{Q}^*$  are the solution to the joint equations (269) and (270) in Theorem 10. Using (270), it can be shown that [4, Eq. (123)]

$$c = 0, \quad (297)$$

$$d = \frac{1}{2[\sigma^2 + \beta(p - q)]}, \quad (298)$$

$$f = \frac{1 + \beta(r - 2m + q)}{2[\sigma^2 + \beta(p - q)]^2}, \quad (299)$$

$$g = f - d. \quad (300)$$

Now, define

$$\eta = \frac{2d^2}{f}, \quad \xi = 2d. \quad (301)$$

Then, by using some algebraic calculation and using the following interesting identity

$$e^{x^2} = \sqrt{\frac{\eta}{2\pi}} \int \exp \left[ -\frac{\eta}{2} u^2 + \sqrt{2\eta} x u \right] du, \quad \forall x, \eta, \quad (302)$$

from (296), we have (cf. a similar formula in [4, Eq. (125)])

$$\mathbb{E} \left[ e^{\text{tr}(\tilde{Q}^* Q_1)} \middle| \mathbf{Q}_0 = \bar{Q}_i \right] \quad (303)$$

$$= \mathbb{E} \left[ \sqrt{\frac{\eta}{2\pi}} \int \exp \left[ -\frac{\eta}{2}(u - \sqrt{S}X_1)^2 \right] \left[ \mathbb{E}_q \left\{ \exp \left[ -\frac{\eta}{2}u^2 - \frac{\eta}{2}(u - \sqrt{S}X)^2 \right] \middle| \mathbf{Q}_0 = \bar{Q}_i \right\} \right]^\nu du \middle| \mathbf{Q}_0 = \bar{Q}_i \right] \quad (304)$$

$$\rightarrow \mathbb{E} \left[ \sqrt{\frac{\eta}{2\pi}} \int \exp \left[ -\frac{\eta}{2}(u - \sqrt{S}X_1)^2 \right] du \middle| \mathbf{Q}_0 = \bar{Q}_i \right] \quad (305)$$

$$= \mathbb{E} [1 \middle| \mathbf{Q}_0 = \bar{Q}_i] \quad (306)$$

$$= 1. \quad (307)$$

■

**Lemma 14.** *Under the replica symmetry assumptions in Definition 11, the following holds:*

$$Q^* = \lim_{\nu \rightarrow 0} \sum_{i=0}^M \lambda_i(\tilde{Q}^*) \mathbb{E}[\mathbf{Q}_1 e^{\text{tr}(\tilde{Q}^* Q_1)} \middle| \mathbf{Q}_0 = \bar{Q}_i] \quad (308)$$

where  $Q^*$  is defined in Theorem 10 and  $\lambda(\tilde{Q}^*)$  is a left (positive) eigenvector associated with the Perron-Frobenius eigenvalue  $\rho(P_{\tilde{Q}^*})$  such that  $\|\lambda(\tilde{Q}^*)\|_1 = 1$ .

*Proof:* Since  $\psi(\tilde{Q}^*)$  is the right eigenvector associated with the Perron-Frobenius eigenvalue of the matrix  $P_{\tilde{Q}^*}$ , it holds that

$$\sum_{j=0}^M P(\bar{Q}_j | \bar{Q}_i) e^{\text{tr}(\tilde{Q}^* \bar{Q}_i)} \psi_j(\tilde{Q}^*) = \rho(P_{\tilde{Q}^*}) \psi_i(\tilde{Q}^*) \quad (309)$$

for all  $i \in [M]$ . By the replica symmetry assumptions in Definition 11, from Lemma 12, we have

$$\rho(P_{\tilde{Q}^*}) \rightarrow 1 \quad \text{and} \quad \sum_{j=0}^M P(\bar{Q}_j | \bar{Q}_i) e^{\text{tr}(\tilde{Q}^* \bar{Q}_i)} \rightarrow 1 \quad \forall i \in [M] \quad (310)$$

as  $\nu \rightarrow 0$ . From (309) and (310), we can set  $\psi(\tilde{Q}^*) = (1, 1, \dots, 1)^T$  is a right eigenvector associated with the eigenvalue  $\rho(P_{\tilde{Q}^*})$  as  $\nu \rightarrow 0$ .

Hence, from Theorem 10, we have

$$Q^* = \lim_{\nu \rightarrow 0} \sum_{i=0}^M \lambda_i(\tilde{Q}^*) \mathbb{E}[\mathbf{Q}_1 e^{\text{tr}(\tilde{Q}^* Q_1)} \middle| \mathbf{Q}_0 = \bar{Q}_i]. \quad (311)$$

Now, since by Theorem 10, it holds that

$$\sum_{j=0}^M \psi_j(\tilde{Q}^*) \lambda_j(\tilde{Q}^*) = 1, \quad (312)$$

so we have

$$\|\lambda(\tilde{Q}^*)\|_1 = 1. \quad (313)$$

■

Then, we obtain our first main result as follows.

**Theorem 15.** *The free energy of the linear model with Markov sources in Section II satisfies*

$$\mathcal{F}_q = \mathcal{G}, \quad (314)$$

where  $\mathcal{G}$  is defined in (33). In addition, the average mutual information of this model satisfies:

$$C = \lim_{n \rightarrow \infty} \frac{1}{n} I(\mathbf{X}^n; \mathbf{Y}^m) = \mathcal{F}_q \Big|_{\sigma=1} - \frac{1}{2\beta}. \quad (315)$$

*Proof:* From Lemma 14, it holds that

$$Q^* = \lim_{\nu \rightarrow 0} \sum_{i=0}^M \lambda_i(\tilde{Q}^*) \mathbb{E}[\mathbf{Q}_1 e^{\text{tr}(\tilde{Q}^* \mathbf{Q}_1)} | \mathbf{Q}_0 = \bar{Q}_i], \quad (316)$$

where  $\|\lambda(\tilde{Q}^*)\|_1 = 1$  and all its components are positive.

By Lemma 5, we have  $\mathbf{Q}_1 = S_1 \mathbf{X}_1 \mathbf{X}_1^T$  and  $\mathbf{Q}_0 = S_0 \mathbf{X}_0 \mathbf{X}_0^T$  where  $\mathbf{X}_1 := (X_1^{(0)}, X_1^{(1)}, \dots, X_1^{(\nu)})^T$  and  $\mathbf{X}_0 := (X_0^{(0)}, X_0^{(1)}, \dots, X_0^{(\nu)})^T$ . It follows that for any  $\tilde{Q} \in \mathcal{Q}$  and  $\bar{Q}_i \in \mathcal{Q}$ , we have

$$\hat{Q}_i(\tilde{Q}) := \mathbb{E}[\mathbf{Q}_1 e^{\text{tr}(\tilde{Q} \mathbf{Q}_1)} | \mathbf{Q}_0 = \bar{Q}_i] \quad (317)$$

$$= \mathbb{E} \left[ S_1 \mathbf{X}_1 \mathbf{X}_1^T \exp[\mathbf{X}_1^T \tilde{Q} \mathbf{X}_1] \Big| S_0 = s_i, \mathbf{X}_0 = x_i \right] \quad (318)$$

$$= \mathbb{E} \left[ S_1 \mathbf{X}_1 \mathbf{X}_1^T \exp[\mathbf{X}_1^T \tilde{Q} \mathbf{X}_1] \Big| \mathbf{X}_0 = x_i \right] \quad (319)$$

for some  $s_i \in \mathcal{S}$  and  $x_i \in \mathcal{X}^{\nu+1}$  such that  $s_i x_i x_i^T = \bar{Q}_i$ , where (318) follows from the uniqueness of the  $x_i$  and  $s_i$  up to the sign, and (319) follows from the fact that  $S_0$  is independent of  $\mathbf{X}_1, \mathbf{X}_0$ .

It follows that

$$\hat{Q}_i(\tilde{Q}) := \mathbb{E}[\mathbf{Q}_1 e^{\text{tr}(\tilde{Q} \mathbf{Q}_1)} | \mathbf{Q}_0 = \bar{Q}_i] = \mathbb{E} \left[ S_1 \mathbf{X}_1 \mathbf{X}_1^T \exp[\mathbf{X}_1^T \tilde{Q} \mathbf{X}_1] \Big| \mathbf{X}_0 = x_i \right]. \quad (320)$$

This means that for each fixed  $i \in [M]$ ,  $\hat{Q}_i^{(a,b)}(\tilde{Q})$  is in the same form as [4, Eq. (127)] for each  $(a, b) \in [\nu + 1] \times [\nu + 1]$ . Hence, we have

$$\hat{Q}_i^{(0,1)}(\tilde{Q}) = \mathbb{E} \left[ S X_1^{(0)} X_1^{(1)} \exp[\mathbf{X}_1^T \tilde{Q} \mathbf{X}_1] \Big| \mathbf{X}_0 = x_i \right] \quad (321)$$

$$= \mathbb{E} \left[ S X_1 \langle X | \mathbf{X}_0 = x_i \rangle_q \Big| \mathbf{X}_0 = x_i \right], \quad (322)$$

where (322) follows from [4, Eq. (131)].

Similarly, we also have

$$r_i := \hat{Q}_i^{(0,0)} = \mathbb{E}[S | \mathbf{X}_0 = x_i], \quad (323)$$

$$m_i := \hat{Q}_i^{(0,1)} = \mathbb{E}[S X_1 \langle X | \mathbf{X}_0 = x_i \rangle_q | \mathbf{X}_0 = x_i], \quad (324)$$

$$p_i := \hat{Q}_i^{(1,1)} = \mathbb{E}[S X^2 | \mathbf{X}_0 = x_i], \quad (325)$$

$$q_i := \hat{Q}_i^{(1,2)} = \mathbb{E}[S \langle X | \mathbf{X}_0 = x_i \rangle_q^2 | \mathbf{X}_0 = x_i], \quad (326)$$

for all  $i \in [M]$ . Since  $\mathbf{X}^{(a)} \sim q_{\mathbf{X}}$  for all  $a = 1, 2, \dots, \nu$  and mutually independent to each other, it follows from (323)–(326) that  $\hat{Q}_i(\tilde{Q})$  has the RS form as defined in Lemma 11, i.e.,

$$\hat{Q}_i(\tilde{Q}) = \begin{bmatrix} r_i & m_i & m_i & \cdots & m_i \\ m_i & p_i & q_i & \cdots & q_i \\ m_i & q_i & p_i & \ddots & \vdots \\ \vdots & \vdots & \ddots & \ddots & q_i \\ m_i & q_i & \cdots & q_i & p_i \end{bmatrix}. \quad (327)$$

for all  $i \in [M]$ .

It follows from Theorem (316) that

$$Q^*(\tilde{Q}) = \lim_{\nu \rightarrow 0} \sum_{i=0}^M \lambda_i(\tilde{Q}) \hat{Q}_i(\tilde{Q}) \quad (328)$$

$$= \lim_{\nu \rightarrow 0} \sum_{i=0}^M \lambda_i(\tilde{Q}) \begin{bmatrix} r_i & m_i & m_i & \cdots & m_i \\ m_i & p_i & q_i & \cdots & q_i \\ m_i & q_i & p_i & \ddots & \vdots \\ \vdots & \vdots & \ddots & \ddots & q_i \\ m_i & q_i & \cdots & q_i & p_i \end{bmatrix}. \quad (329)$$

Hence, from the RS assumption in Definition 11 and (329), we obtain

$$r = \lim_{\nu \rightarrow 0} \sum_{i=0}^M \lambda_i(\tilde{Q}) r_i \quad (330)$$

$$= \lim_{\nu \rightarrow 0} \sum_{i=0}^M \lambda_i(\tilde{Q}) \mathbb{E}[S | \mathbf{X}_0 = x_i] \quad (331)$$

$$= \lim_{\nu \rightarrow 0} \sum_{i=0}^M \lambda_i(\tilde{Q}) \mathbb{E}[S | \mathbf{X}_0 = x_i^{(0)}], \quad (332)$$

$$m = \lim_{\nu \rightarrow 0} \sum_{i=0}^M \lambda_i(\tilde{Q}) m_i \quad (333)$$

$$= \lim_{\nu \rightarrow 0} \sum_{i=0}^M \lambda_i(\tilde{Q}) \mathbb{E} [S \mathbf{X}_1 \langle \mathbf{X} | \mathbf{X}_0 = x_i \rangle_q | \mathbf{X}_0 = x_i] \quad (334)$$

$$= \lim_{\nu \rightarrow 0} \sum_{i=0}^M \lambda_i(\tilde{Q}) \mathbb{E} [S \mathbf{X}_1 \langle \mathbf{X} | \mathbf{X}_0 = x_i^{(0)} \rangle_q | \mathbf{X}_0 = x_i^{(0)}], \quad (335)$$

$$p = \lim_{\nu \rightarrow 0} \sum_{i=0}^M \lambda_i(\tilde{Q}) p_i \quad (336)$$

$$= \lim_{\nu \rightarrow 0} \sum_{i=0}^M \lambda_i(\tilde{Q}) \mathbb{E} [S \mathbf{X}^2 | \mathbf{X}_0 = x_i] \quad (337)$$

$$= \lim_{\nu \rightarrow 0} \sum_{i=0}^M \lambda_i(\tilde{Q}) \mathbb{E} [S \mathbf{X}^2 | \mathbf{X}_0 = x_i^{(0)}], \quad (338)$$

$$q = \lim_{\nu \rightarrow 0} \sum_{i=0}^M \lambda_i(\tilde{Q}) q_i \quad (339)$$

$$= \lim_{\nu \rightarrow 0} \sum_{i=0}^M \lambda_i(\tilde{Q}) \mathbb{E} [S \langle \mathbf{X} | \mathbf{X}_0 = x_i \rangle_q^2 | \mathbf{X}_0 = x_i] \quad (340)$$

$$= \lim_{\nu \rightarrow 0} \sum_{i=0}^M \lambda_i(\tilde{Q}) \mathbb{E} [S \langle \mathbf{X} | \mathbf{X}_0 = x_i^{(0)} \rangle_q^2 | \mathbf{X}_0 = x_i^{(0)}]. \quad (341)$$

From these facts, we obtain

$$r - 2m + q = \lim_{\nu \rightarrow 0} \sum_{i=0}^M \lambda_i(\tilde{Q}) \mathbb{E} \left[ S \left( \mathbf{X}_1^2 - 2 \mathbf{X}_1 \langle \mathbf{X} | \mathbf{X}_0 = x_i^{(0)} \rangle_q + \langle \mathbf{X} | \mathbf{X}_0 = x_i^{(0)} \rangle_q^2 \right) \middle| \mathbf{X}_0 = x_i^{(0)} \right] \quad (342)$$

$$= \lim_{\nu \rightarrow 0} \sum_{i=0}^M \lambda_i(\tilde{Q}) \mathbb{E} \left[ S \left( \mathbf{X}_1 - \langle \mathbf{X} | \mathbf{X}_0 = x_i^{(0)} \rangle_q \right)^2 \middle| \mathbf{X}_0 = x_i^{(0)} \right], \quad (343)$$

$$(344)$$

and similarly,

$$p - q = \lim_{\nu \rightarrow 0} \sum_{i=0}^M \lambda_i(\tilde{Q}) \mathbb{E} \left[ S \left( \mathbf{X} - \langle \mathbf{X} | \mathbf{X}_0 = x_i^{(0)} \rangle_q \right)^2 \middle| \mathbf{X}_0 = x_i^{(0)} \right]. \quad (345)$$

On the other hand, from (297)–(301), we also have

$$r - 2m + q = \frac{1}{\beta} \left( \frac{1}{\eta} - 1 \right), \quad (346)$$

$$p - q = \frac{1}{\beta} \left( \frac{1}{\xi} - \sigma^2 \right). \quad (347)$$

From (343)–(347),  $(\eta, \xi)$  is a solution of the following equation system:

$$\eta^{-1} = 1 + \beta \lim_{\nu \rightarrow 0} \sum_{i=0}^M \lambda_i(\tilde{Q}) \mathbb{E} \left[ S \left( \mathbf{X}_1 - \langle \mathbf{X} | \mathbf{X}_0 = x_i^{(0)} \rangle_q \right)^2 \middle| \mathbf{X}_0 = x_i^{(0)} \right], \quad (348)$$

$$= 1 + \beta \lim_{\nu \rightarrow 0} \sum_{i=0}^M \lambda_i(\tilde{Q}) \mathcal{E}(S; \eta, \xi | \mathbf{X}_0 = x_i^{(0)}), \quad (349)$$

$$\xi^{-1} = \sigma^2 + \beta \lim_{\nu \rightarrow 0} \sum_{i=0}^M \lambda_i(\tilde{Q}) \mathbb{E} \left[ S \left( \mathbf{X} - \langle \mathbf{X} | \mathbf{X}_0 = x_i^{(0)} \rangle_q \right)^2 \middle| \mathbf{X}_0 = x_i^{(0)} \right] \quad (350)$$

$$= \sigma^2 + \beta \lim_{\nu \rightarrow 0} \sum_{i=0}^M \lambda_i(\tilde{Q}) \mathcal{E}(S; \eta, \xi | \mathbf{X}_0 = x_i^{(0)}). \quad (351)$$

Now, from (255) in Lemma 5 and RS assumption on Definition 11, we obtain

$$\begin{aligned} G^{(\nu)}(Q^*) &= -\frac{\nu}{2} \log(2\pi\sigma^2) - \frac{\nu-1}{2} \log \left[ 1 + \frac{\beta}{\sigma^2}(p-q) \right] \\ &\quad - \frac{1}{2} \log \left[ 1 + \frac{\beta}{\sigma^2}(p-q) + \frac{\nu}{\sigma^2} \left( 1 + \beta(r-2m+q) \right) \right]. \end{aligned} \quad (352)$$

In addition, as  $\nu \rightarrow 0$ , we also have

$$I^{(\nu)}(Q^*) = \text{tr}(\tilde{Q}^* Q^*) - \log \rho(P_{\tilde{Q}^*}) \quad (353)$$

$$= \text{tr}(\tilde{Q}^* Q^*), \quad (354)$$

$$= rc + \nu pg + 2\nu md + \nu(\nu-1)qf, \quad (355)$$

where (354) follows from Lemma 12, and (355) follows from assumptions  $Q^*$  and  $\tilde{Q}^*$  in Definition 11.

Now, by the RS assumption, the eight parameters  $(r, m, p, q, c, d, f, g)$  have zero derivatives with respect to  $\nu$  as  $\nu \rightarrow 0$  [4, p.1999]. Hence, from Theorem 9, we have

$$\mathcal{F}_q = -\lim_{\nu \rightarrow 0} \frac{\partial}{\partial \nu} (\beta^{-1} G^{(\nu)}(Q^*) - I^{(\nu)}(Q^*)) \quad (356)$$

$$\begin{aligned} &= \lim_{\nu \rightarrow 0} \frac{\partial}{\partial \nu} \left( rc + \nu pg + 2\nu md + \nu(\nu-1)qf - \beta^{-1} \left( -\frac{\nu}{2} \log(2\pi\sigma^2) - \frac{\nu-1}{2} \log \left[ 1 + \frac{\beta}{\sigma^2}(p-q) \right] \right. \right. \\ &\quad \left. \left. - \frac{1}{2} \log \left[ 1 + \frac{\beta}{\sigma^2}(p-q) + \frac{\nu}{\sigma^2} \left( 1 + \beta(r-2m+q) \right) \right] \right) \right) \end{aligned} \quad (357)$$

$$= pg + 2md - qf + \beta^{-1} \left[ \frac{1}{2} \log(2\pi\sigma^2) + \frac{1}{2} \log \left( 1 + \frac{\beta}{\sigma^2}(p-q) \right) + \frac{1 + \beta(r-2m+q)}{2\sigma^2(1 + \frac{\beta}{\sigma^2}(p-q))} \log e \right] \quad (358)$$

$$= p(f-d) + 2md - qf + \beta^{-1} \left[ \frac{1}{2} \log(2\pi\sigma^2) + \frac{1}{2} \log \left( 1 + \frac{\beta}{\sigma^2}(p-q) \right) + \frac{1 + \beta(r-2m+q)}{2\sigma^2(1 + \frac{\beta}{\sigma^2}(p-q))} \log e \right] \quad (359)$$

$$= (p - q)f - pd + 2md + \beta^{-1} \left[ \frac{1}{2} \log(2\pi\sigma^2) + \frac{1}{2} \log \left( 1 + \frac{\beta}{\sigma^2} (p - q) \right) + \frac{1 + \beta(r - 2m + q)}{2\sigma^2(1 + \frac{\beta}{\sigma^2}(p - q))} \log e \right] \quad (360)$$

$$= (p - q) \frac{1 + \beta(r - 2m + q)}{2(\sigma^2 + \beta(p - q))^2} - \frac{p}{2[\sigma^2 + \beta(p - q)]} + \frac{m}{\sigma^2 + \beta(p - q)} + \beta^{-1} \left[ \frac{1}{2} \log(2\pi\sigma^2) + \frac{1}{2} \log \left( 1 + \frac{\beta}{\sigma^2} (p - q) \right) + \frac{1 + \beta(r - 2m + q)}{2\sigma^2(1 + \frac{\beta}{\sigma^2}(p - q))} \log e \right] \quad (361)$$

$$= \frac{1}{\beta} \left( \frac{1}{\xi} - \sigma^2 \right) \frac{\xi^2}{2\eta} - \frac{p\xi}{2} + \xi m + \frac{1}{\beta} \left[ \frac{1}{2} \log(2\pi\sigma^2) - \frac{1}{2} \log(\xi\sigma^2) + \frac{\xi}{2\eta} \log e \right] \quad (362)$$

$$= \xi m - \frac{p\xi}{2} + \frac{1}{\beta} \left( \frac{1}{\xi} - \sigma^2 \right) \frac{\xi^2}{2\eta} - \frac{1}{2\beta} \log \xi + \frac{1}{2\beta} \log(2\pi) + \frac{\xi}{2\beta\eta} \log e \quad (363)$$

$$= \lim_{\nu \rightarrow 0} \sum_{i=0}^M \lambda_i(\tilde{Q}) \left( \xi \mathbb{E}[SX_1(\mathbf{X}|\mathbf{X}_0 = x_i^{(0)})_q | \mathbf{X}_0 = x_i^{(0)}] - \frac{\xi}{2} \mathbb{E}[SX^2 | \mathbf{X}_0 = x_i^{(0)}] \right) + \frac{1}{\beta} \left( \frac{1}{\xi} - \sigma^2 \right) \frac{\xi^2}{2\eta} - \frac{1}{2\beta} \log \xi + \frac{1}{2\beta} \log(2\pi) + \frac{\xi}{2\beta\eta} \log e \quad (364)$$

$$= \lim_{\nu \rightarrow 0} \sum_{i=0}^M \lambda_i(\tilde{Q}) \mathcal{G}(x_i^{(0)}), \quad (365)$$

where (359) follows from (297)–(301), (361) follows from (346) and (347), (364) follow from (335), (338) and  $\|\lambda(\tilde{Q})\|_1 = 1$ , and (365) follows from [4, Sect. IV].

Finally, as  $\nu \rightarrow 0$ , it holds that  $\tilde{Q}^* \rightarrow c = 0$  by (297) and (286) of Definition 11. Therefore, we have  $P_{\tilde{Q}^*} \rightarrow P_\pi$  and  $M \rightarrow |\mathcal{X}| - 1$ . It follows that  $\lambda(\tilde{Q}) \rightarrow \lambda^{(\pi)}$  where  $\lambda^{(\pi)}$  is the left Perron-Frobenius eigenvector of the stochastic matrix  $P_\pi$  such that  $\|\lambda^{(\pi)}\|_1 = 1$ . By Lemma 39, the left Perron-Frobenius eigenvector exists, and it is unique up to a positive scaling factor, so  $\lambda^{(\pi)}$  exists uniquely. Hence, we obtain (314) from (348), (351), and (365).

Finally, (315) is an direct application of [3, Prop. 5].  $\blacksquare$

The following corollary recovers [4, Sect. II-D]:

**Corollary 16.** *For any i.i.d. sequence  $\{X_n\}_{n=1}^\infty$  on the Polish space  $\mathcal{X}$  defined in Section II, the free energy satisfies*

$$\mathcal{F}_q = \mathcal{G}(\emptyset), \quad (366)$$

where  $\mathcal{G}(\emptyset)$  is the free-energy function estimated in Section III-A when no state information appears in the corresponding single-symbol PME channel.

In addition, the average mutual information of this model satisfies

$$C = \lim_{n \rightarrow \infty} \frac{1}{n} I(\mathbf{X}^n; \mathbf{Y}^m) = \mathcal{F}_q \Big|_{\sigma=1} - \frac{1}{2\beta}. \quad (367)$$

*Proof:* Observe that an i.i.d. sequence  $\{X_n\}_{n=1}^{\infty}$  can be considered as a Markov sequence with transition probability (function)  $\pi(x, y) = p(y)$  for all  $x, y \in \mathcal{X}$ . Hence,  $\mathcal{G}(x_0)$  is a constant, say  $\mathcal{G}(\emptyset)$ , for all  $x_0 \in \mathcal{X}$ . Here,  $\mathcal{G}(\emptyset)$  is the free energy function estimated in Section III-A when there is no state information appeared in the corresponding single-symbol PME channel, i.e.  $X_0 = \emptyset$ . In addition, the left Perron-Frobenius with unit Manhattan norm for this special case is  $\{P_{X_1}(x)\}_{x \in \mathcal{X}}$ .

Hence, by Theorem 15, we have

$$\mathcal{F}_q = \sum_{x_0 \in \mathcal{X}} \lambda_{x_0}^{(\pi)} \mathcal{G}(x_0) \quad (368)$$

$$= \left( \sum_{x_0 \in \mathcal{X}} P_{X_1}(x_0) \right) \mathcal{G}(\emptyset) \quad (369)$$

$$= \mathcal{G}(\emptyset), \quad (370)$$

where the last equation follows from  $\|\lambda^{(\pi)}\|_1 = 1$ . Hence, we obtain (366). Finally, (367) is an direct application of (315) in Theorem 15.  $\blacksquare$

To state our next main result, we recall Carleman theorem.

**Lemma 17.** [35, Theorem 3.1] Denote  $\mathcal{M}(\mathbb{R}^n)$  be the set of all positive Borel measures  $\mu$  on  $\mathbb{R}^n$  such that

$$\int_{\mathbb{R}^n} \|x\|_2^d d\mu(x) < \infty \quad \forall d \geq 0. \quad (371)$$

Suppose that  $\mu_1, \mu_2 \in \mathcal{M}(\mathbb{R}^n)$  satisfy

$$s(\alpha) := \int_{\mathbb{R}^n} x^\alpha d\mu_1(x) = \int_{\mathbb{R}^n} x^\alpha d\mu_2(x) \quad \text{for all } \alpha \in \mathbb{N}^n \quad (372)$$

and that the conditions

$$\sum_{m=1}^{\infty} s(2me_j)^{-1/(2m)} = \infty, \quad j = 1, 2, \dots, n, \quad (373)$$

hold, where  $e_j$  is the  $j$ th canonical basis vector of  $\mathbb{R}^n$ . Then  $\mu_1 = \mu_2$ .

**Theorem 18.** Recall the definition of  $\{\lambda_{x_0}^{(\pi)}\}_{x_0 \in \mathcal{X}}$  in Section III-A. Assume that the generalized PME defined in (14) is used for estimation. Then, for all  $k \in \{1, 2, \dots, n\}$ , the joint moments satisfy:

$$\lim_{n \rightarrow \infty} \mathbb{E} \left[ X_k^{i_0} \tilde{X}_k^{j_0} \langle X_k \rangle_q^{l_0} \right] = \sum_{x_0 \in \mathcal{X}} \lambda_{x_0}^{(\pi)} \mathbb{E} \left[ X_1^{i_0} X^{j_0} \langle X | X_0 \rangle_q^{l_0} | X_0 = x_0 \right] \quad \forall i_0, j_0, l_0 \in \mathbb{Z}_+, \quad (374)$$

where  $(X_1, X, \langle X | X_0 = x_0 \rangle_q)$  is the input and outputs defined in the (composite) single-symbol PME channel in Fig. 1, and  $(X_k, \tilde{X}_k, \langle X_k \rangle)$  is the  $k$ -th symbol in the vector  $\mathbf{X} \in \mathcal{X}^n$ , the  $k$ -th output of the vector retrochannel defined in (12), and its corresponding estimated symbol by using the PME estimate in (14).



In addition, the average MMSE satisfies:

$$\frac{1}{n} \mathbb{E}[\|\mathbf{X} - \langle \mathbf{X} \rangle\|_2^2] = \mathbb{E}[X_1^2] - \sum_{x_0 \in \mathcal{X}} \lambda_{x_0}^{(\pi)} \mathbb{E}[\langle X_1 | X_0 \rangle^2 | X_0 = x_0], \quad (375)$$

where  $X_1, \langle X \rangle, X_0$  are the input, output, and state in the single-symbol PME channel with available states at both encoder and decoder defined Section III-A, and  $X_1 \sim \sum_{x_0 \in \mathcal{X}} \pi(x_0, \cdot) p(x_0)$ .

**Remark 19.** Some remarks are in order.

- For the i.i.d. case of the sequence  $\{X_n\}_{n=1}^\infty$ , we have a tight bound on (374). It is not hard to check that the Carleman condition (373) holds for the joint Gaussian distribution on the composite single-symbol Gaussian channel in Fig. 1. Hence, from Carleman Theorem in Lemma 17, in the large system limit, the channel between the input  $X_k$  and  $\langle X_k \rangle_q$  for each symbol  $k$  is equivalent to the Gaussian channel  $p_{U|X, X_0, S; \eta}$  with available state  $X_0 = \emptyset$  at both encoder and decoder concatenated with the one-to-one decision function with  $S = S_k$ . This result recovers [4, Corrolary 1] as a special case for the i.i.d. sequence  $\{X_n\}_{n=1}^\infty$ .
- From Theorem 18, it can be inferred that for the generalized PME estimation problem, the channel (model) has been decoupled into AWGN channels with state information at both transmitters and receivers, where state vector distribution follows the left Perron-Frobenius eigenvalue  $\lambda^{(\pi)}$  of the stochastic matrix  $P_\pi$ .

*Proof:* The result in (374) can be obtained by using the same ideas as in the proof of Theorem 9, [4, Sec. IV-B], and the facts in (316), (320), and (365). The detailed proof can be found in Appendix C.

Now, observe that by using the MMSE decoder defined in Section II-A, we have

$$\mathbb{E}[\|\mathbf{X} - \langle \mathbf{X} \rangle\|_2^2] = \sum_{k=1}^n \mathbb{E}[|X_k - \langle X \rangle_k|^2] \quad (376)$$

$$= \sum_{k=1}^n \mathbb{E}[|X_k - \langle X_k \rangle|^2] \quad (377)$$

$$= \sum_{k=1}^n \mathbb{E}\left[\mathbb{E}[|X_k - \langle X_k \rangle|^2 | \mathbf{Y}, \Phi]\right] \quad (378)$$

$$= \sum_{k=1}^n \mathbb{E}\left[\mathbb{E}[X_k^2] - \langle X_k \rangle^2 | \mathbf{Y}, \Phi]\right] \quad (379)$$

$$= \sum_{k=1}^n \mathbb{E}[X_k^2 - \langle X_k \rangle^2] \quad (380)$$

$$= \sum_{k=1}^n \mathbb{E}[X_k^2] - \sum_{k=1}^n \mathbb{E}[\langle X_k \rangle^2], \quad (381)$$

where (377) follows from (9), (378) follows from the tower property [36], and (379) follows from the fact that

$$\langle X_k \rangle = \mathbb{E}[X_k | \mathbf{Y}, \Phi] \quad (382)$$

which is drawn from (9).

Now, by (374), we have as  $n \rightarrow \infty$ ,

$$\mathbb{E}[\langle X_k \rangle^2] = \sum_{x_0 \in \mathcal{X}} \lambda_{x_0}^{(\pi)} \mathbb{E}[\langle X_1 | X_0 = x_0 \rangle^2], \quad \forall k \in \{1, 2, \dots, n\}. \quad (383)$$

In addition, for all  $k \in \{1, 2, \dots, n\}$ , we also have

$$\mathbb{E}[X_k^2] = \mathbb{E}[\mathbb{E}[X_k^2 | X_{k-1}]] \quad (384)$$

$$= \mathbb{E}[\mathbb{E}[X_1^2 | X_0]] \quad (385)$$

$$= \mathbb{E}[X_1^2] \quad (386)$$

$$= \mathbb{E}[X_1^2], \quad (387)$$

where (384) follows from the tower property [36], and (385) follows from the time-homogeneity of Markov process  $\{X_n\}_{n=1}^\infty$ .

From (381), (383), and (386), as  $n \rightarrow \infty$ , we have

$$\mathbb{E}[\|\mathbf{X} - \langle \mathbf{X} \rangle\|_2^2] = n \left( \mathbb{E}[X_1^2] - \sum_{x_0 \in \mathcal{X}} \lambda_{x_0}^{(\pi)} \mathbb{E}[\langle X_1 | X_0 = x_0 \rangle^2] \right), \quad (388)$$

which leads to (375). ■

The following corollary also recovers [4, Sect. II-D]:

**Corollary 20.** *Let  $\{X_n\}_{n=1}^\infty$  be an i.i.d. sequence on the Polish space  $\mathcal{X}$  defined in Section II. Assume that the generalized PME defined in (14) is used for estimation. Then, for all  $k \in \{1, 2, \dots, n\}$ , the joint moments satisfy:*

$$\lim_{n \rightarrow \infty} \mathbb{E} \left[ X_k^{i_0} \tilde{X}_k^{j_0} \langle X_k \rangle_q^{l_0} \right] = \mathbb{E} \left[ X_1^{i_0} X_1^{j_0} \langle X | X_0 \rangle_q^{l_0} | X_0 = \emptyset \right] \quad \forall i_0, j_0, l_0 \in \mathbb{Z}_+, \quad (389)$$

where  $(X_1, X, \langle X | X_0 = x_0 \rangle_q)$  is the input and outputs defined in the (composite) single-symbol PME channel in Fig. 1, and  $(X_k, \tilde{X}_k, \langle X_k \rangle)$  is the  $k$ -th symbol in the vector  $\mathbf{X} \in \mathcal{X}^n$ , the  $k$ -th output of the vector retrochannel defined in (12), and its corresponding estimated symbol by using the PME estimate in (14). Here,  $X_0 = \emptyset$  in the RHS of (389) means that the conditional joint moments is estimated when no state information  $X_0$  is assumed in the corresponding single-symbol PME channel in Section III-A.

In addition, the average MMSE satisfies:

$$\frac{1}{n} \mathbb{E}[\|\mathbf{X} - \langle \mathbf{X} \rangle\|_2^2] = \mathbb{E}[X_1^2] - \mathbb{E}[\langle X_1 | X_0 \rangle^2 | X_0 = \emptyset], \quad (390)$$

where  $X_1, \langle X \rangle, X_0$  are the input, output, and state in the single-symbol PME channel with available states at both encoder and decoder defined Section III-A, respectively.

*Proof:* These results can be obtained by using the same arguments as Corollary 16. They are direct applications of Theorem 18.  $\blacksquare$

**Theorem 21.** Assume that  $\{X_n\}_{n=1}^\infty$  is the hidden states (outputs) of a hidden Markov model generated by a Markov chain  $\{\Upsilon_n\}_{n=1}^\infty$  with transition probability (function)  $\pi_\Upsilon(\cdot, \cdot)$  on some Polish space  $\mathcal{S}_\Upsilon$ , i.e.,

- $\Upsilon_n$  is a Markov process and is not directly observable.
- $\mathbb{P}(X_n \in \mathcal{A} | \Upsilon_1 = v_1, \Upsilon_2 = v_2, \dots, \Upsilon_n = v_n) = \mathbb{P}(X_n \in \mathcal{A} | \Upsilon_n = v_n) = P_{X|\Upsilon}(\mathcal{A} | v_n)$ ,

for every  $n \geq 1$ ,  $v_1, v_2, \dots, v_n$ , and an arbitrary measurable set  $\mathcal{A}$ , where  $P_{X|\Upsilon}(\cdot | \cdot)$  is some probability measure called emission probability. Then, the following holds:

- $\{X_n, \Upsilon_n\}_{n=1}^\infty$  forms a Markov chain on  $\mathcal{X} \times \mathcal{S}_\Upsilon$  with transition probability  $P_{X_1, \Upsilon_1 | X_0, \Upsilon_0}(x_1, v_1 | x_0, v_0) = P_{X|\Upsilon}(x_1 | v_1) \pi_\Upsilon(v_0, v_1)$ .
- Recall the definitions of  $\{\lambda_{x_0, v_0}^{(\pi_\Upsilon)}\}_{(x_0, v_0) \in \mathcal{X} \times \mathcal{S}_\Upsilon}$  and  $\tilde{G}$  in Section III-B. Then, the free energy, mutual information, joint moments, the average MMSE of the linear model with hidden Markov sources in II satisfy:

$$\mathcal{F} = \tilde{G}, \quad (391)$$

$$C = \mathcal{F} \Big|_{\sigma=1} - \frac{1}{2\beta}, \quad (392)$$

$$\lim_{n \rightarrow \infty} \mathbb{E} \left[ X_k^{i_0} \tilde{X}_k^{j_0} \langle X_k \rangle_q^{l_0} \right] = \sum_{x_0, v_0 \in \mathcal{X} \times \mathcal{S}_\Upsilon} \lambda_{x_0, v_0}^{(\pi_\Upsilon)} \mathbb{E} \left[ X_1^{i_0} X^{j_0} \langle X | X_0, \Upsilon_0 \rangle_q^{l_0} | X_0 = x_0, \Upsilon_0 = v_0 \right], \forall i_0, j_0, l_0 \in \mathbb{Z}_+, \quad (393)$$

$$\lim_{n \rightarrow \infty} \frac{1}{n} \mathbb{E} [\| \mathbf{X} - \langle \mathbf{X} \rangle \|_2^2] = \mathbb{E}[X_1^2] - \sum_{x_0, v_0 \in \mathcal{X}_1 \times \mathcal{S}_\Upsilon} \lambda_{x_0, v_0}^{(\pi_\Upsilon)} \mathbb{E}[\langle X | X_0 = x_0, \Upsilon_0 = v_0 \rangle^2], \quad (394)$$

where  $(X_1, X, \langle X | X_0 = x_0, \Upsilon_0 = v_0 \rangle_q)$  is the input and outputs defined in the (composite) single-symbol PME channel in Fig. 2, and  $(X_k, \tilde{X}_k, \langle X_k \rangle)$  is the  $k$ -th symbol in the vector  $\mathbf{X} \in \mathcal{X}^n$ , the  $k$ -th output of the vector retrochannel defined in (12), and its corresponding estimated symbol by using the generalized PME estimate in (14). In addition, in (394),  $X_1 \sim \sum_{v \in \mathcal{S}_\Upsilon} P_{X|\Upsilon}(\cdot | v) \pi_\Upsilon(v_0, v)$ , where  $P_{X|\Upsilon}$  is the stationary emission probability of the hidden Markov process.

*Proof:* First, we show that  $\{(X_n, \Upsilon_n)\}_{n=1}^\infty$  forms a Markov chain with states on  $\mathcal{X} \times \mathcal{S}_\Upsilon$ . Indeed, for any  $n \geq 2$ , by using Markov chains such as  $\Upsilon_n - \Upsilon_{n-1} - (X_{n-1}, \{X_k, \Upsilon_k\}_{k=1}^{n-2})$  and  $X_n - \Upsilon_n -$

( $\{X_k, \Upsilon_k\}_{k=1}^{n-1}$ ), we have

$$\begin{aligned} \mathbb{P}\left(X_n = x, \Upsilon_n = v_n \mid \left\{X_k = x_k, \Upsilon_k = v_k\right\}_{k=1}^{n-1}\right) &= \mathbb{P}\left(\Upsilon_n = v_n \mid \left\{X_k = x_k, \Upsilon_k = v_k\right\}_{k=1}^{n-1}\right) \\ &\quad \times \mathbb{P}\left(X_n = x_n \mid \Upsilon_n = v_n, \left\{X_k = x_k, \Upsilon_k = v_k\right\}_{k=1}^{n-1}\right) \end{aligned} \quad (395)$$

$$= \mathbb{P}\left(\Upsilon_n = v_n \mid \Upsilon_{n-1} = v_{n-1}\right) \mathbb{P}\left(X_n = x_n \mid \Upsilon_n = v_n\right) \quad (396)$$

$$= \mathbb{P}\left(\Upsilon_n = v_n \mid \Upsilon_{n-1} = v_{n-1}, X_{n-1} = x_{n-1}\right) \mathbb{P}\left(X_n = x_n \mid \Upsilon_n = v_n, \Upsilon_{n-1} = v_{n-1}, X_{n-1} = x_{n-1}\right) \quad (397)$$

$$= \mathbb{P}\left(X_n = x_n, \Upsilon_n = v_n \mid X_{n-1} = x_{n-1}, \Upsilon_{n-1} = v_{n-1}\right). \quad (398)$$

Hence, (391), (392), and (393) are direct results of Theorem 15 and Theorem 18. Now, by (381), we also have

$$\mathbb{E}[\|\mathbf{X} - \langle \mathbf{X} \rangle\|_2^2] = \sum_{k=1}^n \mathbb{E}[|X_k - \langle \mathbf{X} \rangle_k|^2] \quad (399)$$

$$= \sum_{k=1}^n \mathbb{E}[X_k^2] - \sum_{k=1}^n \mathbb{E}[\langle X_k \rangle^2]. \quad (400)$$

Now, by (393), we have as  $n \rightarrow \infty$ ,

$$\mathbb{E}[\langle X_k \rangle^2] = \sum_{x_0, v_0 \in \mathcal{X} \times \mathcal{S}_\Upsilon} \lambda_{x_0, v_0}^{(\pi_\Upsilon)} \mathbb{E}[\langle X_1 | X_0 = x_0, \Upsilon_0 = v_0 \rangle^2], \quad \forall k \in \{1, 2, \dots, n\}. \quad (401)$$

In addition, for all  $k \in \{1, 2, \dots, n\}$ , we also have

$$\mathbb{E}[X_k^2] = \mathbb{E}[\mathbb{E}[X_k^2 | X_{k-1}, \Upsilon_{k-1}]] \quad (402)$$

$$= \mathbb{E}[\mathbb{E}[X_1^2 | X_0, \Upsilon_0]] \quad (403)$$

$$= \mathbb{E}[X_1^2] \quad (404)$$

$$= \mathbb{E}[\mathbf{X}_1^2], \quad (405)$$

where (402) follows from the tower property [36], and (403) follows from the time-homogeneity of Markov process  $\{X_n\}_{n=1}^\infty$ .

From (400), (401), and (405), as  $n \rightarrow \infty$ , we have

$$\mathbb{E}[\|\mathbf{X} - \langle \mathbf{X} \rangle\|_2^2] = n(\mathbb{E}[\mathbf{X}_1^2] - \sum_{x_0, v_0 \in \mathcal{X} \times \mathcal{S}_\Upsilon} \lambda_{x_0, v_0}^{(\pi_\Upsilon)} \mathbb{E}[\langle X_1 | X_0 = x_0, \Upsilon_0 = v_0 \rangle^2]), \quad (406)$$

which leads to (394). Note that for the hidden Markov process with initial states  $\nu_0$  and the emission probability  $P_{X_1|\Upsilon_1}(\cdot|\cdot)$ , we have

$$P_{X_1}(x_1) = \sum_{v \in \mathcal{S}_\Upsilon} P_{X_1, \Upsilon_1}(x_1, v) \quad (407)$$

$$= \sum_{v \in \mathcal{S}_\Upsilon} P_{X|\Upsilon}(x_1 | v) \pi_\Upsilon(\nu_0, v), \quad \forall x_1 \in \mathcal{X}. \quad (408)$$

■

## APPENDIX A

### SOME NEW RESULTS ON LARGE DEVIATIONS FOR MARKOV CHAINS INDUCED BY THE CHANNEL SETTING

We begin this section with some well-known results on large deviations theory. Based on these results, we develop some large deviations results for the purpose of asymptotic analysis in this paper. For brevity, we only state some existing results in their versions for finite state-space Markov chains such as Theorem 29. However, the Perron-Frobenius eigenvalue concept still exists for Markov chains with infinitely countable-state or uncountable state space (e.g. [37]).

Consider a general sequence of random vectors  $\mathbf{Y}_n \in \mathbb{R}^d$ . Let  $\phi_n(\theta) = \frac{1}{n} \log \mathbb{E}[\exp(n\langle \theta, \mathbf{Y}_n \rangle)]$ . Define the Legendre-Fenchel transform:

$$I(x) := \sup_{\theta \in \mathbb{R}^d} (\langle \theta, x \rangle - \phi(\theta)). \quad (409)$$

**Theorem 22** (Gärtner-Ellis Theorem [38]). *Given a sequence of random vectors  $\mathbf{Y}_n$ , suppose that*

$$\lim_{n \rightarrow \infty} \phi_n(\theta) = \phi(\theta), \quad (410)$$

*which exists for all  $\theta \in \mathbb{R}^d$ . Furthermore, suppose  $\phi(\theta)$  is finite and differentiable everywhere on  $\mathbb{R}^d$ . Then the following large deviations bounds hold for  $I$  defined by (409)*

$$\limsup_n \frac{1}{n} \log \mathbb{P}(\mathbf{Y}_n \in \mathbf{F}) \leq - \inf_{x \in \mathbf{F}} I(x), \quad \text{for any closed set } \mathbf{F} \in \mathbb{R}^d, \quad (411)$$

$$\liminf_n \frac{1}{n} \log \mathbb{P}(\mathbf{Y}_n \in \mathbf{U}) \geq - \inf_{x \in \mathbf{U}} I(x), \quad \text{for all open set } \mathbf{U} \in \mathbb{R}^d. \quad (412)$$

**Theorem 23** (Varadhan Theorem [39]). *Recall the definition of Legendre-Fenchel transform  $I$  in (409). Assume that a large deviation principle holds for a sequence of probability measures  $\{P_n\}_{n=1}^\infty$  defined on the Borel subsets of a Polish (complete separable metric) space  $\mathcal{X}$ , with rate function  $I(x)$ . Then,*

$$\lim_{n \rightarrow \infty} \frac{1}{n} \log \int e^{nF(x)} dP_n(x) = \sup_{x \in \mathcal{X}} [F(x) - I(x)] \quad (413)$$

*for and bounded and continuous function  $F : \mathcal{X} \rightarrow \mathbf{R}$ .*

Our goal is to derive the large deviations bounds for empirical means of states in a Markov chain. For this purpose, we need to recall the Perron-Frobenius Theorem for non-negative irreducible matrices [31].

**Definition 24.** A non-negative matrix  $C \in \mathbb{R}^{N \times N}$  is a matrix in which all elements are equal to or greater than zero, that is,  $C_{ij} \geq 0, \forall i, j$ . If  $C_{ij} > 0, \forall i, j$ , the  $C$  is referred to as a positive matrix.

**Definition 25.** A  $C \in \mathbb{C}^{N \times N}$  is said to be reducible if there exists an  $N \times N$  permutation matrix  $P$  such that

$$P^T A P = \begin{bmatrix} \tilde{C}_{11} & \tilde{C}_{12} \\ 0 & \tilde{C}_{22} \end{bmatrix}, \quad (414)$$

where  $\tilde{C}_{11}$  and  $\tilde{C}_{22}$  are square matrices of order less than  $N$ . If no such  $P$  exists then  $C$  is irreducible.

**Definition 26.** Let  $P_1, P_2, \dots, P_N$  be distinct points of the complex plane and let  $C \in \mathbb{C}^{N \times N}$ . For each non-element  $C_{ij}$  of  $C$ , connect  $P_i$  and  $P_j$  with a directed line  $\overrightarrow{P_i P_j}$ . The resulting figure in the complex plane is a directed graph for  $C$ . We say that a directed graph is strongly connected if, for each pair of nodes  $P_i, P_j$  with  $i \neq j$ , there is a direct path

$$\overrightarrow{P_i P_{k_1}}, \overrightarrow{P_{k_1} P_{k_2}}, \dots, \overrightarrow{P_{k_{r-1}} P_j} \quad (415)$$

connecting  $P_i$  to  $P_j$ . Hence, the path consists of  $r$  directed lines. Observe that nodes  $i$  and  $j$  may be connected by a directed path while  $j$  and  $i$  are not.

**Theorem 27.** [31, Sec. 15.1] A square matrix  $C$  is irreducible if the directed graph for matrix  $C$  is strongly connected.

**Remark 28.** It is clear that the stochastic matrix of an irreducible Markov chain belongs to the class of all irreducible matrices. However, the class of all irreducible matrices are not limited to the class of all stochastic matrices of irreducible Markov chains. The following well-known theorem works for this general class of matrices.

**Theorem 29** (Perron-Frobenius Theorem [31]). If the matrix  $C \in \mathbb{R}^{N \times N}$  is non-negative and irreducible, then

- 1) The matrix  $C$  has a positive eigenvalue,  $\rho(C) > 0$ , equal to the spectral radius of  $C$ ;
- 2) The eigenvalue  $\rho(C)$  has algebraic multiplicity 1.
- 3) There is a positive right eigenvector associated with the eigenvalue  $\rho(C)$  which is unique up to a positive scaling factor;

- 4) *There is a positive left eigenvector associated with the eigenvalue  $\rho(C)$  which is unique up to a positive scaling factor;*

The positive eigenvalue  $\rho(C)$  in Theorem 29 is called Perron-Frobenius eigenvalue of the matrix  $C$ . The following corollary of the Perron-Frobenius Theorem shows that the essential rate of growth of the sequence of matrices  $C^n$  is  $(\rho(C))^n$ .

**Corollary 30.** *Assume that  $C \in \mathbb{R}^{N \times N}$  is non-negative and irreducible. Then, for every positive vector  $h = (h_1, h_2, \dots, h_N)$ , the following holds*

$$\lim_{n \rightarrow \infty} \frac{1}{n} \log \left[ \sum_{j=1}^N C_{i,j}^n h_j \right] = \log \rho(C), \quad \forall i \in \{1, 2, \dots, N\}. \quad (416)$$

*Proof:* Since  $C$  is non-negative and irreducible, it holds that  $C_{i,j} \geq 0$  for all  $i, j \in [N] \times [N]$  and there exists a positive integer  $r$  such that all the elements of  $C^r$  are strictly positive by Theorem 27. Let  $\nu$  be an eigenvector associated with the Perron-Frobenius eigenvalue of  $C$ . Let  $\alpha = \max_j \nu_j$ ,  $\beta = \min_j \nu_j$ ,  $\gamma = \max_j h_j$ , and  $\delta = \min_j h_j$ . We have

$$\frac{\gamma}{\beta} C_{i,j}^n \nu_j \geq C_{i,j}^n h_j \geq \frac{\delta}{\alpha} C_{i,j}^n \nu_j. \quad (417)$$

Therefore, we have

$$\lim_{n \rightarrow \infty} \frac{1}{n} \log \left[ \sum_{j=1}^N C_{i,j}^n h_j \right] = \lim_{n \rightarrow \infty} \frac{1}{n} \log \left[ \sum_{j=1}^N C_{i,j}^n \nu_j \right] \quad (418)$$

$$= \lim_{n \rightarrow \infty} \frac{1}{n} \log \left( (\rho(C))^n \sum_{i=1}^N \nu_i \right) \quad (419)$$

$$= \log \rho(C). \quad (420)$$

■

**Lemma 31.** *Let  $\{S_n\}_{n=1}^{\infty}$  be an i.i.d. sequence of random variable on a finite set  $S \subset \mathbb{R}^+$ . Let  $\mathbf{X} := \{X_n\}_{n=1}^{\infty}$  be a Markov chain with states on a Polish space  $\mathcal{X}$  with the transition matrix  $P = \{P_{i,j}\}_{i,j \in \mathcal{X}}$ . Assume this Markov chain is irreducible. Set  $\mathbf{X}^{(0)} = \mathbf{X}$ . Let  $\mathbf{X}^{(a)} := \{X_n^{(a)}\}_{n=1}^{\infty}$  be a set of  $\nu$  replica sequences with (postulated) distribution  $q_{\mathbf{X}}$  for each  $a = 1, 2, \dots, \nu$ . This means that*

$$p_{\mathbf{X}^{(0)} \mathbf{X}^{(1)} \mathbf{X}^{(2)} \dots \mathbf{X}^{(\nu)}}(x^{(0)}, x^{(1)}, x^{(2)}, \dots, x^{(\nu)}) \sim p_{\mathbf{X}}(x^{(0)}) \prod_{i=1}^{\nu} q_{\mathbf{X}}(x^{(i)}). \quad (421)$$

*Define a new sequence of  $(\nu + 1) \times (\nu + 1)$  random matrices  $\{\mathbf{Q}_n\}_{n=1}^{\infty}$  such that*

$$Q_n^{(a,b)} = S_n X_n^{(a)} X_n^{(b)} \quad (422)$$

for all  $a \in [\nu]$  and  $b \in [\nu]$  and for all  $n = 1, 2, \dots$ . Then,  $\{\mathbf{Q}_n\}_{n=1}^\infty$  is also an irreducible Markov chain with states on  $\mathcal{Q}$ .

*Proof:* Let  $\sigma(\mathbf{Q}_1, \mathbf{Q}_2, \dots, \mathbf{Q}_{n-1})$  be the  $\sigma$ -algebra generated by random matrices  $\mathbf{Q}_1, \mathbf{Q}_2, \dots, \mathbf{Q}_{n-1}$  and  $\sigma(\mathbf{Q}_k)$  be the sigma-algebra generated by  $\mathbf{Q}_k$  for all  $k \in \mathbb{Z}^+$ . Observe that

$$\mathbf{Q}_k = S_k \begin{bmatrix} X_k^{(0)} & X_k^{(1)} & \dots & X_k^{(\nu)} \end{bmatrix} \begin{bmatrix} X_k^{(0)} \\ X_k^{(1)} \\ \dots \\ X_k^{(\nu)} \end{bmatrix}, \quad \forall k. \quad (423)$$

Hence, it holds that

$$\sigma(\mathbf{Q}_k) = \sigma(S_k, X_k^{(0)}, X_k^{(1)}, \dots, X_k^{(\nu)}) \quad (424)$$

since a countable union of Borel sets is a Borel set and there are only a countable number of tuples  $(s, x) \in \mathcal{S} \times \mathcal{X}^{\nu+1}$  such that  $sxx^T = Q$  for each  $Q \in \mathcal{Q}$ . The existence of only a countable number of tuples  $(s, x)$  above follows from the assumption that for each  $q \in \mathbb{R}$ , there are only a countable number of pair  $(s, x) \in \mathcal{S} \times \mathcal{X}$  such that  $sx^2 = q$  (cf. Section II) and the fact that for each symmetric matrix  $Q \in \mathcal{Q}$ , there are only two different decompositions

$$Q = yy^T = (-y)(-y)^T \quad (425)$$

for some  $y \in \mathcal{X}^{\nu+1}$  by the unique up to the sign of the Singular Value Decomposition (SVD) [31].

In addition, we also have

$$\sigma(\mathbf{Q}_1, \mathbf{Q}_2, \dots, \mathbf{Q}_{n-1}) = \sigma\left(\{S_k, X_k^{(0)}, X_k^{(1)}, \dots, X_k^{(\nu)}\}_{k=0}^{n-1}\right). \quad (426)$$

Let  $Q \in \mathcal{Q}$ , where  $\mathcal{Q}$  is defined in (3). Observe that

$$\mathbb{P}(\mathbf{Q}_n = Q | \sigma(\mathbf{Q}_1, \mathbf{Q}_2, \dots, \mathbf{Q}_{n-1}))$$

$$= \mathbb{P}((S_n, X_n^{(0)}, X_n^{(1)}, \dots, X_n^{(\nu)}) \in \{(s, x) \in \mathcal{S} \times \mathcal{X}^{\nu+1} : sxx^T = Q\} | \sigma(\mathbf{Q}_1, \mathbf{Q}_2, \dots, \mathbf{Q}_{n-1})) \quad (427)$$

$$= \mathbb{P}((S_n, X_n^{(0)}, X_n^{(1)}, \dots, X_n^{(\nu)}) \in \{(s, x) \in \mathcal{S} \times \mathcal{X}^{\nu+1} : sxx^T = Q\} | \sigma(\{S_k, X_k^{(0)}, X_k^{(1)}, \dots, X_k^{(\nu)}\}_{k=0}^{n-1})) \quad (428)$$

$$= \mathbb{P}(S_n \in \{s : (x, s) \in \mathcal{S} \times \mathcal{X}^{\nu+1}, sxx^T = Q\})$$

$$\times \mathbb{P}((X_n^{(0)}, X_n^{(1)}, \dots, X_n^{(\nu)}) \in \{x : (s, x) \in \mathcal{S} \times \mathcal{X}^{\nu+1}, sxx^T = Q\} | \sigma(\{X_k^{(0)}, X_k^{(1)}, \dots, X_k^{(\nu)}\}_{k=0}^{n-1})) \quad (429)$$

$$= \mathbb{P}(S_n \in \{s : (x, s) \in \mathcal{S} \times \mathcal{X}^{\nu+1}, sxx^T = Q\})$$



$$\times \mathbb{P}((X_n^{(0)}, X_n^{(1)}, \dots, X_n^{(\nu)}) \in \{x : (s, x) \in \mathcal{S} \times \mathcal{X}^{\nu+1}, sxx^T = Q\} | \sigma(X_{n-1}^{(0)}, X_{n-1}^{(1)}, \dots, X_{n-1}^{(\nu)})) \quad (430)$$

$$= \mathbb{P}((S_n, X_n^{(0)}, X_n^{(1)}, \dots, X_n^{(\nu)}) \in \{(s, x) \in \mathcal{S} \times \mathcal{X}^{\nu+1} : sxx^T = Q\} | \sigma(X_{n-1}^{(0)}, X_{n-1}^{(1)}, \dots, X_{n-1}^{(\nu)})) \quad (431)$$

$$= \mathbb{P}((S_n, X_n^{(0)}, X_n^{(1)}, \dots, X_n^{(\nu)}) \in \{(s, x) \in \mathcal{S} \times \mathcal{X}^{\nu+1} : sxx^T = Q\} | \sigma(S_{n-1}, X_{n-1}^{(0)}, X_{n-1}^{(1)}, \dots, X_{n-1}^{(\nu)})) \quad (432)$$

$$= \mathbb{P}(\mathbf{Q}_n = Q | \sigma(\mathbf{Q}_{n-1})) \quad (433)$$

$$= \mathbb{P}(\mathbf{Q}_n = Q | \mathbf{Q}_{n-1}), \quad (434)$$

where (429) follows from  $\{S_n\}_{n=1}^\infty$  is independent of  $\{X_n\}_{n=1}^\infty$  and  $\{S_n\}$  is independent of  $\sigma(S_1, S_2, \dots, S_{n-1})$ , (430) follows from the Markov property of the sequence  $\{X_n\}_{n=1}^\infty$ , (431) and (432) follows from the same reasons as (429), (433) follows from (424), and (434) follows from conventional definition in probability.

From (434),  $\{\mathbf{Q}_n\}_{n=1}^\infty$  is a Markov process. Finally, the irreducible property follows from that of the Markov chain  $\{X_n\}$ . This concludes our proof of Lemma 31.  $\blacksquare$

Now, consider the homogeneous Markov chain with states in the set  $\mathcal{Q}$  as mentioned in Lemma 31. This Markov chains have  $M$  states  $\bar{Q}_0, \bar{Q}_1, \dots, \bar{Q}_M$  where  $M = |\mathcal{Q}| - 1$ . We define

$$P_{\bar{Q}} = \begin{bmatrix} e^{\text{tr}(\bar{Q}\bar{Q}_0)}P(\bar{Q}_0|\bar{Q}_0) & e^{\text{tr}(\bar{Q}\bar{Q}_1)}P(\bar{Q}_1|\bar{Q}_0) & \dots & e^{\text{tr}(\bar{Q}\bar{Q}_M)}P(\bar{Q}_M|\bar{Q}_0) \\ e^{\text{tr}(\bar{Q}\bar{Q}_0)}P(\bar{Q}_0|\bar{Q}_1) & e^{\text{tr}(\bar{Q}\bar{Q}_1)}P(\bar{Q}_1|\bar{Q}_1) & \dots & e^{\text{tr}(\bar{Q}\bar{Q}_M)}P(\bar{Q}_M|\bar{Q}_1) \\ \vdots & \vdots & \ddots & \vdots \\ e^{\text{tr}(\bar{Q}\bar{Q}_0)}P(\bar{Q}_0|\bar{Q}_M) & e^{\text{tr}(\bar{Q}\bar{Q}_1)}P(\bar{Q}_1|\bar{Q}_M) & \dots & e^{\text{tr}(\bar{Q}\bar{Q}_M)}P(\bar{Q}_M|\bar{Q}_M) \end{bmatrix}, \quad (435)$$

where

$$P(\bar{Q}_j|\bar{Q}_i) := \mathbb{P}(\mathbf{Q}_1 = \bar{Q}_j | \mathbf{Q}_0 = \bar{Q}_i), \quad (436)$$

and  $\mathbf{Q}_1$  and  $\mathbf{Q}_0$  are random matrices defined in Lemma 31.

Then,  $P_{\bar{Q}}$  is an irreducible non-negative matrix, since  $P = \{P(\bar{Q}_j|\bar{Q}_i)\}_{0 \leq i, j \leq M}$  is such a matrix by the fact that  $P_{\bar{Q}} = P \times \text{diag}(e^{\text{tr}(\bar{Q}\bar{Q}_1)}, e^{\text{tr}(\bar{Q}\bar{Q}_2)}, \dots, e^{\text{tr}(\bar{Q}\bar{Q}_M)})$  and Definition 25. Let  $\rho(P_{\bar{Q}})$  denote the Perron-Frobenius eigenvalue of the non-negative irreducible matrix  $P_{\bar{Q}}$ .

**Theorem 32.** *Let  $\{X_n\}_{n=1}^\infty$  be a Markov chain defined in Lemma 31 and recall the definition of  $\{\mathbf{Q}_n\}_{n=1}^\infty$  in this lemma. Then,  $\{\mathbf{T}_n := \frac{1}{n} \sum_{k=1}^n \mathbf{Q}_k\}_{n=1}^\infty$  satisfies the large deviation bounds with rate function  $I(Q) = \sup_{\bar{Q}}(\text{tr}(\bar{Q}Q) - \log \rho(P_{\bar{Q}}))$ , where  $\rho(P_{\bar{Q}})$  is the Perron-Frobenius eigenvalue of the matrix  $P_{\bar{Q}}$*

defined in (435). Specifically, for every initial state  $\bar{Q}_0 \in \mathcal{Q}$ , every closed set  $F \subset \mathcal{Q}$  and every open set  $U \in \mathcal{Q}$ , the following hold:

$$\limsup_n \frac{1}{n} \log \mathbb{P}(\mathbf{T}_n \in F | \bar{Q}_0) \leq - \inf_{Q \in F} I(Q), \quad (437)$$

$$\liminf_n \frac{1}{n} \log \mathbb{P}(\mathbf{T}_n \in U | \bar{Q}_0) \leq - \inf_{Q \in U} I(Q). \quad (438)$$

*Proof:* We will show that the sequence of functions  $\phi_n(\tilde{Q}) = \frac{1}{n} \log \mathbb{E}[e^{\text{tr}(n\tilde{Q}\mathbf{T}_n)}]$  has a limit  $\phi(\tilde{Q})$  which is finite and differentiable everywhere. Recall the definition of the matrix  $P_{\tilde{Q}}$  in (435). Given the starting state  $\bar{Q}_0$ , we have

$$\log \mathbb{E}[e^{\text{tr}(n\tilde{Q}\mathbf{T}_n)}] = \log \sum_{\bar{Q}_1, \bar{Q}_2, \dots, \bar{Q}_n \in \mathcal{Q}} P(\bar{Q}_1 | \bar{Q}_0) P(\bar{Q}_2 | \bar{Q}_1) \cdots P(\bar{Q}_n | \bar{Q}_{n-1}) \prod_{k=1}^n e^{\text{tr}(\tilde{Q}\bar{Q}_k)} \quad (439)$$

$$= \log \left[ \sum_{\bar{Q}_n \in \mathcal{Q}} P_{\tilde{Q}}^n(\bar{Q}_n | \bar{Q}_0) \right], \quad (440)$$

where  $P_{\tilde{Q}}^n(\bar{Q}_j | \bar{Q}_i)$  denotes the  $(i, j)$ -th entry of the matrix  $P_{\tilde{Q}}^n$ . Let  $h_j = \underline{1}$  and apply Corollary 30, we obtain

$$\lim_n \phi_n(\tilde{Q}) = \log \rho(P_{\tilde{Q}}). \quad (441)$$

Since  $\log \rho(P_{\tilde{Q}})$  is the spectral radius of  $P_{\tilde{Q}}$ , hence it is differentiable with respect to  $\tilde{Q}$ . Thus, the Gärtner-Ellis can be applied.  $\blacksquare$

**Corollary 33.** [4, Eq. (107)] Assume that  $\{X_n\}_{n=1}^\infty$  is a memoryless source which, together with another i.i.d. sequence  $\{S_n\}_{n=1}^\infty$ , induces an i.i.d. sequence of random matrices  $\{\mathbf{Q}_n\}_{n=1}^\infty \sim P_Q$  as defined in Lemma 31. Then, the sequence of random matrices  $\{\mathbf{T}_n = \frac{1}{n} \sum_{k=1}^n \mathbf{Q}_k\}_{n=1}^\infty$  satisfies the large deviations bounds with rate function

$$I(Q) = \sup_{\tilde{Q}} (\text{tr}(\tilde{Q}Q) - \log \mathcal{M}(\tilde{Q})) \quad (442)$$

where  $\mathcal{M}(\tilde{Q}) := \mathbb{E}_{\mathbf{Q}}[e^{\text{tr}(\tilde{Q}\mathbf{Q})}]$  is the moment generating function of the random matrix  $\mathbf{Q}$  on  $\mathcal{Q}$  under the distribution

$$P(\mathbf{Q} = Q) = \mathbb{P} \left( S_1 \begin{bmatrix} X_1^{(0)} & X_1^{(1)} & \cdots & X_1^{(\nu)} \end{bmatrix} \begin{bmatrix} X_1^{(0)} \\ X_1^{(1)} \\ \cdots \\ X_1^{(\nu)} \end{bmatrix} = Q \right) \quad (443)$$

$$= \sum_{s, x \in \mathcal{S} \times \mathcal{X}^{\nu+1} : sxx^T = Q} \mathbb{P} \left( (S_1, X_1^{(0)}, X_1^{(1)}, \dots, X_1^{(\nu)}) = (s, x) \right) \quad (444)$$

for all  $Q \in \mathcal{Q}$ , where  $X_1^{(a)}$  be the first sample of replicas  $\mathbf{X}^{(a)}$  defined in Lemma 31.

**Remark 34.** For the i.i.d. case, the rate function  $I(Q)$  can be estimated since  $\log \mathcal{M}(\tilde{Q})$  is in the form of an expectation. However, in the more general Markov setting as in Theorem 32, the estimation of Perron-Frobenius is very challenging. In the next sections, we provide bounds on this eigenvalue by making use of the structure of the Markov chain.

*Proof:* For this special case, the matrix  $P_{\tilde{Q}}$ , which is defined in (435), becomes

$$P_{\tilde{Q}} = \begin{bmatrix} P(\tilde{Q}_0)e^{\text{tr}(\tilde{Q}\tilde{Q}_0)} & P(\tilde{Q}_1)e^{\text{tr}(\tilde{Q}\tilde{Q}_1)} & \dots & P(\tilde{Q}_M)e^{\text{tr}(\tilde{Q}\tilde{Q}_M)} \\ P(\tilde{Q}_0)e^{\text{tr}(\tilde{Q}\tilde{Q}_0)} & P(\tilde{Q}_1)e^{\text{tr}(\tilde{Q}\tilde{Q}_1)} & \dots & P(\tilde{Q}_M)e^{\text{tr}(\tilde{Q}\tilde{Q}_M)} \\ \vdots & \vdots & \vdots & \vdots \\ P(\tilde{Q}_0)e^{\text{tr}(\tilde{Q}\tilde{Q}_0)} & P(\tilde{Q}_1)e^{\text{tr}(\tilde{Q}\tilde{Q}_1)} & \dots & P(\tilde{Q}_M)e^{\text{tr}(\tilde{Q}\tilde{Q}_M)} \end{bmatrix}. \quad (445)$$

This matrix has the Perron-Frobenius eigenvalue

$$\rho(P_{\tilde{Q}}) = \text{tr}(P_{\tilde{Q}}) \quad (446)$$

$$= \sum_{i=0}^M P(\tilde{Q}_i)e^{\text{tr}(\tilde{Q}\tilde{Q}_i)} \quad (447)$$

$$= \mathbb{E}_{\mathbf{Q}}[e^{\text{tr}(\tilde{Q}\mathbf{Q})}] \quad (448)$$

$$= \mathcal{M}(\tilde{Q}). \quad (449)$$

■

**Theorem 35.** Let  $\mathcal{X}$  be a Polish space with finite cardinality and a irreducible Markov chain  $\mathbf{X} := \{X_n\}_{n=1}^{\infty}$  defined on  $\mathcal{X}$  and  $\nu$  be a positive integer number. Let  $X_n^{(a)}$  for  $a \in \{1, 2, \dots, \nu\}$  be replicas of the Markov process  $\mathbf{X}$ . Recall the definition of the sequence  $\mathbf{Q}_n$  in Lemma 31 and  $\mathbf{T}_n = \frac{1}{n} \sum_{j=1}^n \mathbf{Q}_j$ . Let  $P_n(U) := \mathbb{P}(\mathbf{T}_n \in U)$  for any measurable set  $U$  on the  $\sigma$ -algebra generated by  $\{\mathbf{Q}_n\}_{n=1}^{\infty}$ . Then, for and bounded and continuous function  $F : \mathcal{Q} \rightarrow \mathbf{R}$

$$\lim_{n \rightarrow \infty} \frac{1}{n} \log \mathbb{E}[e^{nF(\mathbf{T}_n)}] = \lim_{n \rightarrow \infty} \frac{1}{n} \log \int e^{nF(Q)} dP_n(Q) \quad (450)$$

$$= \sup_Q \left[ F(Q) - I(Q) \right] \quad (451)$$

where  $I(Q) = \sup_{\tilde{Q}} (\text{tr}(\tilde{Q}\mathbf{Q}) - \log \rho(P_{\tilde{Q}}))$  and  $\rho(P_{\tilde{Q}})$  is the Perron-Frobenius eigenvalue of the matrix  $P_{\tilde{Q}} = \{e^{\text{tr}(\tilde{Q}\tilde{Q}_i)} P_{\tilde{Q}_i, \tilde{Q}_j}\}_{0 \leq i, j \leq M}$  and  $M = |\mathcal{Q}| - 1$ , where  $\mathcal{Q}$  is defined in (3).

*Proof:* Equation (450) is an application of the change of measures [36]. Equation (451) is a direct application of Theorem 23 and Theorem 32. ■

## APPENDIX B

## PERRON-FROBENIUS EIGENVALUE ESTIMATION

To estimate  $I(Q) = \sup_{\tilde{Q}} (\text{tr}(\tilde{Q}Q) - \log \rho(P_{\tilde{Q}}))$ , we need to find the maximizer  $\tilde{Q}$ . By taking derivatives of the objective function, it is easy to see that  $\tilde{Q}$  must satisfy the following critical equation:

$$Q = \frac{\partial \log \rho(P_{\tilde{Q}})}{\partial \tilde{Q}}. \quad (452)$$

Next, we find the value of  $\frac{\partial \log \rho(P_{\tilde{Q}})}{\partial \tilde{Q}}$ . To derive this quantity, we use the following theorems:

**Definition 36.** [40, p. 6] Let  $A \in \mathbb{R}^{n \times n}$  and consider the matrix equations

$$(1) \quad ABA = A, \quad (2) \quad BAB = B, \quad (3) \quad BA = AB. \quad (453)$$

Let  $\mu = \{1, 2, 3\}$  and  $\nu \subseteq \mu$ . A matrix  $B \in \mathbb{R}^n$  satisfying equations (i) for all  $i \in \nu$  is called a (generalized)  $\nu$ -inverse of  $A$ . Any matrix  $A \in \mathbb{R}^{n \times n}$  has a  $\{1, 2\}$ -inverse. In fact, if  $A$  is singular then  $A$  has infinitely many  $\{1, 2\}$ -inverses. If  $A$  is nonsingular, then its only  $\{1, 2\}$ -inverse is  $A^{-1}$ . For  $\nu = \mu$ , a  $\nu$ -inverse of  $A$ , if exists, is unique and is called the group (generalized) inverse of  $A$  and denoted by  $A^\#$ . A necessary and sufficient condition for  $A^\#$  to exist is that  $R(A)$  and  $N(A)$  be complementary subspaces in  $\mathbb{R}^n$ , in which case  $AA^\#$  is the projection matrix of  $\mathbb{R}^n$  onto  $R(A)$  along  $N(A)$ .

**Definition 37.** Let

$$\Phi_{n,n} := \left\{ A = (a_{ij}) \in \mathbb{R}^{n \times n} \mid a_{ij} \geq 0 \quad i \neq j \quad \text{and} \quad A \text{ is irreducible} \right\}. \quad (454)$$

**Definition 38.** Let  $A \in \mathbb{R}^n$  be an essentially nonnegative matrix. Then  $Q := tI - A, t \geq \rho(A)$  is called an  $n \times n$   $M$ -matrix. Note that any  $M$ -matrix  $Q$  belongs to the set

$$Z^{n,n} := \left\{ A = (a_{ij}) \in \mathbb{R}^{n \times n} \mid a_{ij} \leq 0 \quad \text{for} \quad i \neq j \right\}. \quad (455)$$

If  $A \in \Phi_{n,n}$  and  $t = r(A)$ , the matrix  $Q$  given by  $Q = \rho(A)I - A$  is called an  $n \times n$  singular irreducible  $M$ -matrix.

**Lemma 39.** [40, p. 7] If  $A$  is an  $n \times n$  singular irreducible  $M$ -matrix, the following holds:

- there exists positive vectors  $\psi$  and  $\lambda$  such that  $Q\psi = 0$  and  $\lambda^T Q = 0$  to which we shall refer to as right and left Perron-Frobenius vectors of  $Q$ . These vectors are unique, up to positive scaling.
- $Q^\#$  exists as 0 is a simple eigenvalue of  $Q$ .
- $I - QQ^\#$  is the projection matrix of  $\mathbb{R}^n$  onto  $N(Q)$  along  $R(Q)$ .
- if  $\psi$  and  $\lambda$  are right and left Perron-Frobenius vectors of  $Q$  normalized so that  $\lambda^T \psi = 1$ , then

$$I - QQ^\# = \psi \lambda^T. \quad (456)$$

**Lemma 40.** [40, Lemma 3.1] For any  $A \in \Phi_{n,n}$ , we have

$$\frac{\partial \rho(A)}{\partial A} = (I - QQ^\#)^T, \quad (457)$$

where  $Q = \rho(A)I - A$  and  $Q^\#$  is the group inverse of  $Q$ .

From lemmas 39 and 40, the following theorem holds

**Theorem 41.** For any  $A \in \Phi_{n,n}$ , we have

$$\frac{\partial \rho(A)}{\partial A} = \lambda \psi^T, \quad (458)$$

where  $\frac{\partial \rho(A)}{\partial_{ij}}$  is the first-order partial derivatives of  $\rho(\cdot)$  at  $A$  with respect to  $(i, j)$ -th element is given by

$$\lim_{t \rightarrow 0} \frac{\rho(A + tE_{ij}) - \rho(A)}{t}, \quad (459)$$

where  $E_{ij}$  is the  $n \times n$  matrix whose  $(i, j)$ -th entry is 1 and whose remaining entries are 0.

**Corollary 42.** Assume that  $\{X_n\}_{n=1}^\infty$  is a memoryless source which induces an i.i.d. sequence  $\{\mathbf{Q}_n\}_{n=1}^\infty \sim P_{\mathbf{Q}}$  as Lemma 31. Then, the following holds

$$\frac{\partial \log \rho(P_{\tilde{\mathbf{Q}}})}{\partial \tilde{\mathbf{Q}}}(\tilde{\mathbf{Q}}) = \frac{1}{\rho(P_{\tilde{\mathbf{Q}}})} \mathbb{E}[\mathbf{Q} \exp(\text{tr}(\tilde{\mathbf{Q}}\mathbf{Q}))], \quad (460)$$

which coincides with the result in [4, Eq. (112)].

*Proof:* For this special case,  $P_{\tilde{\mathbf{Q}}}$  which is defined in (435), becomes

$$P_{\tilde{\mathbf{Q}}} = \begin{bmatrix} P(\bar{\mathbf{Q}}_0)e^{\text{tr}(\tilde{\mathbf{Q}}\bar{\mathbf{Q}}_0)} & P(\bar{\mathbf{Q}}_1)e^{\text{tr}(\tilde{\mathbf{Q}}\bar{\mathbf{Q}}_1)} & \dots & P(\bar{\mathbf{Q}}_M)e^{\text{tr}(\tilde{\mathbf{Q}}\bar{\mathbf{Q}}_M)} \\ P(\bar{\mathbf{Q}}_0)e^{\text{tr}(\tilde{\mathbf{Q}}\bar{\mathbf{Q}}_0)} & P(\bar{\mathbf{Q}}_1)e^{\text{tr}(\tilde{\mathbf{Q}}\bar{\mathbf{Q}}_1)} & \dots & P(\bar{\mathbf{Q}}_M)e^{\text{tr}(\tilde{\mathbf{Q}}\bar{\mathbf{Q}}_M)} \\ \vdots & \vdots & \vdots & \vdots \\ P(\bar{\mathbf{Q}}_0)e^{\text{tr}(\tilde{\mathbf{Q}}\bar{\mathbf{Q}}_0)} & P(\bar{\mathbf{Q}}_1)e^{\text{tr}(\tilde{\mathbf{Q}}\bar{\mathbf{Q}}_1)} & \dots & P(\bar{\mathbf{Q}}_M)e^{\text{tr}(\tilde{\mathbf{Q}}\bar{\mathbf{Q}}_M)} \end{bmatrix}. \quad (461)$$

This matrix has the Perron-Frobenius eigenvalue

$$\rho(P_{\tilde{\mathbf{Q}}}) = \text{tr}(P_{\tilde{\mathbf{Q}}}) \quad (462)$$

$$= \sum_{i=0}^M P(\bar{\mathbf{Q}}_i)e^{\text{tr}(\tilde{\mathbf{Q}}\bar{\mathbf{Q}}_i)} \quad (463)$$

$$= \mathbb{E}_{\mathbf{Q}}[e^{\text{tr}(\tilde{\mathbf{Q}}\mathbf{Q})}] \quad (464)$$

$$= \mathcal{M}(\tilde{\mathbf{Q}}), \quad (465)$$

which is the moment generating function for the random matrix  $\mathbf{Q}$ .

It is easy to see that the (normalized) right and left Perron vectors of  $P_{\tilde{Q}}$  are

$$\psi = (1, 1, \dots, 1)^T, \quad (466)$$

$$\lambda = \frac{1}{\rho(P_{\tilde{Q}})} (P(\bar{Q}_0)e^{\text{tr}(\tilde{Q}\bar{Q}_0)}, P(\bar{Q}_1)e^{\text{tr}(\tilde{Q}\bar{Q}_1)}, \dots, P(\bar{Q}_M)e^{\text{tr}(\tilde{Q}\bar{Q}_M)})^T. \quad (467)$$

Hence, from Theorem 41, we have

$$\frac{\partial \rho(P_{\tilde{Q}})}{\partial P_{\tilde{Q}}} = \frac{1}{\rho(P_{\tilde{Q}})} \begin{bmatrix} P(\bar{Q}_0)e^{\text{tr}(\tilde{Q}\bar{Q}_0)} & P(\bar{Q}_0)e^{\text{tr}(\tilde{Q}\bar{Q}_0)} & \dots & P(\bar{Q}_0)e^{\text{tr}(\tilde{Q}\bar{Q}_0)} \\ P(\bar{Q}_1)e^{\text{tr}(\tilde{Q}\bar{Q}_1)} & P(\bar{Q}_1)e^{\text{tr}(\tilde{Q}\bar{Q}_1)} & \dots & P(\bar{Q}_1)e^{\text{tr}(\tilde{Q}\bar{Q}_1)} \\ \vdots & \vdots & \vdots & \vdots \\ P(\bar{Q}_M)e^{\text{tr}(\tilde{Q}\bar{Q}_M)} & P(\bar{Q}_M)e^{\text{tr}(\tilde{Q}\bar{Q}_M)} & \dots & P(\bar{Q}_M)e^{\text{tr}(\tilde{Q}\bar{Q}_M)} \end{bmatrix}. \quad (468)$$

Let  $A \in \mathbb{R}^{p \times q}$  and  $B \in (\mathbb{R}^{n \times n})^{p \times q}$  and define  $A o_{\text{tr}} B := \sum_{i,j} A_{ij} \odot B_{ij}$ , where  $A \odot B$  is the Hadamard product between  $A$  and  $B$ . Now, from the chain rule for derivatives, we have

$$\frac{\partial \rho(P_{\tilde{Q}})}{\partial \tilde{Q}}(\tilde{Q}) = \frac{\partial \rho(P_{\tilde{Q}})}{\partial P_{\tilde{Q}}} o_{\text{tr}} \frac{\partial P_{\tilde{Q}}}{\partial \tilde{Q}} \quad (469)$$

$$= \frac{1}{\rho(P_{\tilde{Q}})} \begin{bmatrix} P(\bar{Q}_0)e^{\text{tr}(\tilde{Q}\bar{Q}_0)} & P(\bar{Q}_0)e^{\text{tr}(\tilde{Q}\bar{Q}_1)} & \dots & P(\bar{Q}_0)e^{\text{tr}(\tilde{Q}\bar{Q}_M)} \\ P(\bar{Q}_1)e^{\text{tr}(\tilde{Q}\bar{Q}_1)} & P(\bar{Q}_1)e^{\text{tr}(\tilde{Q}\bar{Q}_2)} & \dots & P(\bar{Q}_1)e^{\text{tr}(\tilde{Q}\bar{Q}_2)} \\ \vdots & \vdots & \vdots & \vdots \\ P(\bar{Q}_M)e^{\text{tr}(\tilde{Q}\bar{Q}_1)} & P(\bar{Q}_M)e^{\text{tr}(\tilde{Q}\bar{Q}_M)} & \dots & P(\bar{Q}_M)e^{\text{tr}(\tilde{Q}\bar{Q}_M)} \end{bmatrix} o_{\text{tr}} \begin{bmatrix} \bar{Q}_0 P(\bar{Q}_0)e^{\text{tr}(\tilde{Q}\bar{Q}_0)} & \bar{Q}_1 P(\bar{Q}_1)e^{\text{tr}(\tilde{Q}\bar{Q}_1)} & \dots & \bar{Q}_M P(\bar{Q}_M)e^{\text{tr}(\tilde{Q}\bar{Q}_M)} \\ \bar{Q}_0 P(\bar{Q}_0)e^{\text{tr}(\tilde{Q}\bar{Q}_0)} & \bar{Q}_1 P(\bar{Q}_1)e^{\text{tr}(\tilde{Q}\bar{Q}_1)} & \dots & \bar{Q}_M P(\bar{Q}_M)e^{\text{tr}(\tilde{Q}\bar{Q}_M)} \\ \vdots & \vdots & \vdots & \vdots \\ \bar{Q}_0 P(\bar{Q}_0)e^{\text{tr}(\tilde{Q}\bar{Q}_0)} & \bar{Q}_1 P(\bar{Q}_1)e^{\text{tr}(\tilde{Q}\bar{Q}_1)} & \dots & \bar{Q}_M P(\bar{Q}_M)e^{\text{tr}(\tilde{Q}\bar{Q}_M)} \end{bmatrix} \quad (470)$$

$$= \frac{1}{\rho(P_{\tilde{Q}})} \left[ \sum_{j=0}^M P(\bar{Q}_j)e^{\text{tr}(\tilde{Q}\bar{Q}_j)} \right] \left[ \sum_{j=0}^M \bar{Q}_j P(\bar{Q}_j)e^{\text{tr}(\tilde{Q}\bar{Q}_j)} \right] \quad (471)$$

$$= \frac{1}{\rho(P_{\tilde{Q}})} \rho(P_{\tilde{Q}}) \mathbb{E}[\mathbf{Q}e^{\text{tr}(\tilde{Q}\mathbf{Q})}] \quad (472)$$

$$= \mathbb{E}[\mathbf{Q}e^{\text{tr}(\tilde{Q}\mathbf{Q})}]. \quad (473)$$

Now, by the chain rule, we also have

$$\frac{\partial \log \rho(P_{\tilde{Q}})}{\partial \tilde{Q}}(\tilde{Q}) = \frac{1}{\rho(P_{\tilde{Q}})} \frac{\partial P_{\tilde{Q}}}{\partial \tilde{Q}}(\tilde{Q}) \quad (474)$$

$$= \frac{1}{\rho(P_{\tilde{Q}})} \mathbb{E}[\mathbf{Q}e^{\text{tr}(\tilde{Q}\mathbf{Q})}]. \quad (475)$$

■

Now, we use the above method to find the partial derivative  $\frac{\partial \log \rho(P_{\tilde{Q}})}{\partial \tilde{Q}}$  for the more general Markov model considered in this paper.

**Lemma 43.** *The following holds:*

$$\frac{\partial \log \rho(P_{\tilde{Q}})}{\partial \tilde{Q}}(\tilde{Q}) = \frac{1}{\rho(P_{\tilde{Q}})} \sum_{i=0}^M \lambda_i(\tilde{Q}) \sum_{j=0}^M \psi_j(\tilde{Q}) \bar{Q}_j P(\bar{Q}_j | \bar{Q}_i) e^{\text{tr}(\tilde{Q} \bar{Q}_i)}, \quad (476)$$

where  $\lambda(\tilde{Q})$  and  $\psi(\tilde{Q})$  are left and right eigenvectors associated with the Perron-Frobenius eigenvalue  $\rho(P_{\tilde{Q}})$  which are normalized such that  $\lambda(\tilde{Q})^T \psi(\tilde{Q}) = 1$ .

**Remark 44.** *It is easy to see that we can recover the above result for the i.i.d. case by using this lemma.*

*Proof:* In this case, the matrix

$$P_{\tilde{Q}} = \begin{bmatrix} P(\bar{Q}_0 | \bar{Q}_0) e^{\text{tr}(\tilde{Q} \bar{Q}_0)} & P(\bar{Q}_1 | \bar{Q}_0) e^{\text{tr}(\tilde{Q} \bar{Q}_1)} & \dots & P(\bar{Q}_M | \bar{Q}_0) e^{\text{tr}(\tilde{Q} \bar{Q}_M)} \\ P(\bar{Q}_0 | \bar{Q}_1) e^{\text{tr}(\tilde{Q} \bar{Q}_0)} & P(\bar{Q}_1 | \bar{Q}_1) e^{\text{tr}(\tilde{Q} \bar{Q}_1)} & \dots & P(\bar{Q}_M | \bar{Q}_1) e^{\text{tr}(\tilde{Q} \bar{Q}_M)} \\ \vdots & \vdots & \vdots & \vdots \\ P(\bar{Q}_0 | \bar{Q}_M) e^{\text{tr}(\tilde{Q} \bar{Q}_0)} & P(\bar{Q}_1 | \bar{Q}_M) e^{\text{tr}(\tilde{Q} \bar{Q}_2)} & \dots & P(\bar{Q}_M | \bar{Q}_M) e^{\text{tr}(\tilde{Q} \bar{Q}_M)} \end{bmatrix}. \quad (477)$$

where

$$P(\bar{Q}_j | \bar{Q}_i) := \mathbb{P}(\mathbf{Q}_1 = \bar{Q}_j | \mathbf{Q}_0 = \bar{Q}_i). \quad (478)$$

It follows that

$$\frac{\partial \rho(P_{\tilde{Q}})}{\partial P_{\tilde{Q}}} = \frac{1}{\rho(P_{\tilde{Q}})} \lambda(\tilde{Q}) \psi(\tilde{Q})^T \quad (479)$$

where  $\lambda(\tilde{Q})$  and  $\psi(\tilde{Q})$  are left and right eigenvectors associated with the eigenvalue  $\rho(P_{\tilde{Q}})$  which are normalized such that  $\lambda(\tilde{Q})^T \psi(\tilde{Q}) = 1$ . Then, we have

$$\frac{\partial \rho(P_{\tilde{Q}})}{\partial \tilde{Q}}(\tilde{Q}) = \frac{\partial \rho(P_{\tilde{Q}})}{\partial P_{\tilde{Q}}} o_{\text{tr}} \frac{\partial P_{\tilde{Q}}}{\partial \tilde{Q}} \quad (480)$$

$$= \frac{1}{\rho(P_{\tilde{Q}})} \lambda(\tilde{Q}) \psi(\tilde{Q})^T o_{\text{tr}} \begin{bmatrix} \bar{Q}_0 P(\bar{Q}_0 | \bar{Q}_0) e^{\text{tr}(\tilde{Q} \bar{Q}_0)} & \bar{Q}_1 P(\bar{Q}_1 | \bar{Q}_0) e^{\text{tr}(\tilde{Q} \bar{Q}_1)} & \dots & \bar{Q}_M P(\bar{Q}_M | \bar{Q}_0) e^{\text{tr}(\tilde{Q} \bar{Q}_M)} \\ \bar{Q}_0 P(\bar{Q}_0 | \bar{Q}_1) e^{\text{tr}(\tilde{Q} \bar{Q}_0)} & \bar{Q}_1 P(\bar{Q}_1 | \bar{Q}_1) e^{\text{tr}(\tilde{Q} \bar{Q}_1)} & \dots & \bar{Q}_M P(\bar{Q}_M | \bar{Q}_1) e^{\text{tr}(\tilde{Q} \bar{Q}_M)} \\ \vdots & \vdots & \vdots & \vdots \\ \bar{Q}_0 P(\bar{Q}_0 | \bar{Q}_M) e^{\text{tr}(\tilde{Q} \bar{Q}_0)} & \bar{Q}_1 P(\bar{Q}_1 | \bar{Q}_M) e^{\text{tr}(\tilde{Q} \bar{Q}_2)} & \dots & \bar{Q}_M P(\bar{Q}_M | \bar{Q}_M) e^{\text{tr}(\tilde{Q} \bar{Q}_M)} \end{bmatrix} \quad (481)$$

$$= \frac{1}{\rho(P_{\tilde{Q}})} \sum_{i=0}^M \sum_{j=0}^M \lambda_i(\tilde{Q}) \psi_j(\tilde{Q}) \bar{Q}_j P(\bar{Q}_j | \bar{Q}_i) e^{\text{tr}(\tilde{Q} \bar{Q}_i)} \quad (482)$$

$$= \frac{1}{\rho(P_{\tilde{Q}})} \sum_{i=0}^M \lambda_i(\tilde{Q}) \sum_{j=0}^M \psi_j(\tilde{Q}) \bar{Q}_j P(\bar{Q}_j | \bar{Q}_i) e^{\text{tr}(\tilde{Q} \bar{Q}_i)}. \quad (483)$$

Now, by the chain rule, we also have

$$\frac{\partial \log \rho(P_{\tilde{Q}})}{\partial \tilde{Q}}(\tilde{Q}) = \frac{1}{\rho(P_{\tilde{Q}})} \frac{\partial P_{\tilde{Q}}}{\partial \tilde{Q}}(\tilde{Q}). \quad (484)$$

Hence, we obtain (476) from (483) and (484).  $\blacksquare$

## APPENDIX C

### PROOF OF (374)

To prove (374) we first recall that the Large Deviations Principle for probability measures also holds for any finite Borel measures on compact metric space (e.g. [41]) or on Polish space [42]. More specifically, Theorem 22 and Theorem 23 still holds for finite Borel measures on these spaces.

Now, since replicas  $\mathbf{X}^{(m)}$  are i.i.d. and  $\mathbf{X} - (\mathbf{Y}, \Phi) - \mathbf{X}^{(m)}$  for all  $m \in \{1, 2, \dots, \nu\}$ , it holds that

$$\mathbb{E} \left[ X_k^{i_0} \tilde{X}_k^{j_0} \langle X_k \rangle_q^{l_0} \right] = \mathbb{E} \left[ \mathbb{E} \left[ X_k^{i_0} \tilde{X}_k^{j_0} \langle X_k \rangle_q^{l_0} \middle| \mathbf{Y}, \Phi \right] \right] \quad (485)$$

$$= \mathbb{E} \left[ \mathbb{E} \left[ X_k^{i_0} \tilde{X}_k^{j_0} \middle| \mathbf{Y}, \Phi \right] \mathbb{E} \left[ \langle X_k \rangle_q^{l_0} \middle| \mathbf{Y}, \Phi \right] \right] \quad (486)$$

$$= \mathbb{E} \left[ \mathbb{E} \left[ X_k^{i_0} \tilde{X}_k^{j_0} \middle| \mathbf{Y}, \Phi \right] \mathbb{E} \left[ \left( \mathbb{E}_q[X_k | \mathbf{Y}, \Phi] \right)^{l_0} \middle| \mathbf{Y}, \Phi \right] \right] \quad (487)$$

$$= \mathbb{E} \left[ \mathbb{E} \left[ X_k^{i_0} \tilde{X}_k^{j_0} \middle| \mathbf{Y}, \Phi \right] \left( \mathbb{E}_q[X_k | \mathbf{Y}, \Phi] \right)^{l_0} \right] \quad (488)$$

$$= \mathbb{E} \left[ \mathbb{E} \left[ X_k^{i_0} \middle| \mathbf{Y}, \Phi \right] \mathbb{E} \left[ \tilde{X}_k^{j_0} \middle| \mathbf{Y}, \Phi \right] \left( \mathbb{E}_q[X_k | \mathbf{Y}, \Phi] \right)^{l_0} \right] \quad (489)$$

$$= \mathbb{E} \left[ \mathbb{E} \left[ X_k^{i_0} \middle| \mathbf{Y}, \Phi \right] \mathbb{E} \left[ \tilde{X}_k^{j_0} \middle| \mathbf{Y}, \Phi \right] \prod_{a=1}^{l_0} \mathbb{E}_q[X_k^{(a)} | \mathbf{Y}, \Phi] \right] \quad (490)$$

$$= \mathbb{E} \left[ \mathbb{E} \left[ X_k^{i_0} \middle| \mathbf{Y}, \Phi \right] \mathbb{E} \left[ \tilde{X}_k^{j_0} \middle| \mathbf{Y}, \Phi \right] \prod_{a=1}^{l_0} \mathbb{E}_q[X_k^{(a)} | \mathbf{Y}, \Phi] \right] \quad (491)$$

$$= \mathbb{E} \left[ \mathbb{E} \left[ X_k^{i_0} \middle| \mathbf{Y}, \Phi \right] \mathbb{E} \left[ (X_k^{(m)})^{j_0} \middle| \mathbf{Y}, \Phi \right] \prod_{a=1}^{l_0} \mathbb{E}_q[X_k^{(a)} | \mathbf{Y}, \Phi] \right] \quad (492)$$

$$= \mathbb{E} \left[ \mathbb{E} \left[ X_k^{i_0} (X_k^{(m)})^{j_0} \prod_{a=1}^{l_0} X_k^{(a)} \middle| \mathbf{Y}, \Phi \right] \right] \quad (493)$$

$$= \mathbb{E} \left[ X_k^{i_0} (X_k^{(m)})^{j_0} \prod_{a=1}^{l_0} X_k^{(a)} \right] \quad (494)$$



for all  $k \in \{1, 2, \dots, n\}$  and all  $m \in \{1, 2, \dots, \nu\}$ . Since for  $k \geq 2$ , we know that

$$\mathbb{E} \left[ X_k^{i_0} (X_k^{(m)})^{j_0} \prod_{a=1}^{l_0} X_k^{(a)} \right] = \mathbb{E} \left[ \mathbb{E} \left[ X_k^{i_0} (X_k^{(m)})^{j_0} \prod_{a=1}^{l_0} X_k^{(a)} \middle| \sigma(X_{k-1}, X_{k-1}^{(m)}, \{X_{k-1}^{(a)}\}_{a=1}^{l_0}) \right] \right] \quad (495)$$

$$= \mathbb{E} \left[ \mathbb{E} \left[ X_k^{i_0} \middle| X_{k-1} \right] \mathbb{E} \left[ (X_k^{(m)})^{j_0} \middle| X_{k-1}^{(m)} \right] \prod_{a=1}^{l_0} \mathbb{E} \left[ X_k^{(a)} \middle| X_{k-1}^{(a)} \right] \right] \quad (496)$$

$$= \mathbb{E} \left[ \mathbb{E} \left[ X_1^{i_0} \middle| X_0 \right] \mathbb{E} \left[ (X_1^{(m)})^{j_0} \middle| X_0^{(m)} \right] \prod_{a=1}^{l_0} \mathbb{E} \left[ X_1^{(a)} \middle| X_0^{(a)} \right] \right] \quad (497)$$

$$= \mathbb{E} \left[ \mathbb{E} \left[ X_1^{i_0} (X_1^{(m)})^{j_0} \prod_{a=1}^{l_0} X_1^{(a)} \middle| \sigma(X_0, X_0^{(m)}, \{X_0^{(a)}\}_{a=1}^{l_0}) \right] \right] \quad (498)$$

$$= \mathbb{E} \left[ X_1^{i_0} (X_1^{(m)})^{j_0} \prod_{a=1}^{l_0} X_1^{(a)} \right], \quad (499)$$

where (495) follows from the tower property [36], (496) follows from the i.i.d. of replicas  $\mathbf{X}^{(a)}$  for all  $a \in [\nu]$ , and (497) follows from the time-homogeneous property of the Markov chains  $\{X_n^{(a)}\}_{n=1}^{\infty}$

It follows from (499) that

$$\mathbb{E} \left[ X_k^{i_0} (X_k^{(m)})^{j_0} \prod_{a=1}^{l_0} X_k^{(a)} \right] = \frac{1}{n} \mathbb{E} \left[ \sum_{j=1}^n X_j^{i_0} (X_j^{(m)})^{j_0} \prod_{a=1}^{l_0} X_j^{(a)} \right], \quad \forall k \in \{1, 2, \dots, n\}. \quad (500)$$

Now, let  $\underline{\mathbf{X}} := [\mathbf{X}^{(1)}, \mathbf{X}^{(2)}, \dots, \mathbf{X}^{(\nu)}]$  and set

$$f(\mathbf{X}^{(0)}, \underline{\mathbf{X}}_a) := \sum_{j=1}^n X_j^{i_0} (X_j^{(m)})^{j_0} \prod_{a=1}^{l_0} X_j^{(a)}. \quad (501)$$

Note that

$$\mathbb{E} \left[ f(\mathbf{X}_0, \underline{\mathbf{X}}_a) \middle| \mathbf{Y}, \Phi, \mathbf{X}^{(0)} \right] = \mathbb{E} \left[ \sum_{j=1}^n X_j^{i_0} (X_j^{(m)})^{j_0} \prod_{a=1}^{l_0} X_j^{(a)} \middle| \mathbf{Y}, \Phi, \mathbf{X}^{(0)} \right] \quad (502)$$

does not depend on  $\nu$ . Hence, by [4, Lemma 1], we have

$$\mathbb{E} \left[ f(\mathbf{X}^{(0)}, \underline{\mathbf{X}}_a) \right] = \lim_{\nu \rightarrow 0} \frac{\partial}{\partial h} \log \mathbb{E} \left[ Z^{(\nu)}(\mathbf{Y}, \Phi, \mathbf{X}^{(0)}; h) \right] \Big|_{h=0} \quad (503)$$

where

$$Z^{(\nu)}(\mathbf{Y}, \Phi, \mathbf{X}^{(0)}; h) = (2\pi\sigma^2)^{-\nu m/2} \mathbb{E} \left\{ \exp \left[ h \sum_{j=1}^n X_j^{i_0} (X_j^{(m)})^{j_0} \prod_{a=1}^{l_0} X_j^{(a)} \right] \prod_{a=1}^{\nu} \exp \left[ -\frac{1}{2\sigma^2} \|\mathbf{Y} - \Phi \mathbf{X}^{(a)}\|^2 \middle| \Phi \right] \right\}. \quad (504)$$

Hence, we have

$$\begin{aligned} & \mathbb{E} \left[ Z^{(\nu)}(\mathbf{Y}, \Phi, \mathbf{X}^{(0)}; h) \right] \\ &= \mathbb{E} \left[ (2\pi)^{-\frac{m}{2}} (2\pi\sigma^2)^{-\frac{\nu m}{2}} \mathbb{E} \left\{ \exp \left[ h \sum_{j=1}^n X_j^{i_0} (X_j^{(m)})^{j_0} \prod_{a=1}^{l_0} X_j^{(a)} \right] \right. \right. \\ & \quad \left. \left. \times \exp \left[ -\frac{1}{2} \|\mathbf{Y} - \Phi \mathbf{X}^{(0)}\|^2 \right] \prod_{a=1}^{\nu} \exp \left[ -\frac{1}{2\sigma^2} \|\mathbf{Y} - \Phi \mathbf{X}_a\|^2 \middle| \Phi \right] \right\} \right]. \end{aligned} \quad (505)$$

Let  $\tilde{\mathbf{U}} = (U_1, U_2, \dots, U_n)$ , a vector of i.i.d. random variables each taking the same distribution as a row of the matrix  $\mathbf{A}$ . Define

$$V_a = \frac{1}{\sqrt{n}} \sum_{j=1}^n \sqrt{S_j} U_j X_j^{(a)}, \quad a = 0, 1, \dots, \nu. \quad (506)$$

Now given  $\mathbf{A}, \underline{\mathbf{X}}$ ,  $m$  outputs  $\{Y_k\}_{k=1}^m$  of the channel model in Section II are independent since the sequence  $\{S_k\}_{k=1}^n$  are i.i.d. Hence, (505) can be written as

$$\mathbb{E} \left[ Z^{(\nu)}(\mathbf{Y}, \Phi, \mathbf{X}^{(0)}; h) \right] = \mathbb{E} \left[ \exp \left( m G_n^{(\nu)}(\mathbf{A}, \underline{\mathbf{X}}) \right) \exp \left( h \sum_{j=1}^n X_j^{i_0} (X_j^{(m)})^{j_0} \prod_{a=1}^{l_0} X_j^{(a)} \right) \right], \quad (507)$$

where  $G_n^{(\nu)}(\mathbf{A}, \underline{\mathbf{X}})$  is as [4, Eq. (98)], i.e.,

$$\begin{aligned} G_n^{(\nu)}(\mathbf{A}, \underline{\mathbf{X}}) &= -\frac{\nu}{2} \log(2\pi\sigma^2) + \log \int \mathbb{E} \left\{ \exp \left[ -\frac{(y - \sqrt{\beta} V_0)^2}{2} \right] \right. \\ & \quad \left. \times \prod_{a=1}^{\nu} \exp \left[ -\frac{(y - \sqrt{\beta} V_a)^2}{2} \middle| \mathbf{A}, \underline{\mathbf{X}} \right] \frac{dy}{\sqrt{2\pi}} \right\} \end{aligned} \quad (508)$$

$$= (2\pi\sigma^2)^{-\frac{\nu}{2}} \left( 1 + \frac{\nu}{\sigma^2} \right)^{-1/2} \mathbb{E} \left[ \exp \left( -\frac{1}{2} \mathbf{V}^T \Sigma \mathbf{V} \right) \middle| \mathbf{A}, \underline{\mathbf{X}} \right], \quad (509)$$

where  $\mathbf{V} = (V_1, V_2, \dots, V_\nu)^T$  and (509) follows from [43, Eq. (A80)]. Now, by Edgeworth expansion (e.g. [3, Eq. (138)], [43, Eq. (A75)]), given  $\mathbf{A}, \underline{\mathbf{X}}$  we have

$$f_{\mathbf{V}}(v; \mathbf{T}_n) = \frac{1}{\sqrt{(2\pi)^{\nu+1} \det(\mathbf{T}_n)}} \exp \left( -\frac{1}{2} v^T \mathbf{T}_n^{-1} v \right) + O(n^{-1}), \quad (510)$$

where

$$\mathbf{T}_n = \frac{1}{n} \sum_{k=1}^n \mathbf{Q}_k, \quad (511)$$

$$\mathbf{Q}_k = \left\{ S_k X_k^{(a)} X_k^{(b)} \right\}_{(a,b)}, \quad \forall k \in \{1, 2, \dots, n\}, \quad \forall a, b \in [\nu]. \quad (512)$$

From (509), (511) and (512), given  $\mathbf{A}, \underline{\mathbf{X}}$  we obtain

$$G_n^{(\nu)}(\mathbf{A}, \underline{\mathbf{X}}) = G^{(\nu)}(\mathbf{T}_n) + O(n^{-1}) \quad (513)$$

where [4, Eq. (100)]

$$G^{(\nu)}(\mathbf{T}_n) := -\frac{1}{2} \log \det(I + \Sigma \mathbf{T}_n) - \frac{1}{2} \log \left( 1 + \frac{\nu}{\sigma^2} \right) - \frac{\nu}{2} \log(2\pi\sigma^2), \quad (514)$$

and  $\Sigma$  is a  $(\nu + 1) \times (\nu + 1)$  matrix

$$\Sigma = \frac{\beta}{\sigma^2 + \nu} \begin{bmatrix} \nu & -e^T \\ -e & (1 + \frac{\nu}{\sigma^2})I - \frac{1}{\sigma^2}ee^T \end{bmatrix}, \quad (515)$$

where  $e$  is a  $\nu \times 1$  column vector whose entries are all 1.

From (507) and (513), we have

$$\mathbb{E} \left[ Z^{(\nu)}(\mathbf{Y}, \Phi, \mathbf{X}^{(0)}; h) \right] = \mathbb{E}_{p(\mathbf{A}, \underline{\mathbf{X}})} \left[ \exp \left( mG^{(\nu)}(\mathbf{T}_n) + O(n^{-1}) \right) \exp \left( h \sum_{j=1}^n X_j^{i_0} (X_j^{(m)})^{j_0} \prod_{a=1}^{l_0} X_j^{(a)} \right) \right]. \quad (516)$$

Now, define a new measure

$$\mu(\mathbf{A}, \underline{\mathbf{X}})(F) := \int_F \exp \left( h \sum_{j=1}^n X_j^{i_0} (X_j^{(m)})^{j_0} \prod_{a=1}^{l_0} X_j^{(a)} \right) dp(\mathbf{A}, \underline{\mathbf{X}}) \quad \forall F \in \sigma(\mathbf{A}, \underline{\mathbf{X}}), \quad (517)$$

where  $p(\mathbf{A}, \underline{\mathbf{X}})$  is the joint probability between  $\mathbf{A}$  and  $\underline{\mathbf{X}}$  under the model setting in II. It is obvious that  $\mu(\mathbf{A}, \underline{\mathbf{X}})$  is a finite measure on Borel sets which are generated by  $\mathbf{A}, \underline{\mathbf{X}}$  if

$$\mathbb{E} \left[ \exp \left( h \sum_{j=1}^n X_j^{i_0} (X_j^{(m)})^{j_0} \prod_{a=1}^{l_0} X_j^{(a)} \right) \right] < \infty, \quad (518)$$

By Cauchy Schwarz inequality, (518) happens if  $\mathbb{E}[\exp(hX_k^{i_0} (X_k^{(m)})^{j_0} \prod_{a=1}^{l_0} X_k^{(a)})] < \infty$  for all  $k \in \{1, 2, \dots, n\}$ , which is equivalent to

$$\mathbb{E} \left[ \exp \left( hX_k^{i_0} \tilde{X}_k^{j_0} \langle X_k \rangle_q^{l_0} \right) \right] < \infty, \quad \forall k = 1, 2, \dots, n. \quad (519)$$

by using the same proof techniques to obtain (494). This fact (i.e. (519)), of course, holds if we assume that all the conditional joint moments among  $X_1, X, \langle X|X_0 \rangle$  in the RHS and LHS of (374) are finite.

Under the measure  $\mu(\mathbf{A}, \underline{\mathbf{X}})$ , we have

$$\phi_n(\tilde{Q}) = \mathbb{E}_\mu(\mathbf{A}, \underline{\mathbf{X}}) \left[ \exp(\text{tr}(\tilde{Q} \mathbf{T}_n)) \right] \quad (520)$$

$$= \mathbb{E}_{p(\mathbf{A}, \underline{\mathbf{X}})} \left[ \exp(\text{tr}(\tilde{Q} \mathbf{T}_n)) \exp \left( h \sum_{j=1}^n X_j^{i_0} (X_j^{(m)})^{j_0} \prod_{a=1}^{l_0} X_j^{(a)} \right) \right] \quad (521)$$

$$= \mathbb{E} \left[ \exp(\text{tr}(\tilde{Q} \sum_{j=1}^n Q_j)) \exp \left( h \sum_{j=1}^n X_j^{i_0} (X_j^{(m)})^{j_0} \prod_{a=1}^{l_0} X_j^{(a)} \right) \right] \quad (522)$$

$$= \mathbb{E} \left[ \exp \left( \sum_{j=1}^n \text{tr}(\tilde{Q} Q_j) + h X_j^{i_0} (X_j^{(m)})^{j_0} \prod_{a=1}^{l_0} X_j^{(a)} \right) \right] \quad (523)$$

$$= \mathbb{E} \left[ \exp \left( \sum_{j=1}^n K(\tilde{Q}, \mathbf{Q}_j) \right) \right] \quad (524)$$

where

$$K(\tilde{Q}, \mathbf{Q}_j) := \text{tr}(\tilde{Q} Q_j) + h X_j^{i_0} (X_j^{(m)})^{j_0} \prod_{a=1}^{l_0} X_j^{(a)}. \quad (525)$$

Note that the LHS of (525) is a function of  $\mathbf{Q}_j$  which is defined in (512). Moreover, it is known that  $\{\mathbf{Q}_n\}_{n=1}^\infty$  forms an irreducible Markov chain by Lemma 31.

Now, let

$$P(\bar{Q}_j | \bar{Q}_i) = \mathbb{P}(\mathbf{Q}_1 = \bar{Q}_j | \mathbf{Q}_0 = \bar{Q}_i), \quad (526)$$

and

$$\hat{\pi}(\bar{Q}_i, \bar{Q}_j) = P(\bar{Q}_j | \bar{Q}_i) e^{K(\tilde{Q}, \bar{Q}_j)} \quad (527)$$

Define  $\rho(P_{\tilde{Q}}^{\hat{\pi}})$  be the Perron-Frobenius eigenvalue of the following irreducible non-negative matrix

$$P_{\tilde{Q}}^{\hat{\pi}} = \begin{bmatrix} \hat{\pi}(\bar{Q}_0, \bar{Q}_0) & \hat{\pi}(\bar{Q}_0, \bar{Q}_1) & \cdots & \hat{\pi}(\bar{Q}_0, \bar{Q}_M) \\ \hat{\pi}(\bar{Q}_1, \bar{Q}_0) & \hat{\pi}(\bar{Q}_1, \bar{Q}_1) & \cdots & \hat{\pi}(\bar{Q}_1, \bar{Q}_M) \\ \vdots & \vdots & \ddots & \vdots \\ \hat{\pi}(\bar{Q}_M, \bar{Q}_0) & \hat{\pi}(\bar{Q}_M, \bar{Q}_1) & \cdots & \hat{\pi}(\bar{Q}_M, \bar{Q}_M) \end{bmatrix}. \quad (528)$$

It follows from (524) that

$$\phi_n(\tilde{Q}) = \mathbb{E} \left[ \exp \left( \sum_{j=1}^n K(\mathbf{Q}_j) \right) \right] \quad (529)$$

$$= \mathbb{E} \left[ \sum_{\bar{Q}_1, \bar{Q}_2, \dots, \bar{Q}_n \in \mathcal{Q}^n} P(\bar{Q}_1, \bar{Q}_2, \dots, \bar{Q}_n) \exp \left( \sum_{j=1}^n K(\bar{Q}_j) \right) \right] \quad (530)$$

$$= \mathbb{E} \left[ \mathbb{E} \left[ \sum_{\bar{Q}_1, \bar{Q}_2, \dots, \bar{Q}_n \in \mathcal{Q}^n} P(\bar{Q}_1, \bar{Q}_2, \dots, \bar{Q}_n) \exp \left( \sum_{j=1}^n K(\bar{Q}_j) \right) \middle| \mathbf{Q}_0 \right] \right] \quad (531)$$

$$= \mathbb{E}_{\mathbf{Q}_0} \left[ \sum_{\bar{Q}_1, \bar{Q}_2, \dots, \bar{Q}_n \in \mathcal{Q}^n} P(\bar{Q}_1 | \mathbf{Q}_0) P(\bar{Q}_2 | \bar{Q}_1) \cdots P(\bar{Q}_n | \bar{Q}_{n-1}) \exp \left( \sum_{j=1}^n K(\bar{Q}_j) \right) \right] \quad (532)$$

$$= \mathbb{E}_{\mathbf{Q}_0} \left[ \sum_{\bar{Q}_1, \bar{Q}_2, \dots, \bar{Q}_n \in \mathcal{Q}^n} \hat{\pi}(\mathbf{Q}_0, \bar{Q}_1) \hat{\pi}(\bar{Q}_1, \bar{Q}_2) \cdots \hat{\pi}(\bar{Q}_{n-1}, \bar{Q}_n) \right] \quad (533)$$

$$= \mathbb{E}_{\mathbf{Q}_0} \left[ \sum_{\bar{Q}_n \in \mathcal{Q}} \hat{\pi}_{\mathbf{Q}_0, \bar{Q}_n}^n \right] \quad (534)$$

$$= \mathbb{E}_{\mathbf{Q}_0} \left[ \rho(P_{\tilde{Q}}^{\hat{\pi}}) \right] \quad (535)$$

$$= \rho(P_{\tilde{Q}}^{\hat{\pi}}), \quad (536)$$

where (535) follows from Lemma 30.

Hence, by Theorem 22, under the measure  $\mu(\mathbf{A}, \underline{\mathbf{X}})$ ,  $\mathbf{T}_n$  satisfies the large deviations property, with rate function  $I(Q) = \sup_{\tilde{Q}} (\text{tr}(\tilde{Q}Q) - \log \rho(P_{\tilde{Q}}^{\hat{\pi}}))$ . Specifically, for every initial state  $\bar{Q}_0 \in \mathcal{Q}$ , every closed set  $F \subset \mathcal{Q}$  and every open set  $U \in \mathcal{Q}$ , the following holds:

$$\limsup_n \frac{1}{n} \log \mu_{\mathbf{A}, \underline{\mathbf{X}}} \left( \mathbf{T}_n \in F | \bar{Q}_0 \right) \leq - \inf_{Q \in F} I(Q), \quad (537)$$

$$\liminf_n \frac{1}{n} \log \mu_{\mathbf{A}, \underline{\mathbf{X}}} \left( \mathbf{T}_n \in U | \bar{Q}_0 \right) \leq - \inf_{Q \in U} I(Q). \quad (538)$$

For any Borel set  $F \in \mathcal{Q}$ , define a new measure

$$P_n(F) = \mu_{\mathbf{A}, \underline{\mathbf{X}}}(\mathbf{T}_n \in F). \quad (539)$$

It follows by Theorem 23 that for and bounded and continuous function  $F : \mathcal{Q} \rightarrow \mathbf{R}$

$$\lim_{n \rightarrow \infty} \frac{1}{n} \mathbb{E}_{\mu(\mathbf{A}, \underline{\mathbf{X}})} [e^{nF(\mathbf{T}_n)}] = \lim_{n \rightarrow \infty} \frac{1}{n} \log \int e^{nF(Q)} dP_n(Q) \quad (540)$$

$$= \sup_Q \left[ F(Q) - I(Q) \right] \quad (541)$$

where  $I(Q) = \sup_{\tilde{Q}} (\text{tr}(\tilde{Q}Q) - \log \rho(P_{\tilde{Q}}^{\hat{\pi}}))$ .

On the other hand, by the change of measure [44], we have

$$\mathbb{E}_{\mu(\mathbf{A}, \mathbf{X})} [e^{nF(\mathbf{T}_n)}] = \mathbb{E} \left[ e^{nF(\mathbf{T}_n)} \exp \left( h \sum_{j=1}^n X_j^{i_0} (X_j^{(m)})^{j_0} \prod_{a=1}^{l_0} X_j^{(a)} \right) \right]. \quad (542)$$

Hence, from (541) and (542) we obtain

$$\mathbb{E} \left[ e^{nF(\mathbf{T}_n)} \exp \left( h \sum_{j=1}^n X_j^{i_0} (X_j^{(m)})^{j_0} \prod_{a=1}^{l_0} X_j^{(a)} \right) \right] = \sup_Q \left[ F(Q) - I(Q) \right] \quad (543)$$

where

$$I(Q) = \sup_{\tilde{Q}} (\text{tr}(\tilde{Q}Q) - \log \rho(P_{\tilde{Q}}^{\hat{\pi}})). \quad (544)$$

Combining all the above results, we come up with the following theorem

**Theorem 45.** *Recall the definition of  $G^{(\nu)}(Q)$  in Lemma 5. In the large system limit, the following holds:*

$$\lim_{n \rightarrow \infty} \mathbb{E} \left[ X_k^{i_0} \tilde{X}_k^{j_0} \langle X_k \rangle_q^{l_0} \right] = \frac{\partial}{\partial h} \lim_{\nu \rightarrow 0} \frac{\partial}{\partial \nu} \sup_Q \left[ \beta^{-1} G^{(\nu)}(Q) - I^{(\nu, h)}(Q) \right] \Big|_{h=0}, \quad (545)$$

where

$$I^{(\nu, h)}(Q) := \sup_{\tilde{Q}} \left[ \text{tr}(\tilde{Q}Q) - \log \rho(P_{\tilde{Q}}^{\hat{\pi}}) \right], \quad (546)$$

and  $\log \rho(P_{\tilde{Q}}^{\hat{\pi}})$  is the Perron-Frobenius eigenvalue of the matrix

$$P_{\tilde{Q}}^{\hat{\pi}} = \left\{ \exp \left( \text{tr}(\tilde{Q}\tilde{Q}_j) + h X_j^{i_0} (X_j^{(m)})^{j_0} \prod_{a=1}^{l_0} X_j^{(a)} \right) P(\tilde{Q}_j | \tilde{Q}_i) \right\}_{0 \leq i, j \leq M} \quad (547)$$

and  $M = |\mathcal{Q}| - 1$  where  $\mathcal{Q} := \{sxx^T \text{ for some } s \in \mathcal{S}, x \in \mathcal{X}^{\nu+1}\}$ .

Theorem 45 is similar to Theorem 9, except the matrix  $P_{\tilde{Q}}$  in Theorem 9 is replaced by a new matrix  $P_{\tilde{Q}}^{\hat{\pi}}$ .

Using the same arguments and using the same replica assumptions, we can show a similar result as Lemma 12 that

$$\lim_{\nu \rightarrow 0} \rho(P_{\tilde{Q}}^{\hat{\pi}}) = 1. \quad (548)$$

Then, for a fixed  $\tilde{Q} \in \mathcal{Q}$ , the optimizer of the optimization problem in (545) of Theorem 45, say  $Q^*(h)$  can be expressed in the large system limit (cf. Proof of Lemma 14)

$$Q^*(h) = \lim_{\nu \rightarrow 0} \sum_{i=0}^M \lambda_i(\tilde{Q}) \hat{Q}_i(h) \quad (549)$$

where  $(y_1(\tilde{Q}), y_2(\tilde{Q}), \dots, y_M(\tilde{Q}))^T$  is the positive (left) eigenvector (all elements are positive) of  $P_{\tilde{Q}}^{\hat{\pi}}$  such that  $\sum_{i=1}^M \lambda_i(\tilde{Q}) \rightarrow 1$ , and

$$\hat{Q}_i(h) = \mathbb{E} \left[ \mathbf{Q}_1 \exp(\text{tr}(\tilde{Q}\mathbf{Q}_1) + hX_1^{i_0}(X_1^{(m)})^{j_0} \prod_{a=1}^{l_0} X_j^{(a)}) \middle| \mathbf{Q}_0 = \bar{Q}_i \right]. \quad (550)$$

On the other hand, it holds from (550) that

$$\frac{\partial}{\partial h} \hat{Q}_i(h) \Big|_{h=0} = \mathbb{E} \left[ X_1^{i_0}(X_1^{(m)})^{j_0} \prod_{a=1}^{l_0} X_1^{(a)} \mathbf{Q}_1 \exp(\text{tr}(\tilde{Q}\mathbf{Q}_1)) \middle| \mathbf{Q}_0 = \bar{Q}_i \right]. \quad (551)$$

Then, using the same arguments as ones to achieve (327), it holds that for all  $i \in [M]$ ,

$$\frac{\partial}{\partial h} \lim_{\nu \rightarrow 0} \frac{\partial}{\partial \nu} \left[ \beta^{-1} G^{(\nu)}(Q) - I^{(\nu, h)}(Q) \right] \Big|_{h=0, Q=\hat{Q}_i} \rightarrow \mathbb{E} \left[ X_1^{i_0} X^{j_0} \langle X \rangle_q^{l_0} \middle| X_0 = x_i^{(0)} \right] \quad (552)$$

if

$$\bar{Q}_i = s_i \begin{bmatrix} x_i^{(0)} \\ x_i^{(1)} \\ \vdots \\ x_i^{(\nu)} \end{bmatrix} \begin{bmatrix} x_i^{(0)} & x_i^{(1)} & \dots & x_i^{(\nu)} \end{bmatrix} \quad (553)$$

for some  $s_i \in \mathcal{S}$  and  $(x_i^{(0)}, x_i^{(1)}, \dots, x_i^{(M)})^T \in \mathcal{X}^{\nu+1}$ . Interested readers can refer to [4, Eqs. 165,166] or [43, Sec. (3.4.2)] for some detailed calculations which lead to a similar equation as (552).

Then using the concave property of the function  $\frac{\partial}{\partial h} \lim_{\nu \rightarrow 0} \frac{\partial}{\partial \nu} \left[ \beta^{-1} G^{(\nu)}(Q) - I^{(\nu, h)}(Q) \right] \Big|_{h=0, Q}$  in  $Q$  as in the proof of Theorem 9, we obtain (374).

### Acknowledgements

The author is extremely grateful to Prof. Ramji Venkataramanan, the University of Cambridge, for many suggestions to improve the paper. Especially, the algorithm AMPFB is proposed by Prof. Ramji Venkataramanan.

### REFERENCES

- [1] S. F. Edwards and P. W. Anderson, "Theory of spin glasses," *J. Phys. F: Metal Physics*, vol. 5, pp. 965–974, 1975.
- [2] A. Berezni, R. Müller, and H. S. Baldes, "Statistical mechanics of MAP estimation: General replica ansatz," *IEEE Trans. on Inform. Th.*, vol. 65, no. 12, pp. 7896–7934, Dec. 2019.
- [3] T. Tanaka, "A statistical-mechanics approach to large-system analysis of CDMA multiuser detectors," *IEEE Trans. on Inform. Th.*, vol. 48, no. 11, pp. 2888–2909, 2002.
- [4] Dongning Guo and S. Verdú, "Randomly spread CDMA: asymptotics via statistical physics," *IEEE Transactions on Information Theory*, vol. 51, no. 6, pp. 1983–2010, June 2005.
- [5] R. R. Müller, "Channel capacity and minimum probability of error in large dual antenna array systems with binary modulation," *IEEE Trans. Signal Process.*, vol. 51, pp. 2821–2828, 2003.

- [6] Y. Kabashima, T. Wadayama, and T. Tanaka, “Typical reconstruction limit of compressed sensing based on  $l_p$ -norm minimization,” *Journal of Statistical Mechanics: Theory and Experiment*, 2009.
- [7] D. Guo, D. Baron, and S. Shamai, “A single-letter characterization of optimal noisy compressed sensing,” *2009 47th Annual Allerton Conference on Communication, Control, and Computing (Allerton)*, pp. 52–59, 2009.
- [8] S. Rangan, A. K. Fletcher, and V. K. Goyal, “Asymptotic analysis of MAP estimation via the replica method and applications to compressed sensing,” *IEEE Trans. on Inform. Th.*, vol. 58, no. 3, pp. 1902–1923, March 2012.
- [9] G. Reeves and M. Gastpar, “The sampling rate-distortion tradeoff for sparsity pattern recovery in compressed sensing,” *IEEE Transactions on Information Theory*, vol. 58, pp. 3065–3092, 2012.
- [10] —, “Compressed sensing phase transitions: Rigorous bounds versus replica predictions,” *2012 46th Annual Conference on Information Sciences and Systems (CISS)*, pp. 1–6, 2012.
- [11] A. M. Tulino, G. Caire, S. Verdú, and S. Shamai, “Support recovery with sparsely sampled free random matrices,” *IEEE Transactions on Information Theory*, vol. 59, no. 7, pp. 4243–4271, 2013.
- [12] D. Guo and C.-C. Wang, “Asymptotic mean-square optimality of belief propagation for sparse linear systems,” *2006 IEEE Information Theory Workshop - ITW '06 Chengdu*, pp. 194–198, 2006.
- [13] A. Montanari and D. Tse, “Analysis of belief propagation for non-linear problems: The example of CDMA (or: How to prove Tanaka’s formula),” *2006 IEEE Information Theory Workshop - ITW '06 Punta del Este*, pp. 160–164, 2006.
- [14] D. Baron, S. Sarvotham, and R. G. Baraniuk, “Bayesian compressive sensing via belief propagation,” *IEEE Transactions on Signal Processing*, vol. 58, pp. 269–280, 2010.
- [15] S. Kudekar and H. D. Pfister, “The effect of spatial coupling on compressive sensing,” in *The 48th Annual Allerton Conference on Communications and Computation*, 2010, pp. 347–353.
- [16] F. Krzakala, M. Mézard, F. Sausset, Y. F. Sun, and L. Zdeborová, “Statistical-physics-based reconstruction in compressed sensing,” *Phys. Rev. X*, vol. 2, p. 021005, May 2012.
- [17] D. L. Donoho, A. Javanmard, and A. Montanari, “Information-theoretically optimal compressed sensing via spatial coupling and approximate message passing,” *IEEE Transactions on Information Theory*, vol. 59, pp. 7434–7464, 2011.
- [18] G. Reeves and H. D. Pfister, “The replica-symmetric prediction for random linear estimation with gaussian matrices is exact,” *IEEE Trans. on Inform. Th.*, vol. 65, no. 4, pp. 2252–2283, April 2019.
- [19] Dongning Guo, S. Shamai, and S. Verdú, “Mutual information and minimum mean-square error in gaussian channels,” *IEEE Transactions on Information Theory*, vol. 51, no. 4, pp. 1261–1282, 2005.
- [20] J. Barbier, F. Krzakala, N. Macris, L. Miolane, and L. Zdeborová, “Optimal errors and phase transitions in high-dimensional generalized linear models,” *Proceedings of the National Academy of Sciences*, vol. 116, no. 12, pp. 5451–5460, 2019.
- [21] J. Barbier and N. Macris, “The adaptive interpolation method: a simple scheme to prove replica formulas in bayesian inference,” *Probability Theory and Related Fields*, vol. 174, pp. 1133–1185, 2017.
- [22] F. Guerra and F. L. Toninelli, “The thermodynamic limit in mean field spin glass models,” *Communications in Mathematical Physics*, vol. 230, pp. 71–79, 2002.
- [23] P. Schniter, “Turbo reconstruction of structured sparse signals,” in *Proceedings of Conference on Information Sciences and Systems*, 2010.
- [24] Y. Ma, C. Rush, and D. Baron, “Analysis of approximate message passing with a class of non-separable denoiser and markov random field priors,” *IEEE Trans. on Inform. Th.*, vol. 65, no. 11, pp. 7367–7389, 2019.
- [25] R. Berthier, A. Montanari, and P. M. Nguyen, “State evolution for approximate message passing with non-separable functions,” *Information and Inference: A Journal of IMA*, vol. 9, no. 1, 2020.
- [26] D. Donoho, “Compressed sensing,” *IEEE Trans. on Inform. Th.*, vol. 52, no. 1, pp. 1289–1306, 2006.



- [27] E. Candès and M. Wakin, “An introduction to compressive sampling,” *IEEE Signal Process. Mag.*, vol. 25, no. 2, pp. 21–30, 2008.
- [28] C. A. Metzler, A. Maleki, and R. G. Baraniuk, “From denoising to compressed sensing,” *IEEE Trans. on Inform. Th.*, vol. 62, no. 9, pp. 5117–514, 2016.
- [29] M. Bayati and A. Montanari, “The dynamics of message passing on dense graphs, with applications to compressed sensing,” *IEEE Trans. on Inform. Th.*, vol. 57, no. 2, pp. 764–785, Feb 2011.
- [30] A. Montanari and R. Venkataramanan, “Estimation of low-rank matrices via approximate message passing,” *Annals of Mathematical Statistics*, 2020.
- [31] P. Lancaster and M. Tismenetsky, *The Theory of Matrices*, 2nd ed. Academic Press, 1985.
- [32] J. Stewart, *Multivariate Calculus*, 6th ed. Cengage Learning, 2008.
- [33] J. Barbier, M. Dia, N. Macris, and F. Krzakala, “The mutual information in random linear estimation,” in *2016 54th Annual Allerton Conference on Communication, Control, and Computing (Allerton)*, 2016, pp. 625–632.
- [34] S. M. Kay, *Fundamentals Of Statistical Signal Processing*. Addison Wesley Longman, 2001.
- [35] I. Chalendar and J. R. Partington, “Multivariable approximate Carleman-type theorems for complex measures,” *Annals of Probability*, vol. 35, no. 1, pp. 384–396, 2007.
- [36] P. Billingsley, *Probability and Measure*, 3rd ed. Wiley-Interscience, 1995.
- [37] P. W. Glynn and P. Y. Desai, “A probabilistic proof of the Perron-Frobenius Theorem,” 2018, arXiv:1808.04964.
- [38] R. Ellis, “Large deviations for a general class of random vectors,” *Annals of Probability*, vol. 12, no. 1, pp. 1–12, 1984.
- [39] S. R. S. Varadhan, “Large deviations,” *Annals of Probability*, vol. 36, no. 2, pp. 397–419, 2008.
- [40] E. Deutsch and M. Neumann, “Derivatives of the perron root at an essential nonnegative matrix and the group inverse of an  $M$ -matrix,” *Journal of Mathematical Analysis and Applications*, vol. 102, pp. 1–29, 1984.
- [41] L. S. Young, “Some large deviations results for dynamical systems,” *Trans. of. The American Mathematical Society*, vol. 318, no. 2, pp. 525–543, 1990.
- [42] J. M. Swart, “Large deviation theory,” 2012, the Czech Academy of Sciences Institute of Information Theory and Automation.
- [43] D. Guo, “Gaussian channels: Information, estimation, and multiuser detection,” Ph.D. dissertation, Princeton Univ., United States, 2004.
- [44] H. Royden and P. Fitzpatrick, *Real Analysis*, 4th ed. Pearson, 2010.