

Threat Detection and Investigation with System-level Provenance Graphs: A Survey

Zhenyuan Li [†], Qi Alfred Chen [¶], Runqing Yang [†], Yan Chen ^{‡*}

[†] Zhejiang University, China [¶] University of California, Irvine, USA [‡] Northwestern University, USA

With the development of information technology, the border of the cyberspace gets much broader, exposing more and more vulnerabilities to attackers. Traditional mitigation-based defence strategies are challenging to cope with the current complicated situation. Security practitioners urgently need better tools to describe and modelling attacks for defence.

The provenance graph seems like an ideal method for threat modelling with powerful semantic expression ability and attacks historic correlation ability. In this paper, we firstly introduce the basic concepts about system-level provenance graph and proposed typical system architecture for provenance graph-based threat detection and investigation. A comprehensive provenance graph-based threat detection system can be divided into three modules, namely, "data collection module", "data management module", and "threat detection modules". Each module contains several components and involves many research problem. We systematically analyzed the algorithms and design details involved. By comparison, we give the strategy of technology selection. Moreover, we pointed out the shortcomings of the existing work for future improvement.

Index Terms—Cyber Threat, Provenance Graph, Intrusion Detection, Digital Forensic, Information Flow

I. INTRODUCTION

Threat detection in cyberspace is an arms race between adversaries and defenders. In this arms race, attackers can almost always bypass existing detection mechanisms by discovering new attack surfaces, while defenders are usually tired of plugging various vulnerabilities [1]. Therefore, it is necessary for security researchers and practitioners to start rethinking about traditional mitigation techniques and try to design more robust and general detection mechanisms against not only the various existing attacks but also the previously unseen ones. The Defense's Advanced Research Projects Agency (DARPA) has launched a four-year project called Transparent Computing since 2015 [2], trying to find a high-fidelity and visible method to abstract the interaction between components in the opaque system. The researchers found that the provenance graph may be a promising tool, with a strong abstract expression ability and relatively high efficiency.

Now more and more research works [3]–[9] began to focus on detection and response algorithms based on provenance graphs and believe that provenance graph has the potential to become the next generation of more robust detection mechanisms. As shown in the Figure 1, the provenance graph represents the relationship between the control flow and data flow between the subject (such as processes, threads, etc.) and the object (such as files, registry, network sockets) in the system through a directed graph with timing. The provenance graph can link causal events in the system, regardless of the time between the two events. All in all, utilizing provenance graphs for threat detection and investigation has the following advantages:

- Provenance graphs altogether show system execution by representing them as interactions between system objects. Such dependency is innate for all the execution trace. Unstructured log like Auditd [10] can also be transformed into provenance graph [11].

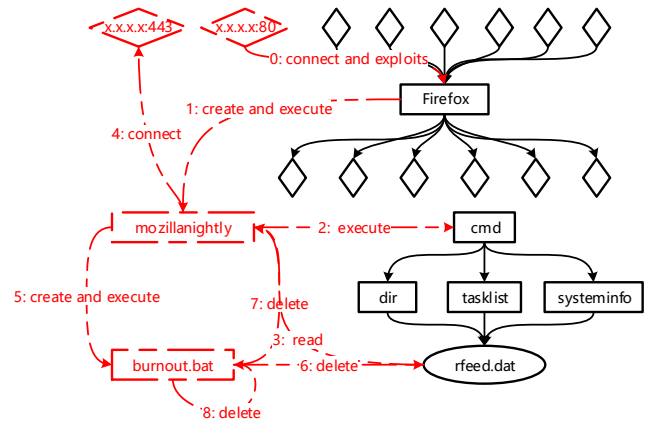

Fig. 1. A provenance graph sample

- Provenance graphs enable semantic-aware and robust detection. Compared to unstructured audit logs, provenance graphs with spatial and temporal information are more difficult to forge by attackers [12]. Moreover, provenance graphs provide richer semantic; thus security analysts can conduct more effective and thorough attack investigation.
- Provenance graphs keep all the execution history. Advanced persistent threat (APT) attacks [13] are long-running and stealthy attacks. To investigate such attacks, analysts need to access and understand the whole attack history. Actually, system execution history is necessary for any intrusion to trace the entry point and understand the impact.

A. Scope of this survey

Data provenance, also called data lineage, was initially introduced to find the origin of data in databases [14], [15]. In the subsequent researches, data provenances are widely adopted for multiple different purposes, such as reproducibility

* Corresponding author: ychen@northwestern.edu

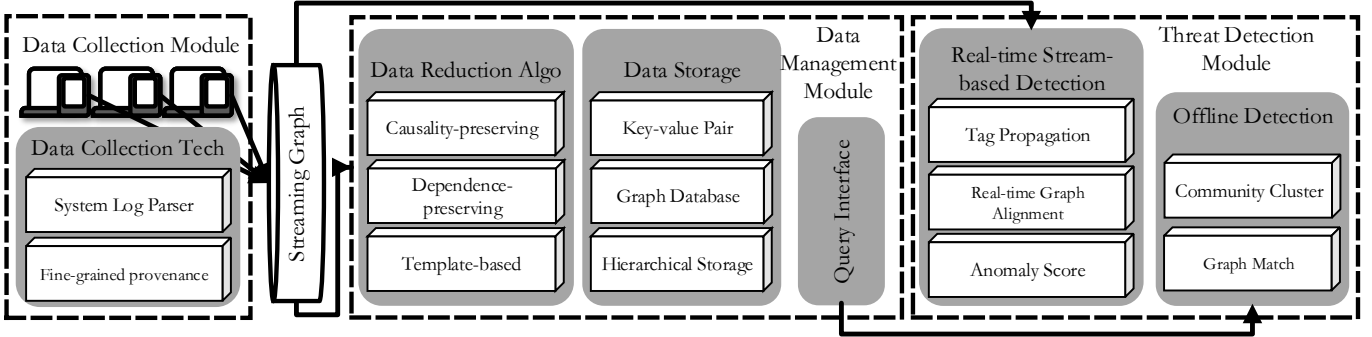

Fig. 2. A general framework of provenance-based threat detection system.

[16], [17], fault injection [18], and so on. Several surveys have also been done for different provenance applications [19]–[22].

Different from the above work, this paper focuses on threat detection and investigation with system-level provenance graphs.

B. Definition of System-level Provenance Graph

System-level provenance graphs treat all system-level entities as vertices and all operations between entities as edges. The operations are collected by auditing tools and generate events stream with timestamps. The order of events affect semantics, and events are directed, which indicate the flow of data or control. Thus, provenance graphs have strong spatial and temporal properties. Such properties are called *causality* for provenance graphs. Correspondingly, provenance graphs are also called *causality graphs*. A series of related basic definitions are given as follows:

DEFINITION 1. Subjects and Objects. Subject refer to the entity in the system that perform a operation to another entity that is called object. Subject and objects are denoted by u and v respectively.

It is worth mentioning that subjects and objects are relative, a subject of one operation can be the object of another event. Subjects can be processes, threads, etc. Moreover, Objects can be files, sockets, and so on. For different operation systems, the types of subject and object could be different. For example, Windows has unique registry objects and COM objects. However, it is not complicated to extend the provenance graph with more types of subjects and objects.

DEFINITION 2. Events refer to the operations between entities in the system. An event includes four main attributes: the subject performing the operation, the object being operated, the time when the event occurred, and the specific content of the operation. Thus, a event can be denoted by a quad $\langle \text{subject}, \text{object}, \text{time}, \text{operation} \rangle$ (or $\langle u, v, t, o \rangle$ for short.) Table I lists the most commonly used events. And it is relatively easy for analysts to add more events.

DEFINITION 3. Provenance Graph is the collection of all subjects, objects, and events, which can be denoted by $G = (S, O, E)$, where S represent the collection of subjects, O represent the collection of objects, E represent the collection of events.

In provenance graphs, both subjects and objects are represented as nodes, while events are represented as edges. There could be more than one edge between two nodes with different time or operation.

DEFINITION 4. Causality Dependency. Two events $e_1 = (u_1, v_1, t_1)$ and $e_2 = (u_2, v_2, t_2)$ have causality dependency, if $v_1 = u_2 \wedge t_1 < t_2$.

Causality dependencies indicate the possible data and control flow between two events. However, two events are causality dependent does not necessarily mean there are data or control flow between them. Thus, compared to taint analysis [23], the causality-based analysis will introduce more false dependencies and cause more severe explosion problems.

DEFINITION 5. Backward Tracking. Starting from a single detection point (e.g., a suspicious file), the backward tracking process tries to find all nodes in the provenance graph that causally affect the detection point.



DEFINITION 6. Forward Tracking. Starting from a single detection point, the forward tracking process tries to find all nodes in the provenance graph that causally depend on the detection point.

The backward and forward tracking is widely used together in attack investigation to find the entry point and analysis the impact of the attack.

C. Typical Design of Provenance Graph-based Detection System

In this section, we will introduce the composition of a typical provenance graph-based detection system. As Figure 2 shows, firstly, data collection modules should be installed in the target hosts to collect operations between system objects, which indicates provenance information. Coarse-grained provenance (§II-A) information can be obtained with built-in auditing systems for most of today’s operation systems, such as ETW [24] (Event Tracing for Windows) and Linux auditing system [10]. However, to collect more fine-grained provenance (§II-B), analyzer needs to install extra infrastructure, such as common libraries or hook into system calls. These fine-grained techniques have much higher overhead, ranging from $2\times$ to $10\times$, and sometimes require support from vendors. The collected information will be parsed into a stream of events defined by Definition 3. The event stream will be transformed

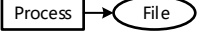
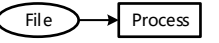
TABLE I
COMMON PROVENANCE EVENTS LIST

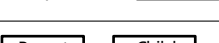
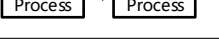
Sample graph	Description
	Write File
	Read File
	Send Data
	Receive Data
	Create New Process
	Inter-process communication

into a data management module or directly to a stream-based detection system.

In the data management module, a filter will apply different data reduction algorithm (§III-B) to remove redundant events according to different principles. Data reduction for provenance graph can not only reduce storage space but also reduce subsequent detection or investigation overhead. The compressed data will be stored in databases, which is appropriately designed to support frequent queries (§III-C) and persistent access (§III-A).

The last and most important module is threat detection modules (§IV). Intrusion detection based on provenance graphs is not straight-forward. The most significant challenge comes from the massive amount of data generated in real time. A typical operating system will perform massive file read and write and network connection operations, which brings a lot of background noises. According to the survey results in [25], for a typical bank with 20,000 hosts, about 70 PB of logs are generated annually. How to find out suspicious events timely is also challenging. One mitigation strategy for both challenges is to build a concise yet comprehensive model incrementally with stream data input.

All in all, to design an ideal provenance graph-based detection and investigation system, we should take the following four research questions into consideration:

- **RQ1:** How to reduce the size of the data storage as much as possible while maintaining the semantics?
- **RQ2:** How to balance the space efficiency of the provenance graph storage with the time efficiency of the query?
- **RQ3:** How to design an efficient and robust intrusion detection algorithm and minimize false positives?
- **RQ4:** How to shorten the response time of detection and forensics as much as possible?

D. A Brief History of The Adoption of Provenance Graph in Threat Detection

As shown in Figure 3, we studied dozens of research work and observed two major technology trends. The first trend we

TABLE II
COMPARISON OF PROVENANCE DATA COLLECTION APPROACHES

	O/H	Acc.	Granularity	Other Requirements
System-level [11], [26]	Low	Low	Coarse	None
Execution Partition [9], [27]–[30]	Low	Mid	Mid	Instrumentation
Causality Inference [31]–[33]	Mid	Mid	Mid	Training or Dual-Execution
Taint Analysis [34]–[36]	High	High	Fine	Tainting Framework
Multi-layer [37]	Low	Low	Coarse	Static Analysis

find is *the study of fine-grained provenance graph collection*. The original system-level provenance graph is coarse-grained, which has lots of false dependence and thus leads to the “dependence explosion” problem. Fine-grained data collection can fundamentally mitigate this problem, while the overhead is much higher.

The second trend we find is *the study of realtime threat detection*. The response time is critical to real-world security investigation. For example, a quick response can effectively avoid the same attack and reduce the loss. However, the investigations after building the complete provenance graph introduce a long delay to such responses. So far, researchers have been focusing on streaming graph-based detection that can perform real-time detection and investigation.

E. Contributions

All in all, this survey makes the following contributions:

- We present the first throughput survey for threat detection and investigation with provenance graph.
- We taxonomize various representative techniques used in existing papers and depict a typical architecture design of the provenance-based threat detection systems today.
- We employ various performance indicators to systematically compare dozens of existing detection systems. Based on the comparison, we identify the strategy of technology selection for real-world deployment.

II. DATA COLLECTION MODULE

As the first step, security analyzers need to deploy collectors on target hosts to collect provenance information. Generally, there are two kinds of collectors: The coarse-grained collectors that focus on system-level information flow, such as file reads, inter-process communication, and so on; and fine-grained collectors that involve intra-process information flow tracking. We will comparatively introduce the design and mechanism of these two kinds of collectors in §II-A and §II-B.

A. Coarse-grained Provenance Collection

Coarse-grained data collectors only track the provenance between system-level objects, also called system-level collectors. The system-level provenance can be obtained from multiple different sources. Most of today’s operating systems have built-in audit system, which can provide necessary information flow among system-level objects. There are also third-party

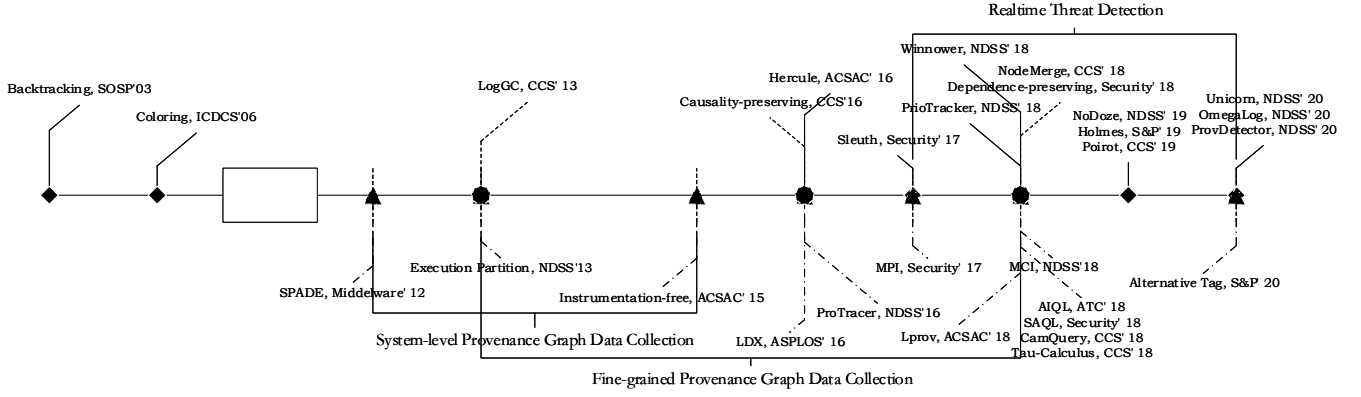

Fig. 3. A brief history of the adoption of provenance graph in threat detection

collectors, such as FUSE [38]. CamFlow [26] adopts LSM [39] and NetFilter [40] to hook kernel objects' security data structure on Linux. Ma et al. proposed [9] to obtain system event from windows built-in auditing system ETW [24]. SPADE [11] provides multiple collector modules for different systems, for example, hooking system call through Auditd [10] on Linux and MacFUSE [41] on Mac OS, etc.

For different operation system and audit tools, the event list could be different. For Linux, all objects are abstracted as files. Table I shows the simplest provenance events list. For windows, reading and writing to the registry is important. However, such extension is trivial and will not affect later data management and detection too much. W3C Prov-DM [42] provide more specific definition. In practice, security analyzer should customize the events list to reach a balance between overhead and functionality.

B. Fine-grained Provenance Collection

One common challenge for causality tracking with provenance graph is the "Dependence Explosion" problem, which causes a large number of benign nodes marked as malicious and brings a lot of computing overhead and human labor. Specifically, for a provenance node with m input edges and n output edges, there could be as much as $m \times n$ possible information flows. Fine-grained provenance collectors can solve the "Dependence Explosion" problem fundamentally by associating inputs and outputs more accurately. Ideally, the number of information flow can be reduce to $m + n$. Thus, researchers proposed lots of approaches to collect fine-grained provenance, as shown in Table II.

Taint analysis that can accurately track information flow within processes are widely used to prevent information leak or zero-day attacks [23], [43]–[45]. By combining inter-process provenance analysis and intra-process analysis, researchers [34]–[36] are able to accurately track the information flow. However, taint analysis introduces significant overhead, slowing down programs by $2\times$ to $10\times$ or more.

Excessive overhead makes Taint infeasible for large-scale threat detection. To reduce the overhead, Ma et al. [9] first proposed execution partition-based approach. They figure out that taint analysis, which tracking information flow between

variables, is too fine-grain and not necessary to build causality connection between inputs and outputs. Thus, they try to find a middle ground between coarse-grain processes and fine-grain variables, called *unit*. Many later works [27]–[30] adopt a similar idea. All these works make a different assumption about what kind of unit the causality should be maintained in. For example, [9] believes that processes can be split into many main loops, and each loop completes a task. Thus, the causality relationship will only be built in the loop. However, such assumptions do not always hold, and these approaches either need extra infrastructure or support from vendors.

Besides improving the accuracy of information flow tracking, causality inference can also effectively reduce false positives. Kwon et al. proposed dual execution-based causality inference [31], [32]. By comparing the output buffer contents of the master and slave at the sink(s), they can determine if the sink(s) are causally dependent on the source(s). Hassan et al. proposed Winnow [33] that tries to infer the connection by training a model to succinctly summarize the behavior of many nodes.

After this module, the collected provenance information can be transmit directly to detection module (§IV) or through a data management module (§III) first.

III. DATA MANAGEMENT MODULE

Ubiquitously monitoring system in an organization or enterprise will generate massive amount of data. An ideal data management module should consider how to reduce storage cost while providing effective query interface. In this section, we introduce how to design such an ideal data management module from 3 aspects: data storage mechanism (§III-A), data reduction algorithms (§III-B), and query interface (§III-C), and try to answer two research questions, namely, RQ1: How to reduce the size of the data storage as much as possible while maintaining the semantics and RQ2: How to balance the space efficiency of the provenance graph storage with the time efficiency of the query?

A. Data Storage Mechanism

The data storage mechanism is the foundation of the whole data management module. The data storage mechanism used

depends on subsequent operations. We will systematically analyze the relationship between different detection algorithms and their corresponding data storage mechanism in §IV.

A straightforward idea is to store provenance graph with a graph database. Graph database [46] is a widely used NoSQL database, which stores all data as nodes and edges, and provide semantic query interfaces with nodes and edges. Thus, performing graph algorithms, such as backtracking and graph alignment, is relatively easy. However, existing graph database needs to load the whole graph database in the main memory to enable queries. In a large organization, terabytes of data needs to be loaded for a long-running attack campaigns. Even though allocating such large memory is still possible, such approaches incur significant I/O overhead. To mitigate this challenge, the security researchers design detection algorithms [3], [4], [6], [47] that consume every event in the stream only once, and adopt state stored in cache to represent the event history. Corresponding to the cached graph stored in memory, we call the input of such approaches as *streaming graph*.

Vertex-centric database, built on relational database, store all entries as $\langle K, V \rangle$ pairs, where K is a identifier representing vertexes (nodes) and V is a list of several entries, such as parents nodes, child nodes, and rules [5]. Such store mechanism can easily count interaction between nodes, thus widely used in abnormal analysis-based detection systems. Furthermore, relational database can be stored in disk and accelerated with in-memory cache, and thus more feasible than graph database-based approaches.

B. Data Reduction Algorithms for Provenance Graphs

In recent years, more organizations, enterprises, and government agencies suffered from advanced persistent threat (APT) attacks [23-25]. These attacks often have multiple phases and last for quite some time. Moreover, these attacks are often very covert and difficult to detect. It has been reported that the average duration of advanced persistent threat attacks lurking within an enterprise is as long as 188 days [26]. However, the amount of data collected in the provenance graph is extremely large, and the amount of data for a single machine can easily exceed 1GB in one day. Moreover, the number of hosts in a large enterprise or organization can reach tens of thousands. This thus brings significant data storage overhead. At the same time, a massive amount of data also brings great difficulties to subsequent data backtracking. Therefore, the algorithm for compressing the provenance graph is a subject that researchers need to study.

The provenance graph is a special graph whose data mainly includes two parts: nodes (subjects and objects) and edges (events). The essence of the compression of the provenance graph is to remove as many unnecessary nodes and edges as possible while maintaining as much semantics as possible. Specifically, three questions need to be considered: 1) How to define the semantics that needs to be maintained? 2) What is the computational complexity of the compression algorithm? 3) How effective is the compression algorithm? With these three questions in mind, we discuss how to compress nodes and edges, respectively.

In this section, we mainly focus on data reduction methods, which refer to some data reduction principle with a guarantee of limited semantic loss.

1) Data Reduction for Edges

In a typical operating system, processes and file objects will exist for a while and generate lots of operations between them. Thus, the number of edges is much larger than that of nodes in most provenance graphs, especially for long-running systems. Data reduction algorithms for edges shall introduce higher data reduction ratios than the algorithms for nodes.

Data reduction approaches need to handle the trade-off between data compression ratio and semantic retention. It is almost impossible to prune data without losing any semantics. Thus, researchers should consider how much semantics should be preserved after data reduction. Causality-preserving reduction approach [25] and dependency-preserving reduction approach [48] are proposed to define the loss. A simple and intuitive definition of causality is that the first write to an object will affect the subsequent readings.

Causality-Preserving Reduction (CPR). As we discussed in §I, causality analysis is the most commonly used operation in provenance graph. Xu et al. proposed causality-preserving reduction [25] that maintains the ability to causality analysis on provenance graphs. A simple and intuitive definition of causality is that the first write to an object will affect the subsequent readings. Thus, to avoid changing the causality between objects, CPR will only remove any repeated writes/reads between a pair of objects with no read/write to the destination object. CPR can completely preserve the topology of the graph, and ensure that most detection algorithms are still valid on the compressed graph. However, the algorithm will lose statistical information, including the access frequency, etc. In real-world scenarios, analyzers should pick reduction algorithms according to the subsequent analysis.

Full Dependence-Preserving Reduction (FDR) and Source Dependence-Preserving Reduction (SDR). As Figure 4 shows, while CPR preserves the semantics in provenance graphs well, it has limited data reduction ratio. To further compress the provenance graph, Hossain et al. [48] proposed dependence-preserving data compaction. Dependence-preserving reduction only considers the basic operation on provenance graphs, namely, backward tracking and forward tracking. FDR and SDR rely on global reachability of provenance graphs, which is much more expensive to compute than CPR. To overcome these computational challenges, they proposed versioned dependence graphs, which are widely used to simplify computation produce of provenance [49], [50].

2) Data Reduction for Nodes

Some techniques try compressing provenance logs via web graph compression algorithm [51] or detecting common sub-graphs and compressing them [52]. The main problem of these techniques is that they involve expensive runtime overhead. However, system-level provenance graphs expand quickly. Thus, light-weight compression algorithms are required.

Towards designing efficient compression algorithms, Lee et al. [53] designed garbage collecting for provenance, which can locate isolated temporary nodes. Removing these nodes will not affect causality in provenance graphs. Tang et al. proposed

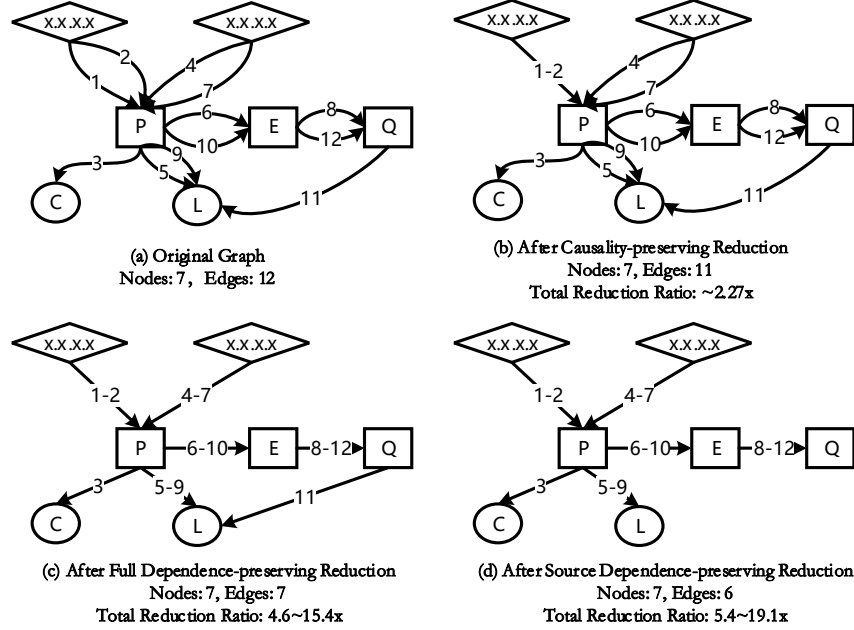

Fig. 4. Data reduction algorithms for edges

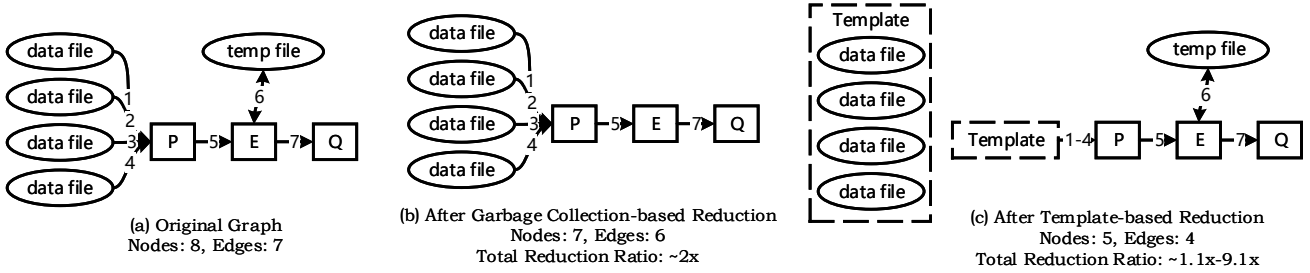

Fig. 5. Data reduction algorithms for nodes

nodemerge [54], which adopt enhanced FP-growth algorithm to find common access patterns during program initialization. The compression ratio of both algorithms is lower than edge-based reduction algorithm.

C. Query Interface

Most detection approaches tend to use naive database query interfaces and fixed data structure to ensure universality. However, for customized attack investigation requirement, the naive query interfaces may not be flexible enough. To fill this research gap, researchers proposed series of provenance graph query systems [55]–[58].

These query systems provide investigation capabilities that naive databases cannot provide or require extra effect. These capabilities are list as following:

Causality Tracking. Provenance graphs have strong spatial and temporal properties, which is thus different from ordinary graphs. Backward and forward tracking should take these properties, which are called causality, into consideration. Such tracking operations are common tasks in forensic for root cause discovery and impact analysis [59]. Almost all the query systems regard the causality tracking as their basic function

and provide convenient language or interface support [55], [57], [58].

Provenance Graph Pattern Matching. Graph pattern matching is at the core of graph query. For threat detection with provenance graph, graph patterns can be used to represent attack behaviors with rich semantics. Thus, pattern matching is equivalent to threat detection. Shu et al. [57] points out that an ideal pattern matching system should be able to treat patterns as values and compose larger patterns based on others to enable pattern reuse and abstraction. To accomplish such targets, Shu et al. adopt well-designed query language and typing system.

Stream-based Query. Threat detection is a time-critical mission. To reduce the delay between the attack and the investigation and response, Gao proposed SAQL [56], which is able to take real-time event feed aggregated from multiple hosts as input and provide rich interface. They built the query engine on the top of Siddhi [60] to leverage its mature stream management engine. To tackle the scalability challenge, they designed a master-dependent query scheme that identifies compatible queries and groups them to use a single copy.

Anomaly Analysis. Security log auditing and threat de-

tection rely heavily on expert experience. In order to adopt domain knowledge from expert to express anomalies, Gao provides a domain-specific query language, SAQL [56], which allows analysts to express models for (1) rule-based anomalies, (2) time-series anomalies, (3) invariant-based anomalies, and (4) outlier-based anomalies.

All in all, the query systems provide analysts with a thorough attack investigation capability. These systems typically build on mature stream processing system or database, but take provenance graphs' special properties into consideration with specifically-designed data model and query language.

IV. THREAT DETECTION MODULE

Using the traceability diagram, security analysts can link causal events and entities in the host to obtain a good abstraction ability, which can well describe the data flow and control flow in the system. In order to connect multiple points involved in an attack, the simplest method is to backtrack [22, 30]. However, the simple backtracking algorithm is difficult to distinguish normal data flow from malicious control flow. There is a problem of dependence explosion, so the accuracy is very low. In order to solve this problem and provide a real-time, efficient, and low false positive threat detection system, researchers have proposed many different schemes. In this section, we first give several threat models (§IV-A) commonly used in threat detection research using provenance graphs. Then we give a comparison of the existing intrusion detection systems and try to answer two of the research questions we summarize in §I-C: RQ3: How to design an efficient and robust intrusion detection algorithm and minimize false positives? and RQ4: How to shorten the response time of detection or traceability forensics as much as possible?

A. Attack Models

1) Multi-Stage APT Attack (APT) Model

A large part of threat detection using a provenance graph aims at detecting advanced persistent threat (APT) attacks. APT attacks have the characteristics of advancedness, complexity, concealment, and persistence. Typical APT attacks can be divided into multiple stages, as ATT&CK Metrics [67] shows. Every stage has a particular target and a variety of different technologies to achieve the target. Real-world attacks usually involve three or more stages. Thus, even if missing some stages, security analyzers can still identify a threat and complete the missing piece with digital forensic techniques. Meanwhile, analyzers can also adopt the multi-stage feature to filter out false alerts.

2) Information Leakage (Leakage) Model

The information leakage model assumes that the attackers are able to take control the entire target system. The goal is to pass the specified sensitive information to endpoints controlled by the attacker in various ways. A large part of APT attacks is also aimed at information leakage. However, unlike the multi-stage APT attack model, the information leakage model does not focus on specific attack technologies, but focuses on the information flow in the system, and continuously monitors whether sensitive information flows to unauthorized points.

3) General Attack (General) Model

General attacks are much more diverse. There are low and stealth attacks like APT but also quick and overt attacks such as ransomware. The target could be stealing information but also pure destruction. Thus, more general and detailed attack models are required to detect such attacks.

B. Threat Detection and Investigation System Design

Provenance graphs are able to link events in system with causality, regardless of the time between events, which thus have a overall view of entire attacks. Backtracking, proposed by King [59], is the earliest and most fundamental attack investigation method on provenance graph. Given a detection point, backtracking is able to traverse the whole historical context of system execution. However, naive backtracking requires complete provenance graph and too much human intervention, which thus is neither timely nor efficient.

An ideal threat detection system needs to consider three attributes at the same time: fast response, high efficiency, and high accuracy. However, the size of a provenance graph, even pruned, is very large. Therefore, threat detection on provenance graphs could introduce high space and computing overhead. In order to find a balance between the three attributes, researchers have made many attempts. These approaches can be divided into 3 categories according to the main detection design.

Firstly, *tag propagation-based approaches* [3], [6] try to store system execution history incrementally in tags and utilize tag propagation process to trace the causality. These algorithms have roughly linear time complexity. Moreover, they can take streaming graph as input and respond fast. Secondly, *abnormal detection* [5], [7], [8], [64] try to identify abnormal interaction between nodes. Thus, these approaches will model normal behaviors by collecting historical data or data from parallel systems. Finally, *graph matching-based approaches* [6], [47], [62] try to identify suspicious behavior by matching substructure in graphs. However, graph matching is computational complex. Researchers try to extract the graphs' features with graph embedding or graph sketch algorithm or use approximate methods.

As shown in Table IV, the target attack models, fundamental detection algorithms, and data management model affect each other and basically determine the design of the detection system. We will compare the system properties according to the ideal system properties introduced in §I-C.

1) Graph Matching-based Detection

The graph representation ensures the adversarially robustness of provenance graph-based detection approaches. The connections between nodes indicate the relationship between system entities. Nodes close to each other are more likely to serve the same function. Thus, utilizing community detection algorithm, analysts are able to correlate nodes in the same attack scenarios. Substructures in a provenance graph can completely describe the malicious behavior. Therefore, it is a very straightforward idea to detect by graph matching. However, graph matching is NP-complete problem [68]. Thus, researchers have proposed many approximate methods.

TABLE III
TAXONOMY OF EXISTING PROVENANCE GRAPH-BASED THREAT DETECTION SYSTEM DESIGNS

Approaches	Attack Models	Detection Models	Data Management	Threat Detection	Threat Investigation	Response Time	Overhead	TP	FP
Back-tracking [59]	General	Naive Backtracking	Cached Graph	✗	✓	Long	Mid	-	High
HERCULE [61]	General	Community Detection	Cached Graph	✗	✓	Long	Low	-	High
POIROT [6]	APT	Graph Alignment	Streaming Graph	✓	✓	Short	Mid	Mid	Low
Log2vec [62]	General	Graph Embedding	Cached Graph	✓	✗	Long	Low	Mid	Mid
ProvDetector [63]	General	Graph Embedding	Cached Graph	✓	✗	Long	Low	Mid	Mid
UNICORN [47]	APT	Graph Sketch Cluster	Streaming Graph	✓	✗	Mid	Low	High	High
PrioTracker [64]	APT	Anomaly Scores	Cached Graph	✓	✗	Mid	Low	Mid	Mid
NoDoze [7]	APT	Anomaly Scores	Vector-centric DB	✓	✗	Mid	Low	Mid	Mid
P-gaussian [8]	APT	Anomaly Scores	Vector-centric DB	✓	✗	Mid	Mid	Mid	Mid
Pagoda [5]	APT	Anomaly Scores	Vector-centric DB	✓	✗	Mid	Low	Mid	Mid
Coloring [65]	General	Process Coloring	Cached Graph	✗	✓	Long	Low	-	High
SLEUTH [3]	Leakage	Tag Propagation	Streaming Graph	✓	✗	Short	Mid	High	High
HOLMES [4]	APT	Tag Propagation	Streaming Graph	✓	✓	Short	Low	Mid	Low
MORSE [66]	APT	Tag Propagation	Cached graph	✓	✓	Long	Mid	Mid	Mid

Milajerdi et al. proposed POIROT [6] and the key online graph alignment algorithm. Utilizing query graph manually extracted from threat intelligence and the graph alignment algorithm, they could locate threats in provenance graph quickly. However, extracting query graphs requires a lot of manual work. Thus, it is difficult to cover all kind of advanced attacks in various forms.

Graph embedding are widely used to extract graph features into vectors while maximally preserving properties like graph structure and information [69]–[71]. Utilizing the graph embedding, researchers can effectively and efficiently detect threats by separating malicious and benign log entries into different clusters and identifying malicious ones [62], [63]. However, such methods typical work on cached graph, so the response is slower; meanwhile, it requires a lot of training data, so it is not suitable for advanced attacks.

To tackle the above two challenges, Han et al. proposed UNICORN [47], which adopts a historical graph sketch approach to build an incrementally updatable, xed size, longitudinal graph data structure. So, they can find threats when the graph structure changed. However, this is an anomaly detection-based approaches, which thus suffers from the limitation of anomaly detection.

2) Anomaly Score-based Detection

Anomaly score-based detection tries to quantify the suspiciousness of each edge between node pairs. Using historical statistics, researchers can find abnormal access in system. Specifically, Pagoda [5] takes into account the anomaly degree of both a single provenance path and the whole provenance graph. Their subsequence work P-Gaussian [8] can detect variants using gaussian distribution scheme. PrioTracker [64] and NoDoze [7] adjust the events' suspiciousness based on its neighbor's suspiciousness.

Compared with graph-based anomaly detection, anomaly score-based detection has much less parameters to tune, which thus is much easier to implement and deploy. Meanwhile, anomaly score-based detection typically adopts a vector-centric relational database, which is much faster than graph database.

3) Tag Propagation-based Detection

Tag propagation-based detection can be divided into two phases, namely, tag initialization and tag propagation. In tag initialization phase, tags are assigned to nodes. The amount of nodes is much less than edges. Thus, storing and updating tags is efficient. In tag propagation phase, tags are passed along the edge according to the pre-designed rules. In this phase, different tags could meet at the same node and triage future calculations together.

Process coloring proposed by Jiang et al. [65] is a simplified tag-based approach. In the tag initialization phase, tags (colors) are assigned to each remotely-accessible server or process. Then, in the tag propagation phase, tags can be inherited by spawned child processes or diffused indirectly through process actions. As a result, analysts can quickly identify the break-in point without tedious backtracking.

Follow-up works adopt more complex tag design to implement more functions. SLEUTH [3] utilizes two types of tags, namely, trustworthiness tags (t-tags) and confidentiality tags (c-tags), to implement a policy enforcement framework. In short, an alarm is triggered when a node with low trustworthiness accesses a node with high confidentiality. Specifically, in the tag initialization phase, t-tags and c-tags are assigned to the nodes according to the predefined trustworthiness and confidentiality respectively. In the tag propagation phase, the trustworthiness and confidentiality are propagated, and the accesses that violate the policy will be captured.

However, tag propagation-based approaches also suffer from the "dependency explosion" problem. Without extra control, single tag can spread to everywhere and cause a lot of false positives. To tackle this challenge, Milajerdi et al. proposed HOLMES [4], which raises the detection threshold by requiring the aggregation of more tags. In the tag initialization phase, HOLMES assigns fewer tags only to process with suspicious behaviors. These suspicious behaviors contain lots of false positives. Thus, in the tag propagation phase, HOLMES requires multiple tags to aggregate and reach a pre-defined threshold, and then triage the alert. Another way to avoid the dependency explosion problem is to make the impact decrease as the number of transmission rounds increases. MORSE [66]

achieves this with tag decay and tag attenuation techniques.

All in all, tag propagation-based approaches have the following advantages. Firstly, tag initialization and propagation processes replace computationally expensive graph matching algorithm and lower the overhead. Secondly, tag propagation-based approaches take one event at a time and update states correspondingly, which thus can support streaming graph input naturally and can respond quickly. Last but not least, the information stored in tags can be used to locate the point involved in the intrusion quickly, and thus avoid the tedious backtracking algorithm.

V. RESEARCH CHALLENGES

In this section, we summarize the limitations of existing works and propose several research challenges for future studies in this area.

A. Empirical Parameter Setting

To distinguish malicious behaviours from benign ones, provenance graph-based threat detection and investigation systems involve a lot of parameters, whose tuning significantly affects the accuracy and efficiency of systems. However, parameters are determined empirically. For example, Holmes [4] adopts empirical numeric scores for each malicious behavior and empirical alert threshold; NoDoze [7], etc. take empirical decay factors. However, it is not easy to ensure that the parameters are suitable for all the scenarios since different systems' behaviors can be quite diverse. Even for the same host, the behaviors could be diverse at different times. Thus, a set of parameters tuned for a host may not work well on another one.

Thus, one possible solution direction is to employ adaptive parameter adjustment mechanisms for every different hosts. We can adopt new techniques such as Few-Shot Learning or Zero-Shot Learning widely used in areas such as knowledge engineering [72], [73].

B. Manual Signature Extraction

The accuracy of signature-based detection approaches heavily rely on the signature extracted. However, signature extraction for provenance graph is non-trivial. On one hand, both academia and industry lack well-labelled real-world attack graph data; on the other hand, extracting typical pattern and corresponding semantic is laborious.

For example, Poirot [6] adopts manually extracted and pre-processed query graphs for all different attacks. The extraction process requires intensive labour. Nevertheless, the accuracy is still not promised. If the query graphs are too detailed, they may miss a variety of similar attacks. On the contrary, if the query graphs lack details, there will be lots of false positive.

Thus, it is highly desired to find a more intelligence and automatic signature extraction framework. Fortunately, more and more security companies start to provide threat intelligence with attack graphs. We may be able to adopt these data to mine general attack patterns.

VI. CONCLUSION

As a system behavior abstraction tool, provenance graphs are widely accepted for endpoint threat detection. In this paper, we present the typical system architecture for provenance graph-based threat detection. Then, we systematically introduced and compared techniques choice involved and concluded existing research challenges for future study.

REFERENCES

- [1] "Symantec internet security threat report," 2020. [Online]. Available: <https://docs.broadcom.com/doc/istr-24-2019-en>
- [2] "Darpa transparentcomputing," 2015.2. [Online]. Available: <https://www.darpa.mil/program/transparent-computing>
- [3] M. N. Hossain, S. M. Milajerdi, J. Wang, B. Eshete, R. Gjomemo, R. Sekar, S. Stoller, and V. N. Venkatakrishnan, "SLEUTH: Real-time Attack Scenario Reconstruction from COTS Audit Data," in *26th USENIX Security Symposium, USENIX Security 2017, Vancouver, BC, Canada, August 16-18, 2017.*, 2017, pp. 487–504. [Online]. Available: <https://www.usenix.org/conference/usenixsecurity17/technical-sessions/presentation/hossain>
- [4] S. M. Milajerdi, R. Gjomemo, B. Eshete, R. Sekar, and V. Venkatakrishnan, "HOLMES: Real-Time APT Detection through Correlation of Suspicious Information Flows," in *2019 IEEE Symposium on Security and Privacy (SP)*, May 2019, pp. 1137–1152, iSSN: 1081-6011.
- [5] Y. Xie, D. Feng, Y. Hu, Y. Li, S. Sample, and D. Long, "Pagoda: A Hybrid Approach to Enable Efficient Real-time Provenance Based Intrusion Detection in Big Data Environments," *IEEE Transactions on Dependable and Secure Computing*, pp. 1–1, 2018.
- [6] S. M. Milajerdi, B. Eshete, R. Gjomemo, and V. Venkatakrishnan, "POIROT: Aligning Attack Behavior with Kernel Audit Records for Cyber Threat Hunting," in *Proceedings of the 2019 ACM SIGSAC Conference on Computer and Communications Security*, ser. CCS '19. New York, NY, USA: ACM, 2019, pp. 1795–1812, event-place: London, United Kingdom. [Online]. Available: <http://doi.acm.org/10.1145/3319535.3363217>
- [7] W. U. Hassan, S. Guo, D. Li, Z. Li, Z. Chen, K. Jee, Z. Li, and A. Bates, "NoDoze: Combatting Threat Alert Fatigue with Automated Provenance Triage," in *NDSS*, 2019. [Online]. Available: <https://www.zhichunli.org/publication/NDSS19-NoDoze.pdf>
- [8] Y. Xie, Y. Wu, D. Feng, and D. Long, "P-Gaussian: Provenance-Based Gaussian Distribution for Detecting Intrusion Behavior Variants Using High Efficient and Real Time Memory Databases," *IEEE Transactions on Dependable and Secure Computing*, pp. 1–1, 2019.
- [9] S. Ma, K. H. Lee, C. H. Kim, J. Rhee, X. Zhang, and D. Xu, "Accurate, Low Cost and Instrumentation-Free Security Audit Logging for Windows," in *Proceedings of the 31st Annual Computer Security Applications Conference*, ser. ACSAC 2015. New York, NY, USA: ACM, 2015, pp. 401–410. [Online]. Available: <http://doi.acm.org/10.1145/2818000.2818039>
- [10] "Linux auditd," 2020.3. [Online]. Available: <https://linux.die.net/man/8/auditd>
- [11] A. Gehani and D. Tariq, "SPADE: support for provenance auditing in distributed environments." Springer-Verlag New York, Inc., 2012, pp. 101–120.
- [12] X. Han, T. Pasquier, and M. Seltzer, "Provenance-based intrusion detection: opportunities and challenges," in *10th {USENIX} Workshop on the Theory and Practice of Provenance (TaPP 2018)*, 2018.
- [13] "Advanced persistent threat," 2020. [Online]. Available: https://en.wikipedia.org/wiki/Advanced_persistent_threat
- [14] P. Buneman, S. Khanna, and T. Wang-Chiew, "Why and where: A characterization of data provenance," in *International conference on database theory*. Springer, 2001, pp. 316–330.
- [15] A. Woodruff and M. Stonebraker, "Supporting fine-grained data lineage in a database visualization environment," in *Proceedings 13th International Conference on Data Engineering*. IEEE, 1997, pp. 91–102.
- [16] M. Greenwood, C. Goble, R. Stevens, J. Zhao, M. Addis, D. Marvin, L. Moreau, and T. Oinn, "Provenance of e-science experiments-experience from bioinformatics," 2003.
- [17] S. Miles, P. Groth, M. Branco, and L. Moreau, "The requirements of using provenance in e-science experiments," *Journal of Grid Computing*, vol. 5, no. 1, pp. 1–25, 2007.

- [18] T. Naughton, W. Bland, G. Vallee, C. Engelmann, and S. L. Scott, "Fault injection framework for system resilience evaluation: fake faults for finding future failures," in *Proceedings of the 2009 workshop on Resiliency in high performance*, 2009, pp. 23–28.
- [19] Y. L. Simmhan, B. Plale, and D. Gannon, "A survey of data provenance in e-science," *ACM Sigmod Record*, vol. 34, no. 3, pp. 31–36, 2005.
- [20] J. Freire, D. Koop, E. Santos, and C. Silva, "Provenance for Computational Tasks: A Survey," *Computing in Science & Engineering*, vol. 10, no. 3, pp. 11–21, May 2008. [Online]. Available: <http://ieeexplore.ieee.org/document/4488060/>
- [21] F. Zafar, A. Khan, S. Suhail, I. Ahmed, K. Hameed, H. M. Khan, F. Jabeen, and A. Anjum, "Trustworthy data: A survey, taxonomy and future trends of secure provenance schemes," *Journal of Network and Computer Applications*, vol. 94, pp. 50–68, Sep. 2017. [Online]. Available: <https://linkinghub.elsevier.com/retrieve/pii/S1084804517302229>
- [22] M. Herschel, "A survey on provenance: What for? What form? What from?" p. 26.
- [23] J. Newsome and D. X. Song, "Dynamic taint analysis for automatic detection, analysis, and signaturegeneration of exploits on commodity software." in *NDSS*, vol. 5. Citeseer, 2005, pp. 3–4.
- [24] "Event tracing for windows," 2020.3. [Online]. Available: <https://docs.microsoft.com/en-us/windows/win32/etw/about-event-tracing>
- [25] Z. Xu, Z. Wu, Z. Li, K. Jee, J. Rhee, X. Xiao, F. Xu, H. Wang, and G. Jiang, "High Fidelity Data Reduction for Big Data Security Dependency Analyses," in *Proceedings of the 2016 ACM SIGSAC Conference on Computer and Communications Security*, ser. CCS '16. New York, NY, USA: ACM, 2016, pp. 504–516. [Online]. Available: <http://doi.acm.org/10.1145/2976749.2978378>
- [26] T. Pasquier, X. Han, M. Goldstein, T. Moyer, D. Eysers, M. Seltzer, and J. Bacon, "Practical whole-system provenance capture," in *Proceedings of the 2017 Symposium on Cloud Computing*, ser. SoCC '17. Santa Clara, California: Association for Computing Machinery, Sep. 2017, pp. 405–418. [Online]. Available: <https://doi.org/10.1145/3127479.3129249>
- [27] S. Ma, J. Zhai, F. Wang, K. H. Lee, X. Zhang, and D. Xu, "MPI: Multiple Perspective Attack Investigation with Semantic Aware Execution Partitioning," in *26th USENIX Security Symposium (USENIX Security 17)*. Vancouver, BC: USENIX Association, 2017, pp. 1111–1128. [Online]. Available: <https://www.usenix.org/conference/usenixsecurity17/technical-sessions/presentation/ma>
- [28] K. H. Lee, X. Zhang, and D. Xu, "High Accuracy Attack Provenance via Binary-based Execution Partitioning," p. 16.
- [29] R. Yang, S. Ma, H. Xu, X. Zhang, and Y. Chen, "Uiscope: Accurate, instrumentation-free, and visible attack investigation for gui applications."
- [30] S. Ma, X. Zhang, and D. Xu, "ProTracer: Towards Practical Provenance Tracing by Alternating Between Logging and Tainting." Internet Society, 2016. [Online]. Available: <https://www.ndss-symposium.org/wp-content/uploads/sites/25/2017/09/protracer-towards-practical-provenance-tracing-alternating-logging-tainting.pdf>
- [31] Y. Kwon, D. Kim, W. N. Sumner, K. Kim, B. Saltaformaggio, X. Zhang, and D. Xu, "LDX: Causality Inference by Lightweight Dual Execution," in *Proceedings of the Twenty-First International Conference on Architectural Support for Programming Languages and Operating Systems*, ser. ASPLOS '16. New York, NY, USA: ACM, 2016, pp. 503–515. [Online]. Available: <http://doi.acm.org/10.1145/2872362.2872395>
- [32] Y. Kwon, F. Wang, W. Wang, K. H. Lee, W.-C. Lee, S. Ma, X. Zhang, D. Xu, S. Jha, G. Ciocarlie, A. Gehani, and V. Yegneswaran, "MCI : Modeling-based Causality Inference in Audit Logging for Attack Investigation." Internet Society, 2018. [Online]. Available: https://www.ndss-symposium.org/wp-content/uploads/sites/25/2018/02/ndss2018_07B-2_Kwon_paper.pdf
- [33] W. U. Hassan, M. Lemay, N. Aguse, A. Bates, and T. Moyer, "Towards Scalable Cluster Auditing through Grammatical Inference over Provenance Graphs," in *Proceedings 2018 Network and Distributed System Security Symposium*. San Diego, CA: Internet Society, 2018. [Online]. Available: https://www.ndss-symposium.org/wp-content/uploads/2018/02/ndss2018_07B-1_Hassan_paper.pdf
- [34] Y. Ji, S. Lee, E. Downing, W. Wang, M. Fazzini, T. Kim, A. Orso, and W. Lee, "RAIN: Refinable Attack Investigation with On-demand Inter-Process Information Flow Tracking," in *Proceedings of the 2017 ACM SIGSAC Conference on Computer and Communications Security - CCS '17*. Dallas, Texas, USA: ACM Press, 2017, pp. 377–390. [Online]. Available: <http://dl.acm.org/citation.cfm?doid=3133956.3134045>
- [35] V. P. Kemerlis, G. Portokalidis, K. Jee, and A. D. Keromytis, "Libdft: Practical Dynamic Data Flow Tracking for Commodity Systems," in *Proceedings of the 8th ACM SIGPLAN/SIGOPS Conference on Virtual Execution Environments*, ser. VEE '12. New York, NY, USA: ACM, 2012, pp. 121–132. [Online]. Available: <http://doi.acm.org/10.1145/2151024.2151042>
- [36] Y. Ji, S. Lee, M. Fazzini, J. Allen, E. Downing, T. Kim, A. Orso, and W. Lee, "Enabling refinable cross-host attack investigation with efficient data flow tagging and tracking," in *27th USENIX Security Symposium (USENIX Security 18)*. Baltimore, MD: USENIX Association, Aug. 2018, pp. 1705–1722. [Online]. Available: <https://www.usenix.org/conference/usenixsecurity18/presentation/jia-yang>
- [37] W. U. Hassan, M. A. Noureddine, P. Datta, and A. Bates, "OmegaLog: High-Fidelity Attack Investigation via Transparent Multi-layer Log Analysis," p. 16.
- [38] "Linux fuse," 2020. [Online]. Available: <https://github.com/libfuse/libfuse>
- [39] C. Schaufler, "Lsm: Stacking for major security modules," 2016. [Online]. Available: <https://lwn.net/Articles/697259/>
- [40] "Netfilter," 2020. [Online]. Available: <https://www.netfilter.org/>
- [41] "Osfuse," 2020. [Online]. Available: <https://osxfuse.github.io/>
- [42] "W3c prov-dm," 2020. [Online]. Available: <https://dvcs.w3.org/hg/prov/raw-file/default/model/working-copy/prov-dm-issue-450.html>
- [43] J. Clause, W. Li, and A. Orso, "Dytan: a generic dynamic taint analysis framework," in *Proceedings of the 2007 international symposium on Software testing and analysis*, 2007, pp. 196–206.
- [44] W. Enck, P. Gilbert, S. Han, V. Tendulkar, B.-G. Chun, L. P. Cox, J. Jung, P. McDaniel, and A. N. Sheth, "Taintdroid: an information-flow tracking system for realtime privacy monitoring on smartphones," *ACM Transactions on Computer Systems (TOCS)*, vol. 32, no. 2, pp. 1–29, 2014.
- [45] W. Xu, S. Bhatkar, and R. Sekar, "Taint-enhanced policy enforcement: A practical approach to defeat a wide range of attacks," in *USENIX Security Symposium*, 2006, pp. 121–136.
- [46] "Graph database," 2020. [Online]. Available: https://en.wikipedia.org/wiki/Graph_database
- [47] X. Han, T. Pasquier, A. Bates, J. Mickens, and M. Seltzer, "UNICORN: Runtime Provenance-Based Detector for Advanced Persistent Threats," in *arXiv preprint arXiv:2001.01525*, 2020.
- [48] M. N. Hossain, J. Wang, R. Sekar, and S. D. Stoller, "Dependence-preserving data compaction for scalable forensic analysis," 2018, pp. 1723–1740.
- [49] "Provenance-aware versioned dataworkspaces," in *8th USENIX Workshop on the Theory and Practice of Provenance (TaPP 16)*. USENIX Association. [Online]. Available: <https://www.usenix.org/conference/tapp16/workshop-program/presentation/niu>
- [50] A. Chavan, S. Huang, A. Deshpande, A. Elmoro, S. Madden, and A. Parameswaran, "Towards a unified query language for provenance and versioning," in *7th USENIX Workshop on the Theory and Practice of Provenance (TaPP 15)*. USENIX Association. [Online]. Available: <https://www.usenix.org/conference/tapp15/workshop-program/presentation/chavan>
- [51] A. P. Chapman, H. V. Jagadish, and P. Ramanan, "Efficient provenance storage," in *Proceedings of the 2008 ACM SIGMOD international conference on Management of data*, 2008, pp. 993–1006.
- [52] Y. Xie, D. Feng, Z. Tan, L. Chen, K.-K. Muniswamy-Reddy, Y. Li, and D. D. Long, "A hybrid approach for efficient provenance storage," in *Proceedings of the 21st ACM international conference on Information and knowledge management*, 2012, pp. 1752–1756.
- [53] K. H. Lee, X. Zhang, and D. Xu, "LogGC: Garbage Collecting Audit Log," in *Proceedings of the 2013 ACM SIGSAC Conference on Computer & Communications Security*, ser. CCS '13. New York, NY, USA: ACM, 2013, pp. 1005–1016. [Online]. Available: <http://doi.acm.org/10.1145/2508859.2516731>
- [54] Y. Tang, Q. Li, D. Li, Z. Li, M. Zhang, K. Jee, X. Xiao, Z. Wu, J. Rhee, and F. Xu, "NodeMerge: Template Based Efficient Data Reduction For Big-Data Causality Analysis," in *Proceedings of the 2018 ACM SIGSAC Conference on Computer and Communications Security - CCS '18*. Toronto, Canada: ACM Press, 2018, pp. 1324–1337. [Online]. Available: <http://dl.acm.org/citation.cfm?doid=3243734.3243763>
- [55] P. Gao, X. Xiao, Z. Li, K. Jee, F. Xu, S. R. Kulkarni, and P. Mittal, "AIQL: Enabling Efficient Attack Investigation from System Monitoring Data," in *arXiv:1806.02290 [cs]*, Jun. 2018, arXiv: 1806.02290. [Online]. Available: <http://arxiv.org/abs/1806.02290>
- [56] P. Gao, X. Xiao, D. Li, Z. Li, K. Jee, Z. Wu, C. H. Kim, S. R. Kulkarni, and P. Mittal, "SAQL: A Stream-based Query System for Real-Time Abnormal System Behavior Detection," in *27th USENIX Security Symposium (USENIX Security 18)*. Baltimore, MD:

- USENIX Association, 2018, pp. 639–656. [Online]. Available: <https://www.usenix.org/conference/usenixsecurity18/presentation/gao-peng>
- [57] X. Shu, F. Araujo, D. L. Schales, M. P. Stoecklin, J. Jang, H. Huang, and J. R. Rao, “Threat Intelligence Computing,” in *Proceedings of the 2018 ACM SIGSAC Conference on Computer and Communications Security*, ser. CCS ’18. New York, NY, USA: ACM, 2018, pp. 1883–1898. [Online]. Available: <http://doi.acm.org/10.1145/3243734.3243829>
- [58] T. Pasquier, X. Han, T. Moyer, A. Bates, O. Hermant, D. Eyers, J. Bacon, and M. Seltzer, “Runtime Analysis of Whole-System Provenance,” in *Proceedings of the 2018 ACM SIGSAC Conference on Computer and Communications Security - CCS ’18*. Toronto, Canada: ACM Press, 2018, pp. 1601–1616. [Online]. Available: <http://dl.acm.org/citation.cfm?doid=3243734.3243776>
- [59] S. T. King and P. M. Chen, “Backtracking Intrusions,” in *Proceedings of the Nineteenth ACM Symposium on Operating Systems Principles*, ser. SOSP ’03. New York, NY, USA: ACM, 2003, pp. 223–236. [Online]. Available: <http://doi.acm.org/10.1145/945445.945467>
- [60] “Siddhi complex event processing engine,” 2020. [Online]. Available: <https://github.com/wso2/siddhi>
- [61] K. Pei, Z. Gu, B. Saltaformaggio, S. Ma, F. Wang, Z. Zhang, L. Si, X. Zhang, and D. Xu, “HERCULE: Attack Story Reconstruction via Community Discovery on Correlated Log Graph,” in *Proceedings of the 32Nd Annual Conference on Computer Security Applications*, ser. ACSAC ’16. New York, NY, USA: ACM, 2016, pp. 583–595. [Online]. Available: <http://doi.acm.org/10.1145/2991079.2991122>
- [62] F. Liu, Y. Wen, D. Zhang, X. Jiang, X. Xing, and D. Meng, “Log2Vec: A Heterogeneous Graph Embedding Based Approach for Detecting Cyber Threats Within Enterprise,” in *Proceedings of the 2019 ACM SIGSAC Conference on Computer and Communications Security*, ser. CCS ’19. New York, NY, USA: ACM, 2019, pp. 1777–1794, event-place: London, United Kingdom. [Online]. Available: <http://doi.acm.org/10.1145/3319535.3363224>
- [63] Q. Wang, W. U. Hassan, D. Li, K. Jee, X. Yu, K. Zou, J. Rhee, Z. Chen, W. Cheng, C. A. Gunter, and H. Chen, “You Are What You Do: Hunting Stealthy Malware via Data Provenance Analysis,” p. 17.
- [64] Y. Liu, M. Zhang, D. Li, K. Jee, Z. Li, Z. Wu, J. Rhee, and P. Mittal, “Towards a Timely Causality Analysis for Enterprise Security.” Internet Society, 2018. [Online]. Available: https://www.ndss-symposium.org/wp-content/uploads/sites/25/2018/02/ndss2018_07B-3_Liu_paper.pdf
- [65] X. Jiang, A. Walters, D. Xu, E. H. Spafford, F. Buchholz, and Y.-M. Wang, “Provenance-Aware Tracing of Worm Break-in and Contaminations: A Process Coloring Approach,” in *26th IEEE International Conference on Distributed Computing Systems (ICDCS’06)*, Jul. 2006, pp. 38–38.
- [66] M. N. Hossain, S. Sheikhi, and R. Sekar, “Combating dependence explosion in forensic analysis using alternative tag propagation semantics,” in *IEEE S&P 2020*.
- [67] “Mitre att&ck metrics,” 2020. [Online]. Available: <https://attack.mitre.org/>
- [68] L. De Nardo, F. Ranzato, and F. Tapparo, “The subgraph similarity problem,” *IEEE Transactions on Knowledge and Data Engineering*, vol. 21, no. 5, pp. 748–749, 2008.
- [69] S. Yan, D. Xu, B. Zhang, H.-J. Zhang, Q. Yang, and S. Lin, “Graph embedding and extensions: A general framework for dimensionality reduction,” *IEEE transactions on pattern analysis and machine intelligence*, vol. 29, no. 1, pp. 40–51, 2006.
- [70] Z. Wang, J. Zhang, J. Feng, and Z. Chen, “Knowledge graph embedding by translating on hyperplanes,” in *Twenty-Eighth AAAI conference on artificial intelligence*, 2014.
- [71] P. Goyal and E. Ferrara, “Graph embedding techniques, applications, and performance: A survey,” *Knowledge-Based Systems*, vol. 151, pp. 78–94, 2018.
- [72] Y. Wang and Q. Yao, “Few-shot learning: A survey,” *arXiv preprint arXiv:1904.05046*, 2019.
- [73] W. Wang, V. W. Zheng, H. Yu, and C. Miao, “A survey of zero-shot learning: Settings, methods, and applications,” *ACM Transactions on Intelligent Systems and Technology (TIST)*, vol. 10, no. 2, pp. 1–37, 2019.