

Fillings of skew shapes avoiding diagonal patterns*

Vít Jelínek Mark Karpilovskij

Abstract

A skew shape is the difference of two top-left justified Ferrers shapes sharing the same top-left corner. We study integer fillings of skew shapes. As our first main result, we show that for a specific hereditary class of skew shapes, which we call D-free shapes, the fillings that avoid a north-east chain of size k are in bijection with fillings that avoid a south-east chain of the same size. Since Ferrers shapes are a subclass of D-free shapes, this result can be seen as a generalization of previous analogous results for Ferrers shapes.

As our second main result, we construct a bijection between 01-fillings of an arbitrary skew shape that avoid a south-east chain of size 2, and the 01-fillings of the same shape that simultaneously avoid a north-east chain of size 2 and a particular non-square subfilling. This generalizes a previous result for transversal fillings.

1 Introduction

Wilf equivalence, and the closely related notion of Wilf order, are undoubtedly among the key notions in the study of combinatorics of permutations. Despite considerable amount of research, many key questions related to these concepts remain open.

One of the most successful approaches in the study of Wilf equivalence is based on the concept of pattern avoidance in fillings of specific shapes. Of particular interest are the so-called transversal fillings, which contain exactly one 1-cell in each row and each column, and can be viewed as generalizations of permutation matrices. Transversal fillings of Ferrers shapes have played a crucial part in establishing most of the known results on Wilf equivalence [1, 16], as well as in the study of many related combinatorial objects, such as involutions [2], words [7], matchings [9, 12], graphs [5, 6] or set partitions [4, 11].

Most of the research into pattern-avoiding fillings focuses on the avoidance of diagonal patterns. We let δ_k and ι_k denote the decreasing and increasing diagonal pattern of size k , respectively. Backelin, West and Xin [1] have shown that the number of transversal fillings of a Ferrers shape that avoid δ_k is the same as the number of such fillings that avoid ι_k . This was later generalized to non-transversal fillings [13], and to more general shapes, such as stack polyominoes [8], moon polyominoes [15], or almost-moon polyominoes [14].

In this paper, we consider yet another family of shapes, namely the so-called skew shapes, which can be seen as a difference of two Ferrers shapes, or equivalently, as a shape whose

*Supported by project 18-19158S of the Czech Science Foundation and by GAUK project 1766318

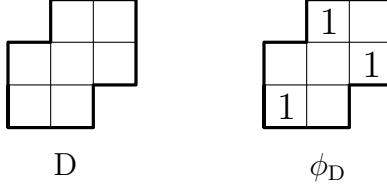

Figure 1: The shape D (left) and its filling ϕ_D (right).

boundary is a union of two nondecreasing lattice paths with common endpoints. Our interest in skew shapes is motivated by the following conjecture.

Conjecture 1.1 (Skew shape conjecture). *For any skew shape S and any number k , the number of transversal fillings of S that avoid ι_k is greater than or equal to the number of such fillings that avoid δ_k .*

Verifying the skew shape conjecture for any particular value of k would imply that for any two permutations α and β , the pattern $\alpha \ominus \delta_k \ominus \beta$ is more Wilf-restrictive than $\alpha \ominus \iota_k \ominus \beta$, where \ominus denotes the skew-sum of permutations (see, e.g., Vatter’s survey [17] for permutation-related terminology). However, the conjecture has so far only been verified for $k \leq 2$ [3, 10].

In this paper, we prove two new results on diagonal avoiding fillings of skew shapes, both of which indirectly support the skew shape conjecture. As our first main result, we will show that the conjecture holds for skew shapes that avoid the shape D from Figure 1 as subshape. In fact, we will show that for D -avoiding skew shapes the conjecture holds with equality, via a bijection that extends to general integer fillings. Since a Ferrers shape is a special case of a D -avoiding skew shape, this result can be seen as another generalization of the result of Backelin et al. [1] on transversals of Ferrers shapes and its generalization by Krattenthaler [13] to non-transversal fillings.

As our second main result, we show that for any skew shape S , the number of 01-fillings of S avoiding the pattern δ_2 is the same as the number of 01-fillings of S that avoid both ι_2 and the pattern ϕ_D from Figure 1. This has been previously known for transversal fillings, where the proof follows from the fact that each skew shape that admit at least one transversal filling admits exactly one δ_2 -avoiding filling and exactly one $\{\iota_2, \phi_D\}$ -avoiding filling. To extend the result to general, i.e. non-transversal, fillings, we devise a new bijective argument.

2 Preliminaries

Shapes. A *cell* is a unit square whose vertices are points of the \mathbb{Z}^2 integer grid, and a *shape* is the union of finitely many cells. The *coordinates* of a cell are the Cartesian coordinates of its top-right corner. If two shapes differ only by a translation in the plane, we shall treat them as identical. We will henceforth assume that in each nonempty shape we consider, the leftmost cell has horizontal coordinate equal to 1, and the bottommost cell has vertical coordinate equal to 1, unless explicitly stated otherwise. We use the term *cell* (i, j) for the cell in column i and row j . The *height* of a shape is the vertical coordinate of its topmost cell, and its *width* is the horizontal coordinate of its rightmost cell. We say that a cell (i, j) is *strictly to the left* of a cell (i', j') if $i < i'$, and we say that it is *weakly to the left* if $i \leq i'$.

Two cells are *adjacent* if their boundaries share an edge. For a shape S , the transitive closure of the adjacency relation on the cells of S yields an equivalence, whose blocks are the *connected components* of S . If S has a single component, we say that it is *connected*. Connected shapes are known as *polyominoes*.

A shape is *convex* if for any two of its cells in the same row or column it also contains every cell in between. Two columns of a shape are *comparable* if the set of row coordinates of one column is contained in the set of row coordinates of the other; comparable rows are defined analogously. We say that a shape is *intersection-free* if any two of its columns are comparable. Note that this is equivalent to having any two of its rows comparable. Convex, intersection-free shapes are known as *moon polyominoes* (see Figure 2).

A shape is *top-justified* if the top ends of all of its columns are in the same row and it is *left-justified* if the left ends of all of its rows are in the same column. *Bottom-justified* and *right-justified* shapes are defined analogously. A shape is *top-left justified* if it is both top-justified and left-justified, and similarly for other combinations of horizontal and vertical directions.

A *northwest Ferrers shape*, or *NW Ferrers shape* for short, is a top-left justified moon polyomino, and similarly, a *SE Ferrers shape* is a bottom-right justified moon polyomino; see Figure 3.

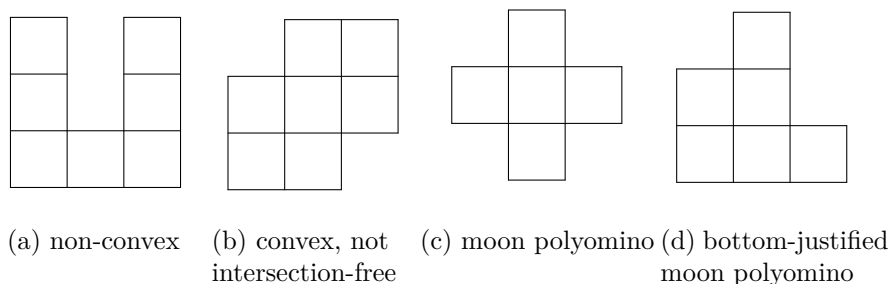

Figure 2: Examples of shapes

A *skew shape* is a shape S that can be obtained by taking two NW Ferrers shapes F_1 and F_2 with a common top-left cell and putting $S = F_1 \setminus F_2$, i.e., S is the union of those cells of F_1 that do not belong to F_2 .

Fillings of shapes. A *filling* of a shape S is a function ϕ that assigns a nonnegative integer to every cell of S . We write $\phi(i, j)$ for the value assigned by ϕ to a cell (i, j) . A *binary filling* (also known as *01-filling*) is a filling that only uses the values 0 and 1. A cell that has been assigned the value 0 (or 1) by a binary filling ϕ is referred to as a *0-cell* (or *1-cell*, respectively) of ϕ . If a row or column only contains 0-cells in a filling ϕ , we say that it is *empty* in ϕ .

A binary filling ϕ of a shape S is *sparse* if every row and every column of S has at most one 1-cell. A binary filling ϕ is a *transversal filling* (or just a *transversal*) if every row and every column of S has exactly one 1-cell.

In figures, we will often represent 0-cells by empty boxes and 1-cells by boxes with crosses; see Figure 5 for examples.

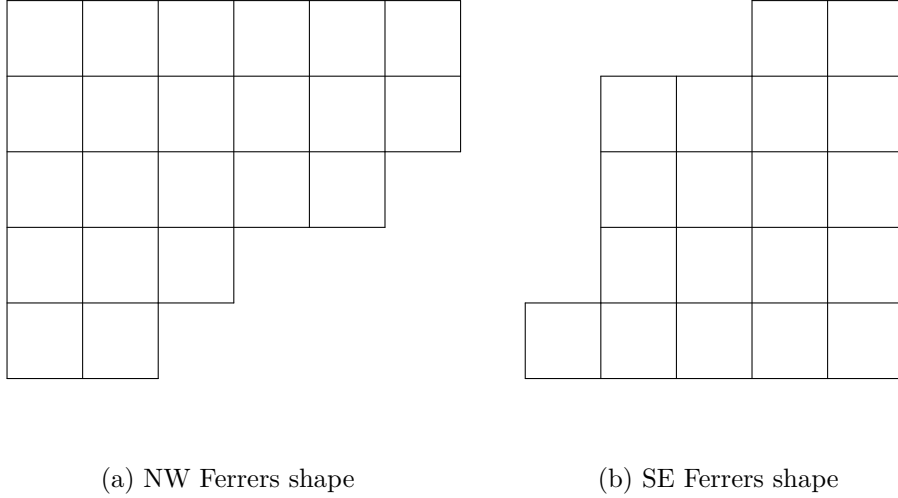

Figure 3: Examples of Ferrers shapes

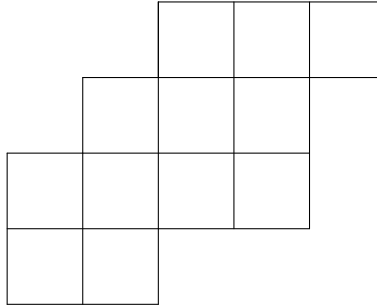

Figure 4: A skew shape

Containment of shapes and fillings. Let S be a shape of height h and width w , and let T be a shape of height k and width ℓ . We say that S *contains* T , or that T is a *subshape* of S , if there is a sequence of row indices $1 \leq r_1 < r_2 < \dots < r_k \leq h$ and column indices $1 \leq c_1 < c_2 < \dots < c_\ell \leq w$, such that for every i and j , the cell (i, j) is contained in T if and only if the cell (c_i, r_j) is in S . The rows (r_1, \dots, r_k) and columns (c_1, \dots, c_ℓ) together form an *occurrence* of T in S . If S does not contain T , we say that S *avoids* T .

With S and T as above, if ϕ_S is a filling of S and ϕ_T a filling of T , we say that ϕ_S *contains* ϕ_T , or that ϕ_T is a *subfilling* of ϕ_S , if there is an occurrence of T in S in rows (r_1, \dots, r_k) and columns (c_1, \dots, c_ℓ) with the additional property that for every cell (i, j) of T , we have $\phi_T(i, j) \leq \phi_S(c_i, r_j)$. We again say that the rows (r_1, \dots, r_k) and columns (c_1, \dots, c_ℓ) form an *occurrence* of ϕ_T in ϕ_S . In the case when ϕ_T is binary, the condition $\phi_T(i, j) \leq \phi_S(c_i, r_j)$ simply says that each 1-cell of ϕ_T must get mapped to a nonzero cell of ϕ_S by the occurrence.

Note that any subshape of a moon polyomino is again a moon polyomino, any subshape of a skew shape is a skew shape, and any subshape of a Ferrers shape is a Ferrers shape.

Let S_n be the square shape of size $n \times n$, i.e., the shape consisting of the cells (i, j) with

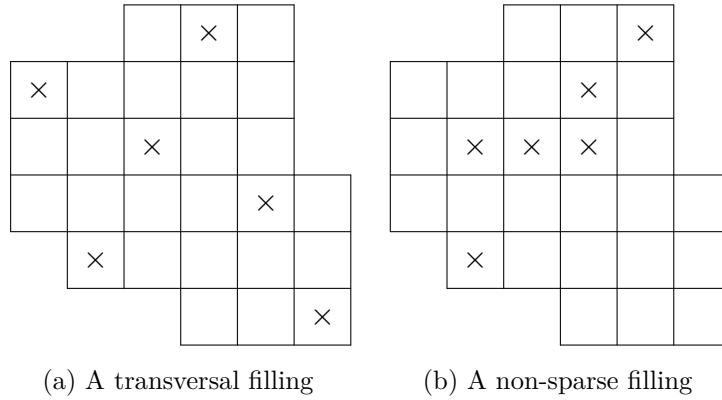

Figure 5: Examples of binary fillings

$1 \leq i \leq n$ and $1 \leq j \leq n$. The transversal fillings of S_n correspond in a natural way to permutations of order n : let $\pi = \pi_1\pi_2 \cdots \pi_n$ be a permutation of order n , represented by a sequence of numbers in which every value from 1 to n appears exactly once. We represent π by a transversal filling of S_n whose 1-cells are the cells (i, π_i) for $i = 1, \dots, n$. Such a transversal filling is usually called the *permutation diagram* of π . In this paper, we shall make no explicit distinction between a permutation and its diagram, and if there is no risk of ambiguity, we will use the term permutation to refer both to the sequence of integers and to the diagram. Note that the containment relation defined above for binary fillings is a generalization of the classical Wilf containment of permutations.

In this paper, we shall be mostly working with two types of forbidden patterns, corresponding to increasing and decreasing permutations, respectively. For any $k \geq 1$ let ι_k denote the diagram of the increasing permutation $1, 2, 3, \dots, k$; in other words, ι_k is the filling of the $k \times k$ square shape with 1-cells (i, i) for $1 \leq i \leq k$. Symmetrically, let δ_k be the diagram of the decreasing permutation $k, k-1, \dots, 1$. An occurrence of ι_k in a filling ϕ is also referred to as a *NE-chain of length k* in ϕ , while an occurrence of δ_k is a *SE-chain of length k* . See Figure 6 for examples.

Results. Our first main result deals with transversal fillings of skew shapes of a special type. Let D be the skew shape in Figure 1 (D stands for ‘dented shape’). We say that a skew shape S is *D-free* if S avoids D .

Let $\text{Tr}(S, \pi)$ be the number of transversal fillings of the shape S that avoid the filling π . Backelin et al. [1] have shown that for any k and any Ferrers shape F , we have the identity $\text{Tr}(F, \delta_k) = \text{Tr}(F, \iota_k)$. This was later generalized by Krattenthaler [13] to general fillings of Ferrers shapes. Our first main result generalizes this identity to a broader class of shapes, namely to D -free skew shapes.

Theorem 2.1. *For any D -free skew shape S , there is a bijection transforming a filling ϕ of S to a filling ϕ' of S with these properties.*

- For any $k \geq 1$, ϕ avoids δ_k if and only if ϕ' avoids ι_k .

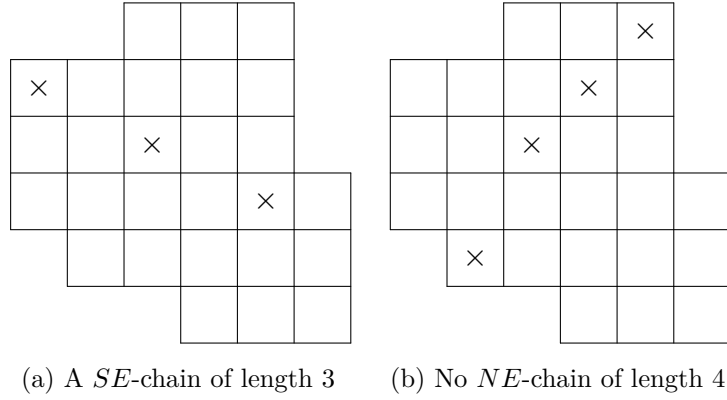

Figure 6: Examples of chains in a shape with a binary filling. Left figure: an example of a SE chain of length 3. Right figure: a filling with no NE chain of length 4, which contains two occurrence of a NE chain of size 3.

- *There is a permutation ρ of row-indices of S and a permutation σ of column-indices of S such that for any i , the entries in the i -th row of ϕ have the same sum as the entries in the ρ_i -th row of ϕ' , and the entries in the i -th column of ϕ have the same sum as the entries in the σ_i -th row of ϕ' .*

The proof of this result is presented in Section 3. A direct consequence of the theorem is the following identity for transversals.

Corollary 2.2. *For any D-free skew shape S and any $k \geq 1$, we have $\text{Tr}(S, \delta_k) = \text{Tr}(S, \iota_k)$.*

Theorem 2.1 cannot in general be extended to non-D-free skew shapes. In fact, for the shape D itself, we easily verify that $\text{Tr}(D, \iota_2) = 2$ and $\text{Tr}(D, \delta_2) = 1$. However, computational evidence suggests the following conjecture.

Conjecture 2.3. [*Skew shape conjecture*] *For any skew shape S and any $k \geq 1$, we have $\text{Tr}(S, \iota_k) \geq \text{Tr}(S, \delta_k)$.*

The conjecture is trivial for $k = 1$ and is known to be true for $k = 2$. Indeed, for the case $k = 2$, a more precise result is known, proven by Jelínek [10, Lemmas 29 and 30] and independently by Burstein and Pantone [3, Lemmas 1.4 and 1.5].

Theorem 2.4 ([10, 3]). *For any skew shape S that admits at least one transversal, there is exactly one transversal of S that avoids δ_2 , and exactly one transversal of S that simultaneously avoids both ι_2 and the filling ϕ_D from Figure 1.*

Note that this theorem implies not only the case $k = 2$ of the skew shape conjecture, but also the case $k = 2$ of Corollary 2.2.

As our second main result, we will extend Theorem 2.4 to an identity for general (i.e., not necessarily transversal) binary fillings.

Theorem 2.5. *For any skew shape S , the number of binary fillings of S that avoid δ_2 is the same as the number of binary fillings of S that avoid both ι_2 and ϕ_D . Moreover, this identity is witnessed by a bijection that preserves the number of 1-cells in every row.*

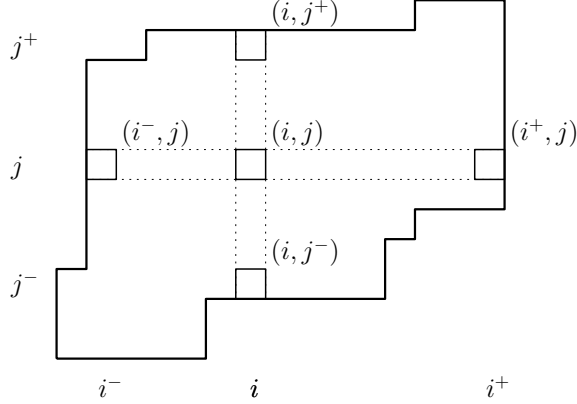

Figure 7: Finding an occurrence of D in a skew shape

The proof of this result appears in Section 4. We note that the approach used to prove Theorem 2.4 does not seem to be applicable to non-transversal fillings. Instead, our proof of Theorem 2.5 is based on a new bijective argument.

3 Proof of Theorem 2.1

3.1 The structure of D-free skew shapes

An important feature of D-free skew shapes is that they admit a natural decomposition into a concatenation of Ferrers diagrams. Before describing this decomposition properly, we need some preparation.

Let S be a shape, and let (i, j) be a cell of S . We let $S[\leq i, \leq j]$ denote the subshape of S formed by those cells (i', j') of S that satisfy $i' \leq i$ and $j' \leq j$. We also use the analogous notations $S[\geq i, \leq j]$, $S[\leq i, \geq j]$, $S[\geq i, \geq j]$, with obvious meanings.

Lemma 3.1. *A skew shape S is D-free if and only if for every cell (i, j) of S at least one of the two subshapes $S[\leq i, \geq j]$ and $S[\geq i, \leq j]$ is a rectangle.*

Proof. Suppose that a skew shape S has an occurrence of D in columns (i_1, i_2, i_3) and rows (j_1, j_2, j_3) . Then $S[\leq i_2, \geq j_2]$ is not a rectangle, since it contains the two cells (i_1, j_2) and (i_2, j_3) but does not contain (i_1, j_3) , which is not a cell of S . Symmetrically, $S[\geq i_2, \leq j_2]$ is not a rectangle either, and the right-hand side of the equivalence in the statement of the lemma fails for $i = i_2$ and $j = j_2$.

Conversely, suppose that S contains a cell (i, j) such that neither $S[\leq i, \geq j]$ nor $S[\geq i, \leq j]$ is a rectangle; see Figure 7. Fix row indices j^- and j^+ so that (i, j^-) is the bottommost cell of S in column i , and (i, j^+) is the topmost cell of S in column i . Note that $j^- < j < j^+$: if we had, e.g., $j^- = j$, then $S[\geq i, \leq j]$ would consist of a single row, and therefore it would be a rectangle. Fix column indices i^- and i^+ so that (i^-, j) and (i^+, j) are the leftmost and rightmost cell of S in row j . Again, we see that $i^- < i < i^+$.

Note that neither (i^-, j^+) nor (i^+, j^-) is a cell of S : if, e.g., S contained the cell (i^-, j^+) , then $S[\leq i, \geq j]$ would be a rectangle. On the other hand, since S is a skew shape, it must

contain both (i^-, j^-) and (i^+, j^+) . It follows that the columns (i^-, i, i^+) and rows (j^-, j, j^+) induce an occurrence of D in S . \square

Let S be a connected skew shape, and let a vertical line leading between two adjacent columns of S divide it into two skew shapes S_1 and S_2 , where the leftmost column of S_2 is directly to the right of the rightmost column of S_1 , and the bottommost row of S_2 is at least as high as the bottommost cell of the rightmost column of S_1 . Then we say that S is a *vertical concatenation* of S_1 and S_2 and we write $S = S_1|^v S_2$. Similarly, we define *horizontal concatenation* and write $T = T_1|^h T_2$.

We say that a skew shape S is *Ferrers-decomposable* if it can be written as

$$S = F_1|^v G_1|^h F_2|^v \cdots |^h F_n|^v G_n,$$

with the following properties (see Figure 8):

- (a) All F_i are *NW* Ferrers shapes, and all G_i are *SE* Ferrers shapes.
- (b) All F_i and G_i are nonempty with the possible exception of G_n .
- (c) For $i < n$, if the dividing line between F_i and G_i is between columns c_i and $c_i + 1$, then the topmost cell of S in column c_i is below the topmost cell of S in column $c_i + 1$. Similarly, if the dividing line between G_i and F_{i+1} is between rows r_i and $r_i + 1$, then the rightmost cell of S in row r_i is to the left of the rightmost cell of S in row $r_i + 1$.
- (d) For $i < n$, G_i is to the left of the vertical line separating F_{i+1} from G_{i+1} , and F_i is below the horizontal line separating G_i from F_{i+1} .

We call this representation of S the *Ferrers decomposition* of S .

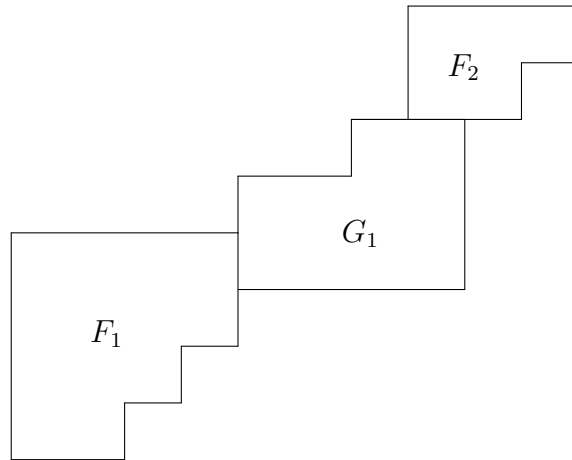

Figure 8: A D-free skew skew shape, with its Ferrers decomposition

Lemma 3.2. *A connected skew shape is D-free if and only if it is Ferrers-decomposable.*

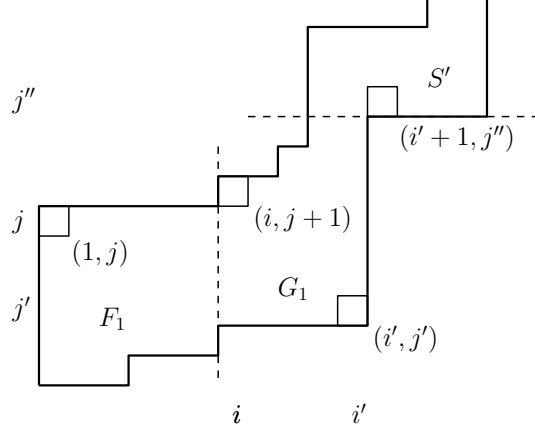

Figure 9: Decomposing a D-free skew shape into Ferrers diagrams

Proof. In a Ferrers-decomposable skew shape S , every cell is in either a *NW* Ferrers subshape or a *SE* Ferrers subshape and thus satisfies the condition of Lemma 3.1. Therefore S is D-free.

To prove the converse, let S be a connected D-free skew shape; see Figure 9. We proceed by induction over the number of cells of S , noting that the statement is trivial if S has a single cell. Let $(1, j)$ be the topmost cell in the first column of S . If j is the topmost row of S , then S is a NW Ferrers shape, and it admits the trivial Ferrers decomposition $S = F_1$.

Suppose that j is not the topmost row of S . Since S is connected, it contains a cell in row $j + 1$, and let $(i, j + 1)$ be the leftmost such cell. We define F_1 to be the subshape of S formed by the cells in the first $i - 1$ columns. Clearly, F_1 is a nonempty NW Ferrers shape. Since S is connected, the cell (i, j) is in S . Applying Lemma 3.1 to this cell, we conclude that $S[\geq i, \leq j]$ is a rectangle – note that $S[\leq i, \geq j]$ cannot be a rectangle, since S contains the cells $(i - 1, j)$ and $(i, j + 1)$ but not $(i - 1, j + 1)$.

Let (i', j') be the bottom-right cell of the rectangle $S[\geq i, \leq j]$. If i' is the rightmost column of S , then $S \setminus F_1$ is a SE Ferrers shape G_1 , and we have a Ferrers decomposition $S = F_1 |^v G_2$. Suppose that i' is not the rightmost column, and let $(i' + 1, j'')$ be the bottommost cell of S in column $i' + 1$. Note that $j'' > j$, otherwise $S[\geq i, \leq j]$ would not be a rectangle. We then let G_1 be the subshape of S formed by the cells in columns $i, i + 1, \dots, i'$ and rows $j', \dots, j'' - 1$. G_1 is then a SE Ferrers shape, and S can be written as $S = F_1 |^v G_1 |^h S'$, where S' is a connected D-free skew shape.

By induction, S' admits a Ferrers decomposition $S' = F_2 |^v G_2 |^h \dots |^v G_n$. We claim that $F_1 |^v G_1 |^h F_2 |^v G_2 |^h \dots |^v G_n$ is a Ferrers-decomposition of S . Clearly, it satisfies conditions (a), (b) and (c) in the definition of Ferrers-decomposition. To verify condition (d), we only need to argue that the dividing line between F_2 and G_2 is to the right of G_1 . To see this, we note that by Lemma 3.1, $S[\leq i', \geq j'']$ is a rectangle, and in particular, the topmost cells in the columns intersecting this rectangle are all in the same row. Thus, by condition (c) of Ferrers-decomposition, this rectangle cannot be separated by a vertical dividing line, and in particular the line separating F_2 from G_2 is to the right of G_1 . \square

3.2 Rubey's bijection

Rubey [15] has proved several general bijective results about fillings of moon polyominoes. Here we formulate a part of his results which will be useful in our argument.

Given a finite sequence $s = (s_1, s_2, \dots, s_n)$ and a permutation σ of length n , we let σs be the sequence $(s_{\sigma(1)}, s_{\sigma(2)}, \dots, s_{\sigma(n)})$. In addition, given a moon polyomino M of width w and a permutation π of length w , we denote by σM the shape created by permuting the columns of M according to π . A *maximal rectangle* in a moon polyomino M is a rectangle $R \subseteq M$ which is not a proper subset of any other rectangle contained in M . Note that a moon polyomino contains a maximal rectangle of width w if and only if it has a row with exactly w cells, and this maximal rectangle is then unique. The analogous property holds for columns as well. In fact, if M and M' are moon polyominoes such that M is obtained from M' by permuting its columns, then there is a size-preserving correspondence between the maximal rectangles of M and the maximal rectangles of M' ; see Rubey [15].

Definition 3.3. Let M be a moon polyomino of height h and width w , let \mathbf{r} and \mathbf{c} be sequences of integers of lengths h and w respectively, and let Λ be a mapping which assigns to every maximal rectangle R in M a nonnegative integer $\Lambda(R)$. Then $\mathcal{F}^{NE}(M, \Lambda, \mathbf{r}, \mathbf{c})$ is the set of all integer fillings of M such that

- the sum of the entries in the j -th row of M is equal to r_j ,
- the sum of the entries in the i -th column of M is equal to c_i , and
- for every maximal rectangle R of M , the length of the longest NE -chain in the filling of R is equal to $\Lambda(R)$.

The following theorem is a special case of a result of Rubey [15, Theorem 5.3].

Theorem 3.4 (Rubey [15]). *Let M be a moon polyomino of height h and width w , and let σ be a permutation of its columns such that σM is again a moon polyomino. Let Λ be a function assigning nonnegative integers to maximal rectangles of M , let \mathbf{r} and \mathbf{c} be nonnegative integer vectors of length h and w , respectively. Then the two sets $\mathcal{F}^{NE}(M, \Lambda, \mathbf{r}, \mathbf{c})$ and $\mathcal{F}^{NE}(\sigma M, \Lambda, \mathbf{r}, \sigma \mathbf{c})$ have the same size, and there is an explicit bijection between them.*

3.3 A bijection on Ferrers fillings

Using Rubey's bijection as our main tool, we will now state and prove a technical result on fillings of Ferrers shapes satisfying certain restrictions.

Let F be a NW Ferrers shape, let k and ℓ be integers. Suppose that the leftmost k columns of F all have the same length, and the topmost ℓ rows of F have the same length. We will call the leftmost k columns of F *special columns* and the topmost ℓ rows *special rows* of F . For any $i \leq k$, let C_i denote the rectangle formed by the i leftmost special columns of F (i.e., columns $1, \dots, i$), and let C'_i be the rectangle formed by the i rightmost special columns of F (i.e., columns $k - i + 1, k - i + 2, \dots, k$). Similarly, for $j \leq \ell$, R_j is the rectangle formed by the j topmost special rows of F , and R'_j the rectangle formed by the j bottommost special rows of F . Additionally, for $i \leq k$, let c_i and c'_i denote the i -th special

column from the left and the i -th special column from the right, respectively (i.e., $c_i = i$ and $c'_i = k + 1 - i$), and for $j \leq \ell$, let r_j and r'_j be the j -th special row from the top and the j -th special row from the bottom, respectively (i.e., $r_j = h + 1 - j$ and $r'_j = h - \ell - 1 + j$, where h is the height of F).

Lemma 3.5. *With F , k and ℓ as above, there is a bijection Γ on the set of fillings of F , such that for any filling ϕ of F and its image $\phi' = \Gamma(\phi)$, the following holds.*

1. *The longest SE-chain in ϕ has the same length as the longest NE-chain in ϕ' .*
2. *For every $i \leq k$, the longest SE-chain of ϕ contained in C_i has the same length as the longest NE-chain of ϕ' contained in C'_i .*
3. *For every $j \leq \ell$, the longest SE-chain of ϕ contained in R_j has the same length as the longest NE-chain of ϕ' contained in R'_j .*
4. *The entries of ϕ in column c_i have the same sum as the entries of ϕ' in column c'_i , and the entries of ϕ in row r_j have the same sum as the entries of ϕ' in row r'_j .*
5. *For any non-special row or column, the sum of its entries in ϕ is the same as the sum of its entries in ϕ' .*

Proof. Let ϕ be a filling of F . Refer to Figure 10 for the illustration of the steps of the construction. As the first step, we add new cells to F , filled with zeros, as follows: for every $i \leq k$, we add i new cells to the bottom of column c'_i , and for every $j \leq \ell$, we add j new cells to the right of row r'_j . We refer to these newly added cells as *dummy cells*. We let F_1 denote the Ferrers shape obtained from F by the addition of the dummy cells, and ϕ_1 the corresponding filling.

The dummy cells will remain filled with zeros throughout all the steps of the construction and will not contribute to any chain; their purpose is to ensure that for every $i \leq k$ and $j \leq \ell$, the shape F_1 has a maximal rectangle containing the cells of C_i and no other cell of F , and similarly for R_j .

As the next step, we reverse the order of the columns of F_1 and ϕ_1 , while keeping the order of the rows preserved. Thus, we replace the filling ϕ_1 of F_1 with its ‘mirror image’ ϕ_2 of the shape F_2 , changing all SE-chains into NE-chains.

Let σ be the permutation of the columns of F_2 which leaves the special columns of F_2 fixed, and places the non-special columns to the right of the special ones, in the same order as in F_1 . This permutation of columns yields a moon polyomino that only differs from F_1 by having the order of the special columns reversed. We call this polyomino F_3 . We now apply to ϕ_2 the bijection from Theorem 3.4, with σ as above, and let ϕ_3 be the resulting filling of F_3 .

Next, we permute the rows of F_3 , by reversing the order of the special rows. Let F_4 be the resulting moon polyomino. The corresponding filling ϕ_4 is obtained by again invoking Theorem 3.4, or more precisely its symmetric version for row permutations.

Finally, we remove from F_4 and ϕ_4 the dummy cells, to obtain a filling ϕ_5 of the original Ferrers shape F . We define Γ by $\Gamma(\phi) = \phi_5$. It follows from Theorem 3.4 that Γ has all the properties stated in the lemma. \square

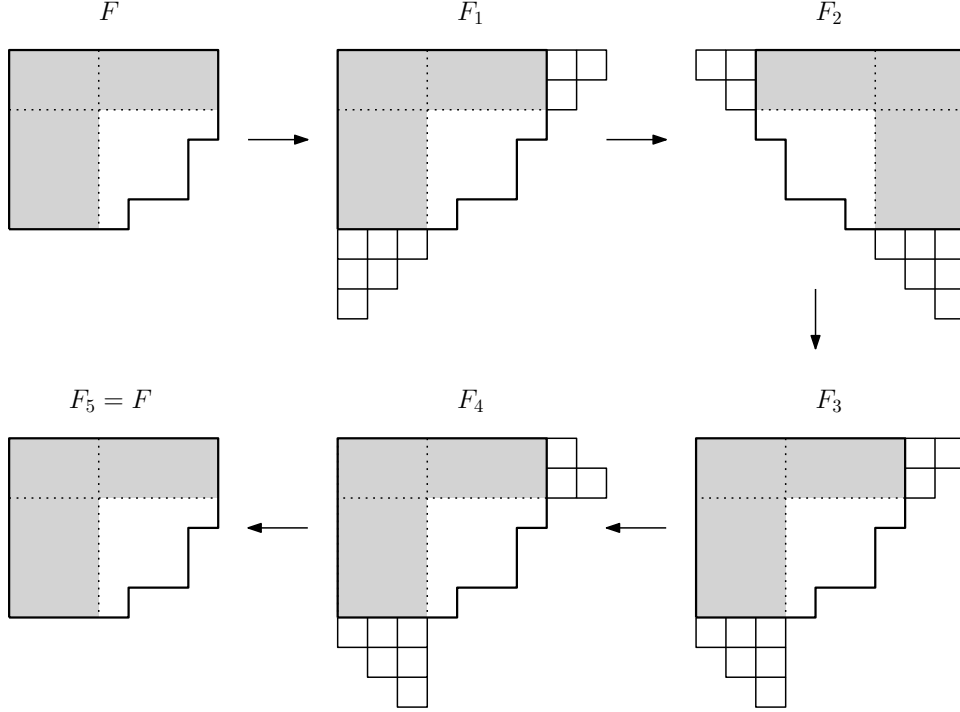

Figure 10: Construction of the bijection Γ from Lemma 3.5. The shaded areas correspond to the special rows and special columns.

3.4 Proof of Theorem 2.1

We now have all the ingredients to prove the main result of this section.

Proof of Theorem 2.1. Clearly, it suffices to prove the theorem for connected skew shapes, since for a disconnected skew shape, we can treat each component separately. Let S be a D-free connected skew shape. Fix its Ferrers-decomposition

$$S = F_1|{}^v G_1|{}^h F_2|{}^v \dots |{}^h F_n|{}^v G_n.$$

For two consecutive Ferrers shapes F_i and G_i from the decomposition, say that a row is special if S contains a cell from both F_i and G_i in this row. In particular, F_i and G_i have the same number of special rows. Clearly, all the special rows have the same length in F_i as well as in G_i . Similarly, for consecutive Ferrers shapes G_i and F_{i+1} , define a special column to be any column containing cells from both these shapes.

Fix now a filling ϕ of S . We transform ϕ by applying the bijection Γ separately to the restriction of ϕ in every Ferrers shape of the decomposition. More precisely, in F_1, \dots, F_n we apply Γ directly, while in G_1, \dots, G_n we first rotate the filling by 180 degrees, apply Γ , and then rotate back. Let ϕ' be the resulting filling of S , obtained by combining the transformed fillings of the individual Ferrers shapes in the decomposition.

We claim that ϕ' has all the properties stated in Theorem 2.1. Suppose first that ϕ contains δ_k for some k , and let us show that ϕ' contains ι_k . If the occurrence of δ_k in ϕ is confined to a single shape F_i or G_i , then ϕ' contains ι_k in the same shape by the properties of Γ .

Suppose now that ϕ has an occurrence of δ_k not confined to a single Ferrers shape of the decomposition. The occurrence must then be confined to the union of two consecutive shapes of the decomposition, since a pair of shapes further apart does not share any common row or column. Suppose, without loss of generality, that ϕ has an occurrence of δ_k inside $F_i \cup G_i$, with k_1 1-cells from the occurrence being in F_i and $k_2 = k - k_1$ 1-cells from the occurrence being in G_i . Moreover, let s be the number of special rows in F_i (and therefore also in G_i). There are then some values s_1, s_2 with $s_1 + s_2 = s$, such that F_i contains a SE-chain of length k_1 in its topmost s_1 special rows while G_i has a SE-chain of length k_2 in its s_2 bottommost special rows (which will become topmost once G_i is rotated before the application of Γ).

Consequently, in ϕ' , the shape F_i has a NE-chain of length k_1 in its bottommost s_1 special rows, and G_i has a NE-chain of length k_2 in its topmost s_2 special rows. The two chains together form a NE-chain of size k , i.e., an occurrence of ι_k in S . The same reasoning shows that an occurrence of ι_k in ϕ' implies an occurrence of δ_k in ϕ .

Let us now consider the row sums of ϕ and ϕ' . Let S_i be the set of row indices of the special rows shared by F_i and G_i . The sets S_1, S_2, \dots, S_n are pairwise disjoint. If a row r does not belong to any S_i , then it intersects only one shape from the decomposition and is not special. Such a row then has the same sum in ϕ as in ϕ' , by the properties of Γ . On the other hand, for the rows in a set S_i , the properties of Γ ensure that the order of their row sums is reversed by the mapping $\phi \mapsto \phi'$, that is, the sum of the topmost row of S_i in ϕ is the same as the sum of the bottommost row of S_i in ϕ' , and so on. Thus, the row sums of ϕ' are obtained from the row sums of ϕ by a permutation that reverses the order of each S_i and leaves the remaining elements fixed. An analogous property holds for column sums. \square

4 Binary fillings avoiding a chain of length 2

In this section, we prove Theorem 2.5.

Recall the skew shape D and its filling ϕ_D from Figure 1.

Given a skew shape S with a total of N cells, we assign labels c_1, c_2, \dots, c_N to every cell starting from the lower left corner, iterating over rows from the bottom to the top of S and labeling cells in a row from left to right, as indicated in Figure 11.

We associate with every cell c a three-part piecewise linear curve $l(c)$ consisting of the ray going from the top-right corner of c to the left, the right border of c and the ray going from the bottom-right corner of c to the right. The curve $l(c_i)$ of the cell c_i of a skew shape S clearly divides it into two parts, with cells c_1, \dots, c_i below and c_{i+1}, \dots, c_N above the curve, as illustrated in Figure 11.

Let $\pi \in \{\delta_2, \iota_2, \phi_D\}$ be a filling. Let S be a skew shape with cells numbered c_1, \dots, c_N as above, and let c_i be one of its cells. We say that an occurrence of π in a filling ϕ of S is *i-low*, if the top-right cell of the occurrence is one of the cells c_1, \dots, c_i . Intuitively, this means that the entire occurrence is below the line $l(c_i)$. If an occurrence is not *i-low*, then it is *i-high*. Note that an occurrence may be *i-high* even when all its 1-cells are below $l(c_i)$.

For a skew shape S with cells numbered c_1, \dots, c_N as above, let \mathcal{G}_i be the set of all the binary fillings of S that contain neither an *i-high* occurrence of δ_2 nor an *i-low* occurrence of ι_2 or of ϕ_D . See Figure 12 for an example.

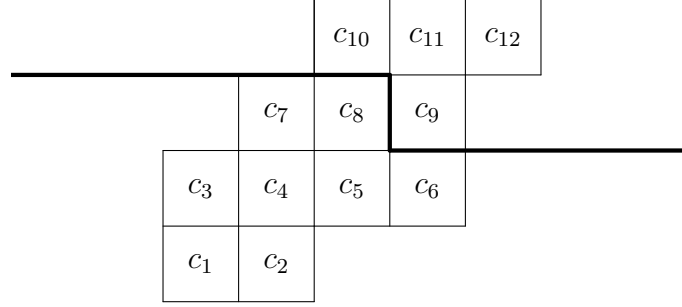

Figure 11: A skew shape with cell labels and the curve $l(c_8)$

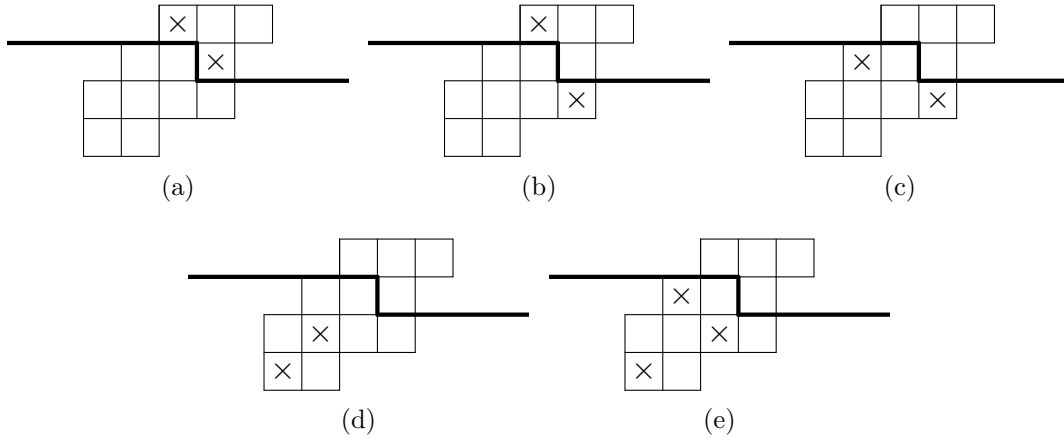

Figure 12: Forbidden patterns of \mathcal{G}_8

Note that \mathcal{G}_1 is precisely the set of all δ_2 -avoiding binary fillings of S , while \mathcal{G}_N is the set of $\{\iota_2, \phi_D\}$ -avoiding binary fillings of S . Thus, Theorem 2.5 will follow directly from the next lemma.

Lemma 4.1. *Let S be a skew shape with N cells and let $1 \leq i < N$. Then there is a bijection between \mathcal{G}_i and \mathcal{G}_{i+1} .*

Proof. First, consider the case when the cells c_i and c_{i+1} are not in the same row, i.e. c_{i+1} is the first cell of a new row and c_i is the last cell of the previous row. In this case we will show that the sets \mathcal{G}_i and \mathcal{G}_{i+1} are identical.

To see this, note that since the three relevant patterns δ_2 , ι_2 and ϕ_D all have two cells in the topmost row, they can never have an occurrence whose top-right cell is mapped to c_{i+1} . Thus, in a filling ϕ of S , an occurrence of any of these patterns is i -low if and only if it is $(i+1)$ -low, and hence $\mathcal{G}_i = \mathcal{G}_{i+1}$.

Suppose now that c_i and c_{i+1} are adjacent cells in a single row. We will partition each of the sets \mathcal{G}_i and \mathcal{G}_{i+1} into two disjoint parts and construct bijections between corresponding parts. Let R consist of all the cells in the same row as c_{i+1} and strictly to the left of it, let C consist of all the cells in the column of c_{i+1} and strictly below it, and let A be the rectangle consisting of all cells that are in a column intersecting R and a row intersecting C ; see Figure 13. Note that A , R , C and c_{i+1} form a rectangle X which is maximal among all

the rectangles contained in S with c_{i+1} as top-right corner. Therefore, in any occurrence of ι_2 with the upper 1-cell in c_{i+1} , the lower 1-cell is inside the rectangle A .

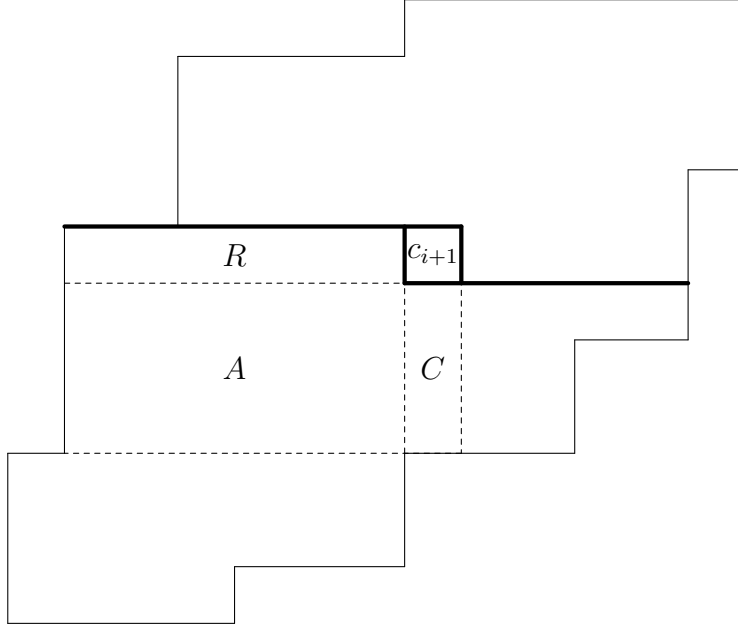

Figure 13: The maximal rectangle X with c_{i+1} in the top-right corner

We divide \mathcal{G}_i into two disjoint sets as follows:

- \mathcal{G}_i^1 contains the fillings in which there is either no 1 in c_{i+1} or no 1 inside A ,
- \mathcal{G}_i^2 contains the fillings with a 1 in c_{i+1} and at least one 1 inside A .

We divide \mathcal{G}_{i+1} into two disjoint sets as follows:

- \mathcal{G}_{i+1}^1 contains the fillings in which there is either no 1 inside R or no 1 inside C ,
- \mathcal{G}_{i+1}^2 contains the fillings in which both R and C are nonempty.

First of all we show that the sets \mathcal{G}_i^1 and \mathcal{G}_{i+1}^1 contain the same fillings. Choose a filling $\phi \in \mathcal{G}_i^1$. Clearly, since ϕ has no i -high occurrence of δ_2 , it has no $(i+1)$ -high occurrence either. The only possibility for ϕ to have an $(i+1)$ -low occurrence of ι_2 or ϕ_D is that c_{i+1} is actually the top-right corner of the occurrence. The definition of \mathcal{G}_i^1 guarantees that there is no such occurrence of ι_2 . If ϕ contained an occurrence of ϕ_D with top-right corner in c_{i+1} , then it would contain an i -high occurrence of δ_2 , contradicting $\phi \in \mathcal{G}_i$. This also shows that ϕ belongs to \mathcal{G}_{i+1}^1 .

Conversely, for $\psi \in \mathcal{G}_{i+1}^1$, we see that ψ has no i -low occurrence of δ_2 or ϕ_D , since it has no such $(i+1)$ -low occurrence. It also has no i -high occurrence of δ_2 , because the top-right cell of such an occurrence would have to coincide with c_{i+1} , which is excluded by the definition of \mathcal{G}_{i+1}^1 . Hence ψ is in \mathcal{G}_i . And since ψ has no $(i+1)$ -low occurrence of ι_2 , we may conclude that ψ is in \mathcal{G}_i^1 . This shows that $\mathcal{G}_i^1 = \mathcal{G}_{i+1}^1$.

For a filling $\psi \in \mathcal{G}_i^2$ we perform the following transformation f into a filling $\rho = f(\psi)$:

1. Label all nonempty columns of A from left to right as C_1, C_2, \dots, C_k .
2. If C is nonempty, then R is empty and we move the 1 from the cell c_{i+1} to the cell of R above the column C_1 and finish.
3. If C is empty, then replace the filling of C by the filling of C_k and for $1 \leq j < k$ replace the filling of C_{j+1} by the filling of C_j . Replace the filling of C_1 by all zeros.
4. If there is a 1 in the cell of R above the column C_1 , finish if $k = 1$ or move the 1 from c_{i+1} to the cell of R above the column C_2 if $k > 1$.
5. Finally if there is no 1 in the cell of R above the column C_1 , move the 1 from c_{i+1} to this cell.

Observe that since ψ has no occurrence of ι_2 inside $A \cup R$, all its 1-cells in R must be weakly to the left of C_1 , and for $i < k$, all the 1-cells in C_i must be weakly above those of C_{i+1} . Observe also that for any 1-cell $c = (i, j)$ of ψ inside A , ρ has a 1-cell in $A \cup C$ in row j weakly to the right of c , and ρ also has a 1-cell in $A \cup R$ in column i weakly above c . Conversely, for any 1-cell of ρ in $A \cup R$, ψ has a 1-cell in the same column and weakly below it, and for any 1-cell of ρ in $A \cup C$, ψ has a 1-cell in the same row and weakly to the left of it.

Recall that X is the rectangle $A \cup C \cup R \cup c_{i+1}$. Note that in any cell not belonging to X , the two fillings ψ and ρ coincide.

We now verify that the filling ρ belongs to \mathcal{G}_{i+1} . If ρ has an $(i+1)$ -high copy of δ_2 , then at least one 1-cell of this copy must be in X , because in the rest of S , no 1-cells were modified. The other 1-cell must be strictly above or strictly to the right of X , otherwise the occurrence would be $(i+1)$ -low.

However, since for every 1-cell of ρ in X , there is a 1-cell of ψ in the same column of X and also a 1-cell of ψ in the same row of X , it follows that to any $(i+1)$ -high occurrence of δ_2 in ρ , we may find such an i -high occurrence in ψ as well, contradicting $\psi \in \mathcal{G}_i$.

If ρ has an $(i+1)$ -low occurrence of ι_2 , we consider the following cases.

- The occurrence of ι_2 has a 1-cell in R and another 1-cell in A : this cannot occur, since in ρ , the rightmost 1-cell in R is in column C_1 or C_2 , and there is no 1-cell in A to the left of this column.
- The occurrence of ι_2 has both 1-cells in $A \cup C$. However, the subfilling of $A \cup C$ induced by the nonempty columns is the same in ρ as in ψ , so ψ contains an occurrence of ι_2 in $A \cup C$ as well, which is impossible.
- The occurrence of ι_2 has one 1-cell in $A \cup R \cup C$ and another outside X . Since the transform f preserves the set of nonempty rows and columns in X , there must be an i -low occurrence of ι_2 in ψ , a contradiction.
- The occurrence of ι_2 uses the 1-cell c_{i+1} and a 1-cell in A . This is impossible, since c_{i+1} is a 1-cell in ρ only if A is empty.
- The occurrence of ι_2 has no 1-cell in X . Then it is also an i -low occurrence of ι_2 in ψ , which is impossible.

The above cases cover all possibilities, and show that ρ avoids an $(i + 1)$ -low ι_2 .

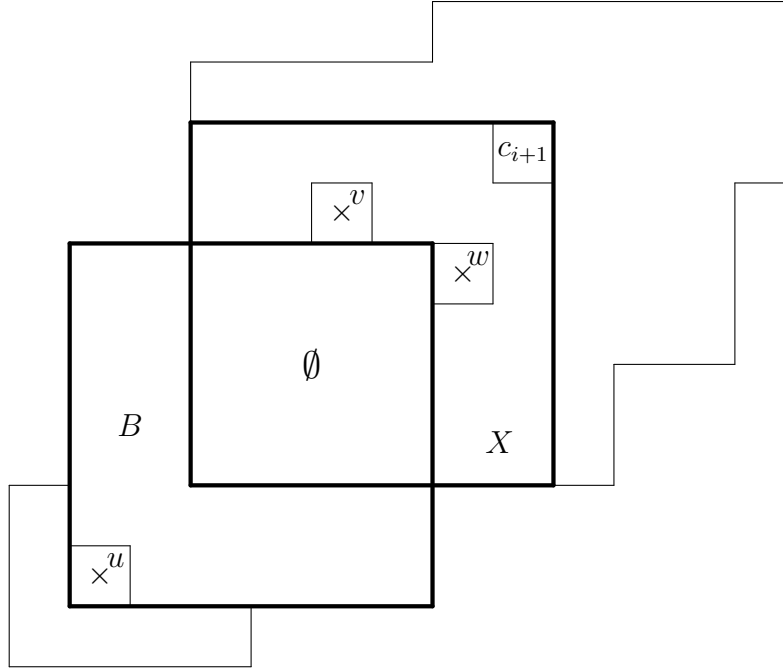

Figure 14: An occurrence of ϕ_D in the cells u , v and w

Suppose that ρ has an $(i + 1)$ -low occurrence of ϕ_D . Let u , v and w be the three 1-cells of this occurrence, ordered left to right; see Figure 14. We note that in order to get an occurrence of ϕ_D , the column containing u must not intersect the row containing v inside S . Since all the three 1-cells are below the line $l(c_{i+1})$, this implies that u is strictly to the left of the leftmost column of A . Moreover, at least one of v and w must be inside X , otherwise the three 1-cells would form a forbidden copy of ϕ_D in ψ .

We claim that u must be strictly below the bottom row of X . If not, then w would be strictly to the right of X , since the column of w does not intersect the row of u inside S . This implies that v is in X , and more precisely v must be in $A \cup C$, otherwise the copy of ϕ_D would not be $(i + 1)$ -low. But then ψ has a 1-cell v' in the same row as v and weakly to the left, and u , v' and w form a forbidden occurrence of ϕ_D in ψ . This shows that u is indeed strictly below X .

Define B to be the largest rectangle inside S whose bottom-left corner is u . Note that ψ has no 1-cell in $A \cap B$, since such a 1-cell would form a forbidden occurrence of ι_2 with u . Note also that the column containing v intersects the row containing w inside B , otherwise u , v and w would not form a copy of ϕ_D .

The filling ψ contains a 1-cell v' in the same column as v and weakly below it, and it contains a 1-cell w' in the same row as w and weakly to the left of it. Since neither v' nor w' are in B , they form an occurrence of ϕ_D with u , and this occurrence is $(i + 1)$ -low. In fact, this occurrence must be i -low as well, otherwise we would have $v' \in R$ and $w' \in C$, in which case v' and w' would form a forbidden i -high occurrence of δ_2 in ψ . We conclude that ψ has a forbidden occurrence of ϕ_D . This contradiction completes the proof that ρ has no

$(i + 1)$ -low occurrence of ϕ_D , and therefore that ρ is in \mathcal{G}_{i+1} .

It follows directly from the definition of f that for any $\psi \in \mathcal{G}_i^2$, the filling ρ has a 1-cell both in R and in C , and hence $\rho \in \mathcal{G}_{i+1}^2$.

Next, we describe a mapping g that transforms a filling $\rho \in \mathcal{G}_{i+1}^2$ into a filling ψ .

1. If there is exactly one 1-cell in R and the column of A below this cell is nonempty, move this entry to c_{i+1} and finish.
2. Otherwise there are either at least two 1-cells in R or the column below the single 1-cell is empty. In both cases we can choose the rightmost empty column of A such that there is a 1 in R above it. We call this column C_1 . Label all nonempty columns of A from left to right as C_2, C_3, \dots, C_k .
3. For each $1 \leq j < k$ copy the filling of C_{j+1} to C_j , copy the filling of C to C_k and replace the filling of C by all zeros.
4. If $k = 1$ finish. If $k \geq 2$ and there is a 1 in R above C_2 , this is the rightmost 1 in R , move it to c_{i+1} and finish.
5. Finally if the entry 1 in R above C_1 is the rightmost 1-cell in R , move this 1 to c_{i+1} .

We may again observe easily that in ψ , either R or C is empty, and that ψ and ρ have the same nonempty rows and columns in X . Moreover, for any 1-cell c of ψ in A , the preimage ρ contains a 1-cell in X in the same column and weakly above c , as well as a 1-cell in X in the same row and weakly to the right of c .

We claim that the filling $\psi = g(\rho)$ belongs to \mathcal{G}_i^2 . Assume that ψ has an i -high copy of δ_2 . Its top-right corner is not c_{i+1} because R or C is empty in ψ . Thus, exactly one of its 1-cells is in X , but since ρ has the same nonempty rows and columns in X as ψ , this means there is an $(i + 1)$ -high copy of δ_2 in ρ , a contradiction.

Suppose ψ contains an i -low copy of ι_2 , and let u and v be its two 1-cells, with u left and below v . If u is in a column or row that intersects A , we easily find a forbidden copy of ι_2 in ρ , using the fact that nonempty rows and columns of X are preserved by g . The only nontrivial case is when u is strictly to the left and below A . Then ρ contains a 1-cell v' in the same column as v and weakly above it, as well as a 1-cell v'' in the same row as v and weakly to the right of it. If u does not form a copy of ι_2 with v' or v'' , it implies that u , v' and v'' form a forbidden copy of ϕ_D in ρ , a contradiction.

Finally, suppose ψ contains an i -low copy of ϕ_D , with 1-cells u , v and w ordered left to right. If u is not strictly to the left and below A , we may use the same reasoning we used in the analysis of the transform f to show that ρ contains a forbidden copy of ϕ_D . If u is strictly to the left and below A , we may find in ρ a 1-cell v' in the same column and weakly above v , as well as a 1-cell w' in the same row and weakly to the right of w , and see that u , v' and w' form a forbidden copy of ϕ_D .

It follows that ψ is in \mathcal{G}_i , and since either R or C is empty in ψ as we observed above, it follows that ψ is in \mathcal{G}_i^2 .

Overall, we have shown that f maps \mathcal{G}_i^2 into \mathcal{G}_{i+1}^2 and that g maps \mathcal{G}_{i+1}^2 into \mathcal{G}_i^2 . In addition, we can routinely check that the two mappings f and g are inverses of each other,

showing that $|\mathcal{G}_i^2| = |\mathcal{G}_{i+1}^2|$. Together with the fact that \mathcal{G}_i^1 is equal to \mathcal{G}_{i+1}^1 , this yields the required identity $|\mathcal{G}_i| = |\mathcal{G}_{i+1}|$. \square

Proof of Theorem 2.5. Let N be the number of cells of S . From Lemma 4.1, we immediately get that there is a bijection between the fillings of \mathcal{G}_1 and \mathcal{G}_N . As discussed above, \mathcal{G}_1 is exactly the set of fillings avoiding δ_2 , while \mathcal{G}_N is exactly the set of fillings avoiding ϕ_D and ι_2 , which completes the proof. Moreover, all the individual bijections we constructed have the property that they preserve row sums. \square

5 Conclusion

Our main motivation for the study of fillings, and fillings of skew shapes in particular, stems from their close connection with the problem of enumeration of pattern-avoiding permutations. In particular, Conjecture 2.3 offers a plausible way of obtaining an infinite family of Wilf-ordering relations. Although the results of this paper do not seem to yield any direct consequences for permutation enumeration, we believe that a better understanding of pattern-avoiding skew-shape fillings may pave the way for future progress in this area.

References

- [1] Jörgen Backelin, Julian West, and Guoce Xin. Wilf-equivalence for singleton classes. *Adv. in Appl. Math.*, 38(2):133–148, 2007.
- [2] Mireille Bousquet-Mélou and Einar Steingrímsson. Decreasing subsequences in permutations and Wilf equivalence for involutions. *J. Algebraic Combin.*, 22(4):383–409, 2005.
- [3] Alexander Burstein and Jay Pantone. Two examples of unbalanced Wilf-equivalence. *J. Comb.*, 6(1-2):55–67, 2015.
- [4] William Y. C. Chen, Eva Y. P. Deng, Rosena R. X. Du, Richard P. Stanley, and Catherine H. Yan. Crossings and nestings of matchings and partitions. *Trans. Amer. Math. Soc.*, 359(4):1555–1575, 2007.
- [5] Anna de Mier. On the symmetry of the distribution of k -crossings and k -nestings in graphs. *Electron. J. Combin.*, 13(1):Note 21, 6, 2006.
- [6] Anna de Mier. k -noncrossing and k -nonnesting graphs and fillings of Ferrers diagrams. *Combinatorica*, 27(6):699–720, 2007.
- [7] Ting Guo, Christian Krattenthaler, and Yi Zhang. On (shape-)Wilf-equivalence for words. *Adv. in Appl. Math.*, 100:87–100, 2018.
- [8] Ting Guo and Svetlana Poznanović. Hecke insertion and maximal increasing and decreasing sequences in fillings of stack polyominoes. arXiv:1911.07799, 2019.

- [9] Vít Jelínek. Dyck paths and pattern-avoiding matchings. *European J. Combin.*, 28(1):202–213, 2007.
- [10] Vít Jelínek. *Wilf-Type Classifications, Extremal and Enumerative Theory of Ordered Structures*. PhD thesis, Charles University in Prague, 2008.
- [11] Vít Jelínek and Toufik Mansour. On pattern-avoiding partitions. *Electron. J. Combin.*, 15(1):Research paper 39, 52, 2008.
- [12] Anisse Kasraoui and Jiang Zeng. Distribution of crossings, nestings and alignments of two edges in matchings and partitions. *Electron. J. Combin.*, 13(1):Research Paper 33, 12, 2006.
- [13] C. Krattenthaler. Growth diagrams, and increasing and decreasing chains in fillings of Ferrers shapes. *Advances in Applied Mathematics*, 37:404–431, 2006.
- [14] Svetlana Poznanović and Catherine H. Yan. Maximal increasing sequences in fillings of almost-moon polyominoes. *Adv. in Appl. Math.*, 66:1–21, 2015.
- [15] M. Rubey. Increasing and decreasing sequences in fillings of moon polyominoes. *Advances in Applied Mathematics*, 47:57–87, 2011.
- [16] Zvezdelina Stankova and Julian West. A new class of Wilf-equivalent permutations. *J. Algebraic Combin.*, 15(3):271–290, 2002.
- [17] Vincent Vatter. Permutation classes. In *Handbook of enumerative combinatorics*, Discrete Math. Appl. (Boca Raton), pages 753–833. CRC Press, Boca Raton, FL, 2015.